

Low and high voltage three phase induction motors

W60 Line - Squirrel cage rotor - Horizontal

Installation, Operation and Maintenance Manual

DMC

Drives Motors Controls

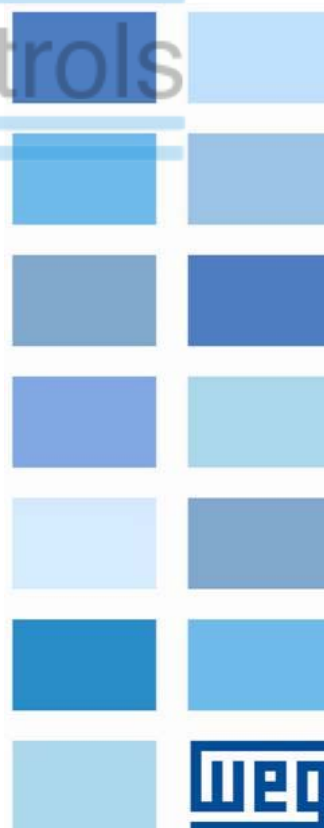

DMC

Drives Motors Controls



DMC

Drives Motors Controls

Installation, Operation and Maintenance Manual

Document Number: 12868866

Model: W60

Language: English

Revision: 4

February 2017

DMC

Drives Motors Controls

Dear Customer,

Thank you for purchasing a WEG motor. Our products are developed with the highest standards of quality and efficiency which ensures outstanding performance.

Since electric motors play a major role in the comfort and well-being of mankind, it must be identified and treated as a driving machine with characteristics that involve specific care, such as proper storage, installation and maintenance

All efforts have been made to ensure that the information contained in this manual is faithful to the configurations and applications of the motor.

Therefore, we recommend that you read this manual carefully before proceeding with the installation, operation or maintenance of the motor in order to ensure safe and reliable operation of your equipment and facility. If you need any further information, please contact WEG.

Always keep this manual close to the motor, so that it can be consulted whenever necessary.



ATTENTION

1. It is imperative to follow the procedures contained in this manual for the warranty to be valid;
2. The motor installation, operation and maintenance procedures must be performed only by qualified personnel.



NOTES

1. The total or partial reproduction of information supplied in this manual is authorized, provided that reference is made to its source.
2. If this manual is lost, an electronic PDF file is available at www.weg.net or another printed copy may be requested.

WEG EQUIPAMENTOS ELÉTRICOS S.A.

DMC

Drives Motors Controls

TABLE OF CONTENTS

1	INTRODUCTION	11
1.1	SAFETY WARNINGS IN THE MANUAL	11
2	GENERAL INSTRUCTIONS	12
2.1	QUALIFIED PERSONNEL	12
2.2	SAFETY INSTRUCTIONS	12
2.3	STANDARDS.....	12
2.4	ENVIRONMENTAL CONDITIONS.....	13
2.5	OPERATING CONDITIONS	13
2.6	VOLTAGE AND FREQUENCY	13
3	RECEIVING, HANDLING AND STORAGE	14
3.1	RECEIVING	14
3.2	HANDLING.....	14
3.3	STORAGE	14
3.3.1	Outdoor storage	14
3.3.2	Extended storage	14
3.3.2.1	Storage location	15
3.3.2.1.1	Indoor storage	15
3.3.2.1.2	Outdoor storage	15
3.3.2.2	Separate parts	15
3.3.3	Preservation during the storage.....	15
3.3.3.1	Space heater.....	15
3.3.3.2	Insulation resistance	16
3.3.3.3	Exposed machined surfaces.....	16
3.3.3.4	Sealing	16
3.3.3.5	Bearings.....	16
3.3.3.5.1	Grease-lubricated rolling bearing.....	16
3.3.3.5.2	Sleeve bearing	16
3.3.3.6	Terminal box	16
3.3.3.7	Air-water heat exchanger	17
3.3.3.8	Cleanliness and conservation of the motor during storage	17
3.3.3.9	Inspections and records during storage.....	17
3.3.3.10	Predictive/preventive maintenance.....	17
3.3.3.11	Maintenance plan during storage.....	18
3.3.4	Preparation for commissioning.....	19
3.3.4.1	Cleaning.....	19
3.3.4.2	Bearing inspection.....	19
3.3.4.3	Bearing lubrication.....	19
3.3.4.4	Insulation resistance verification.....	19
3.3.4.5	Air-water heat exchanger	19
3.3.4.6	Others.....	19
4	INSTALLATION.....	20
4.1	INSTALLATION SITE	20
4.2	SHAFT LOCK.....	20
4.3	ROTATION DIRECTION.....	20
4.4	INSULATION RESISTANCE.....	20
4.4.1	Safety Instructions	20
4.4.2	General considerations	20
4.4.3	Measurement on the stator windings.....	20
4.4.4	Additional Information	21
4.4.5	Polarization Index.....	21
4.4.6	Conversion of the measured values.....	21
4.4.7	Insulation assessment.....	21
4.5	PROTECTIONS	22
4.5.1	Thermal protections	22
4.5.1.1	Temperature sensors	22
4.5.1.2	Temperature limits for the windings	22
4.5.1.3	Alarm and trip temperatures	22
4.5.1.4	Temperature and ohmic resistance of the PT100 thermoresistance	23
4.5.1.5	Space heater.....	23
4.5.2	Water leak sensor	23

4.6	COOLING	23
4.6.1	Enclosed motors	24
4.6.2	Open motors	24
4.6.3	Air-water heat exchange cooling	24
4.6.3.1	Radiators for application with seawater	24
4.7	ELECTRICAL ASPECTS	25
4.7.1	Electrical connections	25
4.7.1.1	Main electrical connections	25
4.7.1.2	Grounding	25
4.7.2	Connection diagrams	25
4.7.2.1	Rotation direction	26
4.7.2.2	Accessory connection diagrams	26
4.8	MECHANICAL ASPECTS	26
4.8.1	Foundations	26
4.8.2	Foundation loads	26
4.8.3	Base types	26
4.8.3.1	Concrete base	26
4.8.3.2	Sliding base	26
4.8.3.3	Metal base	27
4.8.3.4	Anchor bolts	27
4.8.4	Anchor plate set	27
4.8.5	Natural frequency of the base	27
4.8.6	Leveling	27
4.8.7	Alignment	28
4.8.8	Doweling	28
4.8.9	Couplings	29
4.8.9.1	Direct coupling	29
4.8.9.2	Gear coupling	29
4.8.9.3	Belt drive	29
4.8.9.4	Coupling of motors equipped with sleeve bearings	30
4.9	HYDRAULIC UNIT	30
5	STARTING	31
5.1	DIRECT ON-LINE STARTING	31
5.2	DIRECT ONLINE STARTING FREQUENCY	31
5.3	LOCKED ROTOR CURRENT	31
5.4	STARTING WITH REDUCED CURRENT	31
6	COMMISSIONING	32
6.1	PRELIMINARY INSPECTION	32
6.2	FIRST STARTING	32
6.2.1	Starting procedure	32
6.3	OPERATION	33
6.3.1	General	33
6.3.2	Temperatures	33
6.3.3	Bearings	33
6.3.3.1	High-pressure oil injection system	33
6.3.4	Radiators	33
6.3.5	Vibration	34
6.3.6	Shaft vibration limits	34
6.3.7	Shutdown	34
6.4	OPERATION AS ASYNCHRONOUS GENERATOR	35
6.4.1	Operation	35
6.4.2	Slip	35
6.4.3	Precautions	35
7	MAINTENANCE	36
7.1	GENERAL	36
7.2	GENERAL CLEANING	36
7.3	WINDING INSPECTIONS	36
7.4	WINDING CLEANING	36
7.4.1	Inspections	36
7.4.2	Reimpregnation	37
7.4.3	Insulation Resistance	37
7.5	COOLING SYSTEM MAINTENANCE	37

7.6	RADIATOR MAINTENANCE	37
7.7	VIBRATION	37
7.8	SHAFT GROUNDING DEVICE	37
7.9	BEARING MAINTENANCE	38
7.9.1	Grease-lubricated rolling bearings	38
7.9.1.1	Instructions for lubrication	38
7.9.1.2	Procedures for rolling bearing relubrication	38
7.9.1.3	Rolling bearing relubrication with drawer device for grease removal	38
7.9.1.4	Type and amount of grease	38
7.9.1.5	Grease compatibility	39
7.9.1.6	Bearing disassembly	39
7.9.1.7	Bearing assembly	39
7.9.2	Rolling bearing replacement	40
7.9.3	Sleeve bearings	40
7.9.3.1	Bearing data	40
7.9.3.2	Bearing installation and operation	40
7.9.3.3	Cooling by water circulation	40
7.9.3.4	Oil change	40
7.9.3.5	Sealing	41
7.9.3.6	Sleeve bearing operation	41
7.9.3.7	Sleeve bearing maintenance	41
7.9.3.8	Bearing disassembly and assembly	42
7.9.4	Bearing protection	43
7.9.4.1	Protection settings	43
7.9.4.2	Disassembly/assembly of the bearing temperature sensors	43
8	MOTOR DISASSEMBLY AND ASSEMBLY	45
8.1	DISASSEMBLY	45
8.2	ASSEMBLY	45
8.3	AIR-GAP MEASUREMENT	45
8.4	TIGHTENING TORQUE	45
8.5	SPARE PARTS	46
9	MAINTENANCE PLAN	47
10	ABNORMALITIES, CAUSES AND SOLUTIONS	48
11	DECLARATION OF CONFORMITY	50
12	ENVIRONMENTAL INFORMATION	51
12.1	PACKAGE	51
12.2	PRODUCT	51
12.3	HAZARDOUS WASTE	51
13	WARRANTY TERM	52

DMC

Drives Motors Controls

1 INTRODUCTION



This manual contains information regarding low and high-voltage, three-phase induction motors. Motors with special features can be supplied with specific documents (drawings, connection diagram, characteristic curves etc.). Those documents, together with this manual, must be thoroughly evaluated before proceeding with the installation, operation or maintenance of the motor.

In order to use a frequency inverter, it is mandatory to follow the instructions contained in the specific technical documentation of the motor and in the manual of the frequency inverter.

If any additional explanation about motors with major special features is necessary, consult WEG. All procedures and standards contained in this manual must be observed in order to ensure proper operation of the motor and the safety of the personnel involved in its operation. Following these procedures is also important to ensure the validity of the motor warranty. Thus, we recommend the careful reading of this manual before the installation and operation of the motor. If any further information is still necessary, consult WEG.

1.1 SAFETY WARNINGS IN THE MANUAL

In this manual, the following safety warnings are used:

	DANGER Failure to observe the procedures recommend in this warning may result in death, serious injuries and extensive equipment damage.
	ATTENTION Failure to observe the procedures recommend in this warning may result in equipment damage.
	NOTE This provides important information for correct understanding and proper operation of the product.

Drives Motors Controls

2 GENERAL INSTRUCTIONS

All the personnel involved with the assembly, operation or maintenance of electrical installations must be permanently informed and updated on the standards and safety instructions that guide the job and are advised to strictly comply with them. Before beginning any job, the person in charge must make sure that all points have been duly observed and warn the respective personnel about the danger inherent to the task to be performed.

Improper application, inadequate handled or maintenance of the generator, may cause serious injuries and/or material damages.

Therefore, it is highly recommended that these services be always performed by qualified personnel.

2.1 QUALIFIED PERSONNEL

The term qualified personnel means those who, because of their training, experience, education level, and knowledge of the applicable standards, specifications, accident prevention, safety standards and operating conditions, have been authorized by the persons in charge to execute the necessary tasks, and who are able to recognize and avoid any possible danger.

Such qualified personnel must also know and be able to provide first aid procedures if necessary.

The entire start-up, maintenance and repair tasks must only be performed by qualified personnel.

Qualified personnel must also observe:

- All the technical data regarding the allowed applications (operating conditions, connections and installation environment), included in the catalog, in the purchase order documents, in the operating instructions, in manuals and all other documentation;
- The specific regulations and conditions for the local installation;
- The use of suitable tools and equipment for handling and transportation;
- That the protective devices of the individual components are removed shortly before installation.

Individual parts must be stored in vibration-free environments, avoiding falls and ensuring their protection against aggressive agents and/or that they do not jeopardize people.

2.2 SAFETY INSTRUCTIONS



DANGER

During normal operation of this equipment, a hazard associated with energized or rotating components with high voltage or elevated temperatures exists.

Thus, the operation with open terminal boxes, unprotected couplings, improper handling, or failure to comply with the operating standards, may cause severe personal injuries and material damages.



ATTENTION

When devices and equipment are used outside the industrial environment, the user must ensure the safety of the equipment by adopting proper protection and safety measures during installation (for example, keep people away, avoid contact of children, etc.).

Those responsible for the safety of the installation must ensure that:

- Only qualified personnel install and operate the equipment;
- They have this manual and all other documents supplied with the motor at hand, as well as that they perform the tasks in strict compliance with the service instructions, relevant standards and specific product documentation;



ATTENTION

Failure to comply with installation and safety standards may void the product warranty. Firefighting equipment and first aid notices must be available in visible and easily accessible locations at the work site.

2.3 STANDARDS

The motors are specified, designed, manufactured and tested according to the standards described in Table 2.1. The applicable standards are specified in the commercial contract, which may indicate other national or international standards, depending on the application or installation location.

Table 2.1: Applicable standards

	IEC / NBR	NEMA
Specification	IEC60034-1 NBR 17094	MG1-1,10,20
Dimensions	IEC60072 NBR 15623	MG1-4,11
Tests	IEC60034-2 NBR 5383	MG1-12
Levels of protection	IEC60034-5 NBR IEC 60034-5	MG1-5
Cooling	IEC60034-6 NBR IEC 60034-6	MG1-6
Mounting	IEC60034-7 NBR IEC 60034-7	MG1-4
Noise	IEC60034-9 NBR IEC 60034-9	MG1-9
Mechanical Vibration	IEC60034-14 NBR IEC 60034-14	MG1-7
Mechanical Tolerances	ISO286 / NBR6158	MG1-4
Balancing	ISO1940	MG1-7

2.4 ENVIRONMENTAL CONDITIONS

The motor was designed according to the specific environmental conditions (temperature and altitude) of your application, and are described on the nameplate and in the datasheet of the motor.



ATTENTION

For the use of water-cooled motors in ambient temperatures below +5°C, antifreeze additives must be added to the water.

2.5 OPERATING CONDITIONS

In order for the product warranty to be valid, the motor must be operated according to nominal data indicated on its nameplate, observing all applicable standards and information contained in this manual.

2.6 VOLTAGE AND FREQUENCY

It is very important to ensure a proper power supply for the motor. The conductors and the entire protection system must ensure the quality of the power supply at the motor terminals within the limits, in accordance with the IEC60034-1 standard:

- Voltage: may vary within a range of $\pm 10\%$ of the rated value;
- Frequency: may vary within a range of -5% to $+3\%$ of the rated value.

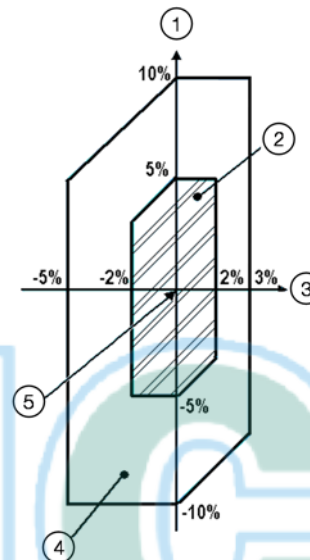

Figure 2.1: Voltage and frequency variation limits

Figure 2.1 legend:

1. Voltage
2. Zone A
3. Frequency
4. Zone B (outside zone A)
5. Voltage with rated characteristics

D M G

Drives Motors Controls

The motor must be able to perform its main function continuously in Zone A, but it may not fully meet its performance characteristics at rated voltage and frequency (refer to the point with rated characteristics in Figure 2.1), when it may present some deviations. The temperature rises may be above those at rated voltage and frequency.

The motor must be able to perform its main function in Zone B, but regarding the performance characteristics at rated voltage and frequency, it may present deviations greater than those of Zone A. The temperature rises may be higher than those observed at rated voltage and frequency, and they will most likely be higher than those in Zone A.

Prolonged operation in the periphery of Zone B is not recommended.

3 RECEIVING, HANDLING AND STORAGE

3.1 RECEIVING

All motors were tested and are in perfect operating conditions. The machined surfaces are protected against corrosion. The package must be inspected upon receipt for occasional damages during transportation.



ATTENTION

Any damage must be photographed, documented and reported immediately to the carrier, the insurer and WEG. The non-communication of this damage will void the warranty.



ATTENTION

Parts supplied in additional packages must be checked upon receipt.

- When lifting the package (or container), the proper hoisting points, the weight indicated on the package or on the nameplate and the operating capacity and conditions of the hoisting equipment must be observed;
- Motors packed in wooden crates must always be lifted by their own lifting lugs or by a proper forklift; they must never be lifted by the package;
- The package can never be overturned. Place it on the floor carefully (without impact) in order to avoid damage to the bearing;
- Do not remove the grease for protection against corrosion from the shaft end, or the closing plugs present in the terminal box holes. These protections must remain in place until the moment of the final assembly.
- A complete visual inspection of the motor must be carried out after removing the package;
- The shaft locking system must be removed just before the installation and stored to be used in future transportation of the motor.

3.2 HANDLING

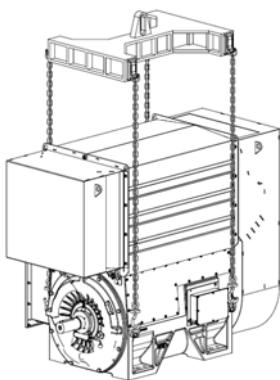



Figure 3.1: Handling

1. Lift the motor, as indicated in Figure 3.1, using the four lifting lugs provided only for that purpose. If necessary, remove the heat exchanger to lift the motor;

2. Observe the weight indicated on the motor. Do not lift the motor causing jolts or put it down abruptly, because this can cause damage to the bearings;
3. The lifting lugs on the heat exchanger, end shields, bearings, radiator, terminal box, etc. are designed to handle these components only separately;
4. Never use the shaft to lift the motor;
5. In order to move the motor, the shaft must be locked with the locking device supplied with the motor.



ATTENTION

Steel cables, clevises and lifting equipment must be able to withstand the motor weight.

3.3 STORAGE

If the Motor is not installed immediately after reception, it must remain inside the package and stored in a location protected against moisture, vapors, sudden changes in temperature, rodents and insects. The motor must be stored in vibration-free locations in order to avoid bearing damage.



ATTENTION

Space heaters must remain powered during storage in order to avoid moisture condensation inside the motor.

Any damage to the paint or corrosion protection of the machined parts must be repaired.

3.3.1 Outdoor storage

The motor must be stored in a dry location, free of flooding and vibrations. Repair any damages on the package before storing the motor, which is needed to ensure proper storage conditions. Place the motor on platforms or foundations that ensure protection against humidity from the ground and prevent it from sinking into the soil. Free air circulation underneath the motor must be assured. The cover used to protect the motor against the bad weather must not be in contact with its surfaces. In order to ensure free air circulation between the motor and such covers, place wooden blocks as spacers.

3.3.2 Extended storage

When the motor is stored for a long period of time (two months or more) before start-up, it is exposed to external agents, such as temperature variations, moisture, aggressive agents, etc. The empty spaces inside the motor – such as rolling bearings, terminal boxes, and windings – are exposed to humidity, which can cause condensation, and, depending on the degree of air contamination, aggressive substances may also penetrate these empty spaces. Consequently, after long periods of storage, the winding insulation resistance may drop below the acceptable

values, internal components, such as rolling bearings, may oxidize, and the lubricant power of the lubricant agent in the bearings may be adversely affected. All of these influences increase the risk of damages before starting the motor.



ATTENTION

To assure that the motor warranty be valid, it is necessary to make sure that all preventive measures described in this manual, such as constructive aspects, maintenance, packaging, storage, and periodical inspections, are followed and recorded.

The extended storage instructions are valid for motors that remain stored for long periods (two months or more) before start-up or motors already installed that are in a prolonged stoppage, considering the same period.



ATTENTION

For extended periods of stoppage or storage, the water inside the frame must be drained (WGM motors with water-jacket cooling).

3.3.2.1 Storage location

In order to ensure the best storage conditions for the motor during long periods, the chosen location must strictly meet the criteria described in sections 3.3.2.1.1 and 3.3.2.1.2.

3.3.2.1.1 Indoor storage

In order to ensure better storage conditions for the motor, the storage site must comply strictly with the criteria described below:

- The storage site must be closed, covered, dry, free of air contaminants (moisture, vapor, dust, particles and aggressive fumes) and free of flooding;
- The site should be protected against sudden temperature variations, humidity, rodents and insects;
- Vibration-free location, to avoid damaging to the motor bearings;
- The floor must be of leveled concrete with resistant structure to support the motor weight;
- Must have system to fire detection and extinguishing;
- Be provided with electricity for supplying the space heaters with power failure detection system;
- Exclusive site to store electrical machines (do not mix with other equipment and/or products that could prejudice the correct motor storage);
- Site with facilities of cargo handling services, suitable to allow the motor handling and removal;
- There must be no gas present, such as chlorine, sulfur dioxide or acids;
- The site must have ventilation system with air filter;
- Ambient temperature between 5°C and 50°C, and should not present sudden temperature variation;
- Relative air humidity <50%;
- Must have prevention against dirt and dust deposition;
- The motor should be stored on a suitable metal base that prevents the absorption of moisture from the floor.

If any of these requirements is not met in the storage site, WEG suggests that additional protections be added to the motor package during the storage period, as follows:

- A closed wooden crate or the like with an electrical installation that allows the energization of the space heaters;
- If there is a risk of infestation and fungus formation, the package must be protected in the storage place by spraying it or painting it with appropriate chemicals;
- The package preparation must be prepared carefully by an experienced person.

3.3.2.1.2 Outdoor storage



ATTENTION

Outdoor storage of the motor is not recommended.

In case outdoor storage is unavoidable, the motor must be packed in specific packaging for such conditions, as follows:

- For outdoor storage (exposed to the weather), besides the packaging recommended for indoor storage, the package must be covered with protection against dust, moisture and other odd materials, using resistant canvas or plastic.
- The package must be placed on platforms or foundations that ensure protection against dirt and moisture and prevent it from sinking into the soil;
- After the package is covered, a shelter must be erected to protect it against direct rain, snow and excessive sun heat.



ATTENTION

In case the motor remains stored for long periods (two months or more), it is recommended to inspect it regularly as specified in the section 3.3.3.11 of this manual.

3.3.2.2 Separate parts

- If parts are supplied separately (terminal boxes, heat exchanger, end shields, etc.), these parts must be mounted on motor to store it;
- Spare parts must be stored in an adequate place, as specified in sections 3.3.2.1.1 and 3.3.2.1.2 of this manual.
- The relative humidity inside the package must not exceed 50%.
- Rolling bearings must not be subject to shocks, falls or storage with vibration or humidity, which can cause marks on the internal tracks or on the balls, reducing their useful life.

3.3.3 Preservation during the storage

3.3.3.1 Space heater

Space heaters must remain powered during storage to avoid moisture condensation inside the motor and ensure that the winding insulation resistance remains within acceptable levels.

The space heaters drive circuit must be unique and the voltage and current of this circuit must be measured and recorded monthly.

It is recommended that a signal be installed near the motor to indicate that the space heaters are energized.

3.3.3.2 Insulation resistance

During the storage period, the insulation resistance of the motor windings must be measured and recorded every two months, and before the motor installation or eventually if there is any change in the preservation process (Eg, prolonged lack of electricity).

The measurement procedures and the criteria for acceptance of the results shall be according to IEEE-43 Standard.

Any insulation resistance reduction must be investigated.

3.3.3.3 Exposed machined surfaces

All exposed machined surfaces (e.g., shaft end and flanges) are protected at the factory with a temporary protective agent (rust inhibitor).

This protection coating must be reapplied at least every six months or when removed and/or damaged.

Recommended Product: Protective agent Anticorit BW
Supplier: Fuchs

3.3.3.4 Sealing

The rubber seals, gaskets, plugs and cable glands of the motor shall be inspected annually and replaced, if necessary.

3.3.3.5 Bearings

3.3.3.5.1 Grease-lubricated rolling bearing

- The rolling bearings are lubricated at the factory for the motor tests.



ATTENTION

In order to keep the bearings in good condition during the storage period, **the shaft locking device must be removed every two months, and the motor rotor must be rotated at least 10 complete turns at 30 rpm** to circulate the grease and preserve the internal parts of the bearings.

- Before putting the motor into operation, the rolling bearings must be lubricated;
- If the motor remains stored for a period exceeding two years, the rolling bearings must be disassembled, washed, inspected and relubricated.

3.3.3.5.2 Sleeve bearing

Depending on the machine mounting position and the lubrication type, the machine can be transported with or without oil in the bearings.

The machine storage must be done in its original operating position and with oil in the bearings, when so specified.

The oil level must be respected, remaining in the middle of the sight glass.

In order to keep the bearings in good conditions during the storage period, the following preservation procedures must be performed:

- Close all the threaded holes with plugs;
- Check if all the flanges (e.g., oil inlet and outlet) are closed. If not, they must be closed with blind covers;

- The oil level must be respected, remaining in the middle of the oil sight glass;
- Every two months, the shaft-locking device must be removed, and the motor rotor must be rotated at least 10 complete turns at 30 rpm to circulate the oil and preserve the internal parts of the bearings.



NOTES

For bearings that have a high-pressure oil injection system (jacking), this system must be activated before rotating the machine rotor.

For bearings without oil tank (dry crankcase), the oil circulation system must be activated before rotating the machine shaft.

The shaft rotation must always be done in the machine rotation direction.

After six months of storage, the following procedure must be used for protecting both the bearing internally and the contact surfaces against corrosion:

- Close all the threaded holes with plugs;
- Seal the gaps between the shaft and the bearing seal on the shaft by applying water-proof adhesive tape;
- Check if all the flanges (e.g., oil inlet and outlet) are closed. If not, they must be closed with blind covers;
- Remove the upper sight glass from the bearing and apply the corrosion inhibitor spray (TECTYL 511 or equivalent) inside the bearing;
- Close the bearing with the upper sight glass.



NOTES

If the bearing has no upper sight glass, the top cover of the bearing must be disassembled to apply the corrosion inhibitor spray.

Each six months of storage, repeat the procedure described above.
If the storage period exceeds two years, the bearing oil must be replaced.

3.3.3.6 Terminal box

When the insulation resistance of the motor windings is measured, the main terminal box and the other terminal boxes must also be inspected, observing the following aspects:

- The inside must be dry, clean and free of any dust accumulation;
- The contact elements cannot present corrosion;
- The seals must be in proper condition;
- The cable inlets must be correctly sealed.



ATTENTION

If any of these items are not in proper condition, proceeds the adequate maintenance and, if necessary, replace damaged parts.

3.3.3.7 Air-water heat exchanger

To ensure better conditions or the radiator storage for long-term storage, the following criteria must be strictly met:

- Remove the flanged connections from the radiator to gain access to it;
- Drain the water inside the radiator tubes and heads completely;
- Blow hot air in one of the nozzles from 15 to 20 minutes in order to eliminate humidity inside of radiator. For this procedure, the radiator tubes shall be horizontally placed, and the inlet and outlet water flanges placed in such a way that the water are eliminated;
- After dried, the nozzles shall be covered with blind flanges with new sealing gaskets in order to assure a perfect sealing;
- Install a pressure gauge on one of the blind flanges and a globe valve on the other;
- Pressurize the cooler with inert gas (Nitrogen or other) at a pressure of 1.2 bar abs;
- This pressure shall be checked monthly during the radiator term storage, which shall not be exposed to temperatures exceeding 50°C;
- Considering that the storage procedure is followed, the radiator seals must be replaced every 3 years, as recommended by the radiator supplier.



ATTENTION

The pressurized radiator must be handled with care. Use a warning plate informing that the equipment is pressurized and should not be exposed to temperatures exceeding 50°C.



NOTE

During short operation stoppages, instead of draining the water, it is preferable to keep its circulation at low speeds through the heat exchanger, thus ensuring that harmful products, such as ammonia compounds and hydrogen sulfide, are taken out of the radiator and not deposited inside.

3.3.3.8 Cleanliness and conservation of the motor during storage

- The motor should be free of oil, water, dust and dirt.
- The motor outside must be cleaned with compressed air under reduced pressure;
- Remove the removable rust signs with a clean cloth soaked in petroleum solvent.
- Check that the bearings and lubrication hollows are free of dust and dirt and if the bearing plugs are properly tightened.

Risks, marks or rust on the shaft-end should be carefully removed.

3.3.3.9 Inspections and records during storage

The stored motor must be inspected periodically and inspection records must be filed.

The following items must be inspected:

1. Check the motor for physical damages and repair it, if necessary;
2. Inspection of the cleanliness conditions;
3. Check for signs of water condensation inside the motor;
4. Check of the protective coating conditions of the exposed machined parts;
5. Check the paint conditions, and repair if necessary;
6. Check for aggressive agents signs;
7. Check the operation of the space heaters.
8. Measure and record the temperature, insulation resistance and polarization index of the stator winding;
9. Make sure that the storage location complies with the criteria described in section 3.3.2.1.

3.3.3.10 Predictive/preventive maintenance

WEG recommends that, every 3 years of storage, the stored motor be sent to a WEG Authorized Repair Shop or to WEG own factory, in order to perform a complete predictive maintenance.

The complete predictive maintenance procedure comprises disassembling the complete motor for inspection and, after assembly, performing a routine test in the laboratory.

3.3.3.11 Maintenance plan during storage

During the storage period, the motor maintenance must be performed and recorded according to the plan described in Table 3.1.

Table 3.1: Storage plan

	Monthly	2 months	6 months	2 years	Before start-up	Notes
STORAGE LOCATION						
Inspect the cleanliness conditions		X			X	
Inspect the humidity and temperature conditions		X				
Inspect for insect infestation signs		X				
PACKAGE						
Inspect for damage			X			
Check the internal relative humidity		X				
Replace the desiccant in the package (if any)			X			Whenever necessary.
SPACE HEATER						
Check the operating conditions	X					
Measure the circuit voltage and frequency	X					
Check the function of the signal system (if any)			X			
WHOLE MOTOR						
Perform external cleaning			X		X	
Check the painting conditions			X			
Check the rust inhibitor on the exposed machined parts			X			
Reapply the rust inhibitor			X			
Inspect the rubber seals and gaskets			X			
Complete predictive maintenance						According to section 3.3.3.10
WINDINGS						
Measure the winding temperature		X			X	
Measure the insulation resistance		X			X	
Measure the polarization index		X			X	
TERMINAL BOX AND GROUNDING TERMINALS						
Clean the interior of the terminal boxes				X	X	
Inspect the seals and gaskets				X	X	
ROLLING BEARINGS						
Rotate the shaft		X				
Relubricate the bearing					X	
Disassemble and clean the bearing						If the storage period exceeds 2 years.
SLEEVE BEARINGS						
Rotate the shaft		X				
Apply corrosion inhibitor spray			X			
Clean the bearings					X	
Change the oil						If the storage period exceeds 2 years.

3.3.4 Preparation for commissioning

3.3.4.1 Cleaning

- The internal and external parts of the motor must be free of oil, water, dust and dirt.
- Remove the rust inhibitor from the exposed surfaces with a cloth damped in a petroleum-based solvent;
- Make sure that the bearings and cavities used for lubrication are free of dirt and that the cavity plugs are correctly sealed and tightened. Oxidation and marks on the bearing seats and on the shaft must be carefully removed.

3.3.4.2 Bearing inspection



ATTENTION

If the motor storage period exceeds six months, the sleeve bearings must be disassembled, inspected and cleaned, before starting the motor operation.

The sleeve bearings without oil tank (dry crankcase), regardless of the motor storage period, should necessarily be disassembled, inspected and cleaned before starting the motor operation.

Reassemble the sleeve bearings and carry out lubrication.

Contact WEG to perform this procedure.

3.3.4.3 Bearing lubrication

Use the lubricant specified for bearing lubrication. Information on the bearings and lubricants are indicated on the bearing nameplates, and the lubrication must be done as described in section 7.9 of this manual, always considering the type of bearing.

3.3.4.4 Insulation resistance verification

Before putting the motor into operation, the insulation resistance must be measured according to section 3.3.3.2 of this manual.

3.3.4.5 Air-water heat exchanger

- When starting the motor, ensure that the water circulates freely through the radiator;
- The radiator bolts should be tightened with torques of 40 to 50Nm;
- Make sure that there is no water leakage. Check the radiator gaskets, and replace if necessary;
- Check the heat exchanger sealing rubbers, and replace them if necessary.

3.3.4.6 Others

Follow the other procedures described in section 6 of this manual before putting the motor into operation.

4 INSTALLATION

4.1 INSTALLATION SITE

Electric motors must be installed in easily accessible places, allowing periodic inspections, on-site maintenance and, if necessary, removal for external services.

The following environmental conditions must be ensured:

- Clean and well-ventilated location;
- The installation of other equipment or walls must not block or hinder the motor ventilation;
- The area around and above the motor must be sufficient for maintenance or handling;
- The environment must be in accordance with the motor protection degree.

4.2 SHAFT LOCK

The motor leaves the factory with a lock on the shaft to prevent damages to the bearings during transportation. This lock must be removed prior to motor installation.



ATTENTION

The shaft-locking device must be installed whenever the motor is removed from its base (uncoupled) in order to prevent damages to the bearings during transportation. The shaft end is protected at the factory with a temporary protective agent (rust inhibitor). During the motor installation, it is necessary to remove this product from the grounding brush (if any) contact track on the shaft.

4.3 ROTATION DIRECTION

The motor rotation direction is indicated by a plate affixed to the frame on the drive end and in the motor specific documentation.



ATTENTION

Motors supplied with a single rotation direction must not operate in the opposite direction. In order to operate the motor in the direction opposite to the specified, consult WEG.

4.4 INSULATION RESISTANCE

4.4.1 Safety Instructions



DANGER

In order to measure the insulation resistance, the motor must be turned off and stopped. The winding being tested must be connected to the frame and grounded until all residual electrostatic charges are removed. Capacitors (if any) must also be grounded before disconnecting and separating the terminals to measure the insulation resistance. Failure to comply with these procedures may result in personal injury.

4.4.2 General considerations

When the motor is not immediately put into operation, it must be protected against moisture, high temperatures, and dirt, thus avoiding impacts on the insulation resistance.

The winding insulation resistance must be measured before putting the motor into operation.

If the environment is too humid, the insulation resistance must be measured periodically during storage. It is difficult to establish fixed rules for the actual value of winding insulation resistance, as it varies according to the environmental conditions (temperature, humidity), machine cleanliness conditions (dust, oil, grease, dirt) and quality and condition of the insulating material used.

The evaluation of the periodical follow-up records is useful to conclude whether the motor is able to operate.

4.4.3 Measurement on the stator windings

The insulation resistance must be measured with a **megohmmeter**. The testing voltage for the motor windings must be in accordance with Table 4.1 and IEEE43 standard.

Table 4.1: Voltage for the winding Insulation resistance test

Winding rated voltage (V)	Insulation resistance test - continuous voltage (V)
< 1000	500
1000 - 2500	500 - 1000
2501 - 5000	1000 - 2500
5001 - 12000	2500 - 5000
> 12000	5000 - 10000

Before measuring the stator winding insulation resistance:

- Disconnect all connections to the stator terminals;
- Disconnect and insulate all CTs and PTs (if any);
- Ground the motor frame;
- Measure the winding temperature;
- Ground all temperature sensors;
- Check the humidity.

The insulation resistance measurement of the stator windings must be done in the main terminal box.

The megohmmeter must be connected between the motor frame and the winding.

The frame must be grounded and the three phases of the stator winding must remain connected to the neutral point, according to Figure 4.1.

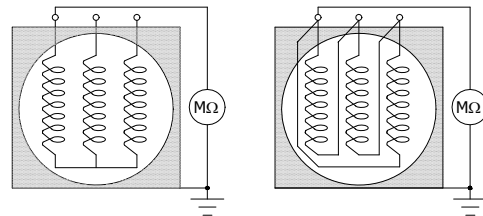

Figure 4.1: Megohmmeter connection

Whenever possible, each phase must be isolated and tested separately. The separate test allows the comparison between the phases. When a phase is tested, the other two phases must be grounded to the same ground of the frame, according to Figure 4.2.

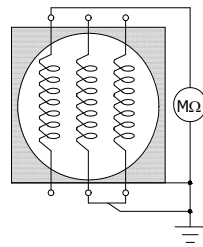



Figure 4.2: Connection of the megohmmeter to separate phases

If the total winding measurement presents a value below the recommended, the neutral connections must be opened and the insulation resistance of each phase must be measured separately.



ATTENTION

Much higher values may be frequently obtained from motors in operation for long periods of time. Comparison with values obtained in previous tests on the same motor - under similar load, temperature and humidity conditions - may be an excellent parameter to evaluate the winding insulation conditions, instead of using the value obtained in a single test as the basis. Significant or sudden reductions are considered suspicious.

4.4.4 Additional Information



ATTENTION

After measuring the insulation resistance, ground the tested winding in order to discharge it. The testing voltage to measure the insulation resistance of the space heater must be 500 Vdc and for the other accessories, 100 Vdc. It is not recommended to measure the insulation resistance of thermal protectors.

4.4.5 Polarization Index

The polarization index is defined by the ratio between the insulation resistance measured in 10 minutes and the insulation resistance measured in 1 minute. This measurement procedure is always carried out at relatively constant temperatures. The polarization index allows the assessment of the motor insulation conditions.



DANGER

In order to avoid accidents, the winding must be grounded immediately after measuring the insulation resistance.

4.4.6 Conversion of the measured values

The insulation resistance must be measured at 40°C. If the measurement is performed at a different temperature, it is necessary to correct the reading to 40°C by using a curve of the insulation resistance variation as a function of the temperature, obtained at the motor itself. If this curve is

not available, the approximate correction provided by the curve in Figure 4.3, according to NBR 5383 / IEEE43 standard, may be used.

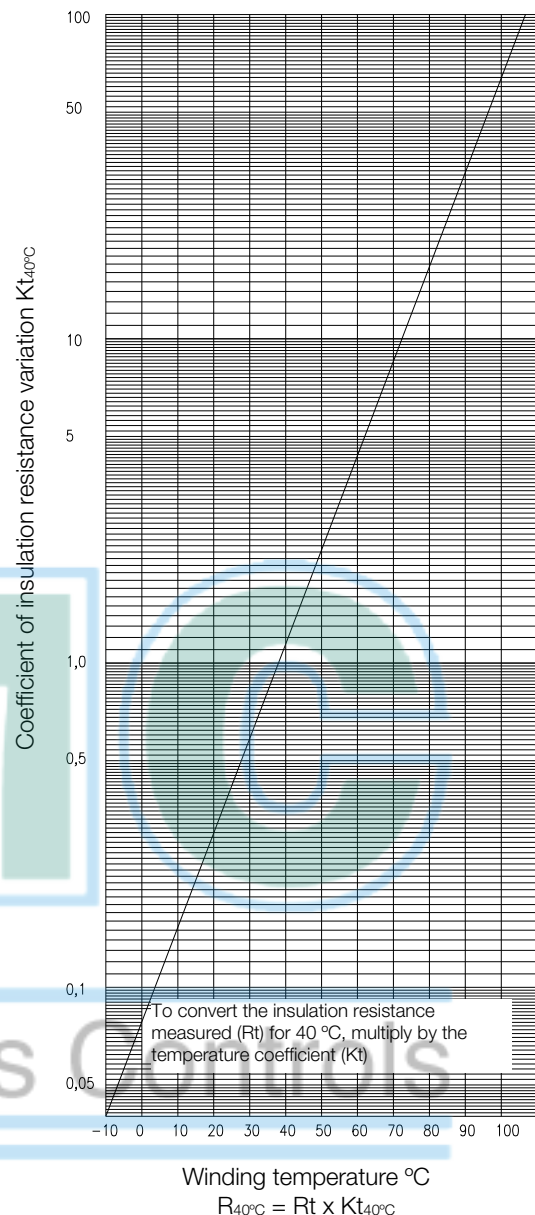

Figure 4.3: Insulation resistance variation coefficient according to the temperature

4.4.7 Insulation assessment

Table 4.2 and Table 4.3 present guiding limits of insulation resistance and polarization index for the assessment of the motor insulation conditions.

Table 4.2: Insulation resistance guiding limits on electrical machines

Insulation resistance value	Insulation assessment
2 MΩ or lower	Unacceptable
< 50 MΩ	Dangerous
50...100 MΩ	Fair
100...500 MΩ	Good
500...1000 MΩ	Very Good
> 1000 MΩ	Excellent

Table 4.3: Polarization index (ratio between 10 minutes and 1 minute)

Polarization Index	Insulation assessment
1 or lower	Unacceptable
< 1.5	Dangerous
1.5 to 2.0	Fair
2.0 to 3.0	Good
3.0 to 4.0	Very Good
> 4.0	Excellent

ATTENTION

If the measured insulation resistance, referred to 40 °C, is below 100 MΩ or the polarization index is below 2, than before putting the motor into operation, consult WEG.

4.5 PROTECTIONS

Motors used in continuous duty must be protected against overloads by means of a motor integral device, or an independent protection device, which is generally a thermal relay with rated or adjustable current equal to or below the value obtained by multiplying the full load motor supply current by:

- 1.25 for motors with service factor equal to or above 1.15;
- 1.15 for motors with service factor equal to 1.0.

Motors also have protection devices against overheating (in cases of overloads, locked rotor, low voltage, lack of motor ventilation).

4.5.1 Thermal protections

The temperature sensors are installed on the main stator, bearings and other parts that require temperature monitoring and thermal protection.

These sensors must be connected to an external temperature monitoring and protection system.

4.5.1.1 Temperature sensors

RTDs (Pt100) - Are calibrated resistance elements. Their operation is based on the principle that the electrical resistance of a metallic conductor varies linearly with the temperature. The detector terminals must be connected to a control panel that includes a temperature meter.

NOTE

Resistance temperature detectors (RTD) allow the monitoring via the absolute temperature informed through their instantaneous resistance value. With this information the relay, which may be programmed for alarm and trip according to pre-defined values, is able to perform the temperature reading.

4.5.1.2 Temperature limits for the windings

The temperature of the hottest spot of the winding must be kept below the limit of the insulation thermal class. The total temperature is obtained by the sum of the ambient temperature and the temperature rise (T), plus the difference between the average temperature of the winding and the hottest spot of the winding.

The ambient temperature must not exceed 40 °C, in accordance with NBR IEC60034-1 standard. Above this temperature, the working conditions are considered special and the motor specific documentation must be consulted.

Table 4.4 shows the numerical values and the composition of the acceptable temperature at the hottest spot on the winding.

Table 4.4: Insulation class

Insulation class		F	H
Ambient temperature	°C	40	40
T = temperature rise (temperature measurement method by resistance variation)	°C	105	125
Difference between the hottest spot and the average temperature	°C	10	15
Total: temperature of the hottest point	°C	155	180

ATTENTION

If the motor operates with winding temperatures above the limits of the insulation thermal class, the lifespan of the insulation, and hence that of the motor, will be significantly reduced, or it may even result in the motor burnout.

4.5.1.3 Alarm and trip temperatures

The motor alarm and trip temperatures must be set at the lowest possible value. These temperatures can be determined based on the factory tests or through the motor operating temperature. The alarm temperature can be set 10 °C above the machine operating temperature at full load, always considering the highest ambient temperature on site. The adjusted trip temperatures must not exceed the maximum admissible temperatures for the stator winding insulation class and for the bearings (considering the lubrication type and system), according to Table 4.5.

Table 4.5: Maximum temperature settings

	Maximum temperature settings for protections (°C)	
	Alarm	Tripping
Winding class F	130	155
Winding class H	155	180
Bearings	110	120

ATTENTION

The alarm and trip values may be determined as a result of experience, but they must not exceed the values indicated in Table 4.5.

ATTENTION

The motor protection devices are listed in the WEG drawing – Connection diagram. Not using these devices is the sole responsibility of the user and, in case of damage to the motor, it will void the warranty.

4.5.1.4 Temperature and ohmic resistance of the PT100 thermoresistance

Table 4.6 shows the temperature as a function of the ohmic resistance measured across PT100 RTDs.

Formula: $\frac{\Omega - 100}{0.386} = \text{°C}$

Table 4.6: Temperature X Resistance (Pt100)

°C	0	1	2	3	4	5	6	7	8	9
0	100.00	100.39	100.78	101.17	101.56	101.95	102.34	102.73	103.12	103.51
10	103.90	104.29	104.68	105.07	105.46	105.95	106.24	106.63	107.02	107.40
20	107.79	108.18	108.57	108.96	109.35	109.73	110.12	110.51	110.90	111.28
30	111.67	112.06	112.45	112.83	113.22	113.61	113.99	114.38	114.77	115.15
40	115.54	115.93	116.31	116.70	117.08	117.47	117.85	118.24	118.62	119.01
50	119.40	119.78	120.16	120.55	120.93	121.32	121.70	122.09	122.47	122.86
60	123.24	123.62	124.01	124.39	124.77	125.16	125.54	125.92	126.31	126.69
70	127.07	127.45	127.84	128.22	128.60	128.98	129.37	129.75	130.13	130.51
80	130.89	131.27	131.66	132.04	132.42	132.80	133.18	133.56	133.94	134.32
90	134.70	135.08	135.46	135.84	136.22	136.60	136.98	137.36	137.74	138.12
100	138.50	138.88	139.26	139.64	140.02	140.39	140.77	141.15	141.53	141.91
110	142.29	142.66	143.04	143.42	143.80	144.17	144.55	144.93	145.31	145.68
120	146.06	146.44	146.81	147.19	147.57	147.94	148.32	148.70	149.07	149.45
130	149.82	150.20	150.57	150.95	151.33	151.70	152.08	152.45	152.83	153.20
140	153.58	153.95	154.32	154.70	155.07	155.45	155.82	156.19	156.57	156.94
150	157.31	157.69	158.06	158.43	158.81	159.18	159.55	159.93	160.30	160.67

4.5.1.5 Space heater

When the motor is equipped with a space heater to prevent internal water condensation during long periods out of operation, it must be assured that the space heater is energized shortly after turning the motor off, and that it is de-energized before the motor is put into operation. The values of the space heater supply voltage and power are informed in the connection diagram and in the specific plate affixed to the motor.

4.5.2 Water leak sensor

Motors with air-water heat exchangers are supplied with a water leak sensor intended to detect accidental water leaks from the radiator into the motor. This sensor must be connected to the control panel, according to the motor connection diagram. The signal of this sensor must be used to activate the alarm.

When this protection actuates, the heat exchanger must be inspected and, if any water leak is detected, the motor must be shut down and the problem corrected.

4.6 COOLING

The motor cooling system type may vary according to its application. Only the correct installation of the motor and of the cooling system can ensure its continuous operation without overheating.



ATTENTION

The protection devices of the cooling system must be monitored periodically. The air and/or water inlets and outlets must not be obstructed, because this could cause overheating and even lead to the motor burnout. For further details, refer to the motor dimensional drawing.

4.6.1 Enclosed motors

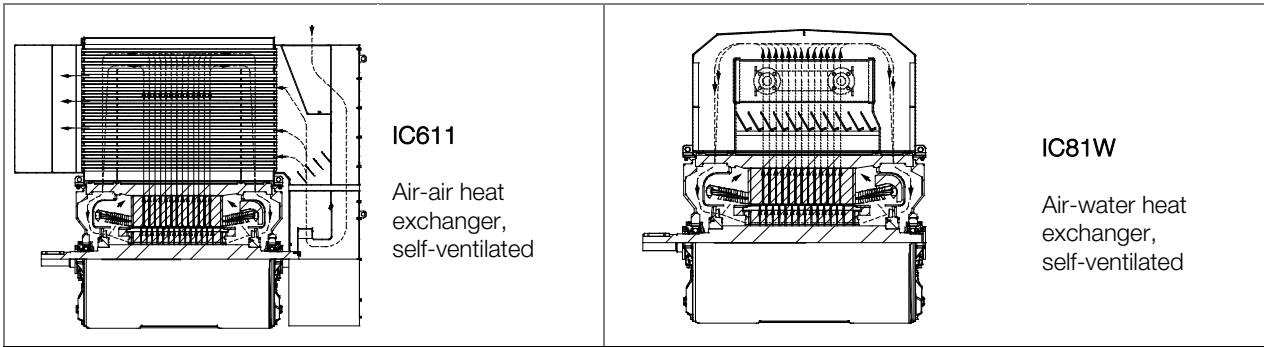

4.6.2 Open motors

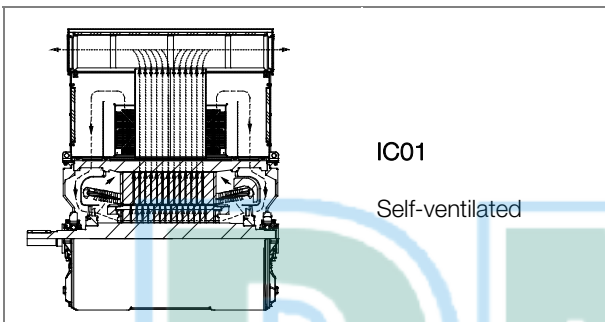

4.6.3 Air-water heat exchange cooling

In motors with air-water heat exchanger, the internal air, in a closed circuit, is cooled by the radiator, which is a surface heat transmitter designed to dissipate heat. Clean water with the following characteristics must be used as coolant:

- pH: 6 to 9;
- Chlorides: maximum 25.0 mg/l;
- Sulphates: maximum 3.0 mg/l;
- Manganese: maximum 0.5 mg/l;
- Suspended solids: maximum 30.0 mg/l;
- Ammonia: without ammonia dashes.

4.6.3.1 Radiators for application with seawater



ATTENTION

In the case of radiators for applications with seawater, the materials in contact with the water (pipes and plates) must be corrosion resistant. Furthermore, the radiators may be fitted with sacrificial anodes (e.g., zinc or magnesium), as shown in Figure 4.4, which are corroded during the heat exchanger operation, protecting the radiator heads. In order to maintain the integrity of the radiator heads, these anodes must be replaced periodically according to their corrosion level.



ATTENTION

Data of the radiators that compose the air-water heat exchanger are informed on their nameplate and on the motor dimensional drawing. This data must be observed for the proper operation of the motor cooling system, thus preventing overheating.

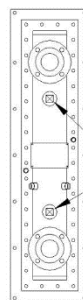

Sacrificial anodes

Figure 4.4: Radiator with sacrificial anodes



NOTE

The type, quantity and position of the sacrificial anodes may vary according to the application.

4.7 ELECTRICAL ASPECTS

4.7.1 Electrical connections



ATTENTION

Analyze the electrical connection diagram supplied with the motor carefully before beginning the connection of the main cables and those of the accessories. For the electrical connection of auxiliary equipment, refer to their specific manuals.

4.7.1.1 Main electrical connections

The locations of power, neutral and rotor terminal boxes are identified in the specific dimensional drawing of the motor.

The stator and rotor terminal identifications and their corresponding connections are indicated in the specific motor connection diagram.

Make sure the cross section and insulation of the connection cables are suitable for the motor current and voltage.

The motor must rotate in the rotation direction specified on the nameplate and on the sign plate affixed to the motor.



NOTE

The rotation direction is, by convention, determined looking to the shaft end at the motor drive end. Motors with a single rotation direction must only rotate in the indicated direction, since fans and other devices are unidirectional. In order to operate the motor in the rotation direction opposite to the specified, consult WEG.



ATTENTION

Before making the connections between the motor and the power supply, it is necessary to perform a careful measurement of the winding insulation resistance.

In order to connect the motor main power supply cables, unscrew the cover of the stator terminal box, cut the sealing rings (standard motors without cable gland) according to the diameter of the cables to be used and insert the cables in the sealing rings. Cut the power supply cables to the necessary length, strip the ends and mount the cable lugs that will be used.

4.7.1.2 Grounding

The motor frame and the main terminal box must be grounded before connecting the motor to the supply system.

Connect the metallic sheath of the cables (if any) to the common grounding conductor. Cut the grounding conductor to the proper length and connect it to the terminal in the terminal box and/or on the frame. Fasten all connections firmly.



ATTENTION

Do not use washers made of steel or other materials with low electrical conductivity to fasten the cable lugs.

4.7.2 Connection diagrams

The following connection diagrams show the terminal identification in the terminal box and the possible stator connections (phases) of squirrel cage three-phase induction motors.

Connection diagrams according to IEC60034-8

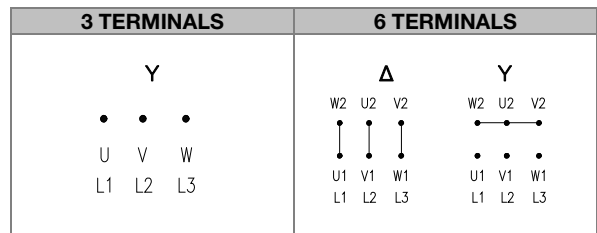

Connection diagrams according to NEMA MG1

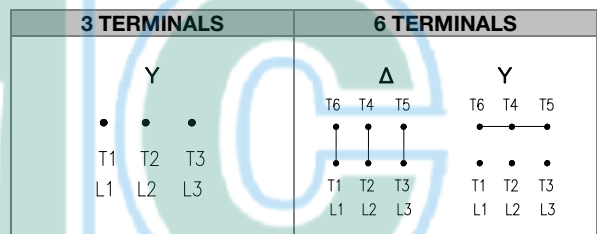

NOTE

When two or more motor connecting cables are used in parallel in order to divide the electric current, the identification of these cables is made with an additional suffix separated by a hyphen, according to Figure 4.5.

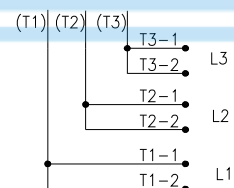

Figure 4.5: Parallel connections

4.7.2.1 Rotation direction

- The rotation direction is indicated on the nameplate and must be observed looking to the shaft end at the motor drive end. The rotation direction must be checked before coupling the motor to the driven machine;
- Motors with terminal identification and connections as described in this manual have clockwise rotation direction, according to IEC60034-8 standard;
- In order to invert the rotation direction, it is necessary to swap any two phases;
- Motors with a single rotation direction, as indicated on the nameplate and on sign plate affixed to the frame, have unidirectional fan and must be operated only in the specified rotation direction. In order to invert the rotation direction of unidirectional motors, consult WEG.

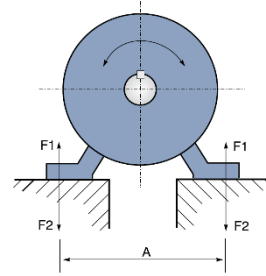

Figure 4.6: Foundation loads

4.7.2.2 Accessory connection diagrams

For the correct installation of the accessories, refer to the drawing in the specific connection diagram of the motor.

4.8 MECHANICAL ASPECTS

4.8.1 Foundations

- The foundation or structure where the motor will be installed must be sufficiently rigid, flat, free of external vibration and capable to withstand the mechanical loads to which it will be submitted;
- If the dimensioning of the foundation is not carefully executed, this may cause vibration in the foundation, on the motor and the driven machine;
- The foundation structural design must be done based on the dimensional drawing, on the information about foundation mechanical loads, and on the motor anchoring method.



ATTENTION

Place shims of different thicknesses between the motor supporting surfaces and the foundation in order to allow a precise alignment.



NOTE

The user is responsible for dimensioning and building the foundation where the motor will be installed.

4.8.2 Foundation loads

Based on Figure 4.6, foundation loads can be calculated by the equations:

$$F_1 = +0.5.m.g. + \frac{(4C \max)}{(A)}$$

$$F_2 = +0.5.m.g. - \frac{(4C \max)}{(A)}$$

Where: F1 and F2 - Reaction of the feet on the base (N)
g - Acceleration of gravity (9.81m/s²)
 m - Motor mass (kg)
 Cmax - Maximum torque (Nm)
 A - Obtained from the motor dimensional drawing (m)

4.8.3 Base types

4.8.3.1 Concrete base

Concrete bases are the most widely used for the installation of these motors. The type and size of the foundation, bolts and anchoring plates depend on the motor size and type.

Example of preparation:

- Remove all the dirt from the foundation to ensure a proper binding between the foundation blocks and the mortar.
- Fasten the foundation blocks to the motor feet using bolts.
- Use shims of different thicknesses (total thickness of approximately 2 mm) between the motor feet and the foundation surfaces in order to obtain a precise vertical alignment.
- In order to ensure the centralization of the bolts regarding the foot holes, use a metallic or a cardboard (prespan) sheet as bushing, making possible a precise horizontal alignment later.
- **Place shims or leveling bolts under the foundation** blocks to ensure proper leveling and perfect alignment of the motor with the driven machine. After the mortar is applied, the alignment must be precisely controlled. Occasional small corrections may be done with washers or metal sheets or by readjusting the clearance of the fastening bolts.
- Tighten all the fastening bolts firmly. Make sure the motor feet surfaces are supported evenly without distorting the motor frame.

For precise fixation, introduce the tapered pins after finishing the test.

4.8.3.2 Sliding base

In case of pulley drive, the motor must always be mounted on a sliding base (rails), and the lower part of the belt must be tightened.

The rail closer to the driving pulley must be mounted so that the positioning bolt is placed between the motor and the driven machine. The other rail must be mounted with the bolt in the opposite position, as shown in Figure 4.7.

The motor is bolted on rails and positioned on the foundation.

The driving pulley is then aligned so that its center and the center of the driven pulley are in the same plane, and the motor and machine shafts are perfectly parallel.

The belt must not be stretched too much. After the alignment, the rails are fixed.

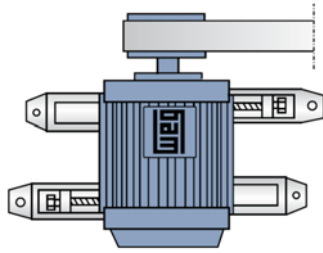

Figure 4.7: Sliding base

4.8.3.3 Metal base

The motor must rest evenly on the metal base in order to prevent deformations of the frame. Occasional errors in the height of the surface that supports the motor feet can be corrected with shims (a maximum height of 2 mm is recommended).

Do not remove the machines from the common base to align them. The base must be leveled on the foundation by using spirit levels or other leveling devices.

When a metal base is used to align the height of the motor shaft end with the machine shaft end, it must be leveled on the concrete base.

After the base has been leveled, the anchor bolts tightened and the couplings checked, then the metal base and the anchor bolts are cemented.

4.8.3.4 Anchor bolts

Anchor bolts are devices to fasten the motors directly on the foundation when the motors are applied with elastic coupling. This coupling type is characterized by the absence of loads on the bearings.

The anchor bolts must neither be painted, nor present rust, since that impairs the adhesion to the concrete, loosening them.

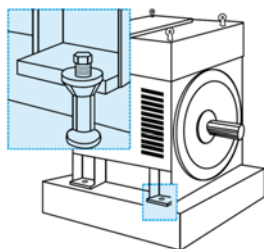

Figure 4.8: Anchor bolts

4.8.4 Anchor plate set

The anchor plate set, when used, is composed of the anchor plate, leveling bolts, leveling shims, alignment bolts and anchor bolts.

NOTES

When WEG supplies the anchor plate for fastening and aligning the motor, the dimensional and installation details of the anchor plate are supplied in the specific dimensional drawing of the motor.

The user is responsible for mounting, leveling and grouting the anchor plates (except when otherwise specified by commercial agreement).

The anchor bolts must be fastened according to Table 4.7.

Table 4.7: Tightening torque of the anchor bolts

Type Ø	Dry tightening torque [Nm]	Tightening torque with Molycote [Nm]
M30	710	470
M36	1230	820
M42	1970	1300
M48	2960	1950

After positioning the motor, perform the final leveling using the vertical leveling bolts and the leveling shims.



ATTENTION

Protect all the threaded holes to prevent grout from penetrating the threads during the grouting of the anchor plate and anchor bolts.

4.8.5 Natural frequency of the base

In order to ensure a safe operation, the motor must be precisely aligned with the coupled equipment and both must be properly balanced.

As a requirement, the motor installation base must be flat and meet the requirements of DIN 4024-1 standard.

In order to verify if the criteria of the standard are being met, the following potential vibration excitation frequencies generated by the motor and coupled machine must be checked:

- The motor rotation frequency;
- The double of the rotation frequency;
- The double of the motor electric frequency.

According to DIN 4024-1 standard, the natural frequencies of the base or foundation must be away from these potential excitation frequencies, as specified next:

- The first natural frequency of the base or foundation (first order natural frequency of the base) must be out of the range from 0.8 to 1.25 times any of the potential excitation frequencies above;
- The other natural frequencies of the base or foundation must be out of the range from 0.9 to 1.1 times any of the potential excitation frequencies above.

4.8.6 Leveling

The motor must rest on a surface with flatness of up to 0.08 mm/m.

Verify whether the motor is perfectly leveled, both in the vertical and horizontal planes. Make the proper adjustments by placing shims under the motor. The motor leveling must be checked with proper equipment.



NOTE

At least 75% of the motor foot support surfaces must rest on the motor base.

4.8.7 Alignment

The motor must be correctly aligned with the driven machine.



ATTENTION

Incorrect alignment can damage the bearings, generate excessive vibration and even break the shaft.

The alignment must be done according to the coupling manufacturer recommendations. The motor and driven machine shafts must be aligned in the axial and radial directions, as shown in Figure 4.9 and Figure 4.10.

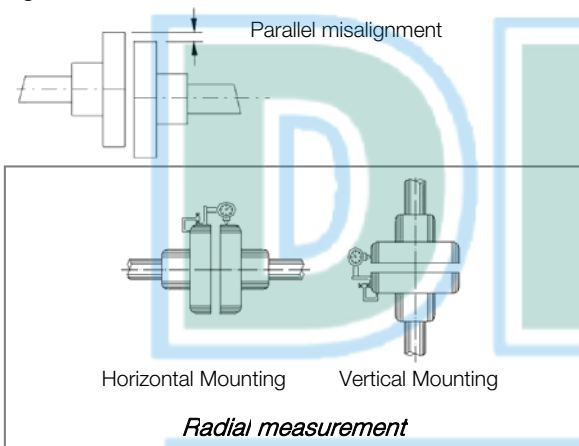

Figure 4.9: Parallel alignment

Figure 4.9 shows the parallel misalignment of the two shaft ends and the practical way to measure it by using suitable dial gauges. The measurement is performed in four points 90° away from each other with the two half-couplings rotating together in order to eliminate effects of support surface irregularities on the dial gauge tip. Choosing the upper vertical point as 0°, half of the difference between the dial gauge measurements at the 0° and 180° points represents the vertical coaxial error. In case of deviation, it must be corrected by adding or removing leveling shims. Half of the difference between the dial gauge measurements at the 90° and 270° points represents the horizontal coaxial error. These measurements indicate when it is necessary to lift or lower the motor, or move it to the right or to the left on the drive end in order to eliminate the coaxial error. Half of the maximum difference among the dial gauge measurements in a complete rotation represents the maximum eccentricity found. The misalignment in a complete shaft rotation, with rigid or semiflexible coupling, cannot exceed 0.03 mm. When flexible couplings are used, greater values than those indicated above are acceptable, provided that they do not exceed the value allowed by the coupling manufacturer. It is recommended to keep a safety margin for these values.

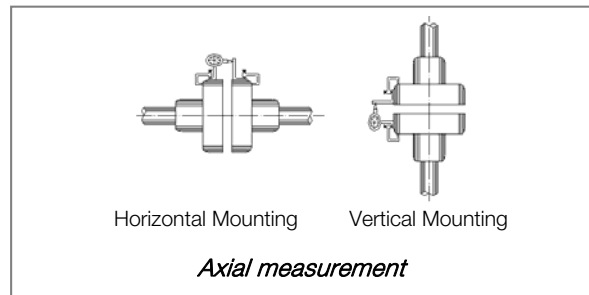
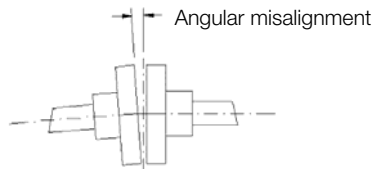

Figure 4.10: Angular alignment

Figure 4.10 shows the angular misalignment and a practical form to measure it. The measurement is done in four points 90° away from each other, with the two half-couplings rotating together in order to eliminate effects of support surface irregularities on the dial gauge tip. Choosing the upper vertical point as 0°, half of the difference between the dial gauge measurements at the 0° and 180° points represents the vertical misalignment. In case of deviation, it must be corrected by adding or removing alignment shims. Half the difference between the dial gauge measurements at the 90° and 270° points represents the horizontal misalignment, which must be properly corrected by displacing the motor in the lateral/angular direction. Half of the maximum difference among the dial gauge measurements in a complete rotation represents the maximum angular misalignment found. The misalignment in a complete shaft rotation, with rigid or semiflexible coupling, cannot exceed 0.03 mm. When flexible couplings are used, greater values than those indicated above are acceptable, provided that they do not exceed the value allowed by the coupling manufacturer. It is recommended to keep a safety margin for these values.

In the alignment/leveling, the influence of the temperature on the motor and the driven machine must be taken into account. Different expansions of the parts may change the alignment/leveling conditions during operation.

4.8.8 Doweling

After aligning the set and having assured a perfect alignment (**both, hot and cold**), the motor must be doweled to the anchor plate or to the base, as shown in Figure 4.11.

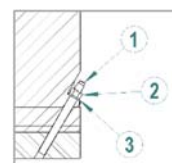



Figure 4.11: Dowel pin set

Figure 4.11 legend:

- 1. Dowel pin (optional supply)
- 2. Nut (optional supply)
- 3. Washer (optional supply)

4.8.9 Couplings

Only proper couplings, which convey only torque without generating transversal forces, must be used. For both flexible and rigid couplings, the shaft centers of the coupled machines must be in a single line. Flexible couplings mitigate the effects of residual misalignments and prevent transmission of vibration between the coupled machines, which does not occur when rigid couplings are used. The coupling must be mounted or removed with the aid of proper devices and never by means of rudimentary tools, such as hammers, sledgehammers, etc.

 **ATTENTION**
Dowel pins, nuts, washers and leveling shims may be supplied with the motor, when requested in the purchase order.

 **NOTES**
The user is responsible for the motor installation (unless otherwise specified by commercial agreement). WEG is not liable for damages to the motor, associated equipment and installation occurred because of:

- Transmission of excessive vibration;
- Poor installations;
- Faulty alignment;
- Improper storage conditions;
- Noncompliance with the instructions before start-up;
- Incorrect electrical connections.

4.8.9.1 Direct coupling

Because of issues about cost, space economy, problems with belt sliding and more safety against accidents, direct coupling must be used whenever possible. Also, direct coupling is preferable in case of transmission with reduction gearing.

 **ATTENTION**
Align the shaft ends carefully, and, whenever possible, use flexible coupling, leaving a minimum clearance (E) of 3 mm between the couplings, as shown in Figure 4.12.

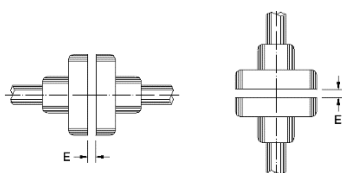

Figure 4.12: Axial clearance of the coupling (E)

4.8.9.2 Gear coupling

Gear couplings badly aligned generate vibration in the transmission itself and in the motor. Therefore, caution must be taken so that the shafts be perfectly aligned, rigorously parallel in case of spur gear transmissions and in a correct angle in case of transmissions by bevel or helical gears. The gear teeth meshing can be controlled with the insertion of a paper strip, on which the trace of all teeth shows up after a gear turn.

4.8.9.3 Belt drive

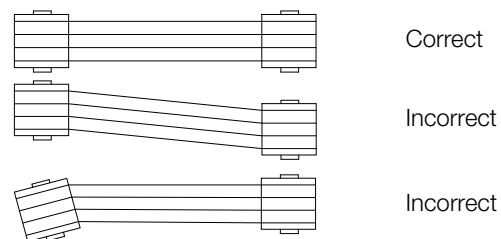





Figure 4.13: Belt drive

When a reduction or increase in speed is required, the belt transmission is the most indicated. In order to avoid unnecessary stress on the bearings, the shafts and the pulleys must be perfectly aligned. Belts that operate obliquely transmit alternating jolts to the rotor and will be able to damage the bearings. Belt slippage can be prevented by applying a resin like material, such as pitch for instance. The belt tension must be just enough to prevent slippage during operation.

 **NOTE**
Belts too tensioned increase the load on the shaft end, causing vibration and fatigue, or even the break of the shaft.

Avoid using too small pulleys, since they cause flexion of the motor shaft because of the belt traction force that, which increases as the diameter of the pulley decreases.

 **ATTENTION**
Consult WEG for the correct sizing of the pulley.

 **NOTE**
Always use properly balanced pulleys. Avoid extra key lengths, because they increase the unbalancing mass and increase the motor vibration.

4.8.9.4 Coupling of motors equipped with sleeve bearings

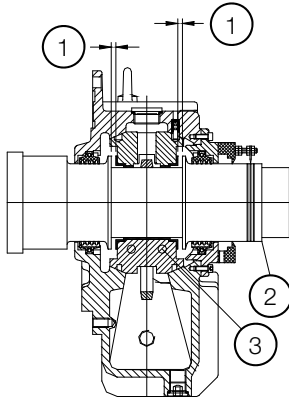

Figure 4.14: Sleeve bearing

Figure 4.14 legend:

- 1. Axial clearance
- 2. Shaft
- 3. Bearing shell

ATTENTION

Motors equipped with sleeve bearings must operate with direct coupling to the driven machine or by means of a gear box. This type of bearing does not allow belt drive.

Motors equipped with sleeve bearings have three marks on the shaft end, so that the central mark (painted red) is the indication of the magnetic center, and the two outer marks indicate the allowed limits for axial rotor movement.

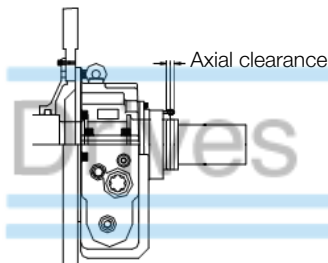

Figure 4.15: Magnetic center mark

For the motor coupling, the following factors must be taken into account:

- Bearing axial clearance;
- Axial displacement of the driven machine (if any);
- Maximum axial clearance allowed by the coupling.

ATTENTION

- Move the shaft completely forward and then perform the correct measurement of the axial clearance;
- Align the shaft ends carefully and, whenever possible, use a flexible coupling, leaving a minimum axial clearance of **3 to 4 mm** between the couplings.



NOTE

If it is not possible to move the shaft, then the shaft position, the shaft forward displacement (according to the marks on the shaft), and the axial clearance recommended for the coupling must be considered.

- Before putting it into operation, it is necessary to check whether the motor shaft allows free axial movement within the aforementioned clearance conditions;
- In operation, the arrow must be positioned on the central mark (red), which indicates that the rotor is in its magnetic center;
- During the start, or even in operation, the motor will be able to move freely between the two outer limit marks.



ATTENTION

The sleeve bearings used on this motor were not designed to withstand constant axial loads; therefore, under no circumstances can the motor operate continuously under axial load on the bearings. The motor can only operate continuously under axial/radial loads on the bearing if the criteria informed in the motor documentation are observed.

4.9 HYDRAULIC UNIT

For further information on installation, operation and maintenance of the hydraulic unit (if any), refer to the motor dimensional drawing and the specific manual of this equipment.

5 STARTING

5.1 DIRECT ON-LINE STARTING

It is the simplest and most economically feasible method; however, it must only be used when the starting current does not affect the power grid.

Bear in mind that the starting current of motors may reach 6 to 7 times the rated current value. Therefore, it must be ensured that this current (I_p) will not affect the supply of other consumers because of the high voltage drop in the power grid.

This requirement is met in one of the three situations:

- a) When the power grid is "**strong**" enough and the motor current is negligible in relation to the grid capacity.
- b) The motor is always started without load, which reduces the starting time and, in turn, the duration of the starting current and the momentary voltage drop, which is acceptable for the other consumers of the grid;
- c) When DOL starting is duly authorized by the local electric utility company.

When the motor starting current is high, the following detrimental consequences may occur:

- a) The high voltage drop in the power supply system may cause interference in equipment installed in this system;
- b) The protection system (cables, contactors) must be oversized, increasing the installation costs.



NOTE

In some cases, there is an imposition of the electric utility companies that limits the voltage drop of the grid.

5.2 DIRECT ONLINE STARTING FREQUENCY

Since induction motors have a high starting current, the time spent to accelerate loads with high inertia results in a quick rise of the motor temperature. If the intervals between successive starts are too short, the temperature of the windings will rise quickly, reducing their useful life or even burning them. The NBR 17094 and IEC60034-1 standards establishes a minimum starting duty to which the motors must be able to comply:

- a) Two successive starts: the first one with the motor cold, i.e., with its windings at ambient temperature, and the second one right afterwards, but only after the motor has decelerated to a full stop;
- b) One start with the motor hot, i.e., with the windings at continuous duty temperature.

The first condition simulates the case in which the first motor start is aborted, for instance, by the trip of the motor protection, when a second motor start is permitted right afterwards.

The second condition simulates the case of an accidental motor shutdown under normal operation, for instance, by power outage, when the motor restart is allowed right after the power is reestablished.



NOTE

Special starting conditions must be checked in the specific motor documentation before starting the procedure.

5.3 LOCKED ROTOR CURRENT

The motor nameplate indicates the value of I_p/I_n , which is the relation between the starting current and the rated current of the motor.

5.4 STARTING WITH REDUCED CURRENT

If direct online starting is not possible, the following starting systems can be used in order to reduce the motor starting current.

- Star-delta starter;
- Series-parallel starter;
- Autotransformer starter;
- Static starter or soft-starter;
- Frequency inverter.

6 COMMISSIONING

When the motor is started for the first time or after a prolonged standstill, several aspects must be considered besides the regular operation procedures.



ATTENTION

- Avoid any contact with electric circuits;
- Even low-voltage circuits may be life threatening;
- In any electromagnetic circuit, overvoltages may occur under certain operating conditions;
- Do not open an electromagnetic circuit suddenly, because the presence of an inductive discharge voltage may break the insulation or injure the operator;
- In order to open those circuits, disconnect switches or circuit breakers must be used.

6.1 PRELIMINARY INSPECTION

Before the first motor start or after long periods out of operation, the following items must be inspected:

1. Check if all the motor fastening bolts are tightened;
2. Measure the winding insulation resistances, making sure they are within the specified values;
3. Check if the motor is clean and if the packages, measuring instruments and alignment devices were removed from the motor operating area;
4. Check if coupling connecting components are in perfect operating conditions, duly tightened and greased, where necessary;
5. Check if the motor is correctly aligned;
6. Check if the bearings are properly lubricated. The lubricant must be of the type specified on the nameplate;
7. Check the oil level of oil-lubricated bearings. Bearings with forced lubrication must have the oil pressure and flow as specified on their nameplate;
8. Inspect the cable connections of accessories (thermal protectors, grounding, space heaters, etc.);
9. Check if all electrical connections comply with the motor connection diagram;
10. Check if the motor is properly grounded;
11. The cables connected to the stator and rotor main terminals must be properly tightened in order to prevent their short-circuit or loosening;
12. Inspect the cooling system. In water-cooled motors, inspect the operation of the radiator water supply system. In motors with independent ventilation, check the rotation direction of the fans;
13. Motor air inlets and outlets (if any) must be unobstructed;
14. The moving parts of the motor must be protected to prevent accidents;
15. The terminal box covers must be correctly fastened;
16. Check if the power supply voltage and frequency comply with the data on the motor nameplate;
17. Inspect the operation of the anti-reversion devices (if any).

6.2 FIRST STARTING

6.2.1 Starting procedure

After all preliminary inspections have been carried out, proceed according to the directions presented next in order to perform the first start of the uncoupled motor:

1. Turn off the space heater;
2. Set the protections in the control panel;
3. In oil-lubricated bearings, check the oil level;
4. In bearings with forced-lubrication, start the oil circulation system and check the level, flow and pressure of the oil, making sure that they comply with the data on the nameplate.
5. If the system has oil flow detection equipment, it must be waited until the flow return signal from the oil circulation system of both bearings is received, which makes sure that the oil has reached the bearings;
6. Start the industrial water cooling system checking the required flow and pressure (motors with air-water heat exchanger);
7. Turn on the fans (motors with forced ventilation);
8. Switch on the high-pressure oil injection system (if any), keeping it on as informed in the motor technical documentation until the bearings get the lubrication by self-pumping;
9. Rotate the motor shaft slowly in order to check that no part is being dragged or any abnormal noises are occurring;
10. After the previous steps have been adequately completed, it is possible to proceed with the motor starting sequence;
11. Start the motor with no load, making sure it rotates smoothly without strange noises;
12. Check the rotation direction with the motor uncoupled;
13. In order to invert the rotation direction, just invert the connections of any two phases;



ATTENTION

In order to invert the rotation direction of motors with single direction, it is necessary to consult WEG.

14. Keep the motor rotating at rated speed and write down the bearing temperatures at 1-minute intervals until they become constant. Any sudden increase in bearing temperature indicates lubrication or friction surface abnormality;
15. Monitor the temperature, the oil level of the bearings, and the vibration levels. If there is a significant variation

- of any value, interrupt the motor starting, identify possible causes and make the necessary corrections;
16. When the bearing temperatures stabilize, it is possible to proceed to the other motor operation steps.



ATTENTION

The noncompliance with the procedures described in section 6.2 may impair the motor performance, cause damages and even lead to its burnout, voiding the warranty.

6.3 OPERATION

The operating procedures vary considerably depending on the motor application and the type of control equipment used.

Only the general procedures are described in this manual. For the control system operating procedures, refer to the specific manual of this equipment.

6.3.1 General

After a first successful starting test, couple the motor to the driven load, and then the starting procedure can be reinitiated, as follows:

- Start the motor coupled to the load until its temperature stabilizes and check for unusual noises, abnormal vibrations or excessive heating. If significant vibration variations occur regarding the initial operation condition until the condition after reaching thermal stability, then it is necessary to check the alignment and the leveling.
- Measure the current consumption and compare it to the value given on the nameplate.
- In continuous duty, without load variation, the measured current must not exceed the value indicated on the nameplate multiplied by the service factor;
- All the instruments and devices for measurement and control must be permanently monitored to detect occasional alterations, determine their causes and make the proper corrections.

6.3.2 Temperatures

- The temperatures of the bearings, stator winding and cooling system must be monitored while the motor is operating.
- These temperatures must stabilize within 4 to 8 hours of operation.
- The stator winding temperature depends on the machine load; therefore, the driven load must also be monitored during the motor.

6.3.3 Bearings

The system start, as well as the first hours of operation, must be monitored carefully.

Before putting the motor into operation, verify:

- If the high-pressure oil injection system (if any) is ON;
- If the external lubrication system (if any) is ON;
- If the used lubricant complies with the specifications;
- The lubricant characteristics;
- The oil level (oil-lubricated bearings);
- If the bearing alarm and trip temperatures are set;
- During the first start, it is important to pay attention to unusual vibrations or noises;
- If the bearing is not working silently and smoothly, the motor must be shut down immediately;
- In case of overheating, the motor must be shut down immediately for the inspection of bearings and

temperature sensors, and the correction of possible causes;

- The motor must operate for several hours until bearing temperatures stabilize within the specified limits;
- After the bearing temperatures stabilize, check if there are no leaks through the plugs, gaskets or shaft end.

6.3.3.1 High-pressure oil injection system

In bearings which have the option for shaft lifting when starting or stopping by means of oil pressure, the activation of this system is done by means of an external oil pump, and the following procedure must be observed:



ATTENTION

The high-pressure oil injection system must be switched on before putting the motor into operation and during the shutdown procedure, as informed in the motor technical documentation.

6.3.4 Radiators

During the operation of motors with air-water heat exchanger, it is necessary:

- Controlling the temperature at the radiator inlet and outlet and, if necessary, correcting the water flow;
- Adjusting the water pressure just to overcome the resistance in the pipes and in the radiator;
- In order to control the motor operation, it is recommended to install thermometers at the radiator air and water inlets and outlets and record these temperatures at certain time intervals;
- When installing the thermometers, recording or signaling instruments (siren, lights) can also be installed in certain places.

Verification of the radiator performance

- For operation control purposes, it is recommended that water and air temperatures at the radiator inlets and outlets be measured and recorded periodically;
- The radiator performance is expressed by the temperature difference between cold water and cold air during normal operation. This difference must be checked periodically. If an increase in this difference is observed after a long period of normal operation, verify the need for radiator cleaning.
- The accumulation of air inside the radiator can lead to a performance reduction or to its damage. In this case, a deaeration of the radiator and the pipes may solve the problem;
- The water pressure differential can be considered an indicator of the need for cleaning the radiator.
- It is also recommended to measure and record the difference between the water pressure before and after the radiator. Periodically, the values measured must be compared to the original value, and an increase of the pressure differential indicates the need for cleaning the radiator.

6.3.5 Vibration

The motors are balanced at the factory in compliance with the vibration limits established by IEC60034-14, NEMA MG1 – Part 7 and NBR 11390 standards (except when the purchase contract specifies different values).

The vibration measurements are carried out on the NDE and DE bearings, in the vertical, horizontal and axial directions. When the customer sends the half coupling to WEG, the motor is balanced with the half coupling mounted on the shaft. Otherwise, according to the standards above, the motor is balanced with half-key (i.e., the key slot is filled with a bar of the same width, thickness and height of the key slot during the balancing operation). The maximum vibration levels attended by WEG for motors in operation are informed in Table 6.1. These values are generic and for guidance, and the specific application conditions must always be taken into account:

Table 6.1: Vibration (RMS)

Rated speed (rpm)	Vibration Levels (mm/s RMS)			
	Frame	< 355	355 to 560	> 630
600 ≤ n ≤ 1800	Alarm	4.5	4.5	5.5
	Tripping	7.0	7.0	8.0
1800 < n ≤ 3600	Alarm	3.5	4.5	5.5
	Tripping	5.5	6.5	7.5

The main vibration causes are:

- Misalignment between the motor and the driven equipment;
- Improper fastening of the motor to the base, with “loose shims” under one or more motor feet, and loose fastening bolts;
- Improper or insufficiently rigid base;
- External vibrations proceeding from other equipment.

ATTENTION
Operating the motor with vibration levels above the values contained in Table 6.1 may impair its useful life and/or performance.

6.3.6 Shaft vibration limits

In motors equipped with or prepared for the installation of proximity sensors (normally used on sleeve bearings), the surfaces of the shaft are prepared with special finishing in the areas adjacent to the bearings, in order to assure the correct measurement of the shaft vibration.

The shaft vibration measured in these motors must comply with the IEC 60034-14 or NEMA MG 1 standard. The alarm and trip values of Table 6.2 represent the acceptable shaft vibration values for coupled electrical machines according to the ISO7919-3 standard. These values are generic and for guidance, and the specific application conditions must always be taken into account, especially the diametrical clearance between the shaft and the bearing.

Table 6.2: Shaft vibration

Rated Speed (rpm)	Shaft Vibration (µm peak-to-peak)			
	Frame	280 and 315	355 to 450	> 450
1800	Alarm	110	130	150
	Tripping	140	160	190
3600	Alarm	85	100	120
	Tripping	100	120	150



ATTENTION

Operating the motor with shaft vibration values within the alarm or tripping range may cause damages to the bearing shell.

The main causes for increase in shaft vibration are:

- Coupling unbalance issues or other problems that may also generate machine vibration;
- Shaft shape problems in the measurement region, minimized during manufacturing;
- Residual magnetism or voltage on the shaft surface where the measurement is done;
- Scratches, dents or variations on the shaft finishing in the measurement region.

6.3.7 Shutdown

In order to shut down the motor, proceed as follows:

- Reduce the load of the driven equipment, if possible;
- Open the main circuit breaker;
- Switch on the high-pressure oil injection system (if any);

After the motor stops completely:

- Switch off the high-pressure oil injection system (if any);
- Switch off the oil circulation system of the bearings (if any);
- Switch off the hydraulic unit (if any);
- Shut down the industrial water system (if any);
- Switch off the forced ventilation system (if any);
- Switch on the space heaters. They must be kept ON until the next motor operation.



DANGER

Even after switching the motor off, while the rotor is rotating, there is danger to life by touching any of the motor active parts.



ATTENTION

The terminal boxes of motors equipped with capacitors must not be opened before their full discharge.

Discharge time of the capacitors: five minutes after shutting down the motor.

6.4 OPERATION AS ASYNCHRONOUS GENERATOR

For operation as asynchronous generator, besides the procedures mentioned in section 6.3, it is necessary to consider the following particularities of this application:

6.4.1 Operation

In order to operate as an asynchronous generator, the induction machine must be electrically connected in parallel to the power grid and mechanically coupled to a driving machine that provides a speed slightly above the synchronous speed.

The more the rotor speed is increased, the greater is the power transferred as electromagnetic force to the stator, which in turn is converted in electric energy to feeding the power grid.



ATTENTION

If the rotor is at the exact synchronous speed, the stator magnetic field speed will be equal to the rotor speed, and thus there will be no current induction on the rotor and consequently no energy will be generated.

6.4.2 Slip

The asynchronous generator speed and the generated electric energy vary according to the torque applied to it. In practice, the difference between the speed at the generator rated power and the synchronous speed is very small, about 1 to 3 percent. This difference in percentage is called slip.



ATTENTION

Check in the technical data sheet the rated speed for operation as asynchronous generator. At this speed, the generator will have the nameplate rated power. Imposing a torque above the maximum torque of the generator causes overspeed and the generator can be damaged.

6.4.3 Precautions

The asynchronous generators present the following restrictions:

- The machine that drives the asynchronous generator must have a precise speed control and protection against overspeed;
- The induction generator must not operate at a speed above its rated speed.

7 MAINTENANCE

7.1 GENERAL

A proper maintenance program for electric motors includes the following recommendations:

- Keep the motor and the associated equipment clean;
- Measure the winding insulation resistance periodically;
- Measure the temperature of windings, bearings and cooling system periodically;
- Check the wear, operation of the lubrication system and useful life of the bearings;
- Measure the motor vibration levels;
- Inspect the cooling system;
- Inspect associated equipment;
- Inspect all the motor accessories, protections and connections, ensuring that they are operating properly;



ATTENTION

Noncompliance with the recommendations of section 7.1 may cause undesired stoppages of the equipment. The frequency of such inspections depends on the local application conditions. Every time that it becomes necessary to transport the motor, the shaft must be properly locked to prevent damages to the bearings. Use the device supplied with the motor to lock the shaft. If the motor requires reconditioning or replacement of any damaged part, consult WEG.

7.2 GENERAL CLEANING

- Keep the frame clean, without external accumulation of oil or dust, in order to facilitate the heat exchange with the environment;
- The inside of the motor must also be kept clean, free of dust, debris and oils;
- For cleaning, use brushes or clean cotton cloths. If the dust is not abrasive, the cleaning must be done with an industrial vacuum cleaner, "aspiring" the dirt from the fan cover and the dust accumulated on the fan blades and on the frame;
- Debris impregnated with oil or moisture can be removed with a cloth soaked in appropriate solvents;
- Clean the terminal boxes when necessary. Terminals and connectors must be kept clean, free of rust and in perfect operating conditions. Avoid the presence of grease or verdigris in the connection parts.

7.3 WINDING INSPECTIONS

Yearly, the windings must be submitted to a complete visual inspection, recording and repairing all and every damage or defect observed.

The winding insulation resistance measurements must be done at regular intervals, especially during humid weather and after prolonged motor stoppages.

Low values or sudden variations in the insulation resistance must be investigated.

The windings must be submitted to complete visual inspections at frequent intervals, recording and repairing all and every damage or defect observed.

The winding insulation resistance can be increased up to an adequate value in the points where it is low (as a result of excessive dust and moisture) by means of the dust removal and by drying the winding moisture.

7.4 WINDING CLEANING

In order to obtain a more satisfactory operation and a longer useful life of the insulated windings, it is recommended to keep them free of dirt, oil, metal dust, contaminants, etc.

Therefore, it is necessary to inspect and clean the windings periodically, according to the recommendations of the "Maintenance Plan" of this manual. If reimpregnation is necessary, consult WEG.

The windings may be cleaned with an industrial vacuum cleaner with a non-metallic crevice tool or just a dry cloth. For extreme dirt conditions, it may be necessary to use a proper liquid solvent for cleaning. This cleaning must be quick to prevent prolonged exposure of the windings to the solvent effects.

After being cleaned with solvents, the windings must be completely dried.

Measure the insulation resistance and the polarization index in order to assess the winding insulation conditions. Winding drying time after cleaning varies depending on the weather conditions such as temperature, humidity, etc.



DANGER

Most solvents currently used are highly toxic and/or flammable. Solvents must not be used in the straight parts of the coils of high-voltage motors, because they may affect the protection against corona effect.

7.4.1 Inspections

The following inspections must be carried out after the windings are carefully cleaned:

- Check the insulations of the winding and connections;
- Check if spacers, bindings, slot wedges, bandages and supports are properly fixed;
- Check for breaks, faulty welds, short-circuit between turns and against the frame in the coils and connections. In case any fault is detected, consult WEG.
- Ensure that all cables are properly connected and that terminal fixation components are duly tightened. Retighten, if necessary.

7.4.2 Reimpregnation

If any layer of resin on the windings is damaged during cleaning or inspection, such parts must be corrected with adequate material (in this case, consult WEG).

7.4.3 Insulation Resistance

The insulation resistance must be measured after the completion of all of the maintenance procedures.



ATTENTION

Before putting the motor back into operation, it is essential to measure the winding insulation resistance and ensure that the measured values meet the specifications.

7.5 COOLING SYSTEM MAINTENANCE

- The pipes of the air-air heat exchanger (if any) must be kept clean and unobstructed to ensure a perfect heat exchange. In order to remove the dirt accumulated in the pipes, a rod with a round brush at the end may be used.
- In case of air-water heat exchangers, periodic cleaning in the radiator pipes is necessary to remove all and any incrustation.



NOTE

If the motor has filters in the air inlets and/or outlets, they must be cleaned with compressed air.
If the dust is difficult to remove, wash the filters with cold water and neutral detergent and dry them in the horizontal position;
In case the filters are impregnated with dust containing grease, it is necessary to wash them with gasoline, kerosene or another petroleum solvent or hot water with P3 additive;
All the filters must be dried after the cleaning.
Do not twist them;
Replace the filter if necessary.

7.6 RADIATOR MAINTENANCE

The degree of dirt in the radiator can be detected by the increase of the temperature at the air outlet. When the temperature of the cold air, under the same operating conditions, exceeds the specified value, it can be assumed that the pipes are dirty.

If corrosion is found in the radiator, it is necessary to provide adequate protection against corrosion (i.e., zinc anodes, cover with plastic, epoxy or other similar products), in order to prevent further damage to the parts already affected.

The external surface of all the radiator parts must always be kept in good conditions.

Instructions for removal and maintenance of the radiator

In order to remove the radiator for maintenance, use the following procedure:

1. Close all the water inlet and outlet valves after stopping the ventilation;

2. Drain the water through the radiator drain plugs;
3. Remove the heads, keeping the bolts, nuts, washers and seals (gaskets) in a safe place;
4. Brush the inside of the pipes carefully with nylon brushes in order to remove residues. If damages to the radiator tubes are found during the cleaning, they must be repaired;
5. Reassemble the heads, replacing the gaskets, if necessary.

Sacrificial anodes

Sacrificial anodes are used in radiators that operate with seawater. The regular inspection must be carried out, according to the maintenance plan. If excessive corrosion is found in the sacrificial anode, the frequency of inspection must be increased in order to determine the corrosion period and establish a plan for proper replacement intervals.

7.7 VIBRATION

Any evidence of increase in the unbalance or vibration of the motor must be investigated immediately.

7.8 SHAFT GROUNDING DEVICE

The shaft grounding brush (if any) avoids the circulation of electric current through the bearings, which is detrimental to their operation. The brush is put in contact with the shaft and connected by a cable to the motor frame, which must be grounded. Make sure that the brush holder fastening and its connection to the frame have been made correctly.

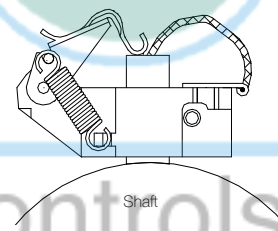

Figure 7.1: Shaft grounding brush

Drying oil is used to protect the motor shaft against rust during transportation. In order to ensure the proper operation of the grounding brush, this oil, as well as any residue between the shaft and the brush, must be removed before starting the motor. The brush must be constantly monitored during operation, and it must be replaced by another one of the same quality (granulation) at the end of its useful life.

7.9 BEARING MAINTENANCE

7.9.1 Grease-lubricated rolling bearings

7.9.1.1 Instructions for lubrication

The lubrication system was designed in such a way that during the lubrication of the rolling bearings, all the old grease is removed from the rolling bearing races and expelled through a drain which enables the exit of the grease, but prevents the ingress of dust or other harmful contaminants.

This drain also prevents damage to the rolling bearings by the known problem of excessive lubrication.

It is recommended to make the lubrication with the motor in operation in order to ensure the renewal of the grease in the rolling bearing housing.

If that is not possible due to the presence of rotating parts near the grease nipple (pulleys, etc.) which may put the operator at risk, follow the procedures below:

- With the motor stopped, inject approximately half of the total intended amount of grease and operate the motor for approximately one minute at full speed;
- Stop the motor and inject the rest of the grease.



ATTENTION

The injection of all the grease with the motor stopped may lead to the penetration of part of the lubricant into the motor through the internal seal of the rolling bearing cap;

It is important to clean the grease nipples prior to lubrication in order to prevent foreign materials from being dragged into the rolling bearing. For lubrication, use only manual grease gun.



NOTE

The rolling bearing data, amount and type of grease, and lubrication intervals are informed on a bearing nameplate affixed to the motor. Check this information before performing the lubrication.

- The lubrication intervals informed on the nameplate consider a 70 °C working temperature of the rolling bearing;
- Based on the operating temperature ranges listed in Table 7.1, apply the following correction factors for the rolling bearing lubrication intervals:

Table 7.1: Reduction factor for lubrication intervals

Bearing operating temperature	Reduction factor
Below 60 °C	1.59
Between 70 and 80 °C	0.63
Between 80 and 90 °C	0.40
Between 90 and 100 °C	0.25
Between 100 and 110 °C	0.16

7.9.1.2 Procedures for rolling bearing relubrication

1. Remove the drain plug;
2. Clean with a cotton cloth around the hole of the grease nipple;
3. With the rotor operating, inject the grease with a manual grease gun until grease starts coming out from the drain;
4. Keep the motor running long enough so that the grease excess passes through the drain;
5. Inspect the bearing temperature to make sure there was no significant change;
6. Put the drain plug back in place.

7.9.1.3 Rolling bearing relubrication with drawer device for grease removal

In order to relubricate the bearings, the old grease is removed by means of the device with a drawer installed on each bearing.

Lubrication procedure:

1. Before starting the lubrication of the bearing, clean the grease nipple with a cotton cloth;
2. Remove the rod with drawer to remove the old grease, clean the drawer and put it back in place;
3. With the motor running, inject the amount of grease specified on the rolling bearing nameplate by means of a manual grease gun;
4. The excess of grease comes out through the bearing lower drain and is deposited in the drawer;
5. Leave the motor running long enough for the grease excess to drain;
6. Remove the excess of grease, by pulling the drawer rod and cleaning the drawer. This procedure must be repeated as many times as necessary until the drawer no longer retains grease;
7. Inspect the bearing temperature to ensure that there was no significant change.

7.9.1.4 Type and amount of grease

The relubrication of the bearings must always be done with the **original grease**, specified on the bearing nameplate and in the documentation of the motor.



ATTENTION

WEG does not recommend the use of greases different from the motor original grease.

It is important to perform a correct lubrication, i.e., to apply the correct grease and in the proper quantity, because either poor or excessive lubrication will damage the rolling bearings.

Excessive amount of grease cause temperature increase, due to the great resistance it offers to the movement of the bearing rotating parts. Consequently, due to the heating, the grease can completely lose its lubricating characteristics.

7.9.1.5 Grease compatibility

You can say that greases are compatible when the properties of the mixture are within the property ranges of the greases individually.

In general, greases with the same type of soap are compatible; however, depending on the proportion of the mixture, there might be incompatibility. Therefore, it is not recommended to mix different types of grease without consulting the grease supplier or WEG.

Some thickeners and basic oils cannot be mixed, because they do not form a homogeneous mixture. In this case, one cannot rule the possibility of hardening or softening of the grease, or reduction of the dropping point of the resulting mixture.



ATTENTION

Greases with different types of base must never be mixed.
For example: Lithium-based greases must never be mixed with sodium or calcium-based greases.

Disassembly

In order to disassemble the bearing, proceed according to the directions below:

1. Remove the screws (4) that fix the closing disc (13);
2. Remove the labyrinth taconite seal (6);
3. Remove the screws (3) from the bearing caps (1 and 5);
4. Remove the outer bearing cap (5);
5. Remove the screw (7) that fixes the grease flinger (8);
6. Remove the grease flinger (8);
7. Remove the D-end shield;
8. Remove the rolling bearing (10);
9. Remove the inner bearing cap (1), if necessary.



ATTENTION

- During the bearing disassembly, it is necessary to be careful not to damage the balls, rollers or shaft surface;
- Keep the disassembled parts in a safe and clean place.

7.9.1.6 Bearing disassembly

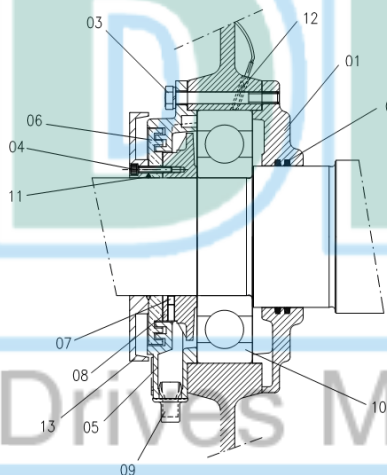

Figure 7.2: Parts of the grease-lubricated rolling bearing

Figure 7.2 legend:

1. Inner bearing cap
2. White felt
3. Bearing cap fastening screw
4. Disc fastening screw
5. Outer bearing cap
6. Labyrinth taconite seal
7. Grease flinger fastening screw
8. Grease flinger
9. Grease collecting drawer
10. Rolling bearing
11. Grease nipple
12. Thermal protector
13. External closing disc

Before disassembling:

- Remove the extension tubes from the grease inlet and outlet;
- Thoroughly clean the external part of the bearing;
- Remove the grounding brush (if any);
- Remove the temperature sensors from the bearing

7.9.1.7 Bearing assembly

- Clean the bearings completely and inspect the disassembled parts and the inside of the bearing caps;
- Make sure the rolling bearing, shaft and bearing cap surfaces are perfectly smooth;
- Fill up to $\frac{3}{4}$ of the inner and outer bearing cap deposits with the recommended grease (Figure 7.3) and lubricate the rolling bearing with enough grease before assembling it;
- Before assembling the rolling bearing on the shaft, heat it up to a temperature between 50 °C and 100 °C;
- For the complete assembly of the bearing, follow the disassembly instructions in the reverse order.

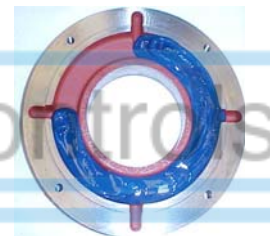

Figure 7.3: Outer bearing cap

7.9.2 Rolling bearing replacement

The disassembly of rolling bearings must be done with an appropriate tool (rolling bearing puller). The arms of the puller must be placed on the lateral surface of the inner ring to be disassembled or on an adjacent part.

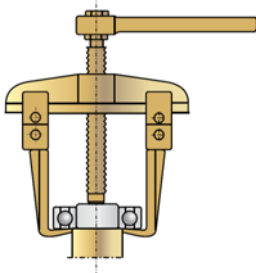

Figure 7.4: Tool for rolling bearing extraction

7.9.3 Sleeve bearings

7.9.3.1 Bearing data

The characteristic data, such as oil flow, quantity and type, are indicated on the bearing nameplate and must be strictly observed; otherwise, overheating and damages to the bearings may occur. The hydraulic installation (for bearings with forced lubrication) and the oil supply for the motor bearings are responsibilities of the user.

7.9.3.2 Bearing installation and operation

For information on the bill of materials, assembly and disassembly instructions, and maintenance details, refer to the specific installation and operation manual of the bearings.

7.9.3.3 Cooling by water circulation

The sleeve bearings with cooling by water circulation have a serpentine inside the oil tank through which the water circulates. In order to assure an efficient bearing cooling, the circulating water must have at the bearing inlet a temperature lower or equal to the ambient, so that the cooling takes place. The water pressure must be 0.1 bar and the flow equal to 0.7 l/s. The pH must be neutral.



NOTE

Under no circumstances can water leak into the oil tank, because this will contaminate the lubricant.

7.9.3.4 Oil change

Self-lubricated bearings

The bearing oil change must be done according to the intervals, which depend on the bearing operating temperatures, shown in Table 7.2:

Table 7.2: Oil change intervals

Bearing operating temperature	Bearing oil change intervals
Below 75 °C	20,000 hours
Between 75 and 80 °C	16,000 hours
Between 80 and 85 °C	12,000 hours
Between 85 and 90 °C	8,000 hours
Between 90 and 95 °C	6,000 hours
Between 95 and 100 °C	4,000 hours

Bearings with external oil circulation

The oil of the bearings must be changed every 20,000 hours of operation or whenever the lubricant presents modifications in its characteristics. The oil viscosity and pH must be checked periodically.



NOTE

The oil level must be inspected daily, and it must remain in the middle of the oil sight glass.

The bearings must be lubricated with the specified oil, respecting the flow rate informed on their nameplate; All threaded holes that are not used must be closed with plugs and no fitting may present leaks. The oil level is reached when the lubricant can be seen approximately in the middle of the sight glass. The use of a larger amount of oil will not damage the bearing, but it can cause leaks through the shaft seals.



ATTENTION

The care with the lubrication will determine the useful life of the bearings and the safety in the motor operation. Therefore, the following recommendations must be observed:

- The selected lubricant oil must be the one with proper viscosity for the operating temperature of the bearings; That must be observed at every oil change or during periodical maintenances;
- Never use or mix hydraulic oil with the lubricant oil of the bearings;
- Lack of lubricant, due to incomplete filling or non-monitoring of the level, can damage the bearing shells;
- The minimum oil level is reached when the lubricant can be seen in the lower part of the sight glass with the motor stopped.

7.9.3.5 Sealing

Make visual inspections of the sealing, making sure that the dragging marks of the seal on the shaft do not compromise its integrity, checking for cracks and broken parts. Cracked or broken parts must be replaced.

In case of bearing maintenance, in order to assemble the seal, it is necessary to carefully clean the seal contact surfaces and its enclosure, and cover the sealing with a non-hardening component (i.e. **Curil T**). The two halves of the labyrinth taconite seal must be joined by a garter spring.

The drain holes located in the lower half of the seal must be cleaned and unobstructed.

Improper installation can damage the sealing and cause oil leakage.



ATTENTION

For further information about the dismounting and mounting of sleeve bearing seals, refer to the specific manual of this equipment.

7.9.3.6 Sleeve bearing operation

The system start, as well as the first hours of operation, must be monitored carefully.

Before starting, check:

- If the oil inlet and outlet tubes (if any) are, clean. Clean the tubes by pickling, if necessary;
- If the used oil complies with the specification on the nameplate;
- The lubricant characteristics;
- The oil level;
- The alarm and trip temperatures set for the bearing.

During the first start, it is necessary to stay alert for unusual vibrations or noises. If the bearing does not operate in a silent and smooth way, the motor must be shut down immediately.

The motor must operate for several hours until the bearing temperatures stabilize. In case of overheating of the bearings, the motor must be shut down for inspection of the bearings and temperature sensors.

Check if there is no oil leak through the plugs, gaskets or shaft end.

7.9.3.7 Sleeve bearing maintenance

The sleeve bearing maintenance includes:

- Periodic checking of the oil level and its lubricating conditions;
- Checking the bearing noise and vibration levels;
- Monitoring of the operating temperatures and retightening of the fastening and mounting screws;
- In order to facilitate the heat exchange with the environment, the frame must be kept clean, without external dust or oil accumulation;
- The NDE bearing is electrically insulated. The spherical seat surfaces of the bearing shell on the frame are covered with insulating material. Never remove this cover;
- The anti-rotation pin is also insulated, and the seals are made of non-conducting material;
- Temperature control devices that are in contact with the bearing shell must also be properly insulated.

7.9.3.8 Bearing disassembly and assembly

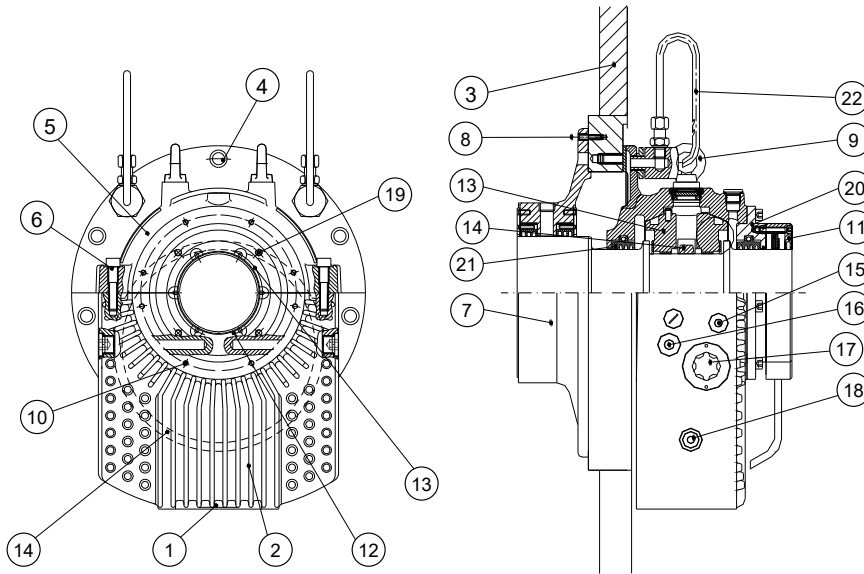

Figure 7.5: Parts of the sleeve bearing

Figure 7.5 legend:

1. Drain plug
2. Bearing housing
3. Motor frame
4. Fastening screws
5. Bearing housing cap
6. Split bearing cap screws
7. Machine seal
8. Machine seal screws
9. Eyebolt
10. Outer cover screw
11. Outer cover
12. Lower bearing shell
13. Upper bearing shell
14. Loose oil ring
15. Oil inlet
16. Temperature sensor fitting
17. Oil level sight glass or oil outlet for lubrication
18. Tube plug
19. Outer protection screws
20. Labyrinth taconite seal housing
21. Labyrinth taconite seal
22. Breather pipe

Disassembly

In order to disassemble the bearing and get access to the bearing shells, as well as to other components, proceed carefully as the following guidelines.

Keep all parts in a safe place (Figure 7.5).

Drive end:

- Clean the outside of the housing thoroughly. Loosen and remove the oil drain plug (1) located in the lower part of the housing, draining all the lubricant;
- Remove the screws (4) that fasten the upper half of the housing (5) to the motor (3);
- Remove the bolts (6) that join the halves of the housing (2 and 5);
- Use the lifting lugs (9) to lift the upper half of the housing (9), totally disassembling it from the lower halves of the outer sealing (11), from the labyrinth taconite seals, from the labyrinth taconite seal housings (20) and from the bearing shell (12);
- Proceed the disassembling of the upper half of the housing on a bench. Loosen the screws (19) and remove the upper half of the outer protection. Remove

- the screws (10), and undock the upper half of the labyrinth taconite seal housing (20);
- Undock and remove the upper half of the bearing shell (13);
- Remove the screws that join the two halves of the loose oil ring (14), and carefully separate and remove them;
- Remove the garter springs from the labyrinth taconite seals and remove the upper half of each seal. Rotate the lower halves of the seals out of their housing and remove them;
- Disconnect and remove the temperature sensor installed in the lower half of the bearing shell;
- Using a hoist or jack, lift the shaft some millimeters so that the lower half of the bearing shell can be turned out of its seat. To do this, it is necessary to loosen the screws 4 and 6 of the other half of the bearing;
- Carefully rotate the lower half of the bearing shell over the shaft and remove it;
- Remove the screws(19) and remove the lower half of the outer protection(11);
- Remove the screws (10) and the lower half of the housing of the labyrinth taconite seal (20);
- Remove the screws (4) and remove the lower half of the housing (2);
- Remove the screws (8) and remove the machine seal (7). Clean and inspect thoroughly the removed parts and inside of the housing.



NOTE

Tightening torque of the bearing fastening bolts to the motor = 10 Kgf.m.

Non-drive end:

- Clean the outside of the housing thoroughly. Loosen and remove the oil drain plug (1) located in the lower part of the housing, draining all the lubricant;
- Loosen the screws (19) and remove the bearing cap (11);
- Loosen the screws (4) that fasten the upper half of the housing (5) to the motor (3). Remove the screws (6) that join the split faces of the bearing housing (2 and 5);

- Use the lifting lugs (9) to lift the upper half of the housing (5), undocking it thoroughly from the lower halves of the housing (2), labyrinth taconite seal and bearing shell (12);
- Undock and remove the upper half of the bearing shell (13);
- Remove the screws that join the two halves of the loose oil ring (14) and carefully separate and remove them;
- Remove the garter spring from the labyrinth taconite seal and remove the upper half of the seal. Rotate the lower half of the taconite seal out of its housing and remove it;
- Disconnect and remove the temperature sensor installed in the lower half of the bearing shell;
- Using a hoist or jack, lift the shaft some millimeters so that the lower half of the bearing shell can be turned out of its seat;
- Carefully rotate the lower half of the bearing shell (12) over the shaft and remove it;
- Remove the screws (4) and remove the lower half of the housing (2);
- Undock the screws (8) and the machine seal (7);
- Clean and inspect thoroughly the removed parts and the inside of the housing;

on the lower half. Incorrect mountings may cause serious damages to the bearing shells;

- Check if the loose oil ring turns freely on the shaft. With the lower half of the bearing shell in place, install the seal on the bearing flanged side (see section 7.9.3.5).

After covering the split faces of the housing with a non-hardening sealing component, mount the upper part of the housing (5), taking care that the gasket seals stay perfectly adjusted to their fittings. Also make sure that the anti-rotation pin is fitted without any contact with the corresponding hole in the bearing shell.

7.9.4 Bearing protection

7.9.4.1 Protection settings



ATTENTION

The following temperatures must be set on the bearing protection system:
Alarm 110 °C – Trip 120 °C

The alarm temperature must be set 10 °C above the operating temperature, not exceeding the limit of 110 °C.



NOTE

Tightening torque of the bearing fastening bolts to the motor = 10 Kgfm.

Assembly

- Check the fitting surfaces of the flange, making sure that they are clean, flat and free of burrs;
- Check if the shaft dimensions are within the tolerances specified by the manufacturer and if the rugosity complies with the requirements (< 0.4 µm);
- Remove the upper half of the housing (2) and the bearing shells (12 and 13), check if there were any damages during transportation and clean the contact surfaces thoroughly;
- Lift the shaft some millimeters, fit the flange of the lower half of the bearing into the machined recess on the machine end shield, and screw it in this position;
- Apply oil to the spherical seat of the frame and to the shaft. Put the lower bearing shell (12) on the shaft and rotate it to its position, taking care not to damage the axial positioning surfaces. After carefully aligning the faces of the lower half of the bearing shell and the housing, slowly lower the shaft down to its operating position. With a hammer, gently hit the housing for the bearing shell to position properly in relation to its seat and the shaft. This procedure generates a high frequency vibration that decreases the static friction between the bearing shell and the housing, and facilitates its correct alignment;
- The bearing self-alignment capacity is intended to compensate only the regular deflection of the shaft during the assembly. Next, install the loose oil ring, which must be done very carefully, since the proper bearing operation depends on the lubrication supplied by the ring. The screws must be slightly tightened and any burr carefully removed in order to provide a smooth and uniform operation of the ring. In an occasional maintenance, be careful not to change the geometry of the ring;
- The lower and upper halves of the bearing shell have identification numbers or marks to guide their positioning. Position the upper half of the bearing shell by aligning its marking with the corresponding marking

7.9.4.2 Disassembly/assembly of the bearing temperature sensors

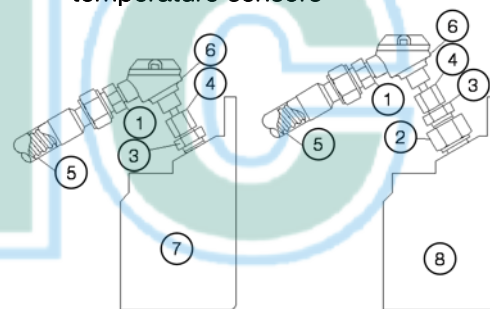

Figure 7.6: Pt100 on the bearings

Figure 7.6 legend:

- 1.Reduction nipple
- 2.Insulating adapter
- 3.Locknut
- 4.Bulb
- 5.Flexible metal tube
- 6.Pt-100 temperature sensor
- 7.Non-insulated bearing
- 8.Insulated bearing

Disassembly instructions:

If it is necessary to remove the Pt100 for bearing maintenance, proceed according to the following instructions:

- Remove the Pt100 carefully, locking the locknut (3), and unscrewing just the Pt100 from the bulb (4);
- Parts (2) and (3) must not be disassembled.

Assembly instructions:



ATTENTION

Before assembling the Pt100 on the bearing, check if it does not contain marks of knock or any other damage that may compromise its operation.

- Insert the Pt100 into the bearing;
- Restrain the locknut (3) with a wrench;
- Screw it in the bulb (4), adjusting it so that the tip of the Pt100 touches the outer surface of the bearing.



NOTES

- The assembly of the Pt100 on non-insulated bearings must be done directly on the bearing, without the insulating adapter (2);
- The tightening torque to assemble the Pt100 and the adapters must not exceed 10Nm.

DMC

Drives Motors Controls

8 MOTOR DISASSEMBLY AND ASSEMBLY



ATTENTION

All the repair, disassembly and assembly services must be performed only by properly qualified and trained professionals; otherwise, equipment damage and personal injury may occur. If any further explanations are necessary, consult WEG.

The disassembly and assembly sequences depend on the motor model.

Always use proper tools and devices. Any damaged part (cracks, dents on machined parts, faulty threads) must be replaced, avoiding restorations.

8.1 DISASSEMBLY

The following precautions must be taken when disassembling the electric motor:

1. Always use proper tools and devices to disassemble the motor;
2. Before disassembling the motor, disconnect the cooling water and lubrication pipes (if any);
3. Disconnect the motor electrical connections and those of the accessories;
4. Remove the heat exchanger and the noise suppressor (if any);
5. Remove the bearing temperature sensors and the grounding brush;
6. In order to prevent damages to the rotor and coil heads, support the shaft on both drive and non-drive ends;
7. In order to disassemble the bearings, follow the procedures described in this manual;
8. The removal of the rotor from the motor must be done with a suitable device and with extreme care so that the rotor does not drag on the stator laminated core or coil heads, thus preventing damages.

Table 8.1: Screw tightening torque for metal/metal parts

Material / Resistance class		Carbon Steel / 8.8 or above		Stainless steel / A2 – 70 or above	
% Yield Strength		60%		70%	
Lubricant		Dry	Molycote 1000	Dry	Molycote 1000
Diam	Pitch (mm)	Screws tightening torque (Nm)			
M3	0,5	1,2	0,8	1	0,69
M4	0,7	2,7	1,8	2,4	1,6
M5	0,8	5,4	3,6	4,8	3,2
M6	1	9,3	6,3	8,2	5,5
M8	1,25	22,4	15	20	13
M10	1,5	44	30	39	26
M12	1,75	77	52	67	45
M14	2	123	82	107	72
M16	2	188	126	165	110
M18	2,5	263	176	230	154
M20	2,5	368	246	322	215
M22	2,5	500	332	437	290
M24	3	637	425	557	372
M27	3	926	615	810	538
M30	3,5	1260	838	1102	734
M33	3,5	1704	1130	1490	990
M36	4	2195	1459	1920	1277
M42	4,5	3507	2328	3070	2037
M48	5	5258	3488	4600	3052

8.2 ASSEMBLY

In order to assemble the motor, follow the disassembly procedures in the reverse order.

Table 8.2: Screw tightening torque for metal/isolated parts

Material / Resistance class		Carbon Steel / 8.8 or above		Stainless steel / A2 – 70 or above	
% Yield Strength		33%		33%	
Lubricant		Dry	Molycote 1000	Dry	Molycote 1000
Diam	Pitch (mm)	Screws tightening torque (Nm)			
M3	0,5	0,6	0,5	0,48	0,32
M4	0,7	1,5	1	1,1	0,76
M5	0,8	3	2	2,2	1,5
M6	1	5,2	3,4	3,8	2,6
M8	1,25	12,3	8,3	9,2	6,2
M10	1,5	24	16	18,2	12,2
M12	1,75	42	28	32	21
M14	2	68	45	51	34
M16	2	104	69	78	52
M18	2,5	145	98	108	72
M20	2,5	202	135	152	101
M22	2,5	274	183	206	137
M24	3	350	233	263	175
M27	3	510	338	382	254
M30	3,5	693	461	520	346
M33	3,5	937	622	703	466
M36	4	1207	802	905	602
M42	4,5	1929	1280	1447	960
M48	5	2892	1918	2170	1440

8.3 AIR-GAP MEASUREMENT

After disassembling and assembling the motor, it is necessary to measure the air gap in order to check the concentricity between rotor and stator.

The difference between the air-gap measured in two points diametrically opposed must be less than 10% of the average air gap.

8.4 TIGHTENING TORQUE

Table 8.1 and Table 8.2 shows the tightening torques of the screws recommended for assembling the motor.



NOTE

The resistance class is normally indicated on the head of the hex bolts.

8.5 SPARE PARTS

When ordering spare parts, inform the motor type and serial number, according to the motor nameplate. WEG recommends keeping in stock the following spare parts:

Table 8.3: Spare parts list

Spare parts	Motor model					
	● Recommended			▲ Highly Recommended		
	MGA, MGP, MGD, MGT	MGF	MGW	MGL, MGI	MGR	W60
Temperature sensor for front and rear bearing	▲	▲	▲	▲	▲	▲
Space heater	▲	▲	▲	▲	▲	▲
Filter felt (if any)	▲	▲		▲		▲
Grounding Brush	▲	▲	▲	▲	▲	▲
Front and rear bearing for the fan motor (if applicable)				▲		
Lubricant for bearings	▲	▲	▲	▲	▲	▲
Vibration sensor for front and rear bearing (if applicable)	●	●	●	●	●	●
Vibration signal converter for front and rear bearing (if applicable)	●	●	●	●	●	●
Air temperature sensor (if applicable)	●	●	●	●	●	●
Water temperature sensor (if applicable)			●			●
Set of water leakage sensor (if applicable)			●			●
Repeater relay for water leak sensor (if applicable)			●			●
Water regulating valve (if applicable)			●			●
Motor for fan motor				●		
Rolling bearing (One piece for each bearing)	Bearing	▲	▲	▲	▲	▲
	Teflon seal	▲	▲	▲	▲	▲
	Internal bearing cap	●	●	●	●	●
	External bearing cap	●	●	●	●	●
	Grease valve	●	●	●	●	●
	Ring with labyrinth	●	●	●	●	●
	Cylindrical pressure spring	●	●	●	●	●
	Protective ring against water ingress	●	●	●	●	●
Sleeve bearing (One piece for each bearing)	Set of bearing shell	▲	▲	▲	▲	▲
	Floating labyrinth seal	▲	▲	▲	▲	▲
	Mechanical seal	▲	▲	▲	▲	▲
	Loose oil ring	●	●	●	●	●
	Oil regulating valve (if applicable)	●	●	●	●	●

The spare parts must be stored in a clean, dry and well-ventilated environment and, if possible, at constant temperature.

9 MAINTENANCE PLAN

The maintenance plan described in Table 9.1 is only referential, and the intervals between each maintenance intervention may vary according to the motor location and operating conditions.

For the associated equipment, such as the water supply unit or control and protection system, it is necessary to refer to their specific manuals.

Table 9.1: Maintenance plan

MOTOR PART	Weekly	Monthly	3 months	6 months	Annual	3 years	
STATOR							
Visual inspection of the stator.					x		
Cleanliness control.					x		
Inspection of the slot wedges.						x	
Verification of the fastening of the stator terminals.					x		
Measurement of the winding insulation resistance.					x		
ROTOR							
Visual inspection.					x		
Cleaning control.					x		
Inspection of the shaft (wear, incrustations).						x	
BEARINGS							
Control of noise, vibration, oil flow, leaks and temperature.	x						
Lubricant quality control.					x		
Inspection of the bearing shell and shaft journal (sleeve bearing).						x	
Lubricant change.							According to the period indicated on the bearing nameplate.
AIR-WATER HEAT EXCHANGER							
Inspection of the radiators					x		
Cleaning of the radiators					x		
Inspection of the radiator sacrificial anodes (if any).		x					Increase the inspection frequency in case of excessive corrosion.
Replacement of the gaskets of the radiator heads.					x		
AIR-AIR HEAT EXCHANGER							
Cleaning of the ventilation ducts.					x		
Inspection of the ventilation.					x		
AIR FILTER(S)							
Inspection, cleaning and replacement, if necessary.			x				
PROTECTION AND CONTROL EQUIPMENT							
Recording of the values.	x						
Operation test.					x		
Disassembly and operation test.						x	
COUPLING							
Inspection of the alignment.					x		Check after the first week of operation.
Inspection of the coupling fastening.					x		Check after the first week of operation.
WHOLE MOTOR							
Inspection of noise and vibration	x						
Drainage of condensed water.			x				
Retightening of the screws.					x		
Cleaning of the terminal boxes.					x		
Retightening of electrical and grounding connections.					x		

10 ABNORMALITIES, CAUSES AND SOLUTIONS



NOTE

The instructions of Table 10.1 present only a basic list of abnormalities, causes and corrective actions. In case of questions, consult WEG.

Table 10.1: Basic list of abnormalities, causes and corrective actions

ABNORMALITY	POSSIBLE CAUSES	CORRECTION
Neither coupled nor uncoupled does the motor start	▪ At least two power cables are interrupted, without voltage	▪ Check the control panel, the power cables, and the terminals
	▪ Rotor is locked	▪ Unlock the rotor
	▪ Bearing damaged	▪ Replace the bearing
Motor starts with no load, but fails when load is applied It starts very slowly and does not reach the rated speed	▪ Load torque is too high during the start	▪ Do not apply load to the driven machine during the start
	▪ Power supply voltage is too low	▪ Measure the power supply voltage, and set it to the correct value
	▪ Very high voltage drop in the power cables	▪ Check the sizing of the installation (transformer, cable section, relays, circuit breakers, etc.)
	▪ Rotor with faulty or interrupted bar	▪ Check and repair the rotor winding
	▪ A power cable was interrupted after the start	▪ Check the power cables
The stator current oscillates under load with double the slip frequency. Motor presents a humming noise during starting	▪ Rotor winding is interrupted	▪ Check and repair the rotor winding
Very high no load current	▪ Power supply voltage is too high	▪ Measure the power supply voltage and set it to the correct value
Hot spots in the stator winding	▪ Short-circuit between turns	▪ Rewind
	▪ Interruption of the parallel wires or phases of the stator winding	
	▪ Faulty connection	▪ Redo the connection
hot spots in the rotor	▪ Interruptions in the rotor winding	▪ Repair the rotor winding or replace it
Abnormal noise during operation with load	▪ Mechanical causes	▪ The noise normally decreases when the speed reduces, see also: "noisy operation when uncoupled"
	▪ Electrical causes	▪ The noise disappears when the motor is switched off. Consult WEG
When coupled, there is noise; when uncoupled, the noise disappears	▪ Defect in the coupling parts or in the driven machine	▪ Check the power transmission, the coupling and the alignment
	▪ Defect in the gear coupling	▪ Align the drive set
	▪ Unaligned/unleveled base	▪ Align/level the motor and the driven machine
	▪ Faulty balancing of the components or of the driven machine	▪ Perform new balancing
	▪ Defective coupling	▪ Repair or replace the coupling
	▪ Wrong rotation direction of the motor	▪ Invert the connection of two phases

ABNORMALITY	POSSIBLE CAUSES	CORRECTION
Stator winding becomes very hot under load	▪ Fans with inverted rotation direction	▪ Correct the rotation direction of the fans
	▪ Insufficient cooling due to dirty air channels	▪ Open and clean the air passage channels
	▪ Overload	▪ Measure the stator current; reduce the load. Analyze the motor application
	▪ High number of starts or moment of inertia too high	▪ Reduce the number of starts
	▪ Voltage too high, therefore, the iron losses increase	▪ Do not exceed 110% of the rated voltage, except when otherwise specified on the nameplate
	▪ Voltage too low, therefore, the current is very high	▪ Check the supply voltage and the voltage drop in the motor
	▪ Interruption in a power cable or in a winding phase	▪ Measure the current in all the phases and, if necessary, correct it
	▪ Rotor drags against the stator	▪ Check the air-gap, operating conditions (vibration etc.), bearing conditions
	▪ The operating condition does not correspond to the nameplate data	▪ Keep the operating condition according to the nameplate or reduce the load
	▪ Unbalance in the power supply (blown fuse, wrong command)	▪ Check if there is voltage unbalance or operation with two phases and correct it
	▪ Dirty windings	▪ Clean
	▪ Air ducts clogged	
	Noisy operation when uncoupled	▪ Dirty air filter
▪ Rotation direction is not compatible with the fan used		▪ Check the fan regarding to the motor rotation direction
▪ Unbalance		▪ Noise remains during deceleration after disconnecting the voltage
		▪ Perform new balancing
▪ Interruption in one phase of the stator winding		▪ Measure the current of all connecting cables
▪ Fastening screws are loose		▪ Retighten and lock the screws
▪ The rotor balancing conditions become worse after the assembly of the coupling		▪ Balance the coupling
▪ Resonance in the foundation		▪ Adjust the foundation
▪ Motor frame is deformed	▪ Check flatness of the base	
	▪ Bent shaft	▪ The shaft may be warped
	▪ Air-gap is not even	▪ Check the rotor balancing and eccentricity
		▪ Check the shaft warping or rolling bearing wear

11 DECLARATION OF CONFORMITY

EU Declaration of Conformity

**Manufacturers:**

WEG Equipamentos Elétricos S.A.
Av. Prefeito Waldemar Grubba, 3000
89256-900 - Jaraguá do Sul - SC - Brazil
www.weg.net

WEG Industrie (India) PVT. LTD.
Plot n° E-20 (North), SIPCOT Industrial Complex
Phase II - Expansion II.
Mornapalli Village, Hosur 635 109
Tamil Nadu - India
www.weg.net/in

WEG MEXICO, S.A. DE C.V
Carretera Jorobas - Tula Km 3.5, Manzana 5,
Lote 1, Fraccionamiento Parque Industrial Huehuetoca,
Municipio de Huehuetoca, C.P. 54680,
CD. de Mexico y Área Metropolitana - Mexico
www.weg.net/mx

WEG (Jiangsu) Electric Equipment CO., LTD.
No. 15 Group, North City Street, Dengyuan Community
Rugao City, Jiangsu Province - China
www.weg.net/cn

WEG (Nantong) Electric Motor Manufacturing CO., LTD.
No. 128# - Xinkai South Road, Nantong
Economic & Technical Development
Zone, Nantong, Jiangsu Province - China
www.weg.net/cn

WEGeuro - Industria Eléctrica S.A.
Rua Eng Frederico Ulrich, Apartado 6074
4476-908 - Maia - Porto - Portugal
www.weg.net/pt
Contact person: Luís Filipe Oliveira Silva Castro Araújo
Authorised Representative in the European Union
(Single Contact Point)

The manufacturer declares under sole responsibility that:

WEG synchronous and asynchronous motors, generators and their components used for following lines:

M..., W60, WGM, G... and S...

.....

when installed, maintained and used in applications for which they were designed, and in compliance with the relevant installation standards and manufacturer's instructions, comply with the provisions of the following relevant European Union harmonisation legislation, wherever applicable:

Low Voltage Directive 2006/95/EC* (valid until April 19th, 2016)

Low Voltage Directive 2014/35/EU* (valid from April 20th, 2016)

Machinery Directive 2006/42/EC**

EMC Directive 2014/30/EU (electric motors are considered inherently benign in terms of electromagnetic compatibility)

The fulfilment of the safety objectives of the relevant European Union harmonisation legislation has been demonstrated by compliance with the following standards, wherever applicable:

EN 60034-1:2010 + AC:2010/ EN 60034-5:2001 + A1:2007/ EN 60034-6:1993/

EN 60034-7:1993 + A1:2001/ EN 60034-8:2007 + A1: 2014/ EN 60034-9:2005 + A1:2007/ EN 60034-11:2004/

EN 60034-12:2002 + A1:2007/ EN 60034-14:2004 + A1:2007/

EN 60204-1:2006 + A1:2009 + AC:2010 and EN 60204-11:2000 + AC:2010

CE marking in: **1998**

* Electric motors designed for use with a voltage rating higher than 1000V are not considered under the scope.

** Low voltage electric motors are not considered under the scope and electric motors designed for use with a voltage rating higher than 1000V are considered partly completed machinery and are supplied with a

Declaration of Incorporation:

The products above cannot be put into service until the machinery into which they have been incorporated has been declared in conformity with the Machinery Directive.

A Technical Documentation for the products above is compiled in accordance with part B of annex VII of Machinery Directive 2006/42/EC.

We undertake to transmit, in response to a reasoned request by the national authorities, relevant information on the partly completed machinery identified above through WEG authorised representative established in the European Union. The method of transmission shall be electronic or physical method and shall be without prejudice to the intellectual property rights of the manufacturer.

Signed for and on behalf of the manufacturer:
Eduardo de Nobrega
Managing Director

Jaraguá do Sul, May 28th, 2016

DEC2816-Rev01 - English 1/1

12 ENVIRONMENTAL INFORMATION

12.1 PACKAGE

Electric motors are supplied in cardboard, polymer, wood or metallic material packages. These materials are recyclable or reusable and must be properly disposed according to the current regulations of each country. All the wood used in the packaging of WEG motors comes from reforestation and receives anti-fungal treatment.

12.2 PRODUCT

Electric motors, under the constructive aspect, are manufactured mainly with ferrous metals (steel, cast iron), nonferrous metals (copper, aluminum) and plastic. The electric motor, in general, is a product that has a long useful life; however, when it must be disposed, WEG recommends that the materials of the packaging and of the product be properly separated and sent for recycling. The non-recyclable materials must be properly disposed according to the environmental regulations, i.e., in industrial landfills, co-processed in cement kilns or incinerated. The service providers for recycling, disposal in industrial landfills, co-processing or incineration of waste must be properly licensed by the environmental agency of each state to carry out these activities.

12.3 HAZARDOUS WASTE

Grease and oil waste used to lubricate the bearings should be disposed, according to the instructions of the relevant environmental agencies, because its improper disposal can cause impacts to the environment.



Drives Motors Controls

13 WARRANTY TERM

These products, when operated under the conditions stipulated by WEG in the operating manual for such product, are warranted against defects in workmanship and materials for twelve (12) months from start-up date or eighteen (18) months from manufacturer shipment date, whichever occurs first.

However, this warranty does not apply to any product which has been subject to misuse, misapplication, neglect (including without limitation, inadequate maintenance, accident, improper installation, modification, adjustment, repair or any other cases originated from inadequate applications).

The company will neither be responsible for any expenses incurred in installation, removal from service, consequential expenses such as financial losses nor transportation costs as well as tickets and accommodation expenses of a technician when this is requested by the customer.

The repair and/or replacement of parts or components, when effected by WEG within the Warranty period do not give Warranty extension, unless otherwise expressed in writing by WEG.

This constitutes WEG's only warranty in connection with this sale and is in lieu of all other warranties, expressed or implied, written or oral.

There are no implied warranties of merchantability or fitness for a particular purpose that apply to this sale.

No employee, agent, dealer, repair shop or other person is authorized to give any warranties on behalf of WEG nor to assume for WEG any other liability in connection with any of its products.

In case this happens without WEG's authorization, Warranty is automatically cancelled.

LIABILITY

Except as specified in the foregoing paragraph entitled "**Warranty Terms for Engineering Products**", the company shall have no obligation or liability whatsoever to the purchaser, including, without limitation, any claims for consequential damages or labor costs, by reason of any breach of the express warranty described therein.

The purchaser further hereby agrees to indemnify and hold the company harmless from any causes of action (other than cost of replacing or repairing the defective product as specified in the foregoing paragraph entitled "**Warranty Terms for Engineering Products**"), arising directly or indirectly from the acts, omissions or negligence of the purchaser in connection with or arising out of the testing, use, operation, replacement or repair of any product described in this quotation and sold or furnished by the company to the purchaser.

Drives Motors Controls



WEG Group - Energy Business Unit
Jaraguá do Sul - SC - Brazil
Phone: 55 (47) 3276-4000
energia@weg.net
www.weg.net

NOTES

DMC

Drives Motors Controls

DMC

Drives Motors Controls

ARGENTINA

WEG EQUIPAMIENTOS ELECTRICOS S.A.
Sgo. Pampiglione 4849
Parque Industrial San Francisco
2400 - San Francisco
Phone: +54 (3564) 421484
www.weg.net/ar

AUSTRALIA

WEG AUSTRALIA PTY. LTD.
14 Lakeview Drive, Scoresby 3179,
Victoria
Phone: +03 9765 4600
www.weg.net/au

AUSTRIA

WATT DRIVE ANTRIEBSTECHNIK GMBH *
Wöllersdorfer Straße 68
2753, Markt Piesting
Phone: + 43 2633 4040
www.wattdrive.com

LENZE ANTRIEBSTECHNIK GES.M.B.H. *

lpf - Landesstrasse 1
A-4481 Asten
Phone: +43 (0) 7224 / 210-0
www.lenze.at

BELGIUM

WEG BENELUX S.A.*
Rue de l'Industrie 30 D,
1400 Nivelles
Phone: +32 67 888420
www.weg.net/be

BRAZIL

WEG EQUIPAMENTOS ELÉTRICOS S.A.
Av. Pref. Waldemar Grubba, 3000,
CEP 89256-900 Jaraguá do Sul - SC
Phone: +55 47 3276-4000
www.weg.net/br

CHILE

WEG CHILE S.A.
Los Canteros 8600,
La Reina - Santiago
Phone: +56 2 2784 8900
www.weg.net/cl

CHINA

WEG (NANTONG) ELECTRIC MOTOR
MANUFACTURING CO. LTD.
No. 128# - Xinkai South Road, Nantong
Economic & Technical Development Zone,
Nantong, Jiangsu Province
Phone: +86 513 8598 9383
www.weg.net/cn

COLOMBIA

WEG COLOMBIA LTDA
Calle 46A N82 - 54
Portería II - Bodega 6 y 7
San Cayetano II - Bogotá
Phone: +57 1 416 0166
www.weg.net/co

DENMARK

WEG SCANDINAVIA DENMARK *
Sales Office of WEG Scandinavia AB
Verkstadgatan 9 - 434 22 Kumgsbacka,
Sweden
Phone: +46 300 73400
www.weg.net/se

FRANCE

WEG FRANCE SAS *
ZI de Chenes - Le Loup13 / 38297 Saint
Quentin Fallavier,
Rue du Mo-reillon - BP 738/
Rhône Alpes, 38 > Isère
Phone: + 33 47499 1135
www.weg.net/fr

GREECE

MANGRINOX*
14, Grevenon St.
GR 11855 - Athens, Greece
Phone: + 30 210 3423201-3
www.weg.net/gr

GERMANY

WEG GERMANY GmbH*
Industriegebiet Türnich 3 Geigerstraße 7
50169 Kerpen-Türnich
Phone: + 49 2237 92910
www.weg.net/de

GHANA

ZEST ELECTRIC MOTORS (PTY) LTD.
15, Third Close Street Airport Residential Area,
Accra
Phone: +233 3027 66490
www.zestghana.com.gh

HUNGARY

AGISYS AGITATORS & TRANSMISSIONS
LTD.*
Tó str. 2. Torokbalint, H-2045 Phone: + 36
(23) 501 150
www.agisys.hu

INDIA

WEG ELECTRIC (INDIA) PVT. LTD.
#38, Ground Floor, 1st Main Road,
Lower Palace, Orchards,
Bangalore, 560 003
Phone: +91 804128 2007
www.weg.net/in

ITALY

WEG ITALIA S.R.L.*
Via Viganò de Vizzi, 93/95
20092 Cinisello Balsamo, Milano Phone: + 39
2 6129 3535
www.weg.net/it

FERRARI S.R.L.*

Via Cremona 25 26015
Soresina (CR), Cremona
Phone: + 39 (374) 340-404
www.ferrarisrl.it

STIAVELLI IRIO S.P.A.*

Via Pantano - Blocco 16 - Capalle 50010 ,
Campi Bisenzio (FI)
Phone: + 39 (55) 898.448
www.stiavelli.com

JAPAN

WEG ELECTRIC MOTORS JAPAN CO., LTD.
Yokohama Sky Building 20F, 2-19-12
Takashima, Nishi-ku, Yokohama City,
Kanagawa, Japan 220-0011
Phone: + 81 45 5503030
www.weg.net/jp

MEXICO

WEG MEXICO. S.A. DE C.V.
Carretera Jorobas-Tula
Km. 3.5, Manzana 5, Lote 1 Fraccionamiento
Parque Industrial
Huehuetoca
Estado de México - C.P. 54680
Phone: +52 55 53214275
www.weg.net/mx

NETHERLANDS

WEG NETHERLANDS *
Sales Office of WEG Benelux S.A. Hanzepoort
23C, 7575 DB Oldenzaal
Phone: +31 541 571090
www.weg.net/nl

PORTUGAL

WEG EURO - INDÚSTRIA ELÉCTRICA. S.A.*
Rua Eng. Frederico Ulrich,
Sector V, 4470-605 Maia,
Apartado 6074, 4471-908 Maia, Porto
Phone: +351 229 477 705
www.weg.net/pt

RUSSIA

WEG ELECTRIC CIS LTD.*
Russia, 194292, St. Petersburg, Pro-spekt
Kulury 44, Office 419
Phone: +7 812 3632172
www.weg.net/ru

SOUTH AFRICA

ZEST ELECTRIC MOTORS (PTY) LTD.
47 Galaxy Avenue, Linbro Business
Park Gauteng Private Bag X10011
Sandton, 2146, Johannesburg
Phone: +27 11 7236000
www.zest.co.za

SPAIN

WEG IBERIA INDUSTRIAL S.L.*
C/ Tierra de Barros, 5-7
28823 Coslada, Madrid
Phone: +34 91 6553008
www.weg.net/es

SINGAPORE

WEG SINGAPORE PTE LTD
159, Kampong Ampat, #06-02A KA PLACE.
368328
Phone: +65 68581081
www.weg.net/sg

SWEDEN

WEG SCANDINAVIA AB *
Box 27, 435 21 Mölnlycke
Visit: Designvägen 5, 435 33
Mölnlycke, Göteborg
Phone: +46 31 888000
www.weg.net/se

SWITZERLAND

BIBUS AG *
Allmendstrasse 26, 8320 - Fehraltorf
Phone: + 41 44 877 58 11
www.bibus-holding.ch

UNITED ARAB EMIRATES

The Galleries, Block No. 3, 8th Floor,
Office No. 801 - Downtown Jebel Ali
262508, Dubai
Phone: +971 (4) 8130800
www.weg.net/ae

UNITED KINGDOM

WEG ELECTRIC MOTORS (U.K.) LTD.*
Broad Ground Road - Lakeside Redditch,
Worcestershire B98 8YP
Phone: + 44 1527 513800
www.weg.net/uk

ERIKS *

Amber Way, B62 8WG Halesowen
West Midlands
Phone: + 44 (0)121 508 6000

BRAMMER GROUP *

PLC43-45 Broad St, Teddington
TW11 8QZ
Phone: + 44 20 8614 1040

USA

WEG ELECTRIC CORP.
6655 Sugarloaf Parkway, Duluth, GA 30097
Phone: +1 678 2492000
www.weg.net/us

VENEZUELA

WEG INDUSTRIAS VENEZUELA C.A.
Centro corporativo La Viña Plaza,
Cruce de la Avenida Carabobo con la calle
Uzlar de la Urbanización La Viña / Jurisdicción
de la Parroquia San José - Valencia
Oficinas 06-16 y 6-17, de la planta tipo 2, Nivel
5, Carabobo
Phone: (58) 241 8210582
www.weg.net/ve

* European Union Importers

