

YASKAWA AC Drive-V1000

Compact Vector Control Drive

Technical Manual

Type: CIMR-VU

Models: 200 V Class, Three-Phase Input: 0.1 to 18.5 kW
200 V Class, Single-Phase Input: 0.1 to 3.7 kW
400 V Class, Three-Phase Input: 0.2 to 18.5 kW

To properly use the product, read this manual thoroughly and retain for easy reference, inspection, and maintenance. Ensure the end user receives this manual.

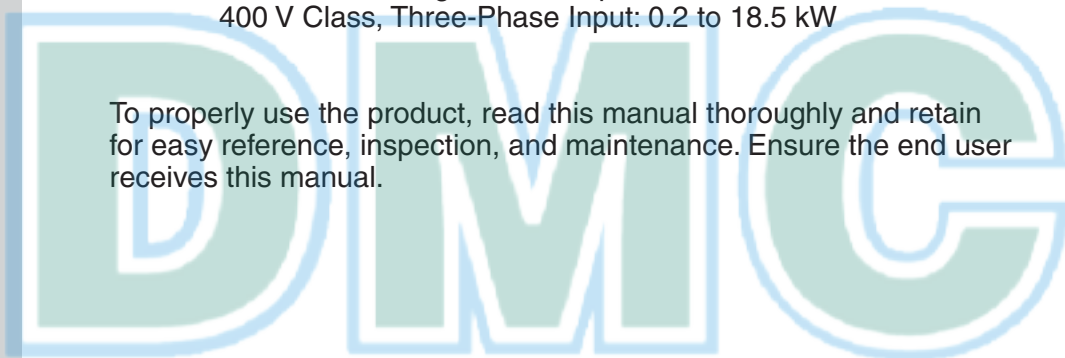

Drives Motors Controls

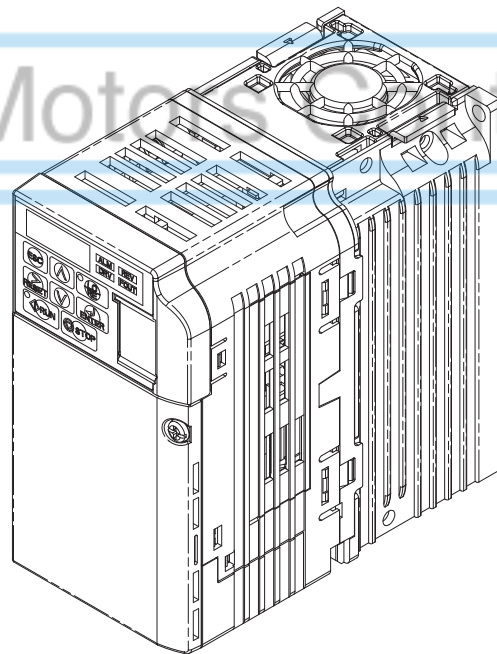

Receiving

1

Mechanical Installation

2

Electrical Installation

3

Start-Up Programming & Operation

4

Parameter Details

5

Troubleshooting

6

Periodic Inspection & Maintenance

7

Peripheral Devices & Options

8

Specifications

A

Parameter List

B

MEMOBUS/Modbus Communications

C

Standards Compliance

D

Quick Reference Sheet

E

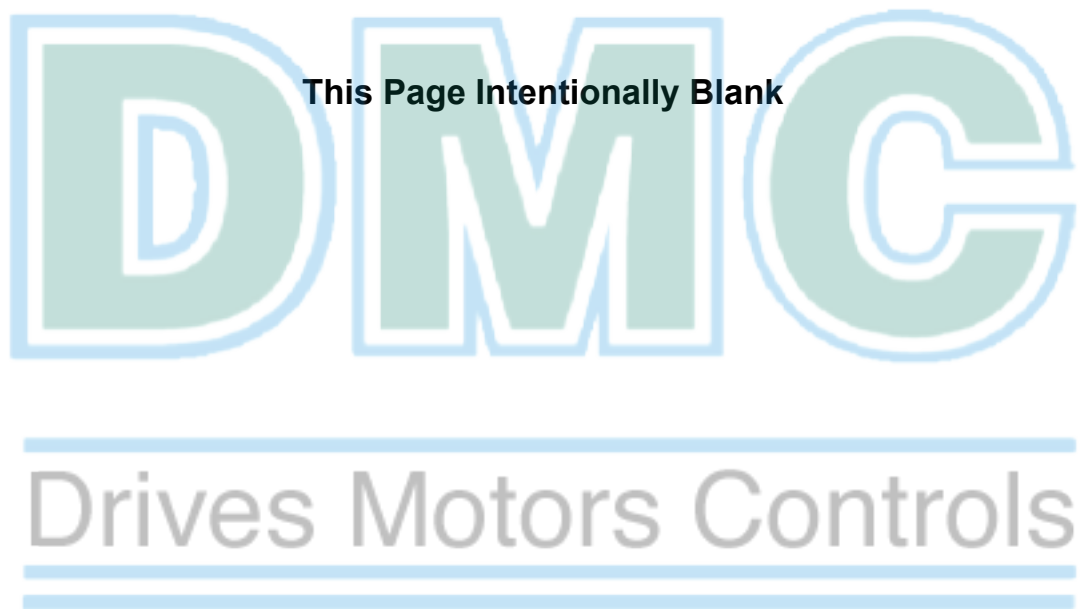

Copyright © 2008 YASKAWA ELECTRIC CORPORATION. All rights reserved.

All rights reserved. No part of this publication may be reproduced, stored in a retrieval system, or transmitted, in any form or by any means, mechanical, electronic, photocopying, recording, or otherwise, without the prior written permission of Yaskawa. No patent liability is assumed with respect to the use of the information contained herein. Moreover, because Yaskawa is constantly striving to improve its high-quality products, the information contained in this manual is subject to change without notice. Every precaution has been taken in the preparation of this manual. Yaskawa assumes no responsibility for errors or omissions. Neither is any liability assumed for damages resulting from the use of the information contained in this publication.

Table of Contents

i. PREFACE & GENERAL SAFETY	11
i.1 Preface	12
Applicable Documentation.....	12
Symbols.....	12
Terms and Abbreviations	12
i.2 General Safety	13
Supplemental Safety Information	13
Safety Messages.....	13
Drive Label Warnings.....	15
Warranty Information.....	16
Quick Reference.....	16
i.3 Application Precautions	18
General Application Precautions	18
Installation Environment.....	19
Settings	19
General Handling	19
Notes on Motor Operation	20
1. RECEIVING	23
1.1 Section Safety	24
1.2 Model Number and Nameplate Check	25
Nameplate	25
1.3 Drive Models and Enclosure Types	27
1.4 Component Names	28
IP20/Open-Chassis	28
IP00/Open-Chassis	30
IP20/NEMA Type 1 Enclosure.....	31
Front Views	34
2. MECHANICAL INSTALLATION	35
2.1 Section Safety	36
2.2 Mechanical Installation	38
Installation Environment.....	38
Installation Orientation and Spacing.....	38
Removing and Attaching the Protective Covers.....	40
Exterior and Mounting Dimensions	40
3. ELECTRICAL INSTALLATION	47

3.1	Section Safety	48
3.2	Standard Connection Diagram	50
3.3	Main Circuit Connection Diagram	53
	Single-Phase 200 V Class Models BA0001 to BA0018	53
	Three-Phase 200 V Class Models 2A0001 to 2A0069	
	Three-Phase 400 V Class Models 4A0001 to 4A0038	53
3.4	Terminal Block Configuration	54
3.5	Protective Covers	55
	IP20/Open-Chassis Front and Bottom Cover Removal and Installation	55
	IP20/NEMA Type 1 Front and Bottom Cover Removal and Installation	56
	IP20/NEMA Type 1 Top Cover Removal and Installation	57
3.6	Main Circuit Wiring	58
	Main Circuit Terminal Functions	58
	Wire Gauges and Tightening Torques	58
	Main Circuit Terminal Power Supply and Motor Wiring	61
3.7	Control Circuit Wiring	63
	Control Circuit Terminal Block Functions	64
	Terminal Configuration	65
	Wiring Procedure.....	66
3.8	I/O Connections	68
	Sinking/Sourcing Mode Switch	68
3.9	Main Frequency Reference	70
	DIP Switch S1 Analog Input Signal Selection	70
3.10	MEMOBUS/Modbus Termination	71
3.11	Braking Resistor	72
	Installation	72
3.12	Wiring Checklist	74
4.	START-UP PROGRAMMING & OPERATION	77
4.1	Section Safety	78
4.2	Using the Digital LED Operator	80
	Keys, Displays, and LEDs	80
	Digital Text Display.....	81
	LED Screen Displays	82
	LO/RE LED and RUN LED Indications.....	82
	Menu Structure for Digital LED Operator	83
4.3	The Drive and Programming Modes	84
	Navigating the Drive and Programming Modes.....	85
	Changing Parameter Settings or Values	88
	Verifying Parameter Changes: Verify Menu	88
	Switching Between LOCAL and REMOTE.....	88
	Parameters Available in the Setup Group.....	89
4.4	Start-up Flowcharts	90
	Flowchart A: Basic Start-up and Motor Tuning.....	91
	Subchart A1: Simple Motor Setup with Energy Savings or Speed Search Using V/f Mode.....	92
	Subchart A2: High Performance Operation Using Open Loop Vector Motor Control.....	93
	Subchart A3: Operation with Permanent Magnet Motors.....	94
4.5	Powering Up the Drive	95

Powering Up the Drive and Operation Status Display.....	95
4.6 Application Selection.....	96
Setting 1: Water Supply Pump Application.....	96
Setting 2: Conveyor Application.....	97
Setting 3: Exhaust Fan Application.....	97
Setting 4: HVAC Fan Application.....	97
Setting 5: Compressor Application.....	98
Setting 6: Preset 6.....	98
Notes on Controlling the Brake when Using Application Preset 6.....	99
Setting 7: Preset 7.....	100
Setting 8: Conveyor Application 2.....	101
4.7 Auto-Tuning.....	102
Types of Auto-Tuning.....	102
Before Auto-Tuning the Drive.....	102
Auto-Tuning Interruption and Fault Codes.....	103
Performing Auto-Tuning.....	103
Auto-Tuning Example.....	105
Input Data for Auto-Tuning.....	106
4.8 No-Load Operation Test Run.....	108
No-Load Operation Test Run.....	108
4.9 Test Run with Load Connected.....	109
Test Run with the Load Connected.....	109
4.10 Verifying Parameter Settings and Backing Up Changes.....	110
Backing Up Parameter Values: o2-03.....	110
Parameter Access Level: A1-01.....	110
Password Settings: A1-04, A1-05.....	110
Copy Function (Optional).....	111
4.11 Test Run Checklist.....	112
5. PARAMETER DETAILS.....	115
5.1 A: Initialization.....	116
A1: Initialization.....	116
A2: User Parameters.....	120
5.2 b: Application.....	121
b1: Mode of Operation.....	121
b2: DC Injection Braking.....	128
b3: Speed Search.....	130
b4: Delay Timers.....	135
b5: PID Control.....	136
b6: Dwell Function.....	144
b8: Energy Saving.....	145
5.3 C: Tuning.....	147
C1: Acceleration and Deceleration Times.....	147
C2: S-Curve Characteristics.....	150
C3: Slip Compensation.....	151
C4: Torque Compensation.....	152
C5: Automatic Speed Regulator (ASR).....	154
C6: Carrier Frequency.....	155
5.4 d: Reference Settings.....	159

Table of Contents

d1: Frequency Reference	160
d2: Frequency Upper/Lower Limits	161
d3: Jump Frequency	162
d4: Frequency Hold and Up/Down 2 Function	162
d7: Offset Frequencies	167
5.5 E: Motor Parameters	169
E1: V/f Characteristics	169
E2: Motor 1 Parameters	173
E3: V/f Characteristics for Motor 2	175
E4: Motor 2 Parameters	176
E5: PM Motor Settings	178
5.6 F: Option Settings	181
F1: Error Detection for V/f Control with PG	181
F6: Serial Communications Option Card Settings	182
MECHATROLINK-II Parameters	183
MECHATROLINK-III Parameters	183
PROFIBUS-DP Parameters	183
DeviceNet Parameters	183
F7-01 to F7-42: EtherNet/IP and Modbus TCP/IP Option Parameters	183
5.7 H: Terminal Functions	184
H1: Multi-Function Digital Inputs	184
H2: Multi-Function Output	195
H3: Multi-Function Analog Input Terminals	204
H4: Multi-Function Analog Output Terminals	210
H5: MEMOBUS/Modbus Serial Communication	210
H6: Pulse Train Input/Output	211
5.8 L: Protection Functions	213
L1: Motor Protection Functions	213
L2: Momentary Power Loss Ride-Thru	218
L3: Stall Prevention	221
L4: Speed Agree/Frequency Reference Loss Detection	227
L5: Fault Restart	230
L6: Torque Detection	231
L7: Torque Limit	234
L8: Hardware Protection	234
5.9 n: Special Adjustments	240
n1: Hunting Prevention	240
n2: Automatic Frequency Regulator (AFR) Tuning	240
n3: High Slip Braking (HSB)/Overexcitation Deceleration	241
n6: Motor Line-to-Line Resistance Online Tuning	243
n8: PM Motor Control	243
5.10 o: Operator Related Settings	247
o1: Display Settings and Selections	247
o2: Operator Key Selections	248
o3: Copy Function	250
o4: Maintenance Monitor Settings	251
q: DriveWorksEZ Parameters	252
r: DriveWorksEZ Connection Parameters	253
T: Motor Tuning	253
5.11 U: Monitor Parameters	254

U1: Operation Status Monitors	254
U2: Fault Trace.....	254
U3: Fault History.....	254
U4: Maintenance Monitors	254
U5: PID Monitors	254
U6: Control Monitors	254
U8: DriveWorksEZ Monitors.....	255
6. TROUBLESHOOTING.....	257
6.1 Section Safety.....	258
6.2 Motor Performance Fine Tuning	260
V/f Motor Control Method Tuning	260
Open Loop Vector (OLV) Motor Control Method Tuning.....	261
Motor Hunting and Oscillation Control Parameters	262
6.3 Drive Alarms, Faults, and Errors	263
Types of Alarms, Faults, and Errors	263
Alarm and Error Displays	264
6.4 Fault Detection	267
Fault Displays, Causes, and Possible Solutions	267
6.5 Alarm Detection	282
Alarm Codes, Causes, and Possible Solutions	282
6.6 Operator Programming Errors	291
oPE Codes, Causes, and Possible Solutions.....	291
6.7 Auto-Tuning Fault Detection	295
Auto-Tuning Codes, Causes, and Possible Solutions.....	295
6.8 Diagnosing and Resetting Faults.....	298
Fault Occurs Simultaneously with Power Loss	298
If the Drive Still has Power After a Fault Occurs	298
Viewing Fault Trace Data After Fault	298
Fault Reset Methods	298
6.9 Troubleshooting without Fault Display.....	300
Cannot Change Parameter Settings	300
Motor Does Not Rotate Properly after Pressing RUN Button or after Entering External Run Command	300
7. PERIODIC INSPECTION & MAINTENANCE	309
7.1 Section Safety.....	310
7.2 Inspection	312
Recommended Daily Inspection.....	312
Recommended Periodic Inspection.....	313
7.3 Periodic Maintenance	314
Replacement Parts.....	314
7.4 Drive Cooling Fans.....	316
Number of Cooling Fans	316
Cooling Fan Replacement.....	317
7.5 Drive Replacement	319
Serviceable Parts	319
Terminal Board Overview.....	319

Dismantling the Removable Terminal Block.....	319
Details on Terminal Board (TB) or Control Board (CNT) Replacement	322
8. PERIPHERAL DEVICES & OPTIONS	325
8.1 Section Safety.....	326
8.2 Drive Options and Peripheral Devices	327
8.3 Connecting Peripheral Devices	329
8.4 Installing Peripheral Devices	330
Installing a Molded Case Circuit Breaker (MCCB) and Earth Leakage Circuit Breaker (ELCB)	330
Installing a Leakage Breaker	330
Installing a Magnetic Contactor	331
Connecting an AC Reactor or DC Link Choke	331
Connecting a Surge Suppressor	332
Connecting a Noise Filter	332
EMC Filter Installation	334
Zero-Phase Reactor	334
Installing Fuses on the Input Side	335
Attachment for External Heatsink	335
Noise Filter Installation	335
Installing a Motor Thermal Overload (oL) Relay on the Drive Output	335
8.5 Communication Options.....	337
8.6 Connecting an Option Card.....	338
Verifying the Option Card and Product Type.....	338
Connecting the Option Card.....	338
A. SPECIFICATIONS	341
A.1 Heavy Duty and Normal Duty Ratings	342
A.2 Single/Three-Phase 200 V Class Drives	343
A.3 Three-Phase 400 V Class Drives	345
A.4 Drive Specifications	347
A.5 Drive Watt Loss Data	350
A.6 Drive Derating Data	351
Carrier Frequency Derating	351
Temperature Derating	351
Altitude Derating	352
B. PARAMETER LIST.....	353
B.1 Parameter Groups	354
B.2 Parameter Table	355
A: Initialization Parameters.....	355
b: Application.....	356
C: Tuning.....	361
d: References	364
E: Motor Parameters	367
F: Options.....	371
H Parameters: Multi-Function Terminals.....	376
L: Protection Function	384
n: Advanced Performance Set-Up.....	391
o: Operator Related Parameters	394

q: DriveWorksEZ Parameters.....	396
r: DriveWorksEZ Connection Parameters	396
T: Motor Tuning.....	398
U: Monitors	399
B.3 Control Mode Dependent Parameter Default Values	406
A1-02 (Motor 1 Control Mode) Dependent Parameters	406
E3-01 (Motor 2 Control Mode) Dependent Parameters	407
B.4 V/f Pattern Default Values.....	408
B.5 Defaults by Drive Model and Duty Rating (ND/HD)	409
B.6 Parameters that Change with the Motor Code Selection	417
Yaskawa SMRA Series SPM Motor	417
SS5 Motor: Yaskawa SSR1 Series IPM Motor.....	418
C. MEMOBUS/MODBUS COMMUNICATIONS.....	431
C.1 Section Safety.....	432
C.2 MEMOBUS/Modbus Configuration	433
C.3 Communication Specifications.....	434
C.4 Connecting to a Network	435
Network Cable Connection.....	435
Wiring Diagram for Multiple Connections	436
Network Termination	438
C.5 MEMOBUS/Modbus Setup Parameters	439
MEMOBUS/Modbus Serial Communication.....	439
C.6 Drive Operations by MEMOBUS/Modbus.....	442
Observing the Drive Operation.....	442
Controlling the Drive.....	442
C.7 Communications Timing.....	443
Command Messages from Master to Drive.....	443
Response Messages from Drive to Master	443
C.8 Message Format	444
Message Content	444
Slave Address	444
Function Code.....	444
Data.....	444
Error Check	444
C.9 Message Examples	446
Reading Drive MEMOBUS/Modbus Register Contents	446
Loopback Test.....	446
Writing to Multiple Registers.....	447
C.10 MEMOBUS/Modbus Data Table.....	448
Command Data	448
Monitor Data.....	449
Broadcast Messages.....	457
Fault Trace Contents.....	457
Alarm Register Contents	458
C.11 Enter Command.....	459
Enter Command Types	459
Enter Command Settings when Upgrading the Drive.....	459

C.12 Communication Errors	460
MEMOBUS/Modbus Error Codes.....	460
Slave Not Responding.....	460
C.13 Self-Diagnostics	461
D. STANDARDS COMPLIANCE	463
D.1 Section Safety.....	464
D.2 European Standards	466
CE Low Voltage Directive Compliance.....	466
EMC Guidelines Compliance	469
D.3 UL and CSA Standards	474
UL Standards Compliance	474
CSA Standards Compliance.....	479
Drive Motor Overload Protection	479
D.4 Safe Disable Input	481
Specifications	481
Precautions	482
Using the Safe Disable Function	483
E. QUICK REFERENCE SHEET	485
E.1 Drive and Motor Specifications.....	486
Drive	486
Motor	486
E.2 Basic Parameter Settings	487
Basic Setup	487
V/f Pattern Setup	487
Motor Setup.....	487
Multi-Function Digital Outputs (SC Common)	487
Pulse Train Input/Analog Inputs (AC Common)	488
Multi-Function Digital Outputs (MC Common).....	488
Multi-Function Photocoupler Outputs (PC Common).....	488
Monitor Outputs (AC Common).....	488
E.3 User Setting Table.....	489
INDEX	495

Preface & General Safety

This section provides safety messages pertinent to this product that, if not heeded, may result in fatality, personal injury, or equipment damage. Yaskawa is not responsible for the consequences of ignoring these instructions.

i.1	PREFACE	12
i.2	GENERAL SAFETY	13
i.3	APPLICATION PRECAUTIONS	18



Drives Motors Controls

i.1 Preface

Yaskawa manufactures products used as components in a wide variety of industrial systems and equipment. The selection and application of Yaskawa products remain the responsibility of the equipment manufacturer or end user. Yaskawa accepts no responsibility for the way its products are incorporated into the final system design. Under no circumstances should any Yaskawa product be incorporated into any product or design as the exclusive or sole safety control. Without exception, all controls should be designed to detect faults dynamically and fail safely under all circumstances. All systems or equipment designed to incorporate a product manufactured by Yaskawa must be supplied to the end user with appropriate warnings and instructions as to the safe use and operation of that part. Any warnings provided by Yaskawa must be promptly provided to the end user. Yaskawa offers an express warranty only as to the quality of its products in conforming to standards and specifications published in the Yaskawa manual. **NO OTHER WARRANTY, EXPRESS OR IMPLIED, IS OFFERED.** Yaskawa assumes no liability for any personal injury, property damage, losses, or claims arising from misapplication of its products.

◆ Applicable Documentation

The following manuals are available for V1000 series drives:

	V1000 Series AC Drive Quick Start Guide
	Read this manual first. This guide is packaged together with the product. It contains basic information required to install and wire the drive. This guide provides basic programming and simple setup and adjustment.
	V1000 Series AC Drive Technical Manual
	This manual describes installation, wiring, operation procedures, functions, troubleshooting, maintenance, and inspections to perform before operation.

◆ Symbols

Note: Indicates a supplement or precaution that does not cause drive damage.



Indicates a term or definition used in this manual.

◆ Terms and Abbreviations



- **Drive:** Yaskawa V1000 Series Drive
- **PM motor:** Permanent Magnet Synchronous Motor (an abbreviation for IPM motor or SPM motor)
- **IPM motor:** Interior Permanent Magnet Motor (e.g., Yaskawa SSR1 Series motor)
- **SPM motor:** Surface Mounted Permanent Magnet Motor (e.g., Yaskawa SMRA Series SPM motor)
- **PG:** Pulse Generator
- **r/min:** Revolutions per Minute
- **V/f:** V/f Control
- **OLV:** Open Loop Vector Control
- **OLV/PM:** Open Loop Vector Control for PM

i.2 General Safety

◆ Supplemental Safety Information

General Precautions

- The diagrams in this manual may be indicated without covers or safety shields to show details. Restore covers or shields before operating the drive and run the drive according to the instructions described in this manual.
- Any illustrations, photographs, or examples used in this manual are provided as examples only and may not apply to all products to which this manual is applicable.
- The products and specifications described in this manual or the content and presentation of the manual may be changed without notice to improve the product and/or the manual.
- When ordering a new copy of the manual due to damage or loss, contact your Yaskawa representative or the nearest Yaskawa sales office and provide the manual number shown on the front cover.
- If nameplate becomes worn or damaged, order a replacement from your Yaskawa representative or the nearest Yaskawa sales office.

⚠ WARNING

Read and understand this manual before installing, operating or servicing this drive. The drive must be installed according to this manual and local codes.

The following conventions are used to indicate safety messages in this manual. Failure to heed these messages could result in serious or possibly even fatal injury or damage to the products or to related equipment and systems.

⚠ DANGER

Indicates a hazardous situation, which, if not avoided, will result in death or serious injury.

⚠ WARNING

Indicates a hazardous situation, which, if not avoided, could result in death or serious injury.

WARNING! will also be indicated by a bold key word embedded in the text followed by an italicized safety message.

⚠ CAUTION

Indicates a hazardous situation, which, if not avoided, could result in minor or moderate injury.

CAUTION! will also be indicated by a bold key word embedded in the text followed by an italicized safety message.

NOTICE

Indicates a property damage message.

NOTICE: will also be indicated by a bold key word embedded in the text followed by an italicized safety message.

◆ Safety Messages

⚠ DANGER

Heed the safety messages in this manual.

Failure to comply will result in death or serious injury.

The operating company is responsible for any injuries or equipment damage resulting from failure to heed the warnings in this manual.

⚠ DANGER

Electrical Shock Hazard

Do not connect or disconnect wiring while the power is on.

Failure to comply will result in death or serious injury.

Before servicing, disconnect all power to the equipment. The internal capacitor remains charged even after the power supply is turned off. The charge indicator LED will extinguish when the DC bus voltage is below 50 Vdc. To prevent electric shock, wait at least five minutes after all indicators are OFF and measure the DC bus voltage level to confirm safe level.

⚠ WARNING

Sudden Movement Hazard

System may start unexpectedly upon application of power, resulting in death or serious injury.

Clear all personnel from the drive, motor and machine area before applying power. Secure covers, couplings, shaft keys and machine loads before applying power to the drive.

When using DriveWorksEZ to create custom programming, the drive I/O terminal functions change from factory settings and the drive will not perform as outlined in this manual.

Unpredictable equipment operation may result in death or serious injury.

Take special note of custom I/O programming in the drive before attempting to operate equipment.

Electrical Shock Hazard

Do not attempt to modify or alter the drive in any way not explained in this manual.

Failure to comply could result in death or serious injury.

Yaskawa is not responsible for any modification of the product made by the user. This product must not be modified.

Do not allow unqualified personnel to use equipment.

Failure to comply could result in death or serious injury.

Maintenance, inspection, and replacement of parts must be performed only by authorized personnel familiar with installation, adjustment and maintenance of AC drives.

Do not remove covers or touch circuit boards while the power is on.

Failure to comply could result in death or serious injury.

Fire Hazard

Do not use an improper voltage source.

Failure to comply could result in death or serious injury by fire.

Verify that the rated voltage of the drive matches the voltage of the incoming power supply before applying power.

Crush Hazard

Do not use this drive in lifting applications without installing external safety circuitry to prevent accidental dropping of the load.

The drive does not possess built-in load drop protection for lifting applications.

Failure to comply could result in death or serious injury from falling loads.

Install electrical and/or mechanical safety circuit mechanisms independent of drive circuitry.

⚠ CAUTION

Crush Hazard

Do not carry the drive by the front cover.

Failure to comply may result in minor or moderate injury from the main body of the drive falling.

NOTICE

Observe proper electrostatic discharge procedures (ESD) when handling the drive and circuit boards.

Failure to comply may result in ESD damage to the drive circuitry.

Never connect or disconnect the motor from the drive while the drive is outputting voltage.

Improper equipment sequencing could result in damage to the drive.

Do not perform a withstand voltage test on any part of the drive.

Failure to comply could result in damage to the sensitive devices within the drive.

Do not operate damaged equipment.

Failure to comply could result in further damage to the equipment.

Do not connect or operate any equipment with visible damage or missing parts.

Install adequate branch circuit short circuit protection per applicable codes.

Failure to comply could result in damage to the drive.

The drive is suitable for circuits capable of delivering not more than 31,000 RMS symmetrical Amperes, 240 Vac maximum (200 V Class) and 480 Vac maximum (400 V Class).

Do not expose the drive to halogen group disinfectants.

Failure to comply may cause damage to the electrical components in the drive.

Do not pack the drive in wooden materials that have been fumigated or sterilized.

Do not sterilize the entire package after the product is packed.

◆ Drive Label Warnings

Always heed the warning information listed in [Figure i.1](#) in the position shown in [Figure i.2](#).

 **WARNING** Risk of electric shock.





-  Read manual before installing.
-  Wait 5 minutes for capacitor discharge after disconnecting power supply.
-  To conform to  requirements, make sure to ground the supply neutral for 400V class.

Figure i.1 Warning Information

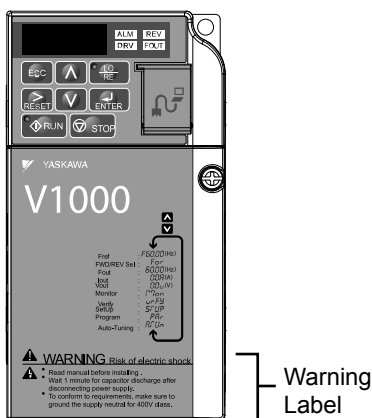

Figure i.2 Warning Information Position

◆ **Warranty Information**

■ **Restrictions**

The drive was not designed or manufactured for use in devices or systems that may directly affect or threaten human lives or health.

Customers who intend to use the product described in this manual for devices or systems relating to transportation, health care, space aviation, atomic power, electric power, or in underwater applications must first contact their Yaskawa representatives or the nearest Yaskawa sales office.

This product has been manufactured under strict quality-control guidelines. However, if this product is to be installed in any location where failure of this product could involve or result in a life-and-death situation or loss of human life or in a facility where failure may cause a serious accident or physical injury, safety devices must be installed to minimize the likelihood of any accident.

◆ **Quick Reference**

Easily Set Application-Specific Parameters	
<p>Preset parameter defaults are available for many applications. <i>Refer to Application Selection on page 96.</i></p>	

Run a Motor of One-Frame Larger Capacity
<p>When using this drive for variable torque loads such as fans and pumps, a motor one frame size larger can be used. <i>Refer to C6-01: Drive Duty Selection on page 155</i></p>

Know the Details of Safety Measures
<p>The functions listed below affect the safe operation of the drive. Ensure that the settings fit the application requirements prior to operation.</p>
<p>Operation of digital outputs during Auto-tuning. Rotational Auto-tuning allows for normal digital output operation. Non-rotational Auto-tuning does not allow for normal digital output operation.</p>
<p>Safe operations. Run by power on. Parameter setting b1-17.</p>
<p>LOCAL/REMOTE key effective during stop in drive mode. Parameter o2-01.</p>
<p>LED operator stop key priority selection. Parameter o2-02.</p>
<p>Enter press required after changing the keypad frequency reference. Parameter o2-05.</p>
<p>Operation interlock when program mode is selected. Parameter b1-08.</p>

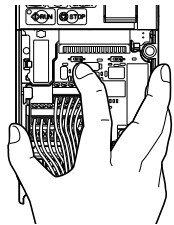
Replace the Drive	
<p>The removable terminal block with parameter backup function allows the transfer of parameter settings after drive replacement. <i>Refer to Dismantling the Removable Terminal Block on page 319.</i></p>	

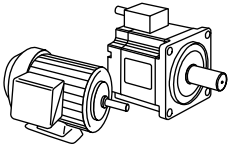
Drive a Synchronous PM Motor	
<p>The V1000 drive can operate synchronous PM motors. <i>Refer to Subchart A3: Operation with Permanent Magnet Motors on page 94.</i></p>	

Perform Auto-Tuning
<p>Automatic tuning sets motor parameters. <i>Refer to Auto-Tuning on page 102.</i></p>

Check the Maintenance Period Using Drive Monitors
<p>The maintenance period of fans and capacitors can be checked with drive monitors. <i>Refer to Performance Life Monitors on page 314</i></p>

Drive or Motor Faults are Displayed on a Digital Operator

Refer to Fault Displays, Causes, and Possible Solutions on page 267 and Refer to Detailed Alarm Codes, Causes, and Possible Solutions on page 282.

Standards Compliance

Refer to European Standards on page 466 and Refer to UL and CSA Standards on page 474.



DMC

Drives Motors Controls

i.3 Application Precautions

◆ General Application Precautions

■ Selecting a Reactor

An AC reactor or DC link choke can be used for the following:

- to suppress harmonic current.
- to smooth peak current that results from capacitor switching.
- when the power supply is above 600 kVA.
- when the drive is running from a power supply system with thyristor converters.

Note: A DC link choke is built in to 200 V and 400 V class models with a capacity of 22 kW and higher (HD rating).

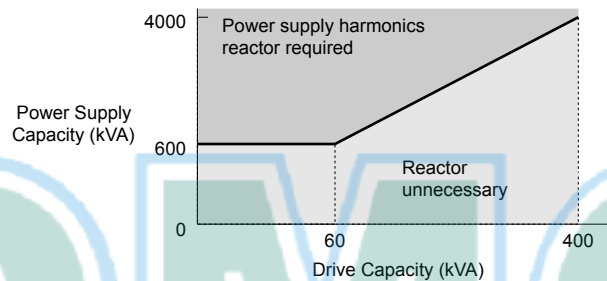

Figure i.3 Installing a Reactor

■ Drive Capacity

Make sure that the motor rated current is less than the rated nameplate output current of the drive. When running more than one motor in parallel from a single drive, the drive rated current should be 1.1 times larger than the total motor rated current for all connected motors or nuisance drive faults may occur.

■ Starting Torque

The overload rating of the drive determines the starting and accelerating characteristics of the motor. Expect lower running torque than when running the motor from line power. To get more starting torque, use a larger drive or increase both the motor and drive capacity.

■ Emergency/Fast Stop

During a drive fault condition, a protective circuit is activated and drive output is shut off. The motor may coast to a stop or attempt to decelerate depending on parameter settings. If the emergency/fast stop cannot stop the load as fast as desired, a customer-supplied mechanical brake may be required. Test emergency stop circuitry before putting drive into operation.

■ Options

The B1, B2, +1, +2, and +3 terminals are used to connect optional power devices. Connect only devices compatible with the drive.

■ Repetitive Starting/Stopping

Applications with frequent starts and stops often exceed 150% of their rated current values. Heat stress generated from repetitive high current can shorten the life span of the IGBTs. The expected lifetime for the IGBTs is about 8 million start and stop cycles with a 4 kHz carrier frequency and a 150% peak current.

Yaskawa recommends lowering the carrier frequency, particularly when audible noise is not a concern. The user can also choose to reduce the load, increase the acceleration and deceleration times, or switch to a larger drive. This will help keep peak current levels under 150%. Be sure to check the peak current levels when starting and stopping repeatedly during the initial test run, and make adjustments accordingly.

◆ Installation Environment

■ Enclosure Panels

Keep the drive in a clean environment by either selecting an area free of airborne dust, lint, and oil mist, or install the drive in an enclosure panel. Be sure to leave the required space between drives to provide for cooling, and that proper measures are taken so that the ambient temperature remains within allowable limits. Keep flammable materials away from the drive. If the drive must be used in an area where it is subjected to oil mist and excessive vibration, protective designs are available. Contact Yaskawa or your Yaskawa agent for details.

■ Installation Direction

The drive should be installed upright as specified in the manual.

◆ Settings

■ Motor Code

If using OLV/PM designed for permanent magnet motors (A1-02 = 5), make sure that the proper motor code is set in parameter E5-01 before performing a trial run.

■ Upper Limits

The drive is capable of running the motor up to 400 Hz. Due to the danger of accidentally operating the motor at high speed, be sure to set the upper frequency limit. The default setting for the maximum output frequency is 60 Hz.

■ DC Injection Braking

Motor overheat can result if there is too much current used during DC Injection Braking, or if the DC Injection Braking time is too long.

■ Acceleration/Deceleration Times

Acceleration and deceleration times are affected by how much torque the motor generates, the load torque, and the inertia moment ($(GD^2)/4$). Set a longer accel/decel time when Stall Prevention is enabled. The accel/decel times are lengthened for as long as the Stall Prevention function is operating. For faster acceleration and deceleration, install a braking option or increase the capacity of the drive.

◆ General Handling

NOTICE: *Wiring Check. Never connect the power supply lines to output terminals U/T1, V/T2, or W/T3. Doing so will destroy the drive. Be sure to perform a final check of all control wiring and other connections before applying line power. Make sure there are no short circuits on the control terminals (+V, AC, etc.), as this could damage the drive.*

■ Selecting a Molded Case Circuit Breaker (MCCB) or Ground Fault Circuit Interrupter (GFCI)

Yaskawa recommends installing a GFCI on the line power supply to protect drive wiring and prevent damage in the event of component failure. An MCCB may also be used if permitted by the power system.

The GFCI should be designed for use with an AC drive (i.e., protected against harmonics)

MCCB selection depends on the power factor for the drive, determined by the power supply voltage, output frequency, and load.

Refer to [Installing Peripheral Devices on page 330](#) for more information on breaker installation. Note that a larger capacity breaker is needed when using a fully electromagnetic MCCB, as operation characteristics vary with harmonic current.

■ Magnetic Contactor (MC) Installation

Use an MC to ensure that line power to the drive can be completely shut off when necessary. The MC should be wired so that it opens when the drive fault output is triggered.

Avoid switching the MC on the power supply side more frequently than once every 30 minutes. Frequent switching can cause damage to the drive.

i.3 Application Precautions

■ Inspection and Maintenance

DANGER! *Electrical Shock Hazard. Do not connect or disconnect wiring while the power is on. Failure to comply will result in death or serious injury. Disconnect all power to the drive, wait at least five minutes after all indicators are OFF, measure the DC bus voltage to confirm safe level, and check for unsafe voltages before servicing to prevent electrical shock. The internal capacitor remains charged even after the power supply is turned off. The charge indicator LED will extinguish when the DC bus voltage is below 50 Vdc.*

CAUTION! *Burn Hazard. Do not touch a hot drive heatsink. Failure to comply could result in minor or moderate injury. Shut off the power to the drive when replacing the cooling fan. To prevent burns, wait at least 15 minutes and make sure the heatsink has cooled to a safe level.*

WARNING! *Electrical Shock Hazard. Wait for at least the time specified on the drive warning label after opening the load switch on the output side before any inspection or maintenance of permanent magnet (PM) motors. Failure to comply could result in death or serious injury.*

WARNING! *Sudden Movement Hazard. Install a switch disconnect between the motor and the drive in applications where the machine can still rotate even though the drive has fully stopped. Unpredictable equipment operation may result in death or serious injury.*

WARNING! *Sudden Movement Hazard. Do not attempt to move a load that could potentially rotate the motor faster than the maximum allowable r/min when the drive has been shut off. Unpredictable equipment operation may result in death or serious injury.*

NOTICE: *Do not open and close the motor disconnect switch while the motor is running, as this may damage the drive.*

NOTICE: *If the motor is coasting, make sure the power to the drive is turned on and the drive output has completely stopped before closing the load switch.*

■ Wiring

All wire ends should use ring terminals for UL/cUL compliance. Use only the tools recommended by the terminal manufacturer for crimping.

■ Transporting the Drive

NOTICE: *Prevent the drive from contact with salts, fluorine, bromine, phthalate ester, and other such harmful chemicals. Never steam clean the drive. Failure to comply may cause damage to the drive components.*

◆ Notes on Motor Operation

■ Using a Standard Motor

Low Speed Range

The cooling fan of a standard motor is usually designed to sufficiently cool the motor at the rated speed. As the self-cooling capability of such a motor reduces with the speed, applying full torque at low speed will possibly damage the motor. To prevent motor damage from overheat, reduce the load torque as the motor slows. [Figure i.4](#) shows the allowable load characteristics for a Yaskawa standard motor. A motor designed specifically for operation with a drive should be used when 100% continuous torque is needed at low speeds.

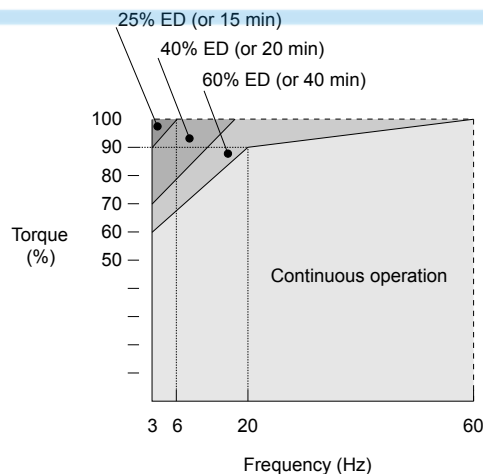

Figure i.4 Allowable Load Characteristics for a Yaskawa Motor

Insulation Tolerance

Consider motor voltage tolerance levels and motor insulation in applications with an input voltage of over 440 V or particularly long wiring distances. Contact Yaskawa or your Yaskawa agent for consultation.

High Speed Operation

Problems may occur with the motor bearings and dynamic balance of the machine when operating a motor beyond its rated speed. Contact the motor or machine manufacturer.

Torque Characteristics

Torque characteristics differ compared to operating the motor directly from line power. The user should have a full understanding of the load torque characteristics for the application.

Vibration and Shock

The drive settings allow the user to choose between high carrier PWM control and low carrier PWM. Selecting high carrier PWM can help reduce motor oscillation.

Take particular caution when using a variable speed drive for an application that is conventionally run from line power at a constant speed. If mechanical resonance occurs, install shock-absorbing rubber around the base of the motor and enable the Jump frequency selection parameter to prevent continuous operation in the resonant frequency range.

Audible Noise

Noise created during run varies by the carrier frequency setting. When using a high carrier frequency, audible noise from the motor is comparable to the motor noise generated when running from line power. Operating above the rated r/min, however, can create unpleasant motor noise.

■ Using a Synchronous Motor

- Synchronous motors cannot be started directly from line power. Applications requiring line power to start should use an induction motor with the drive.
- A single drive is not capable of running multiple synchronous motors at the same time. Use a standard induction motor for such setups.
- At start, a synchronous motor may rotate slightly in the opposite direction of the Run command depending on parameter settings and motor type.
- The amount of starting torque that can be generated differs by each control mode and by the type of motor being used. Set up the motor with the drive after verifying the starting torque, allowable load characteristics, impact load tolerance, and speed control range.

Contact Yaskawa or your Yaskawa agent if you plan to use a motor that does not fall within these specifications.

- **Braking Torque:** In Open Loop Vector Control for PM motors, braking torque is less than 125% when running between 20% to 100% speed, even with a braking resistor. Braking torque drops to less than half when running at less than 20% speed.
- **Load Inertia:** In Open Loop Vector Control for PM motors, the allowable load inertia moment is approximately 50 times higher than the motor inertia moment or less. Contact Yaskawa or your Yaskawa agent concerning applications with a larger inertia moment.
- **Holding Brake:** When using a holding brake in Open Loop Vector Control for PM motors, release the brake prior to starting the motor. Failure to set the proper timing can result in speed loss. Not for use with conveyor, transport, or hoist type applications.
- **Restarting a Coasting Motor:** To restart a coasting motor rotating at over 200 Hz while in the V/f control mode, use the Short Circuit Braking function to first bring the motor to a stop. Short Circuit Braking requires a special braking resistor. Contact Yaskawa or your Yaskawa agent for details.

Speed Search can be used to restart a coasting motor rotating slower than 200 Hz. If the motor cable is relatively long, however, the motor should instead be stopped using Short Circuit Braking, which forces the motor to stop by creating a short-circuit in the motor windings.

■ Applications with Specialized Motors

Multi-Pole Motor

Because the rated current will differ from a standard motor, be sure to check the maximum current when selecting a drive. Always stop the motor before switching between the number of motor poles. If a regen overvoltage (oV) fault occurs or if overcurrent protection (oC) is triggered, the motor will coast to stop.

Submersible Motor

Because motor rated current is greater than a standard motor, select the drive capacity accordingly. Be sure to use a large enough gauge motor cable to avoid decreasing the maximum torque level on account of voltage drop caused by a long motor cable.

i.3 Application Precautions

Explosion-Proof Motor

Both the motor and drive need to be tested together to be certified as explosion-proof. The drive is not designed for explosion proof areas.

Furthermore, if an encoder is attached to an explosion-proof motor make sure the encoder is also explosion-proof. Use an insulating signal converter for connecting the encoder signal lines to the drives speed feedback option card.

Geared Motor

To avoid gear damage when operating at low speeds or very high speeds, make sure that both the gear and lubricant are rated for the desired speed range. Consult with the manufacturer for applications that require operation outside the rated speed range of the motor or gear box.

Single-Phase Motor

Variable speed AC drives are not designed for operation with single phase motors. Using capacitors to start the motor causes excessive current to flow and can damage drive components. A split-phase start or a repulsion start can end up burning out the starter coils because the internal centrifugal switch is not activated. The drive is for use with 3-phase motors only.

Motor with Brake

Caution should be taken when using a drive to operate a motor with a built-in holding brake. If the brake is connected to the output side of the drive, it may not release at start due to low voltage levels. A separate power supply should be installed for the motor brake. Motors with a built-in brake tend to generate a fair amount of noise when running at low speeds.

■ Power Driven Machinery (decelerators, belts, chains, etc.)

Continuous operation at low speeds wears on the lubricating material used in gear box type systems to accelerate and decelerate power driven machinery. Caution should also be taken when operating at speeds above the rated machine speed due to noise and shortened performance life.

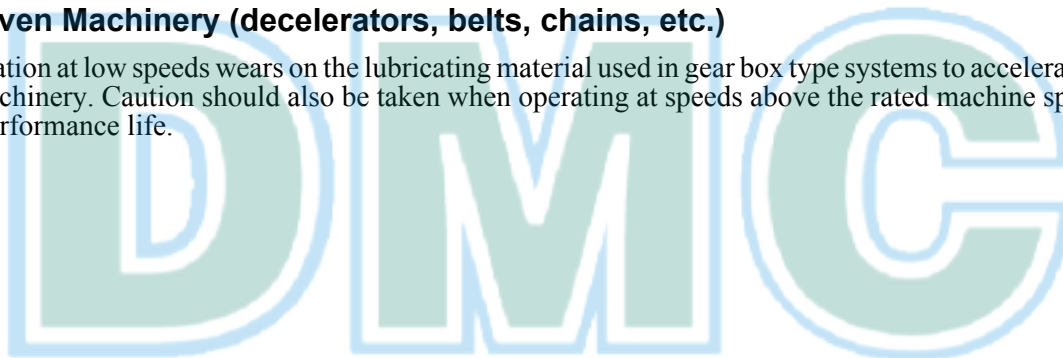

Drives Motors Controls

Receiving

This chapter describes the proper inspections to perform after receiving the drive and illustrates the different enclosure types and components.

1.1	SECTION SAFETY	24
1.2	MODEL NUMBER AND NAMEPLATE CHECK	25
1.3	DRIVE MODELS AND ENCLOSURE TYPES	27
1.4	COMPONENT NAMES	28

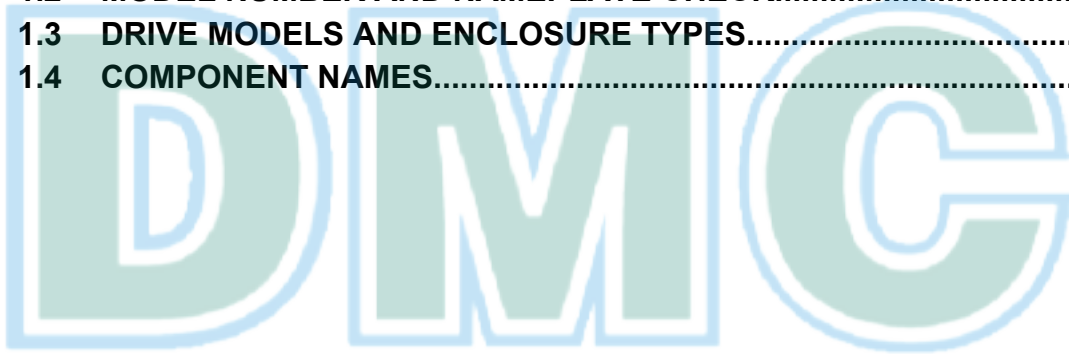

Drives Motors Controls

1.1 Section Safety

⚠ CAUTION

Do not carry the drive by the front cover.

Failure to comply may cause the main body of the drive to fall, resulting in minor or moderate injury.

NOTICE

Observe proper electrostatic discharge procedures (ESD) when handling the drive and circuit boards.

Failure to comply may result in ESD damage to the drive circuitry.

A motor connected to a PWM drive may operate at a higher temperature than a utility-fed motor and the operating speed range may reduce motor cooling capacity.

Ensure that the motor is suitable for drive duty and/or the motor service factor is adequate to accommodate the additional heating with the intended operating conditions.

The logo consists of the letters 'D', 'M', and 'C' in a large, light blue, outlined font. The 'D' is on the left, 'M' is in the middle, and 'C' is on the right. The letters are spaced out and have a consistent thickness for the outlines.The tagline 'Drives Motors Controls' is written in a light blue, sans-serif font. It is positioned below the 'DMC' logo and is flanked by two horizontal light blue lines, one above and one below the text.

1.2 Model Number and Nameplate Check

Please perform the following tasks after receiving the drive:

- Inspect the drive for damage.
- If the drive appears damaged upon receipt, contact the shipper immediately.
- Verify receipt of the correct model by checking the information on the nameplate.
- If you have received the wrong model or the drive does not function properly, contact your supplier.

◆ Nameplate

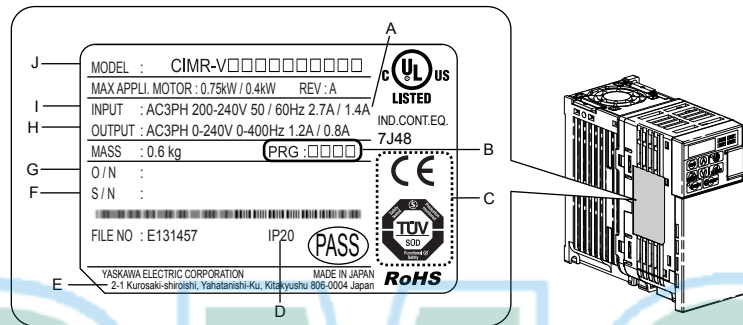

- A – Normal Duty Amps / Heavy Duty Amps
- B – Software version
- C – CE and TÜV Certification
- D – Enclosure type
- E – Address <1>
- F – Serial number
- G – Lot number
- H – Output specifications
- I – Input specifications
- J – AC drive model

Figure 1.1 Nameplate Information Example

<1> The address of the head office of Yaskawa Electric Corporation (responsible for product liability) is shown on the nameplate.

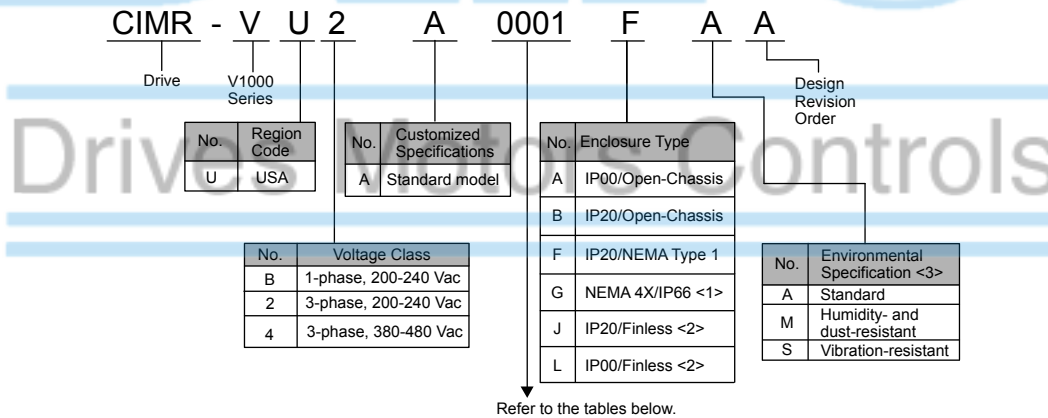

Refer to the tables below.

<1> Refer to manual TOBPC71060635 for more information on these models.
 <2> Refer to manual TOBPC71060621 for more information on these models.
 <3> Drives with these specifications do not guarantee complete protection for the specified environmental condition.

■ Single-Phase 200 V Class

Model	Normal Duty		Heavy Duty	
	Max. Motor Capacity kW	Rated Output Current A	Max. Motor Capacity kW	Rated Output Current A
BA0001	0.2	1.2	0.1	0.8
BA0002	0.4	1.9	0.2	1.6
BA0003	0.75	3.3	0.4	3.0
BA0006	1.1	6.0	0.75	5.0
BA0010	2.2	9.6	1.5	8.0
BA0012	3.0	12.0	2.2	11.0

1.2 Model Number and Nameplate Check

Model	Normal Duty		Heavy Duty	
	Max. Motor Capacity kW	Rated Output Current A	Max. Motor Capacity kW	Rated Output Current A
BA0018 <1>	–	–	3.7	17.5

<1> Available with Heavy Duty rating only.

■ Three-Phase 200 V Class

Model	Normal Duty		Heavy Duty	
	Max. Motor Capacity kW	Rated Output Current A	Max. Motor Capacity kW	Rated Output Current A
2A0001	0.2	1.2	0.1	0.8
2A0002	0.4	1.9	0.2	1.6
2A0004	0.75	3.5	0.4	3.0
2A0006	1.1	6.0	0.75	5.0
2A0010	2.2	9.6	1.5	8.0
2A0012	3.0	12.0	2.2	11.0
2A0020	5.5	19.6	3.7	17.5
2A0030	7.5	30.0	5.5	25.0
2A0040	11	40.0	7.5	33.0
2A0056	15	56.0	11	47.0
2A0069	18.5	69.0	15	60.0

■ Three-Phase 400 V Class

Model	Normal Duty		Heavy Duty	
	Max. Motor Capacity kW	Rated Output Current A	Max. Motor Capacity kW	Rated Output Current A
4A0001	0.4	1.2	0.2	1.2
4A0002	0.75	2.1	0.4	1.8
4A0004	1.5	4.1	0.75	3.4
4A0005	2.2	5.4	1.5	4.8
4A0007	3.0	6.9	2.2	5.5
4A0009	3.7	8.8	3.0	7.2
4A0011	5.5	11.1	3.7	9.2
4A0018	7.5	17.5	5.5	14.8
4A0023	11	23.0	7.5	18.0
4A0031	15	31.0	11	24.0
4A0038	18.5	38.0	15	31.0

Note: Refer to [Component Names on page 28](#) for differences regarding enclosure protection types and component descriptions.

1.3 Drive Models and Enclosure Types

The following table describes drive enclosures and models.

Table 1.1 Drive Models and Enclosure Types

Voltage Class	Enclosure Type		
	IP20/Open-Chassis Drive Model	IP00/Open-Chassis Drive Model	IP20/NEMA Type 1 Drive Model
Single-Phase 200 V Class	BA0001B	–	BA0001F
	BA0002B	–	BA0002F
	BA0003B	–	BA0003F
	BA0006B	–	BA0006F
	BA0010B	–	BA0010F
	BA0012B	–	BA0012F
	BA0018B	–	BA0018F
Three-Phase 200 V Class	2A0001B	–	2A0001F
	2A0002B	–	2A0002F
	2A0004B	–	2A0004F
	2A0006B	–	2A0006F
	2A0010B	–	2A0010F
	2A0012B	–	2A0012F
	2A0020B	–	2A0020F
	–	2A0030A	2A0030F
	–	2A0040A	2A0040F
	–	2A0056A	2A0056F
–	2A0069A	2A0069F	
Three-Phase 400 V Class	4A0001B	–	4A0001F
	4A0002B	–	4A0002F
	4A0004B	–	4A0004F
	4A0005B	–	4A0005F
	4A0007B	–	4A0007F
	4A0009B	–	4A0009F
	4A0011B	–	4A0011F
	–	4A0018A	4A0018F
	–	4A0023A	4A0023F
	–	4A0031A	4A0031F
–	4A0038A	4A0038F	

Two types of enclosures are offered for V1000 drives.

- IP20/Open-Chassis and IP00/Open-Chassis models are often placed inside a large enclosure panel where the front of the drive is covered to prevent someone from accidentally touching charged components.
- IP20/NEMA Type 1 models mount to an indoor wall and not inside a large enclosure panel.

1.4 Component Names

This section illustrates the drive components as they are mentioned in this manual.

◆ IP20/Open-Chassis

- Single-Phase AC 200 V BA0001B to BA0003B
- Three-Phase AC 200 V 2A0001B to 2A0006B

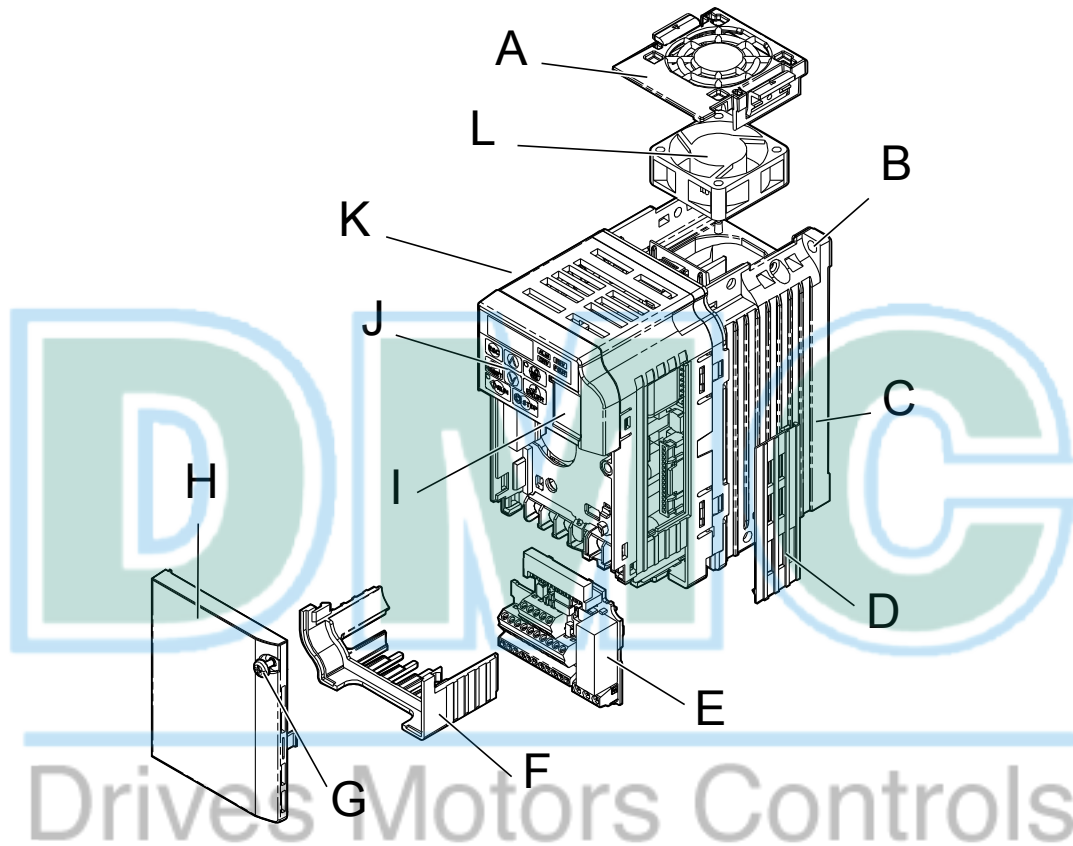

- | | |
|--|--|
| A – Fan cover <1> | G – Front cover screw |
| B – Mounting hole | H – Front cover |
| C – Heatsink | I – Comm port |
| D – Optional 24 VDC power supply connector cover | J – LED operator <i>Refer to Using the Digital LED Operator on page 80</i> |
| E – Terminal board <i>Refer to Control Circuit Terminal Block Functions on page 64</i> | K – Case |
| F – Terminal cover | L – Cooling fan <1> |

Figure 1.2 Exploded View of IP20/Open-Chassis Type Components (Model 2A0006B)

<1> Models BA0001B to BA0003B and 2A0001B to 2A0004B do not have a cooling fan or a cooling fan cover.

- Single-Phase AC 200 V BA0006B to BA0018B
- Three-Phase AC 200 V 2A0010B to 2A0020B
- Three-Phase AC 400 V 4A0001B to 4A0011B

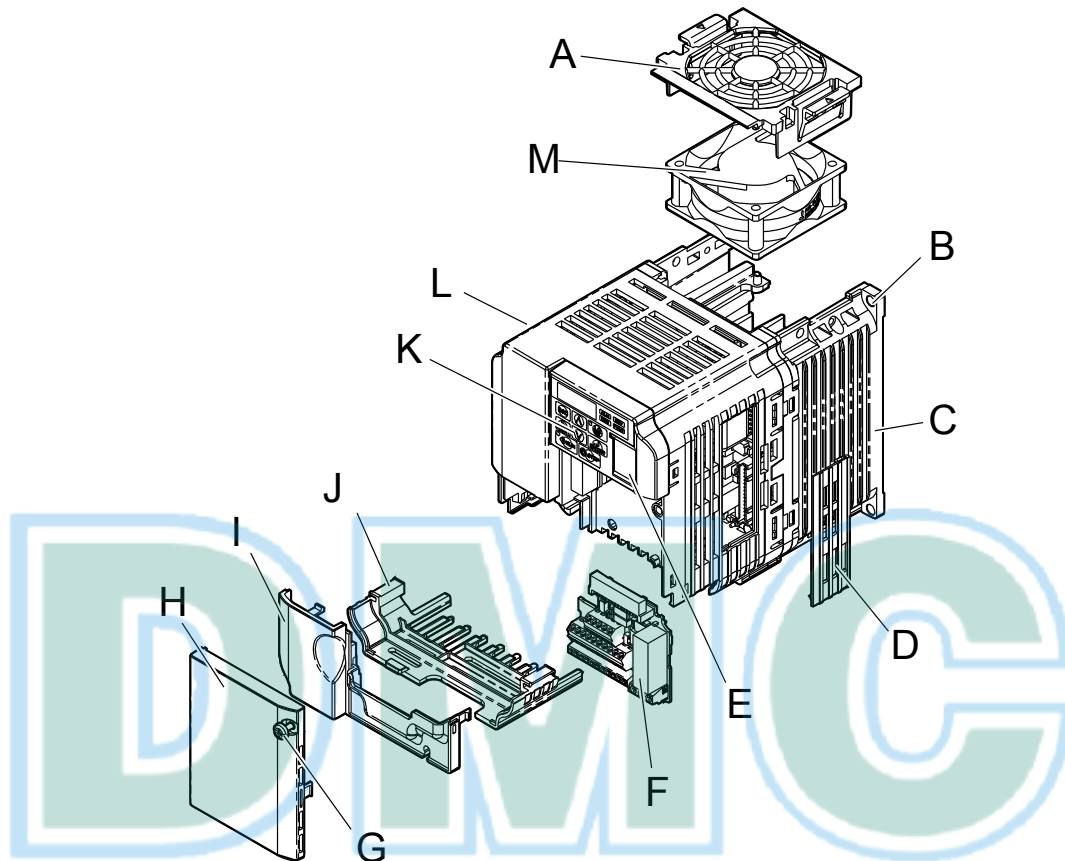

- | | |
|--|--|
| A – Fan cover <1> | H – Front cover |
| B – Mounting hole | I – Terminal cover |
| C – Heatsink | J – Bottom cover |
| D – Optional 24 VDC power supply connector cover | K – LED operator <i>Refer to Using the Digital LED Operator on page 80</i> |
| E – Comm port | L – Case |
| F – Terminal board <i>Refer to Control Circuit Terminal Block Functions on page 64</i> | M – Cooling fan <1> |
| G – Front cover screw | |

Figure 1.3 Exploded View of IP20/Open-Chassis Type Components (Model 2A0012B)

<1> Models BA0006B and 4A0001B to 4A0004B do not have a cooling fan or a cooling fan cover. Model BA0018B has two cooling fans.

◆ IP00/Open-Chassis

- Three-Phase AC 200 V 2A0030A to 2A0069A
- Three-Phase AC 400 V 4A0018A to 4A0038A

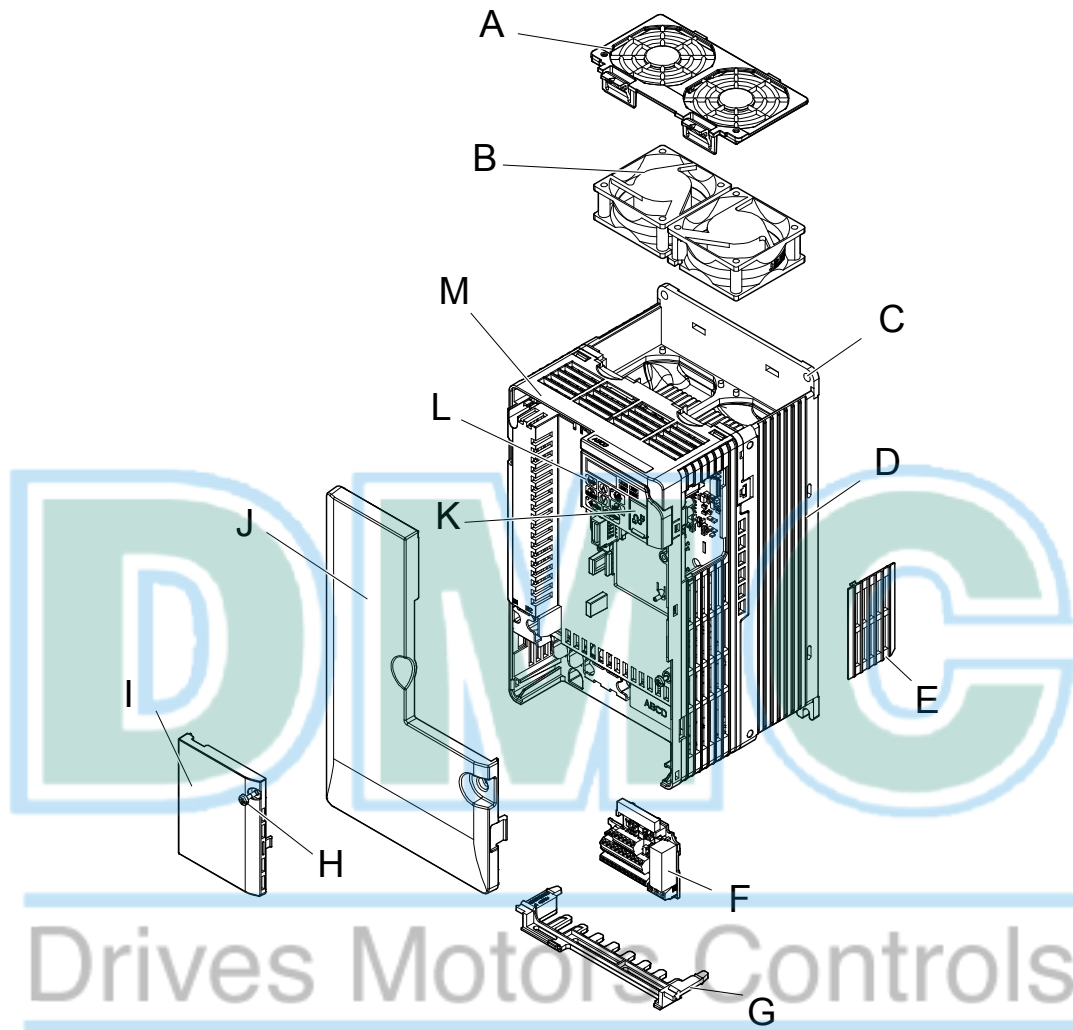

- | | |
|--|--|
| A – Fan cover | H – Front cover screw |
| B – Cooling Fan | I – Front cover |
| C – Mounting hole | J – Terminal cover |
| D – Heatsink | K – Comm port |
| E – Optional 24 VDC power supply connector cover | L – LED operator <i>Refer to Using the Digital LED Operator on page 80</i> |
| F – Terminal board <i>Refer to Control Circuit Terminal Block Functions on page 64</i> | M – Case |
| G – Bottom cover | |

Figure 1.4 Exploded View of IP00/Open-Chassis Type Components (Model 4A0018A)

◆ IP20/NEMA Type 1 Enclosure

- Single-Phase AC 200 V BA0001F to BA0003F
- Three-Phase AC 200 V 2A0001F to 2A0006F

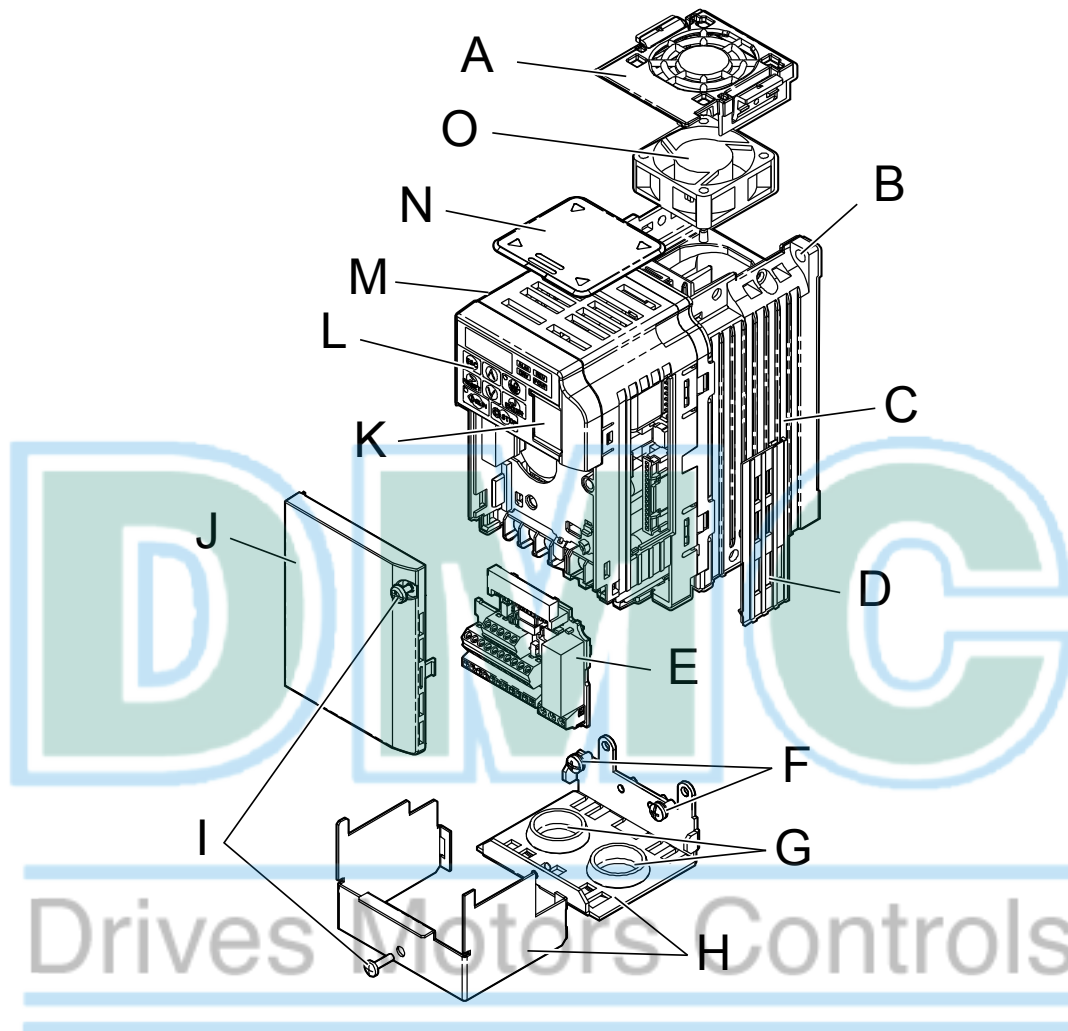

- | | |
|--|--|
| A – Fan cover <1> | I – Front cover screws |
| B – Mounting hole | J – Front cover |
| C – Heatsink | K – Comm port |
| D – Optional 24 VDC power supply connector cover | L – LED operator <i>Refer to Using the Digital LED Operator on page 80</i> |
| E – Terminal board <i>Refer to Control Circuit Terminal Block Functions on page 64</i> | M – Case |
| F – Bottom cover screws | N – Top cover |
| G – Rubber bushing | O – Cooling fan <1> |
| H – Bottom front cover | |

Figure 1.5 Exploded View of IP20/NEMA Type 1 Components (Model 2A0006F)

<1> Models BA0001F to BA0003F and 2A0001F to 2A0004F do not have a cooling fan or a cooling fan cover.

1.4 Component Names

- Single-Phase AC 200 V BA0006F to BA0018F
- Three-Phase AC 200 V 2A0010F to 2A0020F
- Three-Phase AC 400 V 4A0001F to 4A0011F

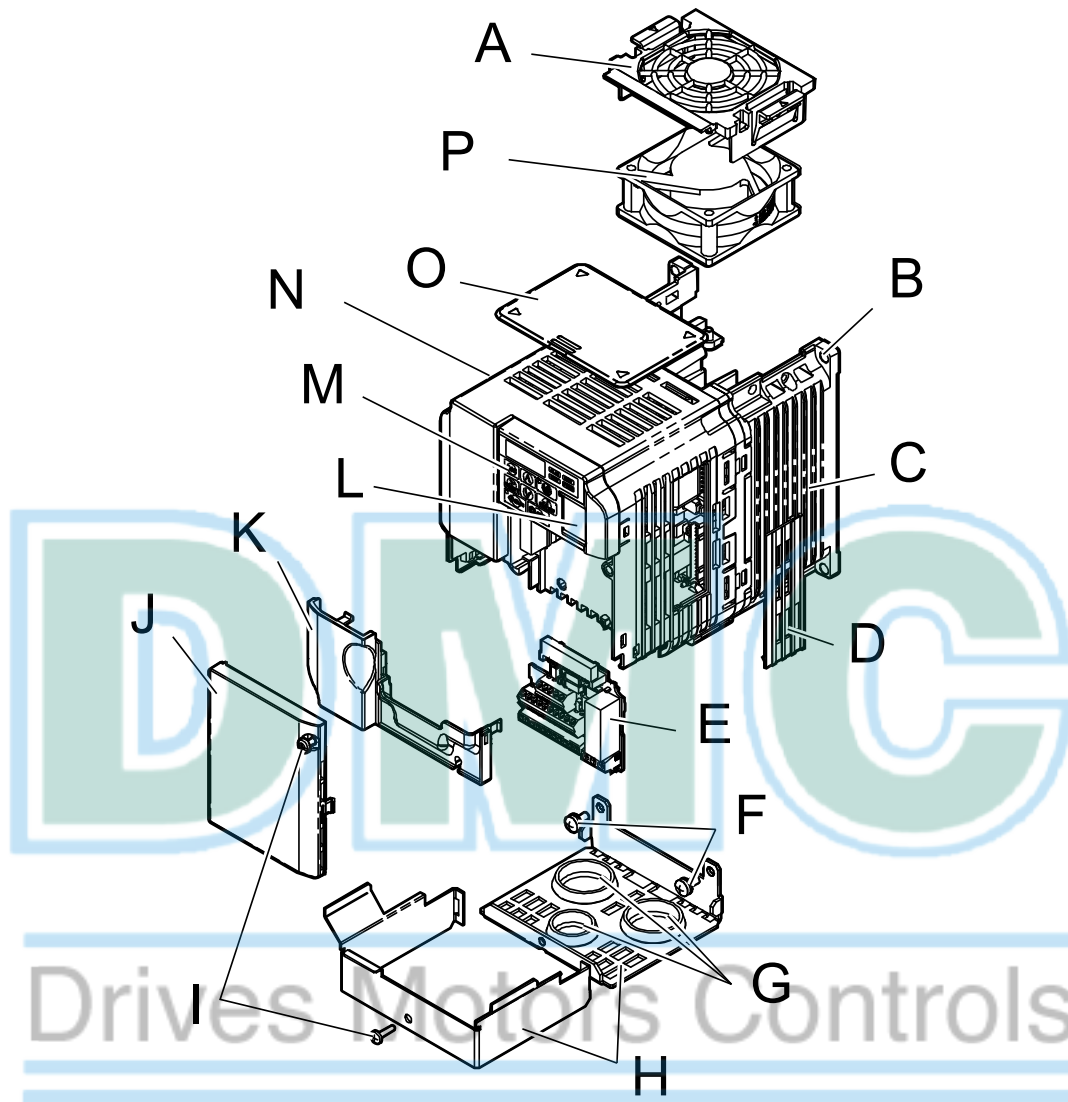

- | | |
|--|--|
| A – Fan cover <1> | I – Front cover screws |
| B – Mounting hole | J – Front cover |
| C – Heatsink | K – Terminal cover |
| D – Optional 24 VDC power supply connector cover | L – Comm port |
| E – Terminal board <i>Refer to Control Circuit Terminal Block Functions on page 64</i> | M – LED operator <i>Refer to Using the Digital LED Operator on page 80</i> |
| F – Cover screws | N – Case |
| G – Rubber bushing | O – Top cover |
| H – Bottom cover | P – Cooling fan <1> |

Figure 1.6 Exploded view of IP20/NEMA Type 1 Components (Model 2A0012F)

<1> Models BA0006B and 4A0001B to 4A0004B do not have a cooling fan or a cooling fan cover. Model BA0018B has two cooling fans.

- Three-Phase AC 200 V 2A0030F to 2A0069F
- Three-Phase AC 400 V 4A00018F to 4A0038F

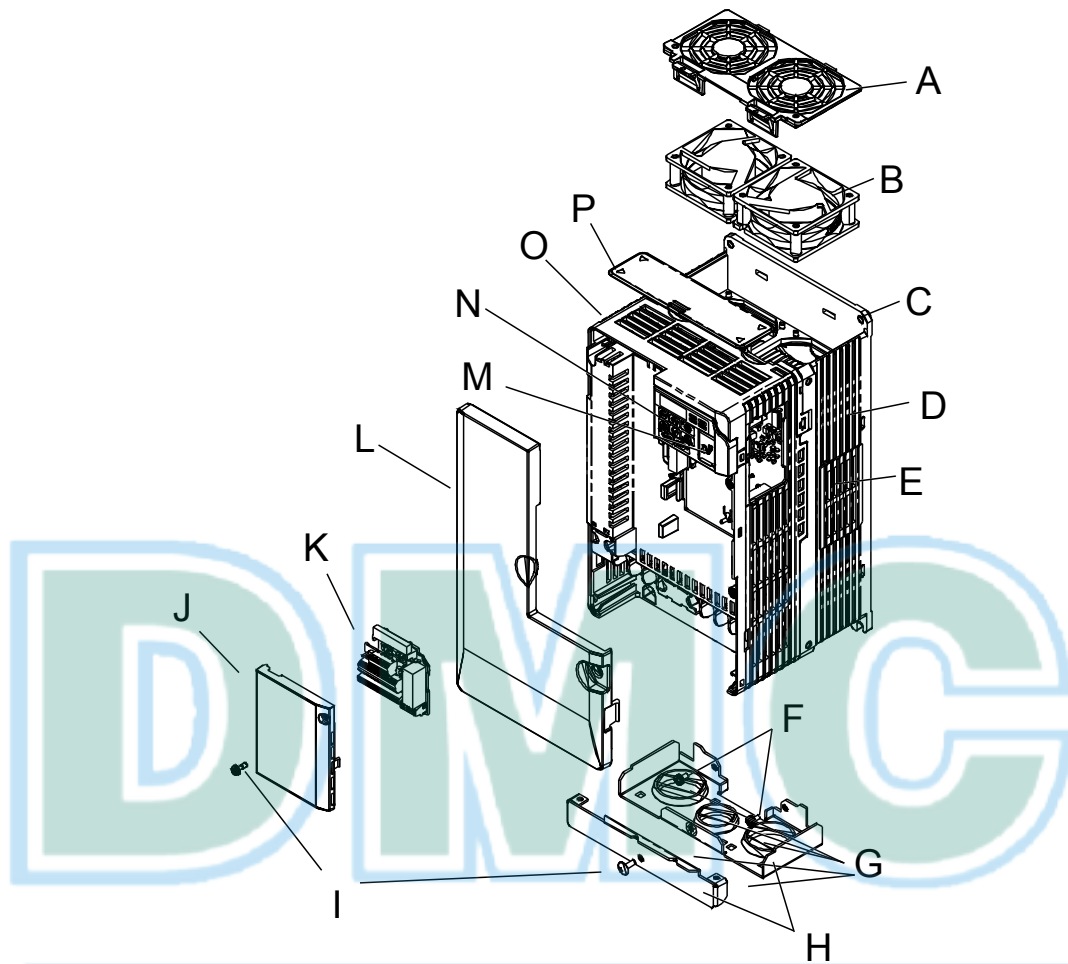

- | | |
|---|--|
| A – Fan cover | I – Front cover screws |
| B – Cooling fan | J – Terminal cover |
| C – Mounting Hole | K – Terminal board <i>Refer to Control Circuit Terminal Block Functions on page 64</i> |
| D – Case and Heatsink | L – Front cover |
| E – Optional 24 VDC power supply connection cover | M – Comm port |
| F – Cover screws | N – LED operator <i>Refer to Using the Digital LED Operator on page 80</i> |
| G – Rubber bushing | O – Case |
| H – Bottom cover | P – Top cover |

Figure 1.7 Exploded View of IP20/NEMA Type 1 Components (Model 4A0018F)

◆ Front Views

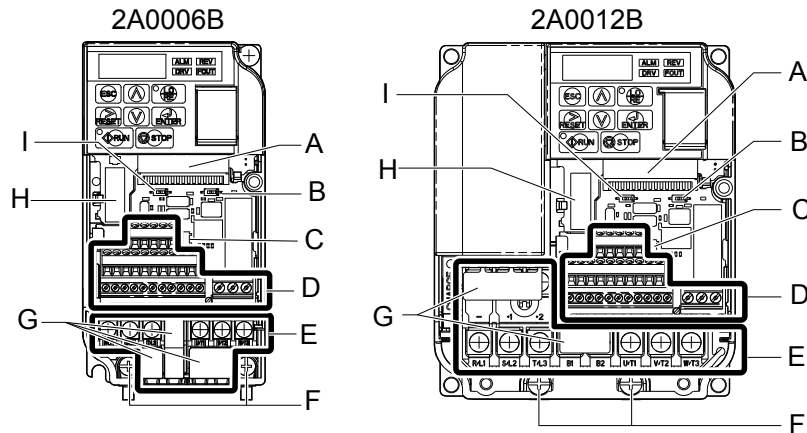

- A – Terminal board connector
- B – DIP switch S1 *Refer to DIP Switch S1 Analog Input Signal Selection on page 70*
- C – DIP switch S3 *Refer to Sinking/Sourcing Mode Switch on page 68*
- D – Control circuit terminal *Refer to Control Circuit Wiring on page 63*
- E – Main circuit terminal *Refer to Wiring the Main Circuit Terminal on page 62*

- F – Ground terminal
- G – Terminal cover
- H – Option card connector *Refer to Connecting the Option Card on page 338*
- I – DIP switch S2 *Refer to MEMOBUS/Modbus Termination on page 71*

Figure 1.8 Front Views of Drives

Drives Motors Controls

Mechanical Installation

This chapter explains how to properly mount and install the drive.

2.1 SECTION SAFETY	36
2.2 MECHANICAL INSTALLATION	38



Drives Motors Controls

2.1 Section Safety

WARNING

Fire Hazard

Provide sufficient cooling when installing the drive inside an enclosed panel or cabinet.

Failure to comply could result in overheating and fire.

When multiple drives are placed inside the same enclosure panel, install proper cooling to ensure air entering the enclosure does not exceed 40 °C.

CAUTION

Crush Hazard

Do not carry the drive by the front cover.

Failure to comply may result in minor or moderate injury from the main body of the drive falling.

NOTICE

Observe proper electrostatic discharge (ESD) procedures when handling the drive.

Failure to comply could result in ESD damage to the drive circuitry.

It may be difficult to perform maintenance on the cooling fans of drives installed in a vertical row inside an enclosure.

Ensure adequate spacing at the top of the drive to perform cooling fan replacement when required.

Operating the motor in the low-speed range diminishes the cooling effects, increases motor temperature, and may lead to motor damage by overheating.

Reduce the motor torque in the low-speed range whenever using a standard blower cooled motor. If 100% torque is required continuously at low speed, consider using a special drive or vector motor. Select a motor that is compatible with the required load torque and operating speed range.

Do not operate motors above the maximum rated RPM.

Failure to comply may lead to bearing or other mechanical motor failures.

The speed range for continuous operation differs according to the lubrication method and motor manufacturer.

If the motor is to be operated at a speed higher than the rated speed, consult with the manufacturer.

Continuously operating an oil-lubricated motor in the low-speed range may result in burning.

NOTICE

When the wiring distance is greater than 100 meters, pay special attention to the motor insulation voltage or use a drive-rated motor.

Failure to comply could lead to motor winding failure.

Motor vibration may increase when operating a machine in variable-speed mode, if that machine previously operated at a constant speed.

Install vibration-proof rubber on the motor base or use the frequency jump function to skip a frequency resonating the machine.

The motor may require more acceleration torque with drive operation than with a commercial power supply.

Set a proper V/f pattern by checking the load torque characteristics of the machine to be used with the motor.

The rated input current of submersible motors is higher than the rated input current of standard motors.

Select an appropriate drive according to its rated output current. When the distance between the motor and drive is long, use a cable thick enough to connect the motor to the drive to prevent motor torque reduction.

When using an explosion-proof motor, it must be subject to an explosion-proof test in conjunction with the drive.

This is also applicable when an existing explosion-proof motor is to be operated with the drive. Since the drive itself is not explosion-proof, always install it in a safe place. Be sure to set A1-02 to "0" when using an explosion-proof motor.

Do not use a drive for a single-phase motor.

Replace the motor with a three-phase motor.

If an oil-lubricated gearbox or speed reducer is used in the power transmission mechanism, oil lubrication will be affected when the motor operates only in the low speed range.

The power transmission mechanism will make noise and experience problems with service life and durability if the motor is operated at a speed higher than the rated speed.

Drives Motors Controls

2.2 Mechanical Installation

This section outlines specifications, procedures, and environment for proper mechanical installation of the drive.

◆ Installation Environment

To help prolong the optimum performance life of the drive, install the drive in the proper environment. [Table 2.1](#) describes the appropriate environment for the drive.

Table 2.1 Installation Environment

Environment	Conditions
Installation Area	Indoors
Ambient Temperature	IP20/NEMA Type 1 enclosure: -10 °C to +40 °C (14 °F to 104 °F) IP20/IP00 Open-Chassis enclosure: -10 °C to +50 °C (14 °F to 122 °F) Finless Type: IP20/IP00 enclosure: -10 °C to +50 °C (14 °F to 122 °F) NEMA Type 4X/IP66 enclosure: -10 °C to +40 °C (14 °F to 104 °F) Drive reliability improves in environments without wide temperature fluctuations. When using an enclosure panel, install a cooling fan or air conditioner in the area to ensure that the air temperature inside the enclosure does not exceed the specified levels. Do not allow ice to develop on the drive.
Humidity	95% RH or less and free of condensation
Storage Temperature	-20 °C to +60 °C (-4 °F to +104 °F)
Surrounding Area	Install the drive in an area free from: <ul style="list-style-type: none"> • oil mist and dust • metal shavings, oil, water or other foreign materials • radioactive materials • combustible materials (e.g., wood) • harmful gases and liquids • excessive vibration • chlorides • direct sunlight
Altitude	Up to 1000 meters without derating; up to 3000 meters with output current, ambient temperature, and voltage derating. Refer to Altitude Derating on page 352 for details.
Vibration	10 to 20 Hz at 9.8 m/s ² 20 to 55 Hz at 5.9 m/s ²
Orientation	Install the drive vertically to maintain maximum cooling effects.

NOTICE: Prevent foreign matter such as metal shavings or wire clippings from falling into the drive during installation and project construction. Failure to comply could result in damage to the drive. Place a temporary cover over the top of the drive during installation. Remove the temporary cover before startup, as the cover will reduce ventilation and cause the drive to overheat.

NOTICE: Avoid placing drive peripheral devices, transformers, or other electronics near the drive. Failure to comply could result in erroneous operation. If such devices must be used in close proximity to the drive, take proper steps to shield the drive from noise.

◆ Installation Orientation and Spacing

Install the drive upright as illustrated in [Figure 2.1](#) to maintain proper cooling.

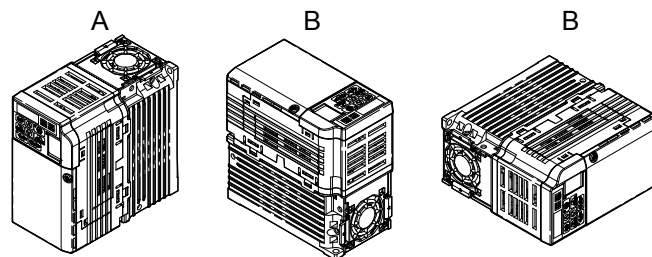

A – Correct

B – Incorrect

Figure 2.1 Correct Installation Orientation

Single Drive Installation

Figure 2.2 shows the required installation spacing to maintain sufficient space for airflow and wiring. Install the heatsink against a closed surface to avoid diverting cooling air around the heatsink.

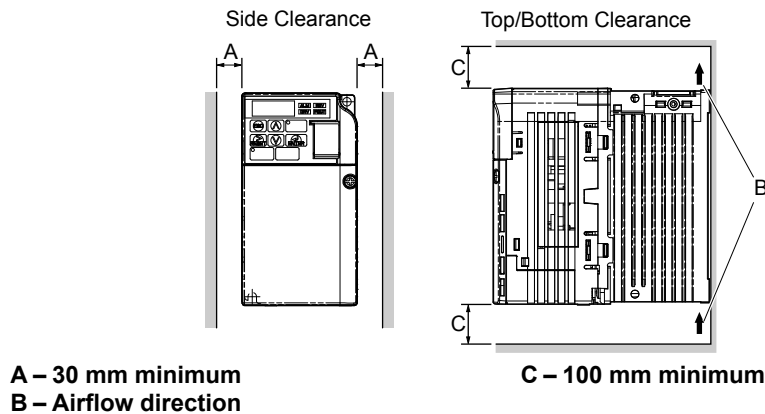

Figure 2.2 Correct Installation Spacing

Note: IP20/NEMA Type 1, IP00/Open-Chassis, and IP20/Open-Chassis models require the same amount of space above and below the drive for installation.

Multiple Drive Installation

When installing multiple drives into the same enclosure panel, mount the drives according to Figure 2.2. When mounting drives with a minimum side-by-side clearance of 2 mm according to Figure 2.3, derating must be considered and parameter L8-35 must be set. Refer to Parameter List on page 353.

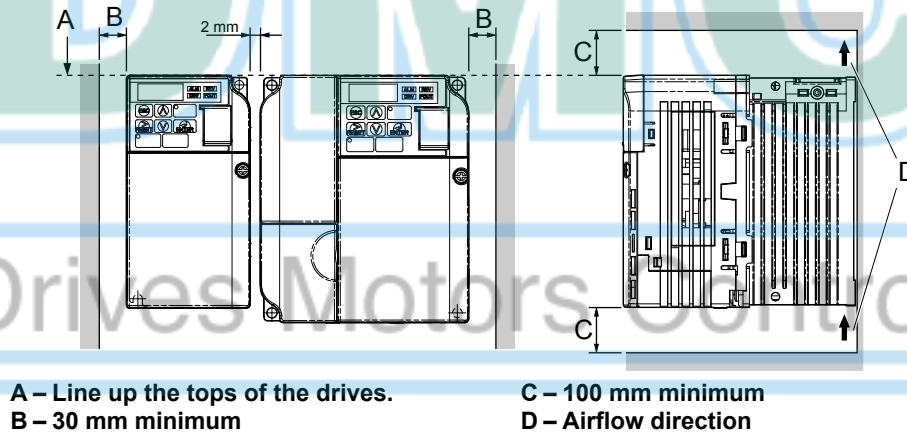

Figure 2.3 Space Between Drives (Side-by-Side Mounting)

Note: When installing drives of different heights in the same enclosure panel, the tops of the drives should line up. Leave space between the top and bottom of stacked drives for cooling fan replacement if required. Using this method, it is possible to replace the cooling fans later.

NOTICE: When mounting IP20/NEMA Type 1 enclosure drives side by side, the top covers of all drives must be removed as shown in Figure 2.4.

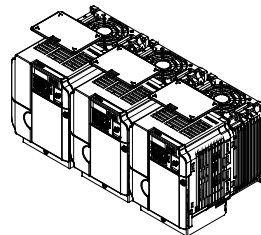

Figure 2.4 IP20/NEMA Type 1 Side-by-Side Mounting in Enclosure

2.2 Mechanical Installation

◆ Removing and Attaching the Protective Covers

Refer to *Electrical Installation on page 47*, for information regarding the removal and reattachment of protective covers.

◆ Exterior and Mounting Dimensions

Table 2.2 Drive Models and Types

Protective Design	Drive Model			Page
	Single-Phase 200 V Class	Three-Phase 200 V Class	Three-Phase 400 V Class	
IP20/Open-Chassis	BA0001B BA0002B BA0003B	2A0001B 2A0002B 2A0004B 2A0006B	–	41
	BA0006B BA0010B BA0012B BA0018B	2A0010B 2A0012B 2A0020B	4A0001B 4A0002B 4A0004B 4A0005B 4A0007B 4A0009B 4A0011B	41
IP00/Open-Chassis	–	2A0030A 2A0040A 2A0056A 2A0069A	4A0018A 4A0023A 4A0031A 4A0038A	43
IP20/NEMA Type 1	BA0001F BA0002F BA0003F	2A0001F 2A0002F 2A0004F	–	44
	BA0006F BA0010F BA0012F BA0018F	2A0006F 2A0010F 2A0012F 2A0020F	4A0001F 4A0002F 4A0004F 4A0005F 4A0007F 4A0009F 4A0011F	44
	–	2A0030F 2A0040F 2A0056F 2A0069F	4A0018F 4A0023F 4A0031F 4A0038F	46

Note: Refer to *Specifications on page 341* for information on the amount of heat generated by the drive and appropriate cooling methods.

■ IP20/Open-Chassis Drives

Table 2.3 IP20/Open-Chassis (without an EMC filter)

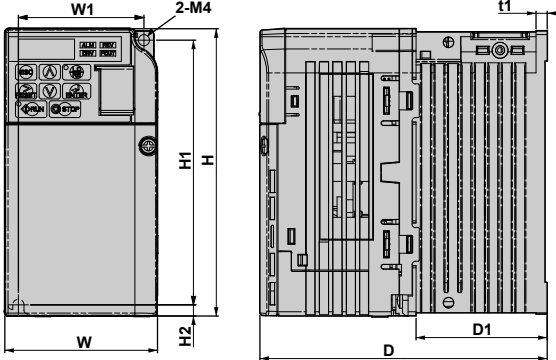

Voltage Class	Drive Model	Dimensions mm (in)								
		W	H	D	W1	H1	H2	D1	t1	Wt. kg (lb.)
Single-Phase 200 V Class	BA0001B	68 (2.68)	128 (5.04)	76 (2.99)	56 (2.20)	118 (4.65)	5 (0.20)	6.5 (0.26)	3 (0.12)	0.6 (1.3)
	BA0002B	68 (2.68)	128 (5.04)	76 (2.99)	56 (2.20)	118 (4.65)	5 (0.20)	6.5 (0.26)	3 (0.12)	0.6 (1.3)
	BA0003B	68 (2.68)	128 (5.04)	118 (4.65)	56 (2.20)	118 (4.65)	5 (0.20)	38.5 (1.52)	5 (0.20)	1.0 (2.2)
Three-Phase 200 V Class	2A0001B	68 (2.68)	128 (5.04)	76 (2.99)	56 (2.20)	118 (4.65)	5 (0.20)	6.5 (0.26)	3 (0.12)	0.6 (1.3)
	2A0002B	68 (2.68)	128 (5.04)	76 (2.99)	56 (2.20)	118 (4.65)	5 (0.20)	6.5 (0.26)	3 (0.12)	0.6 (1.3)
	2A0004B	68 (2.68)	128 (5.04)	108 (4.25)	56 (2.20)	118 (4.65)	5 (0.20)	38.5 (1.52)	5 (0.20)	0.9 (2.0)
	2A0006B	68 (2.68)	128 (5.04)	128 (5.04)	56 (2.20)	118 (4.65)	5 (0.20)	58.5 (2.30)	5 (0.20)	1.1 (2.4)

Table 2.4 IP20/Open-Chassis (without an EMC filter)

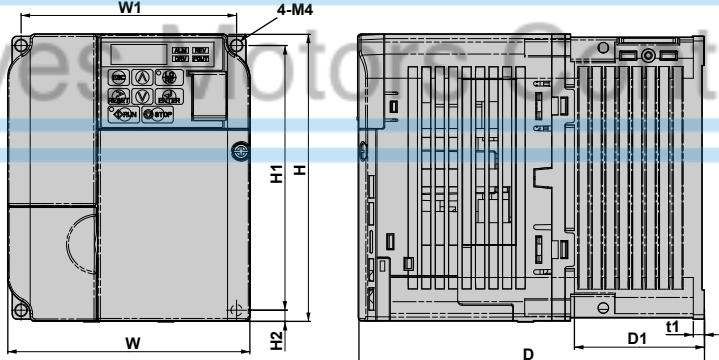

Voltage Class	Drive Model	Dimensions mm (in)								
		W	H	D	W1	H1	H2	D1	t1	Wt. kg (lb.)
Single-Phase 200 V Class	BA0006B	108 (4.25)	128 (5.04)	137.5 (5.41)	96 (3.78)	118 (4.65)	5 (0.20)	58 (2.28)	5 (0.20)	1.7 (3.7)
	BA0010B	108 (4.25)	128 (5.04)	154 (6.06)	96 (3.78)	118 (4.65)	5 (0.20)	58 (2.28)	5 (0.20)	1.8 (4.0)
	BA0012B	140 (5.51)	128 (5.04)	163 (6.42)	128 (5.04)	118 (4.65)	5 (0.20)	65 (2.56)	5 (0.20)	2.4 (5.3)
	BA0018B	170 (6.69)	128 (5.04)	180 (7.09)	158 (6.22)	118 (4.65)	5 (0.20)	65 (2.56)	5 (0.20)	3.0 (6.6)

2.2 Mechanical Installation

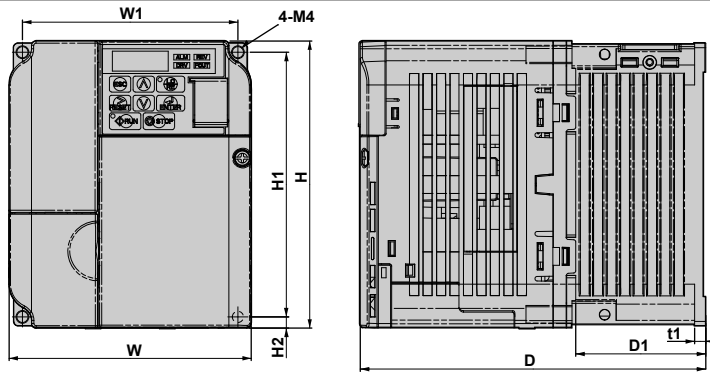

Voltage Class	Drive Model	Dimensions mm (in)								Wt. kg (lb.)
		W	H	D	W1	H1	H2	D1	t1	
Three-Phase 200 V Class	2A0010B	108 (4.25)	128 (5.04)	129 (5.08)	96 (3.78)	118 (4.65)	5 (0.20)	58 (2.28)	5 (0.20)	1.7 (3.7)
	2A0012B	108 (4.25)	128 (5.04)	137.5 (5.41)	96 (3.78)	118 (4.65)	5 (0.20)	58 (2.28)	5 (0.20)	1.7 (3.7)
	2A0020B	140 (5.51)	128 (5.04)	143 (5.63)	128 (5.04)	118 (4.65)	5 (0.20)	65 (2.56)	5 (0.20)	2.4 (5.3)
Three-Phase 400 V Class	4A0001B	108 (4.25)	128 (5.04)	81 (3.19)	96 (3.78)	118 (4.65)	5 (0.20)	10 (0.39)	5 (0.20)	1.0 (2.2)
	4A0002B	108 (4.25)	128 (5.04)	99 (3.90)	96 (3.78)	118 (4.65)	5 (0.20)	28 (1.10)	5 (0.20)	1.2 (2.6)
	4A0004B	108 (4.25)	128 (5.04)	137.5 (5.41)	96 (3.78)	118 (4.65)	5 (0.20)	58 (2.28)	5 (0.20)	1.7 (3.7)
	4A0005B	108 (4.25)	128 (5.04)	154 (6.06)	96 (3.78)	118 (4.65)	5 (0.20)	58 (2.28)	5 (0.20)	1.7 (3.7)
	4A0007B	108 (4.25)	128 (5.04)	154 (6.06)	96 (3.78)	118 (4.65)	5 (0.20)	58 (2.28)	5 (0.20)	1.7 (3.7)
	4A0009B	108 (4.25)	128 (5.04)	154 (6.06)	96 (3.78)	118 (4.65)	5 (0.20)	58 (2.28)	5 (0.20)	1.7 (3.7)
	4A0011B	140 (5.51)	128 (5.04)	143 (5.63)	128 (5.04)	118 (4.65)	5 (0.20)	65 (2.56)	5 (0.20)	2.4 (5.3)

Drives Motors Controls

■ IP00/Open-Chassis Drives

Table 2.5 IP00/Open-Chassis (without an EMC filter)

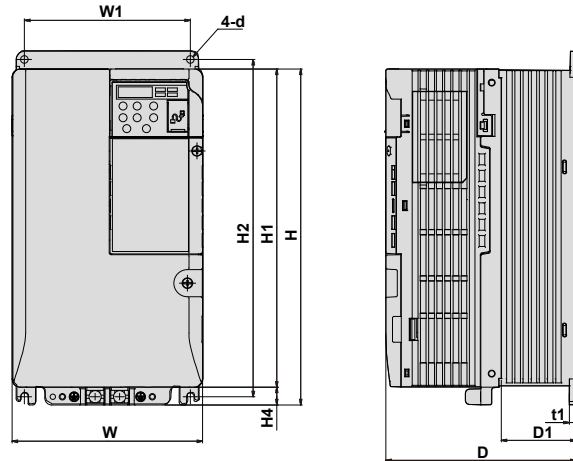

Voltage Class	Drive Model	Dimensions mm (in)										
		W	H	D	W1	H1	H2	H4	D1	d	t1	Wt. kg (lb)
Three-Phase 200 V Class	2A0030A	140 (5.5)	254 (9.7)	140 (5.5)	122 (4.8)	234 (9.2)	248 (9.8)	13 (0.5)	55 (2.2)	M5	5 (0.2)	3.8 (7.9)
	2A0040A	140 (5.5)	254 (9.7)	140 (5.5)	122 (4.8)	234 (9.2)	248 (9.8)	13 (0.5)	55 (2.2)	M5	5 (0.2)	3.8 (7.9)
	2A0056A	180 (7.1)	290 (11.2)	163 (6.4)	160 (6.3)	270 (10.6)	284 (11.2)	15 (0.6)	75 (3.0)	M5	5 (0.2)	5.5 (11.7)
	2A0069A	220 (8.7)	350 (13.2)	187 (7.4)	192 (7.6)	320 (12.6)	336 (13.2)	15 (0.6)	78 (3.1)	M6	5 (0.2)	9.2 (19.2)
Three-Phase 400 V Class	4A0018A	140 (5.5)	254 (9.7)	140 (5.5)	122 (4.8)	234 (9.2)	248 (9.8)	13 (0.5)	55 (2.2)	M5	5 (0.2)	3.8 (7.9)
	4A0023A	140 (5.5)	254 (9.7)	140 (5.5)	122 (4.8)	234 (9.2)	248 (9.8)	13 (0.5)	55 (2.2)	M5	5 (0.2)	3.8 (7.9)
	4A0031A	180 (7.1)	290 (11.2)	143 (5.6)	160 (6.3)	270 (10.6)	284 (11.2)	15 (0.6)	55 (2.2)	M5	5 (0.2)	5.2 (11.0)
	4A0038A	180 (7.1)	290 (11.2)	163 (6.4)	160 (6.3)	270 (10.6)	284 (11.2)	15 (0.6)	75 (3.0)	M5	5 (0.2)	5.5 (11.7)

Mechanical Installation

2.2 Mechanical Installation

■ IP20/NEMA Type 1 Drives

Table 2.6 IP20/NEMA Type 1 (without an EMC filter)

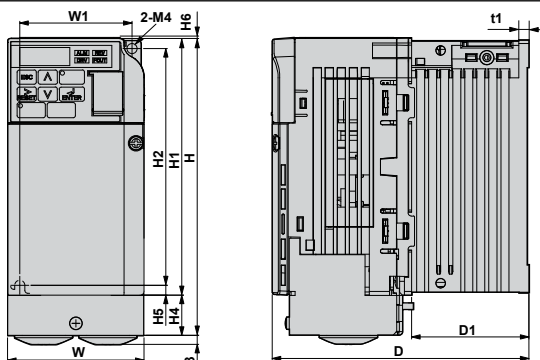

Voltage Class	Drive Model	Dimensions mm (in)												
		W	H	D	W1	H1	H2	H3	H4	H5	H6	D1	t1	Wt. kg (lb.)
Single-Phase 200 V Class	BA0001F	68 (2.68)	149.5 (5.89)	76 (2.99)	56 (2.20)	128 (5.03)	118 (4.65)	4 (0.16)	20 (0.79)	5 (0.20)	1.5 (0.06)	6.5 (0.26)	3 (0.12)	0.8 (1.8)
	BA0002F	68 (2.68)	149.5 (5.89)	76 (2.99)	56 (2.20)	128 (5.03)	118 (4.65)	4 (0.16)	20 (0.79)	5 (0.20)	1.5 (0.06)	6.5 (0.26)	3 (0.12)	0.8 (1.8)
	BA0003F	68 (2.68)	149.5 (5.89)	118 (4.65)	56 (2.20)	128 (5.03)	118 (4.65)	4 (0.16)	20 (0.79)	5 (0.20)	1.5 (0.06)	38.5 (1.54)	5 (0.20)	1.2 (2.6)
Three-Phase 200 V Class	2A0001F	68 (2.68)	149.5 (5.89)	76 (2.99)	56 (2.20)	128 (5.03)	118 (4.65)	4 (0.16)	20 (0.79)	5 (0.20)	1.5 (0.06)	6.5 (0.26)	3 (0.12)	0.8 (1.8)
	2A0002F	68 (2.68)	149.5 (5.89)	76 (2.99)	56 (2.20)	128 (5.03)	118 (4.65)	4 (0.16)	20 (0.79)	5 (0.20)	1.5 (0.06)	6.5 (0.26)	3 (0.12)	0.8 (1.8)
	2A0004F	68 (2.68)	149.5 (5.89)	108 (4.25)	56 (2.20)	128 (5.03)	118 (4.65)	4 (0.16)	20 (0.79)	5 (0.20)	1.5 (0.06)	38.5 (1.54)	5 (0.20)	1.1 (2.4)
	2A0006F	68 (2.68)	149.5 (5.89)	128 (5.04)	56 (2.20)	128 (5.03)	118 (4.65)	4 (0.16)	20 (0.79)	5 (0.20)	1.5 (0.06)	58.5 (2.32)	5 (0.20)	1.3 (2.9)

Table 2.7 IP20/NEMA Type 1 (without an EMC filter)

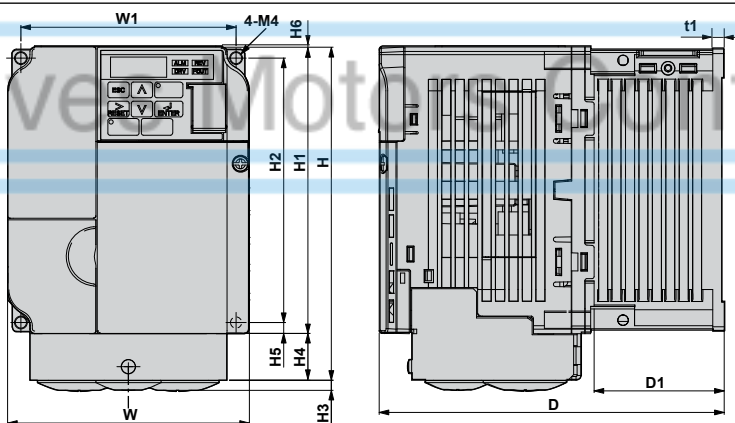

Voltage Class	Drive Model	Dimensions mm (in)												
		W	H	D	W1	H1	H2	H3	H4	H5	H6	D1	t1	Wt. kg (lb.)
Single-Phase 200 V Class	BA0006F	108 (4.25)	149.5 (5.89)	137.5 (5.41)	96 (3.78)	128 (5.03)	118 (4.65)	4 (0.16)	20 (0.79)	5 (0.20)	1.5 (0.06)	58 (2.28)	5 (0.20)	1.9 (4.2)
	BA0010F	108 (4.25)	149.5 (5.89)	154 (6.06)	96 (3.78)	128 (5.03)	118 (4.65)	4 (0.16)	20 (0.79)	5 (0.20)	1.5 (0.06)	58 (2.28)	5 (0.20)	2.0 (4.4)
	BA0012F	140 (5.51)	153 (6.02)	163 (6.42)	128 (5.04)	128 (5.03)	118 (4.65)	4.8 (0.19)	20 (0.79)	5 (0.20)	5 (0.20)	65 (2.56)	5 (0.20)	2.6 (5.7)
	BA0018F	170 (6.69)	171 (6.73)	180 (7.08)	158 (6.22)	133 (5.23)	118 (4.64)	4.8 (0.19)	38 (1.50)	5 (0.20)	5 (0.20)	65 (2.56)	5 (0.20)	3.3 (7.3)

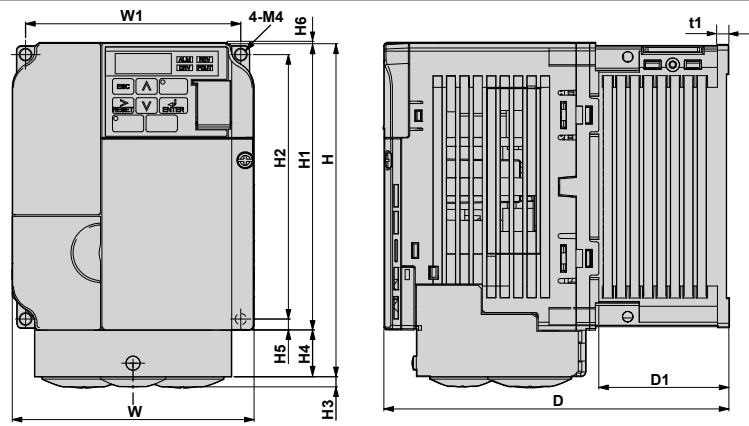

Voltage Class	Drive Model	Dimensions mm (in)												
		W	H	D	W1	H1	H2	H3	H4	H5	H6	D1	t1	Wt. kg (lb.)
Three-Phase 200 V Class	2A0010F	108 (4.25)	149.5 (5.89)	129 (5.08)	96 (3.78)	128 (5.03)	118 (4.65)	4 (0.16)	20 (0.79)	5 (0.20)	1.5 (0.06)	58 (2.28)	5 (0.20)	1.9 (4.2)
	2A0012F	108 (4.25)	149.5 (5.89)	137.5 (5.41)	96 (3.78)	128 (5.03)	118 (4.65)	4 (0.16)	20 (0.79)	5 (0.20)	1.5 (0.06)	58 (2.28)	5 (0.20)	1.9 (4.2)
	2A0020F	140 (5.51)	153 (6.02)	143 (5.63)	128 (5.04)	128 (5.03)	118 (4.65)	4.8 (0.19)	20 (0.79)	5 (0.20)	5 (0.20)	65 (2.56)	5 (0.20)	2.6 (5.7)
Three-Phase 400 V Class	4A0001F	108 (4.25)	149.5 (5.89)	81 (3.19)	96 (3.78)	128 (5.03)	118 (4.65)	4 (0.16)	20 (0.79)	5 (0.20)	1.5 (0.06)	10 (0.39)	5 (0.20)	1.2 (2.6)
	4A0002F	108 (4.25)	149.5 (5.89)	99 (3.90)	96 (3.78)	128 (5.03)	118 (4.65)	4 (0.16)	20 (0.79)	5 (0.20)	1.5 (0.06)	28 (1.10)	5 (0.20)	1.4 (3.1)
	4A0004F	108 (4.25)	149.5 (5.89)	137.5 (5.41)	96 (3.78)	128 (5.03)	118 (4.65)	4 (0.16)	20 (0.79)	5 (0.20)	1.5 (0.06)	58 (2.28)	5 (0.20)	1.9 (4.2)
	4A0005F	108 (4.25)	149.5 (5.89)	154 (6.06)	96 (3.78)	128 (5.03)	118 (4.65)	4 (0.16)	20 (0.79)	5 (0.20)	1.5 (0.06)	58 (2.28)	5 (0.20)	1.9 (4.2)
	4A0007F	108 (4.25)	149.5 (5.89)	154 (6.06)	96 (3.78)	128 (5.03)	118 (4.65)	4 (0.16)	20 (0.79)	5 (0.20)	1.5 (0.06)	58 (2.28)	5 (0.20)	1.9 (4.2)
	4A0009F	108 (4.25)	149.5 (5.89)	154 (6.06)	96 (3.78)	128 (5.03)	118 (4.65)	4 (0.16)	20 (0.79)	5 (0.20)	1.5 (0.06)	58 (2.28)	5 (0.20)	1.9 (4.2)
	4A0011F	140 (5.51)	153 (6.02)	143 (5.63)	128 (5.04)	128 (5.03)	118 (4.65)	4.8 (0.19)	20 (0.79)	5 (0.20)	5 (0.20)	65 (2.56)	5 (0.20)	2.6 (5.7)

Mechanical Installation

2.2 Mechanical Installation

Table 2.8 IP20/NEMA Type 1 (without an EMC filter)

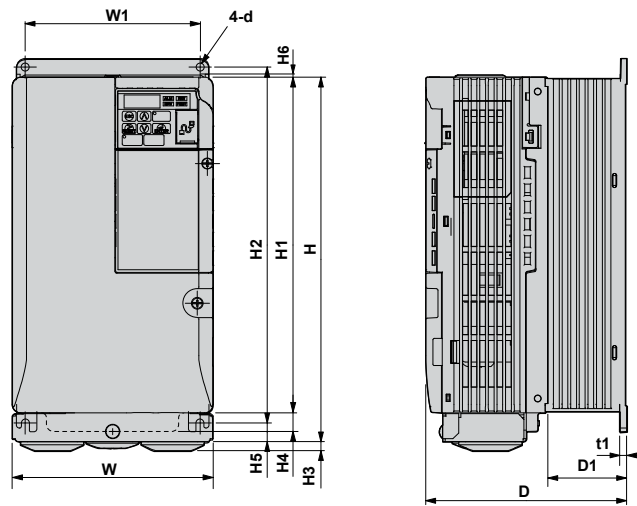

Voltage Class	Drive Model	Dimensions mm (in)													Wt. kg (lb.)
		W	H	D	W1	H1	H2	H3	H4	H5	H6	D1	t1	d	
Three-Phase 200 V Class	2A0030F	140 (5.51)	254 (10.00)	140 (5.51)	122 (4.80)	234 (9.21)	248 (9.76)	6 (0.24)	13 (0.51)	13 (0.51)	1.5 (0.06)	55 (2.17)	5 (0.20)	M5	3.8 (8.4)
	2A0040F	140 (5.51)	254 (10.00)	140 (5.51)	122 (4.80)	234 (9.21)	248 (9.76)	6 (0.24)	13 (0.51)	13 (0.51)	1.5 (0.06)	55 (2.17)	5 (0.20)	M5	3.8 (8.4)
	2A0056F	180 (7.09)	290 (11.42)	163 (6.42)	160 (6.30)	270 (10.63)	284 (11.18)	6 (0.24)	15 (0.59)	13 (0.51)	1.5 (0.06)	75 (2.95)	5 (0.20)	M5	5.5 (12.1)
	2A0069F	220 (8.66)	350 (13.78)	187 (7.36)	192 (7.56)	320 (12.60)	336 (13.23)	7 (0.28)	15 (0.59)	22 (0.87)	1.5 (0.06)	78 (3.07)	5 (0.20)	M6	9.2 (20.3)
Three-Phase 400 V Class	4A0018F	140 (5.51)	254 (10.00)	140 (5.51)	122 (4.80)	234 (9.21)	248 (9.76)	6 (0.24)	13 (0.51)	13 (0.51)	1.5 (0.06)	55 (2.17)	5 (0.20)	M5	3.8 (8.4)
	4A0023F	140 (5.51)	254 (10.00)	140 (5.51)	122 (4.80)	234 (9.21)	248 (9.76)	6 (0.24)	13 (0.51)	13 (0.51)	1.5 (0.06)	55 (2.17)	5 (0.20)	M5	3.8 (8.4)
	4A0031F	180 (7.09)	290 (11.42)	143 (5.63)	160 (6.30)	270 (10.63)	284 (11.18)	6 (0.24)	15 (0.59)	13 (0.51)	1.5 (0.06)	55 (2.17)	5 (0.20)	M5	5.2 (11.5)
	4A0038F	180 (7.09)	290 (11.42)	163 (6.42)	160 (6.30)	270 (10.63)	284 (11.18)	6 (0.24)	13 (0.51)	13 (0.51)	1.5 (0.06)	75 (2.95)	5 (0.20)	M5	5.5 (12.1)

Electrical Installation

This chapter explains proper procedures for wiring the control circuit terminals, motor and power supply.

3.1	SECTION SAFETY	48
3.2	STANDARD CONNECTION DIAGRAM	50
3.3	MAIN CIRCUIT CONNECTION DIAGRAM	53
3.4	TERMINAL BLOCK CONFIGURATION	54
3.5	PROTECTIVE COVERS	55
3.6	MAIN CIRCUIT WIRING	58
3.7	CONTROL CIRCUIT WIRING	63
3.8	I/O CONNECTIONS	68
3.9	MAIN FREQUENCY REFERENCE	70
3.10	MEMOBUS/MODBUS TERMINATION	71
3.11	BRAKING RESISTOR	72
3.12	WIRING CHECKLIST	74

Drives Motors Controls

3.1 Section Safety

DANGER

Electrical Shock Hazard

Do not connect or disconnect wiring while the power is on.

Failure to comply will result in death or serious injury.

WARNING

Electrical Shock Hazard

Do not operate equipment with covers removed.

Failure to comply could result in death or serious injury.

The diagrams in this section may show drives without covers or safety shields to show details. Be sure to reinstall covers or shields before operating the drives and run the drives according to the instructions described in this manual.

Always ground the motor-side grounding terminal.

Improper equipment grounding could result in death or serious injury by contacting the motor case.

Do not perform work on the drive while wearing loose clothing, jewelry or without eye protection.

Failure to comply could result in death or serious injury.

Remove all metal objects such as watches and rings, secure loose clothing, and wear eye protection before beginning work on the drive.

Do not remove covers or touch circuit boards while the power is on.

Failure to comply could result in death or serious injury.

Do not allow unqualified personnel to perform work on the drive.

Failure to comply could result in death or serious injury.

Installation, maintenance, inspection, and servicing must be performed only by authorized personnel familiar with installation, adjustment, and maintenance of AC drives.

Do not touch any terminals before the capacitors have fully discharged.

Failure to comply could result in death or serious injury.

Before wiring terminals, disconnect all power to the equipment. The internal capacitor remains charged even after the power supply is turned off. The charge indicator LED will extinguish when the DC bus voltage is below 50 Vdc. To prevent electric shock, wait at least five minutes after all indicators are off and measure the DC bus voltage level to confirm safe level.

Fire Hazard

Tighten all terminal screws to the specified tightening torque.

Loose electrical connections could result in death or serious injury by fire due to overheating of electrical connections.

Do not use improper combustible materials.

Failure to comply could result in death or serious injury by fire.

Attach the drive to metal or other noncombustible material.

Do not use an improper voltage source.

Failure to comply could result in death or serious injury by fire.

Verify that the rated voltage of the drive matches the voltage of the incoming power supply before applying power.

Always use a thermal overload relay or an over-temperature contact when using a braking resistor.

Failure to comply could result in death or serious injury by fire.

Power to the drive should be interrupted when the relay is triggered.

NOTICE

Observe proper electrostatic discharge procedures (ESD) when handling the drive and circuit boards.

Failure to comply may result in ESD damage to the drive circuitry.

Never connect or disconnect the motor from the drive while the drive is outputting voltage.

Improper equipment sequencing could result in damage to the drive.

Do not use unshielded cable for control wiring.

Failure to comply may cause electrical interference resulting in poor system performance. Use shielded, twisted-pair wires and ground the shield to the ground terminal of the drive.

Check all the wiring to ensure that all connections are correct after installing the drive and connecting any other devices.

Failure to comply could result in damage to the drive.

Do not modify the drive circuitry.

Failure to comply could result in damage to the drive and will void warranty.

Yaskawa is not responsible for any modification of the product made by the user. This product must not be modified.

Route motor leads U/T1, V/T2, and W/T3 separate from other leads to reduce possible interference-related issues.

Failure to comply may result in abnormal operation of drive and nearby equipment.

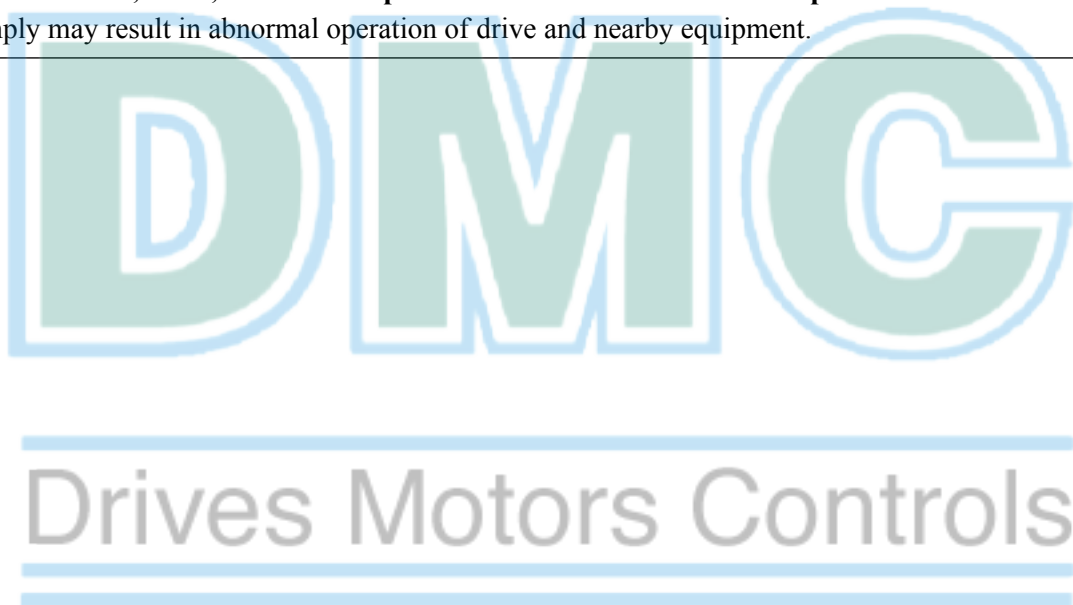

3.2 Standard Connection Diagram

Connect the drive and peripheral devices as shown in [Figure 3](#). It is possible to run the drive via the digital operator without connecting digital I/O wiring. This section does not discuss drive operation; [Refer to Start-Up Programming & Operation on page 77](#) for instructions on operating the drive.

NOTICE: Inadequate branch short circuit protection could result in damage to the drive. Install adequate branch circuit short circuit protection per applicable codes. The drive is suitable for circuits capable of delivering not more than 31,000 RMS symmetrical amperes, 240 Vac maximum (200 V Class) and 480 Vac maximum (400 V Class).

NOTICE: When the wiring distance is greater than 100 meters, pay special attention to the motor insulation voltage or use a drive duty motor. Failure to comply could lead to motor insulation breakdown.

NOTICE: Correctly set Sink/Source jumper S3 for internal power supply. Failure to comply may result in damage to the drive. [Refer to I/O Connections on page 68](#) for details.

NOTICE: Do not connect AC control circuit ground to drive enclosure. Improper drive grounding can cause control circuit malfunction.

NOTICE: Route motor leads U/T1, V/T2, and W/T3 separate from all other leads to reduce possible interference related issues. Failure to comply may result in abnormal operation of drive and nearby equipment.

NOTICE: The minimum load for the multi-function relay output MA-MB-MC is 10 mA. If a circuit requires less than 10 mA (reference value), connect it to a photocoupler output (P1, P2, PC). Improper application of peripheral devices could result in damage to the photocoupler output of the drive.



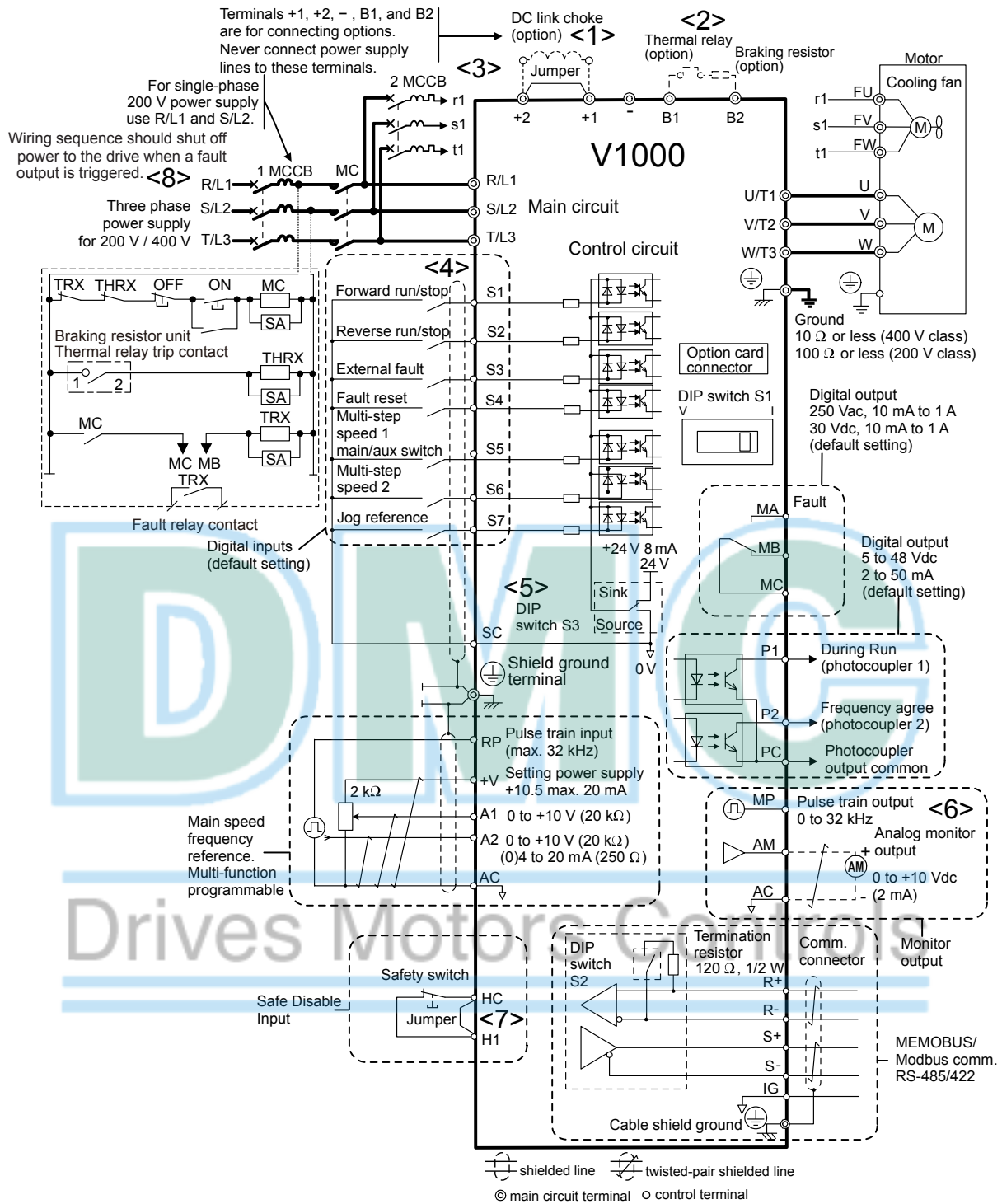

Figure 3.1 Drive Standard Connection Diagram

- <1> Remove the jumper when installing an optional DC link choke.
- <2> The MC on the input side of the main circuit should open when the thermal relay is triggered.
- <3> Self-cooled motors do not require separate cooling fan motor wiring.
- <4> Connected using sequence input signal (S1 to S7) from NPN transistor; Default: sink mode (0 V com).
- <5> Use only a +24 V internal power supply in sinking mode; the source mode requires an external power supply. *Refer to I/O Connections on page 68* for details.
- <6> Monitor outputs work with devices such as analog frequency meters, ammeters, voltmeters and wattmeters; they are not intended for use as a feedback-type of signal.

3.2 Standard Connection Diagram

- <7> Disconnect the wire jumper between HC and H1 when utilizing the safety input. *Refer to Wiring Procedure on page 66* for details on removing the jumper. The wire length for the Safe Disable input should not exceed 30 m. Use only dry contacts on safety inputs HC-H1. External power supplies are not permitted.
- <8> Note that if the drive is set to trigger a fault output whenever the fault restart function is activated (L5-02 = 1), then a sequence to interrupt power when a fault occurs will result in shutting off the power to the drive as the drive attempts to restart itself. The default setting for L5-02 is 0 (fault output active during restart attempt).

WARNING! Sudden Movement Hazard. Do not close the wiring for the control circuit unless the multifunction input terminal parameter is properly set (S5 for 3-Wire; H1-05 = "0"). Improper sequencing of run/stop circuitry could result in death or serious injury from moving equipment.

WARNING! Sudden Movement Hazard. Ensure start/stop and safety circuits are wired properly and in the correct state before energizing the drive. Failure to comply could result in death or serious injury from moving equipment. When programmed for 3-Wire control, a momentary closure on terminal S1 may cause the drive to start.

WARNING! When 3-Wire sequence is used, set the drive to 3-Wire sequence before wiring the control terminals and ensure parameter b1-17 is set to 0 (drive does not accept a run command at power up (default)). If the drive is wired for 3-Wire sequence but set up for 2-Wire sequence (default) and if parameter b1-17 is set to 1 (drive accepts a Run command at power up), the motor will rotate in reverse direction at power up of the drive and may cause injury.

WARNING! When the application preset function is executed (or A1-06 is set to any value other than 0) the drive I/O terminal functions change. This may cause unexpected operation and potential damage to equipment or injury.

Figure 3.2 illustrates an example of a 3-Wire sequence.

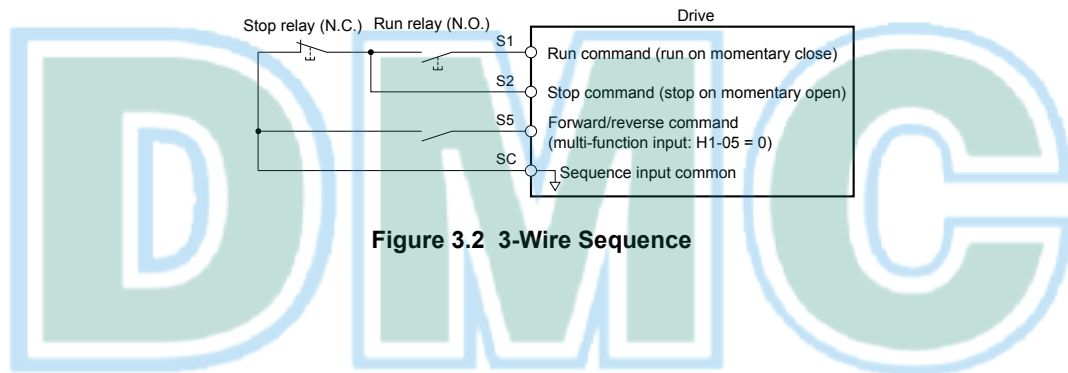

Figure 3.2 3-Wire Sequence

Drives Motors Controls

3.3 Main Circuit Connection Diagram

Refer to diagrams in this section for the Main Circuit wiring connections. Connections may vary based on drive capacity. The main circuit DC power supply powers the control circuit.

NOTICE: Do not use the negative DC bus terminal “-” as a ground terminal. This terminal is at high voltage DC potential. Improper wiring connections could result in damage to the drive.

◆ Single-Phase 200 V Class Models BA0001 to BA0018

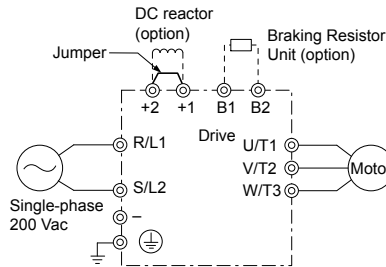

Figure 3.3 Connecting Single-Phase Main Circuit Terminals

NOTICE: Do not connect T/L3 terminal when using single-phase power supply input. Incorrect wiring may damage the drive.

◆ Three-Phase 200 V Class Models 2A0001 to 2A0069 Three-Phase 400 V Class Models 4A0001 to 4A0038

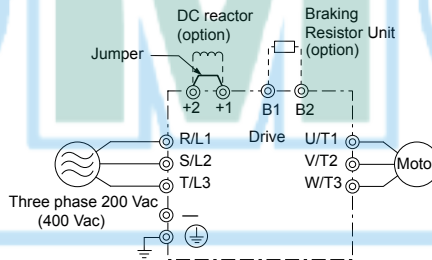

Figure 3.4 Connecting Three-Phase Main Circuit Terminals

3.4 Terminal Block Configuration

The figures in this section provide illustrations of the main circuit terminal block configurations of the different drive sizes.

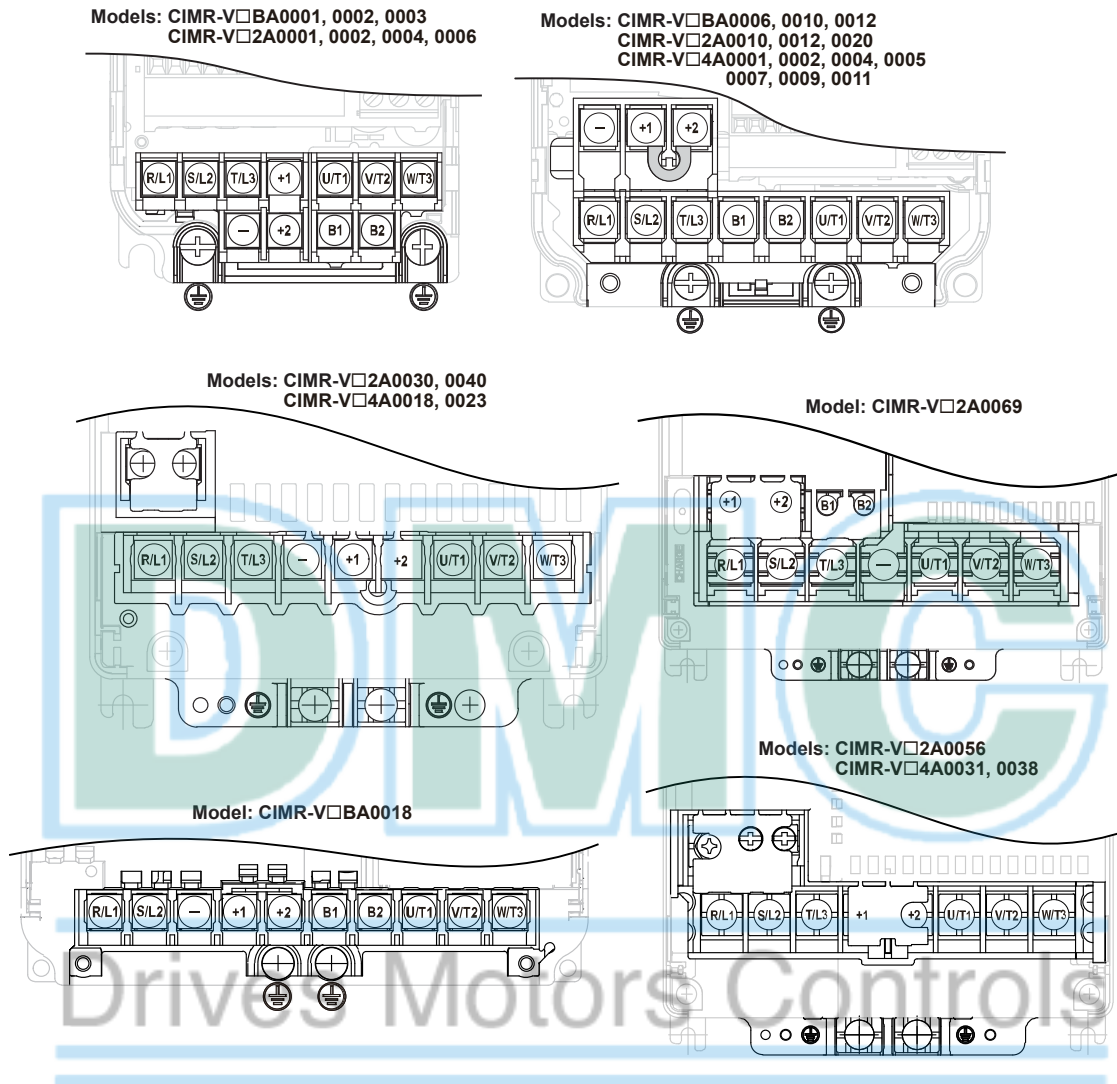

Figure 3.5 Main Circuit Terminal Block Configurations

3.5 Protective Covers

Follow the procedure below to remove the protective covers before wiring the drive and to reattach the covers after wiring is complete.

◆ IP20/Open-Chassis Front and Bottom Cover Removal and Installation

■ Removing the Protective Covers

1. Loosen the screw that locks the front cover in place to remove.

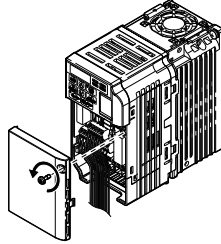

Figure 3.6 Remove the Front Cover on an IP20/Open-Chassis Drive

2. Apply pressure to the tabs on each side of the terminal cover. Pull the terminal cover away from the drive while pushing in on the tabs to pull the cover free.

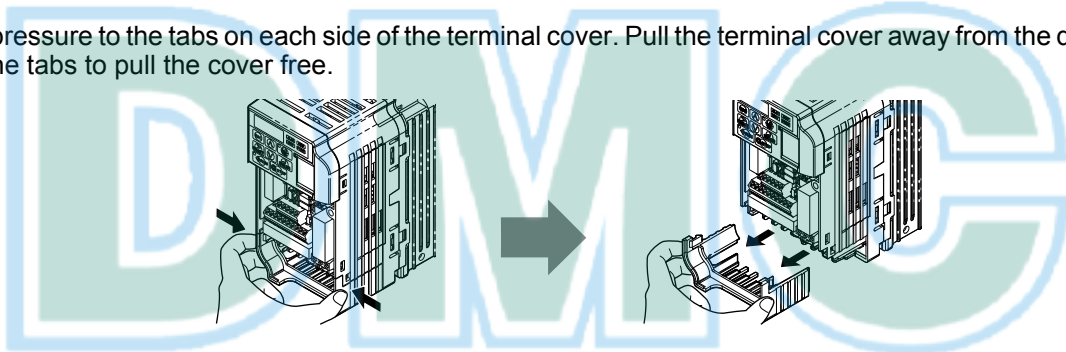

Figure 3.7 Remove the Terminal Cover on an IP20/Open-Chassis Drive

■ Reattaching the Protective Covers

Properly connect all wiring and route power wiring away from control signal wiring. Reattach all protective covers when wiring is complete. Apply only a small amount of pressure to lock the cover back into place.

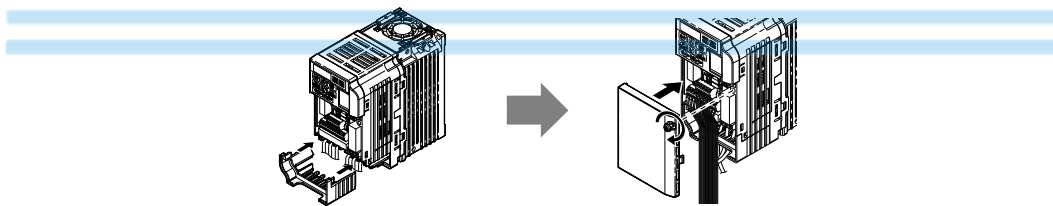

Figure 3.8 Reattach the Protective Covers on an IP20/Open-Chassis Drive

◆ IP20/NEMA Type 1 Front and Bottom Cover Removal and Installation

■ Removing the Protective Covers on an IP20/NEMA 1, UL Type 1 Design

1. Loosen the screw on the front cover to remove the front cover.

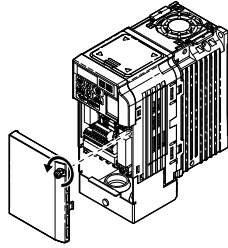

Figure 3.9 Remove the Front Cover on an IP20/NEMA 1, UL Type 1 Drive

2. Loosen the screw on the terminal cover to remove the terminal cover and expose the conduit bracket.

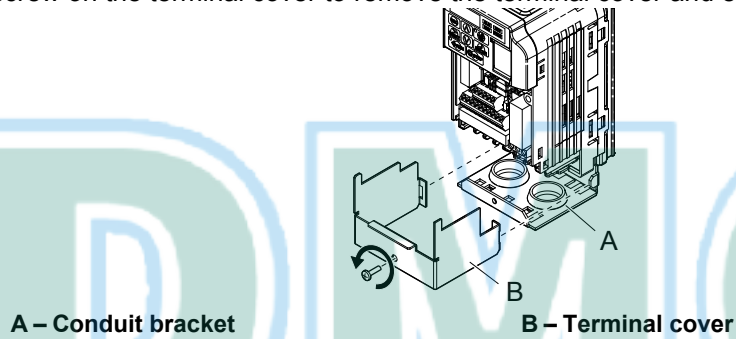
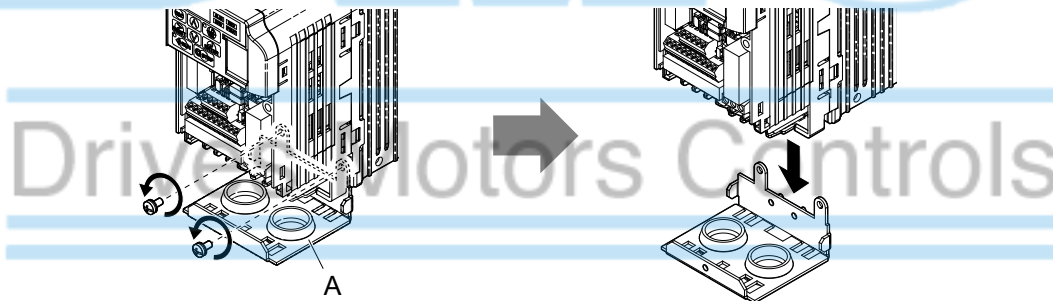

Figure 3.10 Remove the Terminal Cover on an IP20/NEMA 1, UL Type 1 Drive

3. Loosen two screws attaching the conduit bracket to remove.



A – Conduit bracket

Figure 3.11 Remove the Conduit Bracket on an IP20/NEMA 1, UL Type 1 Drive

■ Reattaching the Protective Covers

Pass power wiring and control signal wiring through the exit holes on the bottom of the conduit bracket of the drive. Place power wiring and control signal wiring in separate conduits. Properly connect all wiring after installing the drive and connecting other devices. Reattach all protective covers when wiring is complete.

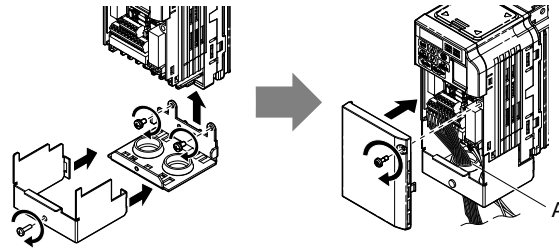

A –Pass power wiring and control signal wiring through different exit holes at the bottom of the drive.

Figure 3.12 Reattach the Protective Covers and Conduit Bracket on an IP20/NEMA 1, UL Type 1 Drive

◆ IP20/NEMA Type 1 Top Cover Removal and Installation

To improve the ambient temperature rating of a NEMA Type 1 drive from 40 °C to 50 °C or to mount NEMA Type 1 drives side-by-side, the top cover can be removed. Remove the top cover and set L8-35 to “2”.

Refer to Temperature Derating on page 351 for details.

Note: Removing the top cover of a NEMA Type 1 drive converts the drive to an IP20/Open-Chassis rating, and the drive will no longer have a NEMA Type 1 rating.

■ Removing the Top Cover

Insert the blade of a straight-edge screwdriver into the opening of the top cover. Gently lift up on the front cover as indicated by the arrow in [Figure 3.13](#) to remove it from the drive.

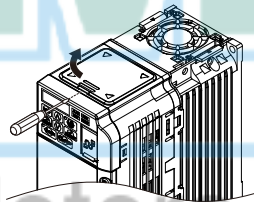

Figure 3.13 Removing the Top Cover

■ Reattaching the Top Cover

Align the connection tabs on the underside of the top cover with the connection tabs on the drive. Pinch in on the top cover to click the cover into place on the drive.

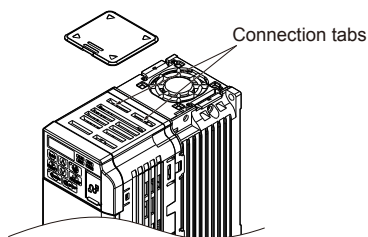

Figure 3.14 Reattaching the Top Cover

3.6 Main Circuit Wiring

This section describes the functions, specifications, and procedures required to safely and properly wire the main circuit of the drive.

NOTICE: Do not solder the ends of wire connections to the drive. Soldered wiring connections can loosen over time. Improper wiring practices could result in drive malfunction due to loose terminal connections.

◆ Main Circuit Terminal Functions

Table 3.1 Main Circuit Terminal Functions

Terminal	Type	Function	Reference
R/L1	Main circuit power supply input	Connects line power to the drive. Drives with single-phase 200 V input power use terminals R/L1 and S/L2 only. Do NOT use T/L3.	53
S/L2			
T/L3			
U/T1	Drive output	Connects to the motor.	61
V/T2			
W/T3			
B1	Braking resistor	Available for connecting a braking resistor or the braking resistor unit option.	72
B2			
⊕1	DC link choke connection	These terminals are shorted at shipment. Remove the shorting bar between ⊕1 and ⊕2 when connecting a DC link choke to this terminal.	331
⊕2			
⊕1	DC power supply input	For connecting a DC power supply.	-
⊖			
⊕ (2 terminals)	Ground	Grounding Terminal	62

◆ Wire Gauges and Tightening Torques

Select the appropriate wires and crimp terminals from [Table 3.2](#) through [Table 3.4](#).

- Note:**
- Wire gauge recommendations based on drive continuous current ratings using 75 °C 600 Vac vinyl-sheathed wire assuming ambient temperature within 30 °C and wiring distance shorter than 100 m.
 - Terminals ⊕1, ⊕2, ⊖, B1 and B2 are for connecting optional devices such as a braking resistor. Do not connect other non-specified devices to these terminals.

- Consider the amount of voltage drop when selecting wire gauges. Increase the wire gauge when the voltage drop is greater than 2% of motor rated voltage. Ensure the wire gauge is suitable for the terminal block. Use the following formula to calculate the amount of voltage drop:
- Line drop voltage (V) = $\sqrt{3}$ x wire resistance (Ω/km) x wire length (m) x current (A) x 10⁻³
- Refer to instruction manual TOBP C720600 00 for braking unit or braking resistor unit wire gauges.
- Refer to [UL Standards Compliance on page 474](#) for information on UL compliance.

■ Single-Phase 200 V Class

Table 3.2 Wire Gauge and Torque Specifications

Drive Model	Terminal	Recomm. Gauge AWG, kcmil	Wire Range AWG, kcmil	Screw Size	Tightening Torque N•m (lb.in.)
BA0001 BA0002 BA0003	R/L1, S/L2, T/L3	14	18 to 14	M3.5	0.8 to 1.0 (7.1 to 8.9)
	U/T1, V/T2, W/T3	14	18 to 14		
	⊖, ⊕1, ⊕2	-	18 to 14		
	B1, B2	-	18 to 14		
	⊕	14	18 to 14		
BA0006	R/L1, S/L2, T/L3	12	14 to 10	M4	1.2 to 1.5 (10.6 to 13.3)
	U/T1, V/T2, W/T3	14	14 to 10		
	⊖, ⊕1, ⊕2	-	14 to 10		
	B1, B2	-	14 to 10		
	⊕	10	14 to 10		

Drive Model	Terminal	Recomm. Gauge AWG, kcmil	Wire Range AWG, kcmil	Screw Size	Tightening Torque N·m (lb.in.)
BA0010	R/L1, S/L2, T/L3	10	14 to 10	M4	1.2 to 1.5 (10.6 to 13.3)
	U/T1, V/T2, W/T3	14	14 to 10		
	⊖, ⊕1, ⊕2	–	14 to 10		
	B1, B2	–	14 to 10		
	⊕	10	14 to 10		
BA0012	R/L1, S/L2, T/L3	10	14 to 10	M4	2.3 to 2.5 (20.4 to 22.1)
	U/T1, V/T2, W/T3	14	14 to 10		
	⊖, ⊕1, ⊕2	–	14 to 10		
	B1, B2	–	14 to 10		
	⊕	10	14 to 10		
BA0018	R/L1, S/L2, T/L3	8	12 to 8	M5	2.3 to 2.5 (20.4 to 22.1)
	U/T1, V/T2, W/T3	10	12 to 8		
	⊖, ⊕1, ⊕2	–	12 to 8		
	B1, B2	–	12 to 8		
	⊕	8	12 to 8		2 to 2.5 (17.7 to 22.1)

■ Three-Phase 200 V Class

Table 3.3 Wire Gauge and Torque Specifications

Drive Model	Terminal	Recomm. Gauge AWG, kcmil	Wire Range AWG, kcmil	Screw Size	Tightening Torque N·m (lb.in.)
2A0001 2A0002 2A0004 2A0006	R/L1, S/L2, T/L3	14	18 to 14	M3.5	0.8 to 1.0 (7.1 to 8.9)
	U/T1, V/T2, W/T3	14	18 to 14		
	⊖, ⊕1, ⊕2	–	18 to 14		
	B1, B2	–	18 to 14		
	⊕	14	18 to 14		
2A0010	R/L1, S/L2, T/L3	12	14 to 10	M4	1.2 to 1.5 (10.6 to 13.3)
	U/T1, V/T2, W/T3	14	14 to 10		
	⊖, ⊕1, ⊕2	–	14 to 10		
	B1, B2	–	14 to 10		
	⊕	10	14 to 10		
2A0012	R/L1, S/L2, T/L3	12	14 to 10	M4	1.2 to 1.5 (10.6 to 13.3)
	U/T1, V/T2, W/T3	14	14 to 10		
	⊖, ⊕1, ⊕2	–	14 to 10		
	B1, B2	–	14 to 10		
	⊕	10	14 to 10		
2A0020	R/L1, S/L2, T/L3	10	14 to 10	M4	1.2 to 1.5 (10.6 to 13.3)
	U/T1, V/T2, W/T3	10	14 to 10		
	⊖, ⊕1, ⊕2	–	14 to 10		
	B1, B2	–	14 to 10		
	⊕	10	14 to 10		
2A0030	R/L1, S/L2, T/L3	8	10 to 6	M4	2.1 to 2.3 (18.6 to 20.4)
	U/T1, V/T2, W/T3	8	10 to 6		
	⊖, ⊕1, ⊕2	–	10 to 6		
	B1, B2	–	14 to 10		
	⊕	8	10 to 6	M5	2 to 2.5 (17.7 to 22.1)

3.6 Main Circuit Wiring

Drive Model	Terminal	Recomm. Gauge AWG, kcmil	Wire Range AWG, kcmil	Screw Size	Tightening Torque N•m (lb.in.)
2A0040	R/L1, S/L2, T/L3	6	10 to 6	M4	2.1 to 2.3 (18.6 to 20.4)
	U/T1, V/T2, W/T3	8	10 to 6		
	⊖, ⊕1, ⊕2	–	10 to 6		
	B1, B2	–	14 to 10		
	⊕	6	10 to 6	M5	2 to 2.5 (17.7 to 22.1)
2A0056	R/L1, S/L2, T/L3	4	6 to 4	M6	5.4 to 6.0 (47.8 to 53.1)
	U/T1, V/T2, W/T3	4	6 to 4		
	⊖, ⊕1, ⊕2	–	6 to 4		
	B1, B2	–	10 to 6	M5	2.7 to 3.0 (23.9 to 26.6)
	⊕	6	8 to 4	M6	5.4 to 6.0 (47.8 to 53.1)
2A0069	R/L1, S/L2, T/L3	3	8 to 2	M8	9.9 to 11 (87.6 to 97.4)
	U/T1, V/T2, W/T3	3	8 to 2		
	⊖, ⊕1, ⊕2	–	8 to 2		
	B1, B2	–	8 to 6	M5	2.7 to 3.0 (23.9 to 26.6)
	⊕	6	6 to 4	M6	5.4 to 6.0 (47.8 to 53.1)

■ Three-Phase 400 V Class

Table 3.4 Wire Gauge and Torque Specifications

Drive Model	Terminal	Recomm. Gauge AWG, kcmil	Wire Range AWG, kcmil	Screw Size	Tightening Torque N•m (lb.in.)
4A0001 4A0002 4A0004	R/L1, S/L2, T/L3	14	14 to 10	M4	1.2 to 1.5 (10.6 to 13.3)
	U/T1, V/T2, W/T3	14	14 to 10		
	⊖, ⊕1, ⊕2	–	14 to 10		
	B1, B2	–	14 to 10		
	⊕	14	14 to 10		
4A0005 4A0007 4A0009	R/L1, S/L2, T/L3	14	14 to 10	M4	1.2 to 1.5 (10.6 to 13.3)
	U/T1, V/T2, W/T3	14	14 to 10		
	⊖, ⊕1, ⊕2	–	14 to 10		
	B1, B2	–	14 to 10		
	⊕	10	14 to 10		
4A0011	R/L1, S/L2, T/L3	12	14 to 10	M4	1.2 to 1.5 (10.6 to 13.3)
	U/T1, V/T2, W/T3	14	14 to 10		
	⊖, ⊕1, ⊕2	–	14 to 10		
	B1, B2	–	14 to 10		
	⊕	10	14 to 10		
4A0018	R/L1, S/L2, T/L3	10	14 to 6	M4	2.1 to 2.3 (18.6 to 20.4)
	U/T1, V/T2, W/T3	10	14 to 6		
	⊖, ⊕1, ⊕2	–	14 to 6		
	B1, B2	–	14 to 10		
	⊕	8	14 to 6	M5	2 to 2.5 (17.7 to 22.1)

Drive Model	Terminal	Recomm. Gauge AWG, kcmil	Wire Range AWG, kcmil	Screw Size	Tightening Torque N•m (lb.in.)
4A0023	R/L1, S/L2, T/L3	10	10 to 6	M4	2.1 to 2.3 (18.6 to 20.4)
	U/T1, V/T2, W/T3	10	10 to 6		
	⊖, ⊕1, ⊕2	–	10 to 6		
	B1, B2	–	14 to 10		
	⊕	8	10 to 6	M5	2 to 2.5 (17.7 to 22.1)
4A0031	R/L1, S/L2, T/L3	8	10 to 6	M5	3.6 to 4.0 (31.8 to 35.4)
	U/T1, V/T2, W/T3	8	10 to 6		
	⊖, ⊕1, ⊕2	–	10 to 6		
	B1, B2	–	14 to 10		
	⊕	6	10 to 6	M6	2.7 to 3.0 (23.9 to 26.6)
4A0038	R/L1, S/L2, T/L3	6	10 to 6	M5	3.6 to 4.0 (31.8 to 35.4)
	U/T1, V/T2, W/T3	8	10 to 6		
	⊖, ⊕1, ⊕2	–	10 to 6		
	B1, B2	–	10 to 8		
	⊕	6	10 to 6	M6	2.7 to 3.0 (23.9 to 26.6)
					5.4 to 6.0 (47.8 to 53.1)

◆ Main Circuit Terminal Power Supply and Motor Wiring

This section outlines the various steps, precautions, and checkpoints for wiring the main circuit terminals and motor terminals.

NOTICE: When connecting the motor to the drive output terminals U/T1, V/T2, and W/T3, the phase order for the drive and motor should match. Failure to comply with proper wiring practices may cause the motor to run in reverse if the phase order is backward.

NOTICE: Route motor leads U/T1, V/T2, and W/T3 separate from all other leads to reduce possible interference related issues. Failure to comply may result in abnormal operation of drive and nearby equipment.

NOTICE: Do not connect phase-advancing capacitors or LC/RC noise filters to the output circuits. Improper application of noise filters could result in damage to the drive.

NOTICE: Do not connect the AC power line to the output motor terminals of the drive. Failure to comply could result in death or serious injury by fire as a result of drive damage from line voltage application to output terminals.

■ Cable Length Between Drive and Motor

When the cable length between the drive and the motor is too long (especially at low frequency output), note that the cable voltage drop may cause reduced motor torque. Drive output current will increase as the leakage current from the cable increases. An increase in leakage current may trigger an overcurrent situation and weaken the accuracy of the current detection.

Adjust the drive carrier frequency according to the following table. If the motor wiring distance exceeds 100 m because of the system configuration, reduce the ground currents. *Refer to C6-02: Carrier Frequency Selection on page 156*

Refer to *Table 3.5* to set the carrier frequency to an appropriate level.

Table 3.5 Cable Length Between Drive and Motor

Cable Length	50 m or less	100 m or less	Greater than 100 m
Carrier Frequency	15 kHz or less	5 kHz or less	2 kHz or less

Note: When setting carrier frequency, calculate the cable length as the total distance of wiring to all connected motors when running multiple motors from a single drive.

3.6 Main Circuit Wiring

■ Ground Wiring

Follow the precautions to wire the ground for one drive or a series of drives.

WARNING! Electrical Shock Hazard. Always use a ground wire that complies with technical standards on electrical equipment and minimize the length of the ground wire. Improper equipment grounding may cause dangerous electrical potentials on equipment chassis, which could result in death or serious injury.

WARNING! Electrical Shock Hazard. Be sure to ground the drive ground terminal. (200 V Class: Ground to 100 Ω or less, 400 V Class: Ground to 10 Ω or less). Improper equipment grounding could result in death or serious injury by contacting ungrounded electrical equipment.

NOTICE: Do not share the ground wire with other devices such as welding machines or large-current electrical equipment. Improper equipment grounding could result in drive or equipment malfunction due to electrical interference.

NOTICE: When using more than one drive, ground multiple drives according to instructions. Improper equipment grounding could result in abnormal operation of drive or equipment.

Refer to **Figure 3.15** when using multiple drives. Do not loop the ground wire.

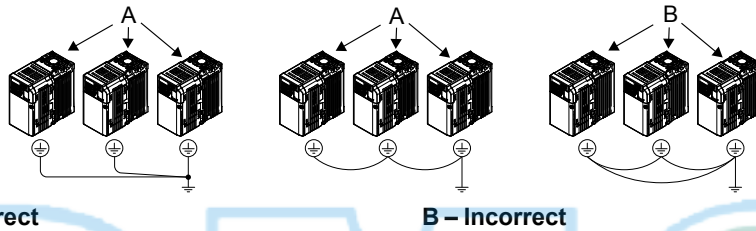
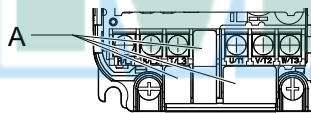

Figure 3.15 Multiple Drive Wiring

■ Wiring the Main Circuit Terminal

WARNING! Electrical Shock Hazard. Shut off the power supply to the drive before wiring the main circuit terminals. Failure to comply may result in death or serious injury.

Note: A cover placed over the DC Bus and braking circuit terminals prior to shipment helps prevent miswiring. Cut away covers as needed for terminals with a needle-nose pliers.



A - Protective Cover to Prevent Miswiring

Note: The ground terminal screw on IP20/NEMA Type 1 holds the protective cover in place.

Main Circuit Connection Diagram

Refer to section **3.3 Main Circuit Connection Diagram** on page **53** for drive main power circuit connections.

WARNING! Fire Hazard. The braking resistor connection terminals are B1 and B2. Do not connect braking resistors to any other terminals. Improper wiring connections could cause the braking resistor to overheat and cause death or serious injury by fire. Failure to comply may result in damage to the braking circuit or drive.

3.7 Control Circuit Wiring

NOTICE: Do not solder the ends of wire connections to the drive. Soldered wire connections can loosen over time. Improper wiring practices could result in drive malfunction due to loose terminal connections.

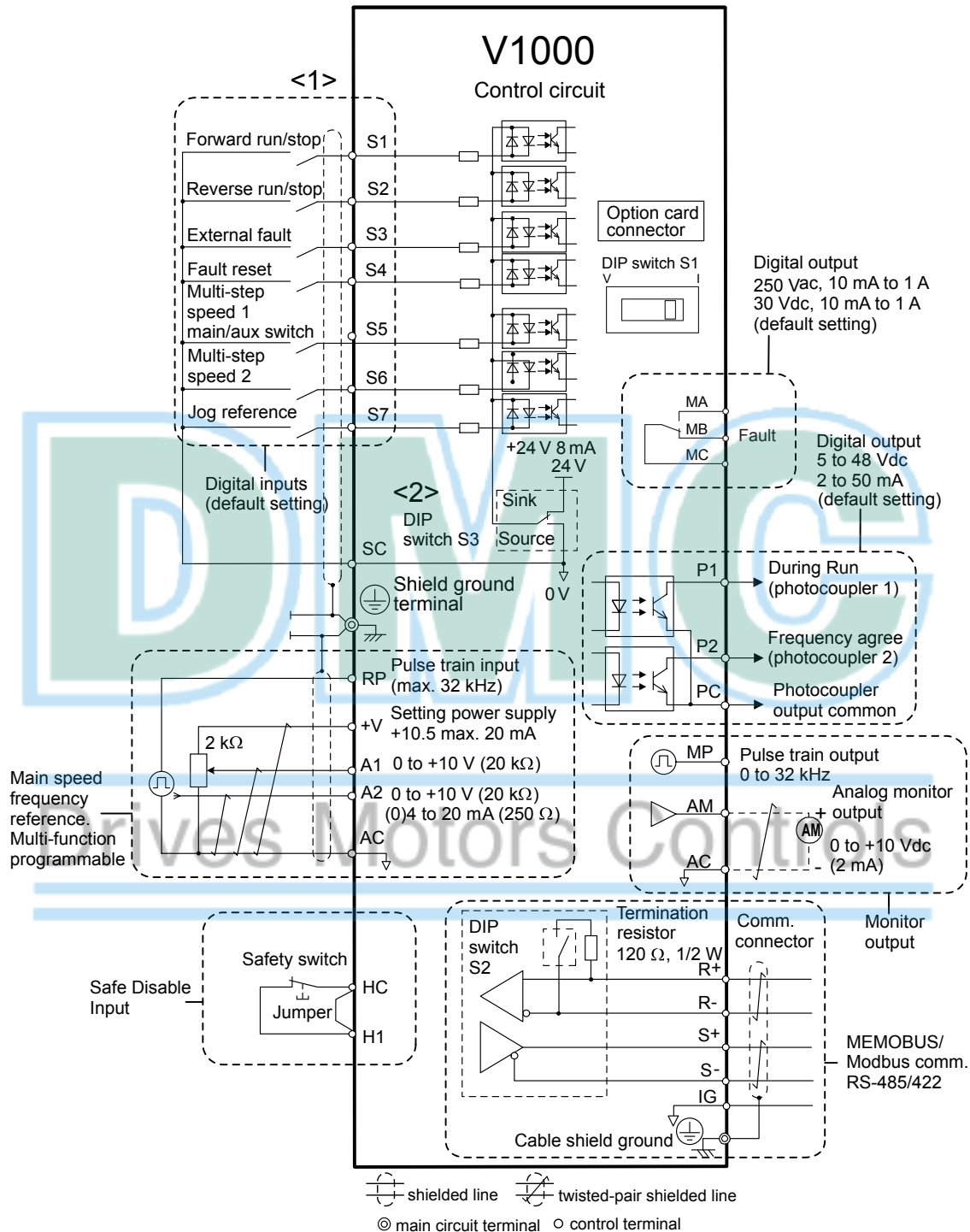

Figure 3.16 Control Circuit Connection Diagram

<1> Connected using sequence input signal (S1 to S7) from NPN transistor; Default: sink mode (0 V com)

<2> Use only the +24 V internal power supply in sinking mode; the source mode requires an external power supply. *Refer to I/O Connections on page 68.*

3.7 Control Circuit Wiring

◆ Control Circuit Terminal Block Functions

Drive parameters determine which functions apply to the multi-function digital inputs (S1 to S7), multi-function digital outputs (MA, MB), multi-function pulse inputs and outputs (RP, MP) and multi-function photocoupler outputs (P1, P2). The default is called out next to each terminal in [Figure 3](#).

WARNING! Sudden Movement Hazard. Always check the operation and wiring of control circuits after being wired. Operating a drive with untested control circuits could result in death or serious injury.

WARNING! Confirm the drive I/O signals and external sequence before starting test run. Setting parameter A1-06 may change the I/O terminal function automatically from the factory setting. [Refer to Application Selection on page 96](#). Failure to comply may result in death or serious injury.

■ Input Terminals

Table 3.6 Control Circuit Input Terminals

Type	No.	Terminal Name (Function)	Function (Signal Level) Default Setting
Multi-Function Digital Inputs	S1	Multi-function input 1 (Closed: Forward run, Open: Stop)	Photocoupler 24 Vdc, 8 mA Note: Drive preset to sinking mode. When using source mode, set DIP switch S3 to allow for a 24 Vdc (±10%) external power supply. Refer to Sinking/Sourcing Mode Switch on page 68 .
	S2	Multi-function input 2 (Closed: Reverse run, Open: Stop)	
	S3	Multi-function input 3 (External fault (N.O.))	
	S4	Multi-function input 4 (Fault reset)	
	S5	Multi-function input 5 (Multi-step speed reference 1)	
	S6	Multi-function input 6 (Multi-step speed reference 2)	
	S7	Multi-function input 7 (Jog reference)	
	SC	Multi-function input common (Control common)	
Safe Disable Input	HC	Power supply for safe disable input	+24 Vdc (max 10 mA allowed) Do not use external power supply.
	H1	Safe disable input	Open: Output disabled Closed: Normal operation Note: Disconnect wire jumper between HC and H1 when using the safe disable input. The wire length should not exceed 30 m. Use only dry contacts on safety inputs HC-H1.
Main Frequency Reference Input	RP	Multi-function pulse train input (frequency reference)	Response frequency: 0.5 to 32 kHz (Duty Cycle: 30 to 70%) (High level voltage: 3.5 to 13.2 Vdc) (Low level voltage: 0.0 to 0.8 Vdc) (input impedance: 3 kΩ)
	+V	Analog input power supply	+10.5 Vdc (max allowable current 20 mA)
	A1	Multi-function analog input 1 (frequency reference)	Input voltage 0 to +10 Vdc (20 kΩ) resolution 1/1000
	A2	Multi-function analog input 2 (frequency reference)	Input voltage or input current (Selected by DIP switch S1 and H3-09) 0 to +10 Vdc (20 kΩ), Resolution: 1/1000 4 to 20 mA (250 Ω) or 0 to 20 mA (250 Ω), Resolution: 1/500
	AC	Frequency reference common	0 Vdc

■ Output Terminals

Table 3.7 Control Circuit Output Terminals

Type	No.	Terminal Name (Function)	Function (Signal Level) Default Setting
Multi-Function Digital Output <1>	MA	N.O. (fault)	Digital output 30 Vdc, 10 mA to 1 A; 250 Vac, 10 mA to 1 A Minimum load: 5 Vdc, 10 mA (reference value)
	MB	N.C. output (fault)	
	MC	Digital output common	
Multi-Function Photocoupler Output	P1	Photocoupler output 1 (During run)	Photocoupler output 48 Vdc, 2 to 50 mA <2>
	P2	Photocoupler output 2 (Frequency agree)	
	PC	Photocoupler output common	
Monitor Output	MP	Pulse train output (Output frequency)	32 kHz (max) <3> <4>
	AM	Analog monitor output	0 to 10 Vdc (2 mA or less) Resolution: 1/1000
	AC	Monitor common	0 V

<1> Do not assign functions to digital relay outputs that involve frequent switching. This may shorten relay performance life. Switching life is estimated at 200,000 times (assumes 1 A, resistive load).

- <2> Connect a suppression diode as shown in *Figure 3.17* when driving a reactive load such as a relay coil. Ensure the diode rating is greater than the circuit voltage.
- <3> When set for sourcing. +5 V/1.5 kΩ or higher, +8 V/3.5 kΩ or higher, +10 V/10 kΩ or higher.
- <4> When set for sinking, the external power supply should be +12 Vdc, ±5% with 16 mA or less.

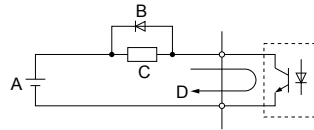

A – External power, 48 V max. **C** – Coil
B – Suppression diode **D** – 50 mA or less

Figure 3.17 Connecting a Suppression Diode

Serial Communication Terminals

Table 3.8 Control Circuit Terminals: Serial Communications

Type	No.	Signal Name	Function (Signal Level)
MEMOBUS/Modbus Communication	R+	Communications input (+)	MEMOBUS/Modbus communication: Use a RS-485 or RS-422 cable to connect the drive. RS-485/422 MEMOBUS/Modbus communication protocol 115.2 kbps (max.)
	R-	Communications input (-)	
	S+	Communications output (+)	
	S-	Communications output (-)	
	IG	Shield ground	0 V

Terminal Configuration

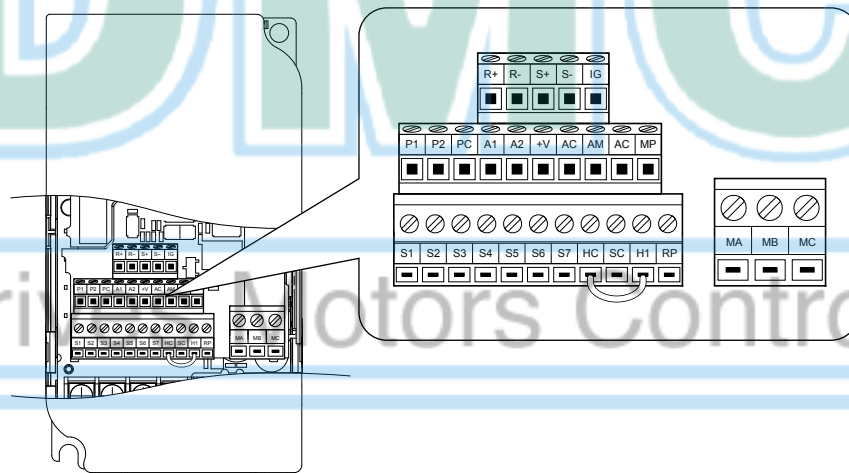

Figure 3.18 Removable Control Circuit Terminal Block

3.7 Control Circuit Wiring

■ Wire Size and Torque Specifications

Select appropriate wire type and size from [Table 3.9](#). For simpler and more reliable wiring, crimp ferrules to the wire ends. Refer to [Table 3.10](#) for ferrule terminal types and sizes.

Table 3.9 Wire Size and Torque Specifications (Same for All Models)

Terminal	Screw Size	Tightening Torque N·m (in-lbs)	Bare Wire Terminal		Ferrule-Type Terminal		Wire Type
			Applic. wire size mm ² (AWG)	Recomm. mm ² (AWG)	Applic. wire size mm ² (AWG)	Recomm. mm ² (AWG)	
MA, MB, MC	M3	0.5 to 0.6 (4.4 to 5.3)	Stranded: 0.25 to 1.5 (24 to 16) Single: 0.25 to 1.5 (24 to 16)	0.75 (18)	0.25 to 1.0 (24 to 17)	0.5 (20)	Shielded line, etc.
S1-S7, SC, RP, +V, A1, A2, AC, HC, H1, P1, P2, PC, MP, AM, AC, S+, S-, R+, R-, IG	M2	0.22 to 0.25 (1.9 to 2.2)	Stranded: 0.25 to 1.0 (24 to 18) Single: 0.25 to 1.5 (24 to 16)	0.75 (18)	0.25 to 0.5 (24 to 20)	0.5 (20)	

■ Ferrule-Type Wire Terminations

Crimp a ferrule to signal wiring to improve wiring simplicity and reliability. Use CRIMPFOX 6, a crimping tool manufactured by PHOENIX CONTACT.

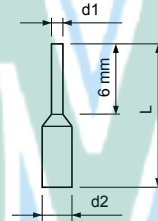

Figure 3.19 Ferrule Dimensions

Table 3.10 Ferrule Terminal Types and Sizes

Size mm ² (AWG)	Type	L (mm)	d1 (mm)	d2 (mm)	Manufacturer
0.25 (24)	AI 0.25-6YE	10.5	0.8	2.0	PHOENIX CONTACT
0.34 (22)	AI 0.34-6TQ	10.5	0.8	2.0	
0.5 (20)	AI 0.5-6WH	12	1.1	2.5	
0.75 (18)	AI 0.75-6GY	12	1.3	2.8	
1.0	AI 1-6RD	12	1.5	3.0	

◆ Wiring Procedure

This section describes the proper procedures and preparations for wiring the control terminals.

WARNING! *Electrical Shock Hazard. Do not remove covers or touch the circuit boards while the power is on. Failure to comply could result in death or serious injury.*

NOTICE: *Separate control circuit wiring from main circuit wiring (terminals R/L1, S/L2, T/L3, B1, B2, U/T1, V/T2, W/T3, -, +1, +2) and other high-power lines. Improper wiring practices could result in drive malfunction due to electrical interference.*

NOTICE: *Separate wiring for digital output terminals MA, MB and MC from wiring to other control circuit lines. Improper wiring practices could result in drive or equipment malfunction or nuisance trips.*

NOTICE: *Use a class 2 power supply (UL standard) when connecting to the control terminals. Improper application of peripheral devices could result in drive performance degradation due to improper power supply.*

NOTICE: *Insulate shields with tape or shrink tubing to prevent contact with other signal lines and equipment. Improper wiring practices could result in drive or equipment malfunction due to short circuit.*

NOTICE: *Connect the shield of shielded cable to the appropriate ground terminal. Improper equipment grounding could result in drive or equipment malfunction or nuisance trips.*

Wire the control terminals using [Figure 3.20](#) as a guide. Prepare the ends of the control circuit wiring as shown in [Figure 3.21](#). Refer to [Wire Size and Torque Specifications on page 66](#).

NOTICE: Do not tighten screws beyond the specified tightening torque. Failure to comply may damage the terminal block.

NOTICE: Use shielded twisted-pair cables as indicated to prevent operating faults. Improper wiring practices could result in drive or equipment malfunction due to electrical interference.

Connect control wires as shown in the following figure:

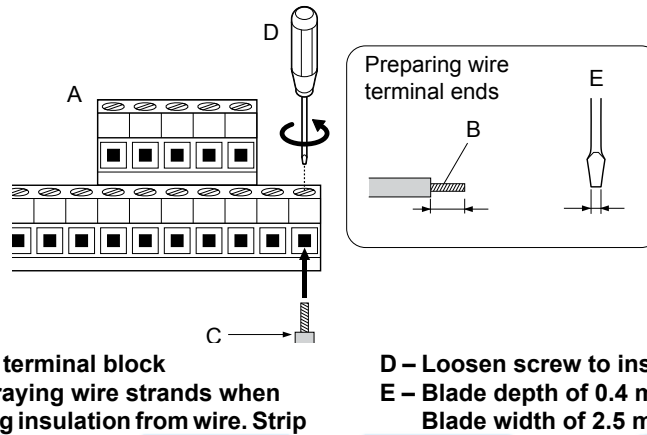

- A – Control terminal block
- B – Avoid fraying wire strands when stripping insulation from wire. Strip length 5.5 mm.
- C – Single wire or stranded wire
- D – Loosen screw to insert wire.
- E – Blade depth of 0.4 mm or less
Blade width of 2.5 mm or less

Figure 3.20 Terminal Board Wiring Guide

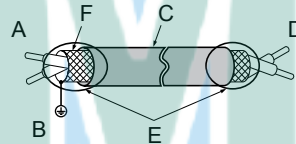

- A – Drive side
- B – Connect shield to ground terminal of drive.
- C – Insulation
- D – Control device side
- E – Shield sheath (Insulate with tape)
- F – Shield

Figure 3.21 Preparing the Ends of Shielded Cables

When setting the frequency by analog reference from an external potentiometer, use shielded twisted-pair wires and ground the shield of twisted-pair wires to the ground terminal of the drive.

NOTICE: The analog signal lines between the drive and the operator station or peripheral equipment should not exceed 50 meters when using an analog signal from a remote source to supply the frequency reference. Failure to comply could result in poor system performance.

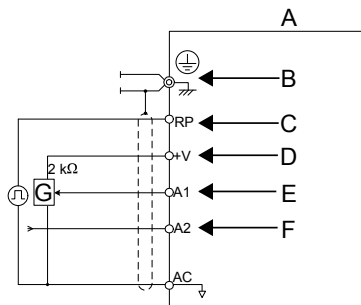

- A – Drive
- B – Ground terminal (shield connection)
- C – (RP) Pulse train (maximum 32 kHz)
- D – (+V) Frequency setting power source +10.5 Vdc maximum 20 mA
- E – (A1) Main speed frequency reference 0 to +10 Vdc (20 k Ω)
- F – (A2) Multi-function analog input 0 to +10 Vdc (20 k Ω) or 4 to 20 mA (250 Ω)/ 0 to 20 mA (250 Ω)
- G – Frequency setting potentiometer

Figure 3.22 Wiring the Frequency Reference to the Control Circuit Terminals (External Reference)

3.8 I/O Connections

◆ Sinking/Sourcing Mode Switch

Set the DIP switch S3 on the front of the drive to switch the digital input terminal logic between sinking mode and sourcing mode; the drive is preset to sinking mode.

Table 3.11 Sinking/Sourcing Mode Setting

Set Value	Details
SINK	Sinking Mode (0 V common): default setting
SOURCE	Sourcing Mode (+24 V common)

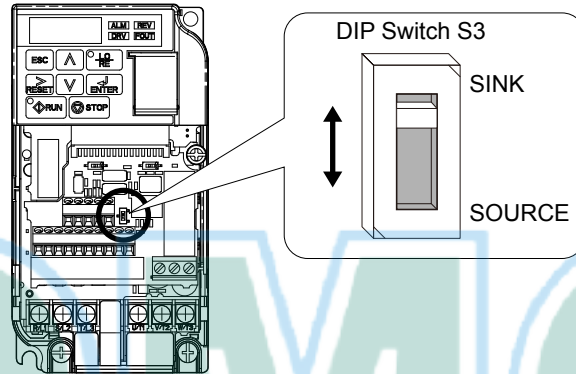

Figure 3.23 DIP Switch S3

■ Transistor Input Signal Using 0 V Common/Sink Mode

When controlling the digital inputs by NPN transistors (0 V common/sinking mode), set the DIP switch S3 to SINK and use the internal 24 V power supply.

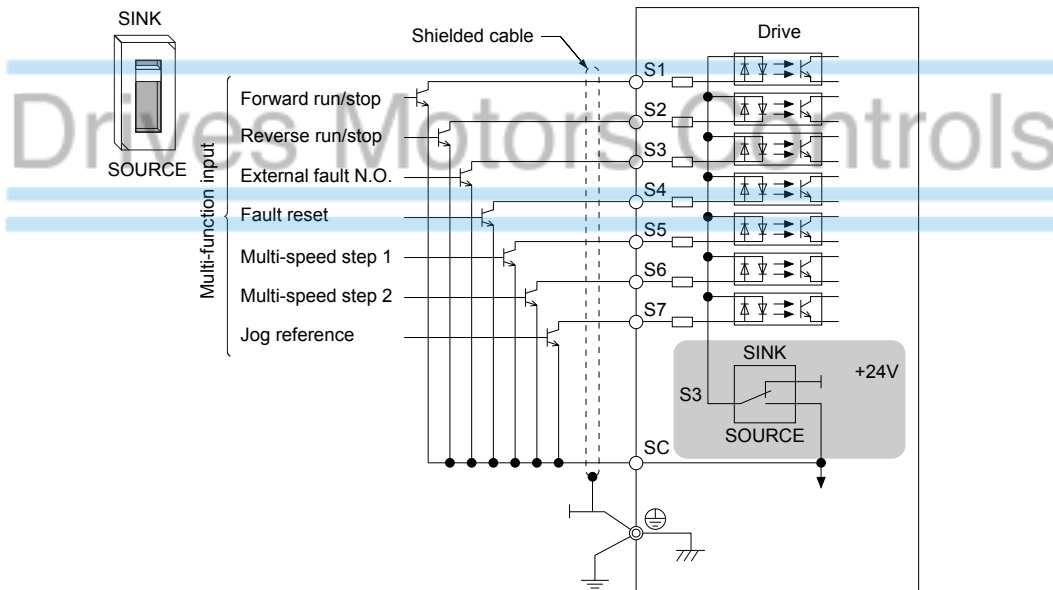

Figure 3.24 Sinking Mode: Sequence from NPN Transistor (0 V Common)

■ Transistor Input Signal Using +24 V Common/Source Mode

When controlling digital inputs by PNP transistors (+24 V common/sourcing mode), set the DIP switch S3 to SOURCE and use an external 24 V power supply.

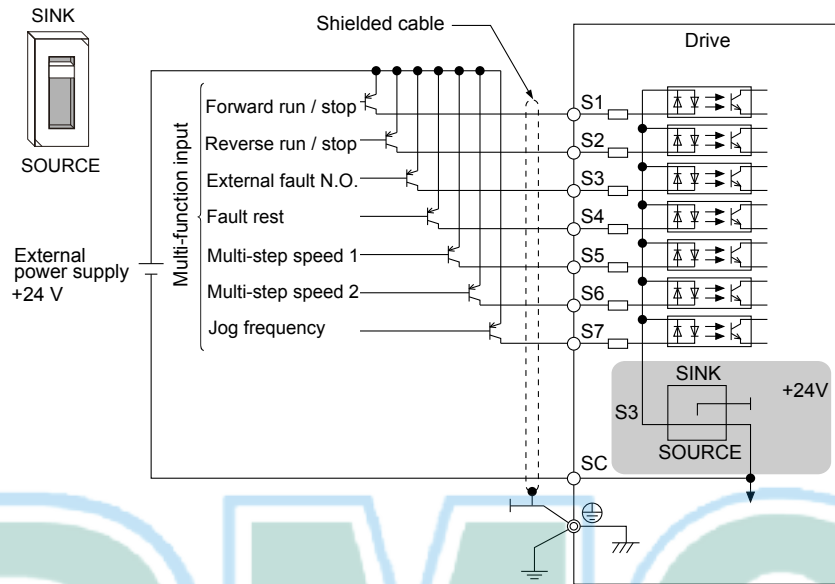
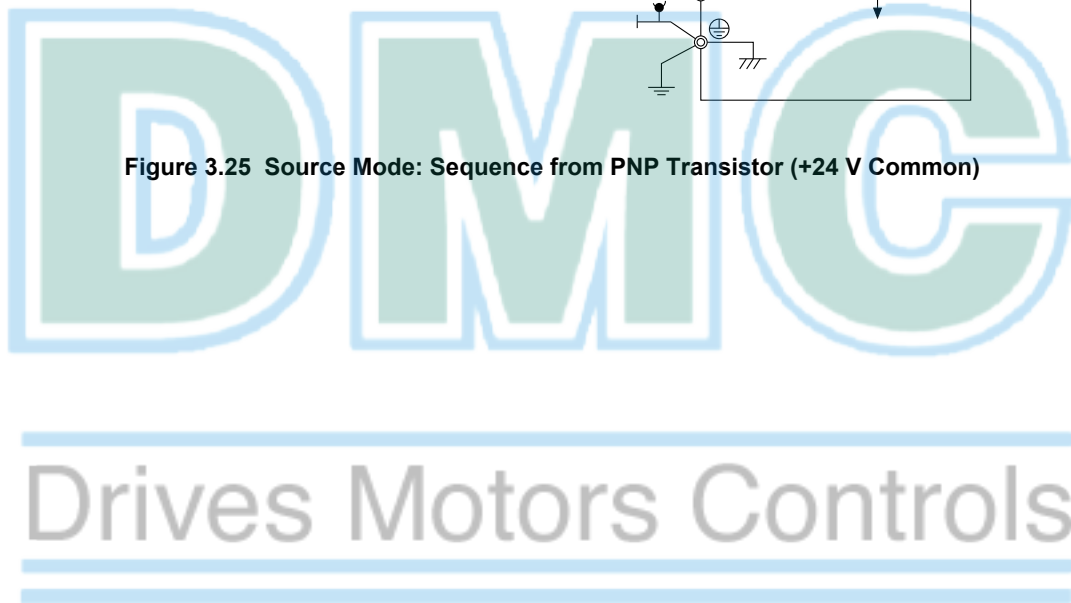

Figure 3.25 Source Mode: Sequence from PNP Transistor (+24 V Common)



3.9 Main Frequency Reference

◆ DIP Switch S1 Analog Input Signal Selection

The main frequency reference can either be a voltage or current signal input. For voltage signals both analog inputs, A1 and A2, can be used, for current signals A2 must be used.

When using input A2 as a voltage input, set DIP switch S1 to "V" (left position) and program parameter H3-09 to "0" (0 to +10 Vdc with lower limit) or "1" (0 to +10 Vdc without lower limit).

To use current input at terminal A2, set the DIP switch S1 to "I" (default setting) and set parameter H3-09 = "2" or "3" (4-20 mA or 0-20 mA). Set parameter H3-10 = "0" (frequency reference).

Note: If Terminals A1 and A2 are both set for frequency reference (H3-02 = 0 and H3-10 = 0), the addition of both input values builds the frequency reference.

Table 3.12 Frequency Reference Configurations

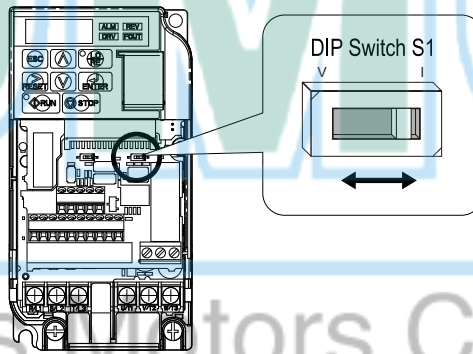
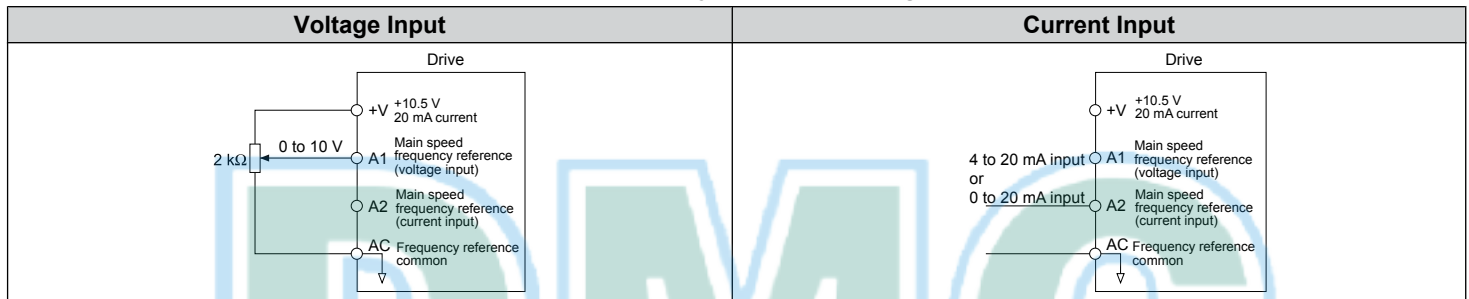

Figure 3.26 DIP Switch S1

Table 3.13 DIP Switch S1 Settings

Setting Value	Description
V (left position)	Voltage input (0 to 10 V)
I (right position)	Current input (4 to 20 mA or 0 to 20 mA): default setting

Table 3.14 Parameter H3-09 Details

No.	Parameter Name	Description	Setting Range	Default Setting
H3-09	Frequency ref. (current) terminal A2 signal level selection	Selects the signal level for terminal A2. 0: 0 to +10 V, unipolar input (with lower limit) 1: 0 to +10 V, bipolar input (no lower limit) 2: 4 to 20 mA 3: 0 to 20 mA	0 to 3	2

3.10 MEMOBUS/Modbus Termination

The two ends of the MEMOBUS/Modbus network line must be terminated. The drive has a built-in termination resistor that can be enabled or disabled using DIP switch S2. If a drive is a single drive on the network or is located at the end of a network line, set DIP switch S2 to the ON position to enable the termination resistor. Disable the termination resistor on all slave drives that are not located at the network line end.

Table 3.15 MEMOBUS/Modbus Switch Settings

S2 Position	Description
ON	Internal termination resistor ON
OFF	Internal termination resistor OFF (no termination resistor); default setting

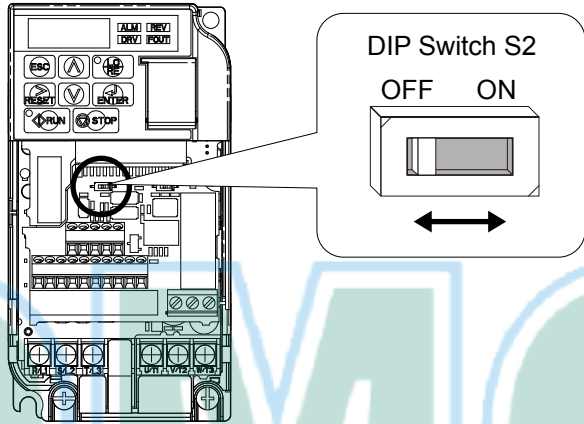
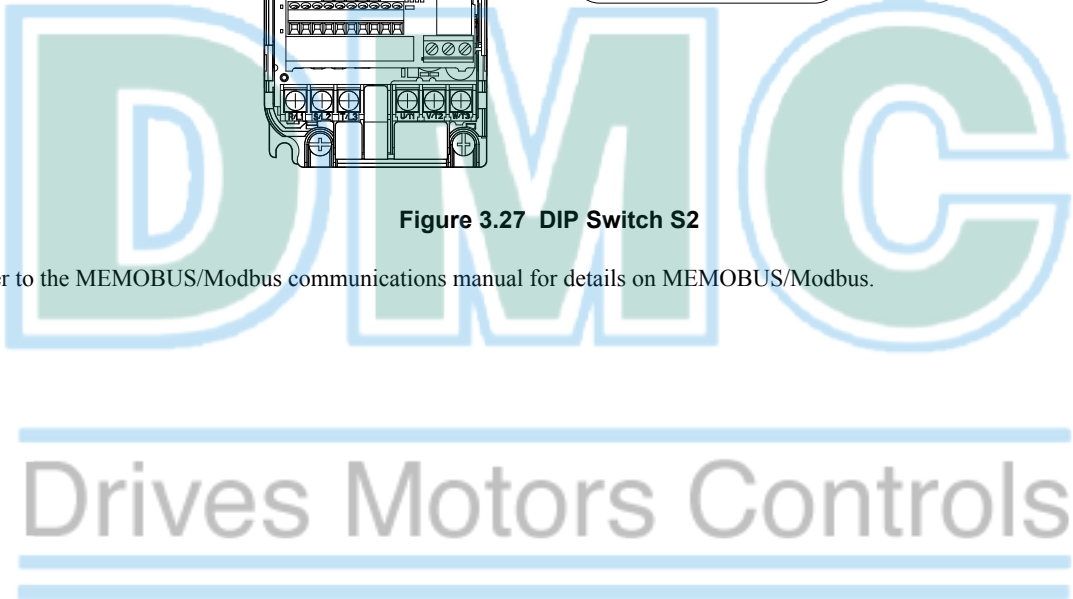

Figure 3.27 DIP Switch S2

Note: Refer to the MEMOBUS/Modbus communications manual for details on MEMOBUS/Modbus.



3.11 Braking Resistor

Dynamic braking (DB) helps bring the motor to a smooth and rapid stop when working with high inertia loads. Regeneration occurs as the drive lowers the motor frequency with high inertia. When the regeneration flows back into the DC bus capacitors, an overvoltage situation occurs. A braking resistor prevents these overvoltage faults.

NOTICE: Do not allow unqualified personnel to use the product. Failure to comply could result in damage to the drive or braking circuit. Carefully review the braking resistor instruction manual when connecting a braking option to the drive.

Note: The braking circuit must be sized properly in order to dissipate the power required to decelerate the load in the desired time. Ensure that the braking circuit can dissipate the energy for the set deceleration time prior to running the drive.

NOTICE: Use a thermal overload relay or over-temperature contact to interrupt input power to the drive if the braking resistor overheats. In the event of a possible thermal overload, the relay triggers the input contactor and prevents the braking resistor from burning up.

◆ Installation

WARNING! Fire Hazard. The braking resistor connection terminals are B1 and B2. Do not connect a braking resistor directly to any other terminals. Improper wiring connections could result in death or serious injury by fire. Failure to comply may result in damage to the braking circuit or drive.

NOTICE: Connect braking resistors to the drive as shown in the I/O wiring examples. Improperly wiring braking circuits could result in damage to the drive or equipment.

■ Installation Procedure

1. Disconnect all electrical power to the drive and wait at least five minutes before servicing the drive and any connected components.
2. Remove drive front cover.
3. Use a voltmeter to verify that voltage is disconnected from incoming power terminals and that the DC bus no longer holds a charge.

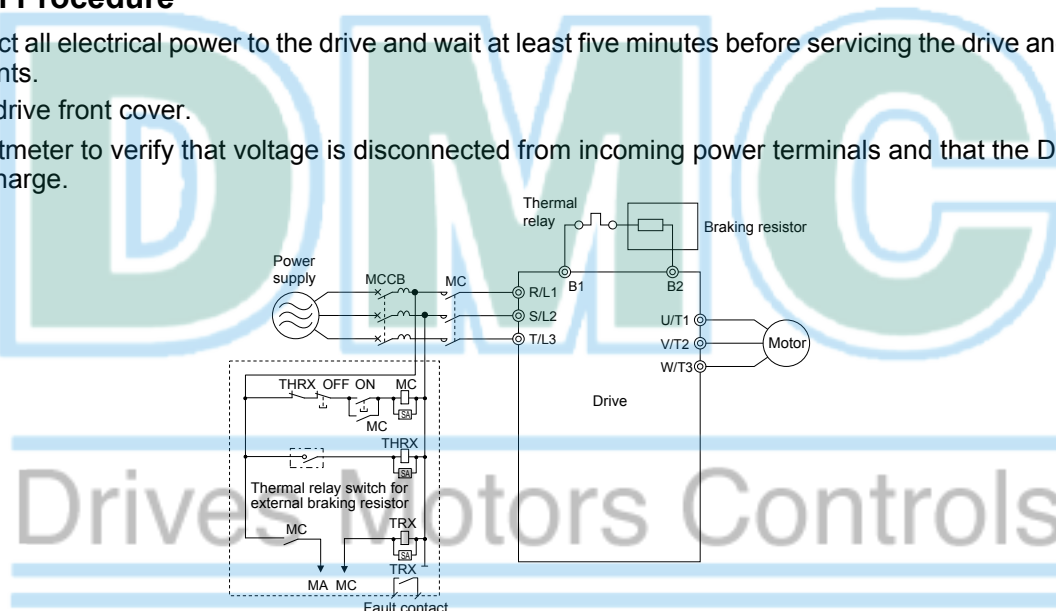

Figure 3.28 Connecting a Braking Resistor

4. Follow manufacturer instructions to connect the resistor unit to the drive using proper wire gauge according to local electrical codes.
Power leads for the remote mount resistors generate high levels of electrical noise; group these signal leads separately.
5. Mount the resistor unit on a noncombustible surface. Maintain minimum side and top clearances according to resistor manufacturer instructions.

WARNING! Fire Hazard. Do not use improper combustible materials. Failure to comply could result in death or serious injury by fire. Attach the drive or braking resistors to metal or other noncombustible material.

6. Reinstall drive covers and resistor covers, if provided.
7. Set parameter L3-04 = "0" or "3" to disable stall prevention during deceleration.
Set parameter L8-01 to "1" to enable overheat protection when using a heatsink-mounted braking resistor option.
Set L8-01 = "0" for other braking resistor types.
Set parameter L3-04 = "3" to generate the shortest possible deceleration time.

Table 3.16 Braking Resistor Settings

Parameter	Settings
L8-01: Internal Dynamic Braking Resistor Protection Selection	0: Disabled. The drive will not provide overheat protection. Supply separate means of overheat protection. 1: Enabled. Braking Resistor is protected from overheat.
L3-04: Stall Prevention During Deceleration Note: Select either 0 or 3	0: Stall prevention disabled. 3: Stall prevention enabled with a braking resistor Note: This setting cannot be used in OLV control for PM motor.

8. Operate the system and verify the required deceleration rate is obtained during dynamic braking or stopping.



3.12 Wiring Checklist

<input checked="" type="checkbox"/>	No.	Item	Page
Drive, peripherals, option cards			
<input type="checkbox"/>	1	Check drive model number to ensure receipt of correct model.	25
<input type="checkbox"/>	2	Check for correct braking resistors, DC link chokes, noise filters, and other peripheral devices.	72
<input type="checkbox"/>	3	Check for correct option card model.	338
Installation area and physical setup			
<input type="checkbox"/>	4	Ensure area surrounding the drive complies with specifications.	38
Power supply voltage, output voltage			
<input type="checkbox"/>	5	The voltage from the power supply should fall within the input voltage specification range of the drive.	169
<input type="checkbox"/>	6	The voltage rating for the motor should match the drive output specifications.	25
Main circuit wiring			
<input type="checkbox"/>	7	Confirm proper branch circuit protection exists per National and Local codes.	50
<input type="checkbox"/>	8	Properly wire the power supply to drive terminals R/L1, S/L2 and T/L3.	53
<input type="checkbox"/>	9	Properly wire the drive and motor together. The motor lines and drive output terminals R/T1, V/T2 and W/T3 should match in order to produce the desired phase order. If the phase order is incorrect, the drive will rotate in the opposite direction.	61
<input type="checkbox"/>	10	Use 600 Vac vinyl-sheathed wire for the power supply and motor lines.	58
<input type="checkbox"/>	11	Use the correct wire gauges for the main circuit. Refer to Table 3.2 , Table 3.3 , or Table 3.4 .	58
<input type="checkbox"/>		<ul style="list-style-type: none"> When using comparatively long motor cable, calculate the amount of voltage drop. <div style="border: 1px solid black; padding: 5px; margin: 5px 0;"> $\text{Motor rated voltage (V)} \times 0.02 \geq 3 \times \text{voltage resistance } (\Omega/\text{km}) \times \text{cable length (m)} \times \text{motor rated current (A)} \times 10^{-3}$ </div> 	58
<input type="checkbox"/>		<ul style="list-style-type: none"> If the cable between the drive and motor exceeds 50 m, adjust the carrier frequency (C6-02) accordingly. 	61
<input type="checkbox"/>	12	Properly ground the drive.	62
<input type="checkbox"/>	13	Tightly fasten all terminal screws (control circuit terminals, grounding terminals). Refer to Table 3.2 , Table 3.3 , or Table 3.4 .	58
<input type="checkbox"/>	14	<p>Set up overload protection circuits when running multiple motors from a single drive.</p> <p style="text-align: center; font-size: small;">MC1 - MCn ... magnetic contactor OL 1 - OL n ... thermal relay</p> <p>Note: Close MC1 through MCn before operating the drive.</p>	-
<input type="checkbox"/>	15	If using a braking resistor or dynamic braking resistor unit, install a magnetic contactor. Properly install the resistor, and ensure that overload protection shuts off the power supply.	72
<input type="checkbox"/>	16	Verify phase advancing capacitors are NOT installed on the output side of the drive.	-
Control circuit wiring			
<input type="checkbox"/>	17	Use twisted-pair cables for all drive control circuit wiring.	63
<input type="checkbox"/>	18	Ground the shields of shielded wiring to the GND ⊕ terminal.	66
<input type="checkbox"/>	19	If using a 3-Wire sequence, properly set parameters for multi-function contact input terminals S1 through S7, and properly wire control circuits.	52
<input type="checkbox"/>	20	Properly wire any option cards.	338
<input type="checkbox"/>	21	Check for any other wiring mistakes. Only use a multimeter to check wiring.	-
<input type="checkbox"/>	22	Properly fasten the control circuit terminal screws in the drive. Refer to Table 3.2 , Table 3.3 , or Table 3.4 .	58
<input type="checkbox"/>	23	Pick up all wire clippings.	-

<input checked="" type="checkbox"/>	No.	Item	Page
<input type="checkbox"/>	24	Ensure that no frayed wires on the terminal block are touching other terminals or connections.	–
<input type="checkbox"/>	25	Properly separate control circuit wiring and main circuit wiring.	–
<input type="checkbox"/>	26	Analog signal line wiring should not exceed 50 m.	–
<input type="checkbox"/>	27	Safe Disable Input wiring should not exceed 30 m.	–



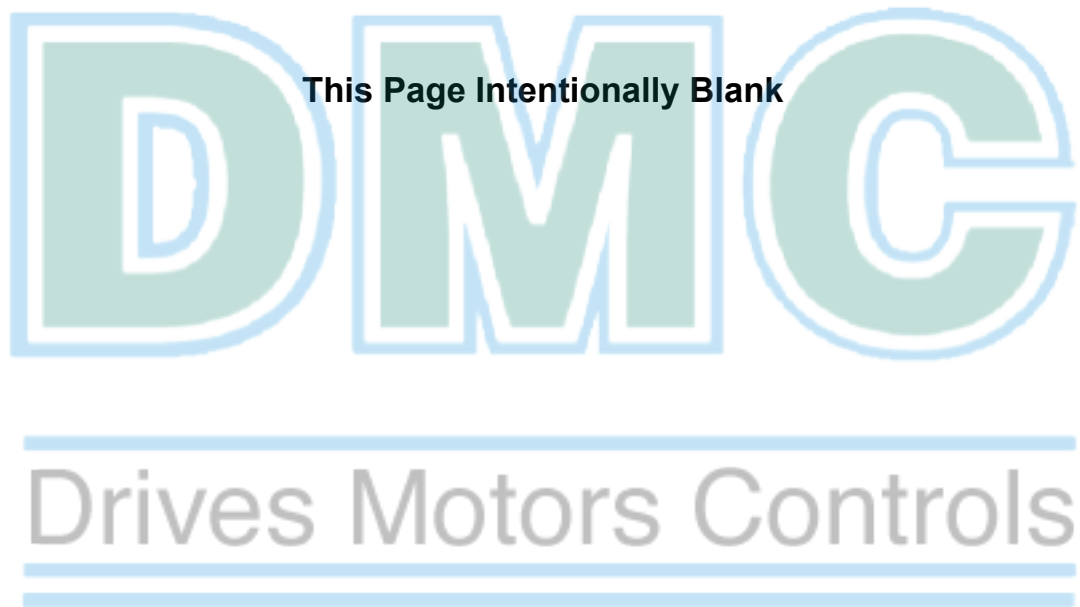

Start-Up Programming & Operation

This chapter explains the functions of the LED operator and how to program the drive for initial operation.

4.1	SECTION SAFETY.....	78
4.2	USING THE DIGITAL LED OPERATOR.....	80
4.3	THE DRIVE AND PROGRAMMING MODES.....	84
4.4	START-UP FLOWCHARTS.....	90
4.5	POWERING UP THE DRIVE.....	95
4.6	APPLICATION SELECTION.....	96
4.7	AUTO-TUNING.....	102
4.8	NO-LOAD OPERATION TEST RUN.....	108
4.9	TEST RUN WITH LOAD CONNECTED.....	109
4.10	VERIFYING PARAMETER SETTINGS AND BACKING UP CHANGES.....	110
4.11	TEST RUN CHECKLIST.....	112

Drives Motors Controls

4.1 Section Safety

DANGER

Electrical Shock Hazard

Do not connect or disconnect wiring while the power is on.

Failure to comply will result in death or serious injury.

WARNING

Electrical Shock Hazard

Do not operate equipment with covers removed.

Failure to comply could result in death or serious injury.

The diagrams in this section may include drives without covers or safety shields to illustrate details. Be sure to reinstall covers or shields before operating the drives and run the drives according to the instructions described in this manual.

Always ground the motor-side grounding terminal.

Improper equipment grounding could result in death or serious injury by contacting the motor case.

Do not touch any terminals before the capacitors have fully discharged.

Failure to comply could result in death or serious injury.

Before wiring terminals, disconnect all power to the equipment. The internal capacitor remains charged even after the power supply is turned off. The charge indicator LED will extinguish when the DC bus voltage is below 50 Vdc. To prevent electric shock, wait at least five minutes after all indicators are off and measure the DC bus voltage level to confirm safe level.

Do not allow unqualified personnel to perform work on the drive.

Failure to comply could result in death or serious injury.

Installation, maintenance, inspection, and servicing must be performed only by authorized personnel familiar with installation, adjustment and maintenance of AC drives.

Do not perform work on the drive while wearing loose clothing, jewelry or without eye protection.

Failure to comply could result in death or serious injury.

Remove all metal objects such as watches and rings, secure loose clothing, and wear eye protection before beginning work on the drive.

Do not remove covers or touch circuit boards while the power is on.

Failure to comply could result in death or serious injury.

Fire Hazard

Tighten all terminal screws to the specified tightening torque.

Loose electrical connections could result in death or serious injury by fire due to overheating of electrical connections.

Do not use an improper voltage source.

Failure to comply could result in death or serious injury by fire.

Verify that the rated voltage of the drive matches the voltage of the incoming power supply before applying power.

Do not use improper combustible materials.

Failure to comply could result in death or serious injury by fire.

Attach the drive to metal or other noncombustible material.

NOTICE

Observe proper electrostatic discharge procedures (ESD) when handling the drive and circuit boards.

Failure to comply may result in ESD damage to the drive circuitry.

Never connect or disconnect the motor from the drive while the drive is outputting voltage.

Improper equipment sequencing could result in damage to the drive.

Do not use unshielded cable for control wiring.

Failure to comply may cause electrical interference resulting in poor system performance. Use shielded twisted-pair wires and ground the shield to the ground terminal of the drive.

Do not allow unqualified personnel to use the product.

Failure to comply could result in damage to the drive or braking circuit.

Carefully review instruction manual TOBP C720600 00 when connecting a braking option to the drive.

Do not modify the drive circuitry.

Failure to comply could result in damage to the drive and will void warranty.

Yaskawa is not responsible for any modification of the product made by the user. This product must not be modified.

Check all the wiring to ensure that all connections are correct after installing the drive and connecting any other devices.

Failure to comply could result in damage to the drive.

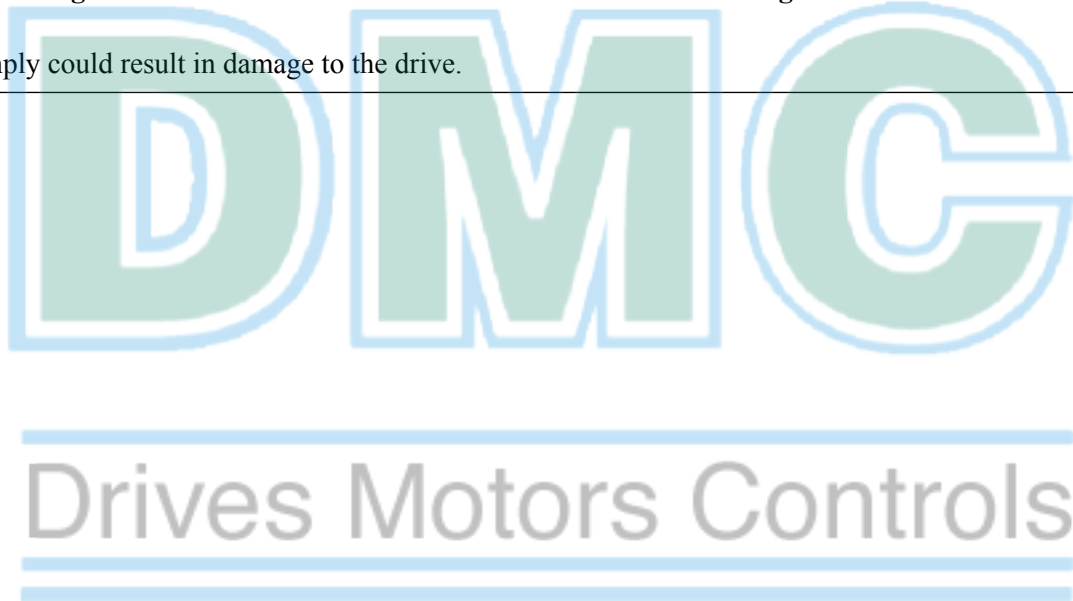

4.2 Using the Digital LED Operator

Use the LED operator to enter run and stop commands, display data, edit parameters, as well as display fault and alarm information.

◆ Keys, Displays, and LEDs

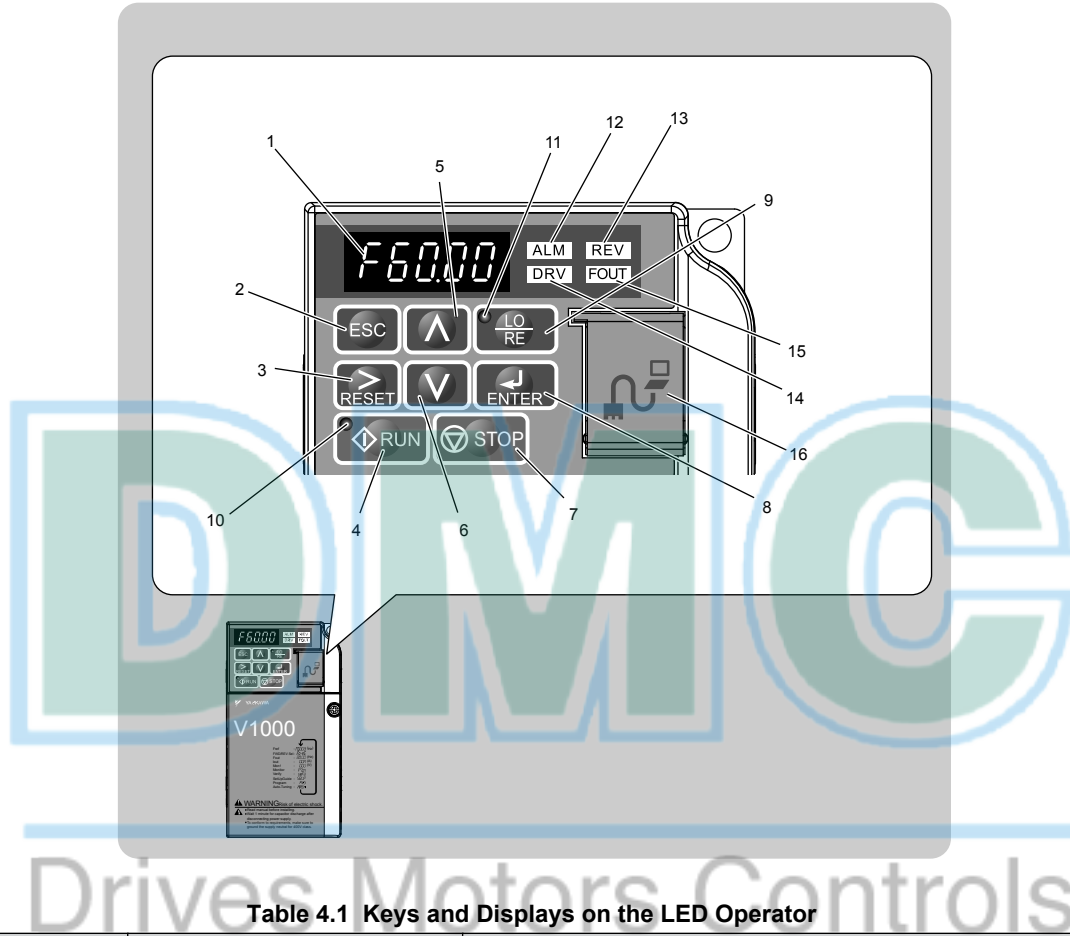









Table 4.1 Keys and Displays on the LED Operator

No.	Display	Name	Function
1		Data Display Area	Displays the frequency reference, parameter number, etc.
2		ESC Key	Returns to the previous menu.
3		RESET Key	Moves the cursor to the right. Resets the drive to clear a fault situation.
4		RUN Key	Starts the drive.
5		Up Arrow Key	Scrolls up to select parameter numbers, setting values, etc.
6		Down Arrow Key	Scrolls down to select parameter numbers, setting values, etc.
7		STOP Key	Stops the drive. Note: Stop priority circuit. Pressing the STOP key will always cause the drive to stop the motor, even when a Run command is active at an external Run command source. Set parameter o2-06 to 0 to disable the STOP key priority.
8		ENTER Key	Selects all modes, parameters, settings, etc. Selects a menu item to move from one display screen to the next.

No.	Display	Name	Function
9		LO/RE Selection Key	Switches drive control between the operator (LOCAL) and the control circuit terminals (REMOTE). Note: LOCAL/REMOTE key effective during stop in drive mode. If the digital operator could change from REMOTE to LOCAL by incorrect operation, set o2-01 (LOCAL/REMOTE Key Function Selection) to "0" (disabled) to disable LOCAL/REMOTE key.
10		RUN Light	Lit while the drive is operating the motor.
11		LO/RE Light	Lit while the operator (LOCAL) is selected to run the drive.
12		ALM LED Light	<i>Refer to LED Screen Displays on page 82.</i>
13		REV LED Light	
14		DRV LED Light	
15		FOUT LED Light	
16	–	Communication Port	Port used for USB Copy Unit, LCD Operator Keypad, and for connecting to a PC. NOTICE: Use only specified cable when making connections to the drive. Failure to comply may damage the drive. NOTICE: Do not open the port cover wider than 90 degrees. Failure to comply may break the port cover and leave the unprotected port susceptible to damage.

◆ Digital Text Display

Text appears on the LED Operator as shown below. This section explains the meaning of text as it appears on the display screen.

Lit	Flashing
	

Table 4.2 Digital Text Display

Text	LED	Text	LED	Text	LED	Text	LED
0	0	9	9	I	l	R	r
1	1	A	A	J	j	S	s
2	2	B	b	K	k	T	t
3	3	C	c	L	l	U	u
4	4	D	d	M	m	V	v
5	5	E	e	N	n	W	w
6	6	F	f	O	o	X	None
7	7	G	g	P	p	Y	y
8	8	H	h	Q	q	Z	None

<1> Displayed in two digits.

◆ LED Screen Displays

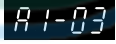
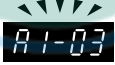
Display	Lit	Flashing	Off
ALM	When the drive detects an alarm or error	<ul style="list-style-type: none"> When an alarm occurs oPE detected When a fault or error occurs during Auto-Tuning 	Normal state (no fault or alarm)
REV	Motor is rotating in reverse	—	Motor is rotating forward
DRV	Drive Mode Auto-Tuning	When DriveWorksEZ is used <1>	Programming Mode
FOUT	Displays output frequency (Hz)	—	—
As illustrated in this manual			

<1> Refer to the DriveWorksEZ instruction manual for further information.

◆ LO/RE LED and RUN LED Indications

LED	Lit	Flashing	Flashing Quickly <1>	Off
	When a Run command is selected from the LED operator (LOCAL)	—	—	Run command is selected from device other than LED operator (REMOTE)
	During Run	<ul style="list-style-type: none"> During deceleration to stop When a Run command is input and frequency reference is 0 	<ul style="list-style-type: none"> During deceleration at a fast-stop. During stop by interlock operation. <2> 	During stop
As shown				

<1> Refer to [Figure 4.1](#) for the difference between “flashing” and “flashing quickly”.

<2> Refer to the description for parameter U4-21 on page [403](#) for information on verifying operation interlock.

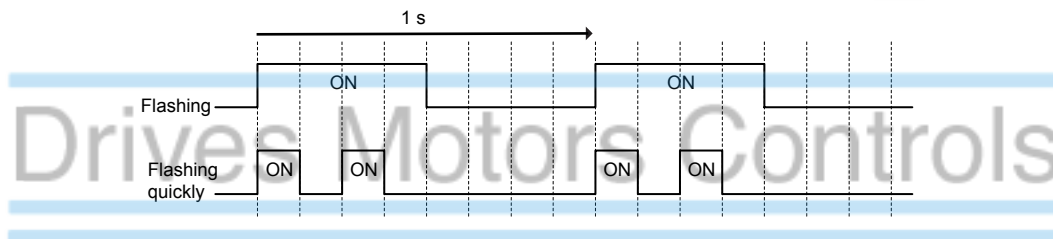

Figure 4.1 RUN LED Status and Meaning

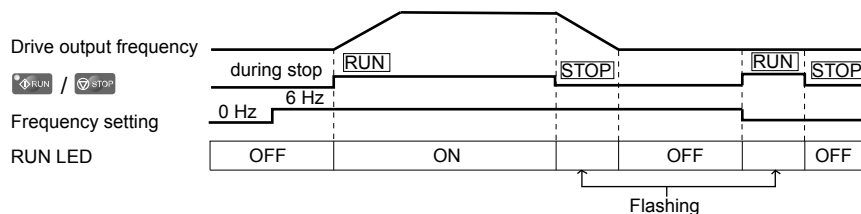

Figure 4.2 RUN LED and Drive Operation

◆ Menu Structure for Digital LED Operator

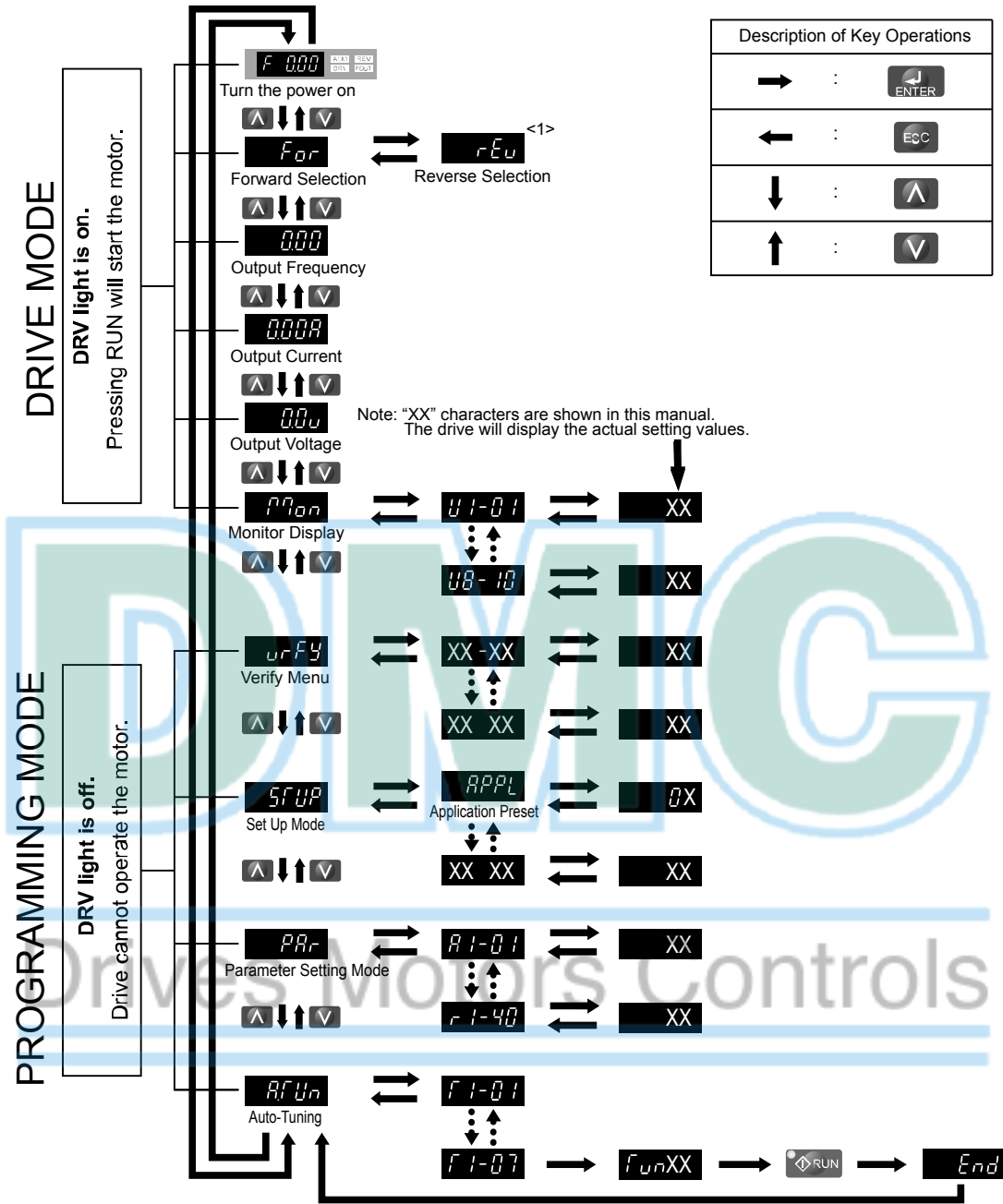

Figure 4.3 Digital LED Operator Screen Structure

<1> Reverse can only be selected when LOCAL is set.

4.3 The Drive and Programming Modes

The drive functions are divided into two main groups accessible via the Digital LED Operator:

Drive Mode: The Drive mode allows motor operation and parameter monitoring. Parameter settings cannot be changed when accessing functions in the Drive Mode (*Table 4.3*)

Programming Mode: The Programming Mode allows access to setup/adjust, verify parameters and Auto-Tuning. The drive prohibits changes in motor operation such as start/stop when the Digital LED Operator is accessing a function in the Programming Mode.

Table 4.3 illustrates the different functions visible as the “Up arrow” is scrolled immediately after powering up the drive.

Note: When b1-08 (Run Command Selection while in Programming Mode) is set to 1 (enabled), the drive can run even if the mode is switched to the programming mode. When setting b1-08 to 0 (disabled), the mode cannot be switched to the programming mode while the drive is running.

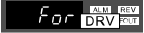



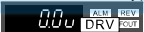

Table 4.3 Summary of Modes

Mode Group	Description	Key Press	LED Digital Operator Display <1>
Drive Mode Functions (Motor operation and monitoring)	Frequency Reference Display (Initial power-up state)	▲	
	Forward/Reverse	▲	
	Output Frequency Display	▲	
	Output Current Display	▲	
	Output Voltage Reference	▲	
	Monitor Display	▲	
Programming Mode Functions (Changing parameters)	Verify Function	▲	
	Setup Group Parameters	▲	
	All Parameters	▲	
	Auto-Tuning	▲	









<1> The enlarged illustration of the LED indicates that the LED is on.

◆ Navigating the Drive and Programming Modes

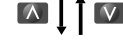
The drive is set to operate in Drive Mode when it is first powered up. Switch between display screens by using the **▲** and **▼** keys.

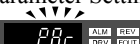
<p>Power Up</p>	<p>Frequency Reference</p>  <p>Default Setting</p>	<p>This display screen allows the user to monitor and set the frequency reference while the drive is running. <i>Refer to The Drive and Programming Modes on page 84.</i> Note: The user can select items to display when the drive is first powered up by setting parameter o1-02.</p>
<p>Drive Mode</p>	<p>▲ ↕ ▼</p>	
	<p>Forward/Reverse</p> 	<p><i>F_{or}</i>: Motor rotates forward. <i>rEv</i>: Motor rotates in reverse. Note: For applications that should not run in reverse (fans, pumps, etc.), set parameter b1-04 = "1" to prohibit the motor from rotating in reverse. This sequence also puts the drive in LOCAL mode.</p> <p>Switching to reverse: <i>rEv</i></p>  <p>The LED is lit when LOCAL is selected.</p> 
	<p>▲ ↕ ▼</p>	
	<p>Output Frequency Display</p> 	<p>Monitors the frequency output by the drive.</p>
	<p>Output Current Display</p> 	<p>Monitors the output current of the drive.</p>
<p>Drive Mode</p>	<p>Output Voltage Reference (Default setting)</p> 	<p>Scroll through o1-01 (User Monitor Selection) until the desired contents appear. → <i>Refer to Parameter List on page 353</i></p>
	<p>Monitor Display</p> 	<p>Monitor parameters (U parameters) are displayed.</p>

4.3 The Drive and Programming Modes

Programming Mode	 Verify Function 	Lists all parameters that have been edited or changed from default settings. → Refer to Verifying Parameter Changes: Verify Menu on page 88 .
	 Setup 	A select list of parameters necessary to get the drive operational quickly. → Refer to The Setup Group within the Programming Mode on page 87 . Note: Parameters to be displayed differ depending on the setting of A1-06 (Application Preset). Refer to Application Selection on page 96 .
	 Parameter Setting 	Allows the user to access and edit all parameter settings. → Refer to Parameter List on page 353 .
	 Auto-Tuning 	Motor parameters are calculated and set automatically. → Refer to Auto-Tuning on page 102 .
	 Frequency Reference 	Returns to the frequency reference display screen.
	Drive Mode	

■ Drive Mode Details

The following actions are possible in the Drive Mode:

- Run and stop the drive.
- Monitor the operation status of the drive (frequency reference, output frequency, output current, output voltage, etc.).
- View information on an alarm.
- View a history of alarms that have occurred.

Note: Select "Drive Mode" when running. The mode can be switched to any mode (program mode, etc.) other than drive mode while the drive is stopped. However, the drive cannot be operated in other modes. Return the mode to "Drive Mode" after completing periodic inspection.

Figure 4.4 illustrates changing the default frequency reference of F 0.00 (0 Hz) to F 6.00 (6 Hz) while in Drive Mode. This example assumes the drive is set to LOCAL.

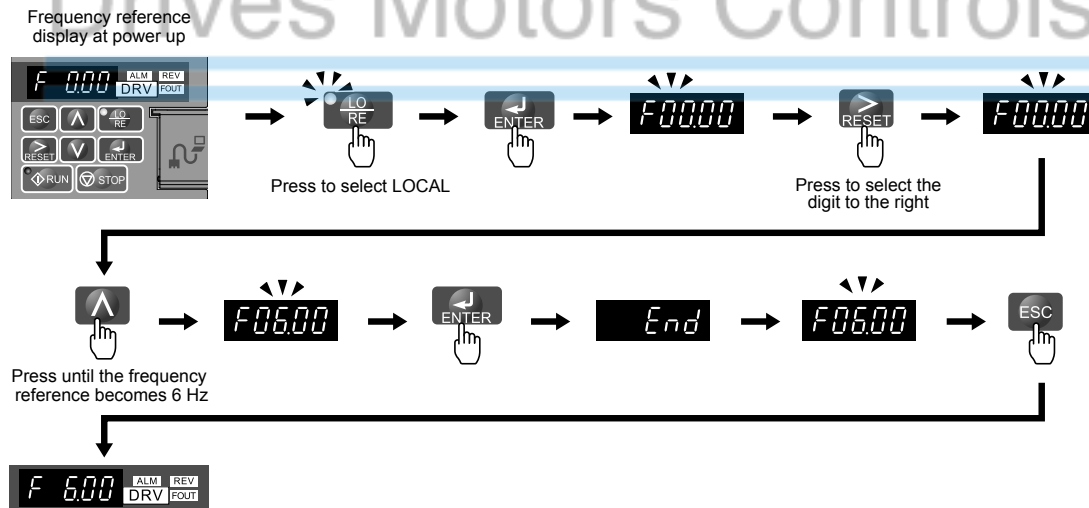

Figure 4.4 Setting the Frequency Reference while in Drive Mode

Note: The drive will not accept a frequency reference set value unless the ENTER key is pressed after the frequency reference is entered. This feature prevents accidental setting of the frequency reference. By setting o2-05 (Frequency Reference Setting Method Selection) to 1 (Enabled), the drive will accept the frequency reference while it is being adjusted on the digital operator.

■ Programming Mode Details

The following actions are possible in the programming mode:

- **Verify Function:** Verify parameter setting changes from original default values.
- **Setup Group:** Access a list of commonly used parameters to simplify setup.
- **Parameter Setting Mode:** Access and edit all parameter settings.
- **Auto-Tuning:** Automatically calculates and sets motor parameters for Open Loop or PM Vector control to optimize the drive for the motor characteristics.

The Setup Group within the Programming Mode

In Setup Group, the user can access the minimum group of parameters required to operate the application.

Note: Setup Group parameters are listed in *Table 4.4*.

Note: Pressing **ENTER** from **APPL** navigates to the Application Preset setting display. When the set value is changed, the parameter is changed to the optimum value for each application. It is set to 0 (General-purpose) prior to shipment. *Refer to Application Selection on page 96.*

Figure 4.5 illustrates the keys to press to enter the Setup Group.

In this example, the source of the frequency reference is changed from the control circuit terminals to the LED Operator (i.e., b1-01 is changed from 1 to 0).

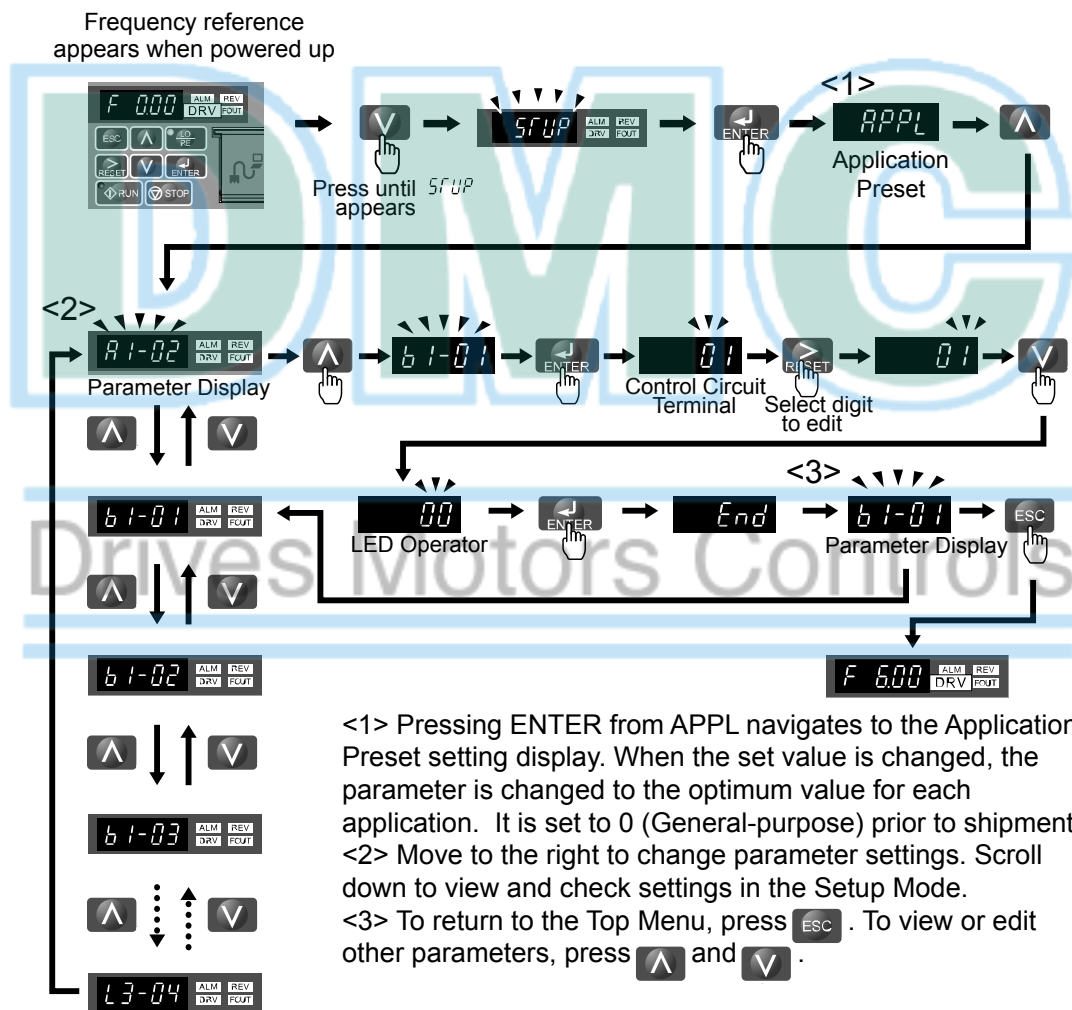

Figure 4.5 Setup Group Example

4.3 The Drive and Programming Modes

◆ Changing Parameter Settings or Values

This example explains changing C1-01 (Acceleration Time 1) from 10.0 seconds (default) to 20.0 seconds.

Step			Display/Result
1.	Turn on the power to the drive. The initial display appears.	→	
2.	Press the key until the Setup Mode Screen appears.	→	
3.	Press the key to view the parameter setting display.	→	
4.	Scroll through parameters by pressing the key until C1-01 appears.	→	
5.	Press to view the current setting value (10.0). (Number farthest to the left flashes)	→	
6.	Press until the desired number is selected. ("1" flashes)	→	
7.	Press the key and enter 0020.0.	→	
8.	Press and the drive will confirm the change.	→	
9.	The display automatically returns to the screen shown in Step 4.	→	
10.	Press the key until back at the initial display.	→	

◆ Verifying Parameter Changes: Verify Menu

The Verify Menu lists edited parameters from the Programming Mode or as a result of Auto-Tuning. The Verify Menu helps determine which settings have been changed, and is particularly useful when replacing a drive. If no settings have been changed, the Verify Menu will read *none*. The Verify menu also allows users to access and re-edit previously edited parameters.

Note: The Verify Menu will not display A1-□□ parameters (except for A1-02), nor will it display parameters A2-01 to A2-32 or E5-01 even if those parameters have been changed from default settings.

The following example is a continuation of the steps beginning on page 88. Here, parameter C1-01 is accessed using the Verify Menu and is changed again to 20.0 s.

To check the list of edited parameters:

Step			Display/Result
1.	Turn on the power to the drive. The initial display appears.	→	
2.	Press until the display shows the "Verify" representation.	→	
3.	Press to enter the list of parameters that have been edited from their original default settings. Scroll through the list by pressing the key.	→	
4.	Press the key until C1-01 appears.	→	
5.	Press the key to access the setting value. (number farthest to the left flashes)	→	

◆ Switching Between LOCAL and REMOTE

Entering the run command using the LED operator is referred to as LOCAL, while entering the run command from an external device via the control circuit terminals or network option is referred to as REMOTE.

WARNING! Sudden Movement Hazard. The drive may start unexpectedly if the Run command is already applied when switching from LOCAL mode to REMOTE mode when b1-07 = 1, resulting in death or serious injury. Be sure all personnel are clear of rotating machinery and electrical connections prior to switching between LOCAL mode and REMOTE mode.

There are two ways to switch between LOCAL and REMOTE.

Note: 1. After selecting LOCAL, the LO/RE light will remain lit.

2. The drive will not allow the user to switch between LOCAL and REMOTE during run.

■ Using the LO/RE Key on the LED Operator

Step		Display/Result
1.	Turn on the power to the drive. The initial display appears.	
2.	Press . The LO/RE light will light up. The drive is now in Local. To set the drive for REMOTE operation, press the key again.	

■ Using Input Terminals S1 through S7 to Switch between LO/RE

Switch between LOCAL and REMOTE using one of the digital input terminals S1 through S7 (set the corresponding parameter H1-01 through H1-07 to 1).

Follow the example below to set the digital input terminals.

- Note:**
1. Refer to [Parameter List on page 353](#) for a list of digital input selections.
 2. Setting a multi-function input terminal to a value of 1 disables the LO/RE key on the LED operator.

◆ Parameters Available in the Setup Group

■ Setup Mode (STUP)

Parameters used for this drive are classified into A to U. To simplify the drive setup, frequently used parameters are selected and input into Setup Mode.

1. To set a parameter, the Setup Mode must be displayed first. Press the Up/Down key until *STUP* is displayed.
2. Select the parameter and change the setting. [Table 4.4](#) lists parameters available in the Setup group. If the desired parameter cannot be set in the Setup mode, use the Parameter Setting mode.

- Note:**
1. When parameter A1-02 (Control Method Selection) is changed, some parameter set values are also changed automatically.
 2. Use the “Par” menu in the Programming mode to access parameters not listed in the Setup Group.
 3. Display parameters depend on A1-06. [Refer to Application Selection on page 96.](#)

Table 4.4 Setup Group Parameters

Parameter	Name	Parameter	Name
A1-02	Control Method Selection	E1-01	Input Voltage Reference
b1-01	Frequency Reference Selection 1	E1-03	V/f Pattern Selection
b1-02	Run Command Selection 1	E1-04	Maximum Output Frequency
b1-03	Stop Method Selection	E1-05	Maximum Voltage
C1-01	Acceleration Time 1	E1-06	Base Frequency
C1-02	Deceleration Time 1	E1-09	Minimum Output Frequency
C6-01	Duty Selection	E1-13	Base Voltage
C6-02	Carrier Frequency Selection	E2-01	Motor Rated Current
d1-01	Frequency Reference 1	E2-04	Number of Motor Poles
d1-02	Frequency Reference 2	E2-11	Motor Rate Capacity
d1-03	Frequency Reference 3	H4-02	Terminal AM Gain Setting
d1-04	Frequency Reference 4	L1-01	Motor Protection Function Selection
d1-17	Jog Frequency Reference	L3-04	Stall Prevention Selection during Deceleration

4.4 Start-up Flowcharts

The flowcharts in this section summarize basic steps required to start the drive. Use the flowcharts to determine the most appropriate start-up method for a given application. The charts are intended as a quick reference to help familiarize the user with start-up procedures.

Flowchart	Subchart	Objective	Page
A		Basic startup procedure and motor tuning.	91
	A-1	Simple motor setup with Energy Savings or Speed Search using V/f mode.	92
	A-2	High-performance operation using Open Loop Vector (OLV) motor control.	93
	A-3	Operation with Permanent Magnet (PM) motors.	94
	-	Setup of drive using application specific selections. <i>Refer to Application Selection on page 96.</i>	-

The logo consists of the letters 'D', 'M', and 'C' in a large, bold, light blue font with a white outline. The letters are spaced out and centered horizontally.The tagline 'Drives Motors Controls' is written in a grey, sans-serif font. It is positioned below the logo and is flanked by two horizontal blue lines, one above and one below the text.

◆ **Flowchart A: Basic Start-up and Motor Tuning**

Figure 4.6, Flowchart A, describes basic start-up sequence for the drive and motor system. This sequence varies slightly depending on application. Use drive default parameter settings in simple applications that do not require high precision.

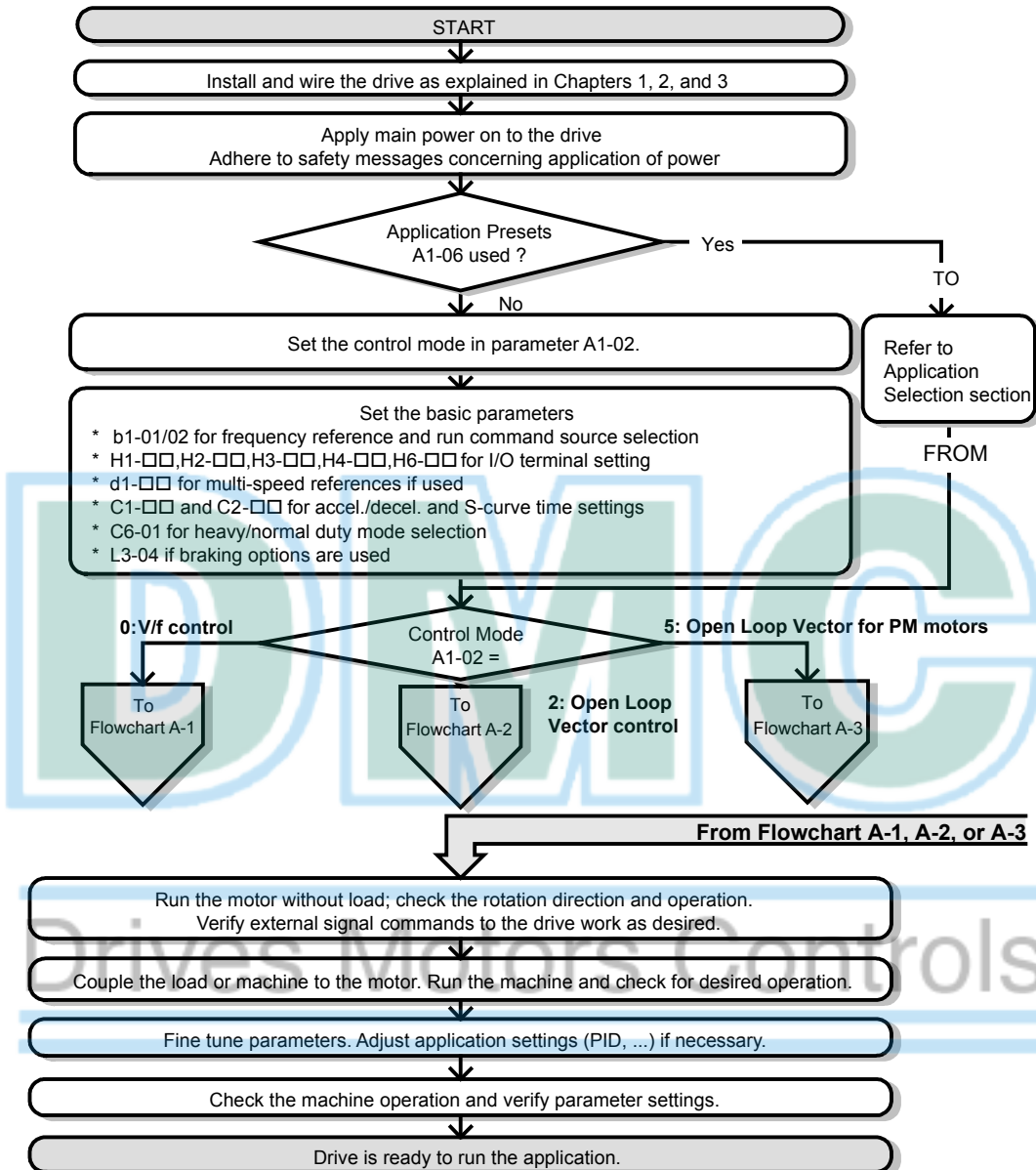

Figure 4.6 Basic Start-up and Motor Tuning

◆ **Subchart A1: Simple Motor Setup with Energy Savings or Speed Search Using V/f Mode**

Figure 4.7, Flowchart A1, describes simple motor setup for V/f control. V/f Motor Control is suited for the most basic applications such as fans or pumps. This procedure illustrates using Energy Savings and Speed Estimation Speed Search. V/f control can be used where rotational auto-tuning cannot be performed.

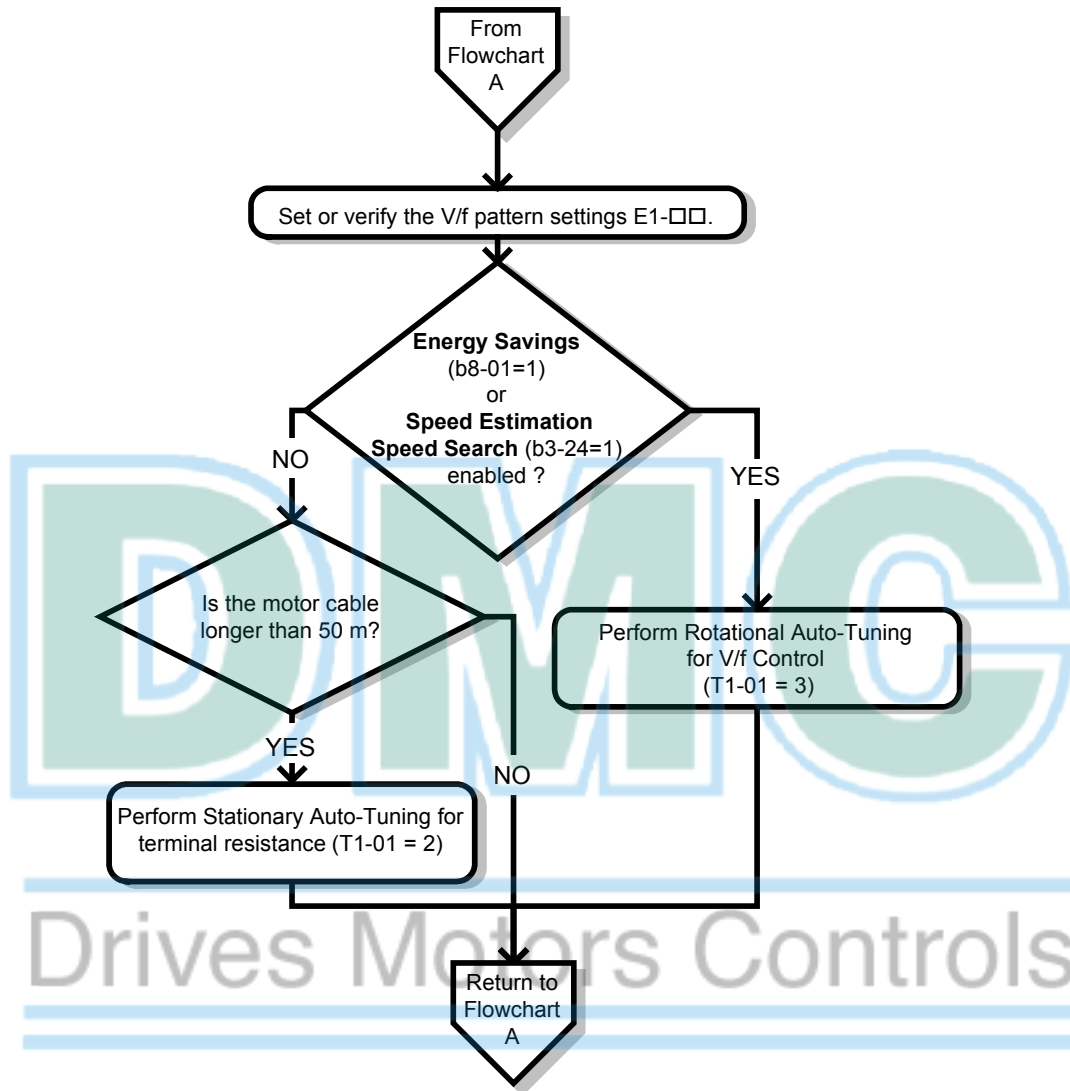

Figure 4.7 Simple Motor Set-Up with Energy Savings or Speed Search Using V/f Mode

◆ Subchart A2: High Performance Operation Using Open Loop Vector Motor Control

Figure 4.8, Flowchart A2, describes Open Loop Vector Control for high-performance motor operation. This is appropriate for applications requiring high starting torque, torque limits, and improved speed regulation.

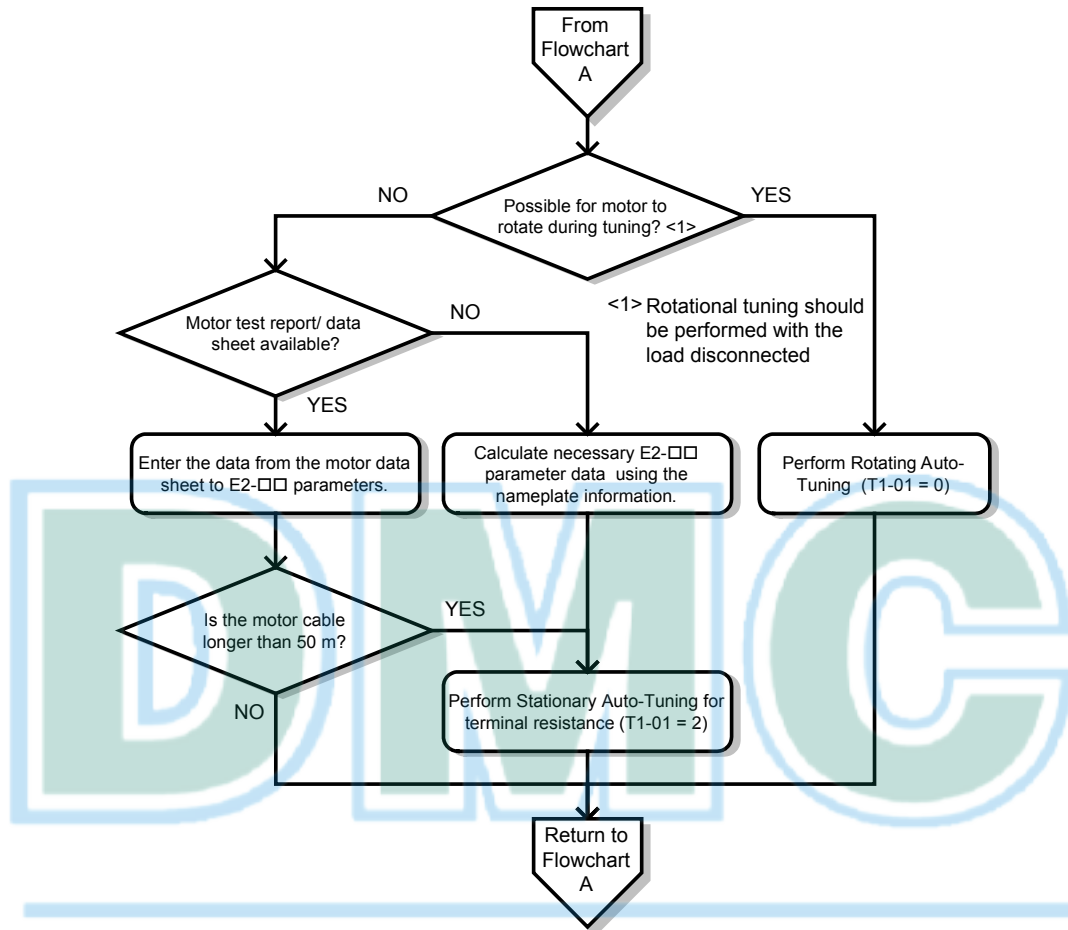

Figure 4.8 Flowchart A2: High Performance Operation Using Open Loop Vector Motor Control

◆ Subchart A3: Operation with Permanent Magnet Motors

Figure 4.9, Flowchart A3, describes tuning for PM motors in Open Loop Vector Control. PM motors can be used for energy savings in reduced or variable torque applications.

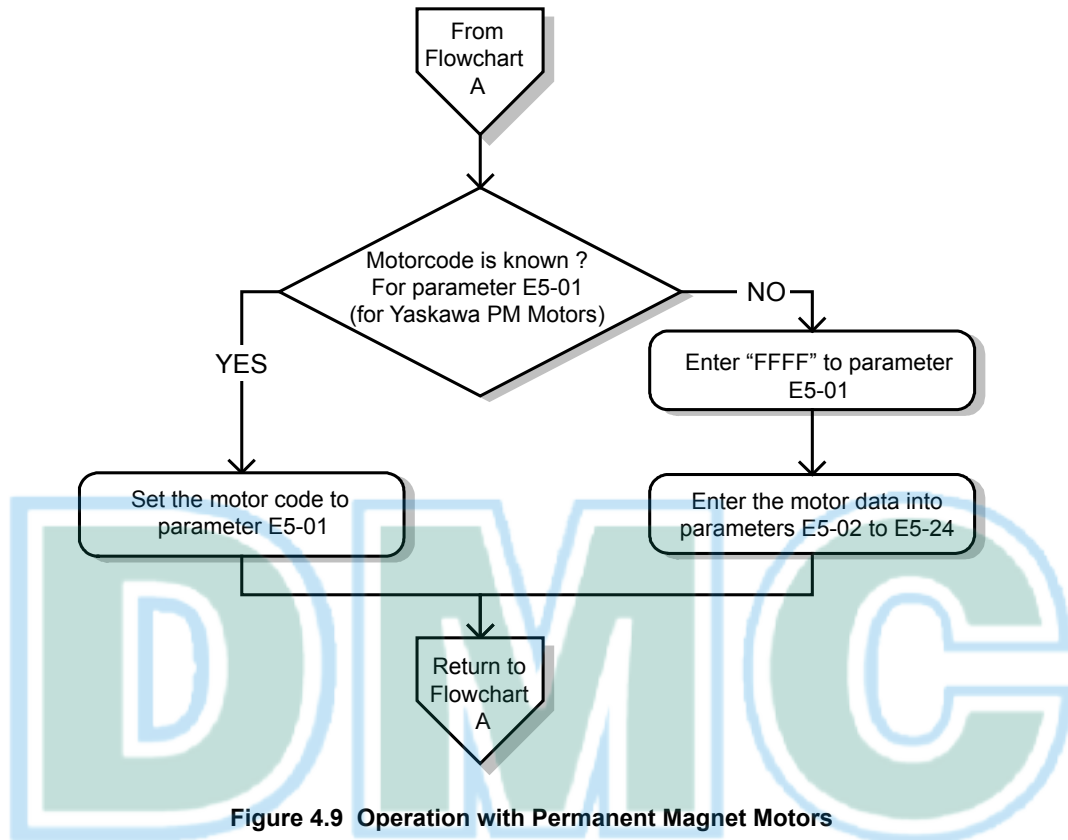

Figure 4.9 Operation with Permanent Magnet Motors

Drives Motors Controls

4.5 Powering Up the Drive

◆ Powering Up the Drive and Operation Status Display



■ Powering Up the Drive

Review the following checklist before turning the power on.

Item to Check	Description
Power supply voltage	Ensure the power supply voltage is correct: 200 V class: single-phase 200 to 240 Vac 50/60 Hz 200 V class: 3-phase 200 to 240 Vac 50/60 Hz 400 V class: 3-phase 380 to 480 Vac 50/60 Hz
	Properly wire the power supply input terminals (R/L1, S/L2, T/L3). (for single-phase 200 V class models, wire only R/L1 and S/L2)
	Check for proper grounding of drive and motor.
Drive output terminals and motor terminals	Properly wire drive output terminals U/T1, V/T2, and W/T3 with motor terminals U, V, and W.
Control circuit terminals	Check control circuit terminal connections.
Drive control terminal status	Open all control circuit terminals (off).
Status of the load and connected machinery	Uncouple the motor from the load.

■ Status Display

When the power supply to the drive is turned on, the LED operator lights will appear as follows:

No.	Name	Description
Normal Operation		The data display area displays the frequency reference. [DRV] is lit.
Fault	 Main circuit low voltage (ex)	Data displayed varies by the type of fault. <i>Refer to Fault Displays, Causes, and Possible Solutions on page 267</i> for more information and possible solution. [ALM] and [DRV] are lit.

Note: Display will vary depending on drive settings.

Drives Motors Controls

4.6 Application Selection

Several Application Presets are available to facilitate drive setup for commonly used applications. Selecting one of these Application Presets automatically sets the required parameters to the Application Preset default values and selects I/Os. In addition, the parameters most likely to be changed are assigned to the list of User Parameters, A2-01 through A2-16. These can be accessed in the Setup Mode and provide quicker application adjustment by eliminating the need to scroll through multiple menus.

The following presets can be selected:

- Note:**
1. Do not set any value outside the allowable range for A1-06. Setting an out-of-range value will cause “APPL” to flash on the display in the Setup group and disable the up and down arrow keys on the digital operator. To fix this error, press the ESC key to return to the Setup group and then it will then be possible to switch to another mode using the up and down arrow keys.
 2. A1-06 setting can only be changed by initializing the drive by first setting A1-03 to 2220. Setting A1-06 to a value that is out of range will not adversely affect drive operation. When the drive should not be initialized because initialization will cause other problems, then A1-06 does not need to be changed.

WARNING! Confirm the drive I/O signals and external sequence before performing a test run. Setting parameter A1-06 may change the I/O terminal function automatically from the default setting. Failure to comply may result in death or serious injury.

No.	Parameter Name	Setting Range	Default
A1-06	Application Preset	0: Disabled 1: Water supply pump 2: Conveyor 3: Exhaust fan 4: HVAC 5: Compressor <1> 8: Conveyor 2 <2>	0

- <1> Application Preset settings 6 and 7 are only available in drive software versions PRG: 5010, PRG: 1010, and PRG: 1011. To determine the drive software version, refer to the PRG: field on the drive nameplate or drive parameter U1-25.
- <2> Available in drive software versions PRG: 1020 and later.

◆ Setting 1: Water Supply Pump Application

Table 4.5 Water Supply Pump Parameter Settings

No.	Name	Default Setting
A1-02	Control Method Selection	0: V/f Control
b1-04	Reverse Operation Selection	1: Reverse Prohibited
C1-01	Acceleration Time 1	1.0 s
C1-02	Deceleration Time 1	1.0 s
C6-01	Drive Duty Selection	1: Normal Duty
E1-03	V/f Pattern Selection	0FH
E1-07	Middle Output Frequency	30.0 Hz
E1-08	Middle Output Frequency Voltage	50.0 V
L2-01	Momentary Power Loss Operation Selection	1: Enabled
L3-04	Stall Prevention Selection during Deceleration	1: Enabled

Table 4.6 Water Supply Pump: User Parameters (A2-01 to A2-16)

No.	Parameter Name	No.	Parameter Name
b1-01	Frequency Reference Selection 1	E1-08	Middle Output Frequency Voltage
b1-02	Run Command Selection 1	E2-01	Motor Rated Current
b1-04	Reverse Operation Selection	H1-05	Multi-Function Digital Input Terminal S5 Function Selection
C1-01	Acceleration Time 1	H1-06	Multi-Function Digital Input Terminal S6 Function Selection
C1-02	Deceleration Time 1	H1-07	Multi-Function Digital Input Terminal S7 Function Selection
E1-03	V/f Pattern Selection	L5-01	Number of Auto Restart Attempts

No.	Parameter Name	No.	Parameter Name
E1-07	Middle Output Frequency	–	–

◆ Setting 2: Conveyor Application

Table 4.7 Conveyor: Parameter Settings

No.	Parameter Name	Default Setting
A1-02	Control Method Selection	0: V/f Control
C1-01	Acceleration Time 1	3.0 s
C1-02	Deceleration Time 1	3.0 s
C6-01	Drive Duty Selection	0: Heavy Duty
L3-04	Stall Prevention Selection during Deceleration	1: Enabled

Table 4.8 Conveyor: User Parameters (A2-01 to A2-16)

No.	Parameter Name	No.	Parameter Name
A1-02	Control Method Selection	C1-02	Deceleration Time 1
b1-01	Frequency Reference Selection 1	E2-01	Motor Rated Current
b1-02	Run Command Selection 1	L3-04	Stall Prevention Selection during Deceleration
C1-01	Acceleration Time 1	–	–

◆ Setting 3: Exhaust Fan Application

Table 4.9 Exhaust Fan: Parameter Settings

No.	Parameter Name	Default Setting
A1-02	Control Method Selection	0: V/f Control
b1-04	Reverse Operation Selection	1: Reverse Prohibited
C6-01	Drive Duty Selection	1: Normal Duty
E1-03	V/f Pattern Selection	0FH
E1-07	Middle Output Frequency	30.0 Hz
E1-08	Middle Output Frequency Voltage	50.0 V
L2-01	Momentary Power Loss Operation Selection	1: Enabled
L3-04	Stall Prevention Selection during Deceleration	1: Enabled

Table 4.10 Exhaust Fan: User Parameters (A2-01 to A2-16)

No.	Parameter Name	No.	Parameter Name
b1-01	Frequency Reference Selection 1	E1-07	Middle Output Frequency
b1-02	Run Command Selection 1	E1-08	Middle Output Frequency Voltage
b1-04	Reverse Operation Selection	E2-01	Motor Rated Current
b3-01	Speed Search Selection at Start	H1-05	Multi-Function Digital Input Terminal S5 Function Selection
C1-01	Acceleration Time 1	H1-06	Multi-Function Digital Input Terminal S6 Function Selection
C1-02	Deceleration Time 1	H1-07	Multi-Function Digital Input Terminal S7 Function Selection
E1-03	V/f Pattern Selection	L5-01	Number of Auto Restart Attempts

◆ Setting 4: HVAC Fan Application

Table 4.11 HVAC Fan: Parameter Settings

No.	Parameter Name	Default Setting
A1-02	Control Method Selection	0: V/f Control
b1-04	Reverse Operation Selection	1: Reverse Prohibited

4.6 Application Selection

No.	Parameter Name	Default Setting
C6-01	Drive Duty Selection	1: Normal Duty
C6-02	Carrier Frequency Selection	3: 8.0 kHz
H2-03	Terminals P2 Function Selection	39: Watt Hour Pulse Output
L2-01	Momentary Power Loss Operation Selection	2: CPU Power Active - Drive will restart if power returns prior to control power supply shut down.
L8-03	Overheat Pre-Alarm Operation Selection	4: Operation at lower speed
L8-38	Carrier Frequency Reduction	2: Enabled across entire frequency range.

Table 4.12 HVAC Fan: User Parameters (A2-01 to A2-16)

No.	Parameter Name	No.	Parameter Name
b1-01	Frequency Reference Selection 1	E1-03	V/f Pattern Selection
b1-02	Run Command Selection 1	E1-04	Maximum Output Frequency
b1-04	Reverse Operation Selection	E2-01	Motor Rated Current
C1-01	Acceleration Time 1	H3-11	Terminal A2 Gain Setting
C1-02	Deceleration Time 1	H3-12	Terminal A2 Bias Setting
C6-02	Carrier Frequency Selection	L2-01	Momentary Power Loss Operation Selection
d2-01	Frequency Reference Upper Limit	L8-03	Overheat Pre-Alarm Operation Selection
d2-02	Frequency Reference Lower Limit	o4-12	kWh Monitor Initialization

◆ Setting 5: Compressor Application

Table 4.13 Compressor: Parameter Settings

No.	Parameter Name	Default Setting
A1-02	Control Method Selection	0: V/f Control
b1-04	Reverse Operation Selection	1: Reverse Prohibited
C1-01	Acceleration Time 1	5.0 s
C1-02	Deceleration Time 1	5.0 s
C6-01	Drive Duty Selection	0: Heavy Duty
E1-03	V/f Pattern Selection	0FH
L2-01	Momentary Power Loss Operation Selection	1: Enabled
L3-04	Stall Prevention Selection during Deceleration	1: Enabled

Table 4.14 Compressor: User Parameters (A2-01 to A2-16):

No.	Parameter Name	No.	Parameter Name
b1-01	Frequency Reference Selection 1	E1-03	V/f Pattern Selection
b1-02	Run Command Selection 1	E1-07	Middle Output Frequency
b1-04	Reverse Operation Selection	E1-08	Middle Output Frequency Voltage
C1-01	Acceleration Time 1	E2-01	Motor Rated Current
C1-02	Deceleration Time 1	–	–

◆ Setting 6: Preset 6

- Note:**
1. Read the instructions listed in *Notes on Controlling the Brake when Using Application Preset 6* on page 99 when using Application Preset 6
 2. Perform Auto-Tuning after selecting Application Preset 6.
 3. If UL3 appears on the operator display after Auto-Tuning is complete, set L6-01 to “0” to repeat the Auto-Tuning process.

Table 4.15 Preset 6: Parameters and Settings

No.	Parameter Name	Default Setting
A1-02	Control Method Selection	2: Open Loop Vector Control
b1-01	Frequency Reference Selection 1	0: Operator

No.	Parameter Name	Default Setting
b6-01	Dwell Reference at Start	3.0 Hz
b6-02	Dwell Time at Start	0.3 s
C1-01	Acceleration Time 1	3.0 s
C1-02	Deceleration Time 1	3.0 s
C6-01	Drive Duty Selection	0: Heavy Duty
C6-02	Carrier Frequency Selection	2: 5 kHz
d1-01	Frequency Reference 1	6.0 Hz
d1-02	Frequency Reference 2	30.0 Hz
d1-03	Frequency Reference 3	60.0 Hz
E1-03	V/f Pattern Selection	0FH
H2-02	Terminals P1 Function Selection	37: During Frequency Output
H2-03	Terminals P2 Function Selection	5: Frequency Detection 2
L2-03	Momentary Power Loss Minimum Baseblock Time	0.3 s
L3-04	Momentary Power Loss Voltage Recovery Ramp Time	0: Disabled
L4-01	Speed Agreement Detection Level	2.0 Hz
L4-02	Speed Agreement Detection Width	0.0 Hz
L6-01	Torque Detection Selection 1	8: UL3 at RUN - Fault
L6-02	Torque Detection Level 1	5%
L6-03	Torque Detection Time 1	0.5 s
L8-05	Input Phase Loss Protection Selection	1: Enabled <1>
L8-07	Output Phase Loss Protection Selection	1: Enabled
L8-38	Carrier Frequency Reduction	1: Enabled below 6 Hz
L8-41	High Current Alarm Selection	1: Enabled (alarm is output)

<1> Disable L8-05 for single-phase models.

Table 4.16 Preset 6: User Parameters (A2-01 to A2-16):

No.	Parameter Name	No.	Parameter Name
A1-02	Control Method Selection	d1-02	Frequency Reference 2
b1-01	Frequency Reference Selection 1	d1-03	Frequency Reference 3
b6-01	Dwell Reference at Start	E1-08	Middle Output Frequency Voltage
b6-02	Dwell Time at Start	H2-01	Terminals MA, MB, and MC Function Selection
C1-01	Acceleration Time 1	L1-01	Motor Overload Protection Selection
C1-02	Deceleration Time 1	L4-01	Speed Agreement Detection Level
C6-02	Carrier Frequency Selection	L6-02	Torque Detection Level 1
d1-01	Frequency Reference 1	L6-03	Torque Detection Time 1

◆ Notes on Controlling the Brake when Using Application Preset 6

The frequency detection function is used for controlling the brake.

When an external Baseblock command is present while a Run command is active, the frequency reference will be kept as long as the Run command is active. To avoid improper brake operation make sure that frequency detection is set so that the brake does not open during Baseblock (L4-07 = "0", default).

The table below shows how to set up the drive when using output terminals P2-PC as brake control output.

Brake Open/Close		Brake Activation Level		Control Mode		
Function	Parameter	Signal	Parameter	V/f	OLV	OLV for PM
Frequency Detection 2	L4-07 = 0	Frequency Detection Level	L4-01 = 1.0 to 3.0 Hz <1>	0	0	-
	H2-03 = 5	Frequency Detection Width	L4-02 = 0.0 to 0.5 Hz <2>			

4.6 Application Selection

- <1> This is the setting recommended when using Open Loop Vector Control. In V/f Control, set the level as the motor rated slip frequency plus 0.5 Hz. Not enough motor torque will be created if this value is set too low, and the load may tend to slip. Make sure this value is greater than the minimum output frequency and greater than the value of L4-02 as shown in the diagram below. If set too high, however, there may be a jolt at start.
- <2> Hysteresis for Frequency Detection 2 can be adjusted by changing the Frequency Detection Width (L4-02) between 0.0 and 0.5 Hz. If the load slips during stop, make changes in steps of 0.1 Hz until the load no longer slips.

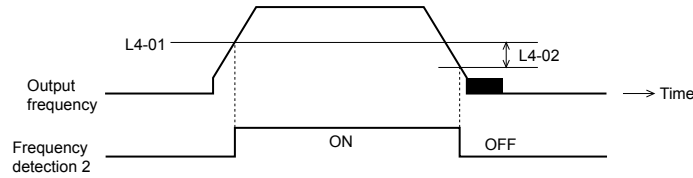

Figure 4.10 Frequency Detection 2

The braking sequence should be designed as follows:

- A normally open signal (N.O.) should be used to control the brake so that it is released when terminal P2-PC closes.
- When an Up or Down command is entered, the brake should release.
- When a fault signal is output, the brake should close.
- When changing the speed using an analog signal, make sure that the source of the frequency reference is assigned to the control circuit terminals (b1-01 = 1).
- A sequence to open and close the holding brake appears in the diagram below.

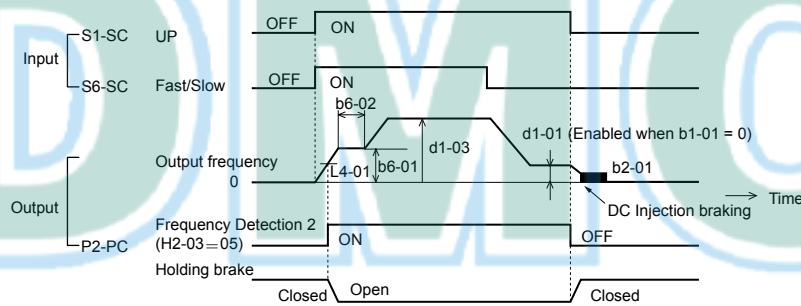

Figure 4.11 Holding Brake Time Chart

◆ Setting 7: Preset 7

Table 4.17 Preset 7: Parameters and Settings

No.	Parameter Name	Default Setting
A1-02	Control Method Selection	0: V/f Control
b1-01	Frequency Reference Selection 1	0: Operator
C1-01	Acceleration Time 1	3.0 s
C1-02	Deceleration Time 1	3.0 s
C6-01	Drive Duty Selection	0: Heavy Duty
C6-02	Carrier Frequency Selection	2: 5 kHz
d1-01	Frequency Reference 1	6.0 Hz
d1-02	Frequency Reference 2	30.0 Hz
d1-03	Frequency Reference 3	60.0 Hz
H1-05	Multi-Function Digital Input Terminal S5 Function	3: Multi-Step Speed 1
H1-06	Multi-Function Digital Input Terminal S6 Function	4: Multi-Step Speed 2
H2-02	Terminals P1 Function Selection	37: During frequency output
L3-04	Stall Prevention Selection during Deceleration	0: Disabled
L8-05	Input Phase Loss Protection Selection	1: Enabled <I>

No.	Parameter Name	Default Setting
L8-07	Output Phase Loss Protection Selection	1: Triggered when a single phase is lost
L8-38	Carrier Frequency Reduction	1: Enabled below 6 Hz
L8-41	High Current Alarm Selection	1: Enabled (alarm output)

<1> Disable L8-05 for single-phase models.

Table 4.18 Preset 7: User Parameters (A2-01 to A2-16):

No.	Parameter Name	No.	Parameter Name
b1-01	Frequency Reference Selection 1	d1-03	Frequency Reference 3
C1-01	Acceleration Time 1	E2-01	Motor Rated Current
C1-02	Deceleration Time 1	H1-05	Multi-Function Digital Input Terminal S5 Function
C6-02	Carrier Frequency Selection	H1-06	Multi-Function Digital Input Terminal S6 Function
d1-01	Frequency Reference 1	H2-01	Terminals MA, MB, and MC Function Selection
d1-02	Frequency Reference 2	L1-01	Motor Overload Protection Selection

◆ Setting 8: Conveyor Application 2

This setting is available in drive software versions PRG: 1020 and later.

Table 4.19 Conveyor 2: Parameters and Settings

No.	Parameter Name	Default Setting
A1-02	Control Method Selection	0: V/f Control
C1-01	Acceleration Time 1	3.0 s
C1-02	Deceleration Time 1	3.0 s
C6-01	Drive Duty Selection	0: Heavy Duty
L3-04	Stall Prevention Selection during Deceleration	0: Disabled
n3-13	Overexcitation Deceleration Gain	1.4
n3-21	High-Slip Suppression Current Level	150%

Table 4.20 Conveyor 2: User Parameters (A2-01 to A2-16):

No.	Parameter Name	No.	Parameter Name
A1-02	Control Method Selection	E2-01	Motor Rated Current
b1-01	Frequency Reference Selection 1	L3-04	Stall Prevention Selection during Deceleration
b1-02	Run Command Selection 1	n3-13	Overexcitation Deceleration Gain
C1-01	Acceleration Time 1	n3-21	High-Slip Suppression Current Level
C1-02	Deceleration Time 1	–	–

4.7 Auto-Tuning

◆ Types of Auto-Tuning

There are three types of Auto-Tuning. Select the best type of Auto-Tuning for the application. *Refer to Auto-Tuning Procedure on page 103.*

Type	Setting	Application Conditions and Benefits	Control Mode
Rotational Auto-Tuning for V/f Control	T1-01 = 3	<ul style="list-style-type: none"> Assumes the motor can rotate during the Auto-Tuning process Improves torque compensation, slip compensation, energy savings, and Speed Search performance Should be performed when Speed Estimation Type Speed Search or Energy Saving is used in V/f Control 	V/f Control
Rotational Auto-Tuning for OLV Control	T1-01 = 0	<ul style="list-style-type: none"> Assumes the motor can rotate during the Auto-Tuning process Achieves high-performance motor control and should be performed whenever Open Loop Vector Control is used 	Open Loop Vector Control
Stationary Auto-Tuning for Line-to-Line Resistance (V/f and OLV Control)	T1-01 = 2	For use when: <ul style="list-style-type: none"> The motor cable exceeds 50 m The motor cable length has been modified after Auto-Tuning has been previously performed When motor capacity and drive capacity differ 	V/f Control, Open Loop Vector Control

Note: Auto-Tuning cannot be performed on permanent magnet motors (IPM, SPM, etc.).

◆ Before Auto-Tuning the Drive

Check the items below before Auto-Tuning the drive.

■ Basic Auto-Tuning Preparations

- Auto-Tuning automatically determines the electrical characteristics of the motor. This is fundamentally different from other types of Auto-Tuning features used in servo systems.
- Auto-Tuning requires the user to input data from the motor nameplate. Make sure the information written on the nameplate is available before Auto-Tuning the drive.
- For best performance, be sure the drive input supply voltage equals or exceeds the motor rated voltage.

Note: Performance can be enhanced by using a motor with a base voltage that is 20 V (40 V for 400 V class models) lower than the input supply voltage. This may be of special importance when operating the motor above 90% of base speed, where high torque precision is required.

- Auto-Tuning is not possible with permanent magnet motors.
- To cancel Auto-Tuning, press the STOP key on the LED operator.
- [Table 4.21](#) describes digital input and output terminal status during Auto-Tuning.

Table 4.21 Digital Input and Output Operation During Auto-Tuning

Auto-Tuning Type	Digital Input	Digital Output
Rotational Auto-Tuning for V/f Control	Not available	Functions the same as during normal operation
Rotational Auto-Tuning for OLV Control	Not available	Functions the same as during normal operation
Stationary Auto-Tuning for Line-to-Line Resistance	Not available	Maintains the status at the start of Auto-Tuning

WARNING! Sudden Movement Hazard. Do not release the mechanical brake during stationary Auto-Tuning. Inadvertent brake release may cause damage to equipment or injury to personnel. Ensure that the mechanical brake release circuit is not controlled by the drive multi-function digital outputs.

Note: It is recommended that Rotational Auto-Tuning is performed with the load disconnected. Failure to comply could result in improper drive operation. If Rotational Auto-Tuning is performed for a motor coupled to a load, the motor constants will be inaccurate and the motor may exhibit abnormal operation. Disconnect or decouple the motor from the load.

■ Notes on Rotational Auto-Tuning

- For optimal performance, Auto-Tuning should only be done with the motor uncoupled from the load for applications requiring high performance over a wide speed range.
- If motor and load cannot be uncoupled, the load should be lower than 30% of the rated load. Performing Rotational Auto-Tuning with a higher load will set motor parameters incorrectly, and can cause irregular motor rotation.
- Ensure the motor-mounted brake is fully released if installed.

- Connected machinery should be allowed to rotate the motor.

■ Notes on Stationary Auto-Tuning for Terminal Resistance Only

- If the motor cable lead length has been significantly modified after Auto-Tuning has already been performed, perform Stationary Auto-Tuning with the new cables.
- Perform when using motor cables longer than 50 m with V/f Control.

WARNING! *Electrical Shock Hazard. When executing stationary Auto-Tuning for line-to-line resistance only, the motor does not rotate, however, power is applied. Do not touch the motor until Auto-Tuning is completed. Failure to comply may result in injury from electrical shock.*

◆ Auto-Tuning Interruption and Fault Codes

If tuning results are abnormal or the STOP key is pressed before completion, Auto-Tuning will be interrupted and a fault code will be displayed on the digital operator.

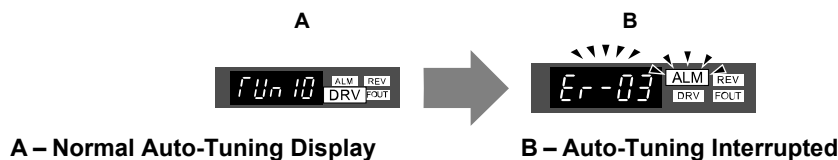

Figure 4.12 Auto-Tuning Interruption Display

◆ Performing Auto-Tuning

■ Auto-Tuning Procedure

Auto-Tuning should generally be performed in the following steps.

1. *Refer to Before Auto-Tuning the Drive on page 102.*
2. Determine which type of Auto-Tuning best fits the application requirements following *Figure 4.13*.

Drives Motors Controls

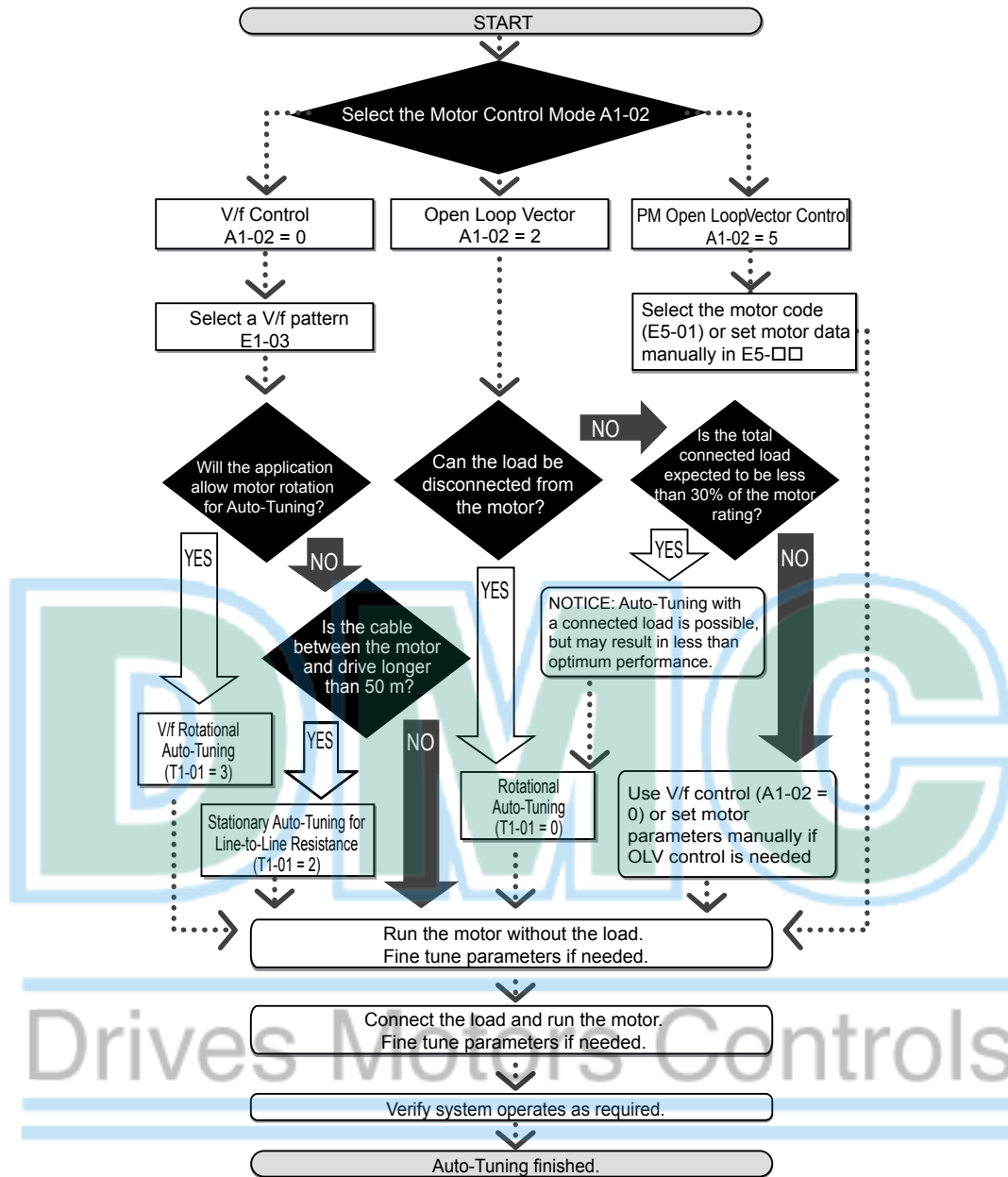

Figure 4.13 Auto-Tuning Selection

3. Enter the type of Auto-Tuning to parameter T1-01.
4. Enter the motor nameplate data.
5. Start the Auto-Tuning process when prompted by the drive.
6. If Auto-Tuning was successfully performed, do a test run without the load and make any necessary parameter adjustments.
7. If the test run was successful, do a test run with the load connected and make parameter adjustments if necessary.

◆ Auto-Tuning Example

The following example illustrates how to perform Rotational Auto-Tuning for Open Loop Vector Control (A1-02 = 2).

■ Set the Selected Type of Auto-Tuning

Step			Display/Result
1.	Turn on the power to the drive. The initial display appears.	→	
2.	Press the key until the Auto-Tuning display appears.	→	
3.	Press to begin setting parameters.	→	
4.	Press to display the value for T1-01.	→	
5.	Press to select the digit to edit.	→	
6.	Press and set the drive to perform Rotational Auto-Tuning (00).	→	
7.	Save the setting by pressing .	→	
8.	The display automatically returns to the display shown in Step 3.	→	

■ Enter Data from the Motor Nameplate

After selecting the type of Auto-Tuning, enter the data required from the motor nameplate.

Note: These instructions continue from Step 8 in “Set the Selected Type of Auto-Tuning”.

Step			Display/Result
1.	Press to access the motor output power parameter T1-02.	→	
2.	Press to view the default setting.	→	
3.	Press to select the digit to edit.	→	
4.	Press and enter the motor power nameplate data in kW.	→	
5.	Press to save the setting.	→	
6.	The display automatically returns to the display in Step 1.	→	
7.	Repeat Steps 1 through 5 to set the following parameters: <ul style="list-style-type: none"> • T1-03, Motor Rated Voltage • T1-04, Motor Rated Current • T1-05, Motor Base Frequency • T1-06, Number of Motor Poles • T1-07, Motor Base Speed 	→	 ↓

- Note:**
1. For the details on each setting, [Refer to Input Data for Auto-Tuning on page 106.](#)
 2. For Stationary Auto-Tuning for Line-to-Line resistance only, set T1-02 and T1-04.

■ Starting Auto-Tuning

WARNING! Sudden Movement Hazard. The drive and motor may start unexpectedly during Auto-Tuning, which could result in death or serious injury. Ensure the area surrounding the drive motor and load are clear before proceeding with Auto-Tuning.

WARNING! Electrical Shock Hazard. High voltage will be supplied to the motor when Stationary Auto-Tuning is performed even with the motor stopped, which could result in death or serious injury. Do not touch the motor until Auto-Tuning has been completed.





NOTICE: Rotational Auto-Tuning will not function properly if a holding brake is engaged on the load. Failure to comply could result in improper operation of the drive. Ensure the motor can freely spin before beginning Auto-Tuning.

4.7 Auto-Tuning

NOTICE: Never perform Rotational Auto-Tuning for a motor connected to a load. Failure to comply could result in improper drive operation. If Rotational Auto-Tuning is performed for a motor coupled to a load, the motor parameters will be inaccurate and the motor may exhibit abnormal operation. Disconnect or decouple the motor from the load.

Enter the required information from the motor nameplate. Press  to proceed to the Auto-Tuning start display.

Note: These instructions continue from Step 7 in “Enter Data from the Motor Nameplate”.

Step			Display/Result
1.	After setting T1-07 as illustrated in the previous section, press  and confirm the display is as described below:	→	
2.	Press  to activate Auto-Tuning. DRV flashes. Note: The first digit indicates which motor is undergoing Auto-Tuning (motor 1 or motor 2). The second digit indicates the type of Auto-Tuning being performed.	→	
3.	Auto-Tuning finishes in approximately one to two minutes.	→	

◆ Input Data for Auto-Tuning

The T1-□□ parameters are used to set the Auto-Tuning input data.

- Note:**
1. Cycling power to the drive will reset any values set during the Auto-Tuning process to factory defaults.
 2. For motors that are to be operated in the field weakening range, first perform the Auto-Tuning with the base data, i.e. the frequency at which the motor is operating with its rated voltage (base frequency). After Auto-Tuning is complete, change the maximum frequency E1-04 to the desired value.

■ T1-00: Motor 1/Motor 2 Selection

Selects the motor to be tuned when motor 1/2 switching is enabled, i.e., a digital input is set for function H1-□□ = 16. This parameter is not displayed if motor 1/2 switching is disabled.

No.	Name	Setting Range	Default
T1-00	Motor 1/2 Selection	1 or 2	1

Setting 1: Motor 1

Auto-Tuning automatically sets parameters E1-□□ and E2-□□ for motor 1.

Setting 2: Motor 2

Auto-Tuning automatically sets parameters E3-□□ and E4-□□ for motor 2. Make sure that motor 2 is connected to the drive for Auto-Tuning.

■ T1-01: Tuning Mode Selection

Sets the type of Auto-Tuning to be used. [Refer to Types of Auto-Tuning on page 102](#) for details on different types of Auto-Tuning.

No.	Name	Setting Range	Default
T1-01	Auto-Tuning Mode Selection	0, 2 (OLV) 2, 3 (V/f)	0 (OLV) 2 (V/f)

Setting 0: Rotating Auto-Tuning for Open Loop Vector Control

Setting 2: Stationary Auto-Tuning for Line-to-Line Resistance

Setting 3: Rotating Auto-Tuning for V/f Control

■ T1-02: Motor Rated Power

Used to set the motor rated power according to the motor nameplate value. For optimal performance, the motor rated power should be between 50 and 100% of the drive rating.

No.	Name	Setting Range	Default
T1-02	Motor Rated Power	<>	Determined by o2-04 and C6-01

<1> The setting range differs based on drive software version.
PRG: 1016 and later: 0.03 to 650.00 kW

PRG: 1015 and earlier: 0.00 to 650.00 kW

■ T1-03: Motor Rated Voltage (T1-01 = 0 or 3)

Used to set the motor rated voltage according to the motor nameplate value. If the motor is used above its base speed, enter the voltage at base speed here.

For higher tuning precision and better control performance, enter the motor no-load voltage here if known. The motor no-load voltage is referred as to the voltage needed to operate the motor under no-load condition at its rated speed. Refer to the motor data sheet.

No.	Name	Setting Range	Default
T1-03	Motor Rated Voltage	0.0 to 255.5 V </>	200.0 V </>

<1> Values shown here are for 200 V class drives. Double values when using a 400 V class drive.

■ T1-04: Motor Rated Current

Used to set the motor rated current according to the motor nameplate value. For optimal performance in OLV, the motor rated current should be between 50 and 100% of the drive rating. Enter the current at the motor base speed.

No.	Name	Setting Range	Default
T1-04	Motor Rated Current	10 to 200% of drive rated current	Determined by o2-04 and C6-01

■ T1-05: Motor Rated Frequency (T1-01 = 0 or 3)

Used to set the motor rated frequency according to the motor nameplate value. If a motor with an extended speed range is used or the motor is used in the field weakening area, enter the base frequency here.

For higher tuning precision and better control performance, enter the motor no-load frequency here if known. The “no-load frequency” refers to the frequency needed to operate the motor under no-load condition at its rated speed. Refer to the motor data sheet.

No.	Name	Setting Range	Default
T1-05	Motor Base Frequency	0.0 to 400.0 Hz	60.0 Hz

■ T1-06: Number of Motor Poles (T1-01 = 0 or 3)

Used to set the number of motor poles according to the motor nameplate value.

No.	Name	Setting Range	Default
T1-06	Number of Motor Poles	2 to 48	4

■ T1-07: Motor Base Speed (T1-01 = 0 or 3)

Used to set the motor rated speed according to the motor nameplate value. If a motor with an extended speed range is used or the motor is used in the field weakening area, enter the speed at base frequency here.

No.	Name	Setting Range	Default
T1-07	Motor Base Speed	0 to 24000 r/min	1750 r/min

■ T1-11: Motor Iron Loss (T1-01 = 3)

Provides iron loss information for determining the Energy Saving coefficient. If E2-10 has been changed and the power has been cycled, the value set to E2-10 will appear as the default in T1-11. If the value of T1-02 is not changed during Auto-Tuning data input, the drive will select a value that is typical for the motor power entered to T1-02.

No.	Name	Setting Range	Default
T1-11	Motor Iron Loss	0 to 65535 W	Determined by o2-04 and C6-01

4.8 No-Load Operation Test Run

◆ No-Load Operation Test Run

This section explains how to operate the drive with the motor uncoupled from the load during a test run.

■ Before Starting the Motor

Check the following items before operation:

- Ensure the area around the motor is safe.
- Ensure external emergency stop circuitry is working properly and other safety precautions have been taken.

■ During Operation

Check the following items during operation:

- The motor should rotate smoothly (i.e., no abnormal noise or oscillation).
- The motor should accelerate and decelerate smoothly.

■ No-Load Operation Instructions

The following example illustrates a test run procedure using the digital operator.

Note: Before starting the motor, set the frequency reference d1-01 to 6 Hz.

Step		Display/Result
1.	Turn on the power to the drive. The initial display appears.	
2.	Press the key to select LOCAL. The LO/RE LED will turn on.	
3.	Press to give the drive a Run command. RUN will light and the motor will rotate at 6 Hz.	
4.	Ensure the motor is rotating in the correct direction and no faults or alarms occur.	
5.	If there is no error in step 4, press to increase the frequency reference. Increase the frequency in 10 Hz increments verifying smooth operation results at all speeds. For each frequency, monitor the drive output current (U1-03) through the LED operator to confirm the current is well below the motor rated current. Example: 6 Hz → 60 Hz.	
6.	The drive should operate normally. Press to stop the motor. RUN flashes until the motor comes to a complete stop.	

4.9 Test Run with Load Connected

◆ Test Run with the Load Connected

After performing a no-load test run connect the load and proceed to run the motor and load together.

■ Notes on Connected Machinery

- Clear the area around the motor.
- The motor should come to a complete stop without problems.
- Connect the machinery.
- Fasten all installation screws properly. Check that the motor and connected machinery are held in place.
- Confirm that the Fast-stop circuit or mechanical safety measures operate correctly.
- Be ready to press the STOP button in case of emergency.

■ Checklist Before Operation

- The motor should rotate in the proper direction.
- The motor should accelerate and decelerate smoothly.

■ Operating the Motor under Loaded Conditions

Test run the application similarly to the no-load test procedure when connecting the machinery to the motor.

- Check monitor parameter U1-03 to ensure there is no overcurrent.
- If the application permits running the load in the reverse direction, try changing motor direction and the frequency reference while watching for abnormal motor oscillation or vibration.
- Correct any problems that occurs with hunting, oscillation, or other control-related issues.

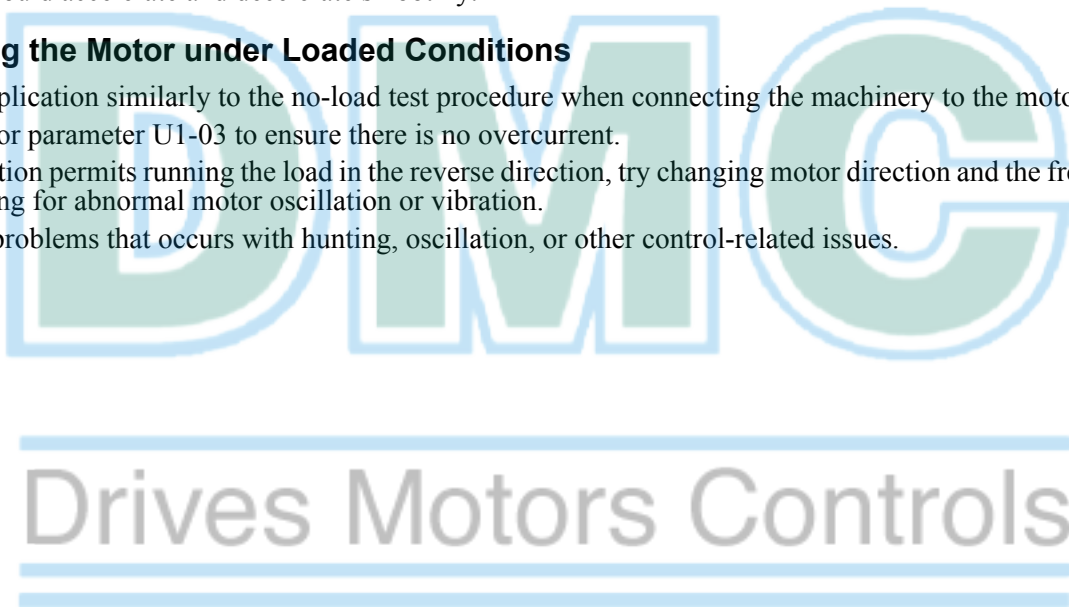

4.10 Verifying Parameter Settings and Backing Up Changes

Check changes to parameter settings as a result of Auto-Tuning using the Verify function. *Refer to Verifying Parameter Changes: Verify Menu on page 88.*

Save the verified parameter settings. Change the access level or set a password to the drive to prevent accidental modification of parameter settings.

◆ Backing Up Parameter Values: o2-03

Performing the following procedure stores all parameters settings to drive memory where they can later be recalled if necessary. Set o2-03 to “1” to save parameter changes. This saves all parameter settings, and then returns o2-03 to 0. The drive can now “recall” the saved parameters by performing a “user-initialization” (A1-03 = 1110).

No.	Parameter Name	Description	Setting Range	Default Setting
o2-03	User Parameter Default Value	Allows storing of parameter settings as a User Initialization Selection. 0: Saved/Not set 1: Set Defaults - Saves current parameter settings as user default settings. 2: Clear All - Clears the currently saved user settings. After saving the user parameter set value, the items of 1110 (User Parameter Initialize) are displayed in A1-03 (User Parameter Default Value).	0 to 2	0
A1-03	Initialize Parameters	Selects a method to initialize the parameters. 0: No Initialize 1110: User Initialize (The user must first program and store desired settings using parameter o2-03) 2220: 2-Wire Initialization (parameter initialized prior to shipment) 3330: 3-Wire Initialization 5550: oPE4 Fault reset	0 to 5550	0

◆ Parameter Access Level: A1-01



Setting the Access Level for “Operation only” (A1-01 = 0) allows the user to access parameters A1-□□ and U□-□□ only. Other parameters are not displayed.

Setting the Access Level for “User Parameters” (A1-01 = 1) allows the user to access parameters that have been previously saved as User Parameters. This is helpful when displaying only the relevant parameters for a specific application.

No.	Parameter Name	Description	Setting Range	Default
A1-01	Access Level Selection	Selects which parameters are accessible via the digital operator. 0: Operation only (A1-01, -04, and -06 can be set and monitored. U parameters can be monitored) 1: User Parameters (Only those recently changed among application parameters A2-01 to -16 and A2-17 to -32 can be set and monitored) 2: Advanced Access Level (All parameters can be set and monitored)	0 to 2	2
A2-01 to A2-32	User Parameters 1 to 32	Parameters selected by the user are stored to the User Parameter menu. This includes recently viewed parameters or parameters specifically selected for quick access. If parameter A2-33 is set to 1, recently viewed parameters will be listed between A2-17 and A2-32. Parameters A2-01 through A2-16 must be manually selected by the user. If A2-33 is set to 0, then recently viewed parameters will not be saved to the User Parameter group. The entire A2 parameter group is now available for manual programming.	b1-01 to o2-08	-
A2-33	User Parameter Automatic Selection	0: Parameters A2-01 through A2-32 are reserved for the user to create a list of User Parameters. 1: Save history of recently viewed parameters. Recently edited parameters will be saved to A2-17 through A2-32 for quick access. The most recently changed parameter is registered in A2-17. The second most recently changed parameter is registered in A2-18.	0, 1	1

◆ Password Settings: A1-04, A1-05

The user can set a password to the drive to restrict access. The password is selected via parameter A1-05. The selected password must be entered in parameter A1-04 to unlock parameter access (i.e., parameter setting A1-04 must match the value programmed into A1-05). The following parameters cannot be viewed or edited until the value programmed into A1-04 correctly matches the value as programmed in parameter A1-05: A1-01, A1-02, A1-03, A1-06 and A2-01 through A2-33.

Note: Parameter A1-05 is hidden from view. To display A1-05, access parameter A1-04 and simultaneously depress the  key and the  key.

◆ Copy Function (Optional)

Parameter settings can be copied to another drive to simplify parameter restoration or multiple drive setup. The drive supports the following options:

■ USB/Copy Unit (JVOP-181)

The copy unit is an external option connected to the drive to copy parameter settings to another drive. It includes a USB adapter to connect the drive to a PC.

■ LCD Operator (JVOP-180)

The LCD operator operates the drive and supports copying, importing, and verifying parameter settings using the parameters o3-01 and o3-02.

Note: Use of the LCD operator requires that the drive is running drive software version PRG: 1012 or later. The LCD operator is not compatible with drive software version PRG: 5010.

■ LED Operator (JVOP-182)

The LED operator operates the drive and supports copying, importing, and verifying parameter settings.

Note: Use of the LED operator requires that the drive is running drive software version PRG: 1014 or later. The LED operator is not compatible with version PRG: 5010.

■ Drive Wizard Plus

Drive Wizard Plus is a PC software tool for parameter management, monitoring, and diagnosis. Drive Wizard Plus can load, store, and copy drive parameter settings. For details, refer to Help in the Drive Wizard Plus software.

The installation files can be obtained at no charge from:

U.S.: <http://www.yaskawa.com>

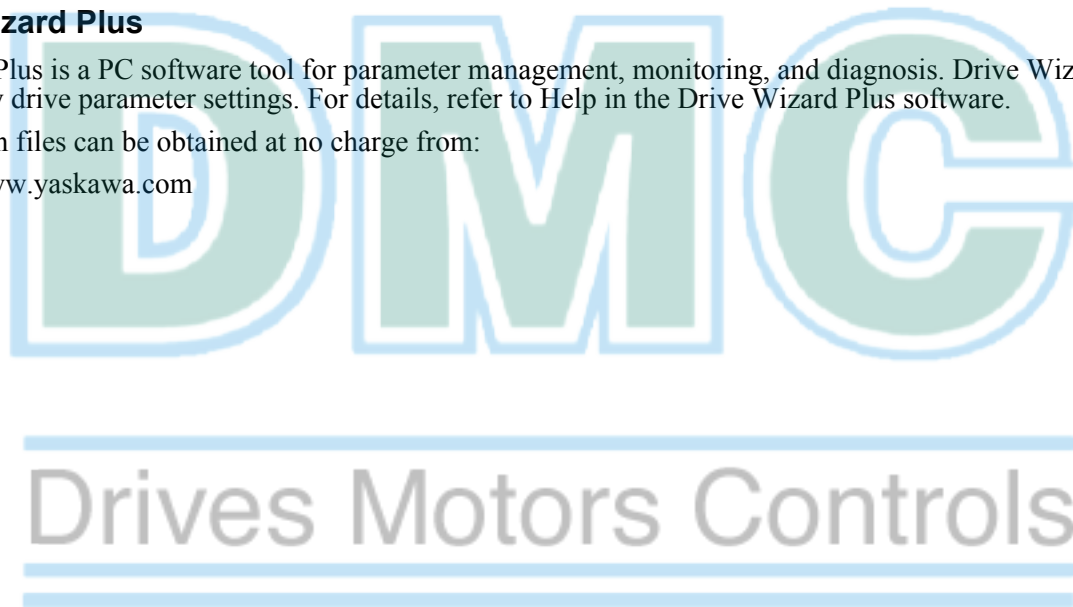

4.11 Test Run Checklist

4.11 Test Run Checklist

Review the checklist before performing a test run. Check each item that applies.

<input checked="" type="checkbox"/>	No.	Checklist	Page
<input type="checkbox"/>	1	Thoroughly read the manual before performing a test run.	–
<input type="checkbox"/>	2	Turn the power on.	95
<input type="checkbox"/>	3	Set the voltage for the power supply to E1-01.	169

Check the items that correspond to the control mode being used.

WARNING! Ensure start/stop and safety circuits are wired properly and in the correct state before energizing the drive. Failure to comply could result in death or serious injury from moving equipment. When programmed for 3-Wire control, a momentary closure on terminal S1 may cause the drive to start.

<input checked="" type="checkbox"/>	No.	Checklist	Page
V/f Control (A1-02 = 0)			
<input type="checkbox"/>	4	Select the best V/f pattern according to the application and motor characteristics. Example: If using a motor with a rated frequency of 60.0 Hz, set E1-03 to “1”.	–
<input type="checkbox"/>	5	Perform Auto-Tuning for Energy Savings if using Energy Saving functions.	102
Open Loop Vector Control (A1-02 = 2)			
<input type="checkbox"/>	6	Uncouple the load from the motor when performing Rotational Auto-Tuning.	102
<input type="checkbox"/>	7	Perform Rotational Auto-Tuning.	102
<input type="checkbox"/>	8	The following data entered during Auto-Tuning should match the information written on the motor nameplate: <ul style="list-style-type: none"> • motor rated output power (kW) → T1-02 • rated voltage (V) → T1-03 • rated current (A) → T1-04 • base frequency (Hz) → T1-05 • number of motor poles → T1-06 • motor rotations per minutes (r/min) → T1-07 	106
PM Open Loop Vector Control (A1-02 = 5)			
<input type="checkbox"/>	9	Set permanent motor parameters E5-01 through E5-24	94

Proceed to the following checklist after checking items 4 through 9.

<input checked="" type="checkbox"/>	No.	Checklist	Page
<input type="checkbox"/>	10	The DRV should illuminate after giving a run command.	–
<input type="checkbox"/>	11	To give a run command and frequency reference from the LED Digital Operator, press  to set to LOCAL. The LO/RE key lights while LOCAL is displayed.	89
<input type="checkbox"/>	12	If the motor rotates in the opposite direction during the test run, switch two of the drive output terminals (U/T1, V/T2, W/T3).	95
<input type="checkbox"/>	13	Select the correct duty rating (C6-01) for the application.	–
<input type="checkbox"/>	14	Set the correct values for the motor rated current (E2-01) and the motor protection selection (L1-01) to ensure motor thermal protection.	–
<input type="checkbox"/>	15	If the run command and frequency reference are provided via the control circuit terminals, set the drive for REMOTE and be sure the LO/RE light is out.	89
<input type="checkbox"/>	16	If the control circuit terminals should supply the frequency reference, select the correct voltage input signal level (0 to 10 V) or the correct current input signal level (4 to 20 mA or 0 to 20 mA).	89
<input type="checkbox"/>	17	Set the proper voltage to terminal A1. (0 to 10 V).	121
<input type="checkbox"/>	18	Set the proper current to terminal A2. (4 to 20 mA or 0 to 20 mA).	121
<input type="checkbox"/>	19	When current input is used, set H3-09 to “2” (4 to 20 mA) or “3” (0 to 20 mA) and set H3-10 to “0”.	–
<input type="checkbox"/>	20	When current input is used, switch the drive built-in DIP switch S1 from the V-side (OFF) to I-side (ON).	–

☑	No.	Checklist	Page
☐	21	Set the minimum and maximum frequency references to the desired values. Make the following adjustments if the drive does not operate as expected: Gain adjustment: Set the maximum voltage/current signal and adjust the analog input gain (H3-03 for input A1, H3-11 for input A2) until the frequency reference value reaches the desired value. Bias adjustment: Set the minimum voltage/current signal and adjust the analog input bias (H3-04 for input A1, H3-12 for input A2) until the frequency reference value reaches the desired minimum value.	-



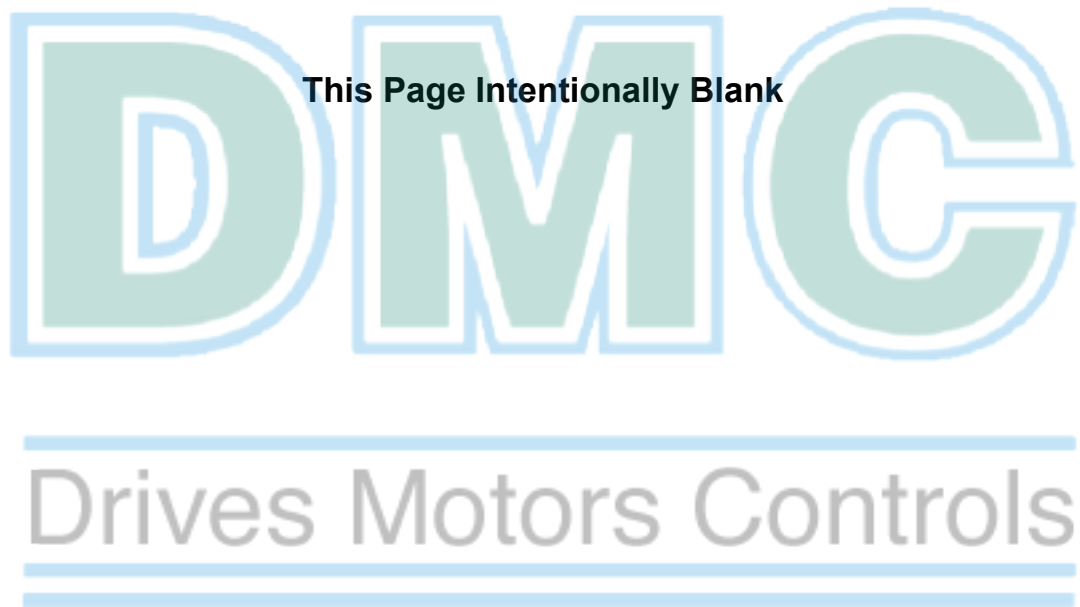

Parameter Details

5.1	A: INITIALIZATION.....	116
5.2	B: APPLICATION.....	121
5.3	C: TUNING.....	147
5.4	D: REFERENCE SETTINGS.....	159
5.5	E: MOTOR PARAMETERS.....	169
5.6	F: OPTION SETTINGS.....	181
5.7	H: TERMINAL FUNCTIONS.....	184
5.8	L: PROTECTION FUNCTIONS.....	213
5.9	N: SPECIAL ADJUSTMENTS.....	240
5.10	O: OPERATOR RELATED SETTINGS.....	247
5.11	U: MONITOR PARAMETERS.....	254

Drives Motors Controls

5.1 A: Initialization

The initialization group contains parameters associated with initial setup of the drive. Parameters involving the display language, access levels, initialization, and password are located in this group.

◆ A1: Initialization

■ A1-00: Language Selection

Selects the display language for the digital operator.

Note: This parameter is not reset when the drive is initialized using parameter A1-03.

No.	Parameter Name	Setting Range	Default
A1-00	Language Selection	0 to 7	0

Setting 0: English

Setting 1: Japanese

Setting 2: German

Setting 3: French

Setting 4: Italian

Setting 5: Spanish

Setting 6: Portuguese

Setting 7: Chinese

■ A1-01: Access Level Selection

Allows or restricts access to drive parameters.

No.	Parameter Name	Setting Range	Default
A1-01	Access Level Selection	0 to 2	2

Setting 0: Operation Only

Access is restricted to parameters A1-01, A1-04, A1-06, and all U monitor parameters.

Setting 1: User Parameters

Access to only a specific list of parameters set to A2-01 through A2-32. These User Parameters can be accessed using the Setup mode of the digital operator.

Setting 2: Advanced Access Level (A) and Setup Access Level (S)

All parameters can be viewed and edited.

Notes on Parameter Access

- If the drive parameters are password protected by A1-04 and A1-05, parameters A1-00 through A1-03, A1-06, and all A2 parameters cannot be modified.
- If a digital input programmed for Program Lockout (H1-□□ = 1B) is enabled, parameter values cannot be modified, even though the A1-01 is set to 1 or 2.
- If parameters are changed via serial communication the parameters cannot be changed from the digital operator until an Enter command is received from the serial communication.

■ A1-02: Control Method Selection

Selects the Control Method of the drive.

- Note:**
1. Be sure to perform Auto-Tuning when using one of the vector control modes.
 2. Reinitializing the drive does not reset A1-02 to the factory default value.

No.	Parameter Name	Setting Range	Default
A1-02	Control Method Selection	0, 2, 5	0

Setting 0: V/f Control

- For general-purpose and multiple motor applications.

- For use when the motor parameters are unknown and Auto-tuning can not be performed.

Setting 2: Open Loop Vector

- For general, variable-speed applications.
- For applications requiring precise speed control, quick response, and higher torque at low speeds.

Setting 5: PM Open Loop Vector

For operating SPM, IPM, and various permanent magnet motors. Takes advantage of Energy Saving features when operating with derated torque.

■ A1-03: Initialize Parameters

Resets parameter settings back to their original default values. After the initialization the parameter automatically returns to 0.

No.	Parameter Name	Setting Range	Default
A1-03	Initialize Parameters	0, 1110, 2220, 3330, 5550	0

Setting 0: No Initialization

Setting 1110: User Initialize

The modified drive parameters are returned to the values selected as user settings. User settings are stored when parameter o2-03 = "1: Set Defaults".

Note: A "user-initialization" resets all parameters to a user-defined set of default values that were previously saved to the drive. To clear the user-defined default values, set parameter o2-03 to "2".

Setting 2220: 2-Wire Initialization

Resets all parameters back to their original default settings with digital inputs S1 and S2 configured as forward run and reverse run, respectively. A 2-wire sequence assigns functions to input terminals S1 and S2.

Refer to Setting 40/41: Forward Run/Reverse Run Command for 2-Wire Sequence on page 191 for more information.

Setting 3330: 3-Wire Initialization

The drive parameters are returned to factory default values with digital inputs S1, S2, and S5 configured as run, stop, and forward/reverse respectively. A 3-wire sequence assigns functions to input terminals S1, S2, and S5.

Refer to Setting 0: 3-Wire Sequence on page 185 for more information.

Setting 5550: oPE04 Reset

If parameters on a certain drive have been edited and then a different terminal block is installed with different settings saved in its built-in memory, an oPE04 error will appear on the display. To use the parameter settings saved to the terminal block memory, set A1-03 to "5550".

Notes on Parameter Initialization

The parameters shown in [Table 5.1](#) will not be reset when the drive is initialized by setting A1-03 = 2220 or 3330. The fault history will not be reset when the drive is initialized by A1-03 = 2220 or 3330. Although the control mode in A1-02 is not reset when A1-03 is set to 2220 or 3330, it may change when an application preset is selected.

Table 5.1 Parameters not Changed by Drive Initialization

No.	Parameter Name
A1-00	Language Selection
A1-02	Control Method Selection
A1-07	DriveWorksEZ Function Selection
E1-03	V/f Pattern Selection
E5-01	Motor Code Selection (for PM motors)
E5-02	Motor Rated Capacity (for PM motors)
E5-03	Motor Rated Current (for PM motors)
E5-04	Motor Poles (for PM motors)
E5-05	Motor Stator Resistance (for PM motors)
E5-06	Motor d Axis Inductance (for PM motors)

5.1 A: Initialization

No.	Parameter Name
E5-07	Motor q Axis Inductance (for PM motors)
E5-09	Motor Induction Voltage Constant 1 (for PM motors)
E5-24	Motor Induction Voltage Constant 2 (for PM motors)
o2-04	Drive/kVA Selection
L8-35	Installation Selection

■ A1-04, A1-05: Password and Password Setting

A1-04 is for entering the password when the drive is locked. A1-05 is a hidden parameter used to set the password.

No.	Parameter Name	Setting Range	Default
A1-04	Password	0 to 9999	0
A1-05	Password Setting		

How to use the Password

The user can set a password for the drive to restrict access. The password is set to A1-05 and must be entered to A1-04 to unlock parameter access. Until the correct password is entered, the following parameters cannot be viewed or edited: A1-01, A1-02, A1-03, A1-06, and A2-01 through A2-33.

The instructions below demonstrate how to set a new password. Here, the password set is “1234”. An explanation follows on how to enter the password to unlock the parameters.





















Table 5.2 Setting the Password for Parameter Lock

Step		Display/Result
1.	Turn on the power to the drive. The initial display appears.	
2.	Scroll to the Parameter Setup display and press	
3.	Scroll to the right by pressing	
4.	Select the flashing digits by pressing	
5.	Select A1-04 by pressing	
6.	Press the key while holding down at the same time. A1-05 will appear. Note: A1-05 is normally hidden, but can be displayed by following the directions listed here.	 “05” flashes
7.	Press the key.	
8.	Use , , and to enter the password.	
9.	Press to save what was entered.	
10.	The display automatically returns to the display shown in step 5.	

Table 5.3 Check to see if A1-01 is locked (continuing from step 10 above)

Step		Display/Result
1.	Press to display A1-01.	 “01” flashes
2.	Press to display the value set to A1-01.	
3.	Press and , making sure that the setting values cannot be changed.	
4.	Press to return to the first display.	

Table 5.4 Enter the Password to Unlock Parameters (continuing from step 4 above)

Step			Display/Result
1.	Press  to enter the parameter setup display.	→	
2.	Press  to select the flashing digits as shown.	→	 "01" flashes
3.	Press  to scroll to A1-04.	→	
4.	Enter the password "1234".	→	
5.	Press  to save the new password.	→	
6.	Drive returns to the parameter display.	→	
7.	Press  and scroll to A1-01.	→	
8.	Press  to display the value set to A1-01. If the first "0" blinks, parameter settings are unlocked.	→	
9.	Use  and  to change the value if desired. This is not typical.		
10.	Press  to save the setting, or  to return to the previous display without saving changes.	→	
11.	The display automatically returns to the parameter display.	→	

Note: Parameter settings can be edited after entering the correct password. Performing a 2-Wire or 3-Wire initialization resets the password to "0000". Reenter the password to parameter A1-05 after drive initialization.

■ A1-06: Application Presets

Several Application Presets are available to facilitate drive setup for commonly used applications. Selecting one of these Application Presets automatically sets the required parameters to default values and selects I/Os. In addition, Application Preset parameters are assigned to the list of User Parameters, A2-01 through A2-16. These can be accessed in the Setup Mode and provide quicker application adjustment by eliminating the need to scroll through multiple menus.

Refer to Application Selection on page 96 for details on parameter A1-06.

■ A1-07: DriveWorksEZ Function Selection

DriveWorksEZ is a software package that can be used to customize the drive functionality or add PLC functionality by the interconnection and configuration of basic software function blocks. The drive performs program created by the user in 2 ms cycles.

Parameter A1-07 can be used to enable or disable the DriveWorksEZ program inside the drive.

- Note:**
1. If DriveWorksEZ assigned functions to any multi-function output terminals, those functions stay set after disabling DriveWorksEZ.
 2. Reinitialization using A1-03 does not reset A1-07 to the factory default value.
 3. For more information on DriveWorksEZ, contact a Yaskawa representative or the Yaskawa sales department directly.

No.	Parameter Name	Setting Range	Default
A1-07	DriveWorksEZ Function Selection	0 to 2	0

Setting 0: DWEZ Disabled

Setting 1: DWEZ Enabled

Setting 2: Digital Input

◆ A2: User Parameters

■ A2-01 to A2-32: User Parameters

The user can select 32 parameters and assign them to A2-01 through A2-32. This saves time later scrolling through the parameter menu. The list of User Parameters can also track the most recently edited settings and save those parameters to this list.

No.	Parameter Name	Setting Range	Default
A2-01 to A2-32	User Parameters 1 to 32	A1-02; b1-01 to o2-08	Depending on A1-06

Saving User Parameters

To save specific parameters to A2-01 to A2-32, first set the access level to allow access to all parameters (A1-02 = 2). Next assign the parameter number to the User Parameters list by entering it into one of the A2-□□ parameters. By then setting A1-01 to “1”, the access level can be restricted so that users can only set and reference the specific parameters saved as User Parameters.

■ A2-33: User Parameter Automatic Selection

A2-33 determines whether or not parameters that have been edited are saved to the User Parameters (A2-17 to A2-32) for quick, easy access.

No.	Parameter Name	Setting Range	Default
A2-33	User Parameter Automatic Selection	0 or 1	Depending on A1-06

Setting 0: Do not save list of recently viewed parameters.

To manually select the parameters listed in the User Parameter group, set A2-33 to “0”.

Setting 1: Save history of recently viewed parameters.

By setting A2-33 to 1, all parameters that were recently edited will be automatically saved to A2-17 through A2-32. A total of 16 parameters are saved in order with the most recently edited parameter set to A2-17. User parameters can be accessed using the Setup mode of the digital operator.

Drives Motors Controls

5.2 b: Application

Application parameters configure the source of the frequency reference, the Run command, DC Injection Braking, Speed Search, various timer functions, PID control, the Dwell function, Energy Savings and a variety of other application-related settings.

◆ b1: Mode of Operation

■ b1-01: Frequency Reference Selection 1

Use parameter b1-01 to select the frequency reference source 1 for the REMOTE mode.

- Note:**
1. If a Run command is input to the drive but the frequency reference entered is 0 or below the minimum frequency, the RUN indicator LED on the digital operator will light and the STOP indicator will flash.
 2. Press the LO/RE key to set the drive to LOCAL and use the operator keypad to enter the frequency reference.

No.	Parameter Name	Setting Range	Default
b1-01	Frequency Reference Selection 1	0 to 4	1

Setting 0: Digital Operator

Using this setting, the frequency reference can be input by:

- Switching between the multi-speed references in the d1-□□ parameters.
- Entering the frequency reference on the operator keypad.

Setting 1: Terminals (Analog Input Terminals)

Using this setting, an analog frequency reference can be entered from:

- Terminal A1 using a 0 to 10 Vdc signal.
- Terminal A2 using either a 0 to 10 Vdc or a 0/4 to 20 mA signal.

Note: Terminal A2 supports voltage and current input. The input signal type must be set up by setting DIP switch S1 and adjusting parameter H3-09. [Refer to H3-09: Terminal A2 Signal Level Selection on page 207.](#)

Entering only the main frequency reference:

Using Control Circuit Terminal A1 (0 to 10 Vdc voltage input):

Use a circuit such as the one shown in [Figure 5.1](#) or an external 0 to 10 Vdc voltage source like a PLC analog output and set the input level selection for A1 in parameter H3-02 as desired. [Refer to H3-02: Terminal A1 Function Selection on page 205.](#)

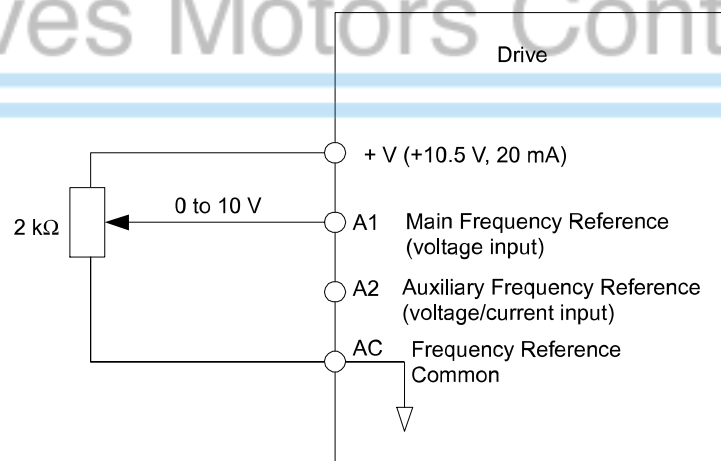

Figure 5.1 Setting the Frequency Reference by Voltage Input

- Using Control Circuit Terminal A2 (0 to 10 Vdc voltage input)

Use the same connection like explained for terminal A1 for terminal A2. Make sure that switch S1 is set to “V” and set the appropriate signal level for terminal A2 by entering 0 or 1 into parameter H3-09. The terminal A2 function must be set to frequency bias by entering 0 into parameter H3-10 ([Refer to H3-10: Terminal A2 Function Selection on page 207.](#))

- Using Control Circuit Terminal A2 (0/4 to 20 mA current input)

5.2 b: Application

Connect input A2 to an external current source such as the one shown in [Figure 5.2](#). Make sure that switch S1 is set to “I” and set the appropriate signal level for terminal A2 by entering 2 (4 to 20 mA) or 3 (0 to 20 mA) into parameter H3-09. The terminal A2 function must be set to frequency bias by entering 0 into parameter H3-10 ([Refer to H3-10: Terminal A2 Function Selection on page 207](#)).

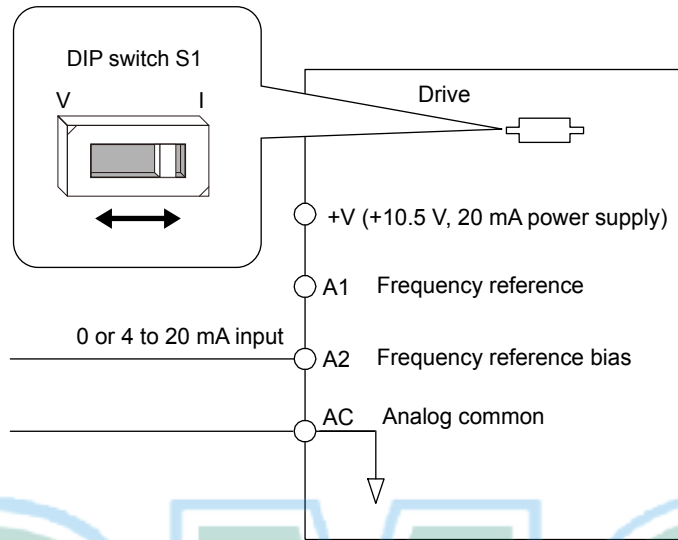

Figure 5.2 Setting the Frequency Reference by Current Input

Switching between Main/Auxiliary Frequency References

The frequency reference input can be switched between terminal A1 (main) and terminal A2 (auxiliary). When using this function:

- Make sure that b1-01 is set to “1” (Frequency reference from analog input).
- Set the terminal A2 function to auxiliary frequency (H3-10 = 2).
- Set one digital input to multi-speed 1 (H1-□□ = 3, default for S5).

The frequency reference value is read from

- Terminal A1 when the digital input set for multi-speed 1 is open.
- Terminal A2 when the digital input set for multi-speed 1 is closed.

[Figure 5.2](#) shows a wiring example for main/auxiliary reference switching using digital input S5.

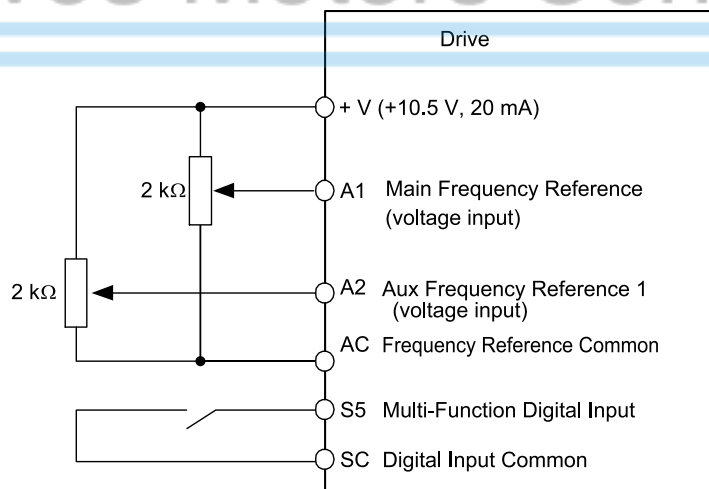

Figure 5.3 Switching between Analog Reference 1 and 2

Setting 2: MEMOBUS/Modbus Communications

This setting requires that the frequency reference is entered via the RS-485/422 serial communications port (control terminals R+, R-, S+, S-, Protocol: MEMOBUS/Modbus). For instructions, [Refer to MEMOBUS/Modbus Communications on page 431](#).

Setting 3: Option Card

This setting requires that the frequency reference is entered via an option board plugged into connector CN5 on the drive control board. Consult the manual supplied with the option board for instructions on integrating the drive with the communication system.

Note: If the frequency reference source is set for an option PCB (b1-01 = 3) but an option board is not installed in CN5, an oPE05 Programming Error will be displayed on the digital operator and the RUN command will not be accepted.

Setting 4: Pulse Train Input

If b1-01 is set to 4 the frequency reference must be provided by a pulse train signal at terminal RP that complies with the following specification.

Pulse Train Input Specifications	
Response Frequency	0.5 to 32 kHz
Duty Cycle	30 to 70%
High Level Voltage	3.5 to 13.2 V
Low Level Voltage	0.0 to 0.8 V
Input Impedance	3 kΩ

Verifying Pulse Train is Working Properly

- Make sure that b1-01 is set to 4 and H6-01 is set to 0.
- Set the pulse input scaling H6-02 to the pulse train frequency value that equals 100% frequency reference.
- Enter a pulse train signal to terminal RP and check if the correct frequency reference is displayed. Try also with different pulse train input frequencies.

■ b1-02: Run Command Selection 1

Parameter b1-02 determines the Run and Stop command source 1 in the REMOTE mode.

WARNING! Sudden Movement Hazard. Clear personnel, secure equipment, and check sequence and safety circuitry before starting the drive. Failure to comply could result in death or serious injury from moving equipment.

No.	Parameter Name	Setting Range	Default
b1-02	Run Command Selection 1	0 to 3	1

Setting 0: Digital Operator

Using this setting, the RUN and STOP keys on the operator keypad will start and stop the motor. The LED in the LO/RE key will be on to indicate that the Run command is assigned to the operator. The example below shows how the drive can be operated if b1-02 is set to 0.

Step		Display/Result
1.	Turn on the power to the drive. The initial display appears.	
2.	Set the frequency reference to F6.00 (6 Hz).	
3.	Press the key to start the motor. The RUN indicator LED will light and the motor will begin rotating at 6 Hz.	
4.	Press the key to stop the motor. The RUN light will flash until the motor comes to a complete stop.	

Setting 1: Control Circuit Terminal

This setting requires that the Run and Stop commands are entered from the digital input terminals. The following sequences can be used:

5.2 b: Application

- 2-Wire sequence 1:

Two inputs (FWD/Stop-REV/Stop). Initializing the drive by setting A1-01 = 2220, presets the terminals S1 and S2 to these functions. This is the default setting of the drive. *Refer to Setting 40/41: Forward Run/Reverse Run Command for 2-Wire Sequence on page 191.*

- 2-Wire sequence 2:

Two inputs (Start/Stop-FWD/REV). *Refer to Setting 42/43: Run and Direction Command for 2-Wire Sequence 2 on page 191.*

- 3-Wire sequence:

Inputs S1, S2, S5 (Start-Stop-FWD/REV). Initialize the drive by setting A1-01 = 3330 presets the terminals S1, S2 and S5 to these functions. *Refer to Setting 0: 3-Wire Sequence on page 185.*

Setting 2: MEMOBUS/Modbus Communications

To issue a Run command via serial communications, set b1-02 to “2” and connect the RS-485/422 serial communication cable to R+, R-, S+, and S- on the removable terminal block. *Refer to MEMOBUS/Modbus Communications on page 431.*

Setting 3: Option Card

To issue the Run command via the communication option board, set b1-02 to “3” and plug a communication option board into the 2CN port on the control PCB. Refer to the manual supplied with the option board for instructions on integrating the drive into the communication system.

Note: If b1-01 is set to 3, but an option board is not installed in 2CN, an oPE05 operator programming error will be displayed on the digital operator and the drive will not run.

■ b1-03: Stopping Method Selection

Select how the drive stops the motor when a Stop command is entered or when the Run command is removed.

No.	Parameter Name	Setting Range	Default
b1-03	Stopping Method Selection	0 to 3	0

Setting 0: Ramp to Stop

When a Stop command is issued or the Run command is removed, the drive will decelerate the motor to stop. The deceleration rate is determined by the active deceleration time. The default deceleration time is set to parameter C1-02.

DC Injection braking (for IM control) or Short Circuit Braking (PM Open Loop Vector) can be applied at the end of the ramp in order to completely stop high inertia loads. *Refer to b2: DC Injection Braking on page 128* for details.

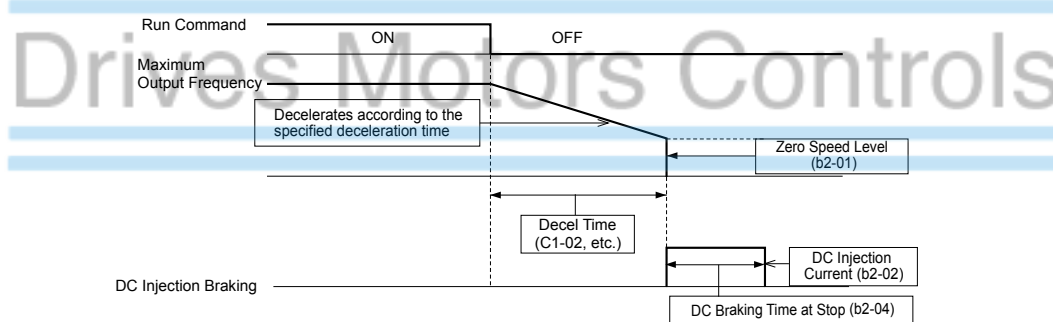

Figure 5.4 Ramp to Stop

Setting 1: Coast to Stop

When a Stop command is issued or the Run command is removed, the drive will shut off its output and the motor will coast (uncontrolled deceleration) to stop where the stopping time is determined by the inertia and the friction in the driven system.

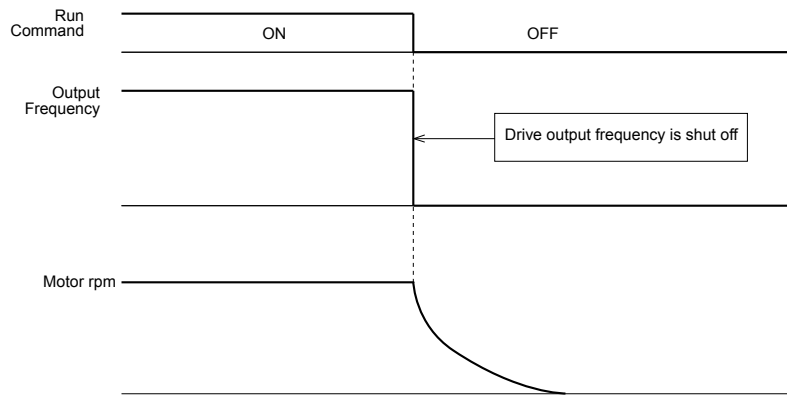

Figure 5.5 Coast to Stop

Note: After a stop is initiated, any subsequent Run command that is entered will be ignored until the Minimum Baseblock Time (L2-03) has expired. Do not attempt to start the motor again until it has come to a complete stop. To start the motor before it has stopped completely, use DC Injection at start (*Refer to b2-03: DC Injection Braking Time at Start on page 129*) or Speed Search (*Refer to b3: Speed Search on page 130*).

Setting 2: DC Injection Braking to Stop

When the Run command is removed, the drive will baseblock (turn off its output) for the minimum baseblock time (L2-03). Once the minimum baseblock time has expired, the drive will brake the motor by injecting DC current into the motor windings. The stopping time will be reduced as compared to coast to stop. The level of DC Injection current is set by parameter b2-02 (default = 50%).

Note: This function is not available when using PM Open Loop Vector.

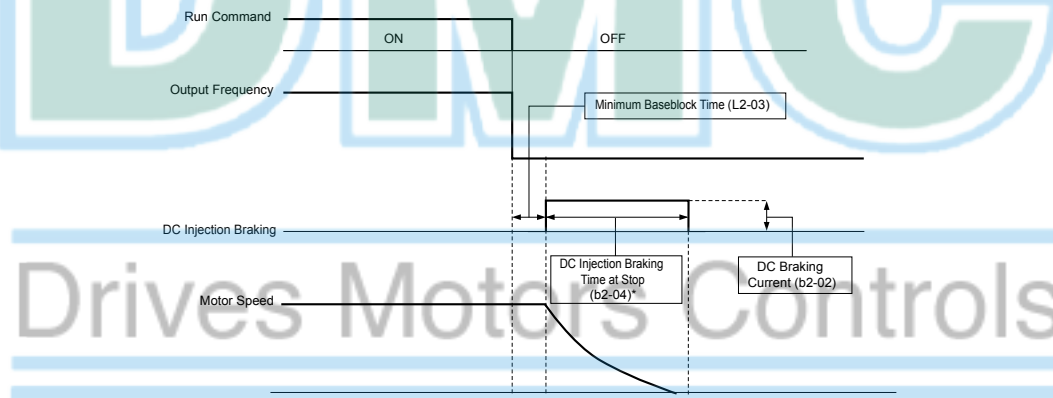

Figure 5.6 DC Injection Braking to Stop

The time for DC Injection Braking is determined by the value set to b2-04 and by the output frequency at the time the Run command is removed. It can be calculated by:

$$\text{DC Injection brake time} = \frac{\text{b2-04} \cdot 10 \cdot \text{Output frequency}}{\text{Max. output frequency (E1-04)}}$$

5.2 b: Application

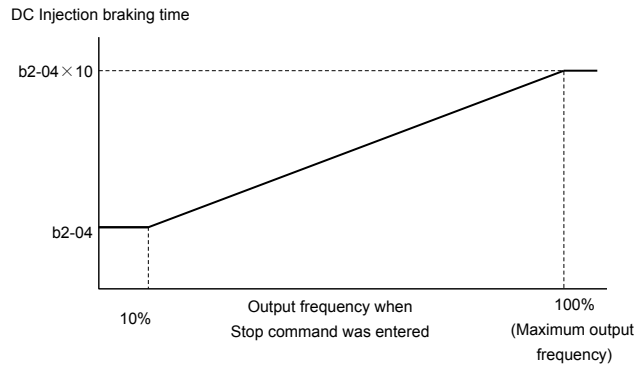

Figure 5.7 DC Injection Braking Time Depending on Output Frequency

Note: If an overcurrent (oC) fault occurs during DC Injection Braking to stop, lengthen the minimum baseblock time (L2-03) until the fault no longer occurs.

Setting 3: Coast to Stop with Timer

When the Run command is removed, the drive will turn off its output and the motor will coast to stop. If a Run command is input before the operation wait time t expires, the drive will not rotate the motor and the Run command will need to be cycled before operation can occur.

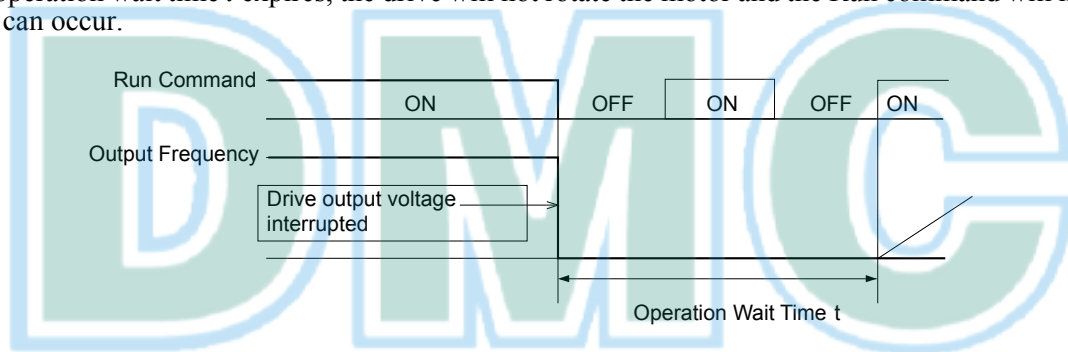

Figure 5.8 Coast to Stop with Timer

The operation wait time t is determined by the output frequency when the Run command is removed and by the active deceleration time.

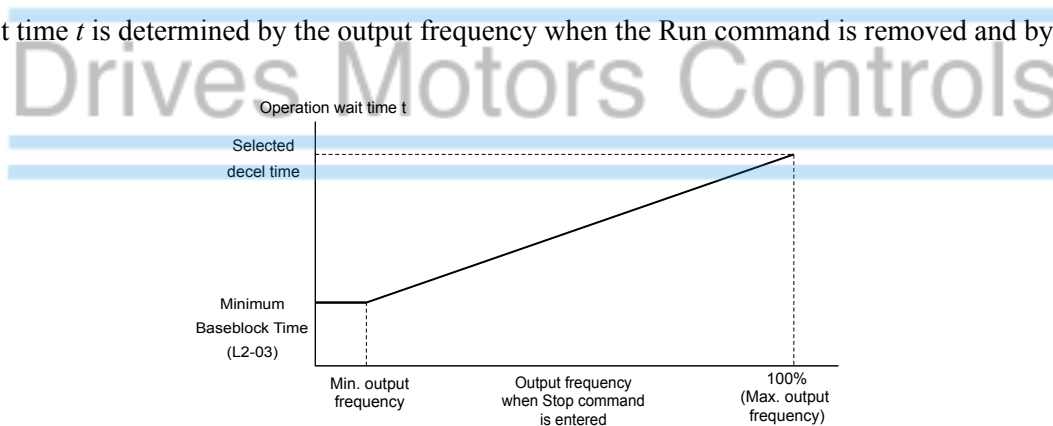

Figure 5.9 Operation Wait Time Depending on Output Frequency

■ b1-04: Reverse Operation Selection

For some applications, reverse motor rotation is not appropriate and may even cause problems (e.g., air handling units, pumps, etc.). Setting parameter b1-04 to 1 instructs the drive to ignore any Reverse run commands.

No.	Parameter Name	Setting Range	Default
b1-04	Reverse Operation Selection	0 or 1	0

Setting 0: Reverse Operation Enabled

Possible to operate the motor in both forward and reverse directions.

Setting 1: Reverse Operation Disabled

Drive disregards a Reverse run command or a negative frequency reference.

■ b1-07: LOCAL/REMOTE Run Selection

The drive has the following three separate control sources that can be switched using digital inputs or the LO/RE key on the digital operator (for details [Refer to Setting 1: LOCAL/REMOTE Selection on page 185](#), [Refer to Setting 2: External Reference 1/2 Selection on page 186](#) and [Refer to o2-01: LO/RE \(LOCAL/REMOTE\) Key Function Selection on page 248](#)):

- LOCAL - The digital operator is used to set the reference and the Run command.
- REMOTE - Reference 1: The settings of b1-01 and b1-02 determine where the frequency reference and Run command are input from.
- REMOTE - Reference 2: The settings of b1-15 and b1-16 determine where the frequency reference and Run command are input from.

When switching from LOCAL to REMOTE, or between Reference 1 and Reference 2, the Run command may already be present at the location the source was switched to. Parameter b1-07 can be used to determine how the Run command is treated in this case.

No.	Parameter Name	Setting Range	Default
b1-07	LOCAL/REMOTE Run Selection	0 or 1	0

Setting 0: Run Command Must Be Cycled

If the Run command is issued differently in the old and new control source (e.g. old - terminals, new - serial communications) and it is active at the new source when switching takes place, the drive will either not start or it will stop if it was running before. The Run command has to be cycled to start from the new control source.

Setting 1: Continue Running

If the Run command is active at the new control source, the drive starts or continues running. There is no need to cycle the Run command.

WARNING! The drive may start unexpectedly if switching control sources when b1-07 = 1. Clear all personnel away from rotating machinery and electrical connections prior to switching control sources. Failure to comply may cause death or serious injury.

■ b1-08: Run Command Selection while in Programming Mode

As a safety precaution, the drive will not normally respond to a Run input when the digital operator is being used to adjust parameters in the Programming Mode (Verify Menu, Setup Mode, Parameter Settings Mode, and Auto-Tuning). If required by the application b1-08 can be used to changed this functionality.

No.	Parameter Name	Setting Range	Default
b1-08	Run Command Selection while in Programming Mode	0 to 2	0

Setting 0: Disabled

A Run command is not accepted while the digital operator is in Programming Mode.

Setting 1: Enabled

A Run command is accepted in any digital operator mode.

Setting 2: Prohibit Programming During Run

It is not possible to enter the Programming Mode as long as the drive output is active.

■ b1-14: Phase Order Selection

Sets the phase order for drive output terminals U/T1, V/T2, and W/T3.

No.	Parameter Name	Setting Range	Default
b1-14	Phase Order Selection	0 or 1	0

Setting 0: Standard Phase Order**Setting 1: Switched Phase Order**

5.2 b: Application

■ b1-15: Frequency Reference Selection 2

Refer to [b1-01: Frequency Reference Selection 1 on page 121](#) for details.

The value set to b1-15 is used as Frequency Reference 2 when one of the multi-function input terminals set for Frequency Reference Switching (H1-□□ = 2) closes. Refer to [Setting 2: External Reference 1/2 Selection on page 186](#) for instructions on how this function works.

No.	Parameter Name	Setting Range	Default
b1-15	Frequency Reference Selection 2	0 to 4	0

■ b1-16: Run Command Selection 2

Refer to [b1-02: Run Command Selection 1 on page 123](#) for details.

The value set to b1-16 is used as Run Command Source 2 when one of the multi-function input terminals set for Frequency Reference Switching (H1-□□ = 2) closes. Refer to [Setting 2: External Reference 1/2 Selection on page 186](#) for instructions on how this function works.

No.	Parameter Name	Setting Range	Default
b1-16	Run Command Selection 2	0 to 3	0

■ b1-17: Run Command at Power Up

This parameter is used to determine whether an external Run command that is active during power up of the drive will start the drive or not.

No.	Parameter Name	Setting Range	Default
b1-17	Run Command at Power Up	0 or 1	0

Setting 0: Run Command at Power Up is not Issued

The Run command has to be cycled to start the drive.

Note: For safety reasons, the drive is initially set up not to accept a Run command at power up (b1-17 = "0"). If a Run command is issued at power up, the RUN indicator LED will flash quickly. Change parameter b1-17 to 1 if a Run command active at power up shall be accepted by the drive.

Setting 1: Run Command and Power Up is Issued

An external Run command active during power up is issued and the drive starts to operate the motor as soon as it gets ready for operation (i.e. once the internal start up process is complete).

WARNING! Sudden Movement Hazard. If b1-17 is set to 1 and an external Run command is active during power up, the motor will begin rotating as soon as the power is switched on. Proper precautions must be taken to ensure that the area around the motor is safe prior to powering up the drive. Failure to comply may cause serious injury.

◆ b2: DC Injection Braking

These parameters determine how the DC Injection Braking/Short Circuit Braking feature operates. Parameters involving the starting frequency, current level, braking time are located here.

■ b2-01: DC Injection Braking Start Frequency

Active when "Ramp to Stop" is selected as the stopping method (b1-03 = 0). Sets the starting frequency for:

- DC Injection Braking at stop in V/f and OLV control.
- Short Circuit Braking at stop in PM OLV control.

No.	Name	Setting Range	Default
b2-01	DC Injection Braking Start Frequency	0.0 to 10.0 Hz	0.5 Hz

When the output frequency while ramping to stop drops below b2-01, the drive begins DC Injection/Short Circuit Braking in order to completely stop the motor at the end of deceleration. If b2-01 < E1-09 (Minimum Frequency), then DC Injection/Short Circuit Braking begins at the frequency set to E1-09.

No.	Name	Setting Range	Default
E1-09	Minimum Output Frequency	0.0 to 400.0 Hz <1>	Determined by A1-02 and E1-03 and on E5-01 in OLV/PM.

<1> The upper limit for the setting range is determined by E1-04.

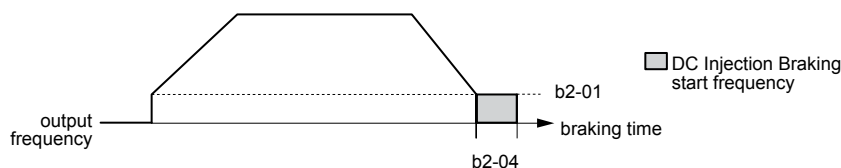

Figure 5.10 DC Injection Braking during Deceleration

■ b2-02: DC Injection Braking Current

Sets the DC Injection Braking current as a percentage of the drive rated current. If set to larger than 50%, the carrier frequency is automatically reduced to 1 kHz.

No.	Name	Setting Range	Default
b2-02	DC Injection Braking Current	0 to 75%	50%

The level of DC Injection Braking current affects the strength of the magnetic field attempting to lock the motor shaft. Increasing the current level will increase the amount of heat generated by the motor windings. This parameter should only be increased to the level necessary to hold the motor shaft.

■ b2-03: DC Injection Braking Time at Start

Sets the time of DC Injection Braking at start. It can be used to stop a coasting motor before restarting it or to apply a braking torque at start. Disabled when set to 0.00 s.

No.	Name	Setting Range	Default
b2-03	DC Injection Braking Time at Start	0.00 to 10.00 s	0.50 s

Note: Before starting an uncontrolled rotating motor (e.g. a fan motor driven by windmill effect), DC Injection or Speed Search should be used to either stop the motor or detect its speed before starting it. Otherwise motor stalling and other faults can occur.

■ b2-04: DC Injection Braking Time at Stop

This parameter works in combination with b2-01, and sets the DC Injection Braking time at stop. Used to completely stop a motor with high inertia load after ramp down. Increase the setting if the motor tends to coast by inertia after a stop.

No.	Name	Setting Range	Default
b2-04	DC Injection Braking Time at Stop	0.00 to 10.00 s	0.50 s

■ b2-08: Magnetic Flux Compensation Value

Sets the magnetic flux compensation as a percentage of the no-load current value (E2-03) and can be used to increase the motor flux when the motor is started up.

No.	Name	Setting Range	Default
b2-08	Magnetic Flux Compensation Value	0 to 1000%	0%

This parameter allows the magnetizing motor flux to be boosted when starting the motor and thereby facilitate a quick ramp-up of the torque reference and magnetizing current reference in order to reduce motor slip during start. This flux level will be applied below the minimum output frequency set to E1-09 until the DC Injection time at start (b2-03) expires. It may be used to compensate for reduced starting torque due to motor circuit inefficiencies.

■ b2-12: Short Circuit Brake Time at Start

Short-Circuit braking can be used in Open Loop Vector for PM motors. By shorting all three motor phases it produces a braking torque in the motor and can be used to stop a coasting motor before starting it.

Parameter b2-12 sets the time for Short-Circuit Brake operation at start. Disabled when set to 0.00 s.

No.	Name	Setting Range	Default
b2-12	Short Circuit Brake Time at Start	0.00 to 25.50 s	0.00 s

■ b2-13: Short Circuit Brake Time at Stop

The Short-Circuit braking described for parameter b2-12 can also be applied at the end of deceleration in order to completely stop high inertia loads. Short circuit braking is initiated when the output frequency falls below the higher of the values b2-01 and E1-09.

5.2 b: Application

Parameter b2-13 sets the time for Short-Circuit brake operation at stop. Disabled when set to 0.00 s.

No.	Name	Setting Range	Default
b2-13	Short Circuit Brake Time at Stop	0.00 to 25.50 s	0.50 s

◆ b3: Speed Search

The Speed Search function allows the drive to detect the speed of a rotating motor shaft that is driven by external forces (e.g. fan rotating by windmill effect or motor driven by load inertia). The motor operation can be directly started from the speed detected without needing to stop the machine before.

Example: When a momentary loss of power occurs, the drive output shuts off. This results in a coasting motor. When power returns, the drive can find the speed of the coasting motor and restart it directly.

The drive offers two types of Speed Search, Speed Estimation and Current Detection. Both methods are explained below followed by a description of all relevant parameters.

■ Speed Estimation Type Speed Search (b3-24 = 1)

This method can be used for a single motor connected to a drive. It should not be utilized if the motor is one or more frame sizes smaller than the drive, at motor speeds above 130 Hz, or when using a single drive to operate more than one motor.

The Speed Estimation type distinguishes two kinds of operation, Back EMF voltage estimation and DC current injection.

Back EMF Voltage Estimation

This method is used by Speed Search after short Baseblock (e.g. a power loss where the drives CPU kept running and the Run command was kept active). Here the drive estimates the motor speed by analyzing the back EMF voltage. It outputs the estimated frequency and increases the voltage using the time constant set in parameter L2-04. After that the motor is accelerated or decelerated to the frequency reference starting from the detected speed.

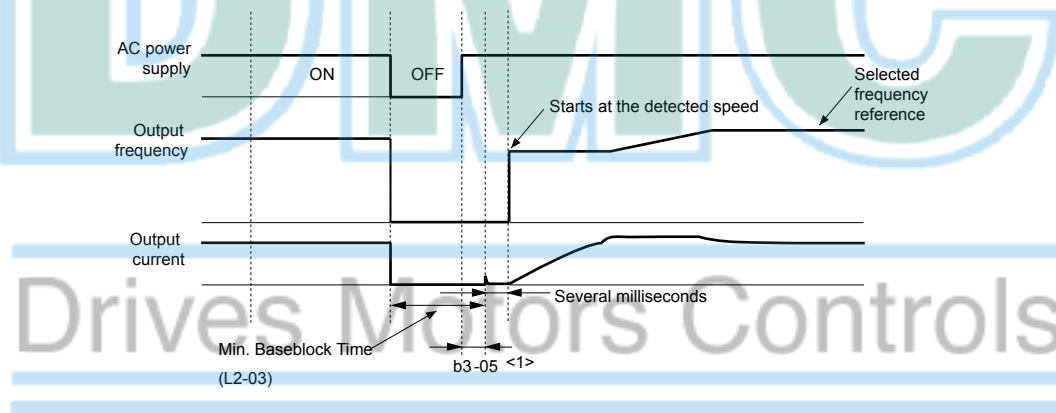

Figure 5.11 Speed Search after Baseblock

<1> Once AC power is restored, the drive will wait for at least the time set to b3-05. If the power interruption is longer than the Minimum Baseblock Time L2-03, the drive will wait for b3-05 after the power has returned before starting Speed Search.

Current Injection

This method is used when there is no detectable back EMF, e.g. after longer power losses, when Speed Search is applied with the Run command (b3-01 = 1) or if an External Search command is used. It injects the DC current set in b3-06 to the motor and detects the speed by measuring the current feedback. The drive outputs the detected frequency and increases the voltage using the time constant set in parameter L2-04. If the resulting current is higher than the level in b3-02 the output frequency is reduced. When the current becomes lower than b3-02 the motor speed is assumed to be found and the drive starts to accelerate or decelerate to the frequency reference.

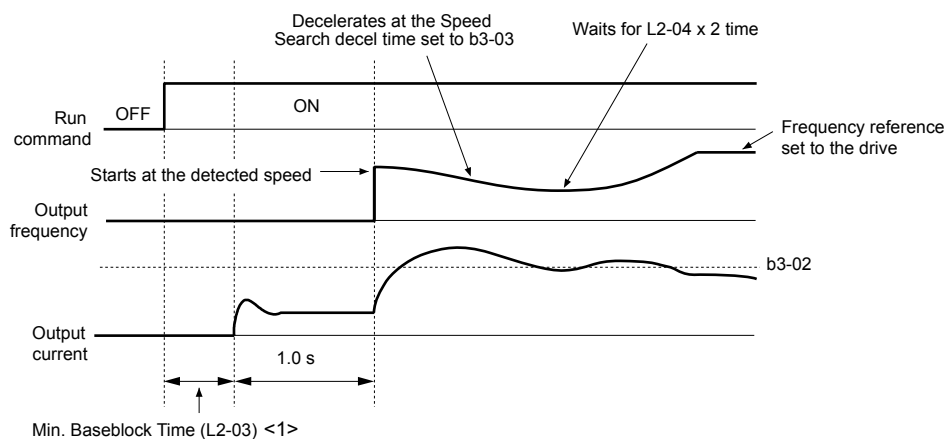

Figure 5.12 Speed Search at Start

<1> The wait time for Speed Search (b3-05) determines the lower limit.

Note: If the Run command is quickly switched off and then back on again when the drive is set to “Coast to stop” as the stopping method, Speed Search will operate as shown in [Figure 5.11](#).

Notes on Using Speed Estimation Type Speed Search

- Auto-Tuning needs to be first performed if you plan to use Speed Estimation. Perform Auto-Tuning again if there is a change in the cable length between the drive and motor.
- Use Current Detection to search for speeds beyond 130 Hz or if the application is running multiple motors from the same drive, or if the motor is considerably smaller than the capacity of the drive.
- Speed Estimation may have trouble finding the actual speed if the motor cable is very long. Current Detection should be used in such situations.
- Use Current Detection instead of Speed Estimation when operating motors smaller than 1.5 kW. Speed Estimation can end up stopping smaller motors as it might not be able to detect the speed or rotation direction of such small motors.
- Use Short circuit Braking instead of Speed Estimation when using Open Loop Vector Control for PM motors along with a fairly long motor cable.
- Use Short circuit Braking instead of Speed Estimation if attempting to find the speed of a motor coasting faster than 120 Hz in Open Loop Vector Control for PM motors.

■ Current Detection Type Speed Search (b3-24 = 0)

Current Detection Speed Search can be applied to any motor. Be aware that sudden acceleration may occur when using Current Detection with relatively light loads.

This method detects the motor speed by reducing the output frequency and measuring the current. The frequency reduction starts from the maximum output frequency or from the set frequency reference. As long as the output frequency is higher than the rotor speed, the slip will cause a high current. The closer the output frequency comes to the rotor speed, the lower the current draw will be. When the output current drops below the level as set in b3-02, the output frequency stops decreasing and normal operation resumes.

The following time chart illustrates how Current Detection Speed Search operates after a momentary power loss:

5.2 b: Application

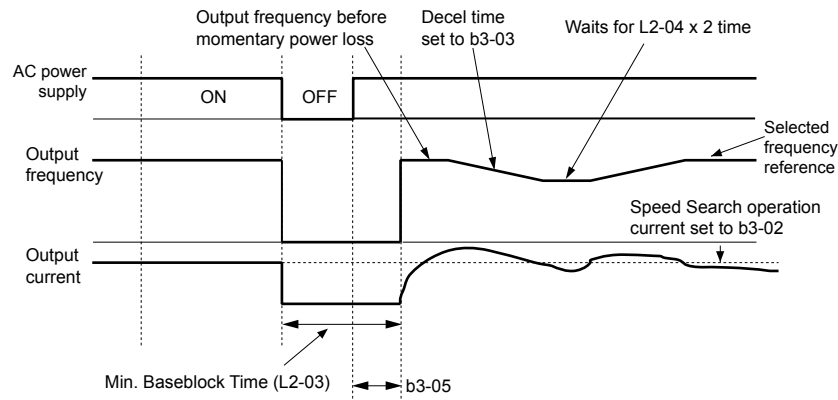

Figure 5.13 Current Detection Speed Search after Power Loss

Note: After power is restored, the drive waits until the time set to b3-05 has passed before performing Speed Search. Thereby the Speed Search may start not at the end of L2-03 but even later.

When Speed Search is applied using an external Search command or automatically with the Run command, the drive waits for the minimum baseblock time L2-03 before Speed Search is started. If L2-03 is smaller than the time set in parameter b3-05, b3-05 is used as the wait time.

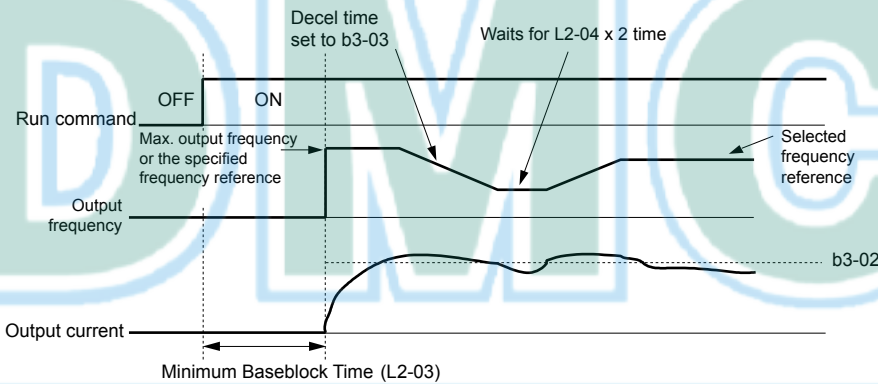

Figure 5.14 Current Detection Speed Search at Start or External Speed Search

Note: When the Run command is set the drive waits until the Speed Search Wait Time (b3-05) before Speed Search is performed, even if the Minimum Baseblock Time is set to smaller values than b3-05.

Notes on Using Current Detection Type Speed Search

- Increase the voltage recovery ramp time set to L2-04 if a Uv1 fault occurs when performing Current Detection Speed Search.
- Shorten the Speed Search deceleration time set to b3-03 if an oL1 fault occurs while performing Current Detection Speed Search.
- Current Detection Speed Search is not available when using Open Loop Vector Control for PM motors.
- Increase the minimum baseblock time set to L2-03 if an overcurrent fault occurs when performing Speed Search after power is restored following a momentary power loss.

■ Activation of Speed Search

Speed Search can be activated as described below. Independent of the activation method the Speed Search type must be selected in parameter b3-24.

1. Automatically at every Run command (*Refer to b3-01: Speed Search Selection at Start on page 133*). With this setting external Speed Search commands are disregarded.
2. By digital inputs:
The following input functions for H1-□□ can be used.

Table 5.5 Speed Search Activation by Digital Inputs

Setting	Description	b3-24 = 0	b3-24 = 1
61	External Search Command 1	Closed: Activate Current Detection Speed Search from the maximum output frequency (E1-04).	Activate Speed Estimation Speed Search
62	External Search Command 2	Closed: Activate Current Detection Speed Search from the frequency reference if b3-01 is set to 0.	–

To activate Speed Search by a digital input the input must always be set together with the Run command.

3. After automatic fault restart

Set the number of maximum fault restarts in parameter L5-01 higher than 0.

4. After momentary power loss

The following parameter settings are necessary:

Enable Power Loss Ride-Thru selection by setting L2-01 to 1 (enabled) or 2 (enabled during CPU operation). *Refer to L2-01: Momentary Power Loss Operation Selection on page 218.*

Set the number of maximum fault restarts in parameter L5-01 higher than 0.

5. After baseblock is released

The drive will resume the operation starting with Speed Search if the Run command is present and the output frequency is above the minimum frequency when the Baseblock command (H1-□□ = 8 or 9, N.O. and N.C., respectively) is released.

■ b3-01: Speed Search Selection at Start

Selects if Speed Search is automatically performed when a Run command is issued.

No.	Parameter Name	Setting Range	Default
b3-01	Speed Search Selection at Start	0 or 1	0

Setting 0: Disabled

Speed Search is not automatically performed. It can be activated using a digital input.

Setting 1: Enabled

Speed Search is performed with every Run command.

■ b3-02: Speed Search Deactivation Current

Sets Speed Search operating current as a percentage of the drive rated current. If the current falls below this level while performing Current Detection Speed Search then Speed Search will be finished and normal operation will resume. Normally there is no need to change this setting. If the drive won't run after a restart, lower this value.

No.	Name	Setting Range	Default
b3-02	Speed Search Deactivation Current	0 to 200%	Determined by A1-02

Note: When parameter A1-02 = 0 (V/f Control) the factory default setting is 120. When parameter A1-02 = 2 (Open Loop Vector) the factory default setting is 100.

■ b3-03: Speed Search Deceleration Time

Parameter b3-03 sets the output frequency reduction ramp used by Current Detection Speed Search (b3-24 = 0) and by the Current Injection Method of Speed Estimation (b3-24 = 1). The time entered into b3-03 will be the time to decelerate from maximum frequency (E1-04) to minimum frequency (E1-09).

No.	Name	Setting Range	Default
b3-03	Speed Search Deceleration Time	0.1 to 10.0 s	2.0 s

■ b3-05: Speed Search Delay Time

In cases where an output contactor is used between the drive and the motor, the contactor must be closed before Speed Search can be performed. For Speed Search after a momentary power loss, parameter b3-05 can be used to delay the Speed Search start providing enough time to operate the contactor.

When Speed Search at start is used, b3-05 will serve as the lower limit of the minimum baseblock time (L2-03).

5.2 b: Application

No.	Name	Setting Range	Default
b3-05	Speed Search Delay Time	0.0 to 100.0 s	0.2 s

■ b3-06: Output Current 1 During Speed Search

Sets the current injected to the motor at the beginning of Estimation Type Speed Search as a factor related to motor rated current set in E2-01 and E4-01. If the motor speed is relatively slow when the drive starts to perform Speed Search after a long period of baseblock, it may be helpful to increase the setting value. The output current during Speed Search is automatically limited by the drive rated current. This function has no influence when Current Detection Speed Search is used (b3-24 = 0).

No.	Name	Setting Range	Default
b3-06	Output Current 1 during Speed Search	0.0 to 2.0	Determined by o2-04

Note: If Speed Estimation is not working correctly even after adjusting b3-06, try using Current Detection Speed Search instead.

■ b3-08: Current Control Gain during Speed Search (Speed Estimation Type)

Note: Parameter available in drive software versions PRG: 1022 and later.

Sets the proportional gain for the current controller during Speed Search. There is normally no need to change this parameter from the default value.

No.	Name	Setting Range	Default
b3-08	Current Control Gain during Speed Search (Speed Estimation Type)	0.00 to 6.00	A1-02 = 0 or 2: 0.50 A1-02 = 5: 0.30

■ b3-10: Speed Search Detection Compensation Gain

This parameter sets the gain for the detected motor speed of the Speed Estimation Speed Search. The drive will start the motor at the estimated speed multiplied by b3-10. The setting should be increased if an overvoltage fault occurs when the drive restarts the motor. This function has no influence when Current Detection Speed Search is used (b3-24 = 0).

No.	Name	Setting Range	Default
b3-10	Speed Search Detection Compensation Gain	1.00 to 1.20	1.10

Note: Increase this value if overvoltage occurs when performing Speed Search at start after a relatively long period of baseblock.

■ b3-14: Bi-Directional Speed Search Selection

Sets how the drive determines the motor rotation direction when performing Speed Estimation Speed Search. The setting has no influence on Current Detection Speed Search (b3-24 = 0).

No.	Parameter Name	Setting Range	Default
b3-14	Bi-Directional Speed Search Selection	0 or 1	0

Setting 0: Disabled

The drive uses the frequency reference to determine the direction of motor rotation in order to restart the motor.

Setting 1: Enabled

The drive detects the motor rotation direction in order to restart the motor.

■ b3-17: Speed Search Restart Current Level

If there is a fairly large difference between the estimated frequency and the actual motor speed when performing Speed Estimation, a large current can flow. This parameter sets the current level at which Speed Estimation is restarted, thus avoiding overcurrent and overvoltage problems. The parameter is set as a percentage of the drive rated current. This function has no influence when Current Detection Speed Search is used (b3-24 = 0).

No.	Name	Setting Range	Default
b3-17	Speed Search Restart Current Level	0 to 200%	150%

■ b3-18: Speed Search Restart Detection Time

Sets the time the current must be above the level set in b3-17 before Speed Search is restarted. This function has no influence when Current Detection Speed Search is used (b3-24 = 0)

No.	Name	Setting Range	Default
b3-18	Speed Search Restart Detection Time	0.00 to 1.00 s	0.10 s

■ b3-19: Number of Speed Search Restarts

Sets the number of times the drive should attempt to find the speed and restart the motor using Speed Estimation Speed Search. This function has no influence when Current Detection Speed Search is used (b3-24 = 0).

No.	Name	Setting Range	Default
b3-19	Number of Speed Search Restarts	0 to 10	3

■ b3-24: Speed Search Method Selection

Sets the Speed Search method used.

Note: For explanations of the Speed Search methods, *Refer to Current Detection Type Speed Search (b3-24 = 0) on page 131* and *Refer to Speed Estimation Type Speed Search (b3-24 = 1) on page 130*.

No.	Parameter Name	Setting Range	Default
b3-24	Speed Search Method Selection	0 or 1	0

Setting 0: Current Detection Speed Search

Setting 1: Speed Estimation Speed Search

■ b3-25: Speed Search Wait Time

Sets the wait time between Speed Search restarts.

No.	Name	Setting Range	Default
b3-25	Speed Search Wait Time	0.0 to 30.0 s	0.5 s

■ b3-29: Speed Search Induced Voltage Level

Performs Speed Search when the motor induced voltage exceeds the set level.

There is normally no need to change this parameter from the default value. Lower this value in small increments if changes are necessary. However, setting this value too low will prevent the drive from performing Speed Search.

No.	Name	Setting Range	Default
b3-29	Speed Search Induced Voltage Level	0 to 10%	10%

◆ b4: Delay Timers

The timer function is independent of the drive operation and can be used to delay the switching of a digital output triggered by a digital input signal. An On-delay and Off-delay can be separately set. The delay timer can help to get rid of chattering switch noise from sensors.

To enable the timer function, a multi-function input must be set to “Timer input” (H1-□□ = 18) and a multi-function output must be set to “Timer output” (H2-□□ = 12). Only one timer can be used.

■ b4-01/b4-02: Timer Function On/Off-Delay Time

b4-01 sets the On-delay time for switching the timer output. b4-02 sets the Off-delay time for switching the timer output.

No.	Name	Setting Range	Default
b4-01	Timer Function On-Delay Time	0.0 to 300.0 s	0.0 s
b4-02	Timer Function Off-Delay Time	0.0 to 300.0 s	0.0 s

■ Timer Function Operation

When the timer function input closes for longer than the value set in b4-01, the timer output switches on. When the timer function input is open for longer than the value set in b4-02, the timer output function switches off. The following diagram demonstrates the timer function operation.

5.2 b: Application

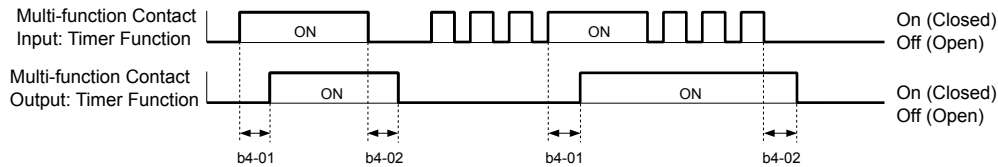

Figure 5.15 Timer Operation

◆ b5: PID Control

The drive has a built in PID (Proportional + Integral + Derivative) controller that can be used for closed loop control of system variables such as pressure, temperature etc. The difference between the target and the feedback value (deviation) is fed into the PID controller. The PID controller adjusts the drive output frequency in order to minimize the deviation, providing an accurate control of the system variables.

■ P Control

The output of P control is the product of the deviation and the P gain so that it follows the deviation directly and linearly. With P control only an offset between the target and feedback remains.

■ I Control

The output of I control is the integral of the deviation. It minimizes the offset between target and feedback value that typically remains when pure P control is used. The integral time (I-time) constant determines how fast the offset is eliminated.

■ D Control

D control predicts the deviation signal by multiplying its derivative (slope of the deviation) with a time constant and adding this to the PID input. This way the D portion of a PID controller provides a braking action to the controller response and can reduce the tendency of oscillations and overshoot.

Be aware that D control tends to amplify noise on the deviation signal, which can result in control instability. D control should therefore only be used when necessary.

■ PID Operation

To better demonstrate how PID works, the diagram below shows how the PID output changes when the PID input (deviation) jumps from 0 to a constant level.

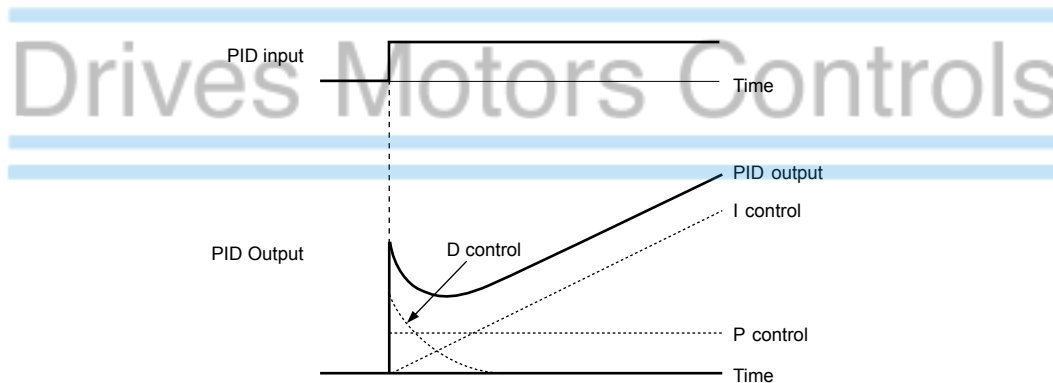

Figure 5.16 PID Operation

■ Using PID Control

Applications for PID control are listed in the table below.

Application	Description	Sensors Used
Speed Control	Machinery speed is fed back and adjusted to meet the target value. Synchronous control is performed using speed data from other machinery as the target value	Tachometer
Pressure	Maintains constant pressure using pressure feedback.	Pressure sensor
Fluid Control	Keeps flow at a constant level by feeding back flow data.	Flow rate sensor
Temperature Control	Maintains a constant temperature by controlling a fan with a thermostat.	Thermocoupler, Thermistor

■ PID Setpoint Input Methods

When the PID control parameter b5-01 is set to 1 or 2, the frequency reference in b1-01 (or b1-15) becomes the PID setpoint. If b5-01 is set to 3 or 4, then the PID setpoint can be input from one of the sources in the following table.

Table 5.6 PID Setpoint Sources

PID Setpoint Source	Settings
Analog Input A1	Set H3-02 = C
Analog Input A2	Set H3-10 = C
MEMOBUS/Modbus Register 0006H	Set Bit 1 in register 000FH to 1 and input the setpoint to register 0006H
Pulse Input RP	Set H6-01 = 2
Parameter b5-19	Set parameter b5-18 = 1 and input the PID setpoint to b5-19

Note: A duplicate allocation of the PID setpoint input will result in an OPE alarm.

■ PID Feedback Input Methods

Either one feedback signal can be input for normal PID control or two feedback signals can be input for controlling a differential process value.

Normal PID Feedback

The PID feedback can be input from one of the sources listed below.

Table 5.7 PID Feedback Sources

PID Feedback Source	Settings
Analog Input A1	Set H3-02 = B
Analog Input A2	Set H3-10 = B
Pulse Input RP	Set H6-01 = 1

Note: A duplicate allocation of the PID feedback input will result in an OPE alarm.

Differential Feedback

The second PID feedback signal for differential feedback can come from the sources listed below. The differential feedback function is automatically enabled when a differential feedback input is assigned.

Table 5.8 PID Differential Feedback Sources

PID Differential Feedback Source	Settings
Analog Input A1	Set H3-02 = 16
Analog Input A2	Set H3-10 = 16

Note: A duplicate allocation of the PID differential feedback input will result in an OPE alarm.

■ PID Block Diagram

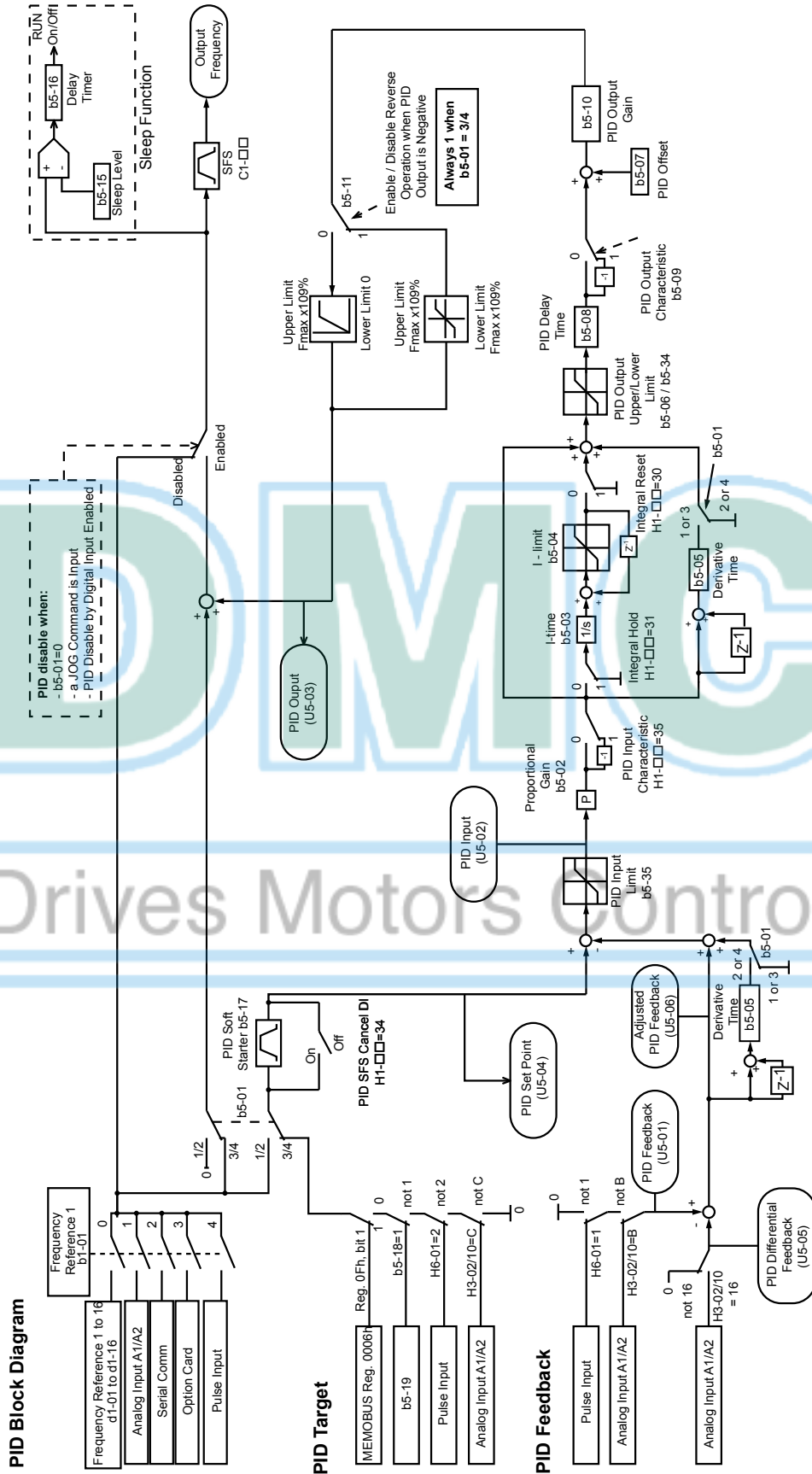

Figure 5.17 PID Block Diagram

■ b5-01: PID Function Setting

Enables or disables the PID operation and selects the PID operation mode.

No.	Parameter Name	Setting Range	Default
b5-01	PID Function Setting	0 to 4	0

Setting 0: PID disabled

Setting 1: Output Frequency = PID Output 1

The PID controller is enabled and the PID output builds the frequency reference. The PID input is D controlled.

Setting 2: Output Frequency = PID Output 2

The PID controller is enabled and the PID output builds the frequency reference. The PID feedback is D controlled.

Setting 3: Output Frequency = Frequency Reference + PID Output 1

The PID controller is enabled and the PID output is added to the frequency reference. D control is applied to the difference of the feedback value (U5-02) and the setpoint.

Setting 4: Output Frequency = Frequency Reference + PID Output 2

The PID controller is enabled and the PID output is added to the frequency reference. Applies D control on the feedback value (U5-06).

■ b5-02: Proportional Gain Setting (P)

Sets the P gain that is applied to the PID input. A large value will tend to reduce the error, but may cause instability (oscillations) if too high. A small value may allow too much offset between the setpoint and feedback.

No.	Name	Setting Range	Default
b5-02	Proportional Gain Setting (P)	0.00 to 25.00	1.00

■ b5-03: Integral Time Setting (I)

Sets the time constant that is used to calculate the integral of the PID input. The smaller the integral time set to b5-03, the faster the offset will be eliminated. If set too short, it can cause overshoot or oscillations. To turn off the integral time, set b5-03 = 0.00.

No.	Name	Setting Range	Default
b5-03	Integral Time Setting (I)	0.0 to 360.0 s	1.0 s

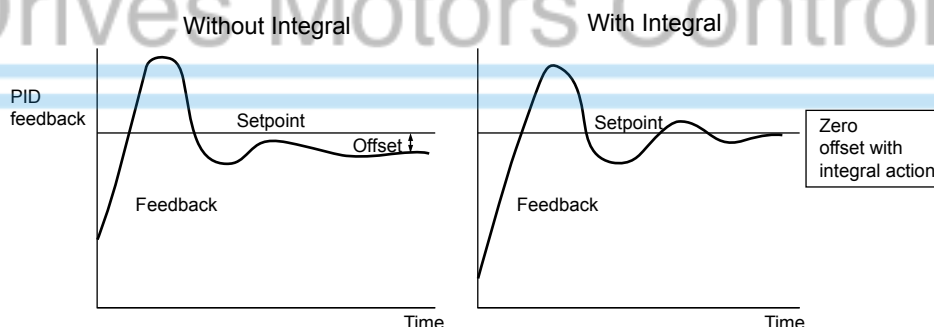

Figure 5.18 Offset Elimination by Integral Operation

■ b5-04: Integral Limit Setting

Sets the maximum output possible from the integral block. Set as a percentage of the maximum frequency (E1-04).

No.	Name	Setting Range	Default
b5-04	Integral Limit Setting	0.0 to 100.0	100.0

Note: On some applications, especially those with rapidly varying loads, the output of the PID function may show a fair amount of oscillation. To suppress this oscillation, a limit can be applied to the integral output by programming b5-04.

5.2 b: Application

■ b5-05: Derivative Time (D)

Sets the time the drive predicts the PID input/PID feedback signal based on the derivative of the PID input/PID feedback. Longer time settings will improve the response but can cause vibrations. Shorter settings will reduce the overshoot but also reduce the controller responsiveness. D control is disabled by setting b5-05 to zero seconds.

No.	Name	Setting Range	Default
b5-05	Derivative Time	0.00 to 10.00 s	0.00 s

■ b5-06: PID Output Limit

Sets the maximum output possible from the entire PID controller. Set as a percentage of the maximum frequency (E1-04).

No.	Name	Setting Range	Default
b5-06	PID Output Limit	0.0 to 100.0%	100.0%

■ b5-07: PID Offset Adjustment

Sets the offset added to the PID controller output. Set as a percentage of the maximum frequency.

No.	Name	Setting Range	Default
b5-07	PID Offset Adjustment	-100.0 to 100.0%	0.0%

■ b5-08: PID Primary Delay Time Constant

Sets the time constant for the filter applied to the output of the PID controller. Normally, change is not required.

No.	Name	Setting Range	Default
b5-08	PID Primary Delay Time Constant	0.00 to 10.00 s	0.00 s

Note: Effective in preventing oscillation when there is a fair amount of oscillation or when rigidity is low. Set to a value larger than the cycle of the resonant frequency. Increasing this time constant reduces the responsiveness of the drive.

■ b5-09: PID Output Level Selection

Normally, the output of the PID function increase whenever the PID input is negative (feedback below setpoint). Using b5-09 the PID controller can be set up for applications that require opposite operation.

No.	Parameter Name	Setting Range	Default
b5-09	PID Output Level Selection	0 or 1	0

Setting 0: Normal Output

A negative PID input causes an increase in the PID output (direct acting).

Setting 1: Reverse Output

A negative PID input causes a decrease in the PID output (reverse acting).

■ b5-10: PID Output Gain Setting

Applies a gain to the PID output and can be helpful when the PID function is used to trim the frequency reference (b5-01 = 3 or 4). Increasing b5-10 causes the PID function to have a greater regulating effect on the frequency reference.

No.	Name	Setting Range	Default
b5-10	PID Output Gain Setting	0.00 to 25.00	1.00

■ b5-11: PID Output Reverse Selection

Determines whether a negative PID output reverses the drive operation direction or not. When the PID function is used to trim the frequency reference (b5-01 = 3 or 4), this parameter has no effect and the PID output will not be limited (same as b5-11 = 1).

No.	Parameter Name	Setting Range	Default
b5-11	PID Output Reverse Selection	0 or 1	0

Setting 0: Reverse Disabled

Negative PID output will be limited to 0 and the drive output will be stopped.

Setting 1: Reverse Enabled

Negative PID output will cause the drive to run in the opposite direction.

■ PID Feedback Loss Detection

The PID Feedback Loss Detection function can detect broken sensors or broken sensor wiring. It should be used whenever PID control is enabled to prevent critical machine conditions (e.g. acceleration to max. frequency) caused by a feedback loss.

Feedback loss can be detected in two ways:

- **Feedback Low Detection:**

Detected when the feedback falls below a certain level for longer than the specified time.

- **Feedback High Detection:**

Detected when the feedback rises beyond a certain level for longer than the specified time.

The following figure explains the working principle of feedback loss detection when the feedback signal is too low. Feedback high detection works in the same way.

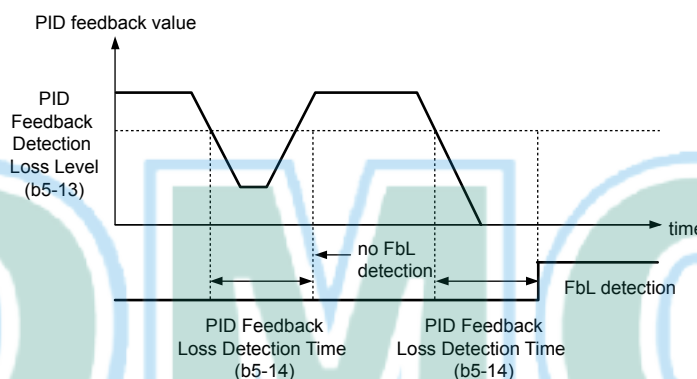

Figure 5.19 PID Feedback Loss Detection

The parameters necessary to set up the feedback loss detection are explained below.

■ b5-12: PID Feedback Loss Detection Selection

Enables or disables the feedback loss detection and sets the operation when a feedback loss is detected.

No.	Parameter Name	Setting Range	Default
b5-12	PID Feedback Loss Detection Selection	0 to 5	0

Setting 0: Digital Output Only

A digital output set for “PID feedback low” (H2-□□ = 3E) will be triggered if the PID feedback value is below the detection level set to b5-13 for the time set to b5-14 or longer. A digital output set for “PID feedback high” (H2-□□ = 3F) will be triggered if the PID feedback value is beyond the detection level set to b5-36 for the time set to b5-37 or longer. Neither a fault nor an alarm is displayed on the digital operator. The drive will continue operation. When the feedback value leaves the loss detection range, the output is reset.

Setting 1: Feedback Loss Alarm

If the PID feedback value falls below the level set to b5-13 for longer than the time set to b5-14, a “FBL - Feedback Low” alarm will be displayed and a digital output set for “PID feedback low” (H2-□□ = 3E) will be triggered. If the PID feedback value exceeds the level set to b5-36 for longer than the time set to b5-37, a “FBH - Feedback High” alarm will be displayed and a digital output set for “PID feedback high” (H2-□□ = 3F) will be triggered. Both events trigger an alarm output (H1-□□ = 10). The drive will continue operation. When the feedback value leaves the loss detection range, the alarm and outputs are reset.

Setting 2: Feedback Loss Fault

If the PID feedback value falls below the level set to b5-13 for longer than the time set to b5-14, a “FBL - Feedback Low” fault will be displayed. If the PID feedback value exceeds the level set to b5-36 for longer than the time set to b5-37, a “FBH - Feedback High” fault will be displayed. Both events trigger a fault output (H1-□□ = E) and cause the drive to stop the motor.

Setting 3: Digital Output Only, Even if PID is Disabled by Digital Input

Same as b5-12 = 0. Detection is still active even if PID is disabled by a digital input (H1-□□ = 19).

5.2 b: Application

Setting 4: Feedback Loss Alarm, Even if PID is Disabled by Digital Input

Same as b5-12 = 1. Detection is still active even if PID is disabled by a digital input (H1-□□ = 19).

Setting 5: Feedback Loss Fault, Even if PID is Disabled by Digital Input

Same as b5-12 = 2. Detection is still active even if PID is disabled by a digital input (H1-□□ = 19).

■ b5-13: PID Feedback Loss Detection Level

Sets the feedback level used for PID feedback loss detection. The PID feedback has to fall below this level for longer than the time b5-14 before feedback loss is detected.

No.	Name	Setting Range	Default
b5-13	PID Feedback Loss Detection Level	0 to 100%	0%

■ b5-14: PID Feedback Loss Detection Time

Sets the time that the PID feedback has to fall below b5-13 before feedback loss is detected.

No.	Name	Setting Range	Default
b5-14	PID Feedback Loss Detection Time	0.0 to 25.5 s	1.0 s

■ b5-36: PID Feedback High Detection Level

Sets the feedback level used for PID feedback high detection. The PID feedback has to exceed this level for longer than the time b5-37 before feedback loss is detected.

No.	Name	Setting Range	Default
b5-36	PID Feedback High Detection Level	0 to 100%	100%

■ b5-37: PID Feedback High Detection Time

Sets the time for that the PID feedback has to exceed b5-36 before feedback loss is detected.

No.	Name	Setting Range	Default
b5-37	PID Feedback High Detection Time	0.0 to 25.5 s	1.0 s

■ PID Sleep

The PID Sleep function stops the drive when the PID output or the frequency reference falls below the PID Sleep operation level for a certain time. The drive will resume operating once the PID output or frequency reference rises above the PID Sleep operation level for the specified time. The operation is explained in the figure below.

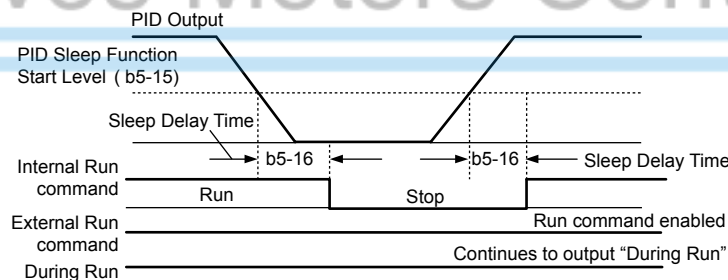

Figure 5.20 PID Sleep Operation

Notes on using the PID Sleep function:

- The PID Sleep function is always active, even if PID control is disabled.
- The method the Sleep function uses to stop the motor is defined by parameter b1-03.
- The parameters necessary to set up the PID Sleep function are explained below.

■ b5-15: PID Sleep Function Start Level

Sets the level used for PID Sleep.

The drive goes into Sleep mode if the PID output or frequency reference is smaller than b5-15 for longer than the time set in b5-16. It resumes the operation when the PID output or frequency reference is above b5-15 for longer than the time set in b5-16.

No.	Name	Setting Range	Default
b5-15	PID Sleep Function Start Level	0.0 to 400.0 Hz	0.0 Hz

■ b5-16: PID Sleep Delay Time

Sets the delay time to activate or deactivate the PID Sleep function.

No.	Name	Setting Range	Default
b5-16	PID Sleep Delay Time	0.0 to 25.5 s	0.0 s

■ b5-17: PID Accel/Decel Time

The PID acceleration/deceleration time is applied on the PID setpoint value.

As the normal acceleration times C1-□□ are applied after the PID output, they reduce the responsiveness of the system and can cause hunting or over- and undershooting when the setpoint changes quickly. Using the PID acceleration/deceleration time instead helps to avoid such problems.

The PID acceleration/deceleration time can be canceled using a digital input programmed for “PID SFS cancel” (H1-□□ = 34).

No.	Name	Setting Range	Default
b5-17	PID Accel/Decel Time	0 to 255 s	0 s

■ b5-18: PID Setpoint Selection

Enables or disables parameter b5-19 for PID setpoint.

No.	Parameter Name	Setting Range	Default
b5-18	PID Setpoint Selection	0 or 1	0

Setting 0: Disabled

Parameter b5-19 is not used as the PID setpoint. The setpoint must be entered via an analog input, pulse input, or MEMOBUS/Modbus register 06H.

Setting 1: Enabled

Parameter b5-19 is used as PID setpoint.

■ b5-19: PID Setpoint Value

Used to adjust the PID setpoint if parameter b5-18 = 1.

No.	Name	Setting Range	Default
b5-19	PID Setpoint Value	0.00 to 100.00%	0.00%

■ b5-20: PID Setpoint Scaling

Determines the units that the PID setpoint (b5-19) is set in and displayed. Also determines the units for monitors U5-01 and U5-04.

No.	Parameter Name	Setting Range	Default
b5-20	PID Setpoint Scaling	0 to 3	1

Setting 0: Hz

The setpoint and PID monitors are displayed in Hz with a resolution of 0.01 Hz.

Setting 1: %

The setpoint and PID monitors are displayed as a percentage with a resolution of 0.01%.

Setting 2: r/min

The setpoint and PID monitors are displayed in r/min with a resolution of 1 r/min.

Setting 3: User Defined

The setpoint b5-19 and PID monitors U1-01/04 are displayed with the unit and resolution defined by parameters b5-38 and b5-39.

5.2 b: Application

■ b5-34: PID Output Lower Limit

Sets the minimum possible PID controller output as a percentage of the maximum output frequency (E1-04). The lower limit is disabled when set to 0.00%

No.	Name	Setting Range	Default
b5-34	PID Output Lower Limit	-100.0 to 100.0%	0.00%

■ b5-35: PID Input Limit

Sets the maximum allowed PID input as a percentage of the maximum output frequency (E1-04). Parameter b5-35 acts as a bipolar limit.

No.	Name	Setting Range	Default
b5-35	PID Input Limit	0.0 to 1000.0%	1000.0%

■ b5-38/39 PID Setpoint/Monitor User Display Value/Display Digits

When parameter b5-20 is set to 3, the parameters b5-38 and b5-39 can be used to set a user defined display for the PID setpoint (b5-19) and feedback monitors (U5-01/04).

Parameter b5-38 determines the display value when the maximum frequency is output. Parameter b5-39 determines the number of digits. The setting value is equal to the number of decimal places.

No.	Name	Setting Range	Default
b5-38	PID Setpoint/Monitor User Display Value	0 to 60000	Determined by b5-20
b5-39	PID Setpoint and Display Digits	0 to 3	Determined by b5-20

■ b5-40: Frequency Reference Monitor Content During PID

Sets the content on the frequency reference monitor display (U1-01) when PID control is active.

No.	Name	Setting Range	Default
b5-40	Frequency Reference Monitor Content During PID	0 or 1	0

Setting 0: Frequency Reference after PID

Monitor U1-01 displays the frequency reference increased or reduced for the PID output.

Setting 1: Frequency Reference

Monitor U1-01 displays the frequency reference value.

■ b5-47: Reverse Operation Selection 2 by PID Output

Reverses operation selection when b5-01 is set to 3 or 4.

No.	Name	Setting Range	Default
b5-47	Reverse Operation Selection 2 by PID Output	0 or 1	1

Setting 0: Zero Limit when PID Output is a Negative Value

Setting 1: Reverse Operation when PID Output is a Negative Value (Zero Limit if the Reverse Operation Is Prohibited by b1-04)

◆ b6: Dwell Function

The reference hold or Dwell function is used to temporarily hold the output frequency at a set reference value, for a set time, and then continue to ramp up or stop.

The Dwell at start function can be used when driving a permanent magnet motor in V/f Control, or a motor with a heavy starting load. The pause in acceleration allows the PM motor rotor to align with the stator field of the motor, thus reducing the starting current.

Dwell works as shown in the figure below.

Note: Using the Dwell function requires that the stopping method for the drive be set to “Ramp to Stop” (b1-03 = 0).

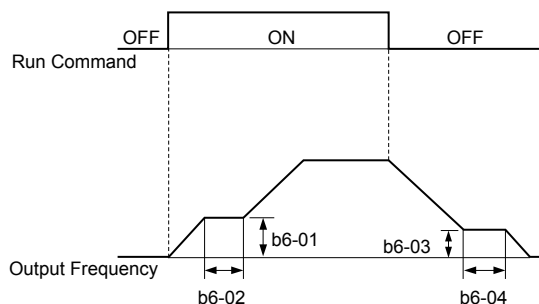

Figure 5.21 Dwell Function at Start and Stop

■ b6-01/b6-02: Dwell Reference/Time at Start

b6-01 sets the frequency that is kept for the time set in b6-02 during acceleration.

No.	Name	Setting Range	Default
b6-01	Dwell Reference at Start	0.0 to 400.0 Hz	0.0 Hz
b6-02	Dwell Time at Start	0.0 to 10.0 s	0.0 s

■ b6-03/b6-04: Dwell Reference/Time at Stop

Parameter b6-03 sets the frequency that is kept for the time set in b6-04 during deceleration.

No.	Name	Setting Range	Default
b6-03	Dwell Reference at Stop	0.0 to 400.0 Hz	0.0 Hz
b6-04	Dwell Time at Stop	0.0 to 10.0 s	0.0 s

◆ b8: Energy Saving

The Energy Saving feature improves overall system operating efficiency by operating the motor at its most efficient level. This is accomplished by continuously monitoring the motor load and controlling the motor so that it always operates near its rated slip frequency.

Note: Energy Saving is mainly designed for applications with variable torque (Normal Duty) but is not appropriate for applications where the load may suddenly increase.

■ b8-01: Energy Saving Control Selection

Enables or disables the Energy Saving function.

No.	Parameter Name	Setting Range	Default
b8-01	Energy Saving Control Selection	0 or 1	0

Setting 0: Disabled

Setting 1: Enabled

■ b8-02: Energy Saving Gain (OLV only)

Sets the gain that is used to for magnetizing current reduction during Energy Saving. A higher value results in lower magnetization of the motor and thereby less energy consumption. However, if b8-02 is too high the motor might stall.

No.	Name	Setting Range	Default
b8-02	Energy Saving Gain	0.00 to 10.0	0.7

■ b8-03: Energy Saving Control Filter Time Constant (OLV only)

Parameter b8-03 sets the response time for Energy Saving. Although lowering this value allows for a quicker response, instability may result if it is too low.

No.	Name	Setting Range	Default
b8-03	Energy Saving Control Filter Time Constant	0.00 to 10.00	Determined by o2-04

5.2 b: Application

■ b8-04: Energy Saving Coefficient Value (V/f Control)

Fine tunes Energy Saving control.

The default setting is for a standard Yaskawa motor. When using a different motor, adjust this parameter in 5% increments while running the drive with a light load until output power monitor U1-08 is at the minimum value.

A low setting results in less output voltage and less energy consumption. If the value is set too low the motor may stall. The default setting depends on the capacity of the drive.

No.	Name	Setting Range	Default
b8-04	Energy Saving Coefficient Value	0.00 to 655.00	Determined by C6-01, E2-11, and o2-04

Note: This default value changes if the motor rated capacity set to E2-11 is changed. The Energy Saving coefficient is set automatically when Auto-Tuning for Energy Saving is performed ([Refer to Auto-Tuning on page 102](#)).

■ b8-05: Power Detection Filter Time (V/f Control only)

The Energy Saving function continuously searches out the lowest output voltage in order to achieve minimum output power. Parameter b8-05 determines how often the output power is measured and the output voltage is adjusted.

No.	Name	Setting Range	Default
b8-05	Power Detection Filter Time	0 to 2000 ms	20 ms

■ b8-06: Search Operation Voltage Limit (V/f Control only)

Sets the voltage limit for the optimal output voltage detection of Speed Search as a percentage of the maximum output voltage. During the search operation the drive will keep the output voltage above this level to prevent motor stalling.

Note: If set too low, the motor may stall with a sudden increase to the load. Disabled when b8-06 = 0. Setting this value to 0 does not disable Energy Saving.

No.	Name	Setting Range	Default
b8-06	Search Operation Voltage Limit	0 to 100%	0%

■ Parameters Related to the Energy Saving Function

Open Loop Vector Control

No.	Parameter Name	Setting Range	Default
E2-02 <1>	Motor Rated Slip	0.00 to 20.00	<2>

<1> Automatically set when Rotational Auto-Tuning is performed.

<2> Default setting is determined by drive capacity (o2-04).

V/f Control

No.	Parameter Name	Setting Range	Default
E2-11 <1>	Motor Rated Capacity	0.00 to 650.00 kW	<2>

<1> Automatically set when Auto-Tuning is performed.

<2> Default setting is determined by drive capacity (o2-04).

5.3 C: Tuning

C parameters are used to set the acceleration and deceleration characteristics, as well as S-curves. Other parameters in this group cover settings for slip compensation, torque compensation, and carrier frequency.

◆ C1: Acceleration and Deceleration Times

■ C1-01 to C1-08: Accel/Decel Times 1 to 4

Four different sets of acceleration and deceleration times can be set in the drive. They can be selected by digital inputs, by the motor selection, or can be switched automatically. Acceleration time parameters always set the time to accelerate from 0 to the maximum output frequency (E1-04). Deceleration time parameters always set the time to decelerate from maximum output frequency to 0. C1-01 and C1-02 are the default active accel/decel settings.

No.	Parameter Name	Setting Range	Default
C1-01	Acceleration Time 1	0.0 to 6000.0 s $\langle \triangleright \rangle$	10.0 s
C1-02	Deceleration Time 1		
C1-03	Acceleration Time 2		
C1-04	Deceleration Time 2		
C1-05	Acceleration Time 3 (Motor 2 Accel Time 1)		
C1-06	Deceleration Time 3 (Motor 2 Decel Time 1)		
C1-07	Acceleration Time 4 (Motor 2 Accel Time 2)		
C1-08	Deceleration Time 4 (Motor 2 Accel Time 2)		

$\langle \triangleright \rangle$ The setting range for the acceleration and deceleration times is determined by C1-10 (Accel/Decel Time Setting Units). For example, if the time is set in units of 0.01 s (C1-10 = 0), the setting range becomes 0.00 to 600.00 s.

Switching Acceleration Times by Digital Input

Accel/decel times 1 are active by default if no input is set. The accel/decel times 2, 3, and 4 can be activated by digital inputs (H1-□□ = 7 and 1A) as explained in [Table 5.9](#).

Table 5.9 Accel/Decel Time Selection by Digital Input

Accel/Decel Time Sel. 1 H1-□□ = 7	Accel/Decel Time Sel. 2 H1-□□ = 1A	Active Times	
		Acceleration	Deceleration
0	0	C1-01	C1-02
1	0	C1-03	C1-04
0	1	C1-05	C1-06
1	1	C1-07	C1-08

[Figure 5.22](#) shows an operation example for changing accel/decel. times. The example below requires that the stopping method be set for "Ramp to Stop" (b1-03 = 0).

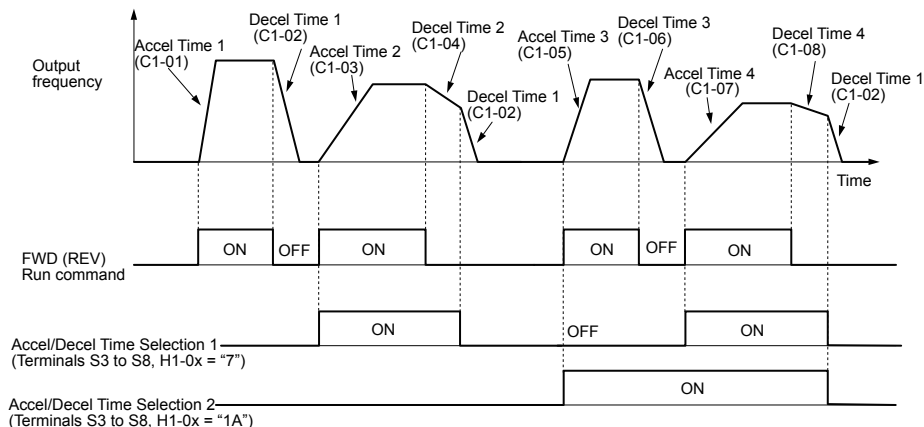

Figure 5.22 Timing Diagram of Accel/Decel Time Change

5.3 C: Tuning

Switching Accel/decel Times by a Frequency Level

The drive can automatically switch from accel/decel times 4 (C1-07 and C1-08) to the default accel/decel times (C1-01/02 for motor 1, C1-05/06 for motor 2) when the output frequency exceeds the frequency level set in parameter C1-11. When it falls below this level, the accel/decel times are switched back. **Figure 5.23** shows an operation example.

Note: Acceleration and deceleration times selected by digital inputs have priority over the automatic switching by a frequency level. For example, if accel/decel time 2 is selected, the drive will use this time only and not switch from accel/decel time 4 to the selected one.

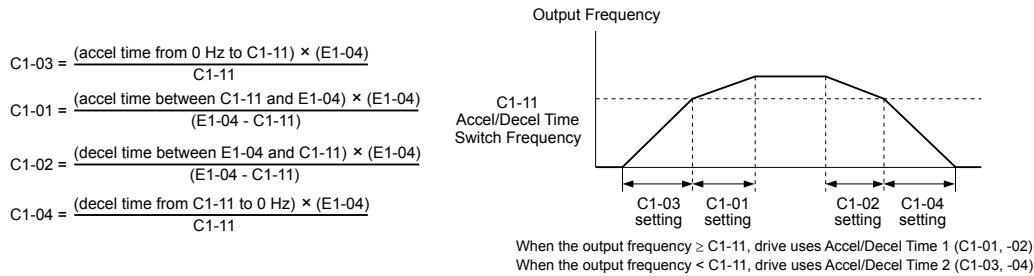

Figure 5.23 Accel/Decel Time Switching Frequency

Switching Acceleration and Deceleration Times by Motor Selection

When switching between motor 1 and 2 using a digital input (H1-□□ = 16) parameters C1-01 to C1-04 become accel/decel time 1/2 for motor 1 and C1-05 to C1-08 become accel/decel time 1/2 for motor 2. In this case the digital input “Accel/Decel Time 2 Selection” cannot be used (this would trigger an oPE03 error, indicating a contradictory multi-function input settings).

Table 5.10 explains the activation of accel/decel times depending on the motor selection and accel/decel time selection.

Table 5.10 Motor Switching and Accel/Decel Time Combinations

Accel/Decel Time 1 (H1-□□ = 7)	Motor 1 Selected		Motor 2 Selected	
	Accel	Decel	Accel	Decel
Open	C1-01	C1-02	C1-05	C1-06
Closed	C1-03	C1-04	C1-07	C1-08

■ C1-09: Fast-stop Time

Parameter C1-09 will set a special deceleration that is used when certain faults occur or that can be operated by closing a digital input configured as H1-□□ = 15 (N.O. input) or H1-□□ = 17 (N.C. input). The input does not have to be closed continuously, even a momentary closure will trigger the Fast-stop operation.

Unlike standard deceleration, once the Fast-stop operation is initiated, the drive cannot be restarted until the deceleration is complete, the Fast-stop input is cleared, and the Run command is cycled.

A digital output programmed for “During Fast-stop” (H2-01/02/03 = 4C) will be closed as long as Fast-stop is active.

No.	Parameter Name	Setting Range	Default
C1-09	Fast-stop Time	0.0 to 6000.0 s <I>	10.0 s

<I> The setting range for the acceleration and deceleration times is determined by C1-10 (Accel/Decel Time Setting Units). For example, if the time is set in units of 0.01 s (C1-10 = 0), the setting range becomes 0.00 to 600.00 s

NOTICE: Rapid deceleration can trigger an overvoltage fault. When faulted, the drive output shuts off, and the motor coasts. To avoid this uncontrolled motor state and to ensure that the motor stops quickly and safely, set an appropriate Fast-stop time to C1-09.

■ C1-10: Accel/Decel Time Setting Units

Determines the units for the acceleration and deceleration times set to C1-01 through C1-09 using parameter C1-10.

No.	Parameter Name	Setting Range	Default
C1-10	Accel/Decel Time Setting Units	0 or 1	1

Setting 0: 0.01 s Units

The accel/decel. times are set in 0.01 s units. The setting range will be 0.00 to 600.00 s. If any of the parameters C1-01 to C1-09 is set to 600.1 seconds or more, then C1-10 cannot be set to 0.

Setting 1: 0.1 s Units

The accel/decel. times are set in 0.1 s units. The setting range will be 0.0 to 6000.0 s.

■ C1-11: Accel/Decel Switch Frequency

Sets the switching frequency for automation accel/decel time change over. *Refer to Switching Accel/decel Times by a Frequency Level on page 148* for details.

No.	Parameter Name	Setting Range	Default
C1-11	Accel/Decel Switch Frequency	0.0 to 400.0 Hz	0.0 Hz

Note: Setting C1-11 to 0.0 Hz disables this function.

■ C1-14: Accel/Decel Rate Frequency

Sets the base frequency used to calculate acceleration and deceleration times.

No.	Parameter Name	Setting Range	Default
C1-14	Accel/Decel Rate Frequency	0.0 to 400.0 Hz	0.0 Hz

Note: The accel/decel rates set to parameters C1-01 to C1-09 change in response to the value set to C1-14.

When C1-14 = 0.0 Hz

Operation example is shown in *Figure 5.24*.

- Accel Times 1 through 4 determine the time required to accelerate from 0 to the maximum output frequency (E1-04)
- Decel Times 1 through 4 and the Fast-stop Time determine the time required to decelerate from the Maximum Output Frequency (E1-04) to 0 Hz.

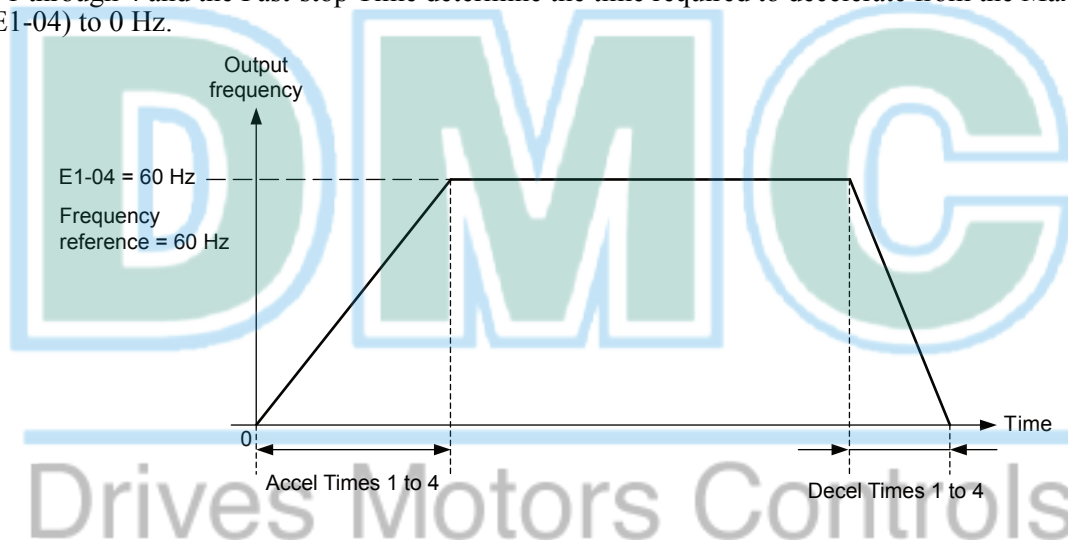

Figure 5.24 Accel/Decel Rate, Example 1 (C1-14 = 0 Hz, E1-04 = 60 Hz, Frequency Reference = 60 Hz)

When C1-14 ≠ 0.0 Hz

Operation examples are shown in *Figure 5.25* and *Figure 5.26*.

- Accel Times 1 through 4 determine the time required to accelerate from 0 to the value set in C1-14 (Accel/Decel Rate Frequency)
- Decel Times 1 through 4 and the Fast-stop Time determine the time required to decelerate from the value set in C1-14 (Accel/Decel Rate Frequency) to 0 Hz.

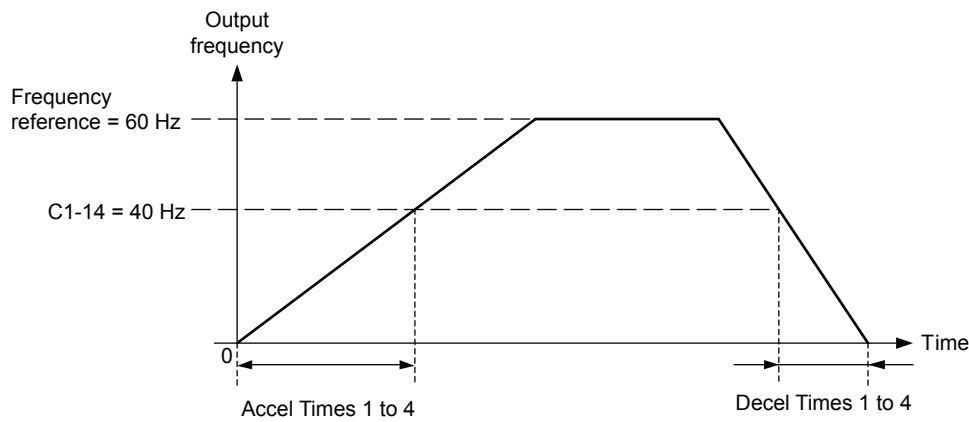

Figure 5.25 Accel/Decel Rate, Example 2 (C1-14 = 40 Hz, E1-04 = 60 Hz, Frequency Reference = 60 Hz)

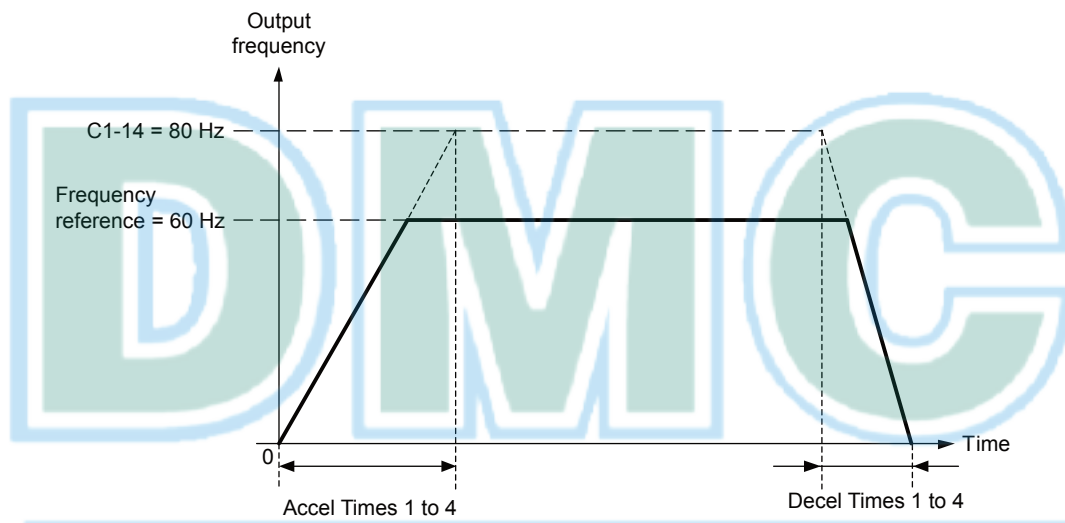

Figure 5.26 Accel/Decel Rate, Example 3 (C1-14 = 80 Hz, E1-04 = 60 Hz, Frequency Reference = 60 Hz)

- Note:**
1. The accel/decel times shown in [Figure 5.24](#) to [Figure 5.26](#) assume S-curve characteristic time during accel/decel at start and accel/decel at stop of 0.00 s (parameters C2-01 to C2-04).
 2. When Stall Prevention during acceleration is enabled (L3-01 ≠ 0), the accel time may take longer than the set value.
 3. When Stall Prevention during deceleration is enabled (L3-04 ≠ 0), the decel time may take longer than the set value.
 4. When performing Rotational Auto-Tuning for OLV Control (T1-01 = 0) and Rotational Auto-Tuning for V/f Control (T1-04 = 3), the drive uses the maximum output frequency set in E1-04 to determine the base accel/decel rate, regardless of the C1-14 value.

◆ C2: S-Curve Characteristics

Use S-curve characteristics to smooth acceleration and deceleration and to minimize abrupt shock to the load. Set S-curve characteristic time during acceleration/deceleration at start and acceleration/deceleration at stop. If a STo fault (Step Out Detection) occurs when starting a PM motor, try increasing the value set to C2-01.

■ C2-01 to C2-04: S-Curve Characteristics

C2-01 through C2-04 set separate S-curves for each section of the acceleration or deceleration.

No.	Parameter Name	Setting Range	Default
C2-01	S-Curve Characteristic at Accel Start	0.00 to 10.00 s	Determined by A1-02
C2-02	S-Curve Characteristic at Accel End		0.20 s
C2-03	S-Curve Characteristic at Decel Start		0.20 s
C2-04	S-Curve Characteristic at Decel End		0.00 s

Figure 5.27 explains how S-curves are applied.

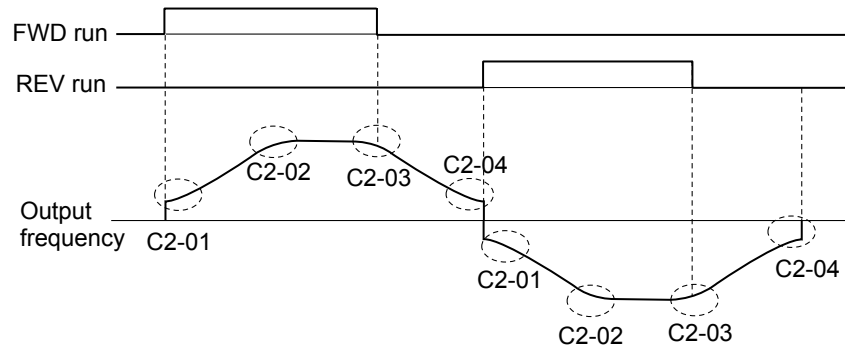

Figure 5.27 S-Curve Timing Diagram - FWD/REV Operation

Setting the S-curve will increase the acceleration and deceleration times.

Actual accel time = accel time setting + (C2-01 + C2-02)/2

Actual decel time = decel time setting + (C2-03 + C2-04)/2

◆ C3: Slip Compensation

The Slip Compensation function prevents motor speed loss due to an increase in load.

Note: Before making changes to the Slip Compensation parameters, make sure the motor parameters and V/f pattern are set properly or perform Auto-Tuning.

■ C3-01: Slip Compensation Gain

This parameter sets the gain for the motor slip compensation function. Although this parameter rarely needs to be changed, adjustments might be needed under the following situations:

- If the speed at constant frequency reference is lower than the frequency reference, increase C3-01.
- If the speed at constant frequency reference is higher than the frequency reference, decrease C3-01.

No.	Parameter Name	Setting Range	Default
C3-01	Slip Compensation Gain	0.0 to 2.5	Determined by A1-02

Note: Default setting is 0.0 in V/f Control (A1-02 = 0). Default setting is 1.0 in Open Loop Vector Control (A1-02 = 2). This parameter is disabled when using V/f Control with Simple PG Feedback (H6-01 = 3).

■ C3-02: Slip Compensation Primary Delay Time

Adjusts the filter on the output of the slip compensation function. Although this parameter rarely needs to be changed, adjustments might be needed under the following situations:

- Decrease the setting when the slip compensation response is too slow.
- Increase this setting when the speed is not stable.

No.	Parameter Name	Setting Range	Default
C3-02	Slip Compensation Primary Delay Time	0 to 10000 ms	Determined by A1-02

Note: When using V/f Control (A1-02 = 0), the default setting becomes 2000 ms. When using Open Loop Vector Control (A1-02 = 2), the default setting becomes 200 ms. This function is not available when using V/f Control with Simple PG Feedback.

■ C3-03: Slip Compensation Limit

Sets the upper limit for the slip compensation function as a percentage of the motor rated slip (E2-02).

No.	Parameter Name	Setting Range	Default
C3-03	Slip Compensation Limit	0 to 250%	200%

5.3 C: Tuning

The slip compensation limit is constant throughout the constant torque range. In the constant power range it is increased based on C3-03 and the output frequency as shown in the following diagram.

Note: This parameter is disabled when using V/f Control with Simple PG Feedback Control (H6-01 = 3).

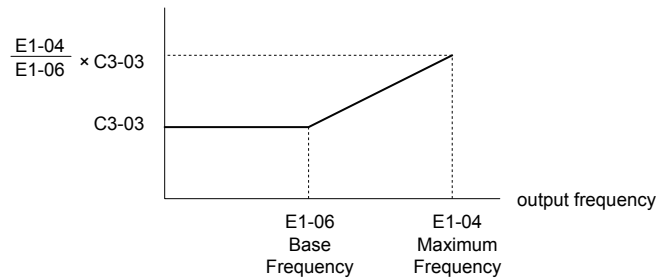

Figure 5.28 Slip Compensation Limit

■ C3-04: Slip Compensation Selection during Regeneration

When the slip compensation during regeneration function has been activated and regenerative load is applied, it might be necessary to use a braking option (braking resistor, braking resistor unit, or braking unit).

Even if enabled, this function does not operate when the output frequency is too low.

No.	Parameter Name	Setting Range	Default
C3-04	Slip Compensation Selection during Regeneration	0 or 1	0

Setting 0: Disabled

Slip compensation is not provided. Depending on the load and operation mode (motoring or regenerative) the actual motor speed will be lower or higher than the frequency reference.

Setting 1: Enabled

Slip compensation is enabled during regenerative operation. It will not be active at output frequencies below 6 Hz.

■ C3-05: Output Voltage Limit Operation Selection

Determines if the motor flux reference is automatically reduced when output voltage reaches the saturation range.

No.	Parameter Name	Setting Range	Default
C3-05	Output Voltage Limit Operation Selection	0 or 1	0

Setting 0: Disabled

Setting 1: Enabled

■ C3-18: Output Voltage Limit Level

Sets the maximum percentage of output voltage reduction when C3-05 is set to 1 (Enabled).

No.	Parameter Name	Setting Range	Default
C3-18	Output Voltage Limit Level	70.0 to 100.0%	90.0%

◆ C4: Torque Compensation

The torque compensation function compensates for insufficient torque production at start-up or when a load is applied.

Note: Before making changes to the torque compensation parameters make sure the motor parameters and V/f pattern are set properly or perform Auto-Tuning.

■ C4-01: Torque Compensation Gain

Sets the gain for the torque compensation function.

No.	Parameter Name	Setting Range	Default
C4-01	Torque Compensation Gain	0.00 to 2.50	Determined by A1-02

Torque Compensation in V/f Control:

The drive calculates the motor primary voltage loss using the output current and the terminal resistance value (E2-05) and then adjusts the output voltage to compensate insufficient torque at start or when load is applied. The effect of this voltage compensation can be increased or decreased using parameter C4-01.

Torque Compensation in Open Loop Vector Control:

The drive controls the motor excitation current and torque producing current separately. Torque compensation affects the torque producing current only. C4-01 works as a factor of the torque reference value that builds the torque producing current reference.

Adjustment

Although this parameter rarely needs to be adjusted, small changes in increments of 0.05 may help in the following situations:

- Increase this setting when using a long motor cable.
- Decrease this setting when motor oscillation occurs.

Adjust C4-01 so that the output current does not exceed the drive rated current.

■ C4-02: Torque Compensation Primary Delay Time 1

Sets the delay time used for applying torque compensation.

No.	Parameter Name	Setting Range	Default
C4-02	Torque Compensation Primary Delay Time 1	0 to 60000 ms	Determined by A1-02

Adjustment

Although C4-02 rarely needs to be changed, adjustments may help in the following situations:

- If the motor vibrates, increase C4-02.
- If the motor responds too slowly to changes in the load, decrease C4-02.

■ C4-03: Torque Compensation at Forward Start (OLV only)

Sets the amount of torque at start in the forward direction in order to improve motor performance during start with heavy load. Compensation is applied using the time constant set in parameter C4-05. A setting of 0.0% disables this feature.

No.	Parameter Name	Setting Range	Default
C4-03	Torque Compensation at Forward Start	0.0 to 200.0%	0.0%

■ C4-04: Torque Compensation at Reverse Start (OLV only)

Sets the amount of torque reference at start in the reverse direction in order to improve motor performance during start with heavy load. Compensation is applied using the time constant set in parameter C4-05. A setting of 0.0% disables this feature.

No.	Parameter Name	Setting Range	Default
C4-04	Torque Compensation at Reverse Start	-200.0 to 0.0%	0.0%

■ C4-05: Torque Compensation at Start Time Constant (OLV only)

This parameter is the time constant for applying the torque compensation at start set in parameters C4-03 and C4-04.

No.	Parameter Name	Setting Range	Default
C4-05	Torque Compensation Time Constant	0 to 200 ms	10 ms

■ C4-06: Torque Compensation Primary Delay Time 2 (OLV only)

This time constant is used during Speed Search or during regenerative operation when the actual motor slip is higher than 50% of the rated slip. Adjust the value if an overvoltage fault occurs with sudden changes in the load or at the end of acceleration with high inertia load.

No.	Parameter Name	Setting Range	Default
C4-06	Torque Compensation Primary Delay Time 2	0 to 10000 ms	150 ms

- Note:**
1. If C4-06 is set to a relatively large value, be sure to also increase the setting in n2-03 (AFR Time Constant 2) proportionally.
 2. C4-06 will not be active if L3-04 is 0, 3 or 4, the output frequency is below 5 Hz, or Speed Search after momentary power loss is active.

◆ **C5: Automatic Speed Regulator (ASR)**

The ASR is a PI controller that adjusts the output frequency in order to compensate the motor slip when load is applied. It is active only when V/f Control is used in combination with a speed feedback signal connected to the drive pulse input RP (V/f Control with Simple Speed Feedback).

The pulse input provides one track only and cannot detect the direction of motor rotation. A separate motor speed direction signal must therefore be input to the ASR by:

1. Using a Digital Input

This method is automatically enabled when a digital input is programmed for “Forward/Reverse direction” (H1-□□= 7E). If the input is closed, the drive assumes reverse rotation. If open, then the drive assumes that the motor is rotating forwards.

When a 2 track encoder is used, an external unit that converts the 2 tracks into 1 track and a digital direction signal can be used.

2. Using the Frequency Reference Direction

When no digital input is set for “Forward/Reverse direction” (H1-□□≠ 7E), ASR uses the direction of the frequency reference.

Figure 5.29 illustrates the ASR function when using V/f with Simple Speed Feedback.

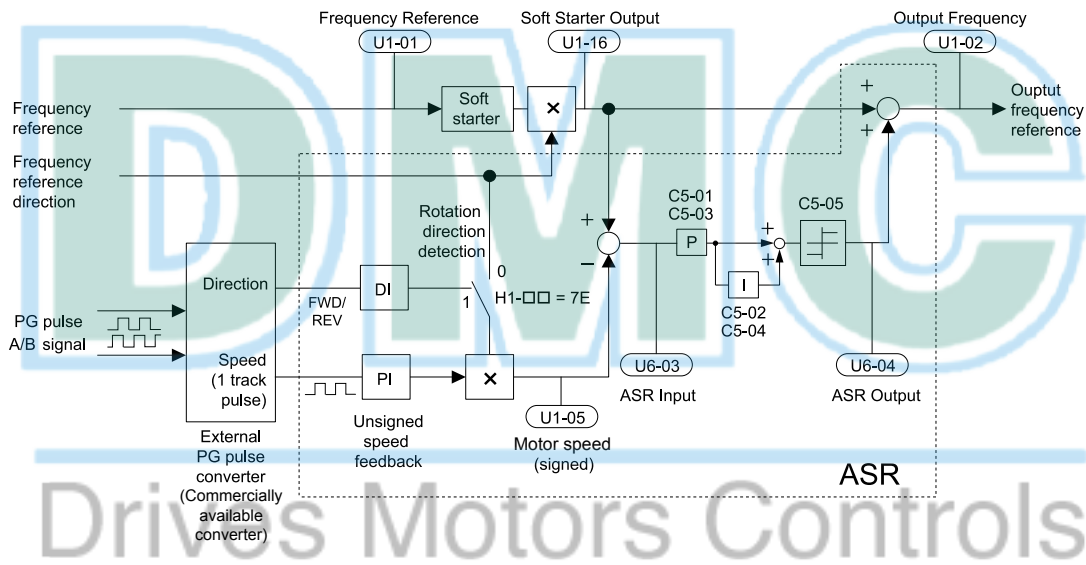

Figure 5.29 Speed Control with ASR in V/f with Simple Speed Feedback

To activate V/f Control with PG feedback:

1. Set the drive to V/f Control (A1-02 = 0).
2. Connect the motor speed pulse signal to the pulse input RP, set H6-01 = 3, and set the pulse signal frequency that is equal to the maximum speed to H6-02 (pulse input scaling). Make sure the pulse input bias (H6-04) is 0% and the gain (H6-03) is 100%.
3. Decide the signal used for detecting the direction. If a digital input is used set H1-□□ = 7E.
4. Use the ASR gain and integral time parameters described below for adjusting the ASR responsiveness.

- Note:**
1. C5 parameters will appear only when using V/f Control (A1-02 = 0) and when the pulse input RP function is set for PG feedback in V/f Control (H6-01 = 3).
 2. V/f Control with PG feedback can be used for motor 1 only.

ASR Tuning Parameters

ASR provides two sets of gain and integral time. Set 1 is active at the maximum output frequency, set 2 is active at the minimum output frequency. The settings are changed linearly depending on the output frequency as shown in Figure 5.30.

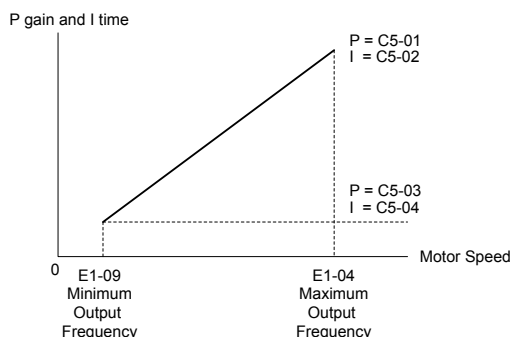

Figure 5.30 Adjusting ASR Proportional Gain and Integral Time

■ C5-01/02: ASR Proportional Gain/Integral Time 1

These parameters determine the responsiveness of ASR at maximum output frequency.

- Increase the gain and/or reduce the integral time if the response is slow at maximum output frequency.
- Reduce the gain and/or increase the integral time when vibrations occur at the maximum output frequency.
- When adjusting ASR always first adjust the P gain, then adjust the integral time.

No.	Parameter Name	Setting Range	Default
C5-01	ASR Proportional Gain 1	0.00 to 300.00	0.20
C5-02	ASR Integral Time 1	0.000 to 10.000 s	0.200 s

■ C5-03/04: ASR Proportional Gain/Integral Time 2

These parameters determine the responsiveness of ASR at the minimum output frequency. Use the same setting rules as described for C5-01/02

No.	Parameter Name	Setting Range	Default
C5-03	ASR Proportional Gain 2	0.00 to 300.00	0.02
C5-04	ASR Integral Time 2	0.000 to 10.000 s	0.050 s

■ C5-05: ASR Limit

Sets the ASR output limit as a percentage of the maximum output frequency (E1-04). If the motor slip is high, the setting might need to be increased to provide proper slip compensation. Use the ASR output monitor U6-04 to determine if ASR is working at the limit and make settings if necessary. If ASR is operating at the ASR limit, check the pulse signal and the pulse input settings prior to changes in C5-05.

No.	Parameter Name	Setting Range	Default
C5-05	ASR Limit	0.0 to 20.0%	5.0%

◆ C6: Carrier Frequency

■ C6-01: Drive Duty Selection

The drive has two different duty modes from which to select based on the load characteristics. The drive rated current, overload capacity, and carrier frequency will change depending upon the duty mode selection. Use parameter C6-01 to select Heavy Duty (HD) or Normal Duty (ND) for the application. The default setting is ND. *Refer to Heavy Duty and Normal Duty Ratings on page 342* for details about the rated current.

No.	Parameter Name	Setting Range	Default
C6-01	Drive Duty Selection	0 or 1	1 </>

<1> Model BA0018 does not have a Normal Duty mode. The default setting is 0.

5.3 C: Tuning

Table 5.11 Differences between Heavy and Normal Duty

Mode	Heavy Duty Rating (HD)	Normal Duty Rating (ND)
C6-01	0	1
Characteristics		
Application	Use Heavy Duty Rating for applications requiring a high overload tolerance with constant load torque. Such applications include extruders and conveyors.	Use Normal Duty Rating for applications in which the torque requirements drop along with the speed. Examples include fans or pumps where a high overload tolerance is not required.
Over load capability (oL2)	150% of drive rated Heavy Duty current for 60 s	120% of drive rated Normal Duty current for 60 s
L3-02 Stall Prevention during Acceleration	150%	120%
L3-06 Stall Prevention during Run	150%	120%
Default Carrier Frequency	8/10 kHz	2 kHz Swing PWM

Note: By changing the Drive Duty, the drive maximum applicable motor power changes and the E2-□□ and E4-□□ parameters are automatically set to appropriate values.

■ C6-02: Carrier Frequency Selection

Parameter C6-02 sets the switching frequency of the drive's output transistors. It can be changed in order to reduce audible noise and also reduce leakage current.

Note: The drive rated current is reduced when the carrier frequency is set higher than the default value. *Refer to Rated Current Depending on Carrier Frequency on page 158.*

No.	Parameter Name	Setting Range	Default
C6-02	Carrier Frequency Selection	<1>	Determined by A1-02 and o2-04. Reset when C6-01 is changed.

<1> Setting range is determined by the drive software version.

PRG: 1020 and later: 1 to B; F

PRG: 1018 and earlier: 1 to A; F

Settings:

C6-02	Carrier Frequency
1	2.0 kHz
2	5.0 kHz
3	8.0 kHz
4	10.0 kHz
5	12.5 kHz
6	15.0 kHz
7	Swing PWM 1

C6-02	Carrier Frequency
8	Swing PWM 2
9	Swing PWM 3
A	Swing PWM 4
B <1>	Leakage Current Rejection PWM
F	User-defined (C6-03 to C6-05)

<1> Available in drive software versions PRG: 1020 and later. Setting B uses a PWM pattern that reduces the amount of leakage current detected over long wiring distances. This can help reduce alarm detection and problems with the current monitor that result from leakage current over long wiring distances. This is the same as setting the carrier frequency to 2 kHz.

Note: Swing PWM uses 2.0 kHz carrier frequency as a base. Applying special PWM patterns minimizes the audible noise of the motor.

Guidelines for Carrier Frequency Parameter Setup

Symptom	Remedy
Speed and torque are unstable at low speeds.	Lower the carrier frequency.
Noise from the drive is affecting peripheral devices.	
Excessive leakage current from the drive.	

Symptom	Remedy
Wiring between the drive and motor is too long. <1>	<ul style="list-style-type: none"> Lower the carrier frequency Set C6-02 to B if an alarm is detected or if leakage current causes a problem with the current monitor.
Audible motor noise is too loud.	Increase the carrier frequency or use Swing PWM. <2>

<1> The carrier frequency may need to be lowered if the motor cable is too long. Refer to the table below.

<2> In Normal Duty default setting is 7 (Swing PWM), equivalent to setting 2 kHz. Increasing the carrier frequency is fine when using the drive is set for Normal Duty, but remember that the drive rated current falls when the carrier frequency is increased.

Wiring Distance	Up to 50 m	Up to 100 m	Greater than 100 m
C6-02 (Carrier Frequency Selection)	0 to 6 (15 kHz)	0 to 4 (10 kHz)	1, 7 to A (2 kHz)

Note: If the motor cable is fairly long when using PM Open Loop Vector, set the carrier frequency to 2 kHz (C6-02 = 1). Switch to V/f Control if the cable is longer than 100 m.

■ C6-03/C6-04/C6-05: Carrier Frequency Upper Limit/Lower Limit/Proportional Gain

Use these parameters to set a user defined or a variable carrier frequency. To set the upper and lower limits, first set C6-02 to “F”.

No.	Parameter Name	Setting Range	Default
C6-03	Carrier Frequency Upper Limit	1.0 to 15.0 kHz	<1>
C6-04	Carrier Frequency Lower Limit (V/f only)	1.0 to 15.0 kHz	
C6-05	Carrier Frequency Proportional Gain (V/f only)	0 to 99	

<1> The default value is determined by the control method (A1-02) as well as the drive capacity (o2-04), and is reinitialized when the value set to C6-01 is changed.

Setting a Fixed User Defined Carrier Frequency

A carrier frequency between the fixed selectable values can be entered in parameter C6-03 when C6-02 is set to “F”. In V/f Control, parameter C6-04 must also be adjusted to the same value as C6-03.

Setting a Variable Carrier Frequency (V/f Control only)

In V/f Control, the carrier frequency can be set up to change linearly with the output frequency. In this case the upper and lower limits for the carrier frequency and the carrier frequency proportional gain (C6-03, C6-04, C6-05) have to be set as shown in [Figure 5.31](#).

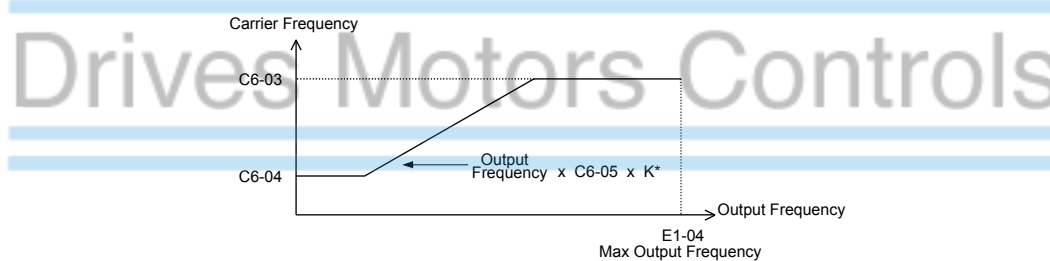

Figure 5.31 Carrier Frequency Changes Relative to Output Frequency

K is a coefficient determined by the value of C6-03:

- 10.0 kHz > C6-03 ≥ to 5.0 kHz: K = 2
- 5.0 kHz > C6-03: K = 1
- C6-03 ≥ 10.0 kHz: K = 3

Note:

1. A carrier frequency error (oPE11) will occur when the carrier frequency proportional gain is greater than 6 while C6-03 is less than C6-04.
2. When C6-05 is set lower than 7, C6-04 is disabled and the carrier frequency will be fixed to the value set in C6-03.

5.3 C: Tuning

■ Rated Current Depending on Carrier Frequency

The tables below show the drive output current depending on the carrier frequency settings. The 2 kHz value is equal to the Normal Duty rated current, the 8/10 kHz value is equal to the Heavy Duty rated current. The carrier frequency determines the output current linearly. Use the data below to calculate output current values for carrier frequencies not listed in the tables.

Note: In Heavy Duty mode the maximum rated output current is equal to the 8/10 kHz value, even if the carrier frequency is reduced.

Table 5.12 200 V Class Drives with 10 kHz Heavy Duty Default Carrier Frequency

Model	Rated Current (A)		
	2 kHz	10 kHz	15 kHz
BA0001 2A0001	1.2	0.8	0.6
BA0002 2A0002	1.9	1.6	1.3
BA0003 2A0004	3.5	3.0	2.4
BA0006 2A0006	6.0	5.0	4.0

Table 5.13 200 V Class Drives with 8 kHz Heavy Duty Default Carrier Frequency

Model	Rated Current (A)		
	2 kHz	8 kHz	15 kHz
BA0010 2A0010	9.6	8.0	6.4
BA0012 2A0012	12.0	11.0	8.8
BA0018	17.5	17.5	14.0
2A0020	19.6	17.5	14.0
2A0030	30.0	25.0	20.0
2A0040	40.0	33.0	26.4
2A0056	56.0	47.0	37.6
2A0069	69.0	60.0	48.0

Table 5.14 400 V Class Drives with 8 kHz Heavy Duty Default Carrier Frequency

Model	Rated Current (A)		
	2 kHz	8 kHz	15 kHz
4A0001	1.2	1.2	0.7
4A0002	2.1	1.8	1.1
4A0004	4.1	3.4	2.0
4A0005	5.4	4.8	2.9
4A0007	6.9	5.5	3.3
4A0009	8.8	7.2	4.3
4A0011	11.1	9.2	5.5
4A0018	17.5	14.8	8.9
4A0023	23.0	18.0	10.8
4A0031	31.0	24.0	14.4
4A0038	38.0	31.0	18.6

5.4 d: Reference Settings

The drive offers various ways of entering the frequency reference. The figure below gives an overview of the reference input, selections, and priorities.

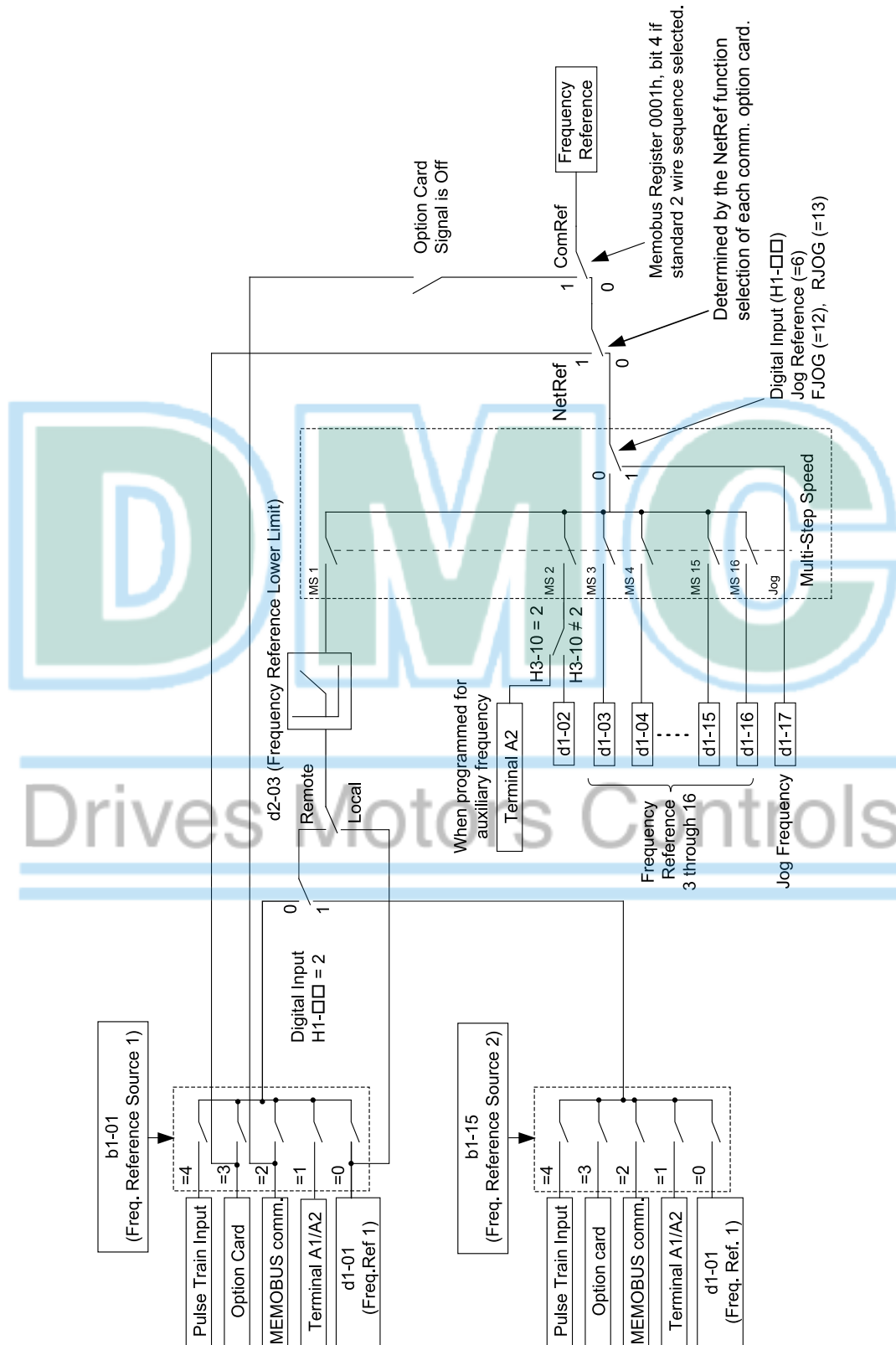

Figure 5.32 Frequency Reference Setting Hierarchy

◆ d1: Frequency Reference

■ d1-01 to d1-17: Frequency Reference 1 to 16 and Jog Reference

Up to 17 preset references (including Jog reference) can be programmed in the drive. The references can be switched during Run by digital inputs. The acceleration/deceleration to the new reference is performed using the active acceleration/deceleration time.

The Jog frequency must be selected by a separate digital input and has priority over the references 1 to 16.

The multi-speed references 1 and 2 can be provided by analog inputs.

No.	Parameter Name	Setting Range	Default
d1-01 to d1-16	Frequency Reference 1 to 16	0.00 to 400.00 Hz <1>	0.00 Hz
d1-17	Jog Frequency Reference	0.00 to 400.00 Hz <1>	6.00 Hz

<1> The upper limit is determined by the maximum output frequency (E1-04) and upper limit for the frequency reference (d2-01).

Multi-Step Speed Selection

Depending on how many speeds are used, some digital inputs have to be programmed for Multi-Step Speed Reference 1, 2, 3 and 4 (H1-□□ = 3, 4, 5, 32). For the Jog reference a digital input must be set to H1-□□ = 6.

Notes on using analog inputs as multi-speed 1 and 2:

- If the frequency reference source is assigned to analog input A1 (b1-01 = 1), then this input will be used for Frequency Reference 1 instead of d1-01. If the reference source is assigned to the digital operator (b1-01 = 0), then d1-01 will be used as Frequency Reference 1.
- When the analog input A2 function is set to “Auxiliary Frequency” (H3-10 = 2), then the value input to terminal A2 will be used as the Frequency Reference 2 instead of the value set to parameter d1-02. When H3-10 does not equal 2, then d1-02 becomes the reference for Frequency Reference 2.

The different speed references can be selected as shown in [Table 5.15](#). [Figure 5.33](#) illustrates the multi-step speed selection.

Table 5.15 Multi-Step Speed Reference and Terminal Switch Combinations

Reference	Multi-Step Speed H1-□□=3	Multi-Step Speed 2 H1-□□=4	Multi-Step Speed 3 H1-□□=5	Multi-Step Speed 4 H1-□□=32	Jog Reference H1-□□=6
Frequency Reference 1 (d1-01/A1)	OFF	OFF	OFF	OFF	OFF
Frequency Reference 2 (d1-02/A2)	ON	OFF	OFF	OFF	OFF
Frequency Reference 3 (d1-03)	OFF	ON	OFF	OFF	OFF
Frequency Reference 4 (d1-04)	ON	ON	OFF	OFF	OFF
Frequency Reference 5 (d1-05)	OFF	OFF	ON	OFF	OFF
Frequency Reference 6 (d1-06)	ON	OFF	ON	OFF	OFF
Frequency Reference 7 (d1-07)	OFF	ON	ON	OFF	OFF
Frequency Reference 8 (d1-08)	ON	ON	ON	OFF	OFF
Frequency Reference 9 (d1-09)	OFF	OFF	OFF	ON	OFF
Frequency Reference 10 (d1-10)	ON	OFF	OFF	ON	OFF
Frequency Reference 11 (d1-11)	OFF	ON	OFF	ON	OFF
Frequency Reference 12 (d1-12)	ON	ON	OFF	ON	OFF
Frequency Reference 13 (d1-13)	OFF	OFF	ON	ON	OFF
Frequency Reference 14 (d1-14)	ON	OFF	ON	ON	OFF
Frequency Reference 15 (d1-15)	OFF	ON	ON	ON	OFF
Frequency Reference 16 (d1-16)	ON	ON	ON	ON	OFF
Jog Frequency Reference (d1-17) <1>	–	–	–	–	ON

<1> The Jog frequency overrides the frequency reference being used.

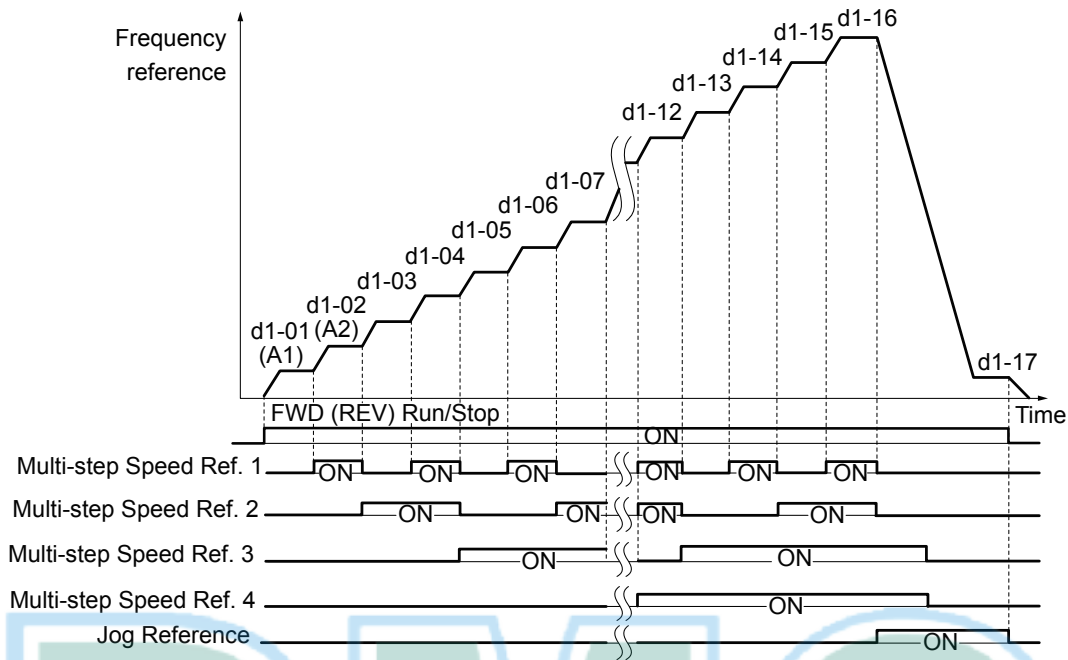

Figure 5.33 Preset Reference Timing Diagram

◆ **d2: Frequency Upper/Lower Limits**

By entering upper or lower frequency limits, the drive programmer can prevent operation of the drive above or below levels that may cause resonance and or equipment damage.

■ **d2-01: Frequency Reference Upper Limit**

Sets the maximum frequency reference as a percentage of the maximum output frequency. This limit applies to all frequency references.

Even if the frequency reference is set to a higher value, the drive internal frequency reference will not exceed this value.

No.	Parameter Name	Setting Range	Default
d2-01	Frequency Reference Upper Limit	0.0 to 110.0%	100.0%

■ **d2-02: Frequency Reference Lower Limit**

Sets the minimum frequency reference as a percentage of the maximum output frequency. This limit applies to all frequency references.

If a lower reference than this value is input, the drive will run at the d2-02 level. If the drive is started with a lower reference than d2-02, it will accelerate up to d2-02.

No.	Parameter Name	Setting Range	Default
d2-02	Frequency Reference Lower Limit	0.0 to 110.0%	0.0%

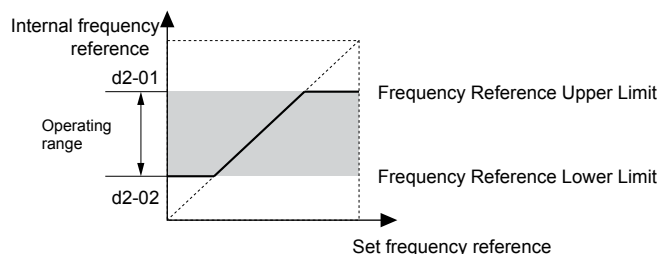

Figure 5.34 Frequency Reference: Upper and Lower Limits

5.4 d: Reference Settings

■ d2-03: Master Speed Reference Lower Limit

Unlike frequency reference lower limit (d2-02) which will affect the frequency reference no matter where it is sourced from (i.e., analog input, preset speed, Jog speed, etc.), the master speed lower limit (d2-03) sets a lower limit that will only affect the analog input (terminals A1 and A2) that is the active master speed frequency.

Set as a percentage of the maximum output frequency.

Note: The lower limits for the Jog frequency, multi-step speed settings, and 2-step speed settings do not change. When lower limits are set to both the frequency reference (d2-02) and the main frequency reference (d2-03), the drive uses the greater of those two values as the lower limit.

No.	Parameter Name	Setting Range	Default
d2-03	Master Speed Reference Lower Limit	0.0 to 110.0%	0.0%

◆ d3: Jump Frequency

■ d3-01 to d3-04: Jump Frequencies 1, 2, 3, and Jump Frequency Width

In order to avoid continuous operation at a speed that causes resonance in driven machinery, the drive can be programmed with three separate Jump frequencies that will not allow continued operation within specific frequency ranges. If the speed reference falls within a Jump frequency dead band, the drive will clamp the frequency reference just below the dead band and only accelerate past it when the frequency reference rises above the upper end of the dead band.

Setting parameters d3-01 through d3-03 to 0.0 Hz disables the Jump frequency function.

No.	Parameter Name	Setting Range	Default
d3-01	Jump Frequency 1	0.0 to 400.0 Hz	0.0 Hz
d3-02	Jump Frequency 2	0.0 to 400.0 Hz	0.0 Hz
d3-03	Jump Frequency 3	0.0 to 400.0 Hz	0.0 Hz
d3-04	Jump Frequency Width	0.0 to 20.0 Hz	1.0 Hz

Figure 5.35 shows the relationship between the Jump frequency and the output frequency.

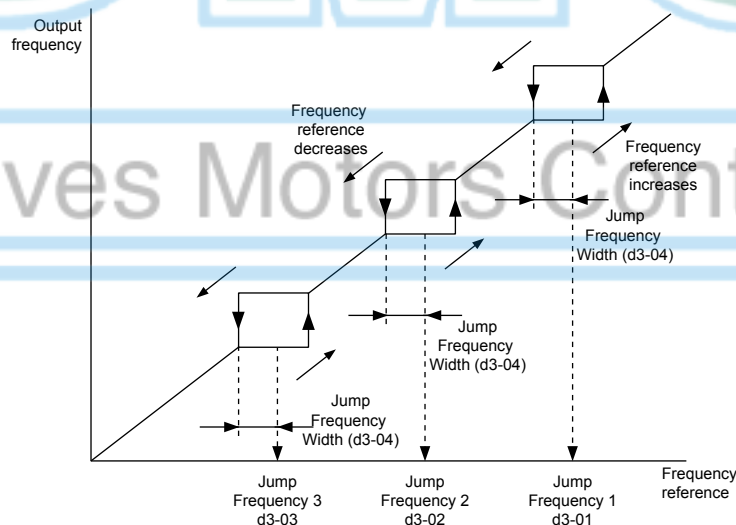

Figure 5.35 Jump Frequency Operation

- Note:**
1. The drive will use the active accel/decel time to pass through the specified dead band range but will not allow continuous operation in that range.
 2. When using more than one Jump frequency, make sure that $d3-01 \geq d3-02 \geq d3-03$.

◆ d4: Frequency Hold and Up/Down 2 Function

■ d4-01: Frequency Reference Hold Function Selection

This parameter is effective when either of the digital input functions listed below is used.

- Accel/decel ramp hold function (H1-□□= A)

- Up/Down function (H1-□□ = 10 and 11, sets the frequency reference by digital inputs)
- Up/Down 2 function (H1-□□ = 75/76, adds a bias to the frequency reference using digital inputs)

Parameter d4-01 determines whether the frequency reference or the frequency bias (Up/Down 2) value is saved when the Run command is cleared or the power supply is shut down.

No.	Parameter Name	Setting Range	Default
d4-01	Frequency Reference Hold Function Selection	0 or 1	0

The operation depends on with what function parameter d4-01 is used.

Setting 0: Disabled

- Acceleration Hold

The hold value will be reset to 0 Hz when the Run command is canceled or the drive power is switched off. The active frequency reference will be the value the drive uses when it restarts.

- Up/Down

The frequency reference value will be reset to 0 Hz when the Run command is canceled or the drive power is switched off. The drive will start from 0 Hz when restarted.

- Up/Down 2

The frequency bias is not saved when the Run command is switched off or 5 s after the Up/Down 2 command has been released. The Up/Down 2 function will start with a bias of 0% when the drive is restarted.

Setting 1: Enabled

- Acceleration Hold

The last hold value will be saved when the Run command or the drive power is switched off. The drive will use the value that was saved as the frequency reference when it restarts. The accel/decel hold input must be enabled the entire time or else the hold value will be cleared.

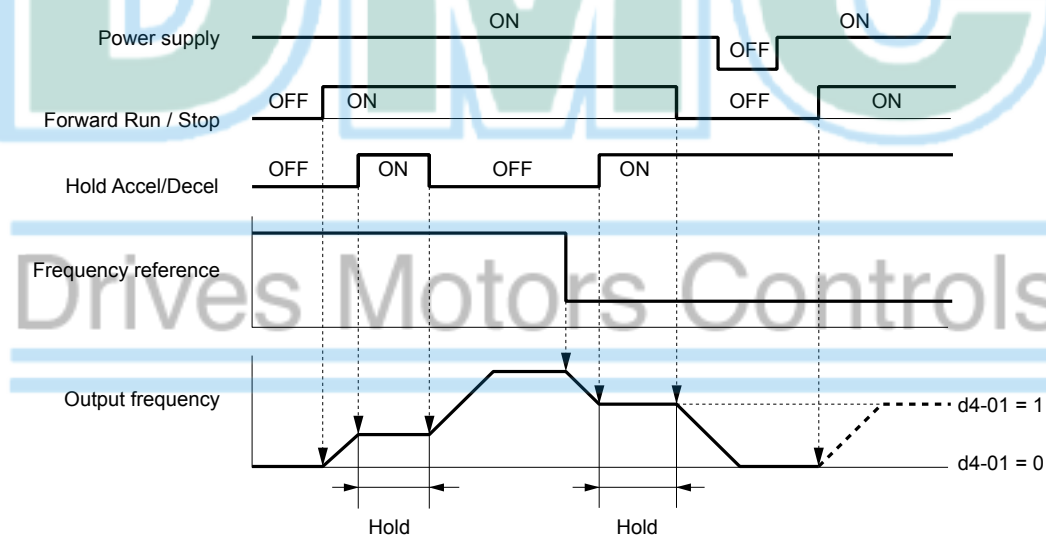

Figure 5.36 Frequency Reference Hold with Accel/Decel Hold Function

- Up/Down

The frequency reference value will be saved when the Run command or the drive power is switched off. The drive will use the frequency reference that was saved when it restarts.

- Up/Down 2 with Frequency Reference from Digital Operator

When the digital operator is selected as the frequency reference source, the bias will be added to the frequency reference that was selected 5 s after the Up/Down 2 command has been released, and then reset to 0 afterwards. The new frequency reference value is then saved. When the Run command or the power supply is switched off, the drive will use the value that was when it restarts.

- Releasing the acceleration hold input.
- Setting an Up or Down command while no Run command is active.

■ d4-03: Frequency Reference Bias Step (Up/Down 2)

Sets the bias that is added to or subtracted from the frequency reference by the Up/Down 2 function.

No.	Parameter Name	Setting Range	Default
d4-03	Frequency Reference Bias Step	0.00 to 99.99 Hz	0.00 Hz

The operation depends on the set value:

Setting d4-03 = 0.0 Hz

While the Up 2 or Down 2 command is enabled, the bias value is increased or decreased using the accel/decel time determined by parameter d4-04.

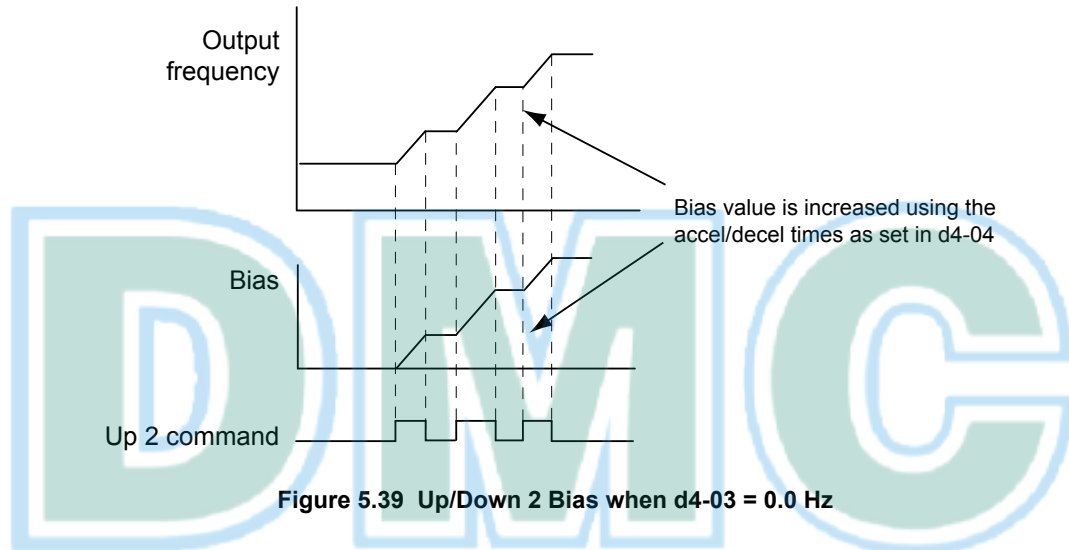

Figure 5.39 Up/Down 2 Bias when d4-03 = 0.0 Hz

Setting d4-03 > 0.0 Hz

When an Up 2 or Down 2 command is enabled, the bias is increased or decreased in steps for the value set in d4-03. The frequency reference changes with the accel/decel times determined by parameter d4-04.

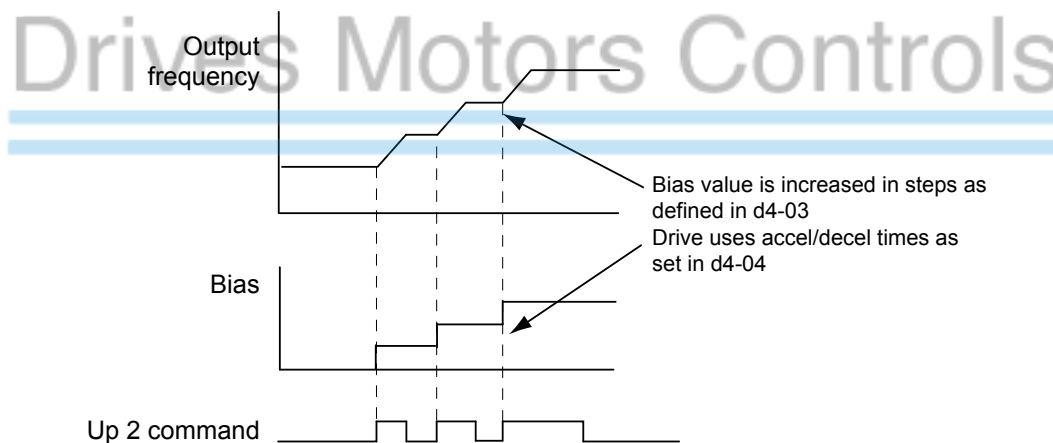

Figure 5.40 Up/Down 2 Bias when d4-03 > 0.0 Hz

■ d4-04: Frequency Reference Bias Accel/Decel (Up/Down 2)

Parameter d4-04 determines the accel/decel times that are used for increasing/decreasing the frequency reference or bias when the Up/Down 2 function is used.

No.	Parameter Name	Setting Range	Default
d4-04	Frequency Reference Bias Accel/Decel	0 or 1	0

5.4 d: Reference Settings

Setting 0: Current Accel/Decel Time

The drive uses the currently active accel/decel time.

Setting 1: Accel/Decel Time 4

The drive uses accel/decel time 4 set to parameters C1-07 and C1-08.

■ d4-05: Frequency Reference Bias Operation Mode Selection (Up/Down 2)

Determines if the bias value is held or not when the Up/Down 2 inputs are both released or both enabled. The parameter is effective only when parameter d4-03 is set to 0.00.

No.	Parameter Name	Setting Range	Default
d4-05	Frequency Reference Bias Operation Mode Selection	0 or 1	0

Setting 0: Hold Bias Value

The bias value will be held if no input Up 2 or Down 2 is active.

Setting 1: Reset Bias Value

The bias is reset to 0% when both inputs Up 2 and Down 2 are either on or off. The drive will use the accel/decel time as selected in d4-04 to accelerate or decelerate to the frequency reference value.

■ d4-06: Frequency Reference Bias (Up/Down 2)

This parameter is used to save the frequency reference bias value set by the Up/Down 2 function. It is set as a percentage of the maximum output frequency. The function of d4-06 depends on how the Up/Down 2 function is configured.

- This parameter is not normally used when the frequency reference is set by the digital operator. The user can set d4-06 to a certain value that will be applied when the operation is started, but it will be reset when the frequency reference changes (including multi-step references) or will be disabled when d4-01 = 0 and the Run command is removed.
- When d4-01 = 0 and the frequency reference is set by an analog or pulse input, the value set in d4-06 is generally added to or subtracted from the frequency reference.
- When d4-01 = 1 and the frequency reference is set by a different source than the digital operator, the bias value adjusted with the Up/Down 2 inputs is stored in d4-06 when 5 s have passed after the Up 2 or Down 2 command release.

No.	Parameter Name	Setting Range	Default
d4-06	Frequency Reference Bias	-99.9 to 100.0%	0.0%

Conditions that Generally Reset or Disable Parameter d4-06

- When the Up/Down 2 function has not been assigned to the multi-function terminals
- When the frequency reference source has been changed (including LOCAL/REMOTE or external reference 1/external reference 2 switch over by digital inputs)
- If d4-03 = 0 Hz, d4-05 = 1 and the Up/Down 2 commands are both open or both closed
- Any changes to the maximum frequency set to E1-04

■ d4-07: Analog Frequency Reference Fluctuation Limit (Up/Down 2)

This parameter is for handling changes in the frequency reference while the terminal set for Up 2 or Down 2 is enabled. If the frequency reference changes for more than the level set to d4-07, then the bias value will be held, and the drive will accelerate or decelerate following the frequency reference. When the frequency reference is reached, the bias hold is released and the bias follows the Up/Down 2 input commands.

Parameter d4-07 is applicable only if the frequency reference is set by an analog or pulse input.

No.	Parameter Name	Setting Range	Default
d4-07	Analog Frequency Reference Fluctuation Limit	0.1 to 100.0%	1.0%

■ d4-08: Frequency Reference Bias Upper Limit (Up/Down 2)

Parameter d4-08 sets the upper limit of the Up/Down 2 bias (monitor U6-20) and the value that can be saved in parameter d4-06. Set this parameter to an appropriate value before using the Up/Down 2 function.

Note: When the frequency reference is set by the digital operator (b1-01 = 0) and d4-01 = 1, the bias value will be added to the frequency reference if no Up/Down 2 command is received for 5 s, and will be reset to 0 afterwards. From that point the bias can be increased up to the limit set in d4-08 again.

No.	Parameter Name	Setting Range	Default
d4-08	Frequency Reference Bias Upper Limit	0.0 to 100.0%	</>

<1> Default setting is determined by the software version.

PRG: 1016 and later: 100.00%

PRG: 1015 and earlier: 0.00%

■ d4-09: Frequency Reference Bias Lower Limit (Up/Down 2)

Parameter d4-08 sets the lower limit of the Up/Down 2 bias (monitor U6-20) and the value that can be saved in parameter d4-06. Set this parameter to an appropriate value before using the Up/Down 2 function.

Note: When the frequency reference is set by the digital operator (b1-01 = 0) and d4-01 = 1, the bias value will be added to the frequency reference if no Up/Down 2 command is received for 5 s, and will be reset to 0 afterwards. If the bias is increased using the Up 2 command, once it is added to the frequency reference the speed cannot be reduced with a Down 2 command if the limit set in d4-09 is 0. In this case make sure to set a negative lower limit in d4-09 to allow speed reduction.

No.	Parameter Name	Setting Range	Default
d4-09	Frequency Reference Bias Lower Limit	-99.9 to 0.0%	0.0%

■ d4-10: Up/Down Frequency Reference Limit Selection

Selects how the lower frequency limit is set when the Up/Down function is used. [Refer to Setting 10/11: Up/Down Command on page 187](#) for details on the Up/Down function in combination with frequency reference limits.

Setting 0: Lower Limit is Determined by d2-02 or Analog Input

The lower frequency reference limit is determined by the higher value of both, parameter d2-02 or an analog input that is programmed for “Frequency Bias” (H3-02/10 = 0).

Note: If the external reference change over function (H1-□□ = 2) used to switch between Up/Down function and analog input as reference source, the analog value would become the lower reference limit when the Up/Down reference is active. Change d4-10 to 1 to make the Up/Down function independent of the analog input value.

Setting 1: Lower Limit is Determined by Parameter d2-02

Only parameter d2-02 sets the lower frequency reference limit.

◆ d7: Offset Frequencies

■ d7-01 to d7-03: Offset Frequency 1 to 3

Three different offset values can be added to the frequency reference. They can be selected using digital inputs programmed for Offset frequency 1, 2 and 3 (H1-□□ = 44, 45, 46). The selected offset values are added if two or all three inputs are closed at the same time.

Note: This function can be used to replace the “Trim Control” function (H1-□□ = 1C/1D) of earlier Yaskawa drives.

No.	Parameter Name	Setting Range	Default
d7-01	Offset Frequency 1	-100.0 to 100.0%	0%
d7-02	Offset Frequency 2	-100.0 to 100.0%	0%
d7-03	Offset Frequency 3	-100.0 to 100.0%	0%

Figure 5.41 illustrates the Offset Frequency Function.

5.4 d: Reference Settings

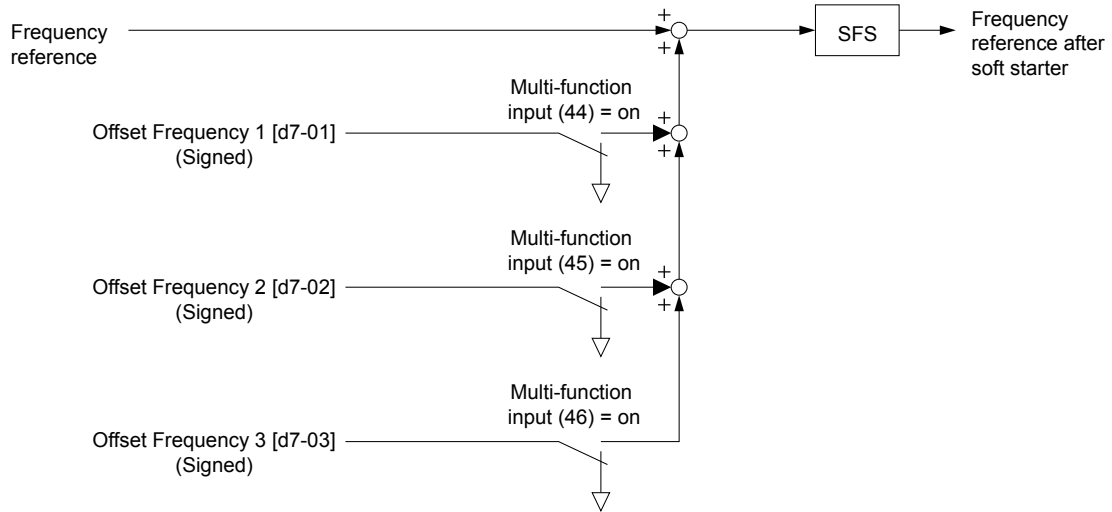

Figure 5.41 Offset Frequency Operation

DMC

Drives Motors Controls

5.5 E: Motor Parameters

E parameters cover V/f pattern and motor data settings.

◆ E1: V/f Characteristics

■ E1-01: Input Voltage Setting

Set the input voltage parameter to the nominal voltage of the AC power supply. This parameter adjusts the levels of some protective features of the drive (overvoltage, Stall Prevention, etc.).

NOTICE: Set parameter E1-01 to match the input voltage of the drive. Drive input voltage (not motor voltage) must be set in E1-01 for the protective features of the drive to function properly. Failure to comply could result in improper drive operation.

No.	Parameter Name	Setting Range	Default
E1-01 </>	Input Voltage Setting	155 to 255 V	230 V

<1> The setting range and default value shown here are for 200 V class drives. Double this for 400 V class units.

E1-01 Related Values

The input voltage setting determines the over-/undervoltage detection level and the operation levels of the braking transistor as well as the KEB function and the overvoltage suppression function.

Voltage	Setting Value of E1-01	(Approximate Values)				
		ov Detection Level	BTR Operation Level	Uv Detection Level (L2-05)	Desired DC Bus Voltage during KEB (L2-11)	ov Suppression / Stall Prevention Level (L3-17)
200 V Class	all settings	410 V	394 V	190 V (single-phase = 160 V)	240 V	370 V
400 V Class	setting ≥ 400 V	820 V	788 V	380 V	480 V	740 V
	setting < 400 V	740 V	708 V	350 V	440 V	660 V

Note: The braking transistor operation levels are valid for the drive internal braking transistor. If an external CDBR braking chopper is used, refer to the instruction manual of that unit.

■ V/f Pattern Settings

The drive utilizes a set V/f pattern to determine the appropriate output voltage level for each relative to the frequency reference. There are 15 different preset V/f patterns to select from with varying voltage profiles, saturation levels (frequency at which maximum voltage is reached), and maximum frequencies. Additionally, one custom V/f pattern can be set up by programming parameters E1-04 through E1-10.

V/f Pattern Setup for V/f Control

- Set the input voltage for the drive. [Refer to E1-01: Input Voltage Setting on page 169.](#)
- Set the V/f pattern by:
 - choosing one of the 15 preset V/f patterns (E1-03 = 0 to E).
 - select the custom V/f pattern (E1-03 = F, default setting).
- When using one of the 15 presets, E1-04 through E1-13 are automatically set. Refer to the description below. For a custom V/f pattern, E1-04 through E1-13 must be adjusted manually. [Refer to V/f Pattern Settings E1-04 to E1-13 on page 172.](#)

Open Loop Vector Control Setup for IM and PM Motors

In OLV only the user defined V/f pattern can be used. [Refer to V/f Pattern Settings E1-04 to E1-13 on page 172.](#)

■ E1-03: V/f Pattern Selection

This parameter can only be changed when the drive is operating in V/f Control. It allows the user to select the V/f pattern from 15 predefined patterns or to create a custom V/f pattern.

No.	Parameter Name	Setting Range	Default
E1-03	V/f Pattern Selection	0 to F	F

5.5 E: Motor Parameters

Setting the V/f Pattern

Choose the V/f pattern that meets the application demands from the table below. Set the correct value to E1-03. The V/f parameters E1-04 to E1-13 can only be monitored, not changed.

- Note:**
1. Setting an improper V/f pattern may result in low motor torque or increased current due to overexcitation.
 2. Parameter E1-03 is not reset when the drive is initialized.

Table 5.16 Predefined V/f Patterns

Setting	Specification	Characteristic	Application
0	50 Hz	Constant torque	For general purpose applications. Torque remains constant regardless of changes to speed.
1	60 Hz (default setting)		
2	60 Hz (with 50 Hz base)		
3	72 Hz (with 60 Hz base)		
4	50 Hz, Heavy Duty 2	Derated torque	For fans, pumps, and other applications that require torque derating relative to the load.
5	50 Hz, Heavy Duty 1		
6	60 Hz, Heavy Duty 1		
7	60 Hz, Heavy Duty 2		
8	50 Hz, mid starting torque	High starting torque	Select high starting torque when: <ul style="list-style-type: none"> • Wiring between the drive and motor exceeds 150 m • A large amount of starting torque is required • An AC reactor is installed
9	50 Hz, high starting torque		
A	60 Hz, mid starting torque		
B	60 Hz, high starting torque	Constant output	When operating at greater than 60 Hz the output voltage will be constant.
C	90 Hz (with 60 Hz base)		
D	120 Hz (with 60 Hz base)		
E	180 Hz (with 60 Hz base)		

The following tables show details on predefined V/f patterns.

The following graphs are for 200 V class drives; double the values for 400 V class drives.

Predefined V/f Patterns for 0.1 to 3.7 kW Drives

Table 5.17 Constant Torque Characteristics, Settings 0 to 3

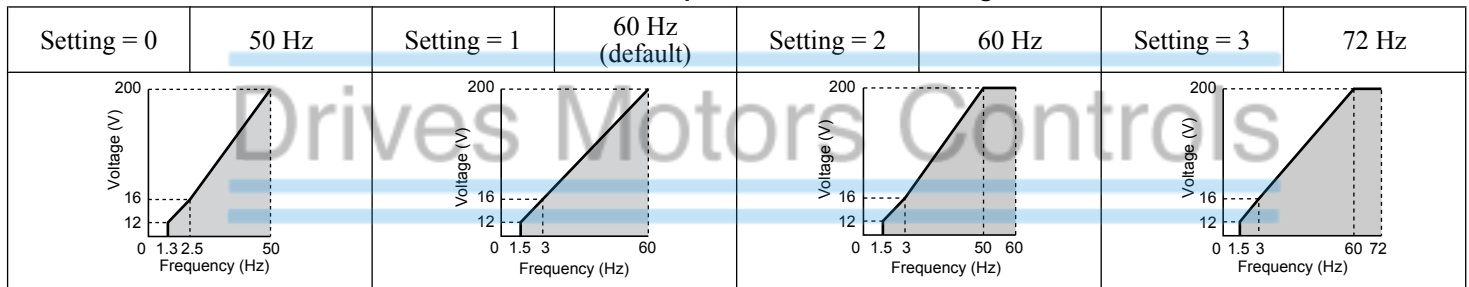

Table 5.18 Derated Torque Characteristics, Settings 4 to 7

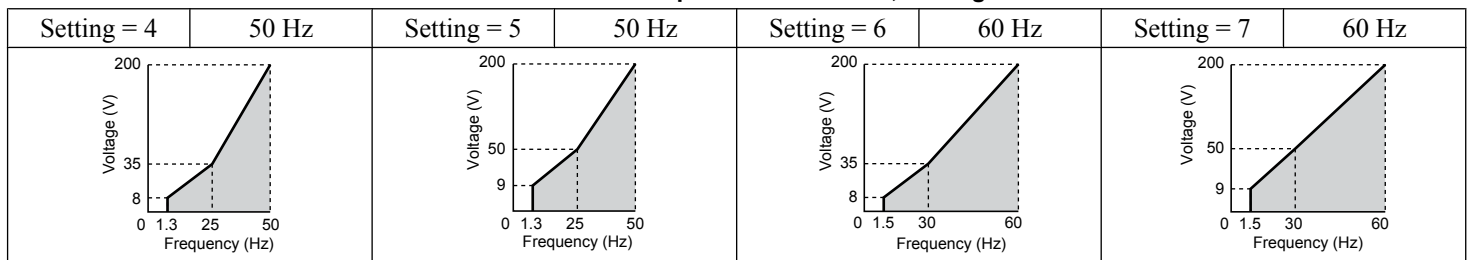

Table 5.19 High Starting Torque, Settings 8 to B

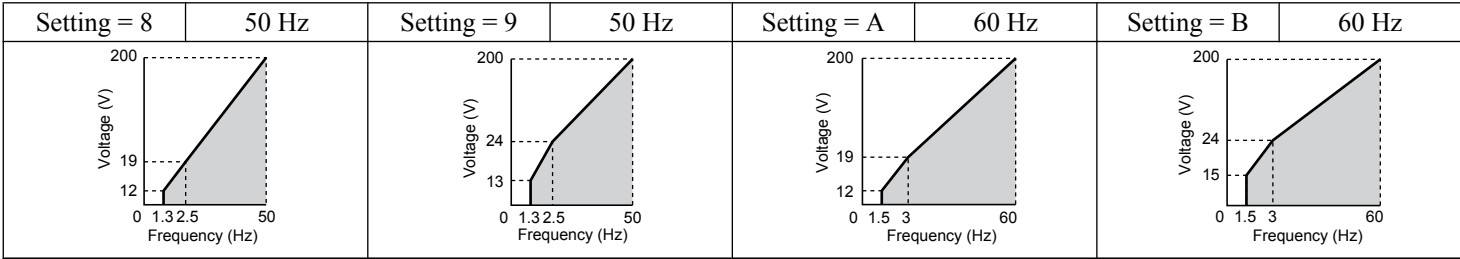
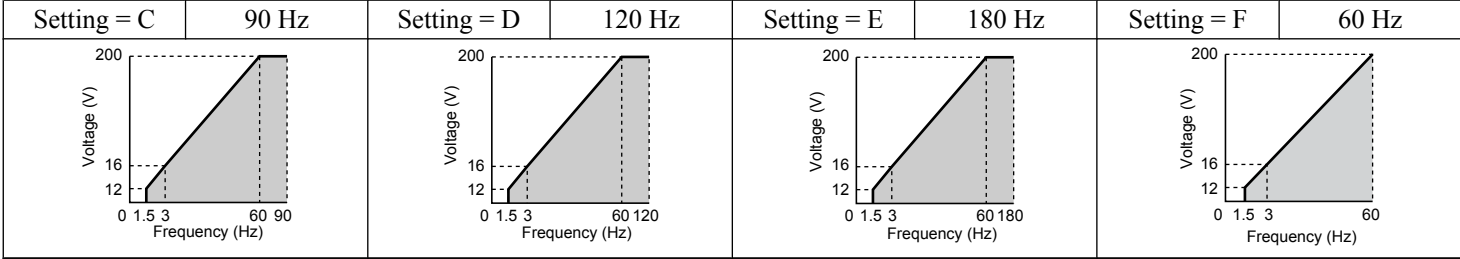

Table 5.20 Rated Output Operation, Settings C to F



Predefined V/f Patterns for 5.5 to 18.5 kW Drives

The following graphs are for 200 V class drives. Double values when using a 400 V class drive.

Table 5.21 Rated Torque Characteristics, Settings 0 to 3

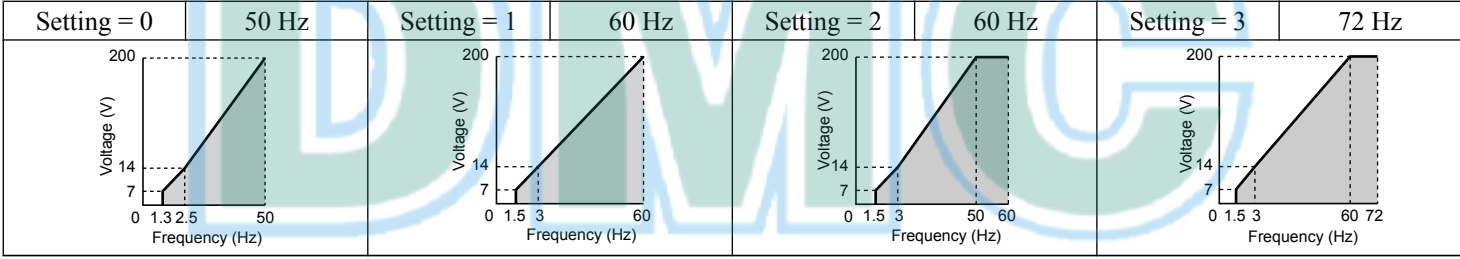

Table 5.22 Derated Torque Characteristics, Settings 4 to 7

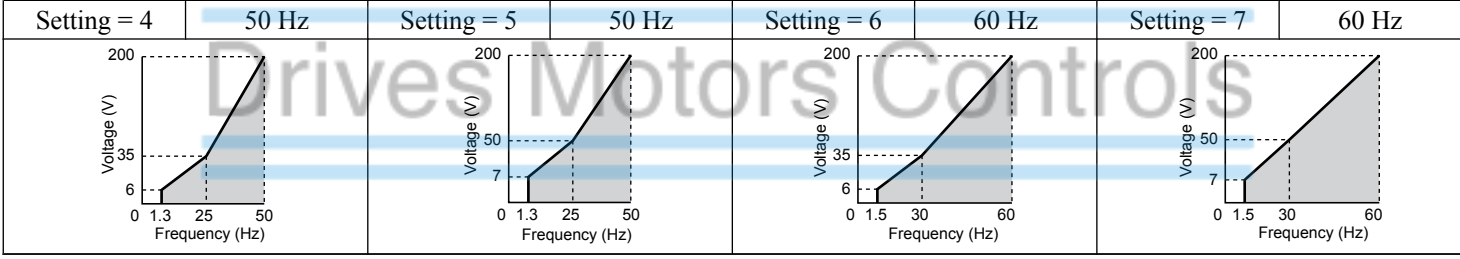
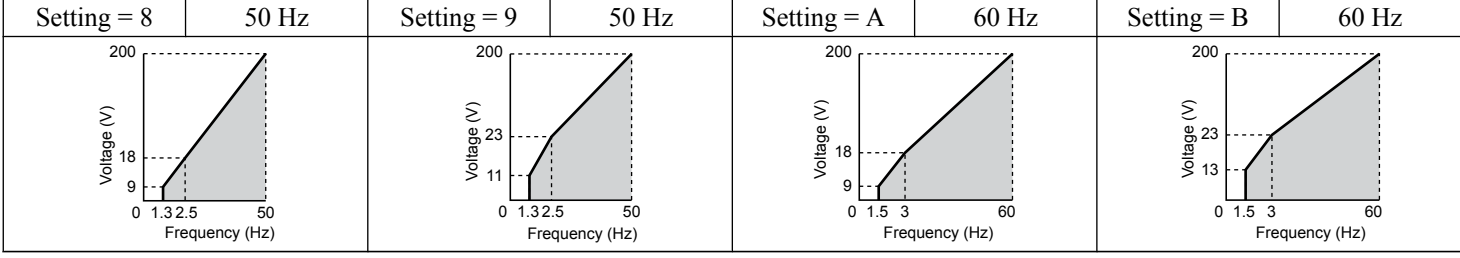

Table 5.23 High Starting Torque, Settings 8 to B



Parameter Details

5

5.5 E: Motor Parameters

Table 5.24 Constant Output, Settings C to F

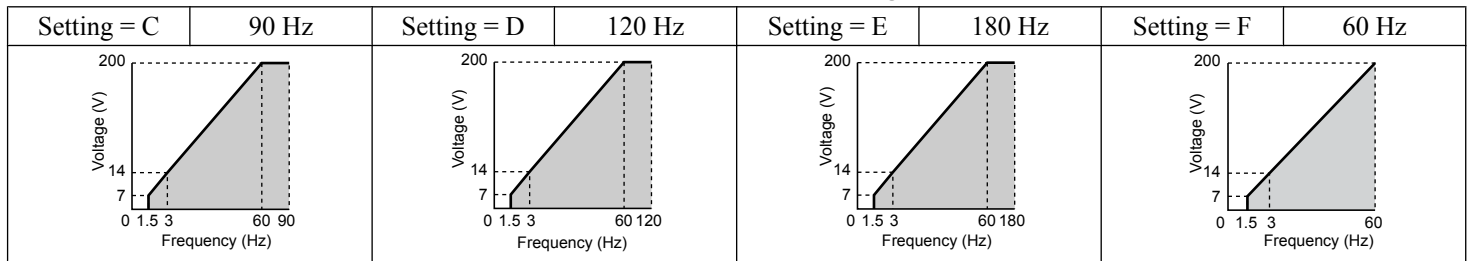

Setting a Custom V/f Pattern

Setting parameter E1-03 to “F” allows to set up a custom V/f pattern by changing parameters E1-04 to E1-13.

When E1-03 is changed to “F”, the default values for parameters E1-04 to E1-13 will be equal to V/f pattern 1 of the predefined patterns.

■ V/f Pattern Settings E1-04 to E1-13

Using parameters E1-04 through E1-13, the user can either monitor the V/f pattern values if E1-03 = <1> or set up a custom V/f pattern as shown in [Figure 5.42](#) when E1-03 = F.

No.	Parameter Name	Setting Range	Default
E1-04	Maximum Output Frequency	40.0 to 400.0 Hz <2>	<3>
E1-05	Maximum Voltage	0.0 to 255.0 V <2>	<3>
E1-06	Base Frequency	0.0 to 400.0 Hz <2>	<3>
E1-07	Middle Output Frequency	0.0 to 400.0 Hz	<3>
E1-08	Middle Output Frequency Voltage	0.0 to 255.0 V <2>	<3>
E1-09 <3>	Minimum Output Frequency	0.0 to 400.0 Hz <5>	<3>
E1-10	Minimum Output Frequency Voltage	0.0 to 255.0 V <2>	<3>
E1-11	Middle Output Frequency 2	0.0 to 400.0 Hz	0.0 Hz
E1-12	Middle Output Frequency Voltage 2	0.0 to 255.0 V <2>	0.0 V
E1-13 <3>	Base Voltage	0.0 to 255.0 Hz	0.0 V

<1> Default setting is determined by the control mode.

<2> Values shown are for 200 V class drives; double the value when using 400 V class drives.

<3> In OLV for PM E1-09 specifies the start frequency for short circuit braking at stop. [Refer to b2-13: Short Circuit Brake Time at Stop on page 129](#) for details.

<4> When E1-13 is set to 0.0 V, the drive uses the value set in E1-05 to control the voltage.

<5> Default setting is determined by E5-01 in OLV/PM. When E5-01 is set to FFFFH, the setting range for E1-04 and E1-06 is 10.0 to 40.0 Hz and the setting range for E1-09 is 0.0 to 400.0 Hz.

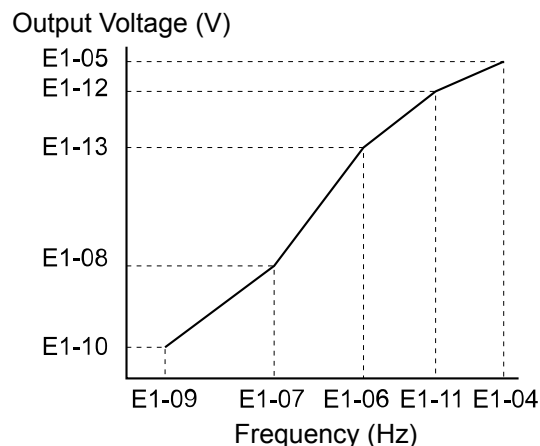

Figure 5.42 V/f Pattern

Note: 1. The following condition must be true when setting up the V/f pattern: $E1-09 \leq E1-07 < E1-06 \leq E1-11 \leq E1-04$

2. Setting E1-11 to 0 disables both E1-11 and E1-12 and the above conditions do not apply.
3. To make the V/f pattern a straight line set E1-09 = E1-07. In this case the E1-08 setting is disregarded.
4. E1-03 is unaffected when the drive is initialized using parameter A1-03, but the settings for E1-04 through E1-13 are returned to their default values.

◆ E2: Motor 1 Parameters

These parameters contain the most important motor data needed for optimal motor control. The parameters are set automatically during Auto-Tuning. Set the parameters manually when Auto-Tuning cannot be performed.

■ E2-01: Motor Rated Current

Set E2-01 to the full load amps (FLA) stamped on the motor nameplate. During Auto-Tuning the value must be entered to parameter T1-04. If Auto-Tuning completes successfully, the value entered will automatically be saved to E2-01.

No.	Parameter Name	Setting Range	Default
E2-01	Motor Rated Current	10% to 200% of the drive rated current. (unit: 0.01 A)	Depending on o2-04

- Note:**
1. Display is in the following units: BA0001 to BA0018, 2A0001 to 2A0040, and 4A0001 to 4A0023: 0.01 A units.
2A0056 to 2A0069, 4A0031 to 4A0038: 0.1 A units.
 2. Change E2-01 only after changing the value set to E2-03. Setting E2-01 < E2-03 will trigger an oPE02 error.

■ E2-02: Motor Rated Slip

Sets the motor rated slip in Hz. This value is automatically set during Rotational Auto-Tuning.

No.	Parameter Name	Setting Range	Default
E2-02	Motor Rated Slip	0.00 to 20.00 Hz	Depending on o2-04

If Auto-Tuning cannot be performed calculate the motor rated slip using the information written on the motor nameplate and the formula below:

$$E2-02 = f - (n \times p) / 120$$

(f: rated frequency (Hz), n: rated motor speed (r/min), p: number of motor poles)

■ E2-03: Motor No-Load Current

Set E2-03 to the motor no-load current at rated voltage and rated frequency. If Rotational Auto-Tuning completes successfully, this value is automatically calculated. If Auto-Tuning cannot be performed, contact the motor manufacturer for information about the no-load current.

No.	Parameter Name	Setting Range	Default
E2-03	Motor No-Load Current	0 to [E2-01] (unit: 0.01 A)	Depending on o2-04

- Note:** Display is in the following units: BA0001 to BA0018, 2A0001 to 2A0040, and 4A0001 to 4A0023: 0.01 A units.
2A0056 to 2A0069, 4A0031 to 4A0038: 0.1 A units.

■ E2-04: Number of Motor Poles

Set the number of motor poles to E2-04. This value must be entered during Auto-Tuning, and will automatically be saved to E2-04 if Auto-Tuning completes successfully.

No.	Parameter Name	Setting Range	Default
E2-04	Number of Motor Poles	2 to 48 poles	4 poles

■ E2-05: Motor Line-to-Line Resistance

Sets the line-to-line resistance of the motor stator winding. If the Auto-Tuning completes successfully, this value is automatically calculated. Remember this value must be entered as line-line and not line-neutral.

No.	Parameter Name	Setting Range	Default
E2-05	Motor Line-to-Line Resistance	0.000 to 65.000 Ω	Depending on o2-04

- Note:** The setting range becomes 0.00 to 130.00 when using BA0002, 2A0002, 4A0001 and smaller.

5.5 E: Motor Parameters

If Auto-Tuning is not possible, then contact the motor manufacturer to find out the line-to-line resistance or measure it manually. When using the manufacturer Motor Test Report, calculate E2-05 by the formulas below.

- E-type insulation: Multiply 0.92 times the resistance value (Ω) listed on the Test Report at 75 °C
- B-type insulation: Multiply 0.92 times the resistance value (Ω) listed on the Test Report at 75 °C.
- F-type insulation: Multiply 0.87 times the resistance value (Ω) listed on the Test Report at 115 °C.

■ E2-06: Motor Leakage Inductance

Sets the voltage drop due to motor leakage inductance as a percentage of motor rated voltage.

No.	Parameter Name	Setting Range	Default
E2-06	Motor Leakage Inductance	0.0 to 40.0%	Depending on o2-04

■ E2-07: Motor Iron-Core Saturation Coefficient 1

This parameter sets the motor iron saturation coefficient at 50% of the magnetic flux. If Rotational Auto-Tuning completes successfully, then this value is automatically calculated.

No.	Parameter Name	Setting Range	Default
E2-07	Motor Iron-Core Saturation Coefficient 1	0.00 to 0.50	0.50

■ E2-08: Motor Iron-Core Saturation Coefficient 2

This parameter sets the motor iron saturation coefficient at 75% of the magnetic flux. If Rotational Auto-Tuning completes successfully, then this value is automatically calculated.

No.	Parameter Name	Setting Range	Default
E2-08	Motor Iron-Core Saturation Coefficient 2	E2-07 to 0.75	0.75

■ E2-09: Motor Mechanical Loss

This parameter sets to the motor mechanical loss as a percentage of motor rated power (kW) capacity.

No.	Parameter Name	Setting Range	Default
E2-09	Motor Mechanical Loss	0.0 to 10.0%	0.0%

Adjust this setting in the following circumstances:

- When there is a large amount of torque loss due to motor bearing friction.
- When there is a large amount of torque loss in a fan or pump application.

The setting for the mechanical loss is added to the torque.

■ E2-10: Motor Iron Loss for Torque Compensation

This parameter sets the motor iron loss in watts.

No.	Parameter Name	Setting Range	Default
E2-10	Motor Iron Loss for Torque Compensation	0 to 65535 W	Depending on o2-04

■ E2-11: Motor Rated Power

This parameter sets the motor rated power in kW. During Auto-Tuning the value must entered to parameter T1-02. If Auto-Tuning completes successfully, the value entered will automatically be saved to E2-11.

No.	Parameter Name	Setting Range	Default
E2-11	Motor Rated Power	0.00 to 650.00 kW	Depending on o2-04

■ E2-12: Motor Iron-Core Saturation Coefficient 3

This parameter sets the motor iron saturation coefficient at 130% of the magnetic flux.

No.	Parameter Name	Setting Range	Default
E2-12	Motor Iron-Core Saturation Coefficient 3	1.30 to 5.00	1.30

◆ E3: V/f Characteristics for Motor 2

These parameters set the V/f pattern used for motor 2. *Refer to Setting 16: Motor 2 Selection on page 189* for details on switching motors.

■ E3-01: Motor 2 Control Mode Selection

Selects the control mode for motor 2. Motor 2 cannot be used in OLV/PM control mode.

No.	Parameter Name	Setting Range	Default
E3-01	Motor 2 Control Mode Selection	0 or 2	0

Setting 0: V/f Control

Setting 2: Open Loop Vector Control

■ E3-04 to E3-13

Parameters E3-04 through E3-13 set up the V/f pattern used for motor 2 like shown in *Figure 5.43*.

No.	Parameter Name	Setting Range	Default
E3-04	Motor 2 Max Output Frequency	40.0 to 400.0 Hz	60.0 Hz
E3-05	Motor 2 Max Voltage	0.0 to 255.0 V <2>	230.0 V <2>
E3-06	Motor 2 Base Frequency	0.0 to 400.0 Hz	60.0 Hz
E3-07	Motor 2 Mid Output Frequency	0.0 to 400.0 Hz	<2>
E3-08	Motor 2 Mid Output Frequency Voltage	0.0 to 255.0 V <2>	<2>
E3-09	Motor 2 Minimum Output Frequency	0.0 to 400.0 Hz	<2>
E3-10	Motor 2 Minimum Output Frequency Voltage	0.0 to 255.0 V <2>	<2>
E3-11	Motor 2 Mid Output Frequency 2	0.0 to 400.0 Hz	0.0 Hz
E3-12	Motor 2 Mid Output Frequency Voltage 2	0.0 to 255.0 V <2>	0.0 Vac
E3-13	Motor 2 Base Voltage	0.0 to 255.0 V <2>	0.0 Vac

<1> Values shown here are for 200 V class drives. Multiply voltage values by 1.15 for U-spec drives. Double the value when using 400 V class drives.

<2> Default setting is determined by the control mode for motor 2.

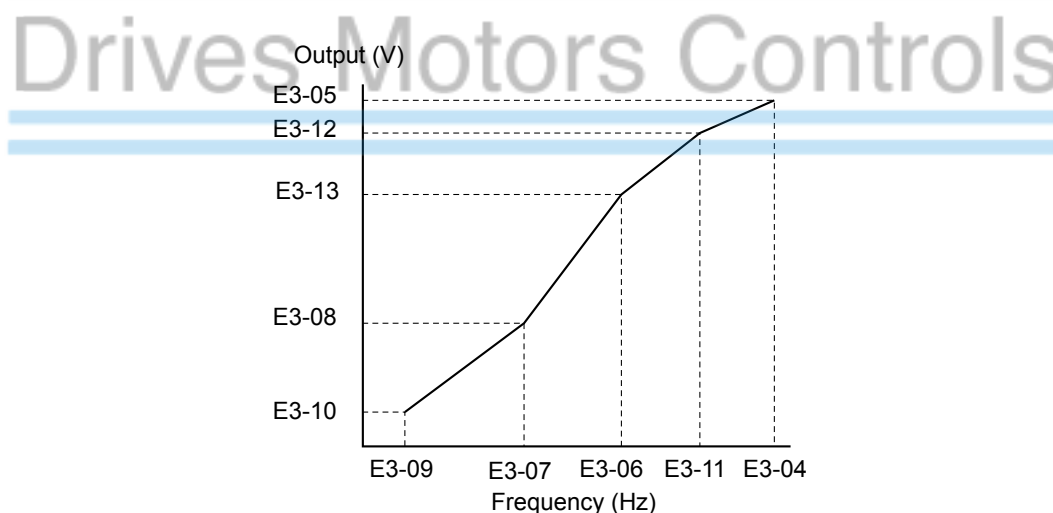

Figure 5.43 V/f Pattern for Motor 2

- Note:**
1. The following condition must be true when setting up the V/f pattern: $E3-09 \leq E3-07 \leq E3-06 \leq E3-11 \leq E3-04$
 2. To make the V/f pattern a straight line set $E3-09 = E3-07$. In this case the E3-08 setting is disregarded.

◆ E4: Motor 2 Parameters

E4 parameters contain the motor data for motor 2. These parameters are usually set automatically during the Auto-Tuning process. They may need to be set manually if there is a problem performing Auto-Tuning.

■ E4-01: Motor 2 Rated Current

Set E4-01 to the full load amps (FLA) stamped on the nameplate of motor 2. During Auto-Tuning the value must be entered to parameter T1-04. If Auto-Tuning completes successfully, the value entered will automatically be saved to E4-01.

No.	Parameter Name	Setting Range	Default
E4-01	Motor 2 Rated Current	10 to 200% of the drive rated current.	Depending on o2-04

Note: Display is in the following units: BA0001 to BA0018, 2A0001 to 2A0040, and 4A0001 to 4A0023: 0.01 A units.
2A0056 to 2A0069, 4A0031 to 4A0038: 0.1 A units.

■ E4-02: Motor 2 Rated Slip

This parameter sets the motor 2 rated slip frequency. The drive calculates this value automatically during Rotational Auto-Tuning.

For information on calculating the motor rated slip, see the description for E2-02.

No.	Parameter Name	Setting Range	Default
E4-02	Motor 2 Rated Slip	0.00 to 20.00 Hz	Depending on o2-04

■ E4-03: Motor 2 Rated No-Load Current

Set E4-03 to the motor no-load current at rated voltage and rated frequency. If Rotational Auto-Tuning completes successfully, this value is automatically calculated. If Auto-Tuning cannot be performed contact the motor manufacturer for information about the no-load current.

No.	Parameter Name	Setting Range	Default
E4-03	Motor 2 Rated No-Load Current	0 to [E4-01]	Depending on o2-04

Note: Display is in the following units: BA0001 to BA0018, 2A0001 to 2A0040, and 4A0001 to 4A0023: 0.01 A units.
2A0056 to 2A0069, 4A0031 to 4A0038: 0.1 A units.

■ E4-04: Motor 2 Motor Poles

Set the pole number of motor 2 to E4-04. During Auto-Tuning the value must be entered to parameter T1-06. If Auto-Tuning completes successfully, the entered value will automatically be saved to E4-04.

No.	Parameter Name	Setting Range	Default
E4-04	Motor 2 Motor Poles	2 to 48	4

■ E4-05: Motor 2 Line-to-Line Resistance

Sets the line-to-line resistance of motor 2 stator winding. If the Auto-tuning completes successfully, this value is automatically calculated. Remember this value must be entered as line-line and not line-neutral.

No.	Parameter Name	Setting Range	Default
E4-05	Motor 2 Line-to-Line Resistance	0.000 to 65.000 Ω	Depending on o2-04

Note: The setting range is 0.00 to 130.00 when using a drive capacity of 0.2 kW or less.

Refer to E2-05: Motor Line-to-Line Resistance on page 173 to manually enter this parameter setting.

■ E4-06: Motor 2 Leakage Inductance

Sets the voltage drop due to motor leakage inductance of motor 2. The value is set as a percentage of the rated voltage.

No.	Parameter Name	Setting Range	Default
E4-06	Motor 2 Leakage Inductance	0.0 to 40.0%	Depending on o2-04

■ E4-07: Motor 2 Motor Iron-Core Saturation Coefficient 1

Sets the motor 2 iron saturation coefficient at 50% of magnetic flux. This value is automatically set during Rotational Auto-Tuning.

No.	Parameter Name	Setting Range	Default
E4-07	Motor 2 Motor Iron-Core Saturation Coefficient 1	0.00 to 0.50	0.50

■ E4-08: Motor 2 Motor Iron-Core Saturation Coefficient 2

Sets the motor iron saturation coefficient at 75% of magnetic flux. This value is automatically set during Rotational Auto-Tuning.

No.	Parameter Name	Setting Range	Default
E4-08	Motor 2 Motor Iron-Core Saturation Coefficient 2	[E4-07] to 0.75	0.75

■ E4-09: Motor 2 Mechanical Loss

Sets the motor mechanical loss as a percentage of motor rated power (kW).

No.	Parameter Name	Setting Range	Default
E4-09	Motor 2 Mechanical Loss	0.00 to 10.0%	0.0%

This parameter seldom needs to be changed, but may need to be adjusted in the following circumstances:

- When there is a large amount of torque loss due to motor bearing friction.
- When there is a large amount of torque loss in a fan or pump application.

■ E4-10: Motor 2 Iron Loss

Sets the motor 2 iron loss in watts.

No.	Parameter Name	Setting Range	Default
E4-10	Motor 2 Iron Loss	0 to 65535 W	Depending on o2-04

■ E4-11: Motor 2 Rated Power

Sets the motor 2 rated power. During Auto-Tuning the value must entered to parameter T1-02. If Auto-Tuning completes successfully, the entered value will automatically be saved to E4-11.

No.	Parameter Name	Setting Range	Default
E4-11	Motor 2 Rated Power	0.00 to 650.00 kW	Depending on o2-04

■ E4-12: Motor 2 Iron-Core Saturation Coefficient 3

Sets the motor 2 iron saturation coefficient at 130% of magnetic flux.

No.	Parameter Name	Setting Range	Default
E4-12	Motor 2 Iron-Core Saturation Coefficient 3	1.30 to 5.00	1.30

■ E4-14: Motor 2 Slip Compensation Gain

Instead of C3-01 the value of E4-14 is used as gain for slip compensation when motor 2 is selected. [Refer to C3-01: Slip Compensation Gain on page 151](#) for details and setting instructions.

No.	Parameter Name	Setting Range	Default
E4-14	Motor 2 Slip Compensation Gain	0.0 to 2.50	Depending on E3-01

■ E4-15: Motor 2 Torque Compensation Gain

Instead of C4-01 the value of E4-15 is used as gain for torque compensation when motor 2 is selected. [Refer to C4-01: Torque Compensation Gain on page 152](#) for details and setting instructions.

5.5 E: Motor Parameters

No.	Parameter Name	Setting Range	Default
E4-15	Motor 2 Torque Compensation Gain	0.0 to 2.50	1.00

◆ E5: PM Motor Settings

These parameters set the motor data of a PM motor used in OLV for PM (A1-02 = 5).

When Yaskawa motors are used, entering the motor code written on the motor nameplate will set up the E5-□□ parameters. For all other PM motors, the data must be entered manually.

■ E5-01: PM Motor Code Selection

Set the motor code for the PM motor being used. Depending on the motor code entered, the drive automatically sets several parameters to appropriate values. *Refer to Parameters that Change with the Motor Code Selection on page 417* for details on the supported motor codes and their parameter settings.

No.	Parameter Name	Setting Range	Default
E5-01	PM Motor Code Selection	0000 to FFFF	Depending on o2-04

- Note:**
1. This parameter is not reset when the drive is initialized using parameter A1-03.
 2. The default setting is for a Yaskawa SMRA Series SPM Motor with a speed rating of 1800 r/min.
 3. Changing the motor code setting resets all E5-□□ settings to their default values.
 4. Set to “FFFF” when using a non-Yaskawa PM motor or one that is not supported by the motor code settings.

Figure 5.44 explains the motor code setting.

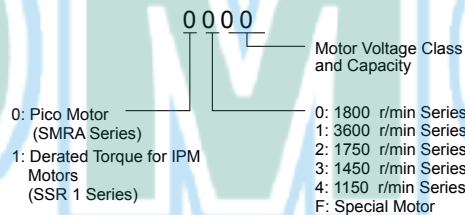

Figure 5.44 PM Motor Code

■ E5-02: Motor Rated Power (PM OLV)

Sets the rated power of the motor.

No.	Parameter Name	Setting Range	Default
E5-02	Motor Rated Power	0.10 to 18.50 kW	Depending on E5-01

- Note:** This parameter is not reset when the drive is initialized using A1-03.

■ E5-03: Motor Rated Current (PM OLV)

Sets the motor rated current in amps.

No.	Parameter Name	Setting Range	Default
E5-03	Motor Rated Current	10 to 200% of drive rated current	Depending on E5-01

- Note:**
1. Display is in the following units: BA0001 to BA0018, 2A0001 to 2A0040, and 4A0001 to 4A0023: 0.01 A units. 2A0056 to 2A0069, 4A0031 to 4A0038: 0.1 A units.
 2. This parameter is not reset when the drive is initialized using A1-03.

■ E5-04: Number of Motor Poles (PM OLV)

Sets the number of motor poles.

No.	Parameter Name	Setting Range	Default
E5-04	Number of Motor Poles	2 to 48	Depending on E5-01

- Note:** This parameter is not reset when the drive is initialized using A1-03.

■ E5-05: Motor Stator Resistance (PM OLV)

Set the resistance for each motor phase (not line-to-line resistance). When measuring the resistance manually make sure to enter the resistance of one phase into E5-05.

No.	Parameter Name	Setting Range	Default
E5-05	Motor Stator Resistance	0.000 to 65.000 Ω	Depending on E5-01

Note: This parameter is not reset when the drive is initialized using A1-03.

■ E5-06: Motor d Axis Inductance (PM OLV)

Sets the d axis inductance in units of 0.01 mH. Contact the motor manufacturer for d-axis inductance. If an LCR meter is available, enter half the value of the measurement taken.

No.	Parameter Name	Setting Range	Default
E5-06	Motor d Axis Inductance	0.00 to 300.00 mH	Depending on E5-01

Note: This parameter is not reset when the drive is initialized using A1-03.

■ E5-07: Motor q Axis Inductance (PM OLV)

Sets the q axis inductance in units of 0.01 mH. Contact the motor manufacturer for d-axis inductance. If an LCR meter is available, enter half the value of the measurement taken.

No.	Parameter Name	Setting Range	Default
E5-07	Motor q Axis Inductance	0.00 to 600.00 mH	Depending on E5-01

Note: This parameter is not reset when the drive is initialized using A1-03.

■ E5-09: Motor Induction Voltage Constant 1 (PM OLV)

Set the induced phase peak voltage in units of 0.1 mV/(rad/s) [electrical angle]. Set this parameter when using an SSR1 series IPM motor with derated torque or an SST4 series motor with constant torque.

When E5-01 is set to “FFFF” use either E5-09 or E5-24 for setting the voltage constant.

No.	Parameter Name	Setting Range	Default
E5-09	Motor Induction Voltage Constant 1	0.0 to 2000.0 mV/(rad/s)	Depending on E5-01

- Note:**
1. Ensure that E5-24 = 0 when setting parameter E5-09. An alarm will be triggered, however, if both E5-09 and E5-24 are set 0, or if neither parameter is set to 0.
 2. This parameter is not reset when the drive is initialized using A1-03.

■ E5-24: Motor Induction Voltage Constant 2 (PM OLV)

Set the induced phase-to-phase rms voltage in units of 0.1 mV/(r/min) [mechanical angle]. Set this parameter to 0 when using an SMRA Series SPM Motor.

When E5-01 is set to “FFFF” use either E5-09 or E5-24 for setting the voltage constant.

No.	Parameter Name	Setting Range	Default
E5-24	Motor Induction Voltage Constant 2 (PM OLV)	<>	Depending on E5-01

<1> Range depends on the drive software version.
 PRG: 1018 and later: 0.0 to 6500.0 mV/(r/min)
 PRG: 1017 and earlier: 0.0 to 2000.0 mV/(r/min)

- Note:**
1. If E5-03 is not set to 0, then setting both E5-09 and E5-24 to 0, or setting neither E5-09 nor E5-24 to 0, will trigger an oPE08 error. However, if E5-03 is set to 0, setting both E5-09 and E5-24 to 0 will not trigger the error.
 2. This parameter is not reset when the drive is initialized using A1-03.
 3. The values for the electrical and mechanical angle should be set using the same units specified by the manufacturer of the motor.

■ E5-39: Current Detection Delay Time

Sets the current detection delay time of d-Axis and q-Axis current feedback calculation.

5.5 E: Motor Parameters

Changing this parameter from the default setting is not normally required.

Note: Parameter available in drive software versions PRG: 1022 and later.

No.	Parameter Name	Setting Range	Default
E5-39	Current Detection Delay Time	-1000 to 1000 μ s	0 μ s

DMC

Drives Motors Controls

5.6 F: Option Settings

◆ F1: Error Detection for V/f Control with PG

A one-track pulse signal can be connected to the drive pulse train input RP as speed feedback. Using this signal for slip compensation improves the speed control accuracy. This function is only available for motor 1.

The F1 parameters determine how the error detection for the speed feedback signal works. *Refer to C5: Automatic Speed Regulator (ASR) on page 154* for details on how to activate and tune the function.

■ Operation at PG Fault Detection

The drive lets the user select from one of four possible operations when a fault occurs with the PG encoder. The operation can be set up separately for each fault using parameters F1-02/03/04. The table below lists the stopping methods and the parameter setting values.

Table 5.25 Stopping Methods for PGo, oS, dEv Detection

Description	Setting
Ramp to Stop (uses the deceleration time set to C1-02)	0
Coast to Stop	1
Fast-stop (uses the Fast-stop time set to C1-09)	2
Alarm only	3

NOTICE: Setting = 3: Alarm only will provide an alarm only while continuing to run the motor during abnormal PG fault conditions. This may cause damage to machinery. Use caution when selecting this setting.

■ F1-02: Operation Selection at PG Open Circuit (PGo)

Sets the stopping method when a PG open circuit fault (PGo) occurs. Refer to [Table 5.25](#) for setting explanations.

No.	Parameter Name	Setting Range	Default
F1-02	Operation Selection at PG Open Circuit (PGo)	0 to 3	1

■ F1-03: Operation Selection at Overspeed

Sets the stopping method when an overspeed (oS) fault occurs. Refer to [Table 5.25](#) for setting explanations.

No.	Parameter Name	Setting Range	Default
F1-03	Operation Selection at Overspeed (oS)	0 to 3	1

■ F1-04: Operation Selection at Deviation

Sets the stopping method when a speed deviation (dEv) fault occurs. Refer to [Table 5.25](#) for setting explanations.

No.	Parameter Name	Setting Range	Default
F1-04	Operation Selection at Deviation (dEv)	0 to 3	3

■ F1-08/F1-09: Overspeed Detection Level/Delay Time

F1-08 sets the detection level for an overspeed (oS) fault as a percentage of the maximum output frequency. The speed feedback has to exceed this level for longer than the time set in F1-09 before a fault is detected.

No.	Parameter Name	Setting Range	Default
F1-08	Overspeed Detection Level	0 to 120%	115%
F1-09	Overspeed Detection Delay Time	0.0 to 2.0 s	1.0 s

■ F1-10/F1-11: Excessive Speed Deviation Detection Level/Delay Time

F1-10 sets the detection level for a speed deviation (dEv) fault as a percentage of the maximum output frequency. The speed feedback has to exceed this level for longer than the time set in F1-11 before a fault is detected. Speed deviation is the difference between actual motor speed and the frequency reference command.

5.6 F: Option Settings

No.	Parameter Name	Setting Range	Default
F1-10	Excessive Speed Deviation Detection Level	0 to 50%	10%
F1-11	Excessive Speed Deviation Detection Delay Time	0.0 to 10.0 s	0.5 s

■ F1-14: PG Open-Circuit Detection Time

Sets the time required to detect PGo if no pulse signal is present at terminal RP.

No.	Parameter Name	Setting Range	Default
F1-14	PG Open-Circuit Detection Time	0.0 to 10.0 s	2.0 s

◆ F6: Serial Communications Option Card Settings

These parameters configure communication option cards and communication fault detection methods.

■ F6-01: Communications Error Operation Selection

Determines drive operation if a communication error occurs.

No.	Parameter Name	Setting Range	Default
F6-01	Communications Error Operation Selection	0 to 5	1

Setting 0: Ramp to Stop Using Current Accel/Decel Time

Setting 1: Coast to Stop

Setting 2: Fast-stop Using C1-09

Setting 3: Alarm Only, Continue Operation

Setting 4: Alarm and Run at d1-04

Note: Take proper safety measures, such as installing an emergency stop switch, as the drive will continue operation when detecting an bUS error.

Setting 5: Alarm and Ramp to stop

■ F6-02: External Fault from Comm. Option Detection Selection

Determines the detection method of an external fault initiated by a communication option (EF0).

No.	Parameter Name	Setting Range	Default
F6-02	External Fault from Comm. Option Selection	0 or 1	0

Setting 0: Always Detected

Setting 1: Detection During Run Only

■ F6-03: External Fault from Comm. Option Operation Selection

Determines the operation when an external fault is initiated by a communication option (EF0).

No.	Parameter Name	Setting Range	Default
F6-03	External Fault from Comm. Option Operation Selection	0 to 3	1

Setting 0: Ramp to Stop Using Current Accel/Decel Time

Setting 1: Coast to Stop

Setting 2: Fast-stop Using C1-09

Setting 3: Alarm Only, Continue Operation

■ F6-07: NetRef/ComRef Function Selection

Selects how multi-step speed inputs are treated when the NetRef command is set.

No.	Parameter Name	Setting Range	Default
F6-07	NetRef/ComRef Function Selection	0 or 1	0

Setting 0: Multi-Step Speed Operation Disabled

If the NetRef command is selected, multi-step speed input frequency references are disabled. This is the same as Yaskawa F7 drives.

Setting 1: Multi-Step Speed Operation Enabled

Multi-step speed inputs are active and can override the frequency reference from the communications option even when the NetRef command is selected. This is the same as Yaskawa F7 drives.

■ F6-08: Reset Communication Parameters

Determines whether communication-related parameters (F6-□□ and F7-□□) are reset when the drive is initialized using A1-03.

No.	Parameter Name	Setting Range	Default
F6-08	Reset Communication Parameters	0 or 1	0

Setting 0: Do Not Reset Parameters F6-□□ and F7-□□ when the Drive Is Initialized with A1-03**Setting 1: Reset F6-□□ and F7-□□ when the Drive Is Initialized with A1-03**

Note: F6-08 is not reset when the drive is initialized, but does determine whether initializing the drive with A1-03 resets communication parameters F6-□□ and F7-□□.

◆ MECHATROLINK-II Parameters

Parameters F6-20 through F6-26 set up the drive to operate on a MECHATROLINK-II network. Refer to the option manual for details on parameter settings.

◆ MECHATROLINK-III Parameters

Parameters F6-20, F6-21, and F6-23 through F6-26 set up the drive to operate on a MECHATROLINK-III network. Refer to the option manual for details on parameter settings.

◆ PROFIBUS-DP Parameters

Parameters F6-30 through F6-32 set up the drive to operate on a PROFIBUS-DP network. Refer to the option manual for details on parameter settings.

◆ DeviceNet Parameters

Parameters F6-50 through F6-63 set up the drive to operate on a DeviceNet network. Refer to the option manual for details on parameter settings.

◆ F7-01 to F7-42: EtherNet/IP and Modbus TCP/IP Option Parameters

F7-□□ parameters are reserved for use with SI-EN3/V and SI-EM3/V options. Refer to the Option Installation Manuals for details.

5.7 H: Terminal Functions

H parameters are used to assign functions to the external terminals.

◆ H1: Multi-Function Digital Inputs

■ H1-01 to H1-07: Functions for Terminals S1 to S7

These parameters assign functions to the multi-function digital inputs. Settings 0 to 9F determine function for each terminal and are explained below.

- Note:**
1. Terminals that are not used and terminals using the through-mode should be set to “F”.
 2. Drive software versions PRG: 1013 and later require that the Forward run and Reverse Run commands be set simultaneously.

No.	Parameter Name	Setting Range	Default
H1-01	Digital Input S1 Function Selection	1 to 9F	40: Forward Run Command (2-wire sequence)
H1-02	Digital Input S2 Function Selection	1 to 9F	41: Reverse Run Command (2-wire sequence)
H1-03	Digital Input S3 Function Selection	0 to 9F	24: External Fault (N.O., always detected, coast to stop)
H1-04	Digital Input S4 Function Selection	0 to 9F	14: Fault Reset
H1-05	Digital Input S5 Function Selection	0 to 9F	3 (0) <1> : Multi-Step Speed Reference 1
H1-06	Digital Input S6 Function Selection	0 to 9F	4 (3) <1> : Multi-Step Speed Reference 2
H1-07	Digital Input S7 Function Selection	0 to 9F	6 (4) <1> : Jog Reference Selection

<1> Number appearing in parenthesis is the default value after performing a 3-Wire initialization.

Table 5.26 Digital Multi-Function Input Settings

Setting	Function	Page	Setting	Function	Page
0	3-Wire Sequence	185	30	PID Integral Reset	191
1	LOCAL/REMOTE Selection	185	31	PID Integral Hold	191
2	External Reference 1/2	186	32	Multi-Step Speed Reference 4	191
3	Multi-Step Speed Reference 1	186	34	PID Soft Starter Cancel	191
4	Multi-Step Speed Reference 2		35	PID Input Level Selection	191
5	Multi-Step Speed Reference 3		40	Forward Run/Stop (2-wire sequence)	191
6	Jog Reference Selection	186	41	Reverse Run/Stop (2-wire sequence)	191
7	Accel/Decel Time 1	186	42	Run/Stop (2-Wire sequence 2)	
8	Baseblock Command (N.O.)	186	43	FWD/REV (2-Wire sequence 2)	191
9	Baseblock Command (N.C.)	186	44	Offset Frequency 1 Addition	192
A	Accel/Decel Ramp Hold		45	Offset Frequency 2 Addition	
B	Drive Overheat Alarm (oH2)		46	Offset Frequency 3 Addition	
C	Terminal A1/A2 Enable/Disable	187	47 <1>	Node Setup	192
F	Not used/Through Mode	187	60	DC Injection Braking Command	192
10	Up Command	187	61	External Speed Search Command 1	192
11	Down Command		62	External Speed Search Command 2	
12	Forward Jog	188	65	KEB Ride-Thru 1 (N.C.)	192
13	Reverse Jog		66	KEB Ride-Thru 1 (N.O.)	
14	Fault Reset	188	67	Communications Test Mode	192
15	Fast-Stop (N.O.)	188	68	High-Slip Braking	192
16	Motor 2 Selection	189	6A	Drive Enable	192
17	Fast-stop (N.C.)	188	75	Up 2 Command	193
18	Timer Function Input	189	76	Down 2 Command	
19	PID Disable	189	7A	KEB Ride-Thru 2 (N.C.)	194
1A	Accel/Decel Time Selection 2	189	7B	KEB Ride-Thru 2 (N.O.)	
1B	Program Lockout	189	7C	Short-Circuit Braking (N.O.)	194
1E	Reference Sample Hold	190	7D	Short-Circuit Braking (N.C.)	
20 to 2F	External Fault	190			

Setting	Function	Page
7E	Forward/Reverse Detection (V/f Control with Simple PG Feedback)	194
90 to 96	DriveWorksEZ Digital Inputs 1 to 7	194

Setting	Function	Page
9F	DriveWorksEZ Disable	194

<1> Available in drive software versions PRG: 1016 and later.

Setting 0: 3-Wire Sequence

When one of the digital inputs is programmed for 3-Wire control, that input becomes a forward/reverse directional input, S1 becomes the Run command input, and S2 becomes the Stop command input.

The drive will start the motor when the Run input S1 is closed for longer than 50 ms. The drive will stop the operation when the Stop input S2 is released. When the input programmed for 3-Wire sequence is open, the drive will be set for forward direction. If the input is closed, the drive is set for reverse direction.

Note: When 3-Wire sequence is selected the Run and Stop command must be input at S1 and S2.

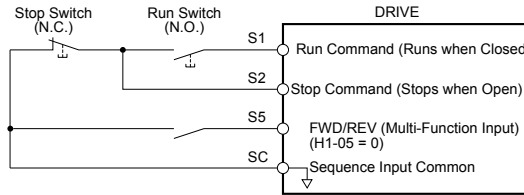

Figure 5.45 3-Wire Sequence Wiring Diagram

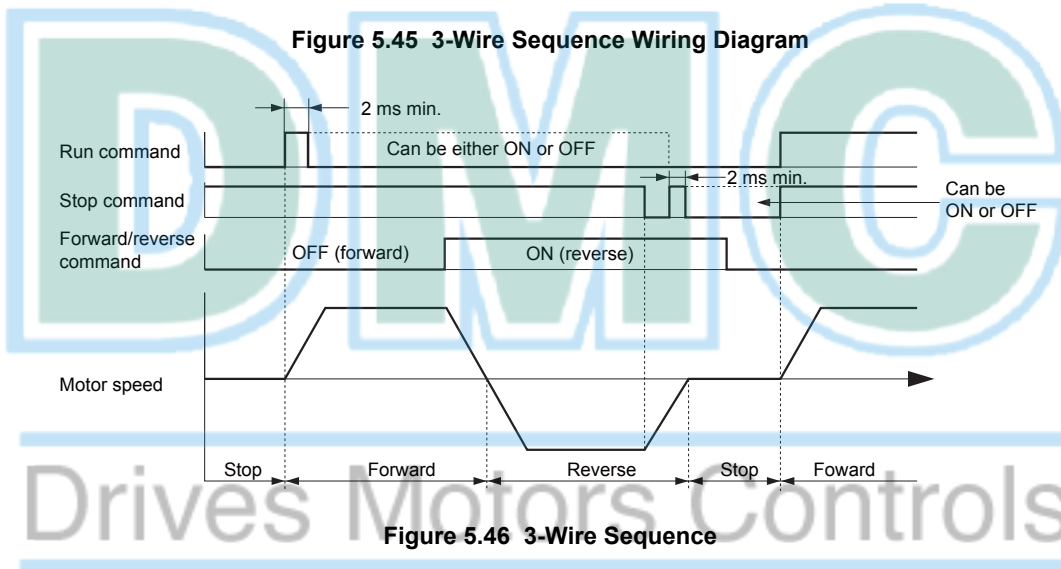

Figure 5.46 3-Wire Sequence

- Note:**
1. The Run and Stop command must be open/closed for a short moment only to start and stop the drive.
 2. If the Run command is active at power up and b1-17 = 0 (Run command at power up not accepted), the Run LED will flash to indicate that protective functions are operating. If required by the application, set b1-17 to “1” to have the Run command issued automatically as soon as the drive is powered up.

WARNING! Sudden Movement Hazard. The drive may start unexpectedly in reverse direction after power up if it is wired for 3-Wire sequence but set up for 2-Wire sequence (default). When using 3-Wire sequence first set the drive properly (H1-□□ = 0) and then connect the control wires. Make sure b1-17 is set to “0” (drive does not accept Run command active at power up). When initializing the drive use 3-Wire initialization. Failure to comply could result in death or serious injury from moving equipment.

Setting 1: LOCAL/REMOTE Selection

This setting allows the input terminal to determine if the drive will run in LOCAL mode or REMOTE mode.

Status	Description
Closed	LOCAL: Frequency reference and Run command are input from the digital operator.
Open	REMOTE: Frequency reference and Run command are input from the selected external reference in accordance with the b1-01 and b1-02 or b1-15 and b1-16 settings.

- Note:**
1. If one of the multi-function input terminals is set to for LOCAL/REMOTE, then the LO/RE key on the operator will be disabled.
 2. When the drive is set to LOCAL, the LO/RE LED will light.
 3. The default setting of the drive is not to allow switching between LOCAL and REMOTE during run. to Refer to b1-07: LOCAL/REMOTE Run Selection on page 127 if this feature is required by the application.

5.7 H: Terminal Functions

Setting 2: External Reference 1/2 Selection

The external reference 1/external reference 2 selection function allows the user to switch between the frequency reference and Run command source between external reference 1 and 2.

Status	Description
Open	External reference 1 is used (defined by parameters b1-01 and b1-02)
Closed	External reference 2 is used (defined by parameters b1-15 and b1-16)

Note: The default setting of the drive is not to allow switching between external reference 1 and 2 during run. *Refer to b1-07: LOCAL/REMOTE Run Selection on page 127* if this feature is required by the application.

Setting 3 to 5: Multi-Step Speed Reference 1 to 3

Used to switch Multi-Step Speed frequency references d1-01 to d1-08 by digital inputs. *Refer to d1-01 to d1-17: Frequency Reference 1 to 16 and Jog Reference on page 160* for details.

Setting 6: Jog Frequency Reference Selection

Used to select the Jog frequency set in parameter d1-17 as active frequency reference. *Refer to d1-01 to d1-17: Frequency Reference 1 to 16 and Jog Reference on page 160* for details.

Setting 7: Accel/Decel Time Selection 1

Used to switch between accel/decel times 1 and 2. *Refer to C1-01 to C1-08: Accel/Decel Times 1 to 4 on page 147* for details.

Setting 8/9: External Baseblock (N.O.) and External Baseblock (N.C.)

Setting 8 or 9 assign the Baseblock command to digital input terminals. When the drive receives a Baseblock command, the output transistor stop switching and the motor coasts to stop. During this time, the alarm “bb” will flash on the LED operator to indicate baseblock. For more information on alarms, *Refer to Alarm Detection on page 282*. When baseblock ends and a Run command is active, the drive performs Speed Search to get the motor running again (*Refer to b3: Speed Search on page 130* for details).

Operation	Inputs	
	Setting 8 (N.O.)	Setting 9 (N.C.)
Normal operation	Open	Closed
Baseblock (Interrupt output)	Closed	Open

NOTICE: If using baseblock in elevator applications, make sure the brake closes when the drive output is cut off by a Baseblock input. Failure to do so will result in the motor suddenly coasting when the Baseblock command is entered, causing the load to slip.

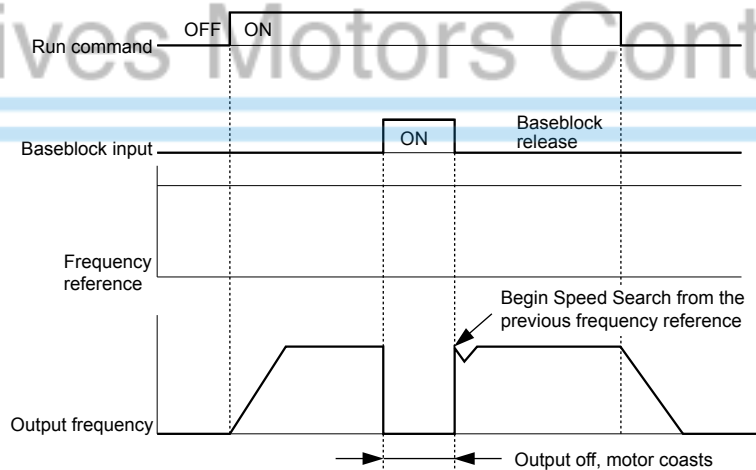

Figure 5.47 Baseblock Operation During Run

Setting A: Accel/Decel Ramp Hold

When the digital input programmed for the Accel/Decel Ramp Hold function closes, the drive will lock (“hold”) the output frequency. All acceleration or deceleration will cease, and the drive will hold the current speed. Acceleration or deceleration will resume once the input is opened again.

If the Accel/Decel Ramp Hold function is enabled ($d4-01 = 1$), the drive will save the output frequency to memory whenever the Ramp Hold input is closed. When the drive is restarted after stop or after power supply interruption, the output frequency that was saved will become the frequency reference (provided that the Accel/Decel Ramp Hold input is still closed). *Refer to d4-01: Frequency Reference Hold Function Selection on page 162* for details.

Setting B: Drive Overheat Alarm (oH2)

Triggers an oH2 alarm when the contact closes. Because this is an alarm, drive operation is not affected.

Setting C: Analog Inputs A1/A2 Enable

If a digital input programmed for this function is open, both analog inputs A1 and A2 are disabled. Close the input to enable the inputs.

The drive disregards the input value selected by parameter H3-14 when this terminal closes.

Note: In drive software versions PRG: 1015 and earlier, input values to terminals A1 and A2 are both disregarded when this terminal closes.

Setting F: Not Used/Through Mode

Any digital input that is not used should be set to F. When set to “F”, an input does not trigger any function in the drive. Setting F, however, still allows the input status to be read out by a PLC via a communication option or MEMOBUS/Modbus communications (through mode). This way external sensors can be connected to unused drive digital inputs, thus reducing the need for separate PLC I/O units.

Setting 10/11: Up/Down Command

Using the Up/Down function allows the frequency reference to be set by two push buttons. One digital input must be programmed as the Up input ($H1-\square\square = 10$) to increase the frequency reference, the other one must be programmed as the Down input ($H1-\square\square = 11$) to decrease the frequency reference.

The Up/Down function has priority over the frequency references digital operator, analog inputs, and pulse input ($b1-01 = 0, 1, 4$). If the Up/Down function is used, then references provided by these sources will be disregarded.

The inputs operate as shown in the table below.

Status		Description
Up (10)	Down (11)	
Open	Open	Hold current frequency reference
Closed	Open	Increase frequency reference
Open	Closed	Decrease frequency reference
Closed	Closed	Hold current frequency reference

- Note:**
1. An oPE03 alarm will occur when only one of the functions Up/Down is programmed for a digital input.
 2. An oPE03 alarm will occur if the Up/Down function is assigned to the terminals while another input is programmed for the Accel/Decel Ramp Hold function. For more information on alarms, *Refer to Drive Alarms, Faults, and Errors on page 263*.
 3. The Up/Down function can only be used for External Reference 1 for parameter b1-01. This should be taken into account when using Up/Down and the external reference parameter b1-15 switching command ($H1-\square\square = 2$).

Using the Up/Down Function with Frequency Reference Hold (d4-01)

- When the frequency reference hold function is disabled ($d4-01 = 0$), the Up/Down frequency reference will be reset to 0 when the Run command is cleared or the power is cycled.
- When $d4-01 = 1$, the drive will save the frequency reference set by the Up/Down function. When the Run command or the power is cycled, the drive will restart with the reference value that was saved. The value that was saved can be reset by closing either the Up or Down input without having a Run command active. *Refer to d4-01: Frequency Reference Hold Function Selection on page 162*.

Using the Up/Down Function with Frequency Reference Limits

The upper frequency reference limit is determined by parameter d2-01.

The value for the lower frequency reference limit depends on the setting of parameter d4-10 and can be set by an analog input or parameter d2-02. *Refer to d4-10: Up/Down Frequency Reference Limit Selection on page 167* for details. When a Run command is applied, the lower limits work as follows:

- If the lower limit is set by parameter d2-02 only, the drive will accelerate to this limit as soon as a Run command is entered.
- If the lower limit is determined by an analog input only, the drive will accelerate to the limit as long as the Run command and an Up or Down command are active. It will not start running if only the Run command is on.
- If the lower limit is set by both an analog input and d2-02, and the analog limit is higher than the d2-02 value, the drive will accelerate to the d2-02 value when a Run command is input. Once the d2-02 value is reached, it will continue acceleration to the analog limit only if an Up or Down command is set.

5.7 H: Terminal Functions

Figure 5.48 shows an Up/Down function example with a lower frequency reference limit set by d2-02 and the frequency reference hold function both enabled (d4-01 = 1) and disabled (d4-01 = 0).

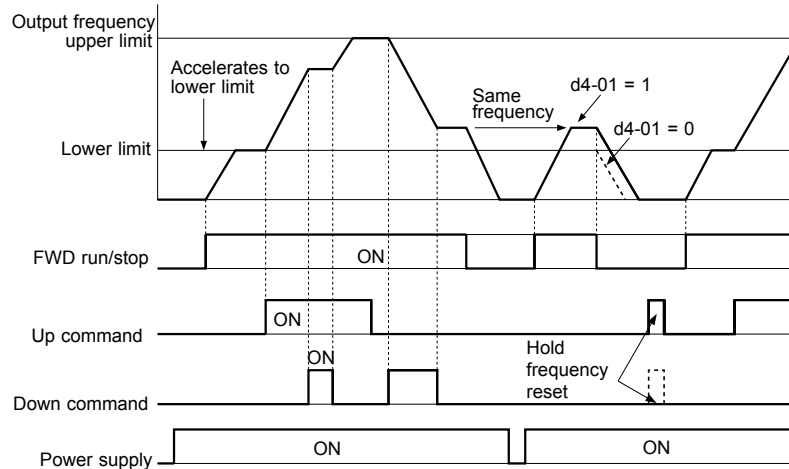

Figure 5.48 Up/Down Command Operation

Setting 12/13: FJOG/RJOG Reference

Digital inputs programmed as Forward Jog (H1-□□ = 12) and Reverse Jog (H1-□□ = 13) will be Jog inputs that do not require a Run command. Closing the terminal set for Forward Jog input will cause the drive to ramp to the Jog Frequency Reference (d1-17) in the forward direction. The Reverse Jog will cause the same action in the reverse direction. The Forward Jog and Reverse Jog command can be set independently.

Note: The Forward Jog and Reverse Jog commands override all other frequency references. However, if the drive is set to prohibit reverse rotation (b1-04 = 1), then activating Reverse Jog will have no effect. If both the Forward Jog and Reverse Jog are input simultaneously for 500 ms or more, an external fault will occur and the drive will stop using the method set by b1-03.

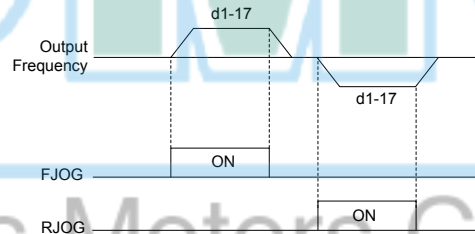

Figure 5.49 FJOG/RJOG Operation

Setting 14: Fault Reset

Whenever the drive detects a fault condition, the fault output contact will close and the drive's output will shut off. The motor then coasts to stop (specific stopping methods can be selected for some faults such as L1-04 for motor overheating). Once the Run command is removed, the fault can be cleared by either the RESET key on the digital operator or by closing a digital input configured as a Fault Reset (H1-□□ = 14).

Note: Fault Reset commands are ignored as long as the Run command is present. To reset a fault, first remove the Run command.

Setting 15/17: Fast-stop (N.O./N.C.)

The Fast-stop function operates much like an emergency stop input to the drive. If a Fast-stop command is input while the drive is running, the drive will decelerate to a stop by the deceleration time set to C1-09 ([Refer to C1-09: Fast-stop Time on page 148](#)). The drive can only be restarted after it has come to a complete stop, the Fast-stop input is off, and the Run command has been switched off.

- To trigger the Fast-stop function with a N.O. switch, set H1-□□ = 15
- To trigger the Fast-stop function with a N.C. switch, set H1-□□ = 17

Figure 5.50 shows an operation example of Fast-stop.

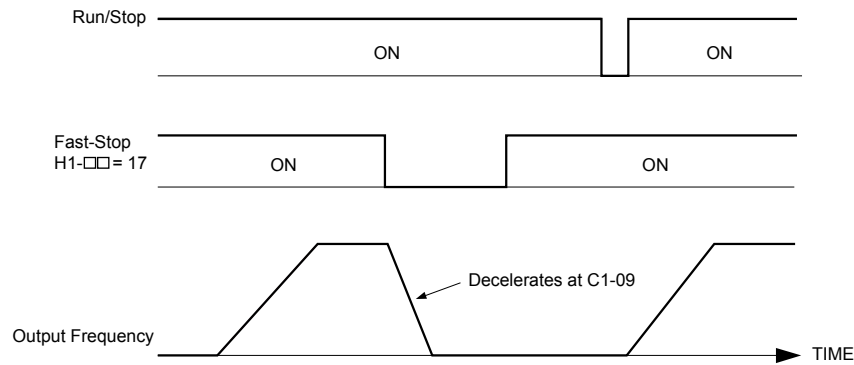

Figure 5.50 Fast-stop Sequence

NOTICE: Rapid deceleration can trigger an overvoltage fault. When faulted, the drive output shuts off, and the motor coasts. To avoid this uncontrolled motor state and to ensure that the motor stops quickly and safely, set an appropriate Fast-stop time to C1-09.

Setting 16: Motor 2 Selection

The drive has the capability to control two motors independently. A second motor may be selected using a multi-function digital input (H1-□□ = 16) as shown in [Figure 5.51](#).

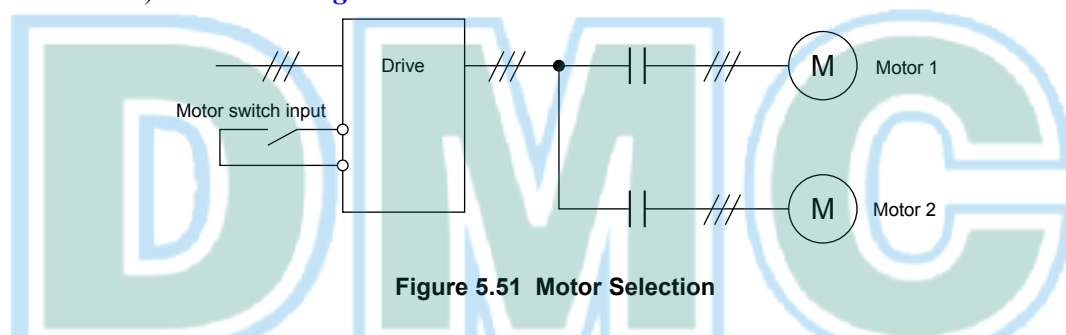

Figure 5.51 Motor Selection

Motor 2 is selected when the input set for Motor 2 Selection closes. When operating motor 2,

- E3-□□ and E4-□□ become valid for motor control. [Refer to E3: V/f Characteristics for Motor 2 on page 175](#) and [Refer to E4: Motor 2 Parameters on page 176](#) for details.
- Accel/decel times set in parameters C1-05/06/07/08 are activated ([Refer to C1-01 to C1-08: Accel/Decel Times 1 to 4 on page 147](#) for details).
- E4-14 is used as gain for slip compensation instead of C3-01.
- E4-15 is used as gain for torque compensation instead of C4-01.
- A digital output programmed for “Motor 2 Selection” (H2-01/02/03 = 1C) will be switched on.

- Note:**
1. When using 2 motors, the motor overload protection selection (oL1) set to L1-01 applies to both motor 1 and motor 2.
 2. It is not possible to switch between motor 1 and motor 2 during run. Doing so will trigger a "rUn" alarm.

Setting 18: Timer Function Input

This setting configures a digital input terminal as the input for the timer function. [Refer to b4: Delay Timers on page 135](#) for details.

Setting 19: PID Control Cancel

When the PID Function has been enabled by b5-01 (PID Mode Selection), it can be indefinitely disabled by closing a digital input configured as a PID Disable (H1-□□ = 19). When the input is released, the drive resumes PID operation. [Refer to PID Block Diagram on page 138](#) for more information on this function.

Setting 1A: Accel/Decel Time Selection 2

Used to select accel/decel times 3 and 4 in combination with the Accel/Decel Time Selection 1 command. [Refer to C1-01 to C1-08: Accel/Decel Times 1 to 4 on page 147](#) for details.

Setting 1B: Program Lockout

When an input is programmed for Program Lockout, parameters values can be monitored but not changed as long as this input is open.

5.7 H: Terminal Functions

Setting 1E: Analog Frequency Reference Sample/Hold

This function allows the user to sample an analog frequency reference signal being input to terminal A1 or A2 and hold the frequency reference at the sampled level. Once the Analog Frequency Reference Sample/Hold function is held for at least 100 ms, the drive reads the analog input and changes the frequency reference to the newly sampled speed as illustrated in [Figure 5.52](#).

When the power is shut off and the sampled analog frequency reference is cleared, the frequency reference is reset to 0.

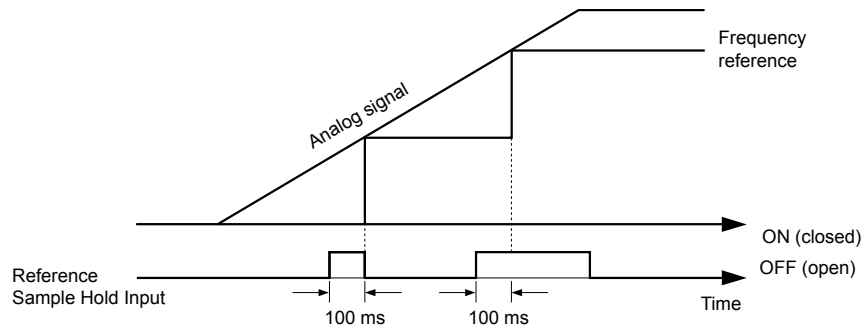

Figure 5.52 Analog Frequency Reference Sample/Hold

An oPE03 error will occur when one of the following functions is used simultaneously with the Analog Frequency Reference Sample/Hold function.

- Hold Accel/Decel Stop (setting: A)
- Up command, Down command (setting: 10, 11)
- Offset Frequency (setting: 44 to 46)
- Up or Down functions (setting: 75, 76)

Setting 20 to 2F: External Fault

By using the External Fault function, the drive can be stopped when problems occur with external devices.

To use the external fault function, set one of the multi-function digital inputs to any value between 20 to 2F. The operator will display EF□ where □ is the number of the terminal (terminal S□) to which the external fault signal is assigned.

For example, if an external fault signal is input to terminal S3, “EF3” will be displayed.

Select the value to be set in H1-□□ from a combination of any of the following three conditions:

- Signal input level from peripheral devices (N.O./N.C.)
- External fault detection method
- Operation after external fault detection

The following table shows the relationship between the conditions and the value set to H1-□□:

Setting	Terminal Status <1>		Detection Method <2>		Stopping Method			
	N.O.	N.C.	Always Detected	Detected during Run only	Ramp to Stop (fault)	Coast to Stop (fault)	Fast-stop (fault)	Alarm Only (continue running)
20	O		O		O			
21		O	O		O			
22	O			O	O			
23		O		O	O			
24	O		O			O		
25		O	O			O		
26	O			O		O		
27		O		O		O		
28	O		O				O	
29		O	O				O	
2A	O			O			O	
2B		O		O			O	

Setting	Terminal Status <1>		Detection Method <2>		Stopping Method			
	N.O.	N.C.	Always Detected	Detected during Run only	Ramp to Stop (fault)	Coast to Stop (fault)	Fast-stop (fault)	Alarm Only (continue running)
2C	O		O					O
2D		O	O					O
2E	O			O				O
2F		O		O				O

<1> Determine the terminal status for each fault, i.e., whether the terminal is normally open or normally closed.

<2> Determine whether detection for each fault should be enabled only during run or always detected.

Setting 30: PID Integral Reset

By configuring one of the digital inputs as an Integral Reset Input, (H1-□□ = 30), the value of the integral component of PID control can be reset to 0 whenever the configured input is closed. The integral component of PID control will be held at 0 as long as the configured digital input is held closed. [Refer to PID Block Diagram on page 138](#) for details.

Setting 31: PID Integral Hold

By configuring a digital input for Integral Hold (H1-0□ = 31), the value of the integral component of the PID control is locked as long as the input is active. The PID controller resumes integral operation from the hold value as soon as the integral hold input is released. [Refer to PID Block Diagram on page 138](#) for details.

Setting 32: Multi-Step Speed 4

Used to select the Multi-Step Speeds d1-09 to d1-16 in combination with the Multi-Step Speed inputs 1, 2 and 3. [Refer to d1-01 to d1-17: Frequency Reference 1 to 16 and Jog Reference on page 160](#) for details.

Setting 34: PID SFS Cancel

A digital input configured as a PID SFS Cancel input (H1-0□ = 34) can be used to enable or disable the PID soft starter and thereby canceling the Accel/Decel time b5-17. [Refer to PID Block Diagram on page 138](#) for details.

Function 35: PID Input Level Selection

An input programmed for this function can be used to switch the sign of the PID input. [Refer to PID Block Diagram on page 138](#) for more information on this function.

Setting 40/41: Forward Run/Reverse Run Command for 2-Wire Sequence

Sets the drive for 2-Wire sequence.

When the input set to 40 is closed, the drive operates in the forward direction. When the input set for 41 is closed, the drive will operate in reverse. Closing both inputs at the same time will result in an external fault.

- Note:**
1. This function cannot be used simultaneously with settings 42 and 43.
 2. These functions are assigned to the terminals S1 and S2 when the drive is initialized for 2-Wire sequence.
 3. Software versions PRG: 1013 and later require that both Forward run and Reverse Run commands be set at the same time.

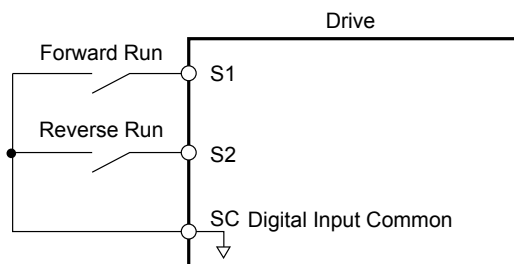

Figure 5.53 Example Wiring Diagram for 2-Wire Sequence

Setting 42/43: Run and Direction Command for 2-Wire Sequence 2

Sets the drive for 2-Wire sequence 2.

When the input programmed for 42 is closed, the drive will operate in the selected direction. When the input opens, the drive will stop. The input programmed for 43 selects the direction. If it is open, forward direction is selected; if it is closed, reverse direction is selected.

- Note:** This function cannot be used simultaneously with settings 40 and 41.

5.7 H: Terminal Functions

Setting 44/45/46: Offset Frequency 1/2/3 Addition

These inputs can be used to add offset frequencies d7-01, d7-02, and d7-03 to the frequency reference. [Refer to d7-01 to d7-03: Offset Frequency 1 to 3 on page 167](#) for details.

Setting 47: Node Setup

If the SI-S3/V option unit is connected, closing this terminal sets a node address for operation on a CANopen network.

Setting 60: DC Injection Braking

When a DC Injection Braking command is input while the drive is stopped, DC Injection Braking operation is activated. When a Run command or a Jog command is input, DC Injection Braking is released. [Refer to b2: DC Injection Braking on page 128](#) for details on setting up the DC braking function.

The diagram below illustrates the DC Injection Braking function.

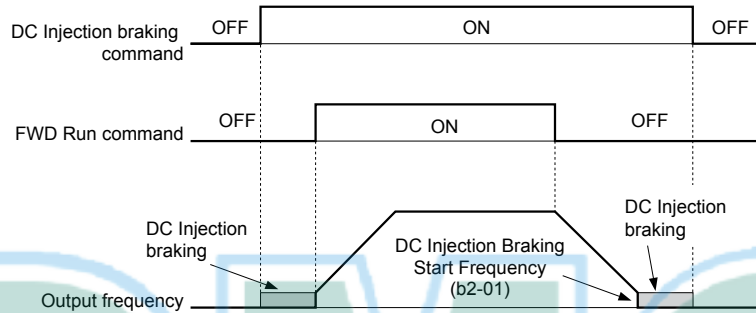

Figure 5.54 DC Injection Braking Input Timing Diagram

Setting 61/62: Speed Search 1/2

These input functions can be used to enable Speed Search even if parameter b3-01 = 0 (no Speed Search at start. [Refer to Activation of Speed Search on page 132](#) for details on how to use the input signals.

If b3-24 is set to 0 and b3-01 is set to 0, when the input terminal set for Speed Search 1 (H1-□□ = 61) is enabled, Speed Search will begin looking for the motor speed from the maximum output frequency. If the Speed Search 2 input (H1-□□ = 62) is enabled, Speed Search starts looking for the motor speed starting at the frequency reference. [Refer to b3: Speed Search on page 130](#) for more information about Speed Search.

Note: Operator error oPE03 will result if both Speed Search 1 and Speed Search 2 are set to the input terminals at the same time.

Setting 65/66: KEB Ride-Thru 1 (N.C.)/2 (N.O.)

A digital input programmed for this function can be used to activate the KEB 1 function and detect power supply return.

Description	Digital Inputs	
	Setting 65 (N.C.)	Setting 66 (N.O.)
KEB 1 deceleration	Open	Closed
Normal operation	Closed	Open

[Refer to Kinetic Energy Backup \(KEB\) Function on page 219](#) for details on how to use these input settings.

Setting 67: Communication Test Mode

The drive has a built-in function for self-diagnosing the serial communications operation. The test involves wiring the send and receive terminals of the RS-485/RS-422 port together. The drive transmits data and then confirms the communications are received normally. [Refer to Self-Diagnostics on page 461](#) for details on how to use this function.

Setting 68: High Slip Braking

Closing an input programmed for this function triggers High Slip Braking. Once HSB is started, the drive has to completely stop and the HSB input has to be removed before a restart can be performed. [Refer to n3: High Slip Braking \(HSB\)/Overexcitation Deceleration on page 241](#) for details on High Slip Braking.

Setting 6A: Drive Enable

A digital input configured as a Drive Enable input (H1-□□ = 6A) will prevent the drive from executing a Run command until the input is closed. When the Drive Enable input is open, the digital operator will display “dnE” to indicate that the drive is disabled.

If a Run command is closed prior to the Drive Enable input being closed, then the drive will not run until the Run command is cycled. If the Drive Enable input is opened while the drive is running, the drive will stop using the method set by parameter b1-03 (*Refer to b1-03: Stopping Method Selection on page 124* for details).

Setting 75/76: Up/Down 2

The Up/Down 2 function can be used to add a bias to the frequency reference. The input programmed for 75 will increase the bias and the input programmed for 76 will decrease it. *Table 5.27* explains how the Up/Down 2 function works depending on the frequency reference source and parameters d4-01, d5-03 and d4-05. *Refer to d4: Frequency Hold and Up/Down 2 Function on page 162* for detailed explanations of these and other Up/Down 2 related parameters.

- Note:**
1. The Up 2 and Down 2 functions must be set as a pair.
 2. When using the Up/Down 2 function, set appropriate bias limit values in parameters d4-08 and d4-09.

Table 5.27 Up/Down 2 Operations

Condition	Freq. Ref. Source	d4-03	d4-05	d4-01	Operation	Frequency Saved
1	Multi-Step Speed Reference	0	0	0	<ul style="list-style-type: none"> Accelerates (increases the bias) while the Up 2 function is closed 	Not saved
2				1	<ul style="list-style-type: none"> Decelerates (decreases the bias) while Down 2 is closed Holds output frequency (holds the bias) when no Up 2 or Down 2 input or both active. Resets the bias when the reference changes Operates with the frequency reference in all other situations. 	If the bias and frequency reference are constant for 5 s, the bias is added to the active frequency reference and reset afterwards.
3				1	--	<ul style="list-style-type: none"> Accelerates (increases the bias) while the Up 2 function is closed, Decelerates (decreases the bias) while Down 2 is closed. Otherwise operates at the frequency reference
4	Multi-Step Speed Reference	Value other than 0	--	0	<ul style="list-style-type: none"> When the Up 2 is enabled, drive accelerates up to the frequency reference plus d4-03 (bias is increased for d4-03). 	Not saved
5				1	<ul style="list-style-type: none"> When Down 2 is enabled, drive decelerates down to the frequency reference minus d4-03 (bias is decreased for d4-03). Holds output frequency (holds the bias) when no Up 2 or Down 2 input or both active. Resets the bias when the reference changes Operates with the frequency reference in all other situations. 	If the bias and frequency reference are constant for 5 s, the bias is added to the active frequency reference and reset afterwards.
6	Other (analog communications, etc.)	0	0	0	<ul style="list-style-type: none"> Accelerates (increases the bias) while the Up 2 function is closed Decelerates (decreases the bias) while Down 2 is closed 	Not saved
7				1	<ul style="list-style-type: none"> Holds output frequency (holds the bias) when no Up 2 or Down 2 input or both active. When during accel/decel. the frequency reference changes for more than d4-07, bias value is held until the output frequency meets the reference (speed agree). 	If the bias is constant for 5 s, it is saved to parameter d4-06. The frequency reference cannot be overwritten, so only the bias is saved.

5.7 H: Terminal Functions

Condition	Freq. Ref. Source	d4-03	d4-05	d4-01	Operation	Frequency Saved
8	Other (analog comms, etc.)	0	1	--	<ul style="list-style-type: none"> Accelerates (increases the bias) while the Up 2 function is closed, Decelerates (decreases the bias) while Down 2 is closed. Otherwise operates at the frequency reference 	Not saved
9		Value other than 0	--	0	<ul style="list-style-type: none"> When the Up 2 is enabled, drive accelerates up to the frequency reference plus d4-03 (increases the bias for d4-03). When Down 2 is enabled, drive decelerates down to the frequency reference minus d4-03 (decreases the bias for d4-03). When during accel/decel the frequency reference changes for more than d4-07, bias value is held until the output frequency meets the reference (speed agree). 	Not saved
10				1		If the bias is constant for 5 s, it is saved to parameter d4-06. The frequency reference cannot be overwritten, so only the bias is saved.

Setting 7A/7B: KEB Ride-Thru 2 (N.C./N.O.)

A digital input programmed for this function can be used to activate the KEB 2 function and detect power supply return.

Description	Digital Inputs	
	Setting 7A (N.C.)	Setting 7B (N.O.)
KEB 2 deceleration	Open	Closed
Normal operation	Closed	Open

Refer to Kinetic Energy Backup (KEB) Function on page 219 for details on how to use these input settings.

Setting 7C/7D: Short Circuit Braking (N.O./N.C.) (OLV/PM only)

An input programmed for this function can be used to activate Short Circuit Braking in Open Loop Vector Control for PM motors. By linking all three phases of a PM motor it creates a braking torque in a rotating motor and can be used to stop a rotating motor or prevent a motor from coasting by external forces (like windmill effect in fan applications etc.).

Description	Digital Inputs	
	Setting 7C (N.O.)	Setting 7D (N.C.)
Normal operation	Open	Closed
Short-Circuit Braking	Closed	Open

Setting 7E: Forward Reverse Detection (V/f Control with Simple PG Feedback)

When a digital input is programmed for this function, the input determines the direction of the speed feedback signal for V/f Control with PG feedback. If the input is open, the speed feedback signal is considered to be forward, if the input is closed, it is considered to be in reverse. *Refer to C5: Automatic Speed Regulator (ASR) on page 154* for details.

Setting 90 to 96: DriveWorksEZ Digital Inputs 1 to 7

These settings are for digital inputs functions used in DriveWorksEZ. Normally there is no need to change or apply these settings.

Setting 9F: DriveWorksEZ Function Disable

This function is used to enable or disable a DriveWorksEZ program in the drive. An input programmed for this function is effective only if A1-07 = 2.

Status	Description
Open	DriveWorksEZ enabled
Closed	DriveWorksEZ disabled

◆ H2: Multi-Function Output

■ H2-01 to H2-03: Terminal MA/MB/MC, P1/PC and P2/PC Function Selection

The drive has three multi-function output terminals. Set parameters H2-01 to H2-03 to values between 0 and 192 to assign functions to these terminals. Default values are listed in the following table.

No.	Parameter Name	Setting Range	Default
H2-01	Terminal MA, MB and MC Function Selection (relay)	0 to 192	E: Fault
H2-02	Terminal P1 Function Selection (open-collector)	0 to 192	0: During Run
H2-03	Terminal P2 Function Selection (open-collector)	0 to 192	2: Speed Agree 1

Note: Terminals that are not used and terminals using the through-mode should be set to “F”.

Table 5.28 Multi-Function Output Terminal Settings

Setting	Function	Page	Setting	Function	Page
0	During Run	195	1B	During Baseblock (N.C.)	202
1	Zero Speed	196	1C	Motor 2 Selection	202
2	Speed Agree 1	196	1E	Restart Enabled	202
3	User Set Speed Agree 1	196	1F	Motor Overload Alarm (oL1)	202
4	Frequency Detection 1	197	20	Drive Overheat Pre alarm (oH)	202
5	Frequency Detection 2	197	22	Mechanical Weakening	202
6	Drive Ready	198	2F <1>	Maintenance Period	202
7	DC Bus Undervoltage	198	30	During Torque Limit	202
8	During Baseblock (N.O.)	198	37	During Frequency Output	202
9	Frequency Reference Source	198	38	Drive Enable	203
A	Run Command Source	198	39	Watt Hour Pulse Output	203
B	Torque Detection 1 (N.O.)	198	3C	LOCAL/REMOTE Status	203
C	Frequency Reference Loss	199	3D	During Speed Search	203
D	Braking Resistor Fault	199	3E	PID Feedback Low	203
E	Fault	199	3F	PID Feedback High	203
F	Not used/Through Mode	199	4A	During KEB Operation	203
10	Alarm	199	4B	During Short-Circuit Braking	203
11	Reset Command Active	199	4C	During Fast-stop	203
12	Timer Output	199	4D	oH Pre-Alarm Time Limit	203
13	Speed Agree 2	199	4E <1>	Braking Transistor Fault (rr)	203
14	User Set Speed Agree 2	200	4F <1>	Braking Resistor Overheat (rH)	204
15	Frequency Detection 3	200	90	DriveWorksEZ Digital Output 1	204
16	Frequency Detection 4	201	91	DriveWorksEZ Digital Output 2	
17	Torque Detection 1 (N.C.)	198	92	DriveWorksEZ Digital Output 3	
18	Torque Detection 2 (N.O.)		100 to 192	H2 Parameter Functions Reversed Output Switching of 0 to 92	204
19	Torque Detection 2 (N.C.)	198			
1A	During Reverse Operation	201			

<1> Available in drive software versions PRG: 1016 and later.

Setting 0: During Run

Output closes when the drive is outputting a voltage.

Status	Description
Open	Drive is stopped.
Closed	A Run command is input or the drive is during deceleration or during DC injection.

5.7 H: Terminal Functions

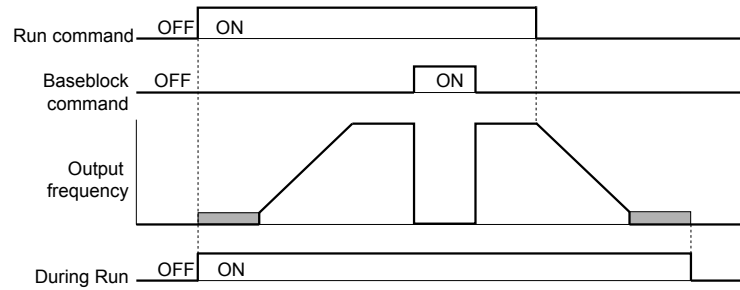

Figure 5.55 During Run Time Chart

Setting 1: Zero Speed

Terminal closes whenever the output frequency falls below the minimum output frequency set to E1-09.

Status	Description
Open	Output frequency is above the minimum output frequency set to E1-09
Closed	Output frequency is less than or equal to the minimum output frequency set to E1-09

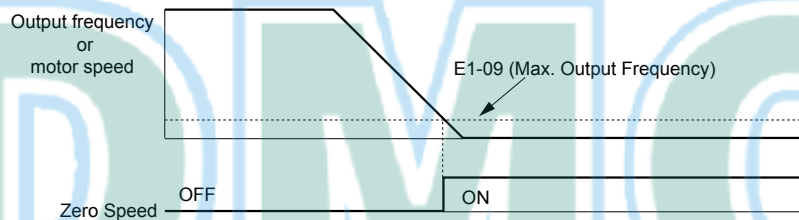

Figure 5.56 Zero-Speed Time Chart

Setting 2: Speed Agree 1 (f_{ref}/f_{out} Agree 1)

Closes whenever the actual output frequency is within the Speed Agree Width (L4-02) of the current frequency reference regardless of the direction.

Status	Description
Open	Output frequency does not match the frequency reference while the drive is running.
Closed	Output frequency is within the range of frequency reference \pm L4-02.

Note: Detection works in both directions, forward and reverse.

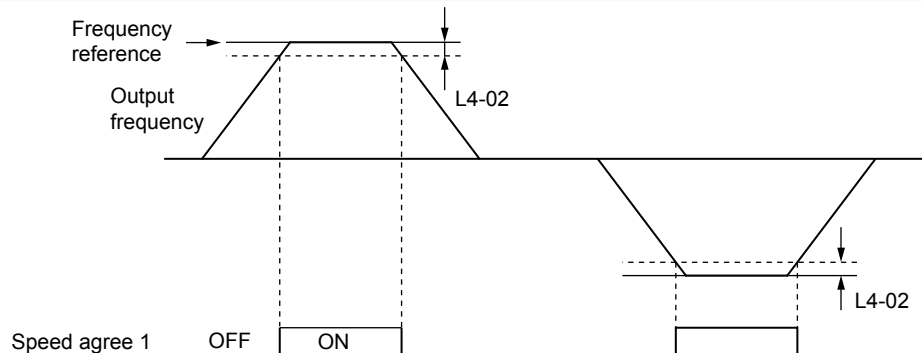

Figure 5.57 Speed Agree 1 Time Chart

Refer to L4-01/02: Speed Agreement Detection Level and Detection Width on page 227 for details on setting the detection width.

Setting 3: User Set Speed Agree 1 (f_{ref}/f_{set} Agree 1)

Closes whenever the actual output frequency and the frequency reference are within the Speed Agree Width (L4-02) of the programmed Speed Agree Level (L4-01).

Status	Description
Open	Output frequency or frequency reference are outside the range of $L4-01 \pm L4-02$.
Closed	Output frequency and the frequency reference are both within the range of $L4-01 \pm L4-02$.

Note: The detection works in both forward and reverse. The value of L4-01 will be used as the detection level for both directions.

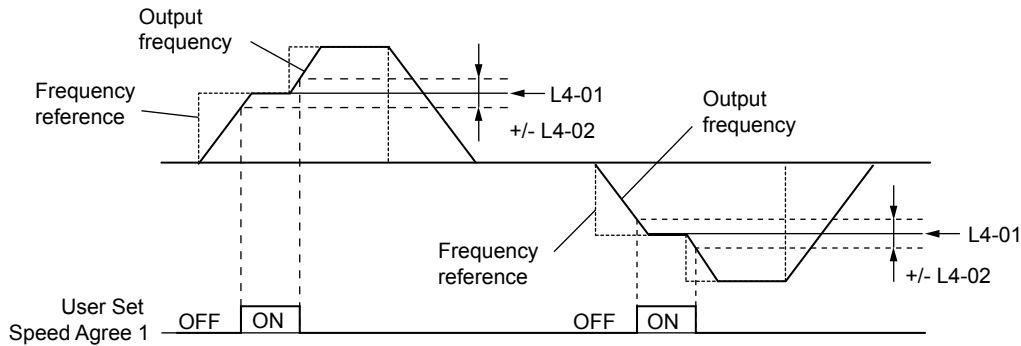

Figure 5.58 User Set Speed Agree 1 Time Chart

Refer to [L4-01/02: Speed Agreement Detection Level and Detection Width on page 227](#) for details on setting the detection width.

Setting 4: Frequency Detection 1

Output is closed as long as the output frequency is below the detection level set in L4-01 plus the hysteresis set in L4-02. It closes when the output frequency falls below L4-01.

Status	Description
Open	Output frequency exceeded $L4-01 + L4-02$.
Closed	Output frequency is below $L4-01$ or has not exceeded $L4-01 + L4-02$.

Note: The detection works in both forward and reverse. The value of L4-01 will be used as the detection level for both directions.

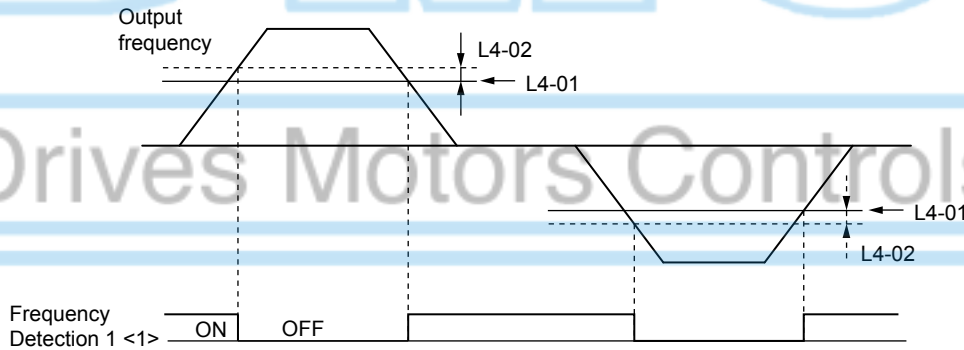

Figure 5.59 Frequency Detection 1 Time Chart

<1> This is the time chart when L4-07, Speed Agree Detection Selection, is set to 1 (Detection always enabled). The default setting for L4-07 is 0 (No detection during baseblock). When L4-07 is set to 0, the terminal opens during baseblock.

Refer to [L4-01/02: Speed Agreement Detection Level and Detection Width on page 227](#) for details on setting the detection width.

Setting 5: Frequency Detection 2

Output closes whenever the output frequency is equal to or above the detection level set in L4-01. The output opens when the output frequency falls below $L4-01$ minus the hysteresis set in L4-02.

Status	Description
Open	Output frequency is below $L4-01 - L4-02$ or has not exceeded $L4-01$.
Closed	Output frequency exceeded $L4-01$.

Note: The detection works in both forward and reverse. The value of L4-01 will be used as the detection level for both directions.

5.7 H: Terminal Functions

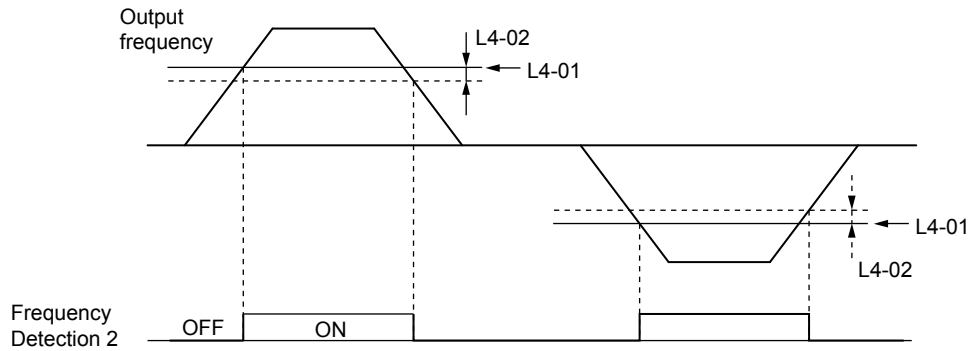

Figure 5.60 Frequency Detection 2 Time Chart

Refer to [L4-01/02: Speed Agreement Detection Level and Detection Width on page 227](#) for details on setting the detection width.

Setting 6: Drive Ready

Output closes whenever the drive is ready to operate the motor.

Status	Description
Open	During power up, initialization, fault or in Programming Mode (while b1-08 = 0 or 2).
Closed	Drive is ready for operation.

Refer to [b1-08: Run Command Selection while in Programming Mode on page 127](#) for details on the setting of b1-08.

Setting 7: DC Bus Undervoltage

Output closes whenever the DC bus voltage or control circuit power supply drops below the trip level. The undervoltage trip level is determined by L2-05. A fault in the DC bus charge circuit will also cause the DC Bus Undervoltage output to close.

Status	Description
Open	DC bus voltage is above the level set to L2-05
Closed	DC bus voltage has fallen below the trip level set to L2-05.

Setting 8: During Baseblock (N.O.)

Output closes to indicate that the drive is in a baseblock state. While Baseblock is executed, output transistors are not switched and no voltage will be output.

Status	Description
Open	Drive is not in a baseblock state.
Closed	Baseblock is being executed.

Setting 9: Frequency Reference Source

A digital output programmed for this function shows the frequency reference source that is currently selected.

Status	Description
Open	Frequency reference is provided from External Reference 1 (b1-01) or 2 (b1-15)
Closed	Frequency reference is being sourced from the digital operator.

Setting A: Run Command Source

A digital output programmed for this function shows the Run command source that is currently selected.

Status	Description
Open	Run command is provided from External Reference 1 (b1-02) or 2 (b1-16)
Closed	Run command is being sourced from the digital operator.

Setting B/17/18/19: Torque Detection 1 (N.O./N.C.) and Torque Detection 2 (N.O./N.C.)

These digital output functions can be used to signal an overtorque or undertorque situation to an external device.

Set up the torque detection and select the output function from the table below. Refer to [L6: Torque Detection on page 231](#) for details.

Setting	Status	Description
B	Closed	Torque Detection 1 (N.O.): Output current/torque exceeds (overtorque detection) or is below (undertorque detection) the torque value set in parameter L6-02 for longer than the time specified in parameter L6-03.
17	Open	Torque Detection 1 (N.C.): Output current/torque exceeds (overtorque detection) or is below (undertorque detection) the torque value set in parameter L6-02 for longer than the time specified in parameter L6-03.
18	Closed	Torque Detection 2 (N.O.): Output current/torque exceeds (overtorque detection) or is below (undertorque detection) the torque value set in parameter L6-05 for longer than the time specified in parameter L6-06.
19	Open	Torque Detection 2 (N.C.): Output current/torque exceeds (overtorque detection) or is below (undertorque detection) the torque value set in parameter L6-05 for longer than the time specified in parameter L6-06.

Setting C: Frequency Reference Loss

An output set for this function will be closed if frequency reference loss is detected. [Refer to L4-05: Frequency Reference Loss Detection Selection on page 227](#) for details.

Setting D: Dynamic Braking Resistor Overheat

An output programmed for this function will close when the dynamic braking resistor (DB) overheats or the braking transistor is in a fault condition.

Setting E: Fault

The Fault configured digital output will close whenever the drive experiences a fault (this excludes faults CPF00 and CPF01).

Setting F: Not Used

Use this setting when the terminal is not used or when using the terminal as a throughput.

When set to “F”, the output is not set by any drive function but it can be switched by a PLC via a communication option or MEMOBUS/Modbus communications (through mode).

Setting 10: Minor Fault

Output closes when a minor fault condition is present.

Setting 11: Reset Command Active

Output closes whenever there is an attempt to reset a fault situation from the control circuit terminals, via serial communications, or using a communications option card.

Setting 12: Timer Output

This setting configures a digital output terminal as output for the timer function. [Refer to b4: Delay Timers on page 135](#) for details.

Setting 13: Speed Agree 2 (f_{ref}/f_{out} Agree 2)

Closes whenever the actual output frequency is within the Speed Agree Width (L4-04) of the current frequency reference regardless of the direction.

Status	Description
Open	Output frequency does not match the frequency reference while the drive is running
Closed	Output frequency is within the range of frequency reference \pm L4-04

Note: The detection works in both forward and reverse.

5.7 H: Terminal Functions

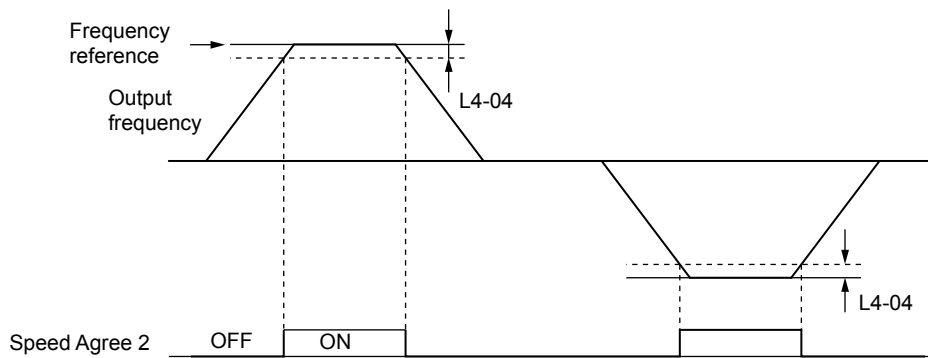

Figure 5.61 Speed Agree 2 Time Chart

Refer to L4-03/04: Speed Agreement Detection Level and Detection Width (+/-) on page 227 for details on setting the detection width.

Setting 14: User Set Speed Agree 2 (f_{ref} / f_{set} Agree 2)

Closes whenever the actual output frequency and the frequency reference are within the Speed Agree Width (L4-04) of the programmed Speed Agree Level (L4-03). As the detection level L4-03 is a signed value, detection works in the specified direction only.

Status	Description
Open	Output frequency or frequency reference are outside the range of $L4-03 \pm L4-04$
Closed	Output frequency and the frequency reference are both within the range of $L4-03 \pm L4-04$

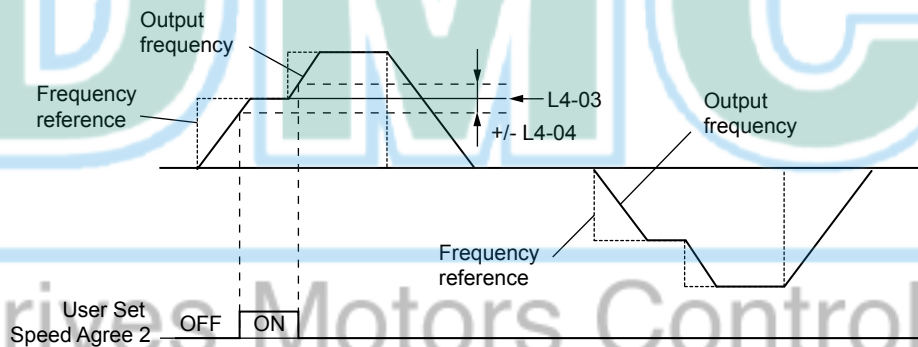

Figure 5.62 User Set Speed Agree 2 Example with Positive L3-04 Value

Refer to L4-03/04: Speed Agreement Detection Level and Detection Width (+/-) on page 227 for details on setting the detection width.

Setting 15: Frequency Detection 3

Output is closed as long as the output frequency is below the detection level set in L4-03 plus the hysteresis set in L4-04. It closes when the output frequency falls below L4-03. As the detection level L4-03 is a signed value, the detection works in the specified direction only.

Status	Description
Open	Output frequency exceeded $L4-03$ plus $L4-04$.
Closed	Output frequency is below $L4-03$ or has not exceeded $L4-03$ plus $L4-04$ yet.

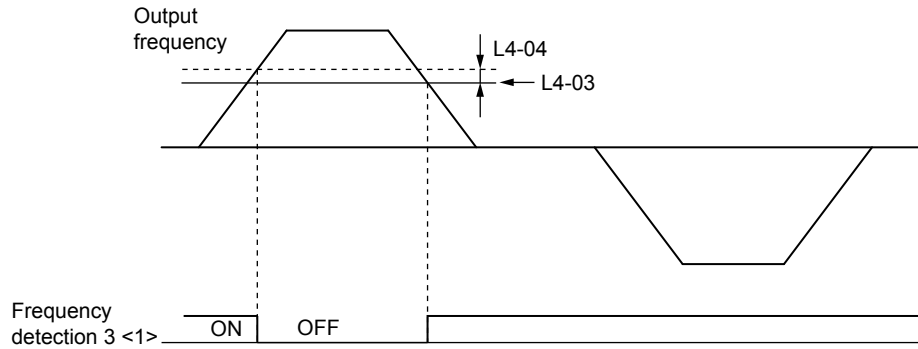

Figure 5.63 Frequency Detection 3 Example with Positive L3-04 Value

<1> This is the time chart when L4-07, Speed Agree Detection Selection, is set to 1 (Detection always enabled). The default setting for L4-07 is 0 (No detection during baseblock). When L4-07 is set to 0, the terminal opens during baseblock.

Refer to L4-03/04: Speed Agreement Detection Level and Detection Width (+/-) on page 227 for details on setting the detection width.

Setting 16: Frequency Detection 4

Output closes whenever the output frequency is equal to or above the detection level set in L4-03. The output opens when the output frequency falls below L4-03 minus the hysteresis set in L4-04. As the detection level L4-03 is a signed value, the detection works in the specified direction only.

Status	Description
Open	Output frequency is below L4-03 minus L4-04 or has not exceeded L4-03 yet.
Closed	Output frequency exceeded L4-03.

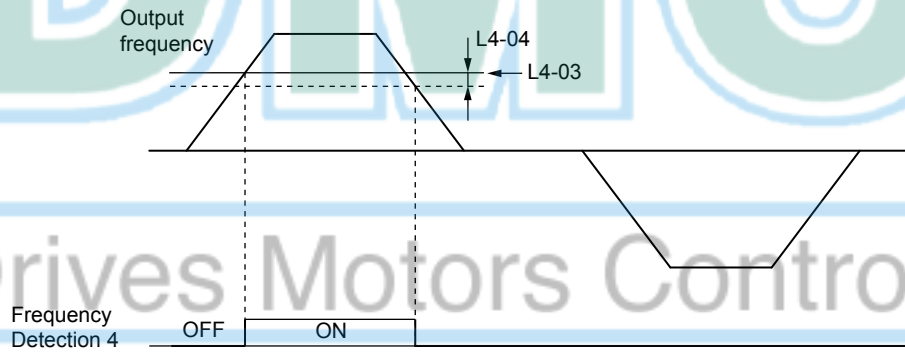

Figure 5.64 Frequency Detection 4 Example with Positive L3-04 Value

Refer to L4-03/04: Speed Agreement Detection Level and Detection Width (+/-) on page 227 for details on setting the detection width.

Setting 1A: During Reverse

The During Reverse digital output will close whenever the drive is turning the motor in the reverse direction.

Status	Description
Open	Motor is driven in the forward direction or stopped.
Closed	Motor is driven in reverse.

5.7 H: Terminal Functions

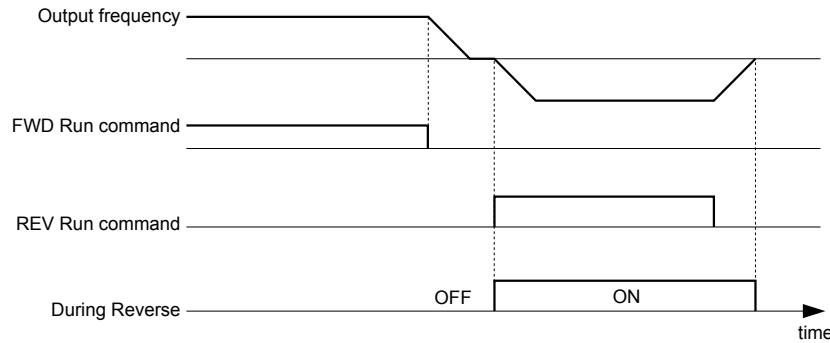

Figure 5.65 Reverse Direction Output Example Time Chart

Setting 1B: During Baseblock (N.C.)

Output opens to indicate that the drive is in a baseblock state. While Baseblock is executed, output transistors are not switched and no voltage is output.

Status	Description
Open	Baseblock is being executed.
Closed	Drive is not in a baseblock state.

Setting 1C: Motor 2 Selected

This output function shows the motor 1/2 selection status. [Refer to Setting 16: Motor 2 Selection on page 189](#) for details on switching motors.

Status	Description
Open	Motor 1 is selected.
Closed	Motor 2 is selected.

Setting 1E: Restart Enabled

The Restart Enabled output will be closed once the fault restart function becomes active and will remain closed until a successful restart is accomplished or the number of Auto Restart attempts as specified by L5-01 is reached. [Refer to L5: Fault Restart on page 230](#) for details on automatic fault restart.

Setting 1F: Motor Overload Alarm oL1

An output programmed for this function will be closed when the motor overload level estimated by the oL1 fault detection exceeds 90% of the oL1 detection level. [Refer to L1-01: Motor Overload Protection Selection on page 213](#) for details.

Setting 20: Drive Overheat Pre-alarm (oH)

Output closes whenever the drive heatsink temperature reaches the level specified by parameter L8-02. [Refer to L8-02: Overheat Alarm Level on page 235](#) for details on drive overheat detection.

Setting 22: Mechanical Weakening Detection

Output closes when mechanical weakening is detected. [Refer to Mechanical Weakening Detection on page 233](#) for details.

Setting 2F: Maintenance Period

The output closes when the cooling fan, DC bus capacitors, or DC bus pre-charge relay may require maintenance as determined by the estimated performance life span of those components.

Setting 30: During Torque Limit

Output closes when the motor is operating at the torque limit specified by the L7-□□ parameters or an analog input. This setting is only valid when using Open Loop Vector Control (A1-02 = 2). [Refer to L7-01/02/03/04: Torque Limits on page 234](#) for details.

Setting 37: During Frequency Output

Output closes when the drive is outputting a frequency.

Status	Description
Open	Drive is not outputting a frequency. One of the following functions is being performed: Stop, baseblock, DC injection braking (during initial excitation), short circuit braking.
Closed	Drive is outputting frequency.

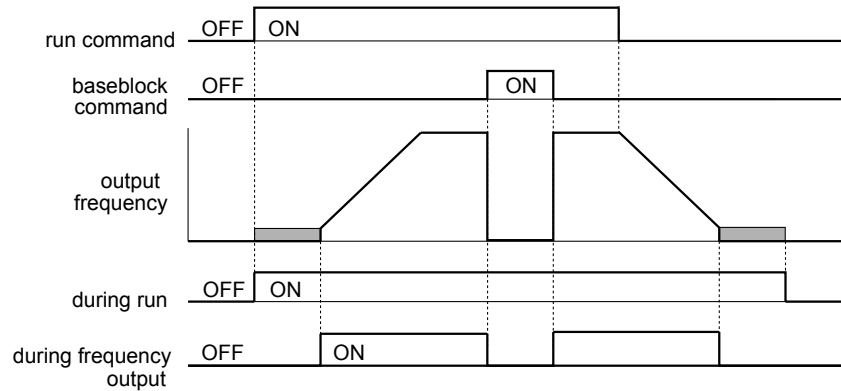

Figure 5.66 During Frequency Output Time Chart

Setting 38: Drive Enabled

A Drive Enable digital output will reflect the status of a digital input configured as a Drive Enable input (H1-□□ = 6A). If the Drive Enable digital input is closed then the Drive Enabled digital output will also close.

Setting 39: Watt Hour Pulse Output

Outputs a pulse to indicate the watt hours. [Refer to H2-06: Watt Hour Output Unit Selection on page 204](#) for details.

Setting 3C: LOCAL/REMOTE Status

Output terminal closes while the drive is set for LOCAL and opens when in REMOTE.

Status	Description
Open	REMOTE: The selected external reference (b1-01/b1-02 or b1-15/b1-16) is used as frequency reference and Run command source
Closed	LOCAL: The digital operator is used as frequency reference and Run command source

Setting 3D: During Speed Search

Output terminal closes while Speed Search is being performed. [Refer to b3: Speed Search on page 130](#) for details on the Speed Search function.

Setting 3E: PID Feedback Low

Output terminal closes when a PID feedback loss is detected. The feedback is considered to be lost if it falls below the level set to b5-13 for longer than the time set to b5-14. [Refer to PID Feedback Loss Detection on page 141](#) for details.

Setting 3F: PID Feedback High

Output terminal closes when a PID feedback loss is detected. The feedback is considered to be lost if it rises beyond the level set to b5-36 for longer than the time set to b5-37. [Refer to PID Feedback Loss Detection on page 141](#) for details.

Setting 4A: During KEB Operation

Output terminal closes while KEB is being performed. [Refer to Kinetic Energy Backup \(KEB\) Function on page 219](#) for a KEB function description.

Setting 4B: During Short Circuit Braking

Closes the output terminal while Short Circuit Braking is being executed.

Setting 4C: During Fast-stop

Output terminal closes when a Fast-stop is being executed. [C1-09: Fast-stop Time](#) for details.

Setting 4D: oH Pre-Alarm Time Limit

Output terminal closes when the drive is reducing the speed due to a drive overheat alarm (L8-03 = 4) and the overheat alarm has not disappeared after ten frequency reduction operation cycles. [Refer to L8-03: Overheat Pre-Alarm Operation Selection on page 235](#) for details.

Setting 4E: Braking Transistor Fault (rr)

The output closes when the internal braking transistor reaches the overheat level.

5.7 H: Terminal Functions

Setting 4F: Braking Resistor Overheat (rH)

The output closes when the braking resistor exceeds the overheat level. the braking resistor may overheat due to the motor regeneration or short deceleration time setting.

Setting 90 to 92: DriveWorksEZ Digital Output 1 to 3

These settings are for digital output functions used in DriveWorksEZ. Normally there is no need to change or apply these settings.

Setting 100 to 192: Reverse Switching for Functions 0 to 92

These settings reverse the switching status of the specified function. Set as 1□□, where the last two digits specify the setting number of the function to be reversed.

Examples:

- To reverse the output for “8: During Baseblock”, set “108”.
- To reverse the output for “4A: During KEB” set “14A”.

■ H2-06: Watt Hour Output Unit Selection

When one of the multi-function terminals is set to output the number of watt hours (H2-01/02/03 = 39), parameter H2-06 determines the units for the output signal.

The output is intended to drive a watt hour meter or a PLC input by a 200 ms pulse signal. A pulse is output according to the kWh unit selected in H2-06.

No.	Parameter Name	Setting Range	Default
H2-06	Watt Hour Output Unit Selection	0: 0.1 kWh units 1: 1 kWh units 2: 10 kWh units 3: 100 kWh units 4: 1000 kWh units	0

◆ H3: Multi-Function Analog Input Terminals

The drive is equipped with 2 multi-function analog input terminals, A1 and A2. The user can assign functions to these terminals by setting parameters H3-02 and H3-10 between 0 and 31.

■ H3-01: Terminal A1 Signal Level Selection

Selects the input signal level for analog input A1.

No.	Name	Setting Range	Default
H3-01	Terminal A1 Signal Level Selection	0 to 1	0

Setting 0: 0 to 10 Vdc with Limit

The input level is 0 to 10 Vdc. Negative input values will be limited to 0.

Example: Terminal A1 is set to supply the frequency reference, and the bias (H3-04) is set to -100%. The frequency reference can be set from 0 to 100% with an analog input of 5 to 10 V. The frequency reference will be zero when the analog input is between 0 and 5 V.

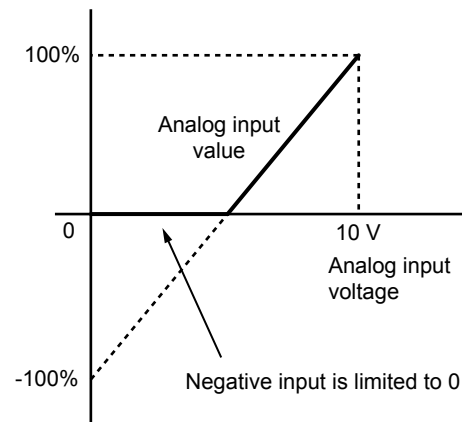

Figure 5.67 Analog Input with Limit (Bias Setting -100%)

Setting 1: 0 to 10 Vdc without Limit

The input level is 0 to 10 Vdc. Negative input values will be accepted.

Example: Terminal A1 is set to supply the frequency reference, and the bias (H3-04) is set to -100%. The frequency reference can be set from 0 to 100% with an analog input of 5 to 10 V. With an input of 0 to 5 V, the frequency reference can be set from -100% to 0%. The drive reverses the motor rotation with negative input.

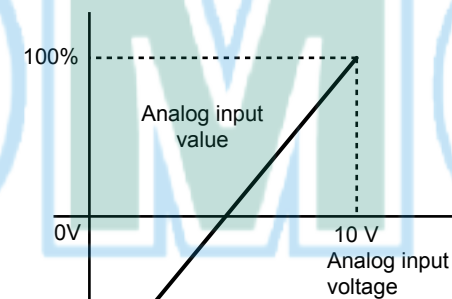

Figure 5.68 Analog Input without Limit (Bias Setting -100%)

■ H3-02: Terminal A1 Function Selection

Determines the function assigned to analog input terminal A1. *Refer to Multi-Function Analog Input Terminal Settings on page 208* for a list of functions and descriptions.

No.	Name	Setting Range	Default
H3-02	Terminal A1 Function Selection	0 to 31	0

Note: If not using an input terminal or if using it in the through-mode, be sure to set that terminal to “F”.

■ H3-03/H3-04: Terminal A1 Gain/Bias Setting

Parameter H3-03 sets the level of the selected input value that is equal to 10 Vdc input at terminal A1 (Gain).

Parameter H3-04 sets the level of the selected input value that is equal to 0 V input at terminal A1.

Both can be used to adjust the analog input A1 characteristics.

No.	Name	Setting Range	Default
H3-03	Terminal A1 Gain Setting	-999.9 to 999.9%	100.0%
H3-04	Terminal A1 Bias Setting	-999.9 to 999.9%	0.0%

5.7 H: Terminal Functions

Default Settings

Using the factory default settings for the analog input's function, gain, and bias, the 0 to 10 Vdc signal at the analog input will yield a 0 to 100% frequency reference span.

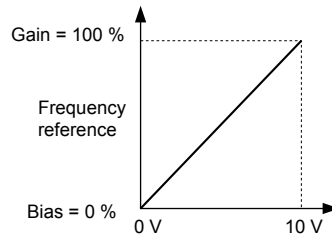

Figure 5.69 Analog Input A1 Default Characteristics

Setting Examples

- Gain H3-03 = 200%, A1 as frequency reference input:

An input 10 Vdc will be equivalent to a 200% frequency reference and 5 Vdc will be equivalent to a 100% frequency reference. Since the drive output is limited by the maximum frequency parameter (E1-04), the frequency reference will be equal to E1-04 above 5 Vdc.

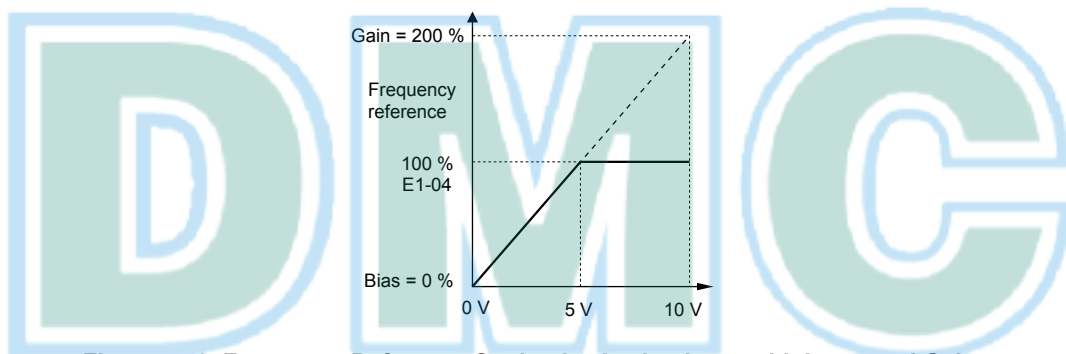

Figure 5.70 Frequency Reference Setting by Analog Input with Increased Gain

- Bias H3-04 = -25%, A1 as frequency reference input

An input of 0 Vdc will be equivalent to a -25% frequency reference.

When parameter H3-01 = 0 the minimum frequency reference is 0% between 0 and 2.5 Vdc input. An analog input of 2.5 to 10 Vdc will now be the same as 0 to 100% of the frequency reference span.

When parameter H3-01 = 1, the motor will rotate in reverse between 0 and 2.5 Vdc input.

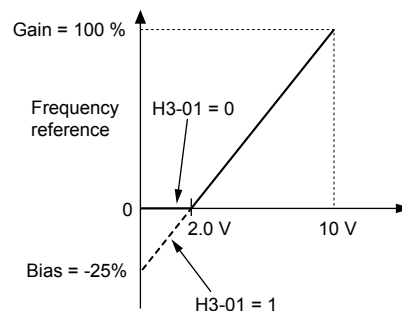

Figure 5.71 Frequency Reference Setting by Analog Input with Negative Bias

- Gain = 0%, Bias = 100%, A1 as frequency reference input

This setting leads to an inverse-acting frequency reference. The minimum analog input level (0 Vdc) will produce a 100% frequency reference and the maximum analog input level (10 Vdc) will produce a 0% frequency reference.

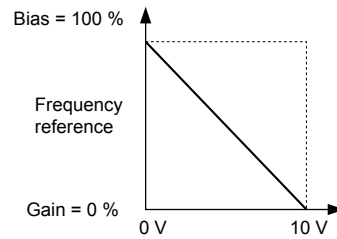

Figure 5.72 Frequency Reference Setting by Analog Input with Inverse Gain and Bias Settings

■ H3-09: Terminal A2 Signal Level Selection

Selects the input signal level for analog input A2. Be sure to also set DIP switch S1 on the terminal board accordingly for a voltage input or current input.

No.	Name	Setting Range	Default
H3-09	Terminal A2 Signal Level Selection	0 to 3	2

Setting 0: 0 to 10 Vdc with Lower Limit

The input level is 0 to 10 Vdc. Negative input values will be limited to 0. Refer to the explanation of H3-01, Setting 0. [Refer to Setting 0: 0 to 10 Vdc with Limit on page 204](#)

Setting 1: 0 to 10 Vdc without Lower Limit

The input level is 0 to 10 Vdc. Negative input values will be accepted. Refer to the explanation of H3-01, Setting 1. [Refer to Setting 1: 0 to 10 Vdc without Limit on page 205](#)

Setting 2: 4 to 20 mA Current Input

The input level is 4 to 20 mA. Negative input values by negative bias or gain settings will be limited to 0 (like setting 0).

Setting 3: 0 to 20 mA Current Input

The input level is 0 to 20 mA. Negative input values by negative bias or gain settings will be limited to 0 (like setting 0).

■ H3-10: Terminal A2 Function Selection

Determines the function assigned to analog input terminal A2. [Refer to Multi-Function Analog Input Terminal Settings on page 208](#) for a list of functions and descriptions.

No.	Name	Setting Range	Default
H3-10	Terminal A2 Function Selection	0 to 31	0

■ H3-11/H3-12: Terminal A2 Gain/Bias Setting

Parameter H3-11 sets the level of the selected input value that is equal to 10 Vdc/20 mA input at terminal A2 (Gain).

Parameter H3-12 sets the level of the selected input value that is equal to 0 Vdc/4 mA/0 mA input at terminal A2.

Both can be used to adjust the analog input A2 characteristics. The setting works in the same way as parameters H3-03/04 for analog input A1.

No.	Name	Setting Range	Default
H3-11	Terminal A2 Gain Setting	-999.9 to 999.9%	100.0%
H3-12	Terminal A2 Bias Setting	-999.9 to 999.9%	0.0%

■ H3-13: Analog Input Filter Time Constant

Parameter H3-13 sets the time constant for a first order filter that will be applied to both analog inputs A1 and A2.

No.	Name	Setting Range	Default
H3-13	Analog Input Filter Time Constant	0.00 to 2.00 s	0.03 s

An analog input filter can be used to prevent erratic drive control when a “noisy” analog reference is used. The drive operation becomes more stable the longer the time programmed, but it becomes less responsive to rapidly changing analog signals.

Multi-Function Analog Input Terminal Settings

This section describes the various functions that can be assigned to terminals A1 and A2 by setting H3-02 and H3-10.

Note: The scaling of all input functions depends on the gain and bias settings for the analog inputs. Set these to appropriate values when selecting and adjusting analog input functions.

Table 5.29 Multi-Function Input Terminal Settings

Setting	Function	Page	Setting	Function	Page
0	Frequency Bias	208	10	Forward Torque Limit	209
1	Frequency Gain	208	11	Reverse Torque Limit	
2	Auxiliary Frequency Reference	208	12	Regenerative Torque Limit	
4	Output Voltage Bias	208	15	General Torque Limit	209
7	Overtorque/Undertorque Detection Level	208	16	Differential PID Feedback	
B	PID Feedback	208	30	DriveWorksEZ Analog Input 1	209
C	PID Set Point	208	31	DriveWorksEZ Analog Input 2	
E	Motor Temperature (PTC input)	208	41 <I>	Output Voltage Gain	209
F	Not used/Through Mode	209			

<I> Available in drive software versions PRG: 1016 and later.

Setting 0: Frequency Bias

The input value of an analog input set to this function will be added to the analog frequency reference value. Use this setting also when only one analog input is used to supply the frequency reference.

By default both analog inputs A1 and A2 are set for this function. Using both A1 and A2 at the same time increases the frequency reference by the total of both inputs.

Example: If the analog frequency reference by analog input A1 is 50% and a bias of 20% is applied by analog input A2, the resulting frequency reference will be 70% of the maximum output frequency.

Setting 1: Frequency Gain

The input value of an analog input set to this function will be multiplied with the analog frequency reference value.

Example: If the analog frequency reference from analog input A1 is 80% and a gain of 50% is applied from analog input A2, the resulting frequency reference will be 40% of the maximum output frequency.

Setting 2: Auxiliary Reference

Sets the auxiliary frequency reference when Multi-Step Speed operation is selected. [Refer to Multi-Step Speed Selection on page 160](#) for details.

Setting 4: Voltage Bias

Voltage bias boosts the output voltage of the V/f curve as a percentage of the maximum output voltage (E1-05). Available only when using V/f Control.

Setting 7: Overtorque/Undertorque Level

Overtorque level sets the overtorque/undertorque detection level using the analog input. This works with Torque Detection Selection 1 (L6-01) and will take the place of the torque detection level set to L6-02. For general Open Loop Vector Control, this function is based on 100% of the motor rated torque. For V/f Control and PM Open Loop Vector, this function is based on 100% of the drive rated current. [Refer to L6: Torque Detection on page 231](#) for details on torque detection.

Setting B: PID Feedback

An input set for this function supplies the PID feedback value. This setting requires PID operation to be enabled in b5-01. [Refer to PID Feedback Input Methods on page 137](#).

Setting C: PID Setpoint

An input set for this function supplies the PID setpoint value. The frequency reference selected in parameter b1-01 no longer becomes the PID setpoint. This setting requires PID operation to be enabled in b5-01. [Refer to PID Setpoint Input Methods on page 137](#).

Setting E: Motor Temperature

In addition to or in place of the oL1 (motor overload) fault detection, it is possible to use a PTC (Positive Temperature Coefficient) thermistor for motor insulation protection. [Refer to Motor Protection Using a Positive Temperature Coefficient \(PTC\) on page 215](#) for detailed explanations.

Setting F: Not Used

Any analog input that is not used should be set to F. When set to “F”, an input does not affect any drive function but the input level can be read out by a PLC via a communication option or MEMOBUS/Modbus communications (through mode). This way drive analog inputs can be used to read out external sensor values if there is a lack of PLC analog inputs.

Setting 10/11/12/15: Positive/Negative/Regenerative/General Torque Limit (OLV only)

These functions make it possible to limit the torque reference with an analog input. The limit can either be set as a general value for all operation conditions (setting 15) or can be programmed separately for each operation condition (quadrants 1, 2, 3, and 4). [Figure 5.73](#) shows which limit is applied in each quadrant. The lowest of the values will always be used as the limit. The value is set as a percentage of the motor rated torque. [Refer to L7: Torque Limit on page 234](#) for information how torque limits work.

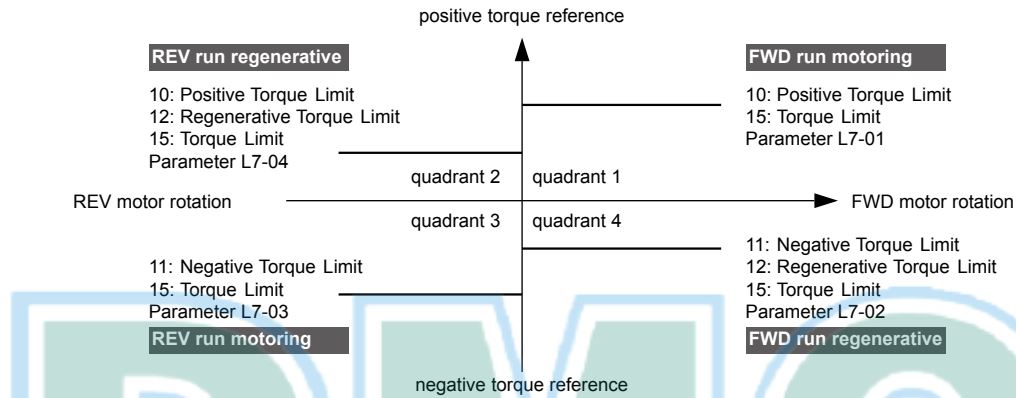

Figure 5.73 Analog Input Torque Limits

Setting 16: Differential PID Feedback

If an analog value is set for this function, the PID controller is set for differential feedback. The subtraction of the PID feedback input value and the differential feedback input value builds the feedback value that is used to calculate the PID input. [Refer to PID Feedback Input Methods on page 137](#).

Setting 30/31: DriveWorksEZ Analog Input 1/2

These settings are for analog output functions used in DriveWorksEZ. Normally there is no need to change or apply these settings.

Setting 41: Output Voltage Gain

Allows the user to change the output voltage by adjusting the voltage reference via one of the analog input terminals or with MEMOBUS/Modbus.

An internal 0.3 second delay has been added to prevent sudden, drastic change to the V/f pattern.

Note: When an input terminal is assigned to adjust the Output Voltage Gain (H3-□□ = 41), a voltage reference from MEMOBUS/Modbus is ignored.

■ H3-14: Analog Input Terminal Enable Selection

Note: Parameter available in drive software versions PRG: 1016 and later.

Determines which of the analog input terminals will be enabled or disabled when a digital input programmed for “Analog input enable” (H1-□□ = C) is closed. When H1-□□ ≠ C, all of the input terminals are enabled all of the time. Terminals not set as the target are not influenced by input signals.

No.	Name	Setting Range	Default
H3-14	Analog Input Terminal Enable Selection	1, 2, 7	7

Setting 1: Terminal A1 only

Setting 2: Terminal A2 only

Setting 7: All Terminals Enabled

■ H3-16/H3-17: Terminal A1/A2 Offset

Note: Parameters available in drive software versions PRG: 1016 and later.

Determines the amount of offset to be used to calibrate analog input signals from the terminals A1 and A2.

5.7 H: Terminal Functions

Enter a 0 V signal to terminal A1. Next adjust the offset in H3-16 until the monitor U1-13 for the terminal A1 input voltage reads 0.0%.

The process is the same for terminal A2. Enter a 0 V signal, and adjust the offset for terminal A2 in H3-17 until the monitor U1-14 for terminal A2 input voltage reads 0.0%.

No.	Name	Setting Range	Default
H3-16	Terminal A1 Offset	-500 to 500	0
H3-17	Terminal A2 Offset	-500 to 500	0

◆ H4: Multi-Function Analog Output Terminals

These parameters assign a function to analog output terminal AM for monitoring a specific aspect of drive performance.

■ H4-01: Multi-Function Analog Terminal AM Monitor Selection

Sets the desired drive monitor parameter U□-□□ to output as an analog value via terminal AM. *Refer to U: Monitors on page 399* for a list of all monitors. The “Analog Output Level” columns indicates if a monitor can be applied for analog output.

Example: Enter “103” for U1-03.

No.	Name	Setting Range	Default
H4-01	Multi-Function Analog 1 (Terminal AM Monitor Selection)	000 to 999	102

A setting of 031 or 000 applies no drive monitor to the analog output. With this setting the terminal AM output level can be set by a PLC via a communication option or MEMOBUS/Modbus communications (through mode).

■ H4-02/H4-03: Multi-Function Analog Output Terminal AM Gain/Bias

Parameter H4-02 sets the output voltage that is equal to 100% of the monitor value. Parameter H4-03 sets the output voltage equal to 0% of the monitor value.

Both values are set as a percentage of 10 V. The minimum output voltage for terminal AM is 0 V, the maximum is 10 Vdc. *Figure 5.74* illustrates the function of the gain and bias settings.

No.	Name	Setting Range	Default
H4-02	Multi-Function Analog Output Terminal AM Gain	-999.9 to 999.9%	100.0%
H4-03	Multi-Function Analog Output Terminal AM Bias	-999.9 to 999.9%	0.0%

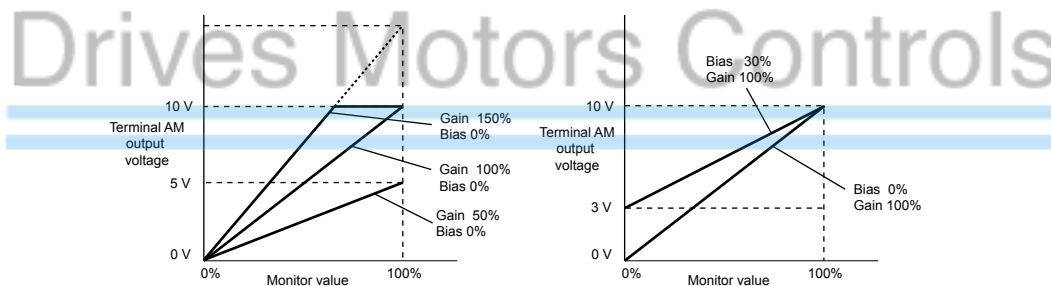

Figure 5.74 Analog Output Gain/Bias Setting

When viewing the settings for H4-02, terminal AM will output a voltage that is equal to 100% of the monitor value (considering the present setting). When viewing the settings for H4-03, terminal AM will output a voltage that is equal to 0% of the monitor value.

◆ H5: MEMOBUS/Modbus Serial Communication

Through the drives built in RS-422/485 port (terminals R+, R-, S+, S-), serial communication can be performed with programmable logic controllers (PLCs) or similar devices using the MEMOBUS/Modbus protocol.

The H5-□□ parameters are used to set up the drive for MEMOBUS/Modbus Communications. *Refer to MEMOBUS/Modbus Serial Communication on page 439* for detailed descriptions of the H5-□□ parameters.

◆ H6: Pulse Train Input/Output

A one track pulse train signal with a maximum frequency of 32 kHz can be input to the drive at terminal RP. This pulse train signal can be used as the frequency reference, for PID functions, or as the speed feedback signal in V/f Control.

The pulse output monitor terminal MP, which can be used in sinking or sourcing mode, can output drive monitors values as a pulse train signal with a maximum frequency of 32 kHz.

Use parameters H6-□□ to scale and set up the function for the pulse input terminal RP and pulse output terminal MP.

■ H6-01: Pulse Train Input Terminal RP Function Selection

Selects the function of pulse train input terminal RP.

No.	Name	Setting Range	Default
H6-01	Pulse Train Input Terminal RP Function Selection	0 to 4	0

Setting 0: Frequency Reference

If the pulse input is set for this function and the frequency reference source is set to pulse input (b1-01/15 = 4), the drive reads the frequency value from terminal RP.

Setting 1: PID Feedback Value

Using this setting, the feedback value for PID control can be supplied as a pulse signal at terminal RP. *Refer to b5: PID Control on page 136* for details on PID control.

Setting 2: PID Setpoint Value

Using this setting, the setpoint value for PID control can be supplied as a pulse signal at terminal RP. *Refer to b5: PID Control on page 136* for details on PID control.

Setting 3: Speed Feedback for V/f Control (V/f Control only, Motor 1 only)

This setting enables simple speed feedback for V/f Control. A pulse signal can be used to input the motor speed to the drive and thereby improve the speed control accuracy. Note that this speed feedback can only be a one track signal that cannot be used for direction detection. The drive needs a separate motor rotation direction signal. *Refer to C5: Automatic Speed Regulator (ASR) on page 154* for details on using Simple V/f Control with Speed Feedback.

■ H6-02: Pulse Train Input Terminal RP Scaling

The pulse train input scaling parameter sets the terminal RP input frequency that is equal to 100% of the signal selected as the input value in parameter H6-01.

No.	Name	Setting Range	Default
H6-02	Pulse Train Input Scaling	<1>	1440 Hz

<1> Setting range is determined by drive software version.

PRG: 1016 and later: 100 to 32000 Hz

PRG: 1015 and earlier: 1000 to 32000 Hz

■ H6-03: Pulse Train Input Terminal RP Gain

Sets the level of the value selected in H6-01 when a pulse train signal with the frequency set in H6-02 is input to terminal RP.

No.	Name	Setting Range	Default
H6-03	Pulse Train Input Gain	0.0 to 1000.0%	100.0%

■ H6-04: Pulse Train Input Terminal RP Bias

Sets the level of the value selected in H6-01 when a 0 Hz signal is input to terminal RP.

No.	Name	Setting Range	Default
H6-04	Pulse Train Input Bias	-100.0 to 100.0%	0.0%

■ H6-05: Pulse Train Input Terminal RP Filter Time

Sets the pulse train input filter time constant in seconds.

The pulse train input filter helps prevent noise interference from causing erroneous operation when operating the drive within the pulse train signal.

5.7 H: Terminal Functions

Increasing the filter setting time increases the effectiveness of the noise prevention, however, this also increasingly slows drive response time.

No.	Name	Setting Range	Default
H6-05	Pulse Train Input Filter Time	0.00 to 2.00 s	0.10 s

■ H6-06: Pulse Train Output Terminal MP Monitor Selection

Selects the pulse train monitor output terminal MP function. The set value $\square\square\square$ is equal to the numerals in U \square - $\square\square$ of the selected monitor. *Refer to U: Monitors on page 399* for a complete list of monitors. Selectable monitor items are listed below.

No.	Name	Setting Range	Default
H6-06	Pulse Train Output Terminal MP Monitor Selection	000, 031, 101, 102, 105, 116, 501, 502, 801 to 809	102

■ H6-07: Pulse Train Output Terminal MP Monitor Scaling

Pulse train monitor scaling sets the output frequency at terminal MP when the monitor item is 100%. Set H6-06 to 102 and H6-07 to 0 to make the pulse train monitor output synchronous to the output frequency.

No.	Name	Setting Range	Default
H6-07	Pulse Train Input Monitor Scaling	0 to 32000 Hz	1440 Hz



5.8 L: Protection Functions

◆ L1: Motor Protection Functions

■ L1-01: Motor Overload Protection Selection

The drive has an electronic overload protection function that estimates the motor overload level based on output current, output frequency, thermal motor characteristics, and time. An oL1 fault will be triggered when motor overload is detected.

L1-01 sets the overload protection function characteristics according to the motor being used.

No.	Name	Setting Range	Default
L1-01	Motor Overload Protection Selection	0 to 4; 6 </>	A1-02 dependent

<1> Setting 6 is available in drive software versions PRG: 1016 and later.

- Note:**
- When the motor protection function is enabled (L1-01 is not set to zero), an oL1 alarm can be output through one of the multi-function outputs by setting H2-01 to 1F. The output will close when the motor overload level reaches 90% of the oL1 detection level.
 - Select a method to protect the motor from overheat by setting L1-01 to a value between 1 and 4; use setting 6 when running a single motor from the drive. An external thermal relay is not required.

Setting 0: Disabled - Motor Overload Protection is not Provided

This setting should be used if no motor overheat protection is desired or if multiple motors are connected to one drive. In this case it is recommended that you install a thermal relay for each motor as show in [Figure 5.75](#)

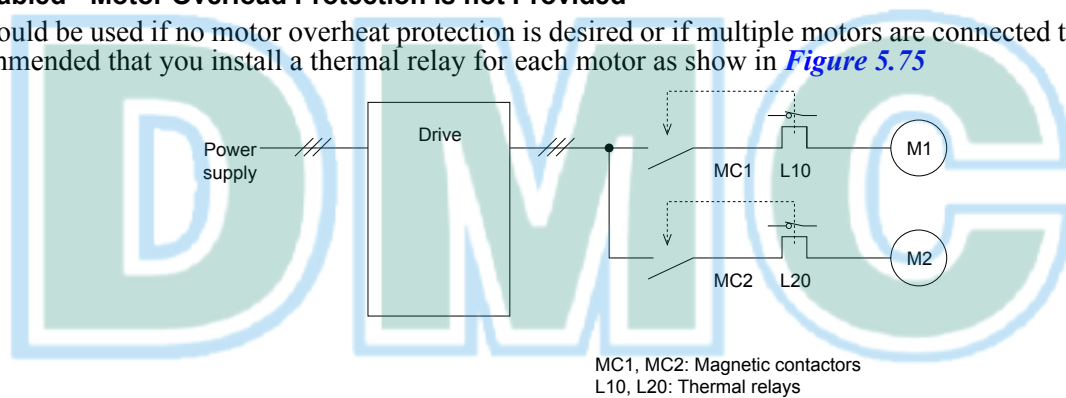

Figure 5.75 Example of Protection Circuit Design for Multiple Motors

NOTICE: Protect each motor with individual thermal overloads when multiple motors are connected to one drive. Failure to comply could result in motor damage. Disable the electronic overload protection of the drive (L1-01 = "0: Disabled") and protect each motor with individual motor thermal overloads.

Setting 1: General Purpose Motor (standard self-cooled)

Because the motor is self-cooled, the overload tolerance drops when the motor speed is lowered. The drive appropriately adjusts the electrothermal trigger point according to the motor overload characteristics, protecting the motor from overheat throughout the entire speed range.

Overload Tolerance	Cooling Ability	Overload Characteristics
<p>Torque (%)</p> <p>Speed (%)</p> <p>Rated Speed=100% Speed</p> <p>60 sec.</p> <p>Continuous</p> <p>A</p> <p>B</p> <p>C</p> <p>05 33 100 120 167 200 (60 Hz)</p>	<p>Motor designed to operate from line power.</p> <p>Motor cooling is most effective when running at rated nameplate base frequency (check the motor specifications).</p>	<p>Continuous operation at less than line power frequency with 100% load can trigger motor overload protection (oL1). A fault is output and the motor will coast to stop.</p>

Setting 2: Drive Dedicated Motor (constant torque, 1:10)

Use this setting when operating a drive duty motor with a torque ratio of 1:10. This motor type is allowed to run with 100% load from 10% up to 100% speed. Running slower speeds with full load can trigger an overload fault.

5.8 L: Protection Functions

Overload Tolerance	Cooling Ability	Overload Characteristics
	<p>Motor is designed to effectively cool itself at speeds as low as 6 Hz.</p>	<p>Continuous operation with 100% load from 6 Hz to 50/60 Hz.</p>

Setting 3: Vector Motor (constant torque, 1:100)

Use this setting when operating a drive dedicated motor with a torque ratio of 1:100. This motor type is allowed to run with 100% load from 1% up to 100% speed. Running slower speeds with full load can trigger an overload fault.

Overload Tolerance	Cooling Ability	Overload Characteristics
	<p>Motor is designed to effectively cool itself at speeds as low as approximately 0.6 Hz.</p>	<p>Continuous operation with 100% load from 0.6 Hz to 50/60 Hz.</p>

Setting 4: PM Derated Torque Motor

This setting is for operating a PM motor. PM motors for derated torque have a self-cooling design, so the overload tolerance drops as the motor slows. Electronic thermal overload is triggered in accordance with the motor overload characteristics, providing overheat protection across the entire speed range.

Overload Tolerance	Cooling Ability	Overload Characteristics
	<p>Motor is designed to produce 100% torque at base speed. Built with effective cooling capabilities.</p>	<p>Reaching 100% when operating at below the base frequency causes a motor overload fault (oL1). The drive fault output closes and the motor coasts to stop.</p>

Setting 6: General-Purpose Motor

Note: General-purpose motors are designed with a base speed that operates at line frequency (50/60 Hz depending on geographic region).

Because the motor is self-cooled, the overload tolerance drops when the motor speed is lowered. The drive appropriately adjusts the electrothermal trigger point according to the motor overload characteristics and protects the motor from overheat throughout the entire speed range.

Overload Tolerance	Cooling Ability	Overload Characteristics
<p>Rated Speed=100% Speed</p> <p>A: Max. speed for 200LJ and above B: Max. speed for 160MJ to 180 LJ C: Max. speed for 132MJ and below</p>	<p>Motor designed to operate from line power. Motor cooling is most effective when running at rated base frequency (check the motor nameplate or specifications)</p>	<p>Continuous operation at less than line power frequency with 100% load can trigger motor overload protection (oL1). A fault is output and the motor will coast to stop.</p>

■ L1-02: Motor Overload Protection Time

Sets the time for the drive to shut down on motor overload (oL1) when the motor is running with excessive current. Enter the time the motor can withstand operating at 150% current after previously running at 100% current (hot motor overload condition). This parameter rarely requires adjustment.

No.	Name	Setting Range	Default
L1-02	Motor Overload Protection Time	0.1 to 5.0 minutes	1.0 minutes

Defaulted to operate with an allowance of 150% overload operation for one minute in a hot start after continuous operation at 100%.

Figure 5.76 illustrates an example of the electrothermal protection operation time using a general-purpose motor operating at the value of E1-06, Motor Base Speed, with L1-02 set to one minute.

Motor overload protection operates in the area between a cold start and a hot start.

- Cold start: Characteristics of motor protection operation time in response to an overload situation that was suddenly reached when starting a stationary motor.
- Hot start: Characteristics of motor protection operation time in response to an overload situation that occurred while the motor was operating continuously at or below its rated current.

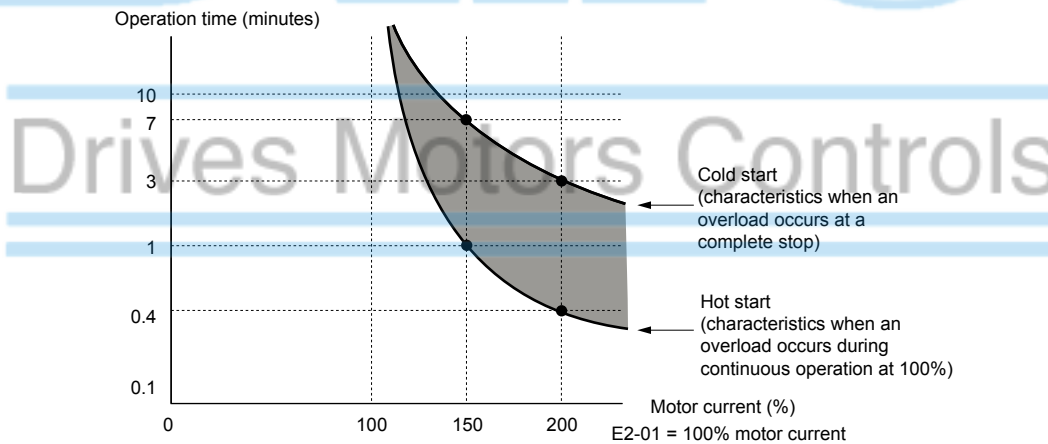

Figure 5.76 Protection Operation Time for General Purpose Motors at the Rated Output Frequency

■ Motor Protection Using a Positive Temperature Coefficient (PTC)

A motor PTC can be connected to an analog input of the drive. This input is used by the drive for motor overheat protection. When the motor overheat alarm level is reached, an oH3 alarm will be triggered and the drive will continue operation as selected in L1-03. When the overheat fault level is reached an oH4 fault is triggered, a fault signal will be output and the drive will stop the motor using the stop method determined in L1-04.

Figure 5.77 shows a PTC connection example for analog input A2. If using analog input A2, make sure to set DIP switch S1 on the terminal board for voltage input when using this function.

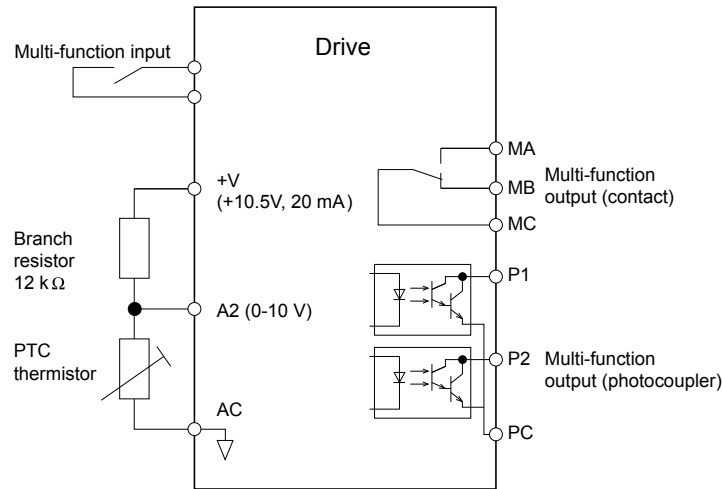

Figure 5.77 Connection of a Motor PTC

The PTC must have the following characteristics for one motor phase. Normally a motor is protected by three PTCs connected in series.

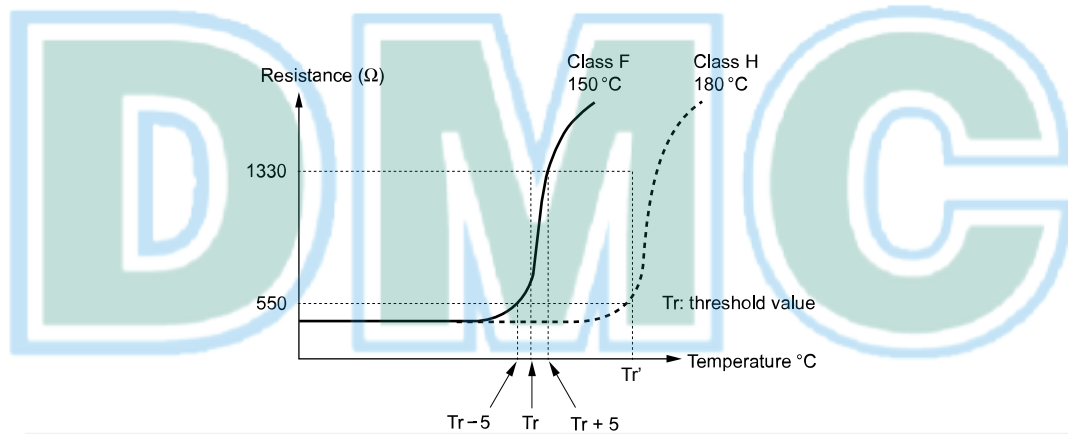

Figure 5.78 Motor PTC Characteristics

Overheat detection using a PTC can be set up by parameters L1-03/04/05 as explained below.

■ L1-03: Motor Overheat Alarm (oH3) Operation Selection

Sets the drive operation when the PTC input signal reaches the motor overheat alarm level. (PTC input level: $Tr - 5\text{ }^{\circ}\text{C}$)

No.	Name	Setting Range	Default
L1-03	Motor Overheat Alarm Operation Selection	0 to 3	3

Setting 0: Ramp to Stop

The drive stops the motor using the active deceleration time.

Setting 1: Coast to Stop

The drive output is switched off and the motor coasts to stop.

Setting 2: Fast-stop

The drive stops the motor using the Fast-stop time set in parameter C1-09.

Setting 3: Alarm Only

The operation is continued and an oH3 alarm is displayed on the digital operator

■ L1-04: Motor Overheat Fault (oH4) Operation Selection

Sets the drive operation when the PTC input signal reaches the motor overheat fault level. (PTC input level: $T_r + 5\text{ }^\circ\text{C}$)

No.	Name	Setting Range	Default
L1-04	Motor Overheat Fault Operation Selection	0 to 2	1

Setting 0: Ramp to Stop

The drive stops the motor using the active deceleration time.

Setting 1: Coast to Stop

The drive output is switched off and the motor coasts to stop.

Setting 2: Fast-stop

The drive stops the motor using the Fast-stop time set in parameter C1-09.

■ L1-05: Motor Temperature Input Filter Time

Used to set a filter on the PTC signal in order to prevent a motor overheat fault from being mistakenly detected.

No.	Name	Setting Range	Default
L1-05	Motor Temperature Input Filter Time	0.00 to 10.00 s	0.20 s

■ L1-13: Continuous Electrothermal Operation Selection

Determines whether to hold the current value of the electrothermal motor protection (L1-01) when the power supply is interrupted.

No.	Name	Setting Range	Default
L1-13	Continuous Electrothermal Operation Selection	0 or 1	1

Setting 0: Disabled

Setting 1: Enabled

■ L1-22: Leakage Current Filter Time Constant 1

- Note:**
1. Available in drive software versions PRG: 1021 and later.
 2. Available only when C6-02 is set to B. To display this parameter, first set C6-02 to B.

Sets the time constant for the filter applied to motor overload detection current or monitor current for constant speed operation. Leakage current can incorrectly trigger motor overload fault oL1 or result in incorrect monitor reading. Increase this setting if erroneous detection occurs or if the monitor display is incorrect.

NOTICE: Setting parameter L1-22 too high may cause the drive to detect motor overload too slowly and burn out the motor. Be sure to set L1-22 to an appropriate value for the application.

No.	Name	Setting Range	Default
L1-22	Leakage Current Filter Time Constant 1	0.0 to 60.0 s	20.0 s

■ L1-23: Leakage Current Filter Time Constant 2

- Note:**
1. Available in drive software versions PRG: 1021 and later.
 2. Available only when C6-02 is set to B. To display this parameter, first set C6-02 to B.

Sets the time constant for the filter applied to monitor current during acceleration and deceleration. Leakage current can result in incorrect monitor reading. Increase this setting if the monitor display is incorrect.

- Note:** Setting parameter L1-23 too high may cause the current monitor to take too long to read the initial current level. Check the operation sequence being used if this is a problem.

No.	Name	Setting Range	Default
L1-23	Leakage Current Filter Time Constant 2	0.0 to 60.0 s	1.0 s

◆ L2: Momentary Power Loss Ride-Thru

■ L2-01: Momentary Power Loss Operation Selection

When a momentary power loss occurs (DC bus voltage falls below the level set in L2-05), the drive can be set to automatically return to the operation it was performing when the power went out based on certain conditions.

No.	Name	Setting Range	Default
L2-01	Momentary Power Loss Operation Selection	0 to 2	0

Setting 0: Disabled (default)

If power is not restored within 15 ms, a Uv1 fault will result and the drive will stop the motor.

Setting 1: Enabled, Recover Within L2-02

When a momentary power loss occurs, the drive will attempt to restart and perform Speed Search if power is restored within the period of time set to parameter L2-02. If power is not restored within the time set to L2-02 (i.e. DC bus voltage level remains below Uv1 detection level L2-05), then a Uv1 fault is triggered and the drive output will be shut off.

Setting 2: Recover as Long as CPU has Power

Drive will try to restart as long as the CPU still has power. This allows for a longer ride-through time than setting L2-01 to 1. A Uv1 fault is not triggered. This setting should also be used if the KEB function is utilized.

- Note:**
1. The amount of time the drive is capable of recovering after a power loss is determined by the capacity of the drive. Drive capacity determines the upper limit for L2-02.
 2. When L2-01 is set to 1 or 2, and a magnetic contactor between motor and drive is used, be sure that the magnetic contactor is kept close as long as the drive attempts to restart.
 3. When L2-01 is set to 1 or 2, "Uv" will flash on the operator while the drive is attempting to recover from a momentary power loss. A fault signal is not output at this time.

■ L2-02: Momentary Power Loss Ride-Thru Time

Set the time in which the power has to return before a Uv fault is tripped. This parameter is valid only if L2-01 = 1.

No.	Name	Setting Range	Default
L2-02	Momentary Power Loss Ride-Thru Time	0.0 to 25.5 s	Determined by o2-04.

■ L2-03: Momentary Power Loss Minimum Baseblock Time

Sets the minimum baseblock time when power is restored following a momentary power loss. This determines the time it takes for the leftover voltage in the motor to dissipate. Increase this setting if overcurrent or overvoltage occur at the beginning of Speed Search after a power loss or DC Injection Braking. If L2-03 > L2-02, then the drive will restart after the time set to L2-03 has passed from the beginning of the power loss.

No.	Name	Setting Range	Default
L2-03	Momentary Power Loss Minimum Baseblock Time	0.1 to 5.0 s	Determined by o2-04

■ L2-04: Momentary Power Loss Voltage Recovery Ramp Time

Sets the time constant used to ramp up the voltage during Speed Search. The setting value determines the time for a change from zero to the maximum voltage.

No.	Name	Setting Range	Default
L2-04	Momentary Power Loss Voltage Recovery Ramp Time	0.0 to 5.0 s	Determined by o2-04

■ L2-05: Undervoltage Detection Level

Determines the voltage at which a Uv1 fault is triggered or at which the KEB function is activated.

No.	Name	Setting Range	Default
L2-05 <1>	Undervoltage Detection Level	150 to 210 V	190 V <2>

<1> Values are for 200 V class drives and must be doubled for 400 V class drives.

<2> This value is initialized when E1-01 is changed.

This setting rarely needs to be changed.

When setting L2-05 is lower than the default setting, be sure to install an AC reactor option to the input side of the power supply to prevent damage to drive circuitry.

■ Kinetic Energy Backup (KEB) Function

In case of a power loss, the KEB function can decelerate the motor and use the rotational energy of the machine to backup/maintain the drive DC bus for a certain period of time. This allows the drive to continue running without interrupting the output power during a momentary power loss. Once the power is restored, the drive smoothly returns to the same operational state before the power loss occurred. The KEB function supports two different operation modes.

KEB 1

In this mode the drive decelerates the motor based on the deceleration time set in parameter L2-06/C1-09 in order to keep the DC bus voltage level high. When the power supply returns, it uses the time set to L2-07 or the selected acceleration time to accelerate back to the frequency reference.

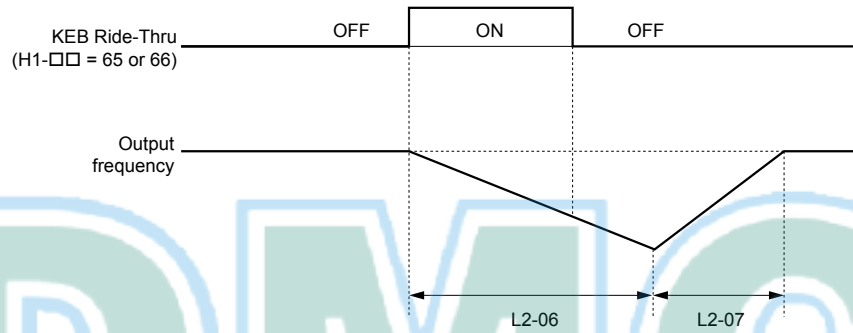

Figure 5.79 KEB Ride-Thru Timing Diagram for Multiple Drives

Note: If L2-06 is set to 0.0 s, C1-09 is used instead. If L2-07 is set to 0.0 s, the drive reaccelerates using the selected acceleration time.

Use this method with setting parameters L2-06 and L2-07 if multiple drives must decelerate but still keep the speed ratio between the drives constant during power loss. In this case, a braking resistor is required in order to avoid overvoltage trips.

KEB 2

In this mode the drive decelerates the motor by calculating the energy of the rotating system. The deceleration rate is continuously adjusted so that the DC bus voltage meets the level set in parameter L2-11. The rotational energy is estimated using the parameters L3-24 and L3-25. When the power supply returns, the drive accelerates back to the frequency reference using the selected acceleration time.

Activation and Deactivation of the KEB Function

The KEB function requires parameter L2-01 to be set to 1 or 2 and a digital input has to be configured for the KEB 1 (H1-□□ = 65/66) or KEB 2 (H1-□□ = 7A/7B) command. The input has to be enabled during KEB. *Refer to Setting 65/66: KEB Ride-Thru 1 (N.C.)/2 (N.O.) on page 192* and *Refer to Setting 7A/7B: KEB Ride-Thru 2 (N.C./N.O.) on page 194* for details on setting the KEB input commands.

The KEB function is automatically activated when one of the conditions below becomes true.

- The DC bus voltage falls below the level set in parameter L2-05. The KEB input has to be set within 50 ms after the KEB function was activated, or the drive will assume the power supply has returned and attempt to restart.
- The input programmed for KEB 1 or 2 is activated. This input should be triggered by an external undervoltage detection relay.

The KEB function ends when one of the conditions below become true.

- The KEB input was released or
- The function was activated by DC bus voltage detection and no KEB input was set within 50 ms after the KEB activation.

Figure 5.80 shows a wiring example for triggering the KEB function at power loss using digital input S6.

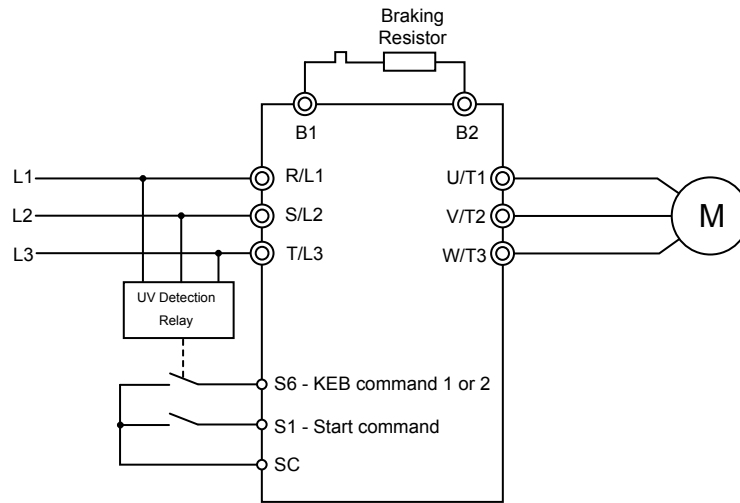

Figure 5.80 KEB Function Wiring Example

Note: Make sure the Run command is not switched off when momentary power loss occurs. If the Run command is shut off, the drive will not accelerate back to speed when the power is restored.

KEB Related Adjustment Parameters

The KEB 1 functions can be adjusted using the following parameters:

- L2-05, Undervoltage Detection Level
- L2-06 or C1-09, KEB Deceleration Time or Fast-stop Time
- L2-07, KEB Acceleration Time
- L2-08, Frequency Gain at KEB Start

Use the following parameters when adjusting the KEB 2 function:

- L2-05, Undervoltage Detection Level
- L2-08, Frequency Gain at KEB Start
- L2-11, Desired DC Bus Voltage during KEB
- L3-20, Main Circuit DC Voltage Adjustment Gain

Sets the proportional gain for controlling the DC bus voltage and keeping it at the desired level during KEB 2 operation.

- L3-21, Accel/Decel Rate Calculation Gain

Sets the gain used to calculate the acceleration or deceleration rate when KEB 2 is active.

- L3-24, Motor Acceleration Time

This value is used to estimate the regenerative power fed back from the mechanics to the drive DC bus during KEB 2.

- L3-25, Load Inertia Ratio

This value is used to estimate the regenerative power fed back from the mechanics to the drive DC bus during KEB 2.

■ L2-06: KEB Deceleration Time (KEB 1 only)

Sets the time to decelerate from the frequency reference when the KEB command was input down to zero speed. It can be used to decelerate different drives down to zero in the same time and thereby keep a constant speed ratio.

When L2-06 is set to 0.0 s, the time set in parameter C1-09 (set for deceleration from maximum frequency to zero) is used for the deceleration.

No.	Name	Setting Range	Default
L2-06	KEB Deceleration Time	0.0 to 200.0 s	0.0 s

■ L2-07: KEB Acceleration Time (KEB 1 only)

Sets the time to reaccelerate from the speed when KEB was deactivated to the frequency reference. It can be used to accelerate different drives up to their frequency reference in the same time and thereby keep a constant speed ratio.

When set to 0, the drive will accelerate back up to speed according to parameters C1-01 through C1-08 (set for acceleration from zero to maximum frequency).

No.	Name	Setting Range	Default
L2-07	KEB Acceleration Time	0.0 to 25.5 s	0.0 s

■ L2-08: Frequency Gain at KEB Start (KEB 1 only)

When KEB 1 is activated, the output frequency is reduced in a single step in order to quickly get the motor into a regenerative state. The amount of this frequency reduction can be calculated using the following formula:

Amount of reduction = Slip frequency prior to KEB x (L2-08/100) x 2

No.	Name	Setting Range	Default
L2-08	Minimum Frequency Gain at KEB Start	0 to 300%	100%

■ L2-11: Desired DC Bus Voltage during KEB (KEB 2 only)

Sets the desired voltage in the DC bus during KEB 2 operation.

No.	Name	Setting Range	Default
L2-11	Desired DC Bus Voltage during KEB	150 to 400 V </>	E1-01 x 1.22

<1> Values are for 200 V class drives and must be doubled for 400 V class drives.

◆ L3: Stall Prevention

When the load is too high or acceleration and deceleration times are too short, the motor may be unable to keep up with the frequency reference, resulting in excessive slip. This “stalling” makes it impossible to decelerate or accelerate. The drive can prevent the motor from stalling and still reach the desired speed without the user needing to change the acceleration or deceleration time settings. The Stall Prevention function can be set separately for acceleration, operating at constant speeds, and deceleration.

■ L3-01: Stall Prevention Selection during Acceleration

Stall Prevention during acceleration is used when the motor loses speed during acceleration due to a relatively large load. It prevents overcurrent and motor overload (oL1) from occurring.

This parameter sets the Stall Prevention method for acceleration.

No.	Name	Setting Range	Default
L3-01	Stall Prevention Selection during Acceleration	0 to 2 </>	1

<1> Setting 2 is not available for PM OLV.

Setting 0: Disabled

No Stall Prevention is provided. If the acceleration time setting is too short, the drive may not be able to accelerate within the set time and the motor may stall.

Setting 1: Enabled

Enables Stall Prevention during acceleration. The operation depends on the selected control mode.

- V/f or Open Loop Vector Control:

When the output current exceeds 85% of the level set in parameter L3-02, the acceleration rate is reduced. The acceleration is stopped when the current exceeds L3-02. Acceleration continues when the current falls below L3-02.

The Stall Prevention level is automatically reduced in the field weakening area. [Refer to L3-03: Stall Prevention Limit During Acceleration on page 223.](#)

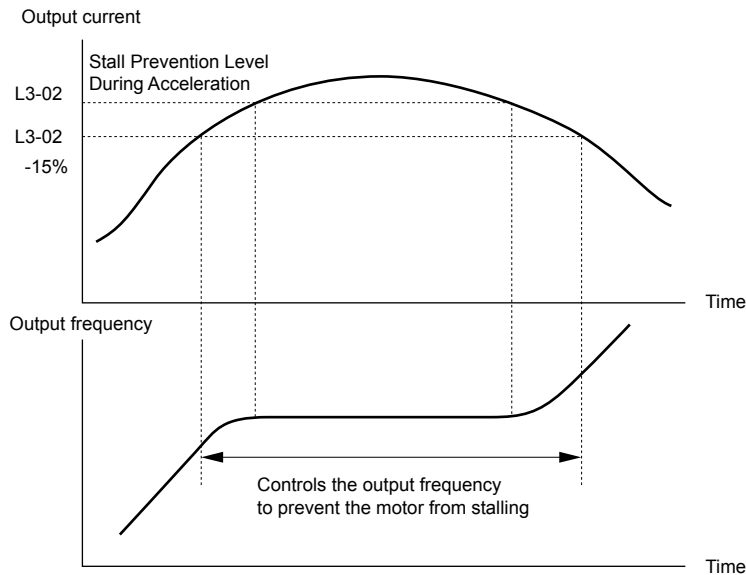

Figure 5.81 Stall Prevention During Acceleration for Induction Motors

- Open Loop Vector Control for PM:

Acceleration is stopped when the output current reaches the level set in parameter L3-02, and after 100 ms the drive decelerates using the deceleration time set in parameter L3-22 (*Refer to L3-22: Deceleration Time at Stall Prevention During Acceleration on page 223*). When the current falls below 85% of L3-02, deceleration is stopped. The drive will attempt to reaccelerate again after 100 ms.

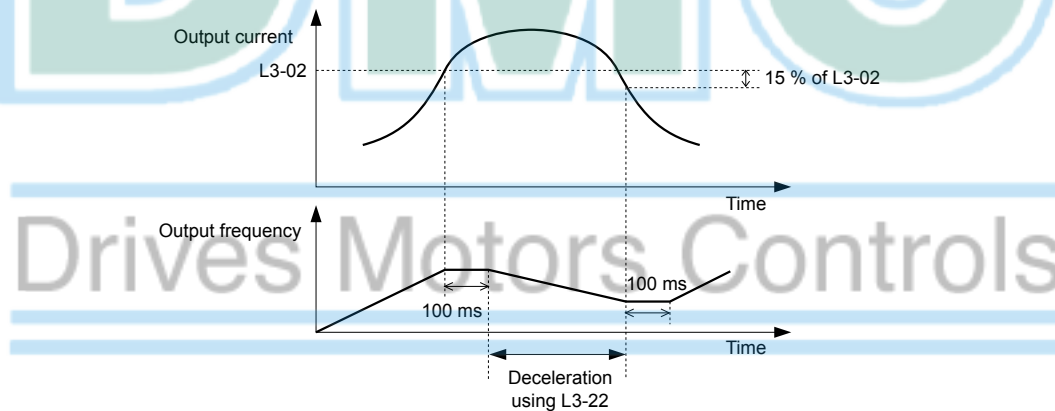

Figure 5.82 Stall Prevention During Acceleration for Permanent Magnet Motors

Setting 2: Intelligent Stall Prevention

When L3-01 = 2, the drive will disregard the selected acceleration time and try to accelerate in the minimum time. The acceleration rate is adjusted so that the current does not exceed the value set in parameter L3-02.

■ L3-02: Stall Prevention Level During Acceleration

Sets the output current level at which the Stall Prevention during acceleration is activated.

No.	Name	Setting Range	Default
L3-02	Stall Prevention Level during Acceleration	0 to 150% </>	</>

<1> The upper limit and default value is determined by the duty rating and the carrier frequency derating selection (C6-01 and L8-38 respectively).

- If stalling occurs with L3-02 set to its default value when using a motor that is relatively small compared to the drive, try lowering L3-02.
- When operating the motor in the constant power range, also set parameter L3-03.

■ L3-03: Stall Prevention Limit During Acceleration

The Stall Prevention level is automatically reduced when the motor is operated in the constant power range. L3-03 sets the lower limit for this reduction as a percentage of the drive rated current.

No.	Name	Setting Range	Default
L3-03	Stall Prevention Limit during Acceleration	0 to 100%	50%

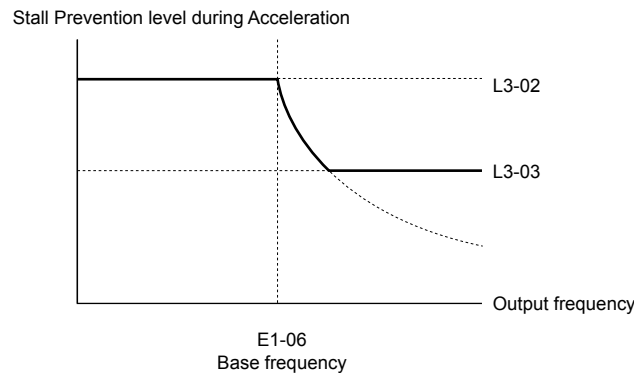

Figure 5.83 Stall Prevention Level and Limit During Acceleration

■ L3-22: Deceleration Time at Stall Prevention During Acceleration

Sets the brief deceleration time used when stalling occurs while accelerating a PM motor. When set to 0, this function is disabled and the drive will decelerate at the selected deceleration time when stalling occurs.

The function is effective only in Open Loop Vector Control for PM motors and if parameter L3-01 is set to 1.

No.	Name	Setting Range	Default
L3-22	Deceleration Time at Stall Prevention During Acceleration	0 to 6000.0 s	0.0 s

■ L3-04: Stall Prevention Selection during Deceleration

Stall Prevention during deceleration can control the deceleration based on the DC bus voltage and prevent an overvoltage fault caused by high inertia or rapid deceleration.

Selects the Stall Prevention method during deceleration.

No.	Name	Setting Range	Default
L3-04	Stall Prevention Selection During Deceleration Selection	0 to 4; 7 <1> <2>	1

<1> Settings 3 and 4 are not available in OLV/PM control mode.

<2> Setting 7 is available in drive software versions PRG: 1020 and later.

Setting 0: Disabled

When this setting is used, the drive decelerates according to the set deceleration time. With high inertia loads or rapid deceleration, an overvoltage (ov) fault may occur. In this case use braking options or switch to another L3-04 selection.

Note: Use this setting or set L3-04 to 3 whenever a Dynamic Braking Resistor or another braking option is used.

Setting 1: General Purpose Stall Prevention

With this setting the drive tries to decelerate in the set deceleration time. When the DC bus voltage exceeds the Stall Prevention level, the drive pauses deceleration. Deceleration continues as soon as the DC bus voltage drops below that level. Stall Prevention may be triggered repeatedly to avoid an overvoltage fault. The DC bus voltage level for Stall Prevention depends on the input voltage setting E1-01.

Drive Input Voltage		Stall Prevention Level during Deceleration
200 V Class		V _{dc} = 380 V
400 V Class	E1-01 ≥ 400 V	V _{dc} = 760 V
	E1-01 < 400 V	V _{dc} = 660 V

Note: 1. This setting should not be used in combination with a Dynamic Braking Resistor or other braking options. If Stall Prevention during deceleration is enabled, it will be triggered before the braking resistor option can operate.

5.8 L: Protection Functions

- This method may lengthen the total deceleration time compared to the set value. If this is not appropriate for the application consider using a braking option.

Figure 5.84 illustrates the function of Stall Prevention during deceleration.

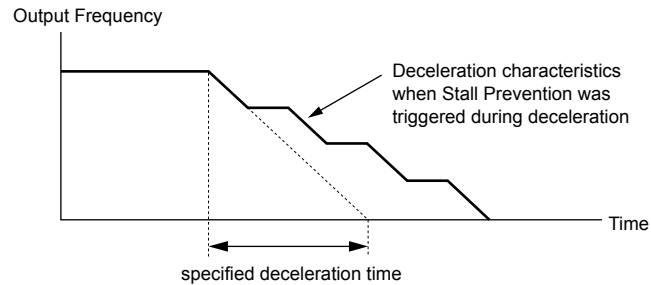

Figure 5.84 Stall Prevention During Deceleration

Setting 2: Intelligent Stall Prevention

With this setting the drive adjusts the deceleration rate so that the DC bus voltage is kept at the level set in parameter L3-17. This way the shortest possible deceleration time is achieved while the motor is protected from stalling. The deceleration time that has been selected is disregarded, but the achievable deceleration time cannot be smaller than 1/10 of the set deceleration time.

This function uses the following parameters for adjusting the deceleration rate:

- DC bus voltage gain L3-20
- Deceleration rate calculations gain L3-21
- Inertia calculations for motor acceleration time L3-24
- Load inertia ratio L3-25

Refer to these parameter descriptions for details.

Note: As the deceleration time is not constant, Intelligent Stall Prevention should not be used in applications where stopping accuracy is a concern. Use braking options instead.

Setting 3: Stall Prevention with Braking Option

Enables the Stall Prevention function while using a braking resistor. Use this setting if overvoltage occurs with L3-04 disabled when using a braking resistor. This makes it possible to reduce the deceleration time.

Setting 4: Overexcitation Deceleration

Enables overexcitation deceleration. Overexcitation Deceleration (increasing the motor flux) shortens the deceleration time compared to deceleration with no Stall Prevention (L3-04 = 0). Repetitive or long overexcitation deceleration can result in motor overheat. In such situations, either shorten the deceleration time setting or use a braking resistor option.

Use parameters n3-13 and n3-23 for fine-tuning this function.

Note: Because the allowable flux level for overexcitation varies based on the flux saturation characteristics of the motor, set the proper overexcitation level by adjusting the excitation gain in parameter n3-13. Motor characteristics and inertia of the machine influence the deceleration time during overexcitation deceleration.

Setting 7: Overexcitation Deceleration 3

Provides faster deceleration than normal Overexcitation Deceleration (L3-04 = 4) by increasing the amount of overexcitation current applied to the motor.

Note: When operation permits, use normal Overexcitation Deceleration (L3-04 = 4).

■ L3-05: Stall Prevention Selection During Run

Stall Prevention During Run can prevent a motor from stalling by automatically reducing the speed when a transient overload occurs while the motor is running at constant speed.

This parameter selects the Stall Prevention During Run method.

No.	Name	Setting Range	Default
L3-05	Stall Prevention Selection During Run	0 to 2	1

- Note:**
- This function is not available in Open Loop Vector Control. Use the torque limit function instead.
 - When output frequency is 6 Hz or less, Stall Prevention During Run is disabled regardless of the setting in L3-05/06.

Setting 0: Disabled

Drive runs at the set frequency reference. A heavy load may cause the motor to stall and trip the drive with an oC or oL fault.

Setting 1: Decelerate Using C1-02

If the current exceeds the Stall Prevention level set in parameter L3-06, the drive decelerates at Decel Time 1 (C1-02). Once the current level drops below the value of L3-06 minus 2% for 100 ms it accelerates back to the frequency reference at the active acceleration time.

Setting 2: Decelerate Using C1-04

Same as setting 1 except the drive decelerates at decel time 2 (C1-04).

■ L3-06: Stall Prevention Level During Run

Sets the current level for Stall Prevention During Run. Depending on the setting of parameter L3-23 the level is automatically reduced in the constant power range (speed beyond base speed).

No.	Name	Setting Range	Default
L3-06	Stall Prevention Level During Run	30 to 150 </>	</>

<1> The upper limit and default value for this setting are determined by C6-01, Drive Duty Selection, and L8-38, Carrier Frequency Reduction Selection.

■ L3-23: Automatic Stall Prevention Level Reduction

This function reduces the Stall Prevention during run level in the constant power range.

No.	Name	Setting Range	Default
L3-23	Automatic Reduction Function Selection for Stall Prevention during Run	0 or 1	0

Setting 0: Disabled

The level set in L3-06 is used throughout the entire speed range.

Setting 1: Enabled

The Stall Prevention level during run is reduced in the constant power range. The lower limit will be 40% of L3-06.

■ Overvoltage Suppression Function

This function suppresses overvoltage faults by slightly increasing the output frequency when the DC bus voltage rises. It can be used to drive loads with cyclic regenerative operation, such as punch presses or other applications that involve repetitive crank movements.

The output frequency is adjusted during ov suppression so that the DC bus voltage does not exceed the level set in parameter L3-17. In addition to the parameters explained below, ov suppression also uses these settings for frequency adjustment:

- DC bus voltage gain L3-20
- Deceleration rate calculations gain L3-21
- Inertia calculations for motor acceleration time L3-24
- Load inertia ratio L3-25

- Note:**
1. The motor speed will exceed the frequency reference when overvoltage suppression is triggered. Consequently, overvoltage suppression is not appropriate in applications that require a perfect match between the frequency reference and the actual motor speed.
 2. Disable overvoltage suppression when using a braking resistor.
 3. Overvoltage may still occur if there is a sudden increase to a regenerative load.
 4. This function is enabled only when operating just below the maximum frequency. Overvoltage suppression does not increase the output frequency beyond the maximum frequency. If this is required by the application increase the maximum frequency and change the base frequency setting.

■ L3-11: Overvoltage Suppression Function Selection

Enables or disables the overvoltage suppression function.

No.	Name	Setting Range	Default
L3-11	ov Suppression Function Selection	0 or 1	0

Setting 0: Disabled

The output frequency is not adjusted. A regenerative load may trip the drive with an overvoltage fault. Use this setting if braking options are installed.

5.8 L: Protection Functions

Setting 1: Enabled

When the DC bus voltage rises due to regenerative load, an overvoltage fault is prevented by increasing the output frequency.

■ L3-17: Target DC Bus Voltage for Overvoltage Suppression and Stall Prevention

Sets the target DC bus voltage target level used by the overvoltage suppression function (L3-11 = 1) and Intelligent Stall Prevention during deceleration (L3-04 = 2).

No.	Name	Setting Range	Default
L3-17	Target DC Bus Voltage for Overvoltage Suppression, and Intelligent Stall Prevention During Deceleration	150 to 400 <1>	370 V <1> <2>

<1> Values are for 200 V class drives and must be doubled for 400 V class drives.

<2> This value is initialized when E1-01 is changed.

■ L3-20: DC Bus Voltage Adjustment Gain

Determines the proportional gain used by overvoltage suppression (L3-11 = 1), Kinetic Energy Backup 2, and Intelligent Stall Prevention during deceleration (L3-04 = 2) in order to control the DC bus voltage.

No.	Name	Setting Range	Default
L3-20	DC Bus Voltage Adjustment Gain	0.00 to 5.00	1.00

Adjustment for KEB 2 and Intelligent Stall Prevention During Deceleration

- Increase this setting slowly in steps of 0.1 if overvoltage (ov) or undervoltage (Uv1) occurs at the beginning of deceleration while KEB Ride-Thru 2 is enabled or Intelligent Stall Prevention during deceleration is activated.
- If this setting is too high, then a fair amount of speed or torque ripple can result.

Adjustment for Overvoltage Suppression

- Increase this setting slowly in steps of 0.1 if overvoltage suppression is enabled (L3-11 = 1) and a sudden increase in a regenerative load results in an overvoltage (ov) fault.
- If this setting is too high, excessive speed or torque ripple can result.

■ L3-21: Accel/Decel Rate Calculation Gain

Determines the proportional gain used by overvoltage suppression (L3-11 = 1), Kinetic Energy Backup 2, and Intelligent Stall Prevention during deceleration (L3-04 = 2) in order to calculate acceleration and deceleration rates.

No.	Name	Setting Range	Default
L3-21	Accel/Decel Rate Calculation Gain	0.00 to 200.00	1.00 <1>

<1> This value is reset to its default value when the control mode is changed (A1-02). The value shown here is for Open Loop Vector Control.

Adjustment for KEB 2 and Intelligent Stall Prevention During Deceleration

- Reduce the setting in steps of 0.05 if there is a fairly large speed or current ripple during KEB Ride-Thru 2 or when using Intelligent Stall Prevention during deceleration.
- Small reductions in the acceleration gain can also help solve problems with overvoltage and overcurrent.
- Decreasing this setting too much can result in a slow DC bus voltage control response and may also lengthen deceleration times beyond optimal levels.

Adjustment for Overvoltage Suppression

- Increase this setting in steps of 0.1 if overvoltage occurs as a result of a regenerative load when overvoltage suppression is enabled (L3-11 = 1).
- If there is a fairly large speed ripple when overvoltage suppression is enabled, then decrease L3-21 in steps of 0.05.

■ L3-24: Motor Acceleration Time for Inertia Calculations

Sets the time it takes to accelerate the motor from stop to the maximum speed at motor rated torque. This parameter should be set when using KEB Ride-Thru 2, Intelligent Stall Prevention during deceleration (L2-04 = 2), or the overvoltage suppression function (L3-11 = 1).

No.	Name	Setting Range	Default
L3-24	Motor Acceleration Time for Inertia Calculations	0.001 to 10.000	Determined by o2-04, E2-11, and E5-01 <1>

<1> Parameter L3-24 is defaulted for a Yaskawa standard 4-pole motor. During Auto-Tuning, L3-24 will be initialized to a Yaskawa standard 4-pole motor if parameter E2-11 is changed. This value also changes based on the motor code set to E5-01 when using the Open Loop Vector Control Mode for PM motors.

Calculations are made as follows:

$$L3-24 = \frac{2 \cdot \pi \cdot J [\text{kgm}^2] \cdot n_{\text{rated}} [\text{r/min}]}{60 \cdot T_{\text{rated}} [\text{Nm}]}$$

The rated torque can be calculated as follows:

$$T_{\text{rated}} [\text{Nm}] = \frac{60 \cdot P_{\text{Motor}} [\text{kW}] \cdot 10^3}{2 \cdot \pi \cdot n_{\text{rated}} [\text{r/min}]}$$

■ L3-25: Load Inertia Ratio

Determines the ratio between the rotor inertia and the load. Set this parameter when using KEB Ride-Thru 2, Intelligent Stall Prevention during deceleration (L3-04 = 2), or the overvoltage suppression function (L3-11 = 1).

No.	Name	Setting Range	Default
L3-25	Load Inertia Ratio	0.0 to 1000.0	1.0

When set incorrectly, a fairly large current ripple can result during KEB Ride-Thru 2 and overvoltage suppression (L3-11 = 1) or other faults such as ov, Uv1, and oC may occur.

Parameter L3-25 can be calculated by:

$$L3-25 = \frac{\text{Machine Inertia}}{\text{Motor Inertia}}$$

◆ L4: Speed Agree/Frequency Reference Loss Detection

These parameters set up the speed agree and speed detection functions which can be assigned to the multi-function output terminals.

■ L4-01/02: Speed Agreement Detection Level and Detection Width

Parameter L4-01 sets the detection level for the digital output functions “Speed Agree 1”, “User Set Speed Agree 1”, “Frequency Detection 1”, and “Frequency Detection 2”.

Parameter L4-02 sets the hysteresis level for these functions.

No.	Name	Setting Range	Default
L4-01	Speed Agreement Detection Level	0.0 to 400.0 Hz	0.0 Hz
L4-02	Speed Agreement Detection Width	0.0 to 20.0 Hz	2.0 Hz

Refer to H2-01 to H2-03: Terminal MA/MB/MC, P1/PC and P2/PC Function Selection on page 195, Settings 2, 3, 4, and 5.

■ L4-03/04: Speed Agreement Detection Level and Detection Width (+/-)

Parameter L4-03 sets the detection level for the digital output functions “Speed Agree 2”, “User Set Speed Agree 2”, “Frequency Detection 3”, and “Frequency Detection 4”.

Parameter L4-04 sets the hysteresis level for these functions.

No.	Name	Setting Range	Default
L4-03	Speed Agreement Detection Level (+/-)	0.0 to 400.0 Hz	0.0 Hz
L4-04	Speed Agreement Detection Width (+/-)	0.0 to 20.0 Hz	2.0 Hz

Refer to H2-01 to H2-03: Terminal MA/MB/MC, P1/PC and P2/PC Function Selection on page 195, Settings 13, 14, 15, and 16.

■ L4-05: Frequency Reference Loss Detection Selection

The drive can detect a loss of an analog frequency reference from input A1 or A2. Reference loss is detected when the frequency reference value reduces for 90% within 400 ms.

5.8 L: Protection Functions

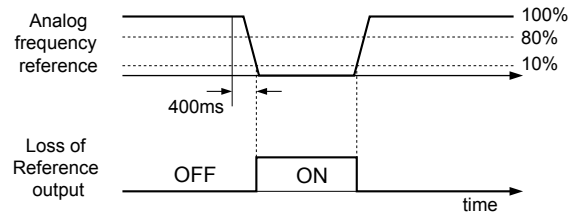

Figure 5.85 Loss of Reference Function

To have a fault output trigger when frequency reference loss occurs, set H2-01, H2-02, or H2-03 to “C”. *Refer to Setting C: Frequency Reference Loss on page 199* for details on setting the output function.

Parameter L4-05 selects the operation when a frequency reference loss is detected.

No.	Name	Setting Range	Default
L4-05	Frequency Reference Loss Detection Selection	0 or 1	0

Setting 0: Stop

The drive will stop the motor.

Setting 1: Continue Operation with Reduced Frequency Reference

The drive will continue operation at the frequency reference value set in parameter L4-06. When the external frequency reference value is restored, the operation is continued with the frequency reference.

■ L4-06: Frequency Reference at Reference Loss

Sets the frequency reference level the drive runs with when L4-05 = 1 and a reference loss was detected. The value is set as a percentage of the frequency reference before the loss was detected.

No.	Name	Setting Range	Default
L4-06	Frequency Reference at Reference Loss	0.0 to 100.0%	80.0%

■ L4-07: Speed Agreement Detection Selection

Determines when frequency detection is active using parameters L4-01 through L4-04.

No.	Name	Setting Range	Default
L4-07	Speed Agreement Detection Selection	0, 1	0

Setting 0: No Detection During Baseblock

Setting 1: Detection Always Enabled

■ L4-08: Speed Agreement Detection Conditions

Note: Parameter available in drive software versions PRG: 1016 and later.

Determines whether soft-starter output or estimated motor speed constitutes a speed agreement situation.

No.	Name	Setting Range	Default
L4-08	Speed Agreement Detection Conditions	0, 1	0

Setting 0: Match Speed with the Soft-Starter Output

Setting 1: Match Frequency Reference and Motor Speed

Note: In V/f control the drive ignores the value set to L4-08 and refers to the soft-starter output to determine whether a speed agreement situation has been reached.

The following functions are influenced by the speed agree condition:

- Overtorque alarms oL3 and oL4 when parameters L6-01 or L6-04 are set to 1, 3, 5, or 7.
- DriveWorksEZ functions that use speed agree output
- The Up 2/Down 2 functions
- Multi-Function Digital Output Settings

Setting Value	Function
2	Frequency (Speed) Agree 1
3	User-set Frequency (Speed) Agree 1
4	Frequency (FOUT) Detection 1
5	Frequency (FOUT) Detection 2
13	Frequency (Speed) Agree 2
14	User-set Frequency (Speed) Agree 2
15	Frequency (FOUT) Detection 3
16	Frequency (FOUT) Detection 4

• MEMOBUS/Modbus Monitor Data

Register No.	Description	
002CH	Drive Status 2	
	Bit 2	Speed Agree, 1: During Agree
	Bit 3	User-set Speed Agree, 1: During Agree
	Bit 4	Frequency Detection 1, 1: Output Frequency \leq L4-01
	Bit 5	Frequency Detection 2, 1: Output Frequency \geq L4-01
004BH	Drive Status (U1-12)	
	Bit 4	1: During Speed Agree

• U: Monitor

No.	Name	Description
U1-12	Drive Status	The fifth digit from the right side: During Speed Agree

■ Notes on Drive Control for Holding Brake Applications

The frequency detection function is used for controlling the brake.

When an external Baseblock command is present while a Run command is active, the frequency reference will be kept as long as the Run command is active. To avoid improper brake operation make sure that frequency detection is set so that the brake does not open during Baseblock (L4-07 = "0", default).

Brake Open/Close		Brake Activation Level	
Function	Parameter	Signal	Parameter
Frequency Detection Conditions	L4-07 = 0	Frequency Detection Level	L4-01 = 2.0 to 3.0 Hz <>
Frequency Detection 2	H2-01 = 5	Frequency Detection Width	2.0 Hz (fixed)

<1> If the load slips during stop, make it greater than E1-09 or 2.0 Hz until the load no longer slips.

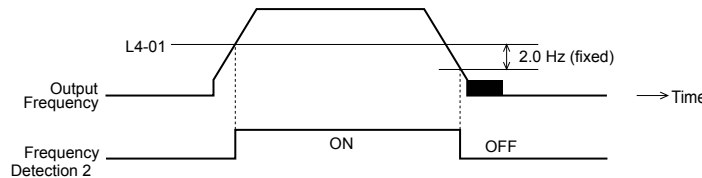

Figure 5.86 Frequency Detection 2

The braking sequence should be designed as follows:

- A normally open signal (N.O.) should be used to control the brake so that it is released when terminal MA-MC closes.
- An external circuit should be added to ensure the brake is fully applied in case of a fault or emergency condition.
- An additional external circuit should also be added to ensure the brake releases properly when an Up/Down Command is entered.

When changing the speed using an analog signal, make sure that the source of the frequency reference is assigned to the control circuit terminals (b1-01 = 1).

A sequence to open and close the holding brake appears in the diagram below.

5.8 L: Protection Functions

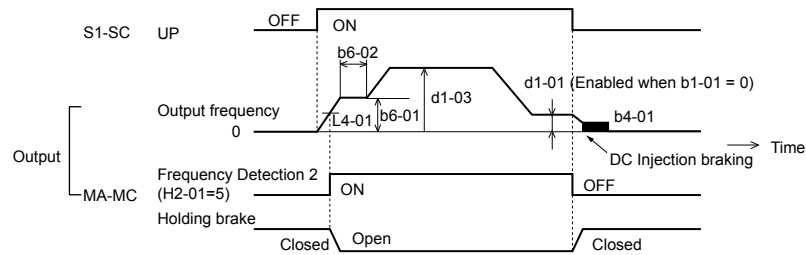

Figure 5.87 Holding Brake Time Chart

◆ L5: Fault Restart

The drive can be set up to perform a self-diagnostic check and resume the operation after a fault has occurred. If the self-check is successful and the cause of the fault has disappeared, the drive restarts by performing Speed Search (Refer to b3: Speed Search on page 130 for details).

The drive can attempt to restart itself following the faults listed below.

Table 5.30 Restart Faults

Setting	Function	Setting	Function
GF	(Ground Fault)	ov	(DC Bus Overvoltage)
LF	(Output Open Phase)	PF	(Input Phase Loss)
oC	(Overcurrent)	rH	(Braking Resistor Fault)
oH1	(Drive Overheat)	rr	(Braking Transistor Fault)
oL1	(Motor Overload)	STo	(Step Out Detection)
oL2	(Drive Overload)	Uv1	(DC Bus Undervoltage) <1>
oL3	(Overtorque 1)		
oL4	(Overtorque 2)		

<1> When L2-01 is set to 1 or 2 (continue operation during momentary power loss)

Use parameters L5-01 to L5-05 to set up automatic fault restart.

To output a signal during fault restart, set H2-01, H2-02, or H2-03 to 1E.

Do not use the fault restart function in elevator applications.

■ L5-01: Number of Auto Restart Attempts

Sets the number of times that the drive may attempt to restart itself.

No.	Name	Setting Range	Default
L5-01	Number of Auto Restarts	0 to 10	0

The method of incrementing the restart counter is determined by the setting of parameter L5-05. When the counter reaches the number set in L5-01 the operation stops and the fault has to be reset manually after correcting the cause.

The restart counter is incremented at each restart attempt, regardless of whether the attempt was successful. When the counter reaches the number set in L5-01 the operation stops and the fault has to be reset manually after correcting the cause.

The number of fault restarts is reset back to zero when:

- The drive operates normally for ten minutes following a fault restart.
- A fault is cleared manually after protective functions are triggered.
- The power supply is cycled.

■ L5-02: Auto Restart Fault Output Operation Selection

Selects if the fault output (H2-01/02/03 = E) is set when the drive attempts to restart.

No.	Name	Setting Range	Default
L5-02	Auto Restart Fault Output Operation Selection	0 or 1	0

Setting 0: No Fault Output

Setting 1: Fault Output is Set

■ **L5-04: Fault Reset Interval Time**

Determines the amount of time to wait between attempts to restart the drive when parameter L5-05 is set to 1.

No.	Name	Setting Range	Default
L5-04	Fault Reset Interval Time	0.5 to 600.0 s	10.0 s

■ **L5-05: Fault Reset Operation Selection**

No.	Name	Setting Range	Default
L5-05	Fault Reset Operation Selection	0 or 1	0

Setting 0: Count Successful Restarts

The drive will continuously attempt to restart. If a restart trial is successful, the restart counter is increased. This operation is repeated each time a fault occurs until the counter reaches the value set in L5-01.

Setting 1: Count Restart Attempts

The drive will try to restart using the time interval set in parameter L5-04. Each attempt is counted, whether it was successful or not.

◆ **L6: Torque Detection**

The drive provides two independent torque detection functions that trigger an alarm or fault signal when the load is too heavy (oL), or suddenly drops (UL). They are set up using the L6-□□ parameters. To indicate the underload or overload condition to an external device, digital outputs should be programmed as shown below.

H2-01 /02/03 Setting	Description
B	Torque detection 1, N.O. (output close when over-/underload is detected)
17	Torque detection 1, N.C. (output opens when over-/underload is detected)
18	Torque detection 2, N.O. (output close when over-/underload is detected)
19	Torque detection 2, N.C. (output opens when over-/underload is detected)

Figure 5.88 and Figure 5.89 show the function of overtorque and undertorque detection.

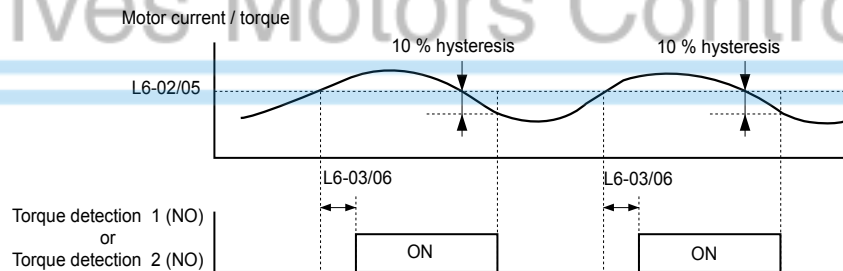

Figure 5.88 Overtorque Detection Operation

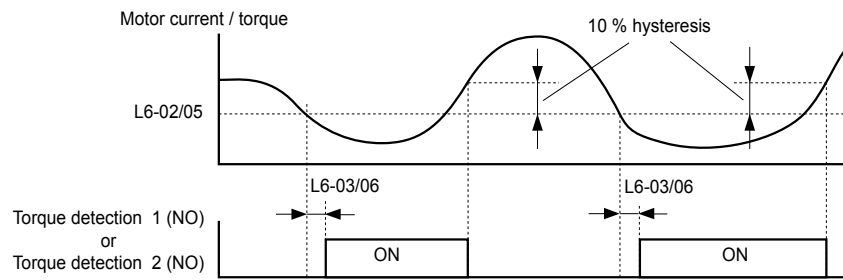

Figure 5.89 Undertorque Detection Operation

- Note:**
1. The torque detection function uses a hysteresis of 10% of the drive rated output current/motor rated torque.
 2. In V/f Control and Open Loop Vector Control for PM, the level is set as a percentage of the drive rated output current. In Open Loop Vector, it is set as a percentage of the motor rated torque.
- Note:** When overtorque occurs in the application, the drive may stop due to overcurrent (oC) or overload (oL1). To prevent this, an overload situation should be indicated to the controller before oC or oL1 occur in the drive. Use the torque detection for this purpose. Use undertorque detection to discover application problems like a torn belt, a pump shutting off, or other similar trouble.

■ L6-01/L6-04: Torque Detection Selection 1/2

The torque detection function is triggered when the current/torque exceeds the levels set in parameter L6-02/L6-05 for longer than the time set in L6-03/L6-06. The parameters L6-01/L6-04 select the detection condition and the operation at detection.

No.	Name	Setting Range	Default
L6-01/ L6-04	Torque Detection Selection 1/2	0 to 8	0

Setting 0: Disabled

Setting 1: oL3/oL4 at Speed Agree - Alarm

Overtorque detection is active only when the output speed is equal to the frequency reference, i.e., no detection during acceleration and deceleration. The operation continues after detection and an oL3/oL4 alarm is triggered.

Setting 2: oL3/oL4 at Run - Alarm

Overtorque detection works whenever a Run command is active. The operation continues after detection and an oL3/oL4 alarm is triggered.

Setting 3: oL3/oL4 at Speed Agree - Fault

Overtorque detection is active only when the output speed is equal to the frequency reference, i.e., no detection during acceleration and deceleration. The operation is stopped and an oL3/oL4 fault is triggered.

Setting 4: oL3/oL4 at Run - Fault

Overtorque detection works whenever a Run command is active. The operation is stopped and an oL3/oL4 fault is triggered.

Setting 5: UL3/UL4 at Speed Agree - Alarm

Undertorque detection is active only when the output speed is equal to the frequency reference, i.e., no detection during acceleration and deceleration. The operation continues after detection and a UL3/UL4 alarm is triggered.

Setting 6: oL5/UL5 at Run - Alarm

Undertorque detection works whenever a Run command is active. The operation continues after detection and an oL5/UL5 alarm is triggered.

Setting 7: UL5 at Speed Agree - Fault

Undertorque detection is active only when the output speed is equal to the frequency reference, i.e., no detection during acceleration and deceleration. The operation is stopped and a UL5 fault is triggered.

Setting 8: oL3/oL4 at Run - Fault

Undertorque detection works whenever a Run command is active. The operation is stopped and an oL3/oL4 fault is triggered.

■ L6-02/L6-05: Torque Detection Level 1/2

These parameters the detection levels for the torque detection functions 1 and 2.

No.	Name	Setting Range	Default
L6-02	Torque Detection Level 1	0 to 300%	150%
L6-05	Torque Detection Level 2	0 to 300%	150%

- Note:**
1. The torque detection level 1 (L6-02) can also be supplied by an analog input set to H3-02/10 = 7. In this case the analog value has priority and the setting L6-02 is disregarded. Torque detection level 2 (L6-05) cannot be set by an analog input.
 2. The detection levels for overtorque and undertorque are set as a percentage of the drive rated current when using V/f Control or Open Loop Vector Control. When using Closed Loop Vector Control, the drive sets torque detection as a percentage of the motor rated current.

■ L6-03/L6-06: Torque Detection Time 1/2

These parameters set the time that the levels set in L6-02/05 have to be exceeded before an alarm/fault is triggered.

No.	Name	Setting Range	Default
L6-03	Torque Detection Time 1	0.0 to 10.0 s	0.1 s
L6-06	Torque Detection Time 2	0.0 to 10.0 s	0.1 s

■ Mechanical Weakening Detection

This function can be used to detect mechanical weakening of a machine that leads to overtorque or undertorque situations after a certain machine operation time has elapsed.

The function is activated in the drive when the cumulative operation counter U4-01 exceeds the time set in parameter L6-11. Mechanical weakening detection uses the torque detection 1 settings (L6-01/02/03) and triggers an oL5 fault when overtorque or undertorque occurs in the speed range determined by parameter L6-08/09. The oL5 operation is set by parameter L6-08.

To output a signal for mechanical weakening detection, set H2-01, H2-02, or H2-03 to 22.

■ L6-08: Mechanical Weakening Detection Operation

Decides which speed range the function is active and sets the mechanical weakening detection operation.

No.	Name	Setting Range	Default
L6-08	Mechanical Weakening Detection	0 to 8	0

Setting 0: Disabled

Setting 1: Continue Running if the Speed is Greater than L6-09 (signed) - Alarm

Detection when the speed is above L6-09 (signed). Upon detection the operation is continued but an oL5 alarm is output.

Setting 2: Continue Running if the Speed is Greater than L6-09 - Alarm

Detection when the speed is above L6-09 (unsigned). Upon detection the operation is continued but an oL5 alarm is output.

Setting 3: Stop when Motor Speed is Greater than L6-09 (signed)

Detection when the speed is above L6-09 (signed). Upon detection the operation is stopped and an oL5 fault is output.

Setting 4: Stop when Motor Speed is Greater than L6-09

Detection when the speed is above L6-09 (unsigned). Upon detection the operation is stopped and an fault is output.

Setting 5: Continue Running if the Speed is less than L6-09 (signed) - Alarm

Detection when the speed is below L6-09 (signed). Upon detection the operation is continued but an oL5 alarm is output.

Setting 6: Continue Running if the Speed is less than L6-09 - Alarm

Detection when the speed is below L6-09 (unsigned). Upon detection the operation is continued but an oL5 alarm is output.

Setting 7: Stop when Motor Speed is less than L6-09 (signed)

Detection when the speed is below L6-09 (signed). Upon detection the operation is stopped and an oL5 fault is output.

Setting 8: Stop when Motor Speed is less than L6-09

Detection when the speed is below L6-09 (unsigned). Upon detection the operation is stopped and an oL5 fault is output.

■ L6-09: Mechanical Weakening Detection Speed Level

Sets the speed level that defines the speed range for mechanical weakening detection.

No.	Name	Setting Range	Default
L6-09	Mechanical Weakening Detection Speed Level	-110.0 to 110.0%	110%

5.8 L: Protection Functions

The value is set as a percentage of the maximum frequency. If L6-08 is set for unsigned speed detection (L6-08 = 2, 4, 6, 8) then the absolute value of L6-09 is used, i.e., negative settings will be treated as positive.

■ L6-10: Mechanical Weakening Detection Time

Sets the time permitted for the situation selected in parameter L6-08 to arise before mechanical weakening is detected.

No.	Name	Setting Range	Default
L6-10	Mechanical Weakening Detection Time	0.0 to 10.0 s	0.1 s

■ L6-11: Mechanical Weakening Detection Start Time

Sets the drives cumulative operation time at which mechanical weakening detection is activated. If U4-01 reaches the L6-11 value, the function is activated.

No.	Name	Setting Range	Default
L6-11	Mechanical Weakening Detection Start Time	0 to 65535 h	0 h

◆ L7: Torque Limit

The torque limit function can be used to limit the torque in each of the four quadrants individually and thereby protect the machinery. It can be used in the Open Loop Vector Control mode. A digital output programmed for “During Torque Limit” (H2-01/02/03 = 30) can be switched when the drive is operating at the torque limit.

■ L7-01/02/03/04: Torque Limits

These parameters set the torque limits in each operation mode.

No.	Name	Setting Range	Default
L7-01	Forward Torque Limit	0 to 300%	200%
L7-02	Reverse Torque Limit	0 to 300%	200%
L7-03	Forward Regenerative Torque Limit	0 to 300%	200%
L7-04	Reverse Regenerative Torque Limit	0 to 300%	200%

Note: If the multi-function analog input is programmed for “10: Positive Torque Limit”, “11: Negative Torque Limit”, “12: Regenerative Torque Limit”, or “15: General Torque Limit”, the drive uses the lower value of either L7-01 through L7-04, or analog input torque limit. [Refer to Setting 10/11/12/15: Positive/Negative/Regenerative/General Torque Limit \(OLV only\) on page 209](#) for details on using analog torque limits.

■ L7-06: Torque Limit Integral Time Constant

Sets the integral time constant for the torque limit function.

No.	Name	Setting Range	Default
L7-06	Torque Limit Integral Time Constant	5 to 10000 ms	200 ms

■ L7-07: Torque Limit Control Method Selection during Accel/Decel

Selects the function of torque limit during acceleration and deceleration.

No.	Name	Setting Range	Default
L7-07	Torque Limit Control Method Selection during Acceleration/Deceleration	0 or 1	0

Setting 0: Proportional Control

The torque limit function works with P-control during acceleration and deceleration and switches to I-control at constant speed. Use this setting when acceleration or deceleration to the desired speed has priority over torque limitation during speed changes.

Setting 1: Integral Control

The torque limit function always uses I-control. Use this setting when high accuracy torque limitation is required even during speed changes. Using this function may increase the acceleration time, or may prevent the motor speed from reaching the frequency reference when the torque limit is reached before.

◆ L8: Hardware Protection

■ L8-01: Internal Dynamic Braking Resistor Protection Selection (ERF type)

This parameter selects the dynamic braking resistor protection when using an optional heatsink mounted braking resistor (ERF type, 3% ED).

No.	Name	Setting Range	Default
L8-01	Internal Braking Resistor Protection	0 or 1	0

Setting 0: Disabled

Disables the braking resistor protection. Use this setting for any braking option other than the Yaskawa ERF Type resistor.

Setting 1: Enabled

Enables the protection for ERF type resistors.

■ L8-02: Overheat Alarm Level

Sets the overheat alarm (oH) detection level.

The drive will output an alarm when the heatsink temperature exceeds the alarm level set in parameter L8-02. If the temperature reaches the overheat fault level, the drive will trigger an oH1 fault and stop operation.

When an output terminal is set for the oH pre-alarm (H2-01/02/03 = 20), the switch will close when the heatsink temperature rises above L8-02.

No.	Name	Setting Range	Default
L8-02	Overheat Alarm Level	50 to 130 °C	Depending on size

■ L8-03: Overheat Pre-Alarm Operation Selection

Sets the operation when an overheat pre-alarm is detected.

No.	Name	Setting Range	Default
L8-03	Overheat Pre-Alarm Operation	0 to 4	3

Setting 0: Ramp to Stop

If an overheat alarm occurs, the drive decelerates to stop using the selected deceleration time. If a digital output is programmed for “fault” (H2-01/02/03 = E), this output will be triggered.

Setting 1: Coast to Stop

If an overheat alarm occurs, the drive switches off the output and the motor coasts to stop. If a digital output is programmed for “fault” (H2-01/02/03 = E), this output will be triggered.

Setting 2: Fast-stop

If an overheat alarm occurs, the drive decelerates to stop using the Fast-stop time (C1-09). If a digital output is programmed for “fault” (H2-01/02/03 = E), this output will be triggered.

Setting 3: Alarm Only

If an overheat alarm occurs, an alarm is output and the drive continues operation.

Setting 4: Operation with Reduced Speed

If an overheat alarm occurs, the operation is continued but the speed is reduced to the level set in parameter L8-19. If after 10 s the oH alarm is still present, the speed is reduced once more. The amount of reduction depends on how often the alarm repeats. If the oH alarm disappears while the drive is operating at a reduced speed, then the drive will switch back to the previous speed it was reduced to before. *Figure 5.90* explains the operation with reduced speed during an oH alarm. A digital output programmed for 4D is switched when the oH alarm is still active after ten reduction cycles.

5.8 L: Protection Functions

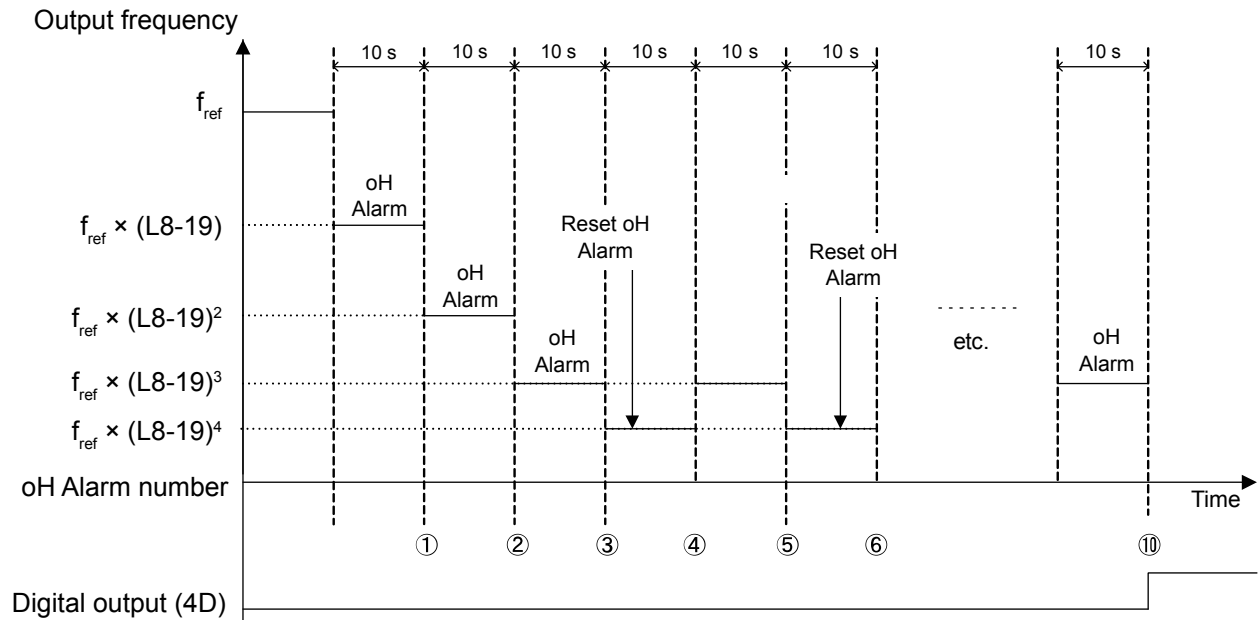

Figure 5.90 Output Frequency Reduction During Overheat Alarm

■ L8-19: Frequency Reduction Rate During Overheat Pre-Alarm

Specifies how much the output frequency is reduced when L8-03 is set to 4 and an oH alarm is present. Set as a factor of the maximum output frequency.

No.	Name	Setting Range	Default
L8-19	Frequency Reduction Rate During oH Pre-Alarm	0.1 to 0.9	0.8

■ L8-05: Input Phase Loss Protection Selection

Enables or disables the input phase loss detection.

No.	Name	Setting Range	Default
L8-05	Input Phase Loss Detection Selection	0 or 1	1

Setting 0: Disabled

Setting 1: Enabled

Enables the input phase loss detection. As detection is performed by measuring the DC bus ripple, a phase loss fault (PF) can also be triggered by power supply voltage imbalance or main circuit capacitor deterioration. Detection is disabled when:

- The drive is decelerating.
- No Run command is active.
- Output current is less than or equal to 30% of the drive rated current.

■ L8-07: Output Phase Loss Protection Selection

Enables or disables the output phase loss detection, which is triggered when the output current falls below 5% of the drive rated current.

Note: Output phase loss detection can mistakenly be triggered if the motor rated current is very small compared to the drive rating. Disable this parameter in such cases.

No.	Name	Setting Range	Default
L8-07	Output Phase Loss Protection Selection	0 to 2	1

Setting 0: Disabled

Setting 1: Fault when One Phase is Lost

An output phase loss fault (LF) is triggered when one output phase is lost. The output shuts off and the motor coasts to stop.

Setting 2: Fault when Two Phases are Lost

An output phase loss fault (LF) is triggered when two output phases are lost. The output shuts off and the motor coasts to stop.

■ L8-09: Output Ground Fault Detection Selection

Enables or disables the output ground fault detection.

No.	Name	Setting Range	Default
L8-09	Output Ground Fault Detection	0 or 1	1

Setting 0: Disabled

Ground faults are not detected.

Setting 1: Enabled

A ground fault (GF) is triggered when high leakage current or a ground short circuit occurs in one or two output phases.

■ L8-10: Heatsink Cooling Fan Operation Selection

Selects the heatsink cooling fan operation.

No.	Name	Setting Range	Default
L8-10	Fan Operation Selection	0 or 1	0

Setting 0: Run with Timer

The fan is switched on when a Run command is active. It is switched off with the delay set in parameter L8-11 after the Run command has been released. Using this setting extends the fan lifetime.

Setting 1: Run always

The fan runs whenever power is supplied to the drive.

■ L8-11: Heatsink Cooling Fan Off Delay Time

Sets the cooling fan switch off delay time if parameter L8-10 is set to 0.

No.	Name	Setting Range	Default
L8-11	Cooling Fan Switch Off Delay	0 to 300 s	60 s

■ L8-12: Ambient Temperature Setting

If the temperature where the drive is mounted is above the specified values, the drive rated current must be reduced for optimal performance life. By setting the ambient temperature to parameter L8-12 and adjusting the installation method setting in L8-35, the drive rating automatically adapts to safe values.

No.	Name	Setting Range	Default
L8-12	Ambient Temperature Setting	-10 to +50 °C	40 °C

■ L8-15: oL2 Characteristics Selection at Low Speeds

Selects whether the drive overload capability (oL fault detection level) is reduced at low speeds in order to prevent premature output transistor failures.

No.	Name	Setting Range	Default
L8-15	oL2 Characteristics at Low Speed	0 or 1	1

Setting 0: Disabled

The overload protection level is not reduced. Frequently operating the drive with high output current at low speed can lead to premature drive faults.

Setting 1: Enabled

The overload protection level (oL2 fault detection level) is automatically reduced at speeds below 6 Hz.

5.8 L: Protection Functions

■ L8-18: Software Current Limit Selection

The Software Current Limit (CLA) is a drive protection function that prevents output transistor failures caused by high current. Parameter L8-18 enables or disables this function.

Note: This setting should not be changed unless absolutely necessary. For proper drive protection and operation leave the Software CLA function enabled.

No.	Name	Setting Range	Default
L8-18	Software Current Limit Selection	0 or 1	<1>

<1> Default setting is determined by drive software version and C6-02 setting. Drive software versions PRG: 1021 and later have a default setting of 0 when the carrier frequency is set for Leakage Current Rejection PWM (C6-02 = B), and 1 when C6-02 is set to any other value.

Setting 0: Disabled

The drive may trip on an oC fault if the load is too heavy or the acceleration is too short.

Setting 1: Enabled

When the soft CLA current level is reached, the drive reduces the output voltage in order to reduce the current. If the current level drops below the Software CLA level, then normal operation will continue.

■ L8-29: Current Unbalance Detection (PM OLV only)

Current unbalance can heat up a PM motor and lead to demagnetization of the magnets from heat. The current imbalance detection function prevents such motor damage by monitoring output currents and triggering a LF2 fault in case of current unbalance.

No.	Name	Setting Range	Default
L8-29	Current Unbalance Detection (LF2)	0 or 1	1

Setting 0: Disabled

The drive does not protect the motor.

Setting 1: Enabled

When an output current imbalance is detected, a LF2 fault is triggered, the output is switched off, and the motor coasts to stop.

■ L8-35: Installation Method Selection

Selects the type of installation and changes the drive overload (oL2) limits accordingly.

- Note:**
1. This parameter is not reset when the drive is initialized.
 2. The value is preset to the appropriate value when the drive is shipped. Change the value only when using Side-by-Side installation or when mounting a standard drive with the heatsink outside the cabinet.

No.	Name	Setting Range	Default
L8-35	Installation Method Selection	0 to 3	Determined by o2-04

Setting 0: IP20/IP00 Drive

Must be selected if an IP20/IP00 drive is installed with a minimum of 30 mm space to the next drive or a cabinet wall.

Setting 1: Side-by-Side Mounting

Must be selected if drives are Side-by-Side mounted with a minimum space of 2 mm.

Setting 2: NEMA Type 1 Drive

Must be selected if the drive has a NEMA Type 1 enclosure or an IP20/Open-Chassis drive fitted with the NEMA Type 1 Kit option.

Setting 3: Finless Drive or External Heatsink Installation

Must be selected for finless drives or if a standard drive is mounted with the heatsink outside the cabinet.

■ L8-38: Carrier Frequency Reduction Selection

The drive can reduce the carrier frequency when the output current exceeds a certain level. This temporarily increases the overload capability (oL2 detection) and the drive can run through transient load peaks without tripping.

L8-38 selects the operation of the carrier frequency reduction function.

Note: This function cannot be used in Open Loop Vector for PM motors.

No.	Name	Setting Range	Default
L8-38	Carrier Frequency Reduction Selection	0 to 2	Determined by o2-04

Setting 0: Disabled

No carrier frequency reduction at high current.

Setting 1: Enabled for Output Frequencies below 6 Hz

The carrier frequency is reduced at speeds below 6 Hz when the current exceeds 100% of the drive rated current. The drive returns to its normal carrier frequency when the current falls below 88% or the output frequency exceeds 7 Hz.

Setting 2: Enabled for Entire Frequency Range

The carrier frequency is reduced at the following speeds:

- Below 6 Hz when the current exceeds 100% of the drive rated current.
- Above 7 Hz when the current exceeds 112% of the drive rated current.

The drive uses the delay time set in parameter L8-40 and a hysteresis of 12% when switching the carrier frequency back to the set value.

■ L8-40: Carrier Frequency Reduction Off Delay Time

Sets the delay time which is used to switch back to the normal carrier frequency. The carrier frequency reduction function is disabled if this value is 0 s.

No.	Name	Setting Range	Default
L8-40	Low Carrier Frequency Off Delay Time	0.00 or 2.00 s	0.50 s

■ L8-41: High Current Alarm Selection

The drive can be set to trigger a high current alarm (HCA) when the output current rises too high.

No.	Name	Setting Range	Default
L8-41	High Current Alarm Selection	0 or 1	0

Setting 0: Disabled

No alarm is output.

Setting 1: Enabled

An alarm is triggered when the output current exceeds 150% of the drive rated current. A digital output indicating an alarm (H2-01/02/03 = 10) can be programmed.

■ L8-51: STo Fault Detection Level

Note: Parameter available in drive software versions PRG: 1018 and later.

Sets the STo detection level as a percentage of the motor rated current.

Increase this value for faster detection of pull-out during acceleration. The drive calculates this value automatically when L8-51 is set to 0.0%. There is normally no need to change this parameter from the default value.

No.	Name	Setting Range	Default
L8-51	STo Fault Detection Level	0.0 to 150. %	0.0%

■ L8-54: STo Deviation Detection

Note: Parameter available in drive software versions PRG: 1018 and later.

Enables or disables the STo Deviation fault detection.

There is normally no need to change this parameter from the default value.

No.	Name	Setting Range	Default
L8-54	STo Deviation Detection	0 or 1	1

Setting 0: Disabled**Setting 1: Enabled**

5.9 n: Special Adjustments

The n parameters handle a variety of specialized adjustments and functions, including Hunting Prevention, AFR Control, High Slip Braking, resistance between motor lines, and PM motor control functions.

◆ n1: Hunting Prevention

Hunting Prevention keeps the drive from hunting as a result of low inertia and operating with light load. It is available in V/f Control only.

■ n1-01: Hunting Prevention Selection

Enables or disables the Hunting Prevention function.

Note: This function is available only when using V/f Control. Hunting Prevention should be disabled when drive response is needed over suppressing motor oscillation. This function can also be disabled without any problems in applications with high inertia loads or relatively heavy loads.

No.	Name	Setting Range	Default
n1-01	Hunting Prevention Selection	0 or 1	1

Setting 0: Disabled

Setting 1: Enabled

■ n1-02: Hunting Prevention Gain Setting

Sets the gain for the Hunting Prevention Function.

No.	Name	Setting Range	Default
n1-02	Hunting Prevention Gain Setting	0.00 to 2.50	1.00

Normally, n1-02 does not need to be changed, but adjustment may help under the following conditions:

- If the motor vibrates while lightly loaded and n1-01 = 1, increase the gain by 0.1 until vibration ceases.
- If the motor stalls while n1-01 = 1, decrease the gain by 0.1 until the stalling ceases.

■ n1-03: Hunting Prevention Time Constant

Determines how responsive the Hunting Prevention function is (affects the primary delay time for Hunting Prevention).

No.	Name	Setting Range	Default
n1-03	Hunting Prevention Time Constant	0 to 500 ms	Determined by o2-04

■ n1-05: Hunting Prevention Gain while in Reverse

This parameter is the same as n1-02, except that it is used when the motor rotates in reverse. See the setting instructions for n1-02.

Note: When set to 0 ms, n1-02 is enabled even when the drive is operating in reverse.

No.	Name	Setting Range	Default
n1-05	Hunting Prevention Gain while in Reverse	0.00 to 2.50	0.00

◆ n2: Automatic Frequency Regulator (AFR) Tuning

These parameters are used to achieve speed stability when a load is suddenly applied or removed by calculating changes in the torque current feedback and then compensating the output frequency.

Note: Before making changes to the AFR parameters, make sure the motor parameters are set properly or perform Auto-Tuning.

■ n2-01: Speed Feedback Detection Control (AFR) Gain

Sets the internal speed feedback detection control gain in the AFR.

No.	Name	Setting Range	Default
n2-01	Speed Feedback Detection Control (AFR) Gain	0.00 to 10.00	<1>

<1> Default setting is determined by drive model.

Models BA0001 to BA0012, 2A0001 to 2A0020, and 4A0001 to 4A0011: Setting 1.00.
 Models BA0018, 2A0030 to 2A0069, and 4A0018 to 4A0038: Setting 1.50.

Normally there is no need to adjust n2-01 from the default setting. Make adjustments in the following cases:

- If hunting occurs, increase the set value in steps of 0.05 while checking the response.
- If response is low, decrease the set value in steps of 0.05 while checking the response.

■ n2-02/n2-03: AFR Time Constant 1/2

Parameter n2-02 sets the time constant normally used by AFR.

Parameter n2-03 sets the time constant during Speed Search or when during regenerative operation the actual motor slip exceeds 50% of the rated slip.

No.	Name	Setting Range	Default
n2-02	AFR Time Constant 1	0 to 2000 ms	50 ms
n2-03	AFR Time Constant 2	0 to 2000 ms	750 ms

Note: Parameter n2-02 cannot be set higher than n2-03 or an oPE08 error will result.

These parameters rarely need to be changed. Adjust settings only under the following conditions.

- If hunting occurs, increase n2-02. If response is low, decrease it.
- Increase the setting of n2-03 if overvoltage (ov) failures occur with high inertia loads at the end of acceleration or when the load changes radically.
- When increasing n2-02, make sure to increase C4-02 (Torque Compensation Delay Time Constant 1) proportionally.
- When increasing n2-03, make sure to increase C4-06 (Torque Compensation Delay Time Constant 2) proportionally.

◆ n3: High Slip Braking (HSB)/Overexcitation Deceleration

High Slip Braking (V/f Control)

HSB works in V/f Control only and is used to decrease the stopping time compared to normal deceleration without using braking resistor options. HSB stops the motor by reducing the output frequency in large steps, thus producing a high slip. Regenerative energy created from decelerating the load is dissipated in the motor windings through increased motor slip. Because of the increased temperature of the motor windings, HSB should not be used for frequently stopping the motor. The duty cycle should be around 5% or less.

Notes on using High Slip Braking:

- The deceleration time that has been set is ignored during HSB.
- Braking time varies based on the load inertia and motor characteristics.
- HSB must be triggered by a digital input set to H1-□□ = 68. Once the HSB command is given, it is not possible to restart the drive until the motor is stopped and the Run command is cycled.

Use parameters n3-01 through n3-04 for adjusting HSB.

Overexcitation Deceleration (V/f Control and Open Loop Vector)

Overexcitation deceleration increases the flux during deceleration and allows shorter deceleration time settings than with normal deceleration without the use of a braking resistor. Enabled by setting L3-04 = 4.

Notes on Overexcitation Deceleration

- As regenerative energy is mainly dissipated as heat in the motor, the motor temperature will rise if overexcitation deceleration is applied frequently. In such cases, make sure the motor temperature does not exceed the maximum allowable value or consider using a braking resistor option instead.
- The drive decelerates at the active deceleration time. Make sure to set this time so that no overvoltage (ov) fault occurs.
- When a Run command is entered during overexcitation deceleration, overexcitation operation is cancelled and the drive will reaccelerate to the specified speed.
- Do not use overexcitation deceleration in combination with a braking resistor option.
- Overexcitation deceleration cannot be used in OLV/PM control mode.

Use parameters n3-13 through n3-23 for adjusting overexcitation deceleration.

■ n3-01: High Slip Braking Deceleration Frequency Width

Sets the step width for frequency reduction during HSB. Increase this value if DC bus overvoltage (ov) occurs during HSB.

5.9 n: Special Adjustments

No.	Name	Setting Range	Default
n3-01	High Slip Braking Deceleration Frequency Width	1 to 20%	5%

■ n3-02: High Slip Braking Current Limit

Sets the maximum current to be output during an HSB stop as a percentage of motor rated current (E2-01). Reducing the current limit increases the deceleration time. Make sure that this value does not exceed 150% of the drive's current rating.

No.	Name	Setting Range	Default
n3-02	High Slip Braking Current Limit	100 to 200%	150%

■ n3-03: High Slip Braking Dwell Time at Stop

When the motor reaches a relatively low speed at the end of HSB, the output frequency is kept at the minimum output frequency E1-09 for the time set in n3-03. Increase this time if the inertia is very high and the motor is still coasting after HSB is complete.

No.	Name	Setting Range	Default
n3-03	High Slip Braking Dwell Time at Stop	0.0 to 10.0 s	1.0 s

■ n3-04: High Slip Braking Overload Time

Sets the time required for an HSB overload fault (oL7) to occur when the drive output frequency does not change for some reason during an HSB stop.

No.	Name	Setting Range	Default
n3-04	High Slip Braking Overload Time	30 to 1200 s	40 s

■ n3-13: Overexcitation Deceleration Gain

Applies a gain to the V/f pattern output value during overexcitation deceleration, thereby determining the level of overexcitation. The drive returns to the normal V/f value after the motor has stopped or when it is accelerating to the frequency reference.

No.	Name	Setting Range	Default
n3-13	Overexcitation Deceleration Gain	1.00 to 1.40	1.10

The optimum setting for n3-13 depends on the motor flux saturation characteristics.

- Increase the gain by 1.25 to 1.30 to improve the breaking power of overexcitation.
- Reduce the value when the motor slip gets too high, which can trigger overcurrent (oC), motor overload (oL1), or drive overload (oL2) faults. Alternatively reduce n3-21.

■ n3-21: High Slip Suppression Current Level

If overcurrent, oL1, or oL2 occur during overexcitation deceleration, reduce the overslip suppression current level. Set as a percentage of the drive rated current.

Reduce this setting if the current during overexcitation deceleration exceeds the overslip suppression current set in n3-21 as a result of flux saturation and excessive slip. Alternatively reduce the overexcitation gain n3-13.

No.	Name	Setting Range	Default
n3-21	Overslip Suppression Current Level	0 to 150%	100%

■ n3-23: Overexcitation Operation Selection

Determines which direction overexcitation can be used in. However, parameter L3-04 must be set to 4 in order for n3-23 to be enabled.

No.	Name	Setting Range	Default
n3-23	Overexcitation Operation Selection	0 to 2	0

Setting 0: Enabled in Both Directions

Setting 1: Enabled in Forward Direction Only

Setting 2: Enabled in Reverse Direction Only

◆ n6: Motor Line-to-Line Resistance Online Tuning

The drive can tune the motor line-to-line resistance during run in order to prevent torque loss due to a rise in motor temperature increase, especially at low speeds.

■ n6-01: Motor Line-to-Line Resistance Online Tuning Selection

No.	Name	Setting Range	Default
n6-01	Motor Line-to-Line Resistance Online Tuning	0 or 1	1

Setting 0: Disabled

Setting 1: Enabled

◆ n8: PM Motor Control

These parameters are available when using the special Open Loop Vector Control for permanent magnet motors and can be used to adjust the control performance.

■ n8-45: Speed Feedback Detection Control Gain (for PM OLV)

Sets the gain for internal speed feedback detection control. Although this setting rarely needs to be changed, adjustment may be necessary under the following conditions:

- Increase this setting if motor oscillation or hunting occurs.
- Decrease this setting in increments of 0.05 to decrease the drive responsiveness.

No.	Name	Setting Range	Default
n8-45	Speed Feedback Detection Control Gain	0.00 to 10.00	0.80

■ n8-47: Pull-In Current Compensation Time Constant (for PM OLV)

Sets the time constant for making the actual current and the pull-in current agree.

Although this setting rarely needs to be changed, adjustment may be necessary under the following conditions:

- Increase this setting when it takes too long for the reference value for the pull-in current to match the target value.
- Decrease this setting if motor oscillation occurs.

No.	Name	Setting Range	Default
n8-47	Pull-In Current Compensation Time Constant	0.0 to 100.0 s	5.0 s

■ n8-48: Pull-In Current (for PM OLV)

Tells the drive the amount of d-axis current to be provided to the motor during no-load operation at a constant speed. Set as a percentage of the motor rated current.

- Increase this setting when hunting occurs or the motor speed is unstable while running at a constant speed.
- If there is too much current when driving a light load at a constant speed, then reduce this level slightly.

No.	Name	Setting Range	Default
n8-48	Pull-In Current	<>	Determined by E5-01

<1> Setting range varies depending on drive software version. Software versions PRG: 1018 and later disable pull-in current when n8-48 = 0, and allow the pull-in current to be changed during Run.

PRG: 1018 and later: 0% or 20 to 200%

PRG: 1017 and earlier: 20 to 200%

■ n8-49: d Axis Current for High Efficiency Control (for PM OLV)

Sets the amount of d axis current when using Energy Saving control as a percentage of the motor rated current.

Although this setting seldom needs to be changed, please note the following:

- If motor operation is unstable when driving heavy loads, try increasing this setting (towards 0).
- If motor parameters (E5) have been changed, this value will be reset to 0 and has to be readjusted.

5.9 n: Special Adjustments

No.	Name	Setting Range	Default
n8-49	d Axis Current for High Efficiency Control	<>	Determined by E5-01

<1> Setting range varies depending on drive software version. Software versions PRG: 1018 and later allow this parameter to be changed during Run.
 PRG: 1018 and later: -200.0 to 200.0%
 PRG: 1017 and earlier: -200.0 to 0.0%

■ n8-51: Acceleration/Deceleration Time Pull-In Current (for PM OLV)

Sets the d-axis current during acceleration and deceleration as a percentage of the motor rated current (E5-03).

Adjustments to this setting may help in the following situations:

- Increase this setting when a large amount of starting torque is required.
- Lower this setting if there is excessive current during acceleration and deceleration.

No.	Name	Setting Range	Default
n8-51	Acceleration/Deceleration Time Pull-In Current	0 to 200%	Determined by E5-01

■ n8-54: Voltage Error Compensation Time Constant (for PM OLV)

Sets the time constant for voltage error compensation. Make changes to this parameter under the following conditions:

- Adjust the value when hunting occurs at low speed.
- Increase the value in steps of 0.1 when hunting occurs with sudden load changes. Try to disable the compensation by setting n8-51 = 0 if increasing does not help.
- Increase the value when oscillations occur at start.

No.	Name	Setting Range	Default
n8-54	Voltage Error Compensation Time Constant	0.00 to 10.00	1.00

■ n8-55: Load Inertia (for PM OLV)

Sets the ratio between motor inertia and the inertia of the connected machinery. If this value is set too low, the motor may not start very smoothly, and a STo fault (Motor Step-Out) might occur.

No.	Name	Setting Range	Default
n8-55	Motor/Load Inertia Ratio	0 to 3	0

Setting 0: Below 1:10

The inertia ratio between the motor and the load is just less than 1:10.

Setting 1: Between 1:10 and 1:30

The inertia ratio between the motor and the load is between 1:10 and 1:30. Set n8-55 to 1 if a STo fault occurs as a result of impact load or sudden acceleration/deceleration when n8-55 = 0.

Setting 2: Between 1:30 and 1:50

The inertia ratio between the motor and the load is between 1:30 and 1:50. Set n8-55 to 2 if a STo fault occurs as a result of impact load or sudden acceleration/deceleration when n8-55 = 1.

Setting 3: Beyond 1:50

The inertia ratio between the motor and the load is higher than 1:50. Set n8-55 to 3 if a STo fault occurs as a result of impact load or sudden acceleration/deceleration when n8-55 = 2.

■ n8-62: Output Voltage Limit (for PM OLV)

Sets the output voltage limit to prevent output voltage saturation. This value should not be set higher than the actual input voltage.

No.	Name	Setting Range	Default
n8-62	Output Voltage Limit	0.0 to 230.0 Vac <>	230 Vac <>

<1> Values shown here are for 200 V class drives. Double values when using a 400 V class drive.

■ n8-63/n8-68: Output Voltage Limit Gain 1/2

n8-63 sets the gain for the output voltage limit in 0.01 units. n8-68 sets the voltage detection level adjustment gain. There is normally no need to change these parameters from their default values.

No.	Name	Setting Range	Default
n8-63	Output Voltage Limit Gain 1	0.00 to 100.00	1.00
n8-68	Output Voltage Limit Gain 2	0.50 to 1.50	0.95

■ n8-65: Speed Feedback Detection Control Gain during ov Suppression (for PM OLV)

Sets the gain for internal speed feedback detection control when overvoltage suppression is active. Although this setting rarely needs to be changed, adjustment may be necessary under the following conditions:

- Increase this setting if motor oscillation or hunting occurs when ov suppression is active.
- Decrease this setting in increments of 0.05 to decrease the drive responsiveness during ov suppression.

No.	Name	Setting Range	Default
n8-65	Speed Feedback Detection Control Gain during Overvoltage Suppression	0.00 to 10.00	1.50

■ n8-87: Output Voltage Limit Selection

Note: Parameter available in drive software versions PRG: 1018 and later.

Determines the method of the output voltage limit. Use the feed-forward method if oscillation occurs in the constant output range. There is normally no need to change this parameter from its default value.

No.	Name	Setting Range	Default
n8-87	Output Voltage Limit Selection	0 or 1	0

Setting 0: Feedback Method

Setting 1: Feed-Forward Method

■ n8-88: Output Voltage Limit Switching Current Level

Note: Parameter available in drive software versions PRG: 1018 and later.

Sets the current level to switch the output voltage limit sequence. Set as a percentage of the motor rated current (E5-03). There is normally no need to change this parameter from its default value.

No.	Name	Setting Range	Default
n8-88	Output Voltage Limit Switching Current Level	0 to 400%	400%

■ n8-89: Output Voltage Limit Switching Current Hysteresis Width

Note: Parameter available in drive software versions PRG: 1018 and later.

Determines the hysteresis of the current level to switch the output voltage limit sequence. Set as a percentage of the motor rated current (E5-03).

No.	Name	Setting Range	Default
n8-89	Output Voltage Limit Switching Current Hysteresis Width	0 to [n8-88]	3%

■ n8-90: Output Voltage Limit Switching Speed

Note: Parameter available in drive software versions PRG: 1018 and later.

Sets the speed level to switch the output voltage limit sequence. Set as a percentage of the maximum output frequency (E1-04).

No.	Name	Setting Range	Default
n8-90	Output Voltage Limit Switching Speed	0 to 200%	200%

5.9 n: Special Adjustments

■ n8-91: Id Limit for Output Voltage Limit Control

Note: Parameter available in drive software versions PRG: 1018 and later.

Sets the amount of pull-in current that flows through the motor while operating at constant speed. Set as a percentage of the motor rated current (E5-03). Increase this setting if hunting occurs at constant speed.

No.	Name	Setting Range	Default
n8-91	Id Limit for Output Voltage Limit Control	-200 to 0%	-50%

The logo consists of the letters 'D', 'M', and 'C' in a large, bold, light blue font with a white outline. The letters are spaced out and centered horizontally.

Drives Motors Controls

5.10 o: Operator Related Settings

These parameters concern the various functions and features of the digital operator.

◆ o1: Display Settings and Selections

These parameters determine how data is shown on the operator display.

■ o1-01: Drive Mode Unit Monitor Selection

When using an LED operator, pressing the up arrow key on the drive will display the following data: frequency reference → rotational direction → output frequency → output current → o1-01 selection.

Parameter o1-01 selects the content of the last monitor in this sequence. There is no effect like this on an LCD operator.

No.	Name	Setting Range	Default
o1-01	Drive Mode Unit Monitor Selection	104 to 810 (U1-04 to U8-10) </>	106 (U1-06)

<1> U2-□□ and U3-□□ parameters cannot be selected.

To select a monitor parameter, set the three numeric digits that make up that monitor. This is done by entering the □-□□ part of U□-□□. For a list of monitors, [Refer to U: Monitor Parameters on page 254.](#)

■ o1-02: User Monitor Selection after Power Up

Selects which monitor parameter will be displayed upon power up. Defaulted to show the frequency reference when the drive is first turned on.

No.	Name	Setting Range	Default
o1-02	User Monitor Selection after Power Up	1 to 5	1

Setting 1: Frequency Reference (U1-01)

Setting 2: Forward/Reverse

Setting 3: Output Frequency (U1-02)

Setting 4: Output Current (U1-03)

Setting 5: User Selected Monitor (set by o1-01)

Setting 5 displays the monitor selected from the U parameter by o1-01.

■ o1-03: Digital Operator Display Selection

Sets the units used to display the frequency reference and output frequency.

Set this parameter to 3 for user-set units before setting parameters o1-10 and o1-11.

No.	Name	Setting Range	Default
o1-03	Digital Operator Display Selection	0 to 3	0

Setting 0: 0.01 Hz Units

Setting 1: 0.01% Units

100% = max output frequency.

Setting 2: r/min Units

Calculated by the max output frequency and the number of motor poles.

Note: Setting 2 requires entering the number of motor poles to E2-04, E4-04, and E5-04.

Setting 3: User-Set Units (use o1-01 and 01-11)

Set the value used for the maximum frequency reference to o1-10, then set the placement of the decimal point in this number to o1-11.

For example, to display the maximum output frequency as “100.00”, set o1-10 to 10000 and o1-11 to 2 (i.e., 10000 with two numbers to the right of the decimal point).

Note: Parameter o1-03 allows the programmer to change the units used in the following parameters and monitors:

5.10 o: Operator Related Settings

U1-01: Frequency Reference
U1-02: Output Frequency
U1-05: Motor Speed
U1-16: Output Frequency after Soft-Starter (Accel/Decel Ramp Generator)
d1-01 to d1-17: Frequency References

■ o1-05: LCD Contrast Control

Note: Parameter available in drive software versions PRG: 1022 and later.

Sets the brightness of the optional LCD operator. The lower the setting, the brighter the LCD contrast. The higher the setting, the darker the LCD contrast.

No.	Name	Setting Range	Default
o1-05	LCD Contrast Control	0 to 5	3

■ o1-10: User-Set Display Units Maximum Value

Determines the display value that is equal to the maximum output frequency. The decimal number is defined by parameter o1-11.

Note: This setting changes automatically when o1-03 is changed. o1-10 can only be adjusted when o1-03 is set to 3.

No.	Name	Setting Range	Default
o1-10	User-Set Display Units Maximum Value	1 to 60000	Determined by o1-03

■ o1-11: User-Set Display Units Decimal Display

Determines the number of digits for user-set display if o1-03 is set to 3. The setting value is equal to the number of decimal places. The maximum display value is defined by o1-10.

Note: This setting changes automatically when o1-03 is changed. o1-11 can only be adjusted when o1-03 is set to 3.

No.	Name	Setting Range	Default
o1-11	User-Set Display Units Decimal Display	0 to 3	Determined by o1-03

◆ o2: Operator Key Selections

These parameters determine the functions assigned to the operator keys.

■ o2-01: LO/RE (LOCAL/REMOTE) Key Function Selection

Parameter o2-01 determines whether the LO/RE key on the digital operator will be enabled or not for switching between LOCAL and REMOTE.

No.	Name	Setting Range	Default
o2-01	LO/RE Key Function Selection	0 or 1	1

Setting 0: Disabled

The LO/RE key is disabled.

Setting 1: Enabled

The LO/RE switches between LOCAL and REMOTE operation. Switching is possible during stop only. When LOCAL is selected, the LED indicator on the LO/RE key will light up.

WARNING! Sudden Movement Hazard. The drive may start unexpectedly if the Run command is already applied when switching from LOCAL mode to REMOTE mode when b1-07 = 1, resulting in death or serious injury. Be sure all personnel are clear of rotating machinery and electrical connections prior to switching between LOCAL mode and REMOTE mode.

■ o2-02: STOP Key Function Selection

Selects if the STOP key on the digital operator can be used to stop the operation when the drive is controlled from a remote source (i.e., not from digital operator).

No.	Name	Setting Range	Default
o2-02	STOP Key Function Selection	0 or 1	1

Setting 0: Disabled

The STOP key has no function when the drive is controlled by a source other than the digital operator. The drive can only be stopped from the Run command source that has been selected.

Setting 1: Enabled

The STOP key can be used to terminate the operation, even if the Run command source is not assigned to the digital operator. If operation has been interrupted by pressing the STOP key, the Run command must be cycled to restart the drive.

■ o2-03: User Parameter Default Value

Once drive parameters are set up completely, the values set can be saved as “User Initialization Values” by setting parameter o2-03. Once this has been done, the “Initialize Parameters” parameter (A1-03) will offer the choice of “1110: User Initialize”. Choosing A1-03 = “1110: User Initialize”, will reset all parameters to the values saved as “User Initialization Values”. *Refer to A1-03: Initialize Parameters on page 117* for details on drive initialization.

No.	Name	Setting Range	Default
o2-03	User Parameter Default Value	0 to 2	0

Setting 0: No Change

All “User Initialization Values” are saved as they are.

Setting 1: Set User Initialization Values

The current parameter settings are saved as “User Initialization Values”. After setting o2-03 to 1 and pressing the ENTER key, the values are saved and the display returns to 0.

Setting 2: Clear User Initialization Values

All “User Initialization Values” are cleared. After setting o2-03 to 2 and pressing the ENTER key, the values are erased and the display returns to 0. A1-03 = 1110 becomes invalid.

■ o2-04: Drive Model Selection

Parameter o2-04 matches the control board to the drive hardware. Proper setting of o2-04 is important for optimal performance and proper protection for the drive hardware. This parameter is configured at the factory and does not normally require adjustment in the field. It is available primarily to accommodate control board replacement in the event of damage.

No.	Name	Setting Range	Default
o2-04	Drive Model Selection	-	Depending on drive size

- Note:**
1. *Refer to Defaults by Drive Model and Duty Rating (ND/HD) on page 409* for a list of o2-04 settings and parameters that change depending on the drive model selection.
 2. Drive performance will suffer if the correct drive capacity is not set to o2-04, and protective functions will fail to operate properly.
 3. This parameter is not reset to the default value when the drive is initialized using A1-03.

■ o2-05: Frequency Reference Setting Method Selection

Determines if the ENTER key must be used to input a frequency reference from the digital operator.

No.	Name	Setting Range	Default
o2-05	Frequency Reference Setting Method Selection	0 or 1	0

Setting 0: ENTER Key Required

Every change in the frequency reference setting on the digital operator has to be finalized by pressing the ENTER key before it becomes effective.

Setting 1: ENTER Key Not Required

The output frequency changes immediately when the reference is changed by the UP and DOWN key on the digital operator. The ENTER key does not need to be pressed. The frequency reference is saved five seconds after the Up or DOWN key has been released. If an undervoltage error (Uv) occurs within 5 seconds of pressing the ENTER key, the frequency reference will not be saved to memory. The digital operator display flashes when settings can be made to the frequency reference.



Figure 5.91 Ready to Set Frequency Reference

■ o2-06: Operation Selection when Digital LCD Operator is Disconnected

Determines if the drive will stop when an external LCD operator is removed in LOCAL mode or with b1-02 set to 0.

Note: An LCD operator is available as an option. This setting is not applicable to the standard LED operator that comes with the drive.

No.	Name	Setting Range	Default
o2-06	Digital Operator Disconnection Operation	0 or 1	0

Setting 0: Continue Operation

The operation is continued.

Setting 1: Trigger a Fault

The operation is stopped and an oPr fault is triggered. The motor coasts to stop.

■ o2-07: Motor Direction at Power Up when Using Operator

Determines the direction the motor will rotate after the drive is powered up when the Run command is set to be given from the digital operator.

Note: This parameter is effective only when the Run command is set to be given from the digital operator (b1-02/16 = 0).

No.	Name	Setting Range	Default
o2-07	Motor Direction at Power Up when Using Operator	0 or 1	0

Setting 0: Forward

Setting 1: Reverse

◆ o3: Copy Function

Use o3 parameters to Read, Copy, and Verify the parameter settings to and from the drive.

■ o3-01: Copy Function Selection

This parameter controls the copying of parameters to and from the LED operator (option). The copy function will change certain parameter default settings depending on the regional specification of the drive.

No.	Name	Setting Range	Default
o3-01	Copy Function Selection	0 to 3	0

0: COPY SELECT (no function)

1: INV --> OP READ

All parameters are copied from the drive to the digital operator.

Note: Set o3-02 to 1 to unlock copy protection.

2: OP --> INV WRITE

All parameters are copied from the digital operator to the drive.

3: OP<-->INV VERIFY

Parameter settings in the drive are compared to those in the digital operator.

Note: When using the copy function, the drive model number (o2-04) and the software number (U1-14) must match or an error will occur.

■ o3-02 Copy Allowed Selection

Enables and disables the digital operator copy functions.

No.	Name	Setting Range	Default
o3-02	Copy Allowed Selection	0, 1	0

0: Disabled

No digital operator copy functions are allowed

1: Enabled

Copying allowed

◆ o4: Maintenance Monitor Settings

■ o4-01: Accumulated Operation Time Setting

Parameter o4-01 sets the cumulative operation time and allows the user to set the starting value of the accumulated operation time displayed in monitor U4-01.

Note: The value in o4-01 is set in 10 h units. For example, a setting of 30 will set the cumulative operation time counter to 300 h. 300 h will also be displayed in monitor U4-01.

No.	Name	Setting Range	Default
o4-01	Accumulated Operation Time Setting	0 to 9999	0

■ o4-02: Accumulated Operation Time Selection

Selects the conditions for what is to be considered “accumulated operation time.” Accumulated operation time is displayed in U4-01.

No.	Name	Setting Range	Default
o4-02	Accumulated Operation Time Selection	0 or 1	0

Setting 0: Power On Time

The drive logs the time it is connected to a power supply, no matter if the motor is running or not.

Setting 1: Run Time

The drive logs the time that the output is active, i.e., whenever a Run command is active (even if the motor is not rotating) or a voltage is output.

■ o4-03: Cooling Fan Operation Time/Maintenance Setting

Sets the value of the cooling fan operation time counter displayed in monitor U4-03. Parameter o4-03 also sets the base value used for the cooling fan maintenance value displayed in U4-04. Be sure to reset this parameter back to 0 if the cooling fan is replaced.

- Note:**
1. The value in o4-03 is set in 10 h units. For example, a setting of 30 will set the cooling fan operation time counter to 300 h. “300” will be displayed in monitor U4-03.
 2. The actual maintenance time depends on the environment the drive is used in.

No.	Name	Setting Range	Default
o4-03	Cooling Fan Operation Time	0 to 9999	0

■ o4-05: Capacitor Maintenance Setting

Sets value of the maintenance monitor for the DC bus capacitors displayed in U4-05 as a percentage of the total expected performance life. This value should be reset to 0 when the DC bus capacitors have been replaced.

Note: The actual maintenance time will depend on the environment the drive is used in.

No.	Name	Setting Range	Default
o4-05	Capacitor Maintenance Setting	0 to 150%	0%

■ o4-07: DC Bus Pre-charge Relay Maintenance Setting

Sets the value of the softcharge bypass relay maintenance time displayed in U4-06 as a percentage of the total expected performance life. This value should be reset to 0 when the relay has been replaced.

Note: The maintenance actual time depends on the environment the drive is used in.

5.10 o: Operator Related Settings

No.	Name	Setting Range	Default
o4-07	DC Bus Pre-charge Relay Maintenance Setting	0 to 150%	0%

■ o4-09: IGBT Maintenance Setting

Sets the value of the IGBT maintenance time displayed in U4-07 as a percentage of the total expected performance life. This value should be reset to 0 when the IGBTs have been replaced.

Note: The actual maintenance time depends on the environment the drive is used in.

No.	Name	Setting Range	Default
o4-09	IGBT Maintenance Setting	0 to 150%	0%

■ o4-11: U2, U3 Initialization

When the drive is initialized, the fault trace and fault history monitors (U2-□□ and U3-□□) are not reset. Parameter o4-11 can be used to initialize them.

No.	Name	Setting Range	Default
o4-11	U2, U3 Initialization	0 or 1	0

Setting 0: No Action

The drive keeps a record of the fault trace and fault history.

Setting 1: Reset Fault Data

Resets the data for the U2-□□ and U3-□□ monitors. Once o4-11 is set to 1 and the ENTER key is pressed, the fault data are erased and the display returns to 0.

■ o4-12: kWh Monitor Initialization

The kWh monitors U4-10 and U4-11 are not initialized when the power is cycled or the drive is initialized. o4-12 can be used to manually reset them.

No.	Name	Setting Range	Default
o4-12	kWh Monitor Initialization	0 or 1	0

Setting 0: No Action

The kWh data are kept as they are.

Setting 1: Reset kWh Data

Resets the kWh counter. The monitors U4-10 and U4-11 will show 0. Once o4-12 is set to 1 and the ENTER key is pressed, the kWh data are erased and the display returns to 0.

■ o4-13: Number of Run Commands Counter Initialization

The Run command counter displayed in U4-02 is not reset when the power is cycled or the drive is initialized. Using o4-13 it can be manually reset to 0.

No.	Name	Setting Range	Default
o4-13	Number of Run Commands Counter Reset	0 or 1	0

Setting 0: No Action

The Run command data are kept as they are.

Setting 1: Reset Run Commands Counter

Resets the Run commands counter. The monitor U4-02 will show 0. Once o4-13 is set to 1 and the ENTER key is pressed, the counter value is erased and the display returns to 0.

◆ q: DriveWorksEZ Parameters

■ q1-01 to q6-07: Reserved for Use by DriveWorksEZ

These parameters are reserved for use with DriveWorksEZ. Refer to the DriveWorksEZ manual for more information.

◆ r: DriveWorksEZ Connection Parameters**■ r1-01 to r1-40: DriveWorksEZ Connection Parameters**

These parameters are reserved for use with DriveWorksEZ. Refer to the DriveWorksEZ manual for more information.

◆ T: Motor Tuning

Auto-Tuning automatically sets and tunes parameters required for optimal motor performance.

Refer to [Auto-Tuning on page 102](#) for details on Auto-Tuning parameters.



5.11 U: Monitor Parameters

Monitor parameters let the user view various aspects of drive performance as it is shown on the operator display.

Some monitors can be output from terminal AM by assigning the specific monitor parameter number to H4-01. *Refer to H4-01: Multi-Function Analog Terminal AM Monitor Selection on page 210* for details on assigning functions to the analog output.

◆ U1: Operation Status Monitors

Status monitors display drive status like output frequency, current etc. Refer to U1: Operation Status Monitors on page [399](#) for a complete list of U1-□□ monitors and descriptions.

◆ U2: Fault Trace

These monitor parameters are used to view the status of various drive aspects when a fault occurs. This information is helpful for finding out why a fault occurred. Refer to U2: Fault Trace on page [400](#) for a complete list of U2-□□ monitors and descriptions.

U2-□□ monitors are not reset when the drive is initialized. *Refer to o4-11: U2, U3 Initialization on page 252* for instructions to initialize the fault trace.

◆ U3: Fault History

These parameters display faults that have occurred during operation as well as the drive operation time when those faults occurred. Refer to U3: Fault History on page [401](#) for a complete list of U3-□□ monitors and descriptions.

U3-□□ monitors are not reset when the drive is initialized. *Refer to o4-11: U2, U3 Initialization on page 252* for instructions to initialize the fault trace.

◆ U4: Maintenance Monitors

Maintenance monitors show:

- Runtime data of the drive and cooling fans, and number of Run commands issued.
- Maintenance data and replacement information for various drive components.
- kWh data.
- Highest peak current that has occurred and output frequency at the time the peak current occurred.
- Motor overload status information.
- Detailed information about the present Run command and frequency reference source selection.

Refer to U4: Maintenance Monitors on page [402](#) for a complete list of U4-□□ monitors and descriptions.

◆ U5: PID Monitors

These monitors display various aspects of PID control. *Refer to PID Block Diagram on page 138* for a description of where each monitor is located in the PID control block.

Refer to U5: PID Monitors on page [403](#) for a complete list of U5-□□ monitors and descriptions.

◆ U6: Control Monitors

Control monitors show:

- Reference data for the output voltage and vector control.
- ASR monitors. *Refer to C5: Automatic Speed Regulator (ASR) on page 154* for details and an illustration that shows where in the ASR block the monitors are located.
- The offset value added to the frequency reference by the Frequency Offset function. *Refer to Setting 44/45/46: Offset Frequency 1/2/3 Addition on page 192.*
- The bias value added to the frequency reference by the Up/Down 2 function. *Refer to Setting 75/76: Up/Down 2 on page 193.*

Refer to U6: Control Monitors on page [404](#) for a complete list of U6-□□ monitors and descriptions.

Note: Fix monitors U6-80 to U6-99 for communication options. Monitor content will vary based on the communication option card connected to the drive. Refer to the option manual for more information.

◆ U8: DriveWorksEZ Monitors

These monitors are reserved for use with DriveWorksEZ.



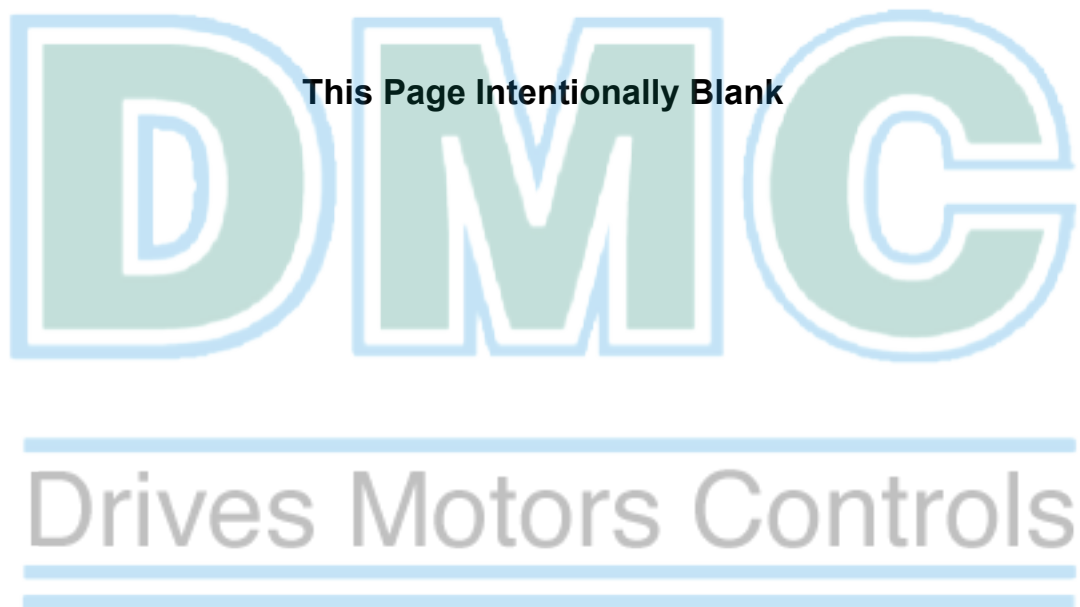

Troubleshooting

This chapter provides descriptions of the drive faults, alarms, errors, related displays, and possible solutions. This chapter can also serve as a reference guide for tuning the drive during a trial run.

6.1	SECTION SAFETY.....	258
6.2	MOTOR PERFORMANCE FINE TUNING.....	260
6.3	DRIVE ALARMS, FAULTS, AND ERRORS.....	263
6.4	FAULT DETECTION.....	267
6.5	ALARM DETECTION.....	282
6.6	OPERATOR PROGRAMMING ERRORS.....	291
6.7	AUTO-TUNING FAULT DETECTION.....	295
6.8	DIAGNOSING AND RESETTING FAULTS.....	298
6.9	TROUBLESHOOTING WITHOUT FAULT DISPLAY.....	300

Drives Motors Controls

6.1 Section Safety

DANGER

Electrical Shock Hazard

Do not connect or disconnect wiring while the power is on.

Failure to comply will result in death or serious injury.

WARNING

Electrical Shock Hazard

Do not operate equipment with covers removed.

Failure to comply could result in death or serious injury.

The diagrams in this section may illustrate drives without covers or safety shields to display details. Be sure to reinstall covers or shields before operating the drives and run the drives according to the instructions described in this manual.

Always ground the motor-side grounding terminal.

Improper equipment grounding could result in death or serious injury by contacting the motor case.

Do not touch terminals before the capacitors have fully discharged.

Failure to comply could result in death or serious injury.

Before wiring terminals, disconnect all power to the equipment. The internal capacitor remains charged even after the drive input power is turned off. The charge indicator LED will extinguish when the DC bus voltage is below 50 Vdc. To prevent electric shock, wait at least five minutes after all indicators are off and measure the DC bus voltage level to confirm safe level.

Do not allow unqualified personnel to perform work on the drive.

Failure to comply could result in death or serious injury.

Installation, maintenance, inspection and servicing must be performed only by authorized personnel familiar with installation, adjustment and maintenance of AC drives.

Do not perform work on the drive while wearing loose clothing, jewelry, or without eye protection.

Failure to comply could result in death or serious injury.

Remove all metal objects such as watches and rings, secure loose clothing and wear eye protection before beginning work on the drive.

Do not remove covers or touch circuit boards while the power is on.

Failure to comply could result in death or serious injury.

Fire Hazard

Tighten all terminal screws to the specified tightening torque.

Loose electrical connections could result in death or serious injury by fire due to overheating of electrical connections.

Do not use an improper voltage source.

Failure to comply could result in death or serious injury by fire.

Verify that the rated voltage of the drive matches the voltage of the incoming drive input power before applying power.

Do not use improper combustible materials.

Failure to comply could result in death or serious injury by fire.

Attach the drive to metal or other noncombustible material.

NOTICE

Observe proper electrostatic discharge procedures (ESD) when handling the drive and circuit boards.

Failure to comply may result in ESD damage to the drive circuitry.

Never connect or disconnect the motor from the drive while the drive is outputting voltage.

Improper equipment sequencing could result in damage to the drive.

Do not use unshielded cable for control wiring.

Failure to comply may cause electrical interference resulting in poor system performance. Use shielded twisted-pair wires and ground the shield to the ground terminal of the drive.

Do not allow unqualified personnel to use the product.

Failure to comply could result in damage to the drive or braking circuit.

Carefully review instruction manual TOBPC72060000 when connecting a braking option to the drive.

Do not modify the drive circuitry.

Failure to comply could result in damage to the drive and will void warranty.

Yaskawa is not responsible for modification of the product made by the user.

Check all the wiring after installing the drive and connecting other devices to ensure that all connections are correct.

Failure to comply could result in damage to the drive.

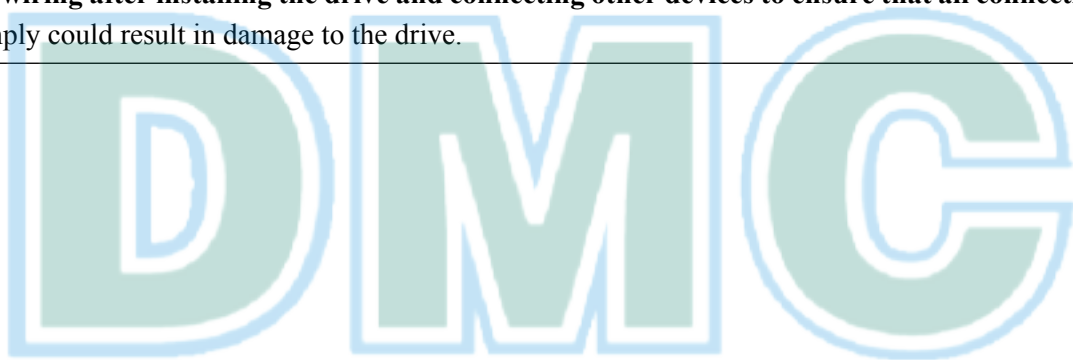
The logo for DMC (Drives Motors Controls) is displayed in a large, light blue, outlined font. The letters 'D', 'M', and 'C' are stylized and spaced out.The tagline 'Drives Motors Controls' is written in a grey, sans-serif font, centered below the logo. It is flanked by two horizontal blue lines above and below the text.

6.2 Motor Performance Fine Tuning

This section offers helpful information for counteracting oscillation, hunting, or other faults that occur while performing a trial run. Refer to the section below that corresponds to the motor control method used.

Note: This section describes parameters that are commonly edited. Consult Yaskawa for more information on detailed settings and fine-tuning the drive.

◆ V/f Motor Control Method Tuning

Table 6.1 Parameters for Tuning the Drive in V/f Motor Control Method

Problem	Parameter	Corrective Action	Default Value	Suggested Setting
<ul style="list-style-type: none"> Motor hunting and oscillation at speeds between 10 and 40 Hz 	Hunting Prevention Gain (n1-02)	<ul style="list-style-type: none"> If insufficient motor torque relative to the size of the load causes hunting, reduce the setting. When motor hunting and oscillation occur with a light load, increase the setting. Lower this setting if hunting occurs when using a motor with a relatively low inductance, such as a high-frequency motor or a motor with a larger frame size. 	1.00	0.10 to 2.00
<ul style="list-style-type: none"> Motor noise Motor hunting and oscillation at speeds up to 40 Hz 	Carrier Frequency Selection (C6-02)	<ul style="list-style-type: none"> If the motor noise is too loud, increase the carrier frequency. When motor hunting and oscillation occur at speeds up to 40 Hz, lower the carrier frequency. The default setting for the carrier frequency depends on the drive capacity (o2-04) and the Drive Duty Selection (C6-01). 	7 (Swing PWM 1)	1 to A
<ul style="list-style-type: none"> Poor torque or speed response Motor hunting and oscillation 	Torque Compensation Primary Delay Time (C4-02)	<ul style="list-style-type: none"> If motor torque and speed response are too slow, decrease the setting. If motor hunting and oscillation occur, increase the setting. 	200 ms </>	100 to 1000 ms
<ul style="list-style-type: none"> Poor motor torque at speeds below 10 Hz Motor hunting and oscillation 	Torque Compensation Gain (C4-01)	<ul style="list-style-type: none"> If motor torque is insufficient at speeds below 10 Hz, increase the setting. If motor hunting and oscillation with a relatively light load, decrease the setting. 	1.00	0.50 to 1.50
<ul style="list-style-type: none"> Poor motor torque at low speeds Motor instability at motor start 	Mid Output Voltage A (E1-08) Minimum Output Voltage (E1-10)	<ul style="list-style-type: none"> If torque is insufficient at speeds below 10 Hz, increase the setting. If motor instability occurs at motor start, decrease the setting. <p>Note: The recommended setting value is for 200 V class drives. Double this value when using a 400 V class drive.</p>	E1-08: 18.4 V E1-10: 13.8 V </>	Initial value ±5 V
<ul style="list-style-type: none"> Poor speed precision 	Slip Compensation Gain (C3-01)	<ul style="list-style-type: none"> After setting the motor-rated current (E2-01), motor-rated slip (E2-02) and motor no-load current (E2-03), adjust the slip compensation gain (C3-01). 	-	0.5 to 1.5

<1> Default settings change when the Control Method is changed (A1-02) or a different V/f pattern is selected using parameter E1-03. The default setting shown is for V/f Control.

Note: Use slip compensation to improve speed precision in V/f Control. First make sure that the proper values have been set for the motor rated current to E2-01, motor rated slip (E2-02), and motor no-load current (E2-03). Next, adjust the slip compensation gain set to C3-01 so that it is between 0.5 to 1.5.

◆ Open Loop Vector (OLV) Motor Control Method Tuning

Table 6.2 Parameters for Tuning the Drive in OLV Motor Control Method

Problem	Parameter No.	Corrective Action	Default Value	Suggested Setting
<ul style="list-style-type: none"> Poor motor torque and speed response Control motor hunting and oscillation at speeds between 10 and 40 Hz. 	AFR Gain (n2-01)	<ul style="list-style-type: none"> If motor torque and speed response are too slow, gradually decrease the setting by 0.05. If motor hunting and oscillation occur, gradually increase the setting by 0.05. 	<>	0.50 to 2.00
<ul style="list-style-type: none"> Poor motor torque and speed response Control motor hunting and oscillation at speeds between 10 and 40 Hz. 	AFR Time Constant 1 (n2-02)	<ul style="list-style-type: none"> To improve motor torque speed response, gradually reduce this setting by 10 ms and check the performance. If motor hunting and oscillation occur as a result of load inertia, gradually increase the setting by 50 ms and check the performance. <p>Note: Ensure that $n2-02 \leq n2-03$. When making adjustments to n2-02, set C4-02 (Torque Compensation Primary Delay Time Constant 1) accordingly.</p>	50 ms	50 to 2000 ms
<ul style="list-style-type: none"> Overvoltage trips when accelerating, decelerating, or during sudden speed or load changes. 	AFR Time Constant 2 (n2-03)	<ul style="list-style-type: none"> If overvoltage trips occur, gradually increase this setting by 50 ms. If response is slow, gradually reduce this setting by 10 ms. <p>Note: Ensure that $n2-02 \leq n2-03$. When making adjustments to n2-03, increase the value of C4-06 (Torque Compensation Primary Delay Time 2) proportionally.</p>	750 ms	750 to 2000 ms
	Torque Compensation Primary Delay Time Constant 2 (C4-06)	<ul style="list-style-type: none"> If overvoltage trips occur, gradually increase this setting by 10 ms and check the performance. If response is slow, gradually reduce this setting by 2 ms and check the performance. <p>Note: Ensure that $C4-02 \leq C4-06$. When changing C4-06 (Torque Compensation Primary Delay Time Constant 2), increase the value of n2-03 proportionally.</p>	150 ms	150 to 750 ms
<ul style="list-style-type: none"> Poor motor torque and speed response Motor hunting and oscillation. 	Torque Compensation Primary Delay Time Constant 1 (C4-02)	<ul style="list-style-type: none"> To improve motor torque speed response, gradually reduce this setting by 2 ms and check the performance. If motor hunting and oscillation occur, gradually increase this setting by 10 ms. <p>Note: Ensure that $C4-02 \leq C4-06$. When making adjustments to C4-02, increase n2-02 (AFR Time Constant) proportionally.</p>	20 ms <>	20 to 100 ms
<ul style="list-style-type: none"> Poor speed response and stability 	Slip Compensation Primary Delay Time Constant (C3-02)	<ul style="list-style-type: none"> If response is slow, gradually decrease the setting by 10 ms. If speed is unstable, gradually increase the setting by 10 ms. 	200 ms <>	100 to 500 ms
<ul style="list-style-type: none"> Poor speed precision 	Slip Compensation Gain (C3-01)	<ul style="list-style-type: none"> If speed is too slow, gradually increase the setting by 0.1 ms. If speed is too fast, gradually decrease the setting by 0.1 ms. 	1.0 <>	0.5 to 1.5
<ul style="list-style-type: none"> Motor noise Control motor hunting and oscillation occur at speeds below 10 Hz. 	Carrier Frequency Selection (C6-02)	<ul style="list-style-type: none"> If there is too much motor noise, the carrier frequency is too high. If motor hunting and oscillation occur at low speeds, reduce the carrier frequency. The default setting for the carrier frequency depends on the drive capacity (o2-04) and Drive Duty Selection (C6-01). 	7 (Swing PWM 1)	0 to the default setting

6.2 Motor Performance Fine Tuning

Problem	Parameter No.	Corrective Action	Default Value	Suggested Setting
<ul style="list-style-type: none"> Poor motor torque at low speeds Poor speed response Motor instability at motor start. 	Mid Output Voltage A (E1-08) Minimum Output Voltage (E1-10)	<ul style="list-style-type: none"> If motor torque and speed response are too slow, increase the setting. If the motor exhibits excessive instability at start-up, reduce the setting. <p>Note: The default value is for 200 V class units. Double this value when using a 400 V class drive. When working with a relatively light load, increasing this value too much can create an excessively high of a torque reference.</p>	E1-08: 12.0 V <2> E1-10: 2.5 V <2>	Initial ±2 V

<1> Default setting is determined by drive model.

Models BA0001 to BA0012, 2A0001 to 2A0020, and 4A0001 to 4A0011: Setting 1.00.

Models BA0018, 2A0030 to 2A0069, and 4A0018 to 4A0038: Setting 1.50.

<2> Default settings change when the Control Method is changed (A1-02) or a different V/f pattern is selected using parameter E1-03. The default setting shown is for V/f Control.

When using OLV Motor Control, leave the torque compensation gain (C4-01) at its default setting of 1.00. To increase speed precision during regeneration in OLV Motor Control, enable slip compensation during regeneration (C3-04 = "1").

◆ Motor Hunting and Oscillation Control Parameters

In addition to the parameters discussed on page 169, the following parameters indirectly affect motor hunting and oscillation.

Table 6.3 Parameters that Affect Control Performance in Applications

Name (Parameter No.)	Application
Dwell Function (b6-01 through b6-04)	Prevents motor speed loss by maintaining the output frequency when working with heavy loads or when there is powerful backlash on the machine side.
Accel/Decel Time (C1-01 through C1-09)	Adjusting accel and decel times will affect the torque presented to the motor during acceleration or deceleration.
S-Curve Characteristics (C2-01 through C2-04)	Prevents shock at the beginning and end of acceleration and deceleration.
Jump Frequency (d3-01 through d3-04)	Skips over the resonant frequencies of connected machinery.
Analog Filter Time Constant (H3-13)	Prevents fluctuation in the analog input signal due to noise.
Stall Prevention (L3-01 through L3-06, L3-11)	<ul style="list-style-type: none"> Prevents motor speed loss and overvoltage. Used when the load is too heavy and also during sudden acceleration/deceleration. Adjustment is not normally required because Stall Prevention is enabled as a default. Disable Stall Prevention during deceleration (L3-04 = "0") when using a braking resistor.
Torque Limits (L7-01 through L7-04, L7-06, L7-07)	<ul style="list-style-type: none"> Sets the maximum torque for Open Loop Vector Control. Ensure that the drive capacity is greater than the motor capacity when increasing this setting. Be careful when reducing this value because motor speed loss may occur with heavy loads.

6.3 Drive Alarms, Faults, and Errors

◆ Types of Alarms, Faults, and Errors

Check the LED operator for information about possible faults if the drive or motor fails to operate. *Refer to Using the Digital LED Operator on page 80.*

If problems occur that are not covered in this manual, contact the nearest Yaskawa representative with the following information:

- Drive model
- Software version
- Date of purchase
- Description of the problem

Table 6.4 contains descriptions of the various types of alarms, faults, and errors that may occur while operating the drive. Contact Yaskawa in the event of drive failure.

Table 6.4 Types of Alarms, Faults, and Errors

Type	Drive Responses to Alarms, Faults, and Errors
Faults	<p>When the drive detects a fault:</p> <ul style="list-style-type: none"> • The digital operator displays text that indicates the specific fault and the ALM indicator LED remains lit until the fault is reset. • The fault interrupts drive output and the motor coasts to a stop. • Depending on the setting, the drive and motor may stop via different methods than listed. • If a digital output is programmed for fault output (H2-□□ = E), it will close if a fault occurs. <p>When the drive detects a fault, it will remain inoperable until that fault has been reset. <i>Refer to Fault Reset Methods on page 298.</i></p>
Minor Faults and Alarms	<p>When the drive detects an alarm or a minor fault:</p> <ul style="list-style-type: none"> • The digital operator displays text that indicates the specific alarm or minor fault and the ALM indicator LED flashes. • The motor does not stop. • One of the multi-function contact outputs closes if set to be tripped by a minor fault (H2-□□ = 10), but not by an alarm. • The digital operator displays text indicating a specific alarm and ALM indicator LED flashes. <p>Remove the cause of an alarm or minor fault to automatically reset.</p>
Operation Errors	<p>When parameter settings conflict with one another or do not match hardware settings (such as with an option card), it results in an operation error.</p> <p>When the drive detects an operation error:</p> <ul style="list-style-type: none"> • The digital operator displays text that indicates the specific error. • Multi-function contact outputs do not operate. <p>When the drive detects an operation error, it will not operate the motor until the error has been reset. Correct the settings that caused the operation error to reset.</p>
Tuning Errors	<p>Tuning errors occur while performing Auto-Tuning.</p> <p>When the drive detects a tuning error:</p> <ul style="list-style-type: none"> • The digital operator displays text indicating the specific error. • Multi-function contact outputs do not operate. • Motor coasts to stop. • Remove the cause of the error and repeat the Auto-Tuning process.

◆ Alarm and Error Displays

■ Faults

When the drive detects a fault, the ALM indicator LEDs remain lit without flashing. If the LEDs flash, the drive has detected a minor fault or alarm. [Refer to Minor Faults and Alarms on page 265](#) for more information. Conditions such as overvoltage or external faults can trip both faults and minor faults, therefore it is important to note whether the LEDs remain lit or if the LEDs flash.

Table 6.5 Fault Displays

Digital Operator Display		Name	Pg.	Digital Operator Display		Name	Pg.
<i>bUS</i>	bUS	Option Communication Error	267	<i>GF</i>	GF	Ground Fault	271
<i>CE</i>	CE	MEMOBUS/Modbus Communication Error	267	<i>LF</i>	LF	Output Phase Loss	272
<i>CF</i>	CF	Control Fault	267	<i>LF2</i>	LF2	Current Imbalance	272
<i>CoF</i>	CoF	Current Offset Fault	267	<i>nSE</i>	nSE	Node Setup Error	272
<i>CPF02</i>	CPF02	A/D Conversion Error	268	<i>oC</i>	oC	Overcurrent	272
<i>CPF03</i>	CPF03	PWM Data Fault	268	<i>oFA00 <3></i>	oFA00	Option Card Connection Error	273
<i>CPF06</i>	CPF06	Drive Specification Mismatch during Terminal Board or Control Board Replacement	268	<i>oFA01 <3></i>	oFA01	Option Unit Fault	273
<i>CPF07</i>	CPF07	Terminal Board Communication Fault	268	<i>oFA03</i>	oFA03	Option Card Fault	273
<i>CPF08</i>	CPF08	EEPROM Serial Communications Fault	268	<i>oFA04</i>	oFA04	Option Card Fault	273
<i>CPF11</i>	CPF11	RAM Fault	268	<i>oFA30 to oFA43</i>	oFA30 to oFA43	Option Card Fault	273
<i>CPF12</i>	CPF12	FLASH Memory Fault	268	<i>oH</i>	oH	Heatsink Overheat	274
<i>CPF13</i>	CPF13	Watchdog Circuit Exception	269	<i>oH1</i>	oH1	Heatsink Overheat	274
<i>CPF14</i>	CPF14	Control Circuit Fault	269	<i>oH3</i>	oH3	Motor Overheat 1 (PTC input)	274
<i>CPF16</i>	CPF16	Clock Fault	269	<i>oH4</i>	oH4	Motor Overheat 2 (PTC input)	275
<i>CPF17</i>	CPF17	Timing Fault	269	<i>oL1</i>	oL1	Motor Overload	275
<i>CPF18</i>	CPF18	Control Circuit Fault	269	<i>oL2</i>	oL2	Drive Overload	275
<i>CPF19</i>	CPF19	Control Circuit Fault	269	<i>oL3</i>	oL3	Overtorque Detection 1	276
<i>CPF20 or CPF21 <1></i>	CPF20 or CPF21	RAM Fault	269	<i>oL4</i>	oL4	Overtorque Detection 2	276
		FLASH Memory Fault	269	<i>oL5</i>	oL5	Mechanical Weakening Detection 1	276
		Watchdog Circuit Exception	269	<i>oL7</i>	oL7	High Slip Braking oL	276
		Clock Fault	269	<i>oPr</i>	oPr	Operator Connection Fault	277
<i>CPF22</i>	CPF22	A/D Conversion Error	269	<i>oS</i>	oS	Overspeed (for Simple V/f with PG)	277
<i>CPF23</i>	CPF23	PWM Feedback Data Fault	269	<i>ov</i>	ov	Overvoltage	277
<i>CPF24</i>	CPF24	Drive Capacity Signal Fault	270	<i>PF</i>	PF	Input Phase Loss	278
<i>CPF25</i>	CPF25	Terminal Board Not Connected	270	<i>PGo</i>	PGo	PG Disconnect (for Simple V/f with PG)	278
<i>dEv</i>	dEv	Excessive Speed Deviation (for Simple V/f with PG)	270	<i>rH</i>	rH	Dynamic Braking Resistor	278
<i>dWAL</i>	dWAL	DriveWorksEZ Program Error Output	270	<i>rr</i>	rr	Dynamic Braking Transistor	279
<i>dWFL</i>	dWFL	DriveWorksEZ Fault	270	<i>SC <2></i>	SC	IGBT Short Circuit	279
<i>E5</i>	E5	MECHATROLINK Watchdog Timer Error	270	<i>SEr</i>	SEr	Too Many Speed Search Restarts	279
<i>EF0</i>	EF0	Option External Fault	270	<i>STo</i>	STo	Pull-Out Detection	279
<i>EF1 to EF7</i>	EF1 to EF7	External Fault (input terminal S1 to S7)	270	<i>UL3</i>	UL3	Undertorque Detection 1	279
<i>Err</i>	Err	EEPROM Write Error	271	<i>UL4</i>	UL4	Undertorque Detection 2	280
<i>FbH</i>	FbH	Excessive PID Feedback	271	<i>UL5</i>	UL5	Mechanical Weakening Detection 2	280
<i>FbL</i>	FbL	PID Feedback Loss	271	<i>Uv1 <3></i>	Uv1	Undervoltage	280
				<i>Uv2 <3></i>	Uv2	Control Power Supply Undervoltage	280
				<i>Uv3</i>	Uv3	Soft Charge Circuit Fault	280

- <1> Displayed as $\overline{CPF20}$ when occurring at drive power up. When one of the faults occurs after successfully starting the drive, the display will show $\overline{CPF21}$.
- <2> Available in drive software versions PRG: 1020 and later.
- <3> Uv1 and Uv2 faults are not saved to the fault history

Minor Faults and Alarms

When a minor fault or alarm occurs, the ALM LED flashes and the text display shows an alarm code. A fault has occurred if the text remains lit and does not flash. *Refer to Alarm Detection on page 282.* An overvoltage situation, for example, can trigger both faults and minor faults. It is therefore important to note whether the LEDs remain lit or if the LEDs flash.

Table 6.6 Minor Fault and Alarm Displays

Digital Operator Display		Name	Minor Fault Output (H2-□□ = 10)	Pg.
\overline{AEr}	AEr	Station Address Setting Error (CC-Link, CANopen, MECHATROLINK)	YES	282
\overline{bb}	bb	Drive Baseblock	No output	282
\overline{bUS}	bUS	Option Card Communications Error	YES	282
\overline{CALL}	CALL	Serial Communication Transmission Error	YES	282
\overline{CE}	CE	MEMOBUS/Modbus Communication Error	YES	283
\overline{CrST}	CrST	Can Not Reset	YES	283
\overline{CyC}	CyC	MECHATROLINK Comm. Cycle Setting Error	YES	283
\overline{dEv}	dEv	Excessive Speed Deviation (for Simple V/f with PG)	YES	283
\overline{dnE}	dnE	Drive Disabled	YES	284
\overline{dWAL}	dWAL	DriveWorksEZ Alarm	YES	270
$\overline{E5}$	E5	MECHATROLINK Watchdog Timer Error	YES	284
\overline{EF}	EF	Run Command Input Error	YES	284
$\overline{EF0}$	EF0	Option Card External Fault	YES	284
$\overline{EF1}$ to $\overline{EF7}$	EF1 to EF7	External Fault (input terminal S1 to S7)	YES	284
\overline{FbH}	FbH	Excessive PID Feedback	YES	285
\overline{FbL}	FbL	PID Feedback Loss	YES	285
\overline{Hbb}	Hbb	Safe Disable Signal Input	YES	285
\overline{HbbF}	HbbF	Safe Disable Signal Input	YES	285
\overline{HCA}	HCA	Current Alarm	YES	285
$\overline{LT-1}$	LT-1	Cooling Fan Maintenance Alarm	No output </>	286
$\overline{LT-2}$	LT-2	Capacitor Maintenance Alarm	No output </>	286
$\overline{LT-3}$	LT-3	Soft Charge Bypass Relay Maintenance Time	No output </>	286
$\overline{LT-4}$	LT-4	IGBT Maintenance Time (50%)	No output </>	286
\overline{oH}	oH	Heatsink Overheat	YES	286
$\overline{oH2}$	oH2	Drive Overheat	YES	287
$\overline{oH3}$	oH3	Motor Overheat	YES	287
$\overline{oL3}$	oL3	Overtorque 1	YES	287
$\overline{oL4}$	oL4	Overtorque 2	YES	287
$\overline{oL5}$	oL5	Mechanical Weakening Detection 1	YES	288
\overline{oS}	oS	Overspeed (for Simple V/f with PG)	YES	288
\overline{ov}	ov	Overvoltage	YES	288
\overline{PASS}	PASS	MEMOBUS/Modbus Test Mode Complete	No output	288
\overline{PGo}	PGo	PG Disconnect (for Simple V/f with PG)	YES	288
\overline{rUn}	rUn	During Run 2, Motor Switch Command Input	YES	289

6.3 Drive Alarms, Faults, and Errors

Digital Operator Display		Name	Minor Fault Output (H2-□□ = 10)	Pg.
SE	SE	MEMOBUS/Modbus Test Mode Fault	YES	289
TrPC	TrPC	IGBT Maintenance Time (90%)	YES	289
UL3	UL3	Undertorque 1	YES	289
UL4	UL4	Undertorque 2	YES	289
UL5	UL5	Mechanical Weakening Detection 2	YES	280
Uv	Uv	Undervoltage	YES	290

<1> Output when H2-□□ = F

■ Operation Errors

Table 6.7 Operation Error Displays

Digital Operator Display	Name	Pg.	Digital Operator Display	Name	Pg.
oPE01	oPE01	Drive Unit Setting Error	oPE08	oPE08	Parameter Selection Error
oPE02	oPE02	Parameter Setting Range Error	oPE09	oPE09	PID Control Selection Error
oPE03	oPE03	Multi-Function Input Setting Error	oPE10	oPE10	V/f Data Setting Error
oPE04	oPE04	Terminal Board Mismatch Error	oPE11	oPE11	Carrier Frequency Setting Error
oPE05	oPE05	Run Command Selection Error	oPE13	oPE13	Pulse Train Monitor Selection Error
oPE07	oPE07	Multi-Function Analog Input Selection Error			

■ Auto-Tuning Errors

Table 6.8 Auto-Tuning Error Displays

Digital Operator Display	Name	Pg.	Digital Operator Display	Name	Pg.
End1	End1	Excessive V/f Setting	Er-04	Er-04	Line-to-Line Resistance Error
End2	End2	Motor Iron Core Saturation Coefficient Error	Er-05	Er-05	No-Load Current Error
End3	End3	Rated Current Setting Alarm	Er-08	Er-08	Rated Slip Error
Er-01	Er-01	Motor Data Error	Er-09	Er-09	Acceleration Error
Er-02	Er-02	Alarm	Er-11	Er-11	Motor Speed Error
Er-03	Er-03	STOP button Input	Er-12	Er-12	Current Detection Error

6.4 Fault Detection

◆ Fault Displays, Causes, and Possible Solutions

Table 6.9 Detailed Fault Displays, Causes, and Possible Solutions

Digital Operator Display		Fault Name
<i>bUS</i>	bUS	Option Communication Error
		<ul style="list-style-type: none"> After establishing initial communication, the connection was lost. Only detected when the run command frequency reference is assigned to an option card.
Cause		Possible Solution
No signal received from the PLC.		<ul style="list-style-type: none"> Check for faulty wiring.
The communication cable is faulty or a short circuit exists.		<ul style="list-style-type: none"> Correct the wiring. Check for loose wiring and short circuits. Repair as needed.
A communications data error occurred due to noise.		<ul style="list-style-type: none"> Check the various options available to minimize the effects of noise. Counteract noise in control circuit, main circuit, and ground wiring. Ensure that other equipment such as switches or relays do not cause noise and use surge suppressors if required. Use cables recommended by Yaskawa or another type of shielded line. Ground the shield on the controller side or on the drive input power side. Separate all wiring for communications devices from drive input power lines. Install an EMC noise filter to the input side of the drive input power.
The option card is damaged.		<ul style="list-style-type: none"> Replace the option card if there are no problems with the wiring and the error continues to occur.
The option card is not properly connected to the drive.		<ul style="list-style-type: none"> The connector pins on the option card are not properly lined up with the connector pins on the drive. Reinstall the option card.

Digital Operator Display		Fault Name
<i>CE</i>	CE	MEMOBUS/Modbus Communication Error
		Control data was not received for the CE detection time set to H5-09.
Cause		Possible Solution
Faulty communications wiring, or a short circuit exists.		<ul style="list-style-type: none"> Check for faulty wiring. Correct the wiring. Check for loose wiring and short circuits. Repair as needed.
A communications data error occurred due to noise.		<ul style="list-style-type: none"> Check the various options available to minimize the effects of noise. Counteract noise in control circuit, main circuit, and ground wiring. Use Yaskawa-recommended cables, or another type of shielded line. Ground the shield on the controller side or on the drive input power side. Ensure that other equipment such as switches or relays do not cause noise and use surge suppressors if required. Separate all wiring for communications devices from drive input power lines. Install an EMC noise filter to the input side of the drive input power.

Digital Operator Display		Fault Name
<i>CF</i>	CF	Control Fault
		A torque limit was reached continuously for three seconds or longer during a ramp to stop while in Open Loop Vector Control.
Cause		Possible Solution
Motor parameters are not set properly.		Check the motor parameter settings and repeat Auto-Tuning.
Torque limit is too low.		Set the torque limit to the most appropriate setting (L7-01 through L7-04).
Load inertia is too big.		<ul style="list-style-type: none"> Adjust the deceleration time (C1-02, -04, -06, -08). Set the frequency to the minimum value and interrupt the run command when the drive finishes decelerating.

Digital Operator Display		Fault Name
<i>CoF</i>	CoF	Current Offset Fault
		The current sensor is damaged or there was residual induction current in the motor (e.g., during sudden deceleration or when coasting) when the drive attempted to start the motor.
Cause		Possible Solution

6.4 Fault Detection

Digital Operator Display	Fault Name
Due to residual induction current in the motor when the drive attempted to start the motor, the drive attempted to adjust the current offset value beyond the allowable range.	<ul style="list-style-type: none"> Create a motor restart sequence that allows enough time for the residual induction voltage to dissipate. Enable Speed Search at start (b3-01 = 1). Use the multi-function terminals to execute External Speed Search 1 and 2 (H1-□□ = 61 or 62). <p>Note: When using a PM motor, both External Speed Search 1 and 2 perform the same operation.</p>

Digital Operator Display	Fault Name
<i>CPF02</i> CPF02	A/D Conversion Error An A/D conversion error occurred.
Cause	Possible Solution
Control circuit is damaged.	Cycle power to the drive. If the problem continues, replace the drive.
Control circuit terminals have shorted out (+V, AC).	<ul style="list-style-type: none"> Check for wiring errors along the control circuit terminals. Correct the wiring.
Control terminal input current has exceeded allowable levels.	<ul style="list-style-type: none"> Check the input current. Reduce the current input to control circuit terminal (+V) to 20 mA.

Digital Operator Display	Fault Name
<i>CPF03</i> CPF03	PWM Data Error There is a problem with the PWM data.
Cause	Possible Solution
Drive hardware is damaged.	Replace the drive.

Digital Operator Display	Fault Name
<i>CPF06</i> CPF06	EEPROM Data Error There is an error in the data saved to EEPROM.
Cause	Possible Solution
Control circuit is damaged.	Cycle power to the drive. If the problem continues, replace the drive.
The power supply was switched off when parameters were written (e.g., using a communications option card).	<ul style="list-style-type: none"> Cycle power to the drive and check operation again. Initialize the drive using A1-03. If the problem persists after initializing the drive, replace the drive.

Digital Operator Display	Fault Name
<i>CPF07</i> CPF07	Terminal Board Communications Error A communication error occurred at the terminal board.
Cause	Possible Solution
There is a fault connection between the terminal board and control board.	Turn the power off and reconnect the control circuit terminals.

Digital Operator Display	Fault Name
<i>CPF08</i> CPF08	EEPROM Serial Communication Fault EEPROM communications are not functioning properly.
Cause	Possible Solution
Terminal board or control board is not connected properly.	Turn the power off and check the control terminal connections.

Digital Operator Display	Fault Name
<i>CPF11</i> CPF11	RAM Fault
Cause	Possible Solution
Hardware is damaged.	Replace the drive.

Digital Operator Display	Fault Name
<i>CPF12</i> CPF12	FLASH Memory Fault Problem with the ROM (FLASH memory).
Cause	Possible Solution
Hardware is damaged.	Replace the drive.

Digital Operator Display		Fault Name
[PF13]	CPF13	Watchdog Circuit Exception Self-diagnostics problem.
Cause		Possible Solution
Hardware is damaged.		Replace the drive.

Digital Operator Display		Fault Name
[PF14]	CPF14	Control Circuit Fault CPU error (CPU operates incorrectly due to noise, etc.)
Cause		Possible Solution
Hardware is damaged.		Replace the drive.

Digital Operator Display		Fault Name
[PF16]	CPF16	Clock Fault Standard clock error.
Cause		Possible Solution
Hardware is damaged.		Replace the drive.

Digital Operator Display		Fault Name
[PF17]	CPF17	Timing Fault A timing error occurred during an internal process.
Cause		Possible Solution
Hardware is damaged.		Replace the drive.

Digital Operator Display		Fault Name
[PF18]	CPF18	Control Circuit Fault CPU error. Non-Maskable Interrupt (An unusual interrupt was triggered by noise, etc.)
Cause		Possible Solution
Hardware is damaged.		Replace the drive.

Digital Operator Display		Fault Name
[PF19]	CPF19	Control Circuit Fault CPU error (Manual reset due to noise, etc.)
Cause		Possible Solution
Hardware is damaged.		Replace the drive.

Digital Operator Display		Fault Name
[PF20] or [PF21]	CPF20 or CPF21	One of the following faults occurred: RAM fault, FLASH memory error, watchdog circuit exception, clock error <ul style="list-style-type: none"> • RAM fault. • FLASH memory error (ROM error). • Watchdog circuit exception (self-diagnostic error). • Clock error.
Cause		Possible Solution
Hardware is damaged.		Replace the drive.

Digital Operator Display		Fault Name
[PF22]	CPF22	A/D Conversion Fault A/D conversion error.
Cause		Possible Solution
Control circuit is damaged.		<ul style="list-style-type: none"> • Cycle power to the drive. <i>Refer to Diagnosing and Resetting Faults on page 298.</i> • If the problem continues, replace the drive.

Digital Operator Display		Fault Name
[PF23]	CPF23	PWM Feedback Fault PWM feedback error.

6.4 Fault Detection

Digital Operator Display		Fault Name
Cause		Possible Solution
Hardware is damaged.		Replace the drive.
Digital Operator Display		Fault Name
<i>CPF24</i>	CPF24	Drive Capacity Signal Fault
		Entered a capacity that does not exist. (Checked when the drive is powered up.)
Cause		Possible Solution
Hardware is damaged.		Replace the drive.
Digital Operator Display		Fault Name
<i>CPF25</i>	CPF25	Terminal Board Not Connected
Cause		Possible Solution
Terminal board is not connected correctly.		Reconnect the terminal board to the connector on the drive, then cycle the power to the drive.
Digital Operator Display		Fault Name
<i>dEv</i>	dEv	Speed Deviation (for Simple V/f with PG)
		According to the pulse input (RP), the speed deviation is greater than the setting in F1-10 for longer than the time set to F1-11.
Cause		Possible Solution
Load is too heavy.		Reduce the load.
Acceleration and deceleration times are set too short.		Increase the acceleration and deceleration times (C1-01 through C1-08).
The load is locked up.		Check the machine.
Parameters are not set appropriately.		Check the settings of parameters F1-10 and F1-11.
Motor brake engaged.		Ensure the motor brake releases properly.
Digital Operator Display		Fault Name
<i>dWFL</i>	dWFL	DriveWorksEZ Fault
<i>dWAL</i>	dWAL	DriveWorksEZ Program Error Output
Cause		Possible Solution
Fault output by DriveWorksEZ		Correct the cause of the fault.
Digital Operator Display		Fault Name
<i>E5</i>	E5	MECHATROLINK Watchdog Timer Error
		The watchdog timed out.
Cause		Possible Solution
Data has not been received from the PLC, triggering the watchdog timer.		Execute DISCONNECT or ALM_CLR, then issue a CONNECT command or SYNC_SET command and proceed to phase 3.
Digital Operator Display		Fault Name
<i>EF0</i>	EF0	Option Card External Fault
		An external fault condition is present.
Cause		Possible Solution
An external fault was received from the PLC with other than F6-03 = 3 "alarm only" (the drive continued to run after external fault).		<ul style="list-style-type: none"> Remove the cause of the external fault. Remove the external fault input from the PLC.
Problem with the PLC program.		Check the PLC program and correct problems.
Digital Operator Display		Fault Name
<i>EF1</i>	EF1	External Fault (input terminal S1)
		External fault at multi-function input terminal S1.
<i>EF2</i>	EF2	External Fault (input terminal S2)
		External fault at multi-function input terminal S2.
<i>EF3</i>	EF3	External Fault (input terminal S3)
		External fault at multi-function input terminal S3.

Digital Operator Display		Fault Name
EF4	EF4	External Fault (input terminal S4)
		External fault at multi-function input terminal S4.
EF5	EF5	External Fault (input terminal S5)
		External fault at multi-function input terminal S5.
EF6	EF6	External Fault (input terminal S6)
		External fault at multi-function input terminal S6.
EF7	EF7	External Fault (input terminal S7)
		External fault at multi-function input terminal S7
Cause		Possible Solution
An external device has tripped an alarm function.		Remove the cause of the external fault and reset the fault.
Wiring is incorrect.		<ul style="list-style-type: none"> Ensure the signal lines have been connected properly to the terminals assigned for external fault detection (H1-□□ = 20 to 2F). Reconnect the signal line.
Incorrect setting of multi-function contact inputs.		<ul style="list-style-type: none"> Check if the unused terminals set for H1-□□ = 20 to 2F (External Fault). Change the terminal settings.

Digital Operator Display		Fault Name
Err	Err	EEPROM Write Error
		Data does not match the EEPROM being written to.
Cause		Possible Solution
-		<ul style="list-style-type: none"> Press the ENTER button. Correct the parameter settings. Cycle power to the drive. <i>Refer to Diagnosing and Resetting Faults on page 298.</i>

Digital Operator Display		Fault Name
FbH	FbH	Excessive PID Feedback
		PID feedback input is greater than the level set b5-36 for longer than the time set to b5-37. Set b5-12 to 2 or 5 to enable fault detection.
Cause		Possible Solution
Parameters are not set appropriately.		Check the settings of parameters b5-36 and b5-37.
Wiring for PID feedback is incorrect.		Correct the wiring.
There is a problem with the feedback sensor.		<ul style="list-style-type: none"> Check the sensor on the control side. Replace the sensor if damaged.

Digital Operator Display		Fault Name
FbL	FbL	PID Feedback Loss
		This fault occurs when PID Feedback Loss Detection is programmed to fault (b5-12 = 2) and the PID Feedback < PID Feedback Loss Detection Level (b5-13) for the PID Feedback Loss Detection Time (b5-14).
Cause		Possible Solution
Parameters are not set appropriately.		Check the settings of parameters b5-13 and b5-14.
Wiring for PID feedback is incorrect.		Correct the wiring.
There is a problem with the feedback sensor.		Check the sensor on the controller side. If damaged, replace the sensor.

Digital Operator Display		Fault Name
GF	GF	Ground Fault
		<ul style="list-style-type: none"> Current shorted to ground exceeded 50% of rated current on output side of the drive. Setting L8-09 to 1 enables ground fault detection in models 2A0020 to 2A0069 and 4A0011 to 4A0038.
Cause		Possible Solution
Motor insulation is damaged.		<ul style="list-style-type: none"> Check the insulation resistance of the motor. Replace the motor.

6.4 Fault Detection

Digital Operator Display	Fault Name
A damaged motor cable is creating a short circuit.	<ul style="list-style-type: none"> Check the motor cable. Remove the short circuit and turn the power back on.
The leakage current at the drive output is too high.	<ul style="list-style-type: none"> Check the resistance between the cable and the ground terminal ⊕. Replace the cable.
The drive started to run during Current Offset Fault or while coasting to a stop.	<ul style="list-style-type: none"> Reduce the carrier frequency. Reduce the amount of stray capacitance.
Hardware problem.	<ul style="list-style-type: none"> The value set exceeds the allowable setting range while the drive automatically adjusts the current offset (this happens only attempting to restart a PM motor that is coasting to stop). Enable Speed Search at start (b3-01 = 1). Perform Speed Search 1 or 2 (H1-□□ = 61 or 62) via one of the external terminals. Note: Speed Search 1 and 2 are the same when using OLV/PM control mode.
	<ul style="list-style-type: none"> Replace the drive.

Digital Operator Display	Fault Name
LF	Output Phase Loss
LF	<ul style="list-style-type: none"> Phase loss on the output side of the drive. Phase Loss Detection is enabled when L8-07 is set to 1 or 2.
Cause	Possible Solution
The output cable is disconnected.	<ul style="list-style-type: none"> Check for wiring errors and ensure the output cable is connected properly. Correct the wiring.
The motor winding is damaged.	<ul style="list-style-type: none"> Check the resistance between motor lines. Replace the motor if the winding is damaged.
The output terminal is loose.	<ul style="list-style-type: none"> Apply the tightening torque specified in this manual to fasten the terminals. <i>Refer to Wire Size and Torque Specifications on page 66.</i>
The motor being used is less than 5% of the drive rated current.	Check the drive and motor capacities.
An output transistor is damaged.	Replace the drive.
A single-phase motor is being used.	The drive being used cannot operate a single phase motor.

Digital Operator Display	Fault Name
LF2	Output current imbalance
LF2	One or more of the phases in the output current is lost.
Cause	Possible Solution
Phase loss has occurred on the output side of the drive.	<ul style="list-style-type: none"> Check for faulty wiring or poor connections on the output side of the drive. Correct the wiring.
Terminal wires on the output side of the drive are loose.	Apply the tightening torque specified in this manual to fasten the terminals. <i>Refer to Wire Size and Torque Specifications on page 66.</i>
No signal displays from the gate driver board.	Replace the drive. Contact Yaskawa for assistance.
Motor impedance or motor phases are uneven.	<ul style="list-style-type: none"> Measure the line-to-line resistance for each motor phase. Ensure all values are the same. Replace the motor. Contact Yaskawa for assistance.

Digital Operator Display	Fault Name
nSE	Node Setup Error
nSE	A terminal assigned to the node setup function closed during Run.
Cause	Possible Solution
The node setup terminal closed during Run.	<ul style="list-style-type: none"> Check whether a Run command was accidentally entered via the terminals or from a comm. option unit. Turn off the Run command when using the node setup function.
A Run command was issued while the node setup function was active.	

Digital Operator Display	Fault Name
oC	Overcurrent
oC	Drive sensors have detected an output current greater than the specified overcurrent level.
Cause	Possible Solution
The motor has been damaged due to overheating or the motor insulation is damaged.	<ul style="list-style-type: none"> Check the insulation resistance. Replace the motor.

Digital Operator Display	Fault Name
One of the motor cables has shorted out or there is a grounding problem.	<ul style="list-style-type: none"> Check the motor cables. Remove the short circuit and power the drive back up. Check the resistance between the motor cables and the ground terminal⊕. Replace damaged cables.
The load is too heavy.	<ul style="list-style-type: none"> Measure the current flowing into the motor. Replace the drive with a larger capacity unit if the current value exceeds the rated current of the drive. Determine if there is sudden fluctuation in the current level. Reduce the load to avoid sudden changes in the current level or switch to a larger drive.
The acceleration or deceleration times are too short.	<p>Calculate the torque needed during acceleration relative to the load inertia and the specified acceleration time. If the right amount of torque cannot be set, make the following changes:</p> <ul style="list-style-type: none"> Increase the acceleration time (C1-01, C1-03, C1-05, C1-07) Increase the S-curve characteristics (C2-01 through C2-04) Increase the capacity of the drive.
The drive is attempting to operate a specialized motor or a motor larger than the maximum size allowed.	<ul style="list-style-type: none"> Check the motor capacity. Ensure that the rated capacity of the drive is greater than or equal to the capacity rating found on the motor nameplate.
Magnetic contactor (MC) on the output side of the drive has turned on or off.	Set up the operation sequence so that the MC is not tripped while the drive is outputting current.
V/f setting is not operating as expected.	<ul style="list-style-type: none"> Check the ratios between the voltage and frequency. Set parameter E1-04 through E1-10 appropriately. Set E3-04 through E3-10 when using a second motor. Lower the voltage if it is too high relative to the frequency.
Excessive torque compensation.	<ul style="list-style-type: none"> Check the amount of torque compensation. Reduce the torque compensation gain (C4-01) until there is no speed loss and less current.
Drive fails to operate properly due to noise interference.	<ul style="list-style-type: none"> Review the possible solutions provided for handling noise interference. Review the section on handling noise interference and check the control circuit lines, main circuit lines and ground wiring.
Overexcitation gain is set too high.	<ul style="list-style-type: none"> Check if fault occurs simultaneously to overexcitation function operation. Consider motor flux saturation and reduce the value of n3-13 (Overexcitation Deceleration Gain).
Run command applied while motor was coasting.	<ul style="list-style-type: none"> Set b3-01 to 1 to enable Speed Search at Start. Program the Speed Search command input through one of the multi-function contact input terminals (H1-□□ = "61" or "62").
The wrong motor code has been entered for in OLV/PM (Yaskawa motors only).	Enter the correct motor code to E5-01 to indicate that a PM motor is connected.
The motor control method and motor do not match.	<p>Check which motor control method the drive is set to in A1-02.</p> <ul style="list-style-type: none"> For IM motors, set A1-02 to 0 or 2. For PM motors, set A1-02 to 5.
The motor cable is too long	Use a larger drive.

Digital Operator Display	Fault Name
<i>oFR00</i>	<i>oFA00</i>
Cause	Possible Solution
The option card is incompatible with the drive.	Use a compatible option card.

Digital Operator Display	Fault Name
<i>oFR01</i>	<i>oFA01</i>
Cause	Possible Solution
The option card is not connected properly to the drive.	Turn the power off and reconnect the option card.

Digital Operator Display	Fault Name
<i>oFR03</i>	<i>oFA03</i>
	Option card self-diagnostic error

6.4 Fault Detection

Digital Operator Display		Fault Name
oFA04	oFA04	Option Card Fault An error occurred attempting to write to the option card memory.
oFA30 to oFA43	oFA30 to oFA43	Option Card Fault Communication ID error
Cause		Possible Solution
Option card or hardware is damaged.		Replace the option card. Contact Yaskawa for consultation.

Digital Operator Display		Fault Name
oH	oH	Heatsink Overheat The temperature of the heatsink exceeded the value set to L8-02. Default value for L8-02 is determined by drive capacity (o2-04).
Cause		Possible Solution
Surrounding temperature is too high.		<ul style="list-style-type: none"> Check the temperature surrounding the drive. Verify temperature is within drive specifications. Improve the air circulation within the enclosure panel. Install a fan or air conditioner to cool the surrounding area. Remove anything near the drive that might be producing excessive heat.
Load is too heavy.		<ul style="list-style-type: none"> Measure the output current. Decrease the load. Lower the carrier frequency in C6-02.
Internal cooling fan is stopped.		<ul style="list-style-type: none"> After replacing the fan, set o4-03 to 0 to reset cooling fan maintenance.

Digital Operator Display		Fault Name
oH1	oH1	Overheat 1 (Heatsink Overheat) The temperature of the heatsink has exceeded 10 °C plus the default value of L8-02.
Cause		Possible Solution
Surrounding temperature is too high.		<ul style="list-style-type: none"> Check the temperature surrounding the drive. Improve the air circulation within the enclosure panel. Install a fan or air conditioner to cool the surrounding area. Remove anything near the drive that might be producing excessive heat.
Load is too heavy.		<ul style="list-style-type: none"> Measure the output current. Lower the carrier frequency (C6-02). Reduce the load.
The internal cooling fan has reached its performance life or has malfunctioned.		<ul style="list-style-type: none"> Check the maintenance time for the cooling fan (U4-04). After replacing the fan, set o4-03 to 0 to reset cooling fan maintenance.
Current flowing to control circuit terminal +V exceeded the tolerance level.		<ul style="list-style-type: none"> Check the current level of the terminal. Set the current to the control circuit terminal to be 20 mA or less.

Digital Operator Display		Fault Name
oH3	oH3	Motor Overheat Alarm (PTC Input) <ul style="list-style-type: none"> The motor overheat signal to analog input terminal A1 or A2 exceeded the alarm detection level. Detection requires multi-function analog input H3-02 or H3-10 be set to E.
Cause		Possible Solution
Motor has overheated		<ul style="list-style-type: none"> Check the size of the load, the accel/decel times and the cycle times. Decrease the load. Increase the acceleration and deceleration times (C1-01 through C1-08). Adjust the preset V/f pattern (E1-04 through E1-10). This will mainly involve reducing E1-08 and E1-10. Be careful not to lower E1-08 and E1-10 excessively, as this reduces load tolerance at low speeds. Check the motor-rated current. Enter the motor-rated current as indicated on the motor nameplate (E2-01). Ensure the motor cooling system is operating normally. Repair or replace the motor cooling system.

Digital Operator Display		Fault Name
oH4	oH4	Motor Overheat Fault (PTC Input)
		<ul style="list-style-type: none"> The motor overheat signal to analog input terminal A1 or A2 exceeded the fault detection level. Detection requires multi-function analog input H3-02 or H3-10 be set to E.
Cause		Possible Solution
Motor has overheated.		<ul style="list-style-type: none"> Check the size of the load, the accel/decel times and the cycle times. Decrease the load. Increase the acceleration and deceleration times (C1-01 through C1-08).
		<ul style="list-style-type: none"> Adjust the preset V/f pattern (E1-04 through E1-10). This will mainly involve reducing E1-08 and E1-10. Be careful not to lower E1-08 and E1-10 excessively because this reduces load tolerance at low speeds Check the motor-rated current. Enter the motor-rated current as indicated on the motor nameplate (E2-01). Ensure the motor cooling system is operating normally. Repair or replace the motor cooling system.

Digital Operator Display		Fault Name
oL1	oL1	Motor Overload
		The electrothermal sensor tripped overload protection.
		Note: The U4-16 value must be less than 100 before oL1 can be reset.
Cause		Possible Solution
Cycle times are too short during acceleration and deceleration.		Increase the acceleration and deceleration times (C1-01 through C1-08).
<ul style="list-style-type: none"> Drive overloaded at low speeds. Overload may occur at low speeds when using a general-purpose motor, even if operating within the rated current limitation. 		<ul style="list-style-type: none"> Reduce the load. Increase the speed. If the drive is supposed to operate at low speeds, either increase the motor capacity or use a motor specifically designed to operate with the drive.
Although a special type of motor is being used, the motor protection selection is set for a general-purpose motor (L1-01 = 1).		Set L1-01 to 2.
Voltage is too high for the V/f characteristics.		<ul style="list-style-type: none"> Adjust the user set V/f patterns (E1-04 through E1-10). Parameters E1-08 and E1-10 may need to be reduced. If E1-08 and E1-10 are set too high, there may be very little load tolerance at low speed.
The wrong motor-rated current is set to E2-01.		<ul style="list-style-type: none"> Check the motor-rated current. Enter the value written on the motor nameplate to parameter E2-01.
The motor base frequency for the drive input power is set too low.		<ul style="list-style-type: none"> Check the rated frequency indicated on the motor nameplate. Enter the rated frequency to E1-06 (Base Frequency).
Multiple motors are running off the same drive.		Set L1-01 to 0 to disable the Motor Protection function and install a thermal relay to each motor.
The electrical thermal protection characteristics and motor overload characteristics do not match.		<ul style="list-style-type: none"> Check the motor characteristics. Correct the value set to L1-01 (Motor Protection Function). Install an external thermal relay.
The electrical thermal relay is operating at the wrong level.		<ul style="list-style-type: none"> Check the current rating listed on the motor nameplate. Check the value set for the motor-rated current (E2-01).
Motor overheated by overexcitation operation.		<ul style="list-style-type: none"> Overexcitation increases the motor losses and the motor temperature. If applied too long, motor damage can occur. Prevent excessive overexcitation operation or apply proper cooling to the motor Reduce the excitation deceleration gain (n3-13). Set L3-04 (Stall Prevention during Deceleration) to a value other than 4.
Speed Search related parameters are not set to the proper values.		<ul style="list-style-type: none"> Check values set to Speed Search related parameters. Adjust the Speed Search current and Speed Search deceleration times (b3-02 and b3-03 respectively). After Auto-Tuning, enable Speed Estimation Type Search (b3-24 = "1").
Output current fluctuation due to input phase loss		Check the power supply for phase loss.

Digital Operator Display		Fault Name
oL2	oL2	Drive Overload
		The thermal sensor of the drive triggered overload protection.

6.4 Fault Detection

Digital Operator Display	Fault Name
Cause	Possible Solution
Load is too heavy.	Reduce the load.
Cycle times are too short during acceleration and deceleration.	Increase the settings for the acceleration and deceleration times (C1-01 through C1-08).
Voltage is too high for the V/f characteristics.	<ul style="list-style-type: none"> Adjust the preset V/f pattern (E1-04 through E1-10). This will mainly involve reducing E1-08 and E1-10. Be careful not to lower E1-08 and E1-10 excessively because this reduces load tolerance at low speeds.
Drive capacity is too small.	Replace the drive with a larger model.
Overload occurred when operating at low speeds.	<ul style="list-style-type: none"> Reduce the load when operating at low speeds. Replace the drive with a model that is one frame size larger. Lower the carrier frequency (C6-02).
Excessive torque compensation.	Reduce the torque compensation gain (C4-01) until there is no speed loss but less current.
Speed Search related parameters are not set correctly.	<ul style="list-style-type: none"> Check the settings for all Speed Search related parameters. Adjust the current used during Speed Search and the Speed Search deceleration time (b3-03 and b3-02 respectively). After Auto-Tuning the drive, enable the Speed Search Estimation Type (b3-24 = "1").
Output current fluctuation due to input phase loss	Check the power supply for phase loss.

Digital Operator Display	Fault Name
oL3	Overtorque Detection 1
	The current has exceeded the value set for torque detection (L6-02) for longer than the allowable time (L6-03).
Cause	Possible Solution
Parameter settings are not appropriate for the type of load.	Check the settings of parameters L6-02 and L6-03.
There is a fault on the machine side (e.g., the machine is locked up).	Check the status of the load. Remove the cause of the fault.

Digital Operator Display	Fault Name
oL4	Overtorque Detection 2
	The current has exceeded the value set for Overtorque Detection 2 (L6-05) for longer than the allowable time (L6-06).
Cause	Possible Solution
Parameter settings are not appropriate for the type of load.	Check the settings of parameters L6-05 and L6-06.

Digital Operator Display	Fault Name
oL5	Mechanical Weakening Detection 1
	Overtorque occurred, matching the conditions specified in L6-08.
Cause	Possible Solution
Overtorque occurred, triggering the mechanical weakening level set to L6-08.	Check for the cause of mechanical weakening.

Digital Operator Display	Fault Name
oL7	High-Slip Braking oL
	The output frequency stayed constant for longer than the time set in n3-04 during High-slip Braking.
Cause	Possible Solution
Excessive load inertia.	<ul style="list-style-type: none"> Reduce deceleration times using parameters C1-02, C1-04, C1-06 and C1-08 in applications that do not use High-slip Braking. Use a braking resistor to shorten deceleration time.
Motor is driven by the load.	
Something on the load side is restricting deceleration.	<ul style="list-style-type: none"> Increase parameter n3-04 (High-slip Braking Overload Time). Install a thermal relay and increase the parameter setting of n3-04 to the maximum value.
The overload time during High-slip Braking is too short.	

Digital Operator Display		Fault Name
oPr	oPr	External Digital Operator Connection Fault <ul style="list-style-type: none"> The external operator has been disconnected from the drive. Note: An oPr fault will occur when all of the following conditions are true: <ul style="list-style-type: none"> Output is interrupted when the operator is disconnected (o2-06 = 1). The run command is assigned to the operator (b1-02 = 0 and LOCAL has been selected).
Cause		Possible Solution
External operator is not properly connected to the drive.		<ul style="list-style-type: none"> Check the connection between the operator and the drive. Replace the cable if damaged. Turn off the drive input power and disconnect the operator. Next reconnect the operator and turn the drive input power back on.

Digital Operator Display		Fault Name
oS	oS	Overspeed (Simple V/f with PG) Pulse input (RP) indicates that motor speed feedback exceeded F1-08 setting.
Cause		Possible Solution
Overshoot or undershoot is occurring.		<ul style="list-style-type: none"> Adjust the gain by using the pulse train input parameters (H6-02 through H6-05). Increase the settings for C5-01 (Speed Control Proportional Gain 1) and reduce C5-02 (Speed Control Integral Time 1).
Incorrect PG pulse settings.		Set the H6-02 (Pulse Train Input Scaling) = 100%, the frequency of the PG pulses at maximum motor speed.
Inappropriate parameter settings.		Check the setting for the overspeed detection level and the overspeed detection time (F1-08 and F1-09).

Digital Operator Display		Fault Name
ov	ov	Overvoltage Voltage in the DC bus has exceeded the overvoltage detection level. <ul style="list-style-type: none"> For 200 V class: approximately 410 V For 400 V class: approximately 820 V (740 V when E1-01 is less than 400)
Cause		Possible Solution
Deceleration time is too short and regenerative energy flows from the motor into the drive.		<ul style="list-style-type: none"> Increase the deceleration time (C1-02, C1-04, C1-06, C1-08). Install a braking resistor or a dynamic braking resistor unit. Enable stall prevention during deceleration (L3-04 = "1"). Stall prevention is enabled as the default setting.
Fast acceleration time causes the motor to overshoot the speed reference.		<ul style="list-style-type: none"> Check if sudden drive acceleration triggers an overvoltage alarm. Increase the acceleration time. Use longer S-curve acceleration and deceleration times.
Excessive braking load.		The braking torque was too high, causing regenerative energy to charge the DC bus. Reduce the braking torque, use a braking option, or lengthen decel time.
Surge voltage entering from the drive input power.		Install a DC link choke. Note: Voltage surge can result from thyristor convertor and phase advancing capacitor using same drive main input power supply.
Ground fault in the output circuit causing the DC bus capacitor to overcharge.		<ul style="list-style-type: none"> Check the motor wiring for ground faults. Correct grounding shorts and turn the power back on.
Improper Setting of Speed Search related parameters. (Includes Speed Search after a momentary power loss and after a fault restart.)		<ul style="list-style-type: none"> Check the settings for Speed Search related parameters. Enable Speed Search Retry function (b3-19 greater than or equal to 1 to 10). Adjust the current level during Speed Search and the deceleration time (b3-02 and b3-03 respectively). Perform Line-to-Line Resistance Auto-Tuning and then enable Speed Estimation Type Speed Search (b3-24 = 1).
Excessive regeneration when overshoot occurs after acceleration.		<ul style="list-style-type: none"> Enable the Overvoltage Suppression function (L3-11 = 1). Lengthen the S-curve at acceleration end.
Drive input power voltage is too high.		<ul style="list-style-type: none"> Check the voltage. Lower drive input power voltage within the limits listed in the specifications.
The dynamic braking transistor is damaged.		Replace the drive.
The braking transistor is wired incorrectly.		<ul style="list-style-type: none"> Check braking transistor wiring for errors. Properly rewire the braking resistor device.

6.4 Fault Detection

Digital Operator Display	Fault Name
Drive fails to operate properly due to noise interference.	<ul style="list-style-type: none"> Review the list of possible solutions provided for controlling noise. Review the section on handling noise interference and check the control circuit lines, main circuit lines and ground wiring.
Load inertia has been set incorrectly.	<ul style="list-style-type: none"> Check the load inertia settings when using KEB, overvoltage suppression or Stall Prevention during deceleration. Adjust L3-25 (Load Inertia Ratio) in accordance with the load.
Braking function is being used in PM Open Loop Vector Control.	Connect a braking resistor.
Motor hunting occurs.	<ul style="list-style-type: none"> Adjust the parameters that control hunting. Set the hunting prevention gain (n1-02). Adjust the AFR time constant 1 (n2-02) and the AFR time constant 2 (n2-03) when in OLV Control. Use parameters n8-45 (PM Speed Feedback Detection Suppression Gain) and n8-47 (Pull-In Current Compensation Time Constant).

Digital Operator Display	Fault Name
PF	PF
	Input Phase Loss
	Drive input power has an open phase or has a large imbalance of voltage between phases. Detected when L8-05 = 1 (enabled).
Cause	Possible Solution
There is phase loss in the drive input power.	<ul style="list-style-type: none"> Check for wiring errors in the main circuit drive input power. Correct the wiring.
There is loose wiring in the drive input power terminals.	<ul style="list-style-type: none"> Ensure the terminals are tightened properly. Apply the tightening torque specified in this manual to fasten the terminals. <i>Refer to Wire Gauges and Tightening Torques on page 58</i> for details.
There is excessive fluctuation in the drive input power voltage.	<ul style="list-style-type: none"> Check the voltage from the drive input power. Review the possible solutions for stabilizing the drive input power. Disable Input Phase Loss Detection (L8-05 = "0"). PF is detected if DC bus ripple is too high. If it is disabled, there is no fault but the ripple is still too high, thereby the capacitors are stressed more and lose lifetime.
There is poor balance between voltage phases.	<ul style="list-style-type: none"> Stabilize drive input power or disable phase loss detection.
The main circuit capacitors are worn.	<ul style="list-style-type: none"> Check the maintenance time for the capacitors (U4-05). Replace the drive if U4-05 is greater than 90%.
	<ul style="list-style-type: none"> Check for anything wrong with the drive input power. If nothing is wrong with the drive input power, try the following solutions if the alarm continues: Disable Input Phase Loss Protection selection (L8-05 = "0"). PF is detected if DC bus ripple is too high. If it is disabled, there is no fault but the ripple is still too high, thereby the capacitors are stressed more and lose lifetime. Replace the drive.

Digital Operator Display	Fault Name
PGo	PGo
	PG Disconnect (for Simple V/f with PG)
	No PG pulses are received for longer than the time set to F1-14.
Cause	Possible Solution
Pulse input (RP) is disconnected.	Reconnect the pulse input (RP).
Pulse input (RP) wiring is wrong.	Correct the wiring.
Motor brake engaged.	Ensure the motor brake releases properly.

Digital Operator Display	Fault Name
rH	rH
	Braking Resistor Overheat
	Braking resistor protection was triggered. Fault detection is enabled when L8-01 = 1 (disabled as a default).
Cause	Possible Solution
Deceleration time is too short and excessive regenerative energy is flowing back into the drive.	<ul style="list-style-type: none"> Check the load, deceleration time and speed. Reduce the load. Increase the acceleration and deceleration times (C1-01 through C1-08). Replace the braking option with a larger device that can handle the power that is discharged.

Digital Operator Display	Fault Name
Excessive braking inertia.	Recalculate braking load and braking power. Then try reducing the braking load and checking the braking resistor settings and improve braking capacity.
The proper braking resistor has not been installed.	<ul style="list-style-type: none"> • Check the specifications and conditions for the braking resistor device. • Select the optimal braking resistor.
Note: The magnitude of the braking load trips the braking resistor overheat alarm, NOT the surface temperature. Using the braking resistor more frequently than its rating trips the alarm even when the braking resistor surface is not very hot.	

Digital Operator Display	Fault Name
rr	Dynamic Braking Transistor
	The built-in dynamic braking transistor failed.
Cause	Possible Solution
The braking transistor is damaged.	<ul style="list-style-type: none"> • Cycle power to the drive and check if the fault reoccurs. <i>Refer to Diagnosing and Resetting Faults on page 298.</i> • Replace the drive if the fault continues.
The control circuit is damaged.	

Digital Operator Display	Fault Name
SC	IGBT Short Circuit
Cause	Possible Solution
IGBT fault	<ul style="list-style-type: none"> • Check motor wiring • Cycle power to the drive. • If the problem continues, contact your Yaskawa representative or the nearest Yaskawa sales office.
IGBT short circuit detection and circuit fault	

Digital Operator Display	Fault Name
SEr	Too Many Speed Search Restarts
	The number of speed search restarts exceeded the number set to b3-19.
Cause	Possible Solution
Speed Search parameters are set to the wrong values.	<ul style="list-style-type: none"> • Reduce the detection compensation gain during Speed Search (b3-10). • Increase the current level when attempting Speed Search (b3-17). • Increase the detection time during Speed Search (b3-18). • Repeat Auto-Tuning.
The motor is coasting in the opposite direction of the Run command.	

Digital Operator Display	Fault Name
STo	Motor Pull Out or Step Out Detection
	Motor pull out or step out has occurred. Motor has exceeded its pull out torque.
Cause	Possible Solution
The wrong motor code has been set (Yaskawa motors only).	<ul style="list-style-type: none"> • Enter the correct motor code for the PM being used into E5-01. • For special-purpose motors, enter the correct data to all E5 parameters according to the Test Report provided for the motor.
Load is too heavy.	
Load inertia is too heavy.	Increase n8-55 (Load Inertia for PM).
Acceleration and deceleration times are too short.	<ul style="list-style-type: none"> • Increase the acceleration and deceleration times (C1-01 through C1-08). • Increase the S-curve acceleration and deceleration times (C2-01).

Digital Operator Display	Fault Name
UL3	Undertorque Detection 1
	The current has fallen below the minimum value set for torque detection (L6-02) for longer than the allowable time (L6-03).
Cause	Possible Solution
Parameter settings are not appropriate for the type of load.	Check the settings of parameters L6-02 and L6-03.
There is a fault on the machine side.	Check the load for any problems.

6.4 Fault Detection

Digital Operator Display		Fault Name
$UL4$	UL4	Undertorque Detection 2
		The current has fallen below the minimum value set for torque detection (L6-05) for longer than the allowable time (L6-06).
Cause		Possible Solution
Parameter settings are not appropriate for the type of load.		Check the settings of parameters L6-05 and L6-06.
There is a fault on the machine side.		Check the load for any problems.

Digital Operator Display		Fault Name
$UL5$	UL5	Mechanical Weakening Detection 2
		The operation conditions matched the conditions set to L6-08.
Cause		Possible Solution
Undertorque was detected and matched the condition of mechanical loss detection operation selection (L6-08).		Check the load side for any problems.

Digital Operator Display		Fault Name
$Uv1$	Uv1	DC Bus Undervoltage
		One of the following conditions occurred while the drive was in operation:
		<ul style="list-style-type: none"> Voltage in the DC bus fell below the undervoltage detection level (L2-05). For 200 V class: approximately 190 V (160 V for single phase drives) For 400 V class: approximately 380 V (350 V when E1-01 is less than 400) The fault is output only if L2-01 = 0 or L2-01 = 1 and the DC bus voltage is under L2-05 for longer than L2-02.
Cause		Possible Solution
Input power phase loss.		<ul style="list-style-type: none"> The main circuit drive input power is wired incorrectly. Correct the wiring.
One of the drive input power wiring terminals is loose.		<ul style="list-style-type: none"> Ensure there are no loose terminals. Apply the tightening torque specified in this manual to fasten the terminals. <i>Refer to Wire Gauges and Tightening Torques on page 58</i> for details.
There is a problem with the voltage from the drive input power.		<ul style="list-style-type: none"> Check the voltage. Correct the voltage to within range listed in drive input power specifications.
The power has been interrupted.		Correct the drive input power.
Drive internal circuitry has become worn.		<ul style="list-style-type: none"> Check the maintenance time for the capacitors (U4-05). Replace the drive if U4-05 exceeds 90%.
The drive input power transformer is not large enough and voltage drops after switching on power.		Check the capacity of the drive input power transformer.
Air inside the drive is too hot.		Check the drive internal temperature.
Problem with the CHARGE indicator.		Replace the drive.

Digital Operator Display		Fault Name
$Uv2$	Uv2	Control Power Supply Voltage Fault
		Voltage is too low for the control drive input power.
Cause		Possible Solution
L2-02 changed from its default value in drive that is 7.5 kW or smaller without installing a Momentary Power Loss Ride-Thru.		Correct parameter L2-02 setting or install optional Momentary Power Loss Ride-Thru unit.
The wiring for the control power supply is damaged.		<ul style="list-style-type: none"> Cycle power to the drive. Check if the fault reoccurs. Replace the drive if the fault continues to occur.
Internal circuitry is damaged.		<ul style="list-style-type: none"> Cycle power to the drive. Check if the fault reoccurs. Replace the drive if the fault continues to occur.

Digital Operator Display		Fault Name
$Uv3$	Uv3	Undervoltage 3 (Inrush Prevention Circuit Fault)
		The inrush prevention circuit has failed.
Cause		Possible Solution

Digital Operator Display	Fault Name
The contactor on the inrush prevention circuit is damaged.	<ul style="list-style-type: none"> • Cycle power to the drive. Check if the fault reoccurs. • Replace the drive if the fault continues to occur. • Check monitor U4-06 for the performance life of the inrush prevention circuit. • Replace the drive if U4-06 exceeds 90%.

DMC

Drives Motors Controls

6.5 Alarm Detection

Alarms are drive protection functions that do not operate the fault contact. The drive will return to original status when the cause of the alarm has been removed.

During an alarm condition, the Digital Operator display flashes and an alarm output is generated at the multi-function outputs (H2-01 to H2-03), if programmed.

Investigate the cause of the alarm and [Refer to Detailed Alarm Codes, Causes, and Possible Solutions on page 282](#) for the appropriate action.

◆ Alarm Codes, Causes, and Possible Solutions

Table 6.10 Detailed Alarm Codes, Causes, and Possible Solutions

Digital Operator Display		Minor Fault Name	
REr	AEr	Station Address Setting Error (CC-Link, CANopen, MECHATROLINK)	
		Option card node address is outside the acceptable setting range.	
Cause		Possible Solution	Minor Fault (H2-□□ = 10)
Station number is set outside the possible setting range.		<ul style="list-style-type: none"> Set parameter F6-10 to the proper value if a CC-Link option card is used Set parameter F6-20 to the proper value if a MECHATROLINK option card is used. Set parameter F6-35 to the proper value if a CANopen option card is used. 	YES
Digital Operator Display		Minor Fault Name	
bb	bb	Baseblock	
		Drive output interrupted as indicated by an external baseblock signal.	
Cause		Possible Solution	Minor Fault (H2-□□ = 10)
External baseblock signal entered via multi-function input terminal (S1 to S7).		Check external sequence and baseblock signal input timing.	No output
Digital Operator Display		Minor Fault Name	
bUS	bUS	Option Communication Error	
		<ul style="list-style-type: none"> After initial communication was established, the connection was lost. Assign a run command frequency reference to the option card. 	
Cause		Possible Solution	Minor Fault (H2-□□ = 10)
Connection is broken or master controller stopped communicating.		<ul style="list-style-type: none"> Check for faulty wiring. Correct the wiring. Repair ground wiring or disconnected cables. 	YES
Option card is damaged.		If there are no problems with the wiring and the fault continues to occur, replace the option card.	
The option card is not properly connected to the drive.		<ul style="list-style-type: none"> The connector pins on the option card are not properly lined up with the connector pins on the drive. Reinstall the option card. 	
A data error occurred due to noise.		<ul style="list-style-type: none"> Check options available to minimize the effects of noise. Take steps to counteract noise in the control circuit wiring, main circuit lines and ground wiring. Try to reduce noise on the controller side. Use surge absorbers on magnetic contactors or other equipment causing the disturbance. Use cables recommended by Yaskawa, or another type of shielded line. The shield should be grounded on the controller side or on the drive input power side. All wiring for communications devices should be separated from drive input power lines. Install an EMC noise filter to the input side of the drive input power. 	
Digital Operator Display		Minor Fault Name	
CALL	CALL	Serial Communication Transmission Error	
		Communication has not yet been established.	
Cause		Possible Solution	Minor Fault (H2-□□ = 10)

Digital Operator Display		Minor Fault Name	
Communications wiring is faulty, there is a short circuit, or something is not connected properly.		<ul style="list-style-type: none"> Check for wiring errors. Correct the wiring. Remove and ground shorts and reconnect loose wires. 	YES
Programming error on the master side.		Check communications at start-up and correct programming errors.	
Communications circuitry is damaged.		<ul style="list-style-type: none"> Perform a self-diagnostics check. Replace the drive if the fault continues to occur. 	
Terminal resistance setting is incorrect.		The terminal slave drive must have the internal terminal resistance switch set correctly. Place DIP switch S2 to the ON position.	

Digital Operator Display		Minor Fault Name	
EE	CE	MEMOBUS/Modbus Communication Error	
		Control data was not received correctly for two seconds.	
Cause		Possible Solution	Minor Fault (H2-□□ = 10)
A data error occurred due to noise.		<ul style="list-style-type: none"> Check options available to minimize the effects of noise. Counteract noise in the control circuit wiring, main circuit lines and ground wiring. Reduce noise on the controller side. Use surge absorbers on magnetic contactors or other equipment causing the disturbance. Use cables recommended by Yaskawa or another type of shielded line. The shield should be grounded on the controller side or on the drive input power side. Separate all wiring for communications devices from drive input power lines. Install an EMC noise filter to the input side of the drive input power. 	YES
Communication protocol is incompatible.		<ul style="list-style-type: none"> Check the H5 parameter settings as well as the protocol setting in the controller. Ensure settings are compatible. 	
The CE detection time (H5-09) is set shorter than the time required for a communication cycle to take place.		<ul style="list-style-type: none"> Check the PLC. Change the software settings in the PLC. Set a longer CE detection time (H5-09). 	
Incompatible PLC software settings or there is a hardware problem.		<ul style="list-style-type: none"> Check the PLC. Remove the cause of the error on the controller side. 	
Communications cable is disconnected or damaged.		<ul style="list-style-type: none"> Check the connector for a signal through the cable. Replace the communications cable. 	

Digital Operator Display		Minor Fault Name	
Er5f	CrST	Can Not Reset	
Cause		Possible Solution	Minor Fault (H2-□□ = 10)
Fault reset was being executed when a run command was entered.		<ul style="list-style-type: none"> Ensure that a run command cannot be entered from the external terminals or option card during fault reset. Turn off the run command. 	YES

Digital Operator Display		Minor Fault Name	
E4C	CyC	MECHATROLINK Comm. Cycle Setting Error	
		Comm. Cycle Setting Error was detected.	
Cause		Possible Solution	Minor Fault (H2-□□ = 10)
The controller is using a comm. cycle beyond the allowable setting range for the MECHATROLINK option unit.		Set the comm. cycle for the upper controller within the allowable setting range for the MECHATROLINK option unit.	YES

Digital Operator Display		Minor Fault Name	
dEv	dEv	Speed Deviation (for Simple V/f with PG)	
		According to the pulse input (RP), the speed deviation is greater than the setting in F1-10 for a time longer than the setting in F1-11.	
Cause		Possible Solution	Minor Fault (H2-□□ = 10)

6.5 Alarm Detection

Digital Operator Display	Minor Fault Name	
Load is too heavy	Reduce the load.	
Acceleration and deceleration times are set too short.	Increase the acceleration and deceleration times (C1-01 through C1-08).	
The load is locked up.	Check the machine.	
Parameter settings are inappropriate.	Check the settings of parameters F1-10 and F1-11.	
The motor brake engaged.	Ensure the brake releases properly.	
	YES	

Digital Operator Display	Minor Fault Name	
$d\bar{n}\bar{E}$	dnE	Drive Disabled
Cause	Possible Solution	Minor Fault (H2-□□ = 10)
“Drive Enable” is set to a multi-function contact input (H1-□□ = 6A) and that signal was switched off.	Check the operation sequence.	YES

Digital Operator Display	Minor Fault Name	
$\bar{E}5$	E5	MECHATROLINK Watchdog Timer Error
Cause	Possible Solution	Minor Fault (H2-□□ = 10)
The watchdog timer expired while waiting for data from the controller.	Issue a DISCONNECT or ALM_CLR command, followed by a CONNECT or SYNC_SET command and move to phase 3.	YES

Digital Operator Display	Minor Fault Name	
$\bar{E}F$	EF	Forward/Reverse Run Command Input Error
	Both forward run and reverse run closed simultaneously for over 0.5 s.	
Cause	Possible Solution	Minor Fault (H2-□□ = 10)
Sequence error	Check the forward and reverse command sequence and correct the problem. Note: Motor ramps to stop when minor fault EF is detected.	YES

Digital Operator Display	Minor Fault Name	
$\bar{E}F0$	EF0	Option Card External Fault
	An external fault condition is present.	
Cause	Possible Solution	Minor Fault (H2-□□ = 10)
An external fault was received from the PLC with F6-03 = 3 (causing the drive to continue running when an external fault occurs).	<ul style="list-style-type: none"> Remove the cause of the external fault. Remove the external fault input from the PLC. 	YES
There is a problem with the PLC program.	Check the PLC program and correct problems.	

Digital Operator Display	Minor Fault Name	
$\bar{E}F1$	EF1	External fault (input terminal S1)
	External fault at multi-function input terminal S1.	
$\bar{E}F2$	EF2	External fault (input terminal S2)
	External fault at multi-function input terminal S2.	
$\bar{E}F3$	EF3	External fault (input terminal S3)
	External fault at multi-function input terminal S3.	
$\bar{E}F4$	EF4	External fault (input terminal S4)
	External fault at multi-function input terminal S4.	
$\bar{E}F5$	EF5	External fault (input terminal S5)
	External fault at multi-function input terminal S5.	
$\bar{E}F6$	EF6	External fault (input terminal S6)
	External fault at multi-function input terminal S6.	
$\bar{E}F7$	EF7	External fault (input terminal S7)
	External fault at multi-function input terminal S7.	

Digital Operator Display		Minor Fault Name	
Cause		Possible Solution	Minor Fault (H2-□□ = 10)
An external device has tripped an alarm function.		Remove the cause of the external fault and reset the multi-function input value.	YES
Wiring is incorrect.		<ul style="list-style-type: none"> Ensure the signal lines have been connected properly to the terminals assigned for external fault detection (H1-□□ = 20 to 2F). Reconnect the signal line. 	
Multi-function contact inputs are set incorrectly.		<ul style="list-style-type: none"> Check if the unused terminals have been set for H1-□□ = 20 to 2F (External Fault). Change the terminal settings. 	

Digital Operator Display		Minor Fault Name	
Cause		Possible Solution	Minor Fault (H2-□□ = 10)
<i>FbH</i>	FbH	Excessive PID Feedback The PID feedback input is higher than the level set in b5-36 for longer than the time set in b5-37, and b5-12 is set to 1 or 4.	YES
Parameters settings for b5-36 and b5-37 are incorrect.		Check parameters b5-36 and b5-37.	
PID feedback wiring is faulty.		Correct the wiring.	
Feedback sensor has malfunctioned.		Check the sensor and replace it if damaged.	
Feedback input circuit is damaged.		Replace the drive.	

Digital Operator Display		Minor Fault Name	
Cause		Possible Solution	Minor Fault (H2-□□ = 10)
<i>FbL</i>	FbL	PID Feedback Loss The PID feedback input is lower than the level set in b5-13 for longer than the time set in b5-14, and b5-12 is set to 1 or 4.	YES
Parameters settings for b5-13 and b5-14 are incorrect.		Check parameters b5-13 and b5-14.	
PID feedback wiring is faulty.		Correct the wiring.	
Feedback sensor has malfunctioned.		Check the sensor and replace it if damaged.	
Feedback input circuit is damaged.		Replace the drive.	

Digital Operator Display		Minor Fault Name	
Cause		Possible Solution	Minor Fault (H2-□□ = 10)
<i>Hbb</i>	Hbb	Safe Disable Signal Input The Safe Disable Input channel is open.	YES
There is no signal at terminal H1.		Check if external safety circuit tripped and disabled the drive. If the Safe Disable function is not utilized, check if the terminals HC, H1, and H2 are linked.	
Internally, the Safe Disable channel is broken.		Replace the drive.	

Digital Operator Display		Minor Fault Name	
Cause		Possible Solution	Minor Fault (H2-□□ = 10)
<i>HbbF</i>	HbbF	Safe Disable Signal Input The safe disable input hardware is defective.	YES
One of the Safe Disable channels is faulty.		Replace the drive.	

Digital Operator Display		Minor Fault Name	
Cause		Possible Solution	Minor Fault (H2-□□ = 10)
<i>HcA</i>	HcA	Current Alarm Drive current exceeded overcurrent warning level (150% of the rated current).	YES

6.5 Alarm Detection

Digital Operator Display		Minor Fault Name	
Load is too heavy.		<ul style="list-style-type: none"> • Measure the current flowing through the motor. • Reduce the load or increase the capacity of the drive. 	YES
Acceleration and deceleration times are too short.			
A special-purpose motor is being used, or the drive is attempting to run a motor greater than the maximum allowable capacity.			

Digital Operator Display		Minor Fault Name	
LF-1	LT-1	Cooling Fan Maintenance Time	
		The cooling fan has reached its expected maintenance period and may need to be replaced. Note: An alarm output (H2-□□ = 10) will only be triggered if H2-□□ = 2F.	
Cause		Possible Solution	Minor Fault (H2-□□ = 10)
The cooling fan has reached 90% of its expected performance life.		Replace the cooling fan and reset the Maintenance Monitor by setting o4-03 to 0.	–

Digital Operator Display		Minor Fault Name	
LF-2	LT-2	Capacitor Maintenance Time	
		The main circuit and control circuit capacitors are nearing the end of their expected performance life. Note: An alarm output (H2-□□ = 10) will only be triggered if H2-□□ = 2F.	
Cause		Possible Solution	Minor Fault (H2-□□ = 10)
The main circuit and control circuit capacitors have reached 90% of their expected performance life.		Replace either the control board or the entire drive. For instructions on replacing the control board, contact Yaskawa or your nearest sales representative.	–

Digital Operator Display		Minor Fault Name	
LF-3	LT-3	Soft Charge Bypass Relay Maintenance Time	
		The DC bus soft charge relay is nearing the end of its expected performance life. Note: An alarm output (H2-□□ = 10) will only be triggered if H2-□□ = 2F.	
Cause		Possible Solution	Minor Fault (H2-□□ = 10)
The DC bus soft charge relay has reached 90% of their expected performance life.		Replace either the control board or the entire drive. For instructions on replacing the control board, contact Yaskawa or your nearest sales representative.	–

Digital Operator Display		Minor Fault Name	
LF-4	LT-4	IGBT Maintenance Time (50%)	
		IGBTs have reached 50% of their expected performance life. Note: An alarm output (H2-□□ = 10) will only be triggered if H2-□□ = 2F.	
Cause		Possible Solution	Minor Fault (H2-□□ = 10)
IGBTs have reached 50% of their expected performance life.		Check the load, carrier frequency, and output frequency.	–

Digital Operator Display		Minor Fault Name	
oH	oH	Heatsink Overheat	
		The temperature exceeded the value set to L8-02.	
Cause		Possible Solution	Minor Fault (H2-□□ = 10)

Digital Operator Display	Minor Fault Name	
Surrounding temperature is too high	<ul style="list-style-type: none"> Check the surrounding temperature. Improve the air circulation within the enclosure panel. Install a fan or air conditioner to cool surrounding area. Remove anything near drive that may cause extra heat. 	
Internal cooling fan has stopped.	<ul style="list-style-type: none"> Replace the cooling fan. <i>Refer to Cooling Fan Replacement on page 317.</i> After replacing the fan, reset the cooling fan maintenance parameter to (o4-03 = "0"). 	
Airflow around the drive is restricted.	<ul style="list-style-type: none"> Provide proper installation space around the drive as indicated in the manual. <i>Refer to Correct Installation Orientation on page 38.</i> Allow for the specified space and ensure that there is sufficient circulation around the control panel. 	
	<ul style="list-style-type: none"> Check for dust or foreign materials clogging cooling fan. Clear debris caught in the fan that restricts air circulation. 	

YES

Digital Operator Display	Minor Fault Name	
oH2	oH2	Drive Overheat Warning
"Drive Overheat Warning" was input to a multi-function input terminal, S1 through S7 (H1-□□ = B)		
Cause		Possible Solution
An external device triggered and overheat warning in the drive.		<ul style="list-style-type: none"> Search for the device that tripped the overheat warning. Solving the problem will clear the warning.

Minor Fault
(H2-□□ = 10)

YES

Digital Operator Display	Minor Fault Name	
oH3	oH3	Motor Overheat
The motor overheat signal entered to a multi-function analog input terminal exceeded the alarm level (H3-02 or H3-10 = E).		
Cause		Possible Solution
Motor thermostat wiring is fault (PTC input).		Repair the PTC input wiring.
There is a fault on the machine side (e.g., the machine is locked up).		<ul style="list-style-type: none"> Check the status of the machine. Remove the cause of the fault.
Motor has overheated.		<ul style="list-style-type: none"> Check the load size, accel/decel times, and cycle times. Decrease the load. Increase accel and decel times (C1-01 to C1-08). Adjust the preset V/f pattern (E1-04 through E1-10). This will mainly involve reducing E1-08 and E1-10. Note: Do not lower E1-08 and E1-10 excessively, because this reduces load tolerance at low speeds. Check the motor-rated current. Enter motor-rated current on motor nameplate (E2-01). Ensure the motor cooling system is operating normally. Repair or replace the motor cooling system.

Minor Fault
(H2-□□ = 10)

YES

Digital Operator Display	Minor Fault Name	
oL3	oL3	Overtorque 1
Drive output current (or torque in OLV) was greater than L6-02 for longer than the time set in L6-03.		
Cause		Possible Solution
Inappropriate parameter settings.		Check parameters L6-02 and L6-03.
There is a fault on the machine side (e.g., the machine is locked up).		<ul style="list-style-type: none"> Check the status of the machine. Remove the cause of the fault.

Minor Fault
(H2-□□ = 10)

YES

Digital Operator Display	Minor Fault Name	
oL4	oL4	Overtorque 2
Drive output current (or torque in OLV) was greater than L6-05 for longer than the time set in L6-06.		
Cause		Possible Solution

Minor Fault
(H2-□□ = 10)

6.5 Alarm Detection

Digital Operator Display		Minor Fault Name	
Parameter settings are not appropriate.		Check parameters L6-05 and L6-06.	
There is a fault on the machine side (e.g., the machine is locked up).		<ul style="list-style-type: none"> • Check the status of the machine being used. • Remove the cause of the fault. 	YES

Digital Operator Display		Minor Fault Name	
<i>oL5</i>	oL5	Mechanical Weakening Detection 1	
		Overtorque occurred, matching the conditions specified in L6-08.	
Cause		Possible Solution	Minor Fault (H2-□□ = 10)
Overtorque occurred, triggering the mechanical weakening level set to L6-08.		Check for the cause of mechanical weakening.	YES

Digital Operator Display		Minor Fault Name	
<i>oS</i>	oS	Overspeed (for Simple V/f with PG)	
		Pulse input (RP) indicates that motor speed feedback exceeded F1-08 setting.	
Cause		Possible Solution	Minor Fault (H2-□□ = 10)
Overshoot or undershoot is occurring.		<ul style="list-style-type: none"> • Adjust the gain by using the pulse train input parameters (H6-02 through H6-05). • Adjust the speed feedback accuracy. • Increase the settings for C5-01 (Speed Control Proportional Gain 1) and reduce C5-02 (Speed Control Integral Time 1). 	YES
PG pulse settings are incorrect.		Set the H6-02 (Pulse Train Input Scaling) to the frequency of PG pulses at maximum motor speed.	
Parameter settings are inappropriate.		Check the setting for the overspeed detection level and the overspeed detection time (F1-08 and F1-09).	

Digital Operator Display		Minor Fault Name	
<i>ov</i>	ov	DC Bus Overvoltage	
		The DC bus voltage exceeded the trip point. For 200 V class: approximately 410 V For 400 V class: approximately 820 V (740 V when E1-01 < 400)	
Cause		Possible Solution	Minor Fault (H2-□□ = 10)
Surge voltage present in the drive input power.		<ul style="list-style-type: none"> • Install an AC reactor or DC link choke. • Voltage surge can result from a thyristor convertor and a phase advancing capacitor operating on the same drive input power system. 	YES
<ul style="list-style-type: none"> • The motor is short-circuited. • Ground current has over-charged the main circuit capacitors via the drive input power. 		<ul style="list-style-type: none"> • Check the motor power cable, relay terminals and motor terminal box for short circuits. • Correct grounding shorts and turn the power back on. 	
Noise interference causes the drive to operate incorrectly.		<ul style="list-style-type: none"> • Review possible solutions for handling noise interference. • Review section on handling noise interference and check control circuit lines, main circuit lines and ground wiring. • If the magnetic contactor is identified as a source of noise, install a surge protector to the MC coil. 	
		Set number of fault restarts (L5-01) to a value other than 0.	

Digital Operator Display		Minor Fault Name	
<i>PASS</i>	PASS	MEMOBUS/Modbus Comm. Test Mode Complete	
Cause		Possible Solution	Minor Fault (H2-□□ = 10)
MEMOBUS/Modbus test has finished normally.		This verifies that the test was successful.	No output

Digital Operator Display		Minor Fault Name	
<i>PGo</i>	PGo	PG Disconnect (for Simple V/f with PG)	
		Detected when no PG pulses received for a time longer than setting in F1-14.	
Cause		Possible Solution	Minor Fault (H2-□□ = 10)

Digital Operator Display		Minor Fault Name	
Pulse input (RP) is disconnected.		Reconnect the pulse input (RP).	
Pulse input (RP) wiring is wrong.		Correct the wiring.	
Motor brake is engaged.		Ensure the brake releases properly	
YES			

Digital Operator Display		Minor Fault Name	
<i>rUn</i>	rUn	Motor Switch during Run	
		A command to switch motors was entered during run.	
Cause		Possible Solution	
A motor switch command was entered during run.		Change the operation pattern so that the motor switch command is entered while the drive is stopped.	
Minor Fault (H2-□□ = 10) YES			

Digital Operator Display		Minor Fault Name	
<i>SE</i>	SE	MEMOBUS/Modbus Communication Test Mode Error	
Cause		Possible Solution	
A digital input programmed to 67H (MEMOBUS/Modbus test) was closed while the drive was running.		Stop the drive and run the test again.	
Minor Fault (H2-□□ = 10) No output			

Digital Operator Display		Minor Fault Name	
<i>TrPC</i>	TrPC	IGBT Maintenance Time (90%)	
		IGBTs have reached 90% of their expected performance life.	
Cause		Possible Solution	
IGBTs have reached 90% of their expected performance life.		Replace the drive.	
Minor Fault (H2-□□ = 10) YES			

Digital Operator Display		Minor Fault Name	
<i>UL3</i>	UL3	Undertorque Detection 1	
		Drive output current (or torque in OLV) less than L6-02 for longer than L6-03 time.	
Cause		Possible Solution	
Inappropriate parameter settings.		Check parameters L6-02 and L6-03.	
Load has dropped or decreased significantly.		Check for broken parts in the transmission system.	
Minor Fault (H2-□□ = 10) YES			

Digital Operator Display		Minor Fault Name	
<i>UL4</i>	UL4	Undertorque Detection 2	
		Drive output current (or torque in OLV) less than L6-05 for longer than L6-06 time.	
Cause		Possible Solution	
Inappropriate parameter settings.		Check parameters L6-05 and L6-06.	
The load has dropped or decreased significantly.		Check for broken parts in the transmission system.	
Minor Fault (H2-□□ = 10) YES			

Digital Operator Display		Minor Fault Name	
<i>UL5</i>	UL5	Mechanical Weakening Detection 2	
		The operation conditions matched the conditions set to L6-08.	
Cause		Possible Solution	
Undertorque was detected and matched the condition of mechanical loss detection operation selection (L6-08).		Check the load side for any problems.	
Minor Fault (H2-□□ = 10) YES			

6.5 Alarm Detection

Digital Operator Display		Minor Fault Name	
U_u	U_v	Undervoltage One of the following conditions was true when the drive was stopped and a run command was entered: <ul style="list-style-type: none"> • DC bus voltage dropped below the level specified in L2-05. • Contactor to suppress inrush current in the drive was open. • Low voltage in the control drive input power. This alarm outputs only if L2-01 is not 0 and DC bus voltage is under L2-05. 	
Cause		Possible Solution	Minor Fault (H2-□□ = 10)
Phase loss in the drive input power.		Check for wiring errors in the main circuit drive input power. Correct the wiring.	YES
Loose wiring in the drive input power terminals.		<ul style="list-style-type: none"> • Ensure the terminals have been properly tightened. • Apply the tightening torque specified in this manual to fasten the terminals. <i>Refer to Wire Gauges and Tightening Torques on page 58.</i> 	
There is a problem with the drive input power voltage.		<ul style="list-style-type: none"> • Check the voltage. • Lower the voltage of the drive input power so that it is within the limits listed in the specifications. 	
Drive internal circuitry is worn.		<ul style="list-style-type: none"> • Check the maintenance time for the capacitors (U4-05). • Replace the drive if U4-05 exceeds 90%. 	
The drive input power transformer is not large enough and voltage drops when the power is switched on.		<ul style="list-style-type: none"> • Check for a tripped alarm when the magnetic contactor, line breaker and leakage breaker are turned on. • Check the capacity of the drive input power transformer. 	
Air inside the drive is too hot.		<ul style="list-style-type: none"> • Check the temperature inside the drive. 	
The CHARGE indicator light is broken or disconnected.		<ul style="list-style-type: none"> • Replace the drive. 	

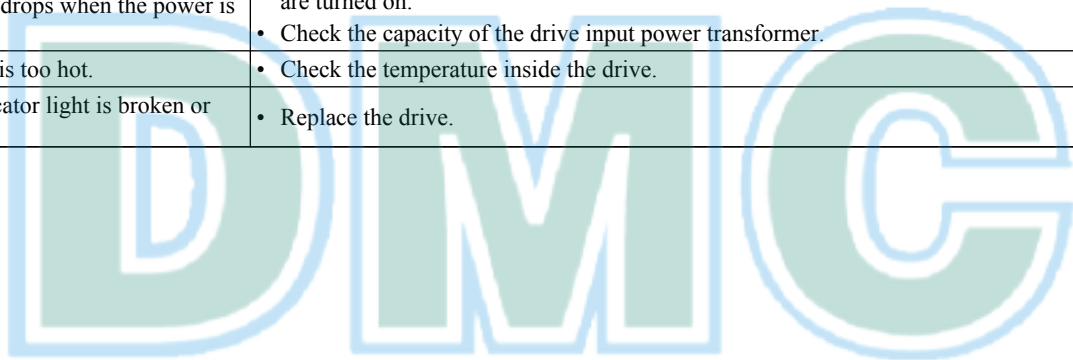

Drives Motors Controls

6.6 Operator Programming Errors

An Operator Programming Error (oPE) occurs when an inappropriate parameter is set or an individual parameter setting is inappropriate.

The drive will not operate until the parameter is set correctly; however, no alarm or fault outputs will occur. If an oPE occurs, investigate the cause and [Refer to oPE Codes, Causes, and Possible Solutions on page 291](#) for the appropriate action. When an oPE error is displayed, press the ENTER button to display U1-18 (oPE fault constant). This monitor displays the parameter causing the oPE error.

◆ oPE Codes, Causes, and Possible Solutions

Table 6.11 Detailed oPE Codes, Causes, and Possible Solutions

Digital Operator Display		Error Name
<i>oPE01</i>	oPE01	Drive Capacity Setting Fault
Cause		Possible Solution
The drive capacity setting (o2-04) and the actual capacity of the drive are not the same.		Correct the value set to o2-04.
Digital Operator Display		Fault Name
<i>oPE02</i>	oPE02	Parameter Range Setting Error
Cause		Possible Solution
Parameters were set outside the possible setting range.		Set parameters to the proper values.
Note: Other errors are given precedence over oPE02 when multiple errors occur at the same time.		
Digital Operator Display		Fault Name
<i>oPE03</i>	oPE03	Multi-Function Input Selection Error
Cause		Possible Solution
<ul style="list-style-type: none"> The same function is assigned to two multi-function inputs. Excludes “Not used” and “External Fault.” 		<ul style="list-style-type: none"> Ensure all multi-function inputs are assigned to different functions. Re-enter the multi-function settings to ensure this does not occur.
The Up command was set but the Down command was not, or vice versa (settings 10 vs. 11).		Correctly set functions that need to be enabled in combination with other functions.
The Up 2 command was set but the Down 2 command was not, or vice versa (settings 75 vs. 76).		
<ul style="list-style-type: none"> Run/Stop command for a 2-Wire sequence 2 was set (H1-□□ = 42), but forward/reverse command (H1-□□ = 43) was not. “Drive Enable” is set to multi-function input S1 or S2 (H1-01 = 6A or H1-02 = 6A). 		Correctly set functions that need to be enabled in combination with other functions.
Two of the following functions are set at the same time: <ul style="list-style-type: none"> Up/Down Command (10 vs. 11) Up 2/Down 2 Command (75 vs. 76) Hold Accel/Decel Stop (A) Analog Frequency Reference Sample/Hold (1E) Offset Frequency 1, 2, 3 Calculations (44, 45, 46) 		<ul style="list-style-type: none"> Check if contradictory settings have been assigned to the multi-function input terminals at the same time. Correct setting errors.
The Up/Down command (10, 11) is enabled at the same time as PID control (b5-01).		Set b5-01 to 0 to disable PID control or disable the Up/Down command.

6.6 Operator Programming Errors

Digital Operator Display	Fault Name
Settings for NC and NO input for the following functions were selected at the same time: <ul style="list-style-type: none"> External Search Command 1 and External Search Command 2 (61 vs. 62) Fast-Stop N.O. and Fast-Stop N.C. (15 vs. 17) KEB for Momentary Power Loss and High Slip Braking (65, 66, 7A, 7B vs. 68) Motor Switch Command and Accel/Decel Time 2 (16 vs. 1A) KEB Command 1 and KEB Command 2 (65, 66 vs. 7A, 7B) FWD Run Command (or REV) and FWD/REV Run Command (2-wire) (40, 41 vs. 42, 43) External DB Command and Drive Enable (60 vs. 6A) Motor Switch Command and Up 2/Down 2 Command (16 vs. 75, 76) 	Check for contradictory settings assigned to the multi-function input terminals at the same time. Correct setting errors.
One of the following settings was entered while H1-□□ = 2 (External Reference 1/2): <ul style="list-style-type: none"> b1-15 = 4 (Pulse Train Input) and H6-01 (Pulse Train Input Function Selection) not = 0 (Frequency Reference) b1-15 or b1-16 set to 3 but no option card connected Although b1-15 = 1 (Analog Input) and H3-02 or H3-10 are set to 0 (Frequency Bias). 	Correct the settings for the multi-function input terminal parameters.
H2-□□ = 38 (Drive Enabled) but H1-□□ is not set to 6A (Drive Enable).	
H1-□□ = 7E (Direction Detection) although H6-01 is not set to 3 (Simple V/f with PG).	

Digital Operator Display	Fault Name				
<table border="1"> <tr> <td>oPE04</td> <td>oPE04</td> </tr> <tr> <td>Cause</td> <td>Possible Solution</td> </tr> </table>	oPE04	oPE04	Cause	Possible Solution	Initialization required.
oPE04	oPE04				
Cause	Possible Solution				
The drive, control board, or terminal board has been replaced and the parameter settings between the control board and the terminal board no longer match.	To load the parameter settings to the drive that are stored in the terminal board, set A1-03 to 5550. Initialize parameters after drive replacement by setting A1-03 to 1110 or 2220.				

Digital Operator Display	Fault Name				
<table border="1"> <tr> <td>oPE05</td> <td>oPE05</td> </tr> <tr> <td>Cause</td> <td>Possible Solution</td> </tr> </table>	oPE05	oPE05	Cause	Possible Solution	Run Command/Frequency Reference Source Selection Error
oPE05	oPE05				
Cause	Possible Solution				
Frequency reference is assigned to an option card (b1-01 = 3) that is not connected to the drive.	Reconnect the option card to the drive.				
The Run command is assigned to an option card (b1-02 = 3) that is not connected to the drive.					
Frequency reference is assigned to the pulse train input (b1-01 = 4), but terminal RP is not set for pulse train input (H6-01 > 0)	Set H6-01 to 0.				

Digital Operator Display	Fault Name				
<table border="1"> <tr> <td>oPE07</td> <td>oPE07</td> </tr> <tr> <td>Cause</td> <td>Possible Solution</td> </tr> </table>	oPE07	oPE07	Cause	Possible Solution	Multi-Function Analog Input Selection Error
oPE07	oPE07				
Cause	Possible Solution				
	A contradictory setting is assigned to multi-function analog inputs H3-02 through to H3-10 and PID functions conflict.				

Digital Operator Display	Fault Name
H3-02 and H3-10 are set to the same value.	Change the settings to H3-02 and H3-10 so that functions no longer conflict. Note: Both 0 (primary analog frequency reference) and F (Not Used) can be set to H3-02 and H3-10 at the same time.
The following simultaneous contradictory settings: H3-02 or H3-10 = B (PID Feedback) H6-01 (Pulse Train Input) = 1 (PID Feedback)	Disable one of the PID selections.
The following simultaneous contradictory settings: H3-02 or H3-10 = C (PID Target Value) H6-01 = 2 (pulse train input sets the PID target value)	
The following simultaneous contradictory settings: H3-02 or H3-10 = C (PID Target Value) b5-18 = 1 (enables b5-19 as the target PID value)	
The following simultaneous contradictory settings: H6-01 or H3-10 = C (PID Target Value) b5-18 = 1 (enables b5-19 as the target PID value)	

Digital Operator Display	Fault Name
\square PE08	Parameter Selection Error
\square PE08	A function has been set that cannot be used in the motor control method selected.
Cause	Possible Solution
Attempted to use a function in the V/f motor control method that is only possible in Open Loop Vector Control.	Check the motor control method and the functions available.
Simple V/f with PG was enabled while not in V/f Control (H6-01 = 3).	To use Simple V/f with PG, ensure the motor control method has been set to V/f Control (A1-02 = 0).
In Open Loop Vector Control, n2-02 is greater than n2-03	Correct parameter settings so that n2-02 is less than n2-03.
In Open Loop Vector Control, C4-02 is greater than C4-06	Correct parameter settings so that C4-02 is less than C4-06.
In OLV/PMI, parameters E5-02 to E5-07 are set to 0.	<ul style="list-style-type: none"> Set the correct motor code in accordance with the motor being used (E5-01). When using a special-purpose motor, set E5-□□ in accordance with the Test Report provided.
The following conditions are true in PM Open Loop Vector Control: <ul style="list-style-type: none"> E5-03 does not equal 0 E5-09 and E5-24 are both equal to 0, or neither equals 0 	<ul style="list-style-type: none"> Set E5-09 or E5-24 to the correct value, and set the other to "0". Set the motor-rated current for PM to "0" (E5-03).
Note: Use U1-18 to find parameters set outside of the specified setting range. Other errors are given precedence over \square PE08 when multiple errors occur simultaneously.	

Digital Operator Display	Fault Name
\square PE09	PID Control Selection Fault
\square PE09	PID control function selection is incorrect. Requires that PID control is enabled (b5-01 = 1 to 4).
Cause	Possible Solution
The following simultaneous contradictory settings: <ul style="list-style-type: none"> b5-15 not 0.0 (PID Sleep Function Operation Level) The stopping method is set to either DC injection braking or coast to stop with a timer (b1-03 = 2 or 3). 	<ul style="list-style-type: none"> Set b5-15 to a value other than 0. Set the stopping method to coast to stop or ramp to stop (b1-03 = 0 or 1).
<ul style="list-style-type: none"> D control is being used on the setpoint deviation (b5-01 = 1) or on the feedback value (b5-01 = 2). A negative PID output value is set to operate the drive in reverse (b5-11 = 1) and the frequency reference lower limit greater than 0 (d2-02 > 0). 	Set parameters b5-01, b5-11, and d2-02 to the proper values.

6.6 Operator Programming Errors

Digital Operator Display	Fault Name
<ul style="list-style-type: none"> D control is being used on the setpoint deviation and the frequency reference plus the PID output (b5-01 = 4), D control is being used on the feedback value and the frequency reference plus the PID output (b5-01 = 4). The frequency reference lower limit is set to a value greater than 0 (d2-02 > 0). 	Set parameters b5-01 and d2-02 to the proper values.
The absolute value of the lower limit for PID output is greater than the PID upper limit (b5-34 > b5-06).	Set parameters b5-34 and b5-06 to the proper values.

Digital Operator Display	Fault Name
<div style="display: flex; justify-content: space-between;"> <div style="border: 1px solid black; padding: 2px;">oPE10</div> <div style="border: 1px solid black; padding: 2px;">oPE10</div> </div>	V/f Data Setting Error One or more of the parameters listed below are not set according to the formula: <ul style="list-style-type: none"> E1-09 ≤ E1-07 < E1-06 ≤ E1-11 ≤ E1-04 E3-09 ≤ E3-07 < E3-06 ≤ E3-11 ≤ E3-04
Cause	Possible Solution
V/f pattern setting error.	Correct the settings for E1-04, E1-06, E1-07, E1-09, and E1-11. For motor 2, correct E3-04, E3-06, E3-07, E3-09, and E3-11.

Digital Operator Display	Fault Name
<div style="display: flex; justify-content: space-between;"> <div style="border: 1px solid black; padding: 2px;">oPE11</div> <div style="border: 1px solid black; padding: 2px;">oPE11</div> </div>	Carrier Frequency Setting Error Correct the setting for the carrier frequency.
Cause	Possible Solution
The following simultaneous contradictory settings: C6-05 is greater than 6 and C6-04 is greater than C6-03 (carrier frequency lower limit is greater than the upper limit). If C6-05 is less than or equal to 6, the drive operates at C6-03. Upper and lower limits between C6-02 and C6-05 contradict each other.	Correct the parameter settings.

Digital Operator Display	Fault Name
<div style="display: flex; justify-content: space-between;"> <div style="border: 1px solid black; padding: 2px;">oPE13</div> <div style="border: 1px solid black; padding: 2px;">oPE13</div> </div>	Pulse Monitor Selection Error Incorrect setting of monitor selection for Pulse Train (H6-06).
Cause	Possible Solution
Scaling for the Pulse Train monitor is set to 0 (H6-07 = 0) while H6-06 is not set to 000, 031, 101, 102, 105, or 116.	Change scaling for the Pulse Train monitor or set H6-06 to 000, 031, 101, 102, 105, or 116.

6.7 Auto-Tuning Fault Detection

Auto-Tuning faults are shown below. When the following faults are detected, the fault is displayed on the digital operator and the motor coasts to a stop. No fault or alarm outputs will occur

◆ Auto-Tuning Codes, Causes, and Possible Solutions

Table 6.12 Detailed Auto-Tuning Codes, Causes, and Possible Solutions

Digital Operator Display		Error Name
<i>End1</i>	End1	Excessive V/f Setting. Displayed after Auto-Tuning is complete.
Cause		Possible Solution
The torque reference exceeded 20% during Auto-Tuning.		<ul style="list-style-type: none"> Before Auto-Tuning the drive, verify the information written on the motor nameplate and enter that data to T1-03 through T1-05. Enter proper information to parameters T1-03 to T1-05 and repeat Auto-Tuning. If possible, disconnect the motor from the load and perform Auto-Tuning.
The no-load current exceeded 80% of the drive rated current during Auto-Tuning.		

Digital Operator Display		Fault Name
<i>End2</i>	End2	Motor Iron-Core Saturation Coefficient. Detected only during Rotational Auto-Tuning and displayed after Auto-Tuning is complete.
Cause		Possible Solution
Motor data entered during Auto-Tuning was incorrect.		<ul style="list-style-type: none"> Enter the correct data. Restart Auto-Tuning and enter the correct information. Check and correct faulty motor wiring. Disconnect the motor from machine and perform Rotational Auto-Tuning.
Auto-Tuning calculated values outside the parameter setting range, assigning the iron-core saturation coefficient (E2-07, E2-08) a temporary value.		

Digital Operator Display		Fault Name
<i>End3</i>	End3	Rated Current Setting Alarm (displayed after Auto-Tuning is complete)
Cause		Possible Solution
<ul style="list-style-type: none"> The motor line-to-line resistance and the motor-rated current are not consistent with one another. The correct current rating printed on the nameplate was not entered into T1-04. 		<ul style="list-style-type: none"> Check T1-04 setting. Check the motor data and repeat Auto-Tuning.

Digital Operator Display		Fault Name
<i>Er-01</i>	Er-01	Motor Data Error
Cause		Possible Solution
Motor data entered during Auto-Tuning was incorrect.		<ul style="list-style-type: none"> Enter the correct data. Restart Auto-Tuning and enter the correct information. Check the drive and motor capacities. Correct the settings of parameters T1-02 and T1-04.
Motor output and motor-rated current settings (T1-02 and T1-04) do not match.		
Motor output and no-load current settings (T1-04 and E2-03) do not match. Data required when Auto-Tuning for OLV Control or Stationary Auto-Tuning.		<ul style="list-style-type: none"> Check the motor-rated current and no-load current. Correct the settings of parameters T1-04 and E2-03.
Base frequency and base motor rotations (T1-05 and T1-07) do not match.		Set T1-05 and T1-07 to the correct values.

Digital Operator Display		Fault Name
<i>Er-02</i>	Er-02	Minor Fault
Cause		Possible Solution
Motor data entered during Auto-Tuning was incorrect.		<ul style="list-style-type: none"> Enter the correct data. Restart Auto-Tuning and enter the correct information. Check the wiring and correct defective connections. Check around the machine. Check the load.
The wiring is faulty.		
Load is too heavy.		

6.7 Auto-Tuning Fault Detection

Digital Operator Display		Fault Name
Er-03	Er-03	STOP Button Input
Cause		Possible Solution
Auto-Tuning canceled by pressing STOP button.		Auto-Tuning did not complete properly and will have to be performed again.

Digital Operator Display		Fault Name
Er-04	Er-04	Line-to-Line Resistance Error
Cause		Possible Solution
Motor data entered during Auto-Tuning was incorrect.		<ul style="list-style-type: none"> Enter the correct data. Restart Auto-Tuning and enter the correct information.
Auto-Tuning did not complete within designated time frame.		<ul style="list-style-type: none"> Check and correct faulty motor wiring.
Drive-calculated values outside parameter setting range.		<ul style="list-style-type: none"> Disconnect the motor from machine and perform Rotational Auto-Tuning.

Digital Operator Display		Fault Name
Er-05	Er-05	No-Load Current Error
Cause		Possible Solution
Motor data entered during Auto-Tuning was incorrect.		<ul style="list-style-type: none"> Enter the correct data. Restart Auto-Tuning and enter the correct information.
Auto-Tuning did not complete within designated time frame.		<ul style="list-style-type: none"> Check and correct faulty motor wiring.
Drive-calculated values outside parameter setting range.		<ul style="list-style-type: none"> Disconnect the motor from machine and perform Rotational Auto-Tuning.

Digital Operator Display		Fault Name
Er-08	Er-08	Rated Slip Error
Cause		Possible Solution
Motor data entered during Auto-Tuning was incorrect.		<ul style="list-style-type: none"> Enter the correct data. Restart Auto-Tuning and enter the correct information.
Auto-Tuning did not complete within designated time frame.		<ul style="list-style-type: none"> Check and correct faulty motor wiring.
Values calculated by the drive are outside the allowable parameter setting ranges.		<ul style="list-style-type: none"> Disconnect the motor from machine and perform Auto-Tuning.

Digital Operator Display		Fault Name
Er-09	Er-09	Acceleration Error (detected only during Rotational Auto-Tuning)
Cause		Possible Solution
The motor did not accelerate for the specified acceleration time.		<ul style="list-style-type: none"> Increase the acceleration time (C1-01). Check if it is possible to disconnect the machine from the motor.
Torque limit when motoring is too low (L7-01 and L7-02).		<ul style="list-style-type: none"> Check the settings of parameters L7-01 and L7-02. Increase the setting.

Digital Operator Display		Fault Name
Er-11	Er-11	Motor Speed Fault (detected only when Auto-Tuning is enabled)
Cause		Possible Solution
Torque reference is too high. (Enabled in OLV only.)		<ul style="list-style-type: none"> Increase the acceleration time in C1-01. Disconnect the machine from the motor, if possible.

Digital Operator Display		Fault Name
Er-12	Er-12	Current Detection Error
Cause		Possible Solution
One of the motor phases is missing (U/T1, V/T2, W/T3).		Check motor wiring and correct problems.

Digital Operator Display	Fault Name
Current exceeded the current rating of the drive.	<ul style="list-style-type: none"> • Check the motor wiring for a short between motor lines. • If a magnetic contactor is used between motors, ensure it is on. • Replace the drive.
The current is too low.	
Attempted Auto-Tuning without motor connected to the drive.	Connect the motor and perform Auto-Tuning.
Current detection signal error.	Replace the drive.

DMC

Drives Motors Controls

6.8 Diagnosing and Resetting Faults

When a fault occurs and the drive stops, follow the instructions below to remove whatever conditions triggered the fault, then restart the drive.

◆ Fault Occurs Simultaneously with Power Loss

WARNING! *Electrical Shock Hazard. Ensure there are no short circuits between the main circuit terminals (R/L1, S/L2, and T/L3) or between the ground and main circuit terminals before restarting the drive. Failure to comply may result in serious injury or death and will cause damage to equipment.*

1. Turn on the drive input power.
2. Use monitor parameters U2-□□ to display data on the operating status of the drive just before the fault occurred.
3. Remove the cause of the fault and reset.











Note: To find out what faults were triggered, check U2-02 (Fault History). Information on drive status when the fault occurred such as the frequency, current and voltage, can be found in U2-03 through U2-17. [Refer to Viewing Fault Trace Data After Fault on page 298](#) for information on how to view fault trace data.

Note: When the fault continues to be displayed after cycling power, remove the cause of the fault and reset.

◆ If the Drive Still has Power After a Fault Occurs

1. Look at the LED operator for information on the fault that occurred.
2. [Refer to Fault Displays, Causes, and Possible Solutions on page 267](#)
3. Reset the fault. [Refer to Fault Reset Methods on page 298](#).

◆ Viewing Fault Trace Data After Fault

Step	Display/Result
1. Turn on the drive input power. The first screen displays.	
2. Press  until the monitor screen is displayed.	
3. Press  to display the parameter setting screen.	
4. Press  and > until U2-02 (Fault History) is displayed.	
5. Press  to view most recent fault (here, EF3).	
6. Press  to view drive status information when fault occurred.	
7. Parameters U2-03 through U2-17 help determine cause of fault.	

◆ Fault Reset Methods

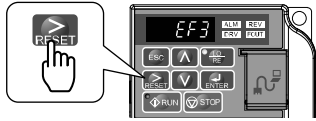
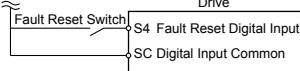
After the Fault Occurs	Procedure	
Fix the cause of the fault, restart the drive, and reset the fault	Press  on the digital operator.	
Fix the cause of the fault and reset via Fault Reset Digital Input S4.	Close then open the fault signal digital input via terminal S4. S4 is set fault reset as default (H1-04 = 12)	

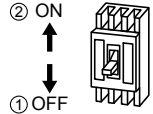
After the Fault Occurs	Procedure	
	If the above methods do not reset the fault, turn off the drive main power supply. Reapply power after LED operator display is out.	 <p>The diagram shows a fuse with a switch mechanism. An upward-pointing arrow is labeled '② ON' and a downward-pointing arrow is labeled '① OFF'. The fuse is depicted as a rectangular component with a central window and a small tab on the right side.</p>



DMC

Drives Motors Controls

6.9 Troubleshooting without Fault Display



This section describes troubleshooting problems that do not trip an alarm or fault.



◆ Cannot Change Parameter Settings

Cause	Possible Solutions
The drive is running the motor (i.e., the Run command is present).	<ul style="list-style-type: none"> Stop the drive and switch over to the Programming Mode. Most parameters cannot be edited during run.
The Access Level is set to restrict access to parameter settings.	<ul style="list-style-type: none"> Set the Access Level to allow parameters to be edited (A1-01 = 2).
The operator is not in the Parameter Setup Mode (the LED screen will display “PAR”).	<ul style="list-style-type: none"> See what mode the LED parameter is current set for. Parameters cannot be edited when in the Setup Mode (“STUP”). Switch modes so that “PAR” appears on the screen.
A multi-function contact input terminal is set to allow or restrict parameter editing (H1-01 through H1-07 = 1B).	<ul style="list-style-type: none"> When the terminal is open, parameters cannot be edited. Turn on the multi-function contact input set to 1B.
The wrong password was entered.	<ul style="list-style-type: none"> If the password entered to A1-04 does not match the password saved to A1-05, then drive settings cannot be changed. Reset the password. <p>If you cannot remember the password:</p> <ul style="list-style-type: none"> Display parameter A1-04. Press the  button while pressing  at the same time. Parameter A1-05 will appear. Set a new password to parameter A1-05.
Undervoltage was detected.	<ul style="list-style-type: none"> Check the drive input power voltage by looking at the DC bus voltage (U1-07). Check all main circuit wiring.

◆ Motor Does Not Rotate Properly after Pressing RUN Button or after Entering External Run Command

■ Motor Does Not Rotate

Cause	Possible Solutions
The drive is not in the Drive Mode.	<ul style="list-style-type: none"> Check if the DRV light on the LED operator is lit. Enter the Drive Mode to begin operating the motor. <i>Refer to The Drive and Programming Modes on page 84.</i>
The  button was pushed.	<p>Stop the drive and check if the correct frequency reference source is selected. If the operator keypad shall be the source, the LO/RE button LED must be on, if the source is REMOTE, it must be off. Take the following steps to solve the problem:</p> <ul style="list-style-type: none"> Push the  button. If o2-01 is set to 0, then the LO/RE button will be disabled.
Auto-Tuning has just completed.	<ul style="list-style-type: none"> When Auto-Tuning has completed, the drive is switched back to the Programming Mode. The Run command will not be accepted unless the drive is in the Drive Mode. Use the LED operator to enter the Drive Mode. <i>Refer to The Drive and Programming Modes on page 84.</i>
A Fast-Stop was executed and has not yet been reset.	Reset the Fast-Stop command.
Settings are incorrect for the source that provides the run command.	<p>Check parameter b1-02 (Run Command Selection). Set b1-02 so that it corresponds with the correct run command source.</p> <p>0: LED/LCD operator 1: Control circuit terminal (default setting) 2: MEMOBUS/Modbus communications 3: Option card</p>
One of the Safety Inputs is open.	<ul style="list-style-type: none"> Check for a short-circuit between terminals H1 and HC. See if one of the Safety Inputs is open. Correct any faulty wiring.
There is faulty wiring in the control circuit terminals.	<ul style="list-style-type: none"> Check the wiring for the control terminal. Correct wiring mistakes. Check the input terminal status monitor (U1-10).

Cause	Possible Solutions
The drive has been set to accept the frequency reference from the incorrect source.	Check parameter b1-01 (Frequency Reference Selection 1). Set b1-01 to the correct source of the frequency reference. 0: LED operator 1: Control circuit terminal (default setting) 2: MEMOBUS/Modbus communications 3: Option card 4: Pulse train input (RP)
The terminal set to accept the main speed reference is set to the incorrect voltage and/or current.	If the frequency reference is set at terminal A1, check parameter H3-01 for the correct signal level selection. If terminal A2 is used, check DIP switch S1. Then select the correct input level for terminal A2 in parameter H3-08. <i>Refer to DIP Switch S1 Analog Input Signal Selection on page 70.</i>
Selection for the sink/source mode is incorrect.	Check DIP switch S3. <i>Refer to Sinking/Sourcing Mode Switch on page 68.</i>
Frequency reference is too low.	<ul style="list-style-type: none"> Check the frequency reference monitor (U1-01). Increase the frequency by changing the maximum output frequency (E1-09).
Multi-function analog input is set up to accept gain for the frequency reference, but no voltage (current) has been provided.	<ul style="list-style-type: none"> Check the multi-function analog input settings. Check if analog input A1 or A2 is set for frequency reference gain (H3-02/10 = 1). If so, check if the correct signal is applied to the terminal. The gain and the frequency reference will be 0 if no signal is applied to the gain input. Check if H3-02 and H3-10 have been set to the proper values. Check if the analog input value has been set properly.
The  button was pressed when the drive was started from a REMOTE source.	<ul style="list-style-type: none"> When the  button is pressed, the drive will decelerate to stop. Switch off the run command and then re-enter a run command. The  button is disabled when o2-02 is set to 0.
Motor is not producing enough torque in the V/f motor control method.	<ul style="list-style-type: none"> Ensure the selected V/f pattern corresponds with the characteristics of the motor being used. Set the correct V/f pattern to E1-03. When E1-03 = F, increase both the minimum and mid output frequency voltages (E1-08, E1-10).
	Increase the frequency reference so that it is higher than the minimum frequency reference (E1-09).
	Perform Line-to-Line Resistance Auto-Tuning when using particularly long motor cables.
	Increase the torque compensation gain (C4-01).
Motor is not producing enough torque in Open Loop Vector Control.	<ul style="list-style-type: none"> Execute Rotational Auto-Tuning. If the motor cables are replaced with longer cables after Rotational Auto-Tuning was performed, Auto-Tuning may need to be repeated due to voltage drop across the line.
	<ul style="list-style-type: none"> Check if the torque limit parameters have been set too low (L7-01 through L7-04). Reset the torque limit back to its default setting (200%).
	Increase both the minimum and mid output frequency voltages (E1-08 and E1-10).
The drive is set for both 2-Wire and 3-Wire sequence at the same time.	<ul style="list-style-type: none"> The drive is set for a 3-Wire sequence when one of parameters H1-03 through H1-07 is set to 0. If the drive is supposed to be set up for a 2-Wire sequence, then ensure parameters H1-03 through H1-07 are not set to 0. If the drive is supposed to be set up for a 3-Wire sequence, then H1-□□ must be set to 0.

■ Motor Rotates in the Opposite Direction from the Run Command

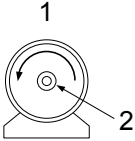
Cause	Possible Solutions
Phase wiring between the drive and motor is incorrect.	<ul style="list-style-type: none"> Check the motor wiring. Switch two motor cables (U, V, and W) to reverse motor direction. Connect drive output terminals U/T1, V/T2 and W/T3 in the right order to the corresponding motor terminals U, V, and W. Change the setting of parameter b1-14.
The forward direction for the motor is setup incorrectly.	<p>Typically, forward is designated as being counterclockwise when looking from the motor shaft (refer to the figure below).</p>  <p>1. Forward Rotating Motor (looking down the motor shaft) 2. Motor Shaft</p>

6.9 Troubleshooting without Fault Display

Cause	Possible Solutions
The motor is running at almost 0 Hz and the Speed Search estimated the speed to be in the opposite direction.	<ul style="list-style-type: none"> Disable bi-directional search (b3-14 = "0") so that Speed Search is performed only in the specified direction.

Note: Check the motor specifications for the forward and reverse directions. The motor specifications will vary depending on the manufacturer of the motor.

■ Motor Rotates in One Direction Only

Cause	Possible Solutions
The drive prohibits reverse rotation.	<ul style="list-style-type: none"> Check parameter b1-04. Set the drive to allow the motor to rotate in reverse (b1-04 = "0").
A Reverse run signal has not been entered, although 3-Wire sequence is selected.	<ul style="list-style-type: none"> Make sure that one of the input terminals S3 to S7 used for the 3-Wire sequence has been set for reverse.

■ Motor is Too Hot

Cause	Possible Solutions
The load is too heavy.	<p>If the load is too heavy for the motor, the motor will overheat as it exceeds its rated torque value for an extended period of time. Keep in mind that the motor also has a short-term overload rating in addition to the possible solutions provided below:</p> <ul style="list-style-type: none"> Reduce the load. Increase the acceleration and deceleration times. Check the values set for the motor protection (L1-01, L1-02) as well as the motor rated current (E2-01). Increase motor capacity.
The air around the motor is too hot.	<ul style="list-style-type: none"> Check the ambient temperature. Cool the area until it is within the specified temperature range.
The drive is operating in a vector control mode but Auto-Tuning has not yet been performed.	<ul style="list-style-type: none"> Perform Auto-Tuning. Calculate the motor value and reset the motor parameters. Change the motor control method to V/f Control (A1-02 = "0").
Insufficient voltage insulation between motor phases.	<p>When the motor is connected to terminals U/T1, V/T2, and W/T3, voltage surges occur between the motor coils and drive switching. Normally, surges can reach up to three times the drive input power supply voltage (600 V for 200 V class, and 1200 V for 400 V class).</p> <ul style="list-style-type: none"> Use a motor with voltage tolerance higher than the max voltage surge. Use a motor designed to work specifically with a drive when using a 400 V class unit. Install an AC reactor on the output side of the drive.
The motor fan has stopped or is clogged.	Check the motor fan.

■ Drive Does Not Allow Selection of Rotational Auto-Tuning

Cause	Possible Solutions
The drive is in the incorrect motor control method for Rotational Auto-Tuning.	<ul style="list-style-type: none"> Check if the drive is set to V/f Control by accident (A1-02 = 0). Change the motor control method to Open Loop Vector Control (A1-02 = "2").

■ Motor Hunting Occurs at Low Speeds

Cause	Possible Solutions
Excessive load inertia in Open Loop Vector Control.	<ul style="list-style-type: none"> Excess load inertia can cause motor hunting in Open Loop Vector Control due to slow motor response. Increase the speed feedback detection control time constant (n2-02) from its default value of 50 ms to an appropriate level between 200 and 1000 ms. Adjust this setting in combination with n2-03 (Feedback Detection Control Time Constant 2).

■ oPE02 Error Occurs when Lowering the Motor Rated Current Setting

Cause	Possible Solutions
The motor rated current and the motor no-load current settings in the drive are incorrect.	<p>The user is trying to set the motor rated current in E2-01 to a value lower than the no-load current set in E2-03.</p> <ul style="list-style-type: none"> • Make sure that value set in E2-01 is higher than E2-03. Setting $E2-01 < E2-03$ will trigger an oPE02 error. • If it is necessary to set E2-01 lower than E2-03, first lower the value set to E2-03, then change the setting in E2-01 as needed.

■ Overvoltage Occurs When Running at a Constant Speed

Cause	Possible Solutions
Excessive load inertia in Open Loop Vector Control.	<ul style="list-style-type: none"> • Loads with a lot of inertia (fans, etc.) can trigger an overvoltage fault when operating in Open Loop Vector Control. • Switch to the V/f motor control method. • Adjust the values set for the speed feedback detection control time constant (n2-02, n2-03).

■ Motor Stalls During Acceleration or With Large Loads

Cause	Possible Solutions
Load is too heavy.	<p>Take the following steps to resolve the problem:</p> <ul style="list-style-type: none"> • Reduce the load. • Increase the acceleration time. • Increase motor capacity. • Although the drive has a Stall Prevention function and a Torque Compensation Limit function, accelerating too quickly or trying to drive an excessively large load can exceed the capabilities of the motor.

■ Motor Will Not Accelerate or the Acceleration Time is Too Long

Cause	Possible Solutions
Frequency reference is too low.	<ul style="list-style-type: none"> • Check the maximum output frequency (E1-04). • Increase E1-04 if it is set too low. <p>Check U1-01 for proper frequency reference.</p> <p>Check if a frequency reference signal switch has been set to one of the multi-function input terminals.</p> <p>Check for low gain level set to terminals A1 or A2 (H3-03, H3-11).</p>
Load is too heavy.	<ul style="list-style-type: none"> • Reduce the load so that the output current remains within the motor-rated current. • In extruder and mixer applications, the load will sometimes increase as the temperature drops. <p>Check if the mechanical brake is fully releasing as it should.</p>
The torque limit function is operating in Open Loop Vector Control.	<ul style="list-style-type: none"> • Check the torque limit setting. It may be too low. (L7-01 through L7-04). • Reset the torque limit to its default value (200%).
Acceleration time has been set too long.	Check if the acceleration time parameters have been set too long (C1-01, -03, -05, -07).
Motor characteristics and drive parameter settings are incompatible with one another in V/f Control.	<ul style="list-style-type: none"> • Set the correct V/f pattern so that it matches the characteristics of the motor being used. • Check E1-03 (V/f Pattern Selection).
The right combination of motor characteristics have not been set in Open Loop Vector Control.	Execute Rotational Auto-Tuning.
Incorrect frequency reference setting.	<ul style="list-style-type: none"> • Check the multi-function analog input settings. • Check if multi-function analog input terminal A1 or A2 is set for frequency gain (H3-02 or H3-10 = "1"). If so, the frequency reference will be 0 if there is no voltage (current) input provided. • Ensure H3-02 and H3-10 are set to the proper values. • Ensure the analog input value is set to the right value (U1-13, U1-14).
The Stall Prevention level during acceleration and deceleration set too low.	<ul style="list-style-type: none"> • Check the Stall Prevention level during acceleration (L3-02). • If L3-02 is set too low, acceleration will take a fair amount of time. • Increase L3-02.
The Stall Prevention level during run has been set too low.	<ul style="list-style-type: none"> • Check the Stall Prevention level during run (L3-06). • If L3-06 is set too low, speed will drop as the drive outputs torque. • Increase the setting value.

6.9 Troubleshooting without Fault Display

Cause	Possible Solutions
Although the drive is operating in Open Loop Vector motor control method, Auto-Tuning has not been performed.	<ul style="list-style-type: none"> Perform Auto-Tuning. Calculate motor data and reset motor parameters. Switch to the V/f motor control method (A1-02 = "0").
Drive reached the limitations of the V/f motor control method.	<ul style="list-style-type: none"> The motor cable may be long enough (over 50 m) to require Auto-Tuning for line-to-line resistance. Be aware that V/f Control is comparatively limited when it comes to producing torque at low speeds. Consider switching to Open Loop Vector Control.

■ Drive Frequency Reference Differs from the Controller Frequency Reference Command

Cause	Possible Solutions
The analog input frequency gain and bias are set to incorrect values.	<ul style="list-style-type: none"> Check the main speed frequency reference terminal input gain level assigned to terminals A1 and A2, as well as the frequency reference input bias to terminals A1 and A2 (parameters H3-03, H3-04, and H3-12). Set these parameters to the appropriate values.
A frequency bias signal is being entered via analog input terminals A1 or A2.	<ul style="list-style-type: none"> If multi-function analog input terminals A1 and A2 are set for frequency reference (H3-02 = 0 and H3-10 = 0), the addition of both signals builds the frequency reference. Ensure that H3-02 and H3-10 are set appropriately. Check the input level set for terminals A1 and A2 (U1-13, U1-14).

■ Poor Speed Control Accuracy

Cause	Possible Solutions
Drive reached the slip compensation limit.	<ul style="list-style-type: none"> Check the slip compensation limit (C3-03). Increase the value set to C3-03.
Motor-rated voltage is set too high in Open Loop Vector Control.	<ul style="list-style-type: none"> The input voltage for the drive determines the maximum output voltage. A drive with an input of 200 Vac can only output a maximum of 200 Vac. Open Loop Vector Control sometimes calculates an output voltage reference value that exceeds the maximum drive output voltage level, resulting in a loss of speed control accuracy. Use a motor with a lower voltage rating (a vector control motor). Increase the input power voltage.
Auto-Tuning did not complete properly for Open Loop Vector Control.	<ul style="list-style-type: none"> Perform Auto-Tuning again.

■ Deceleration Takes Longer Than Expected with Dynamic Braking Enabled

Cause	Possible Solutions
L3-04 is set incorrectly.	<ul style="list-style-type: none"> Check the Stall Prevention Level during deceleration (L3-04). If a braking resistor option has been installed, disable Stall Prevention during deceleration (L3-04 = "0").
The deceleration time is set too long.	Set deceleration to more appropriate time (C1-02, C1-04, C1-06, C1-08).
Insufficient motor torque.	<ul style="list-style-type: none"> Assuming parameter settings are normal and that no overvoltage occurs when there is insufficient torque, it is likely that the demand on the motor has exceeded the motor capacity. Use a larger motor.
Reaching the torque limit.	<ul style="list-style-type: none"> Check the settings for the torque limit (L7-01 through L7-04). If the torque limit is enabled, deceleration might take longer than expected because the drive cannot output more torque than the limit setting. Ensure the torque limit is set to a large enough value. Increase the torque limit setting. If multi-function analog input terminal A1 or A2 is set to torque limit (H3-02 or H3-10 equals 10, 11, 12, or 15), ensure that the analog input levels are set to the correct levels. Ensure H3-02 and H3-10 are set to the right levels. Ensure the analog input is set to the correct value.
Load exceeded the internal torque limit determined by the drive rated current.	Switch to a larger capacity drive.

Motor Hunting Occurs When Operating With a Light Load

Cause	Possible Solutions
Carrier frequency is too high.	Lower the carrier frequency setting C6-02.
Large V/f setting value at low speeds triggers overexcitation.	<ul style="list-style-type: none"> Select the proper V/f pattern (E1-03). Use parameters E1-04 through E1-10 to set the V/f pattern in relation to the load characteristics.
The maximum output frequency and the base frequency reference are not set properly in relationship to each other.	Set the proper values for the maximum output frequency and base frequency (E1-04, E1-06).
Hunting Prevention is disabled (V/f control only).	<ul style="list-style-type: none"> Enable Hunting Prevention by setting n1-01 = "1". (OLV only) Increase the speed feedback detection control gain and time constant (n2-01, n2-02).

Load Falls When Brake is Applied (Elevator-Type Applications)

Cause	Possible Solutions
The timing for the brake to close and release is not set properly.	<p>Use frequency reference detection for closing and releasing the brake.</p> <ul style="list-style-type: none"> At start: Release the brake after creating enough torque. At stop: Close the brake when the motor still produces torque. <p>Make the following setting changes to hold the brake:</p> <ul style="list-style-type: none"> Set the frequency detection inactive during baseblock (L4-07 = 0). Multi-function contact output terminal will switch on when the output frequency is greater than the frequency detection level set in L4-01. Set L4-01 between 1.0 and 3.0 Hz. Slipping may occur when stopping because hysteresis is used in Frequency Reference 2 (where the frequency agree setting in L4-02 is 2.0 Hz). To prevent this, change the setting to 0.1 Hz. Do not use the multi-function contact output setting "During Run" (H2-01 = 0) for the brake signal.
Insufficient DC Injection Braking.	Increase the amount of DC Injection Braking (b2-02).

Noise From Drive or Output Lines When the Drive is Powered On

Cause	Possible Solutions
Relay switching in the drive generates excessive noise.	<ul style="list-style-type: none"> Lower the carrier frequency (C6-02). Install a noise filter on the input side of drive input power. Install a noise filter on the output side of the drive. Place the wiring inside a metal conduit to shield it from switching noise. Ground the drive and motor properly. Separate the main circuit wiring and the control lines.

Ground Fault Circuit Interrupter (GFCI) Trips During Run

Cause	Possible Solutions
Excessive leakage current trips MCCB.	<ul style="list-style-type: none"> Increase the GFCI sensitivity or use GFCI with a higher threshold. Lower the carrier frequency (C6-02). Reduce the length of the cable used between the drive and the motor. Install a noise filter or reactor on the output side of the drive.

Connected Machinery Vibrates When Motor Rotates

Excessive Motor Oscillation and Erratic Rotation

Cause	Possible Solution
Poor balance between motor phases.	Check drive input power voltage to ensure that it provides stable power.

Unexpected Noise from Connected Machinery

Cause	Possible Solutions
The carrier frequency is at the resonant frequency of the connected machinery.	Adjust the carrier frequency using parameters C6-02 through C6-05.
The drive output frequency is the same as the resonant frequency of the connected machinery.	<ul style="list-style-type: none"> Adjust the parameters used for the Jump Frequency function (d3-01 through d3-04) to skip the problem-causing bandwidth. Place the motor on a rubber pad to reduce vibration.

Note: The drive may have trouble assessing the status of the load due to white noise generated when using Swing PWM (C6-02 = 7 to A).

6.9 Troubleshooting without Fault Display

■ Oscillation or Hunting

Cause	Possible Solutions
Insufficient tuning in Open Loop Vector Control	Adjust the following parameters in the order listed. An increase in gain should be followed with an increase in the primary delay time constant. <ul style="list-style-type: none"> • C4-02 (Torque Compensation Primary Delay Time) • n2-01 (Speed Feedback Detection Control [AFR] Time Constant 1) • C3-02 (Slip Compensation Primary Delay Time) The response for torque compensation and slip compensation will drop as the time constant is increased.
Auto-Tuning has not yet been performed (required for Open Loop Vector Control).	Perform Auto-Tuning. Set motor parameters after calculating the proper values. Change the motor control method to V/f Control (A1-02 = "0").
Insufficient tuning in V/f Control.	Reduce the gain. <ul style="list-style-type: none"> • n1-02 (Hunting Prevention Gain Setting) • n1-03 (Hunting Prevention Time Constant Setting)
Gain is too low when using PID control.	Check the period of oscillation and adjust P, I, and D settings accordingly.
The frequency reference is assigned to an external source and the signal is noisy.	<ul style="list-style-type: none"> • Ensure that noise is not affecting the signal lines. • Separate main circuit wiring and control circuit wiring. • Use twisted-pair cables or shielded wiring for the control circuit. • Increase the analog input time filter constant (H3-13).
The cable between the drive and motor is too long.	<ul style="list-style-type: none"> • Perform Auto-Tuning. • Reduce the length of the cable.

■ PID Output Fault

Cause	Possible Solutions
No PID feedback input.	<ul style="list-style-type: none"> • Check the multi-function analog input terminal settings. • Set multi-function analog input terminal A1 or A2 for PID feedback (H3-02 or H3-10 = "B"). • A signal input to the terminal selection for PID feedback is necessary. • Check the connection of the feedback signal. • Check the various PID-related parameter settings. • No PID feedback input to the terminal causes the value detected to be 0, causing a PID fault and the drive to operate at max frequency.
The level of detection and the target value do not correspond with each other.	<ul style="list-style-type: none"> • PID control keeps the difference between target and detection values at 0. Set the input level for the values relative to one another. • Use analog input gains H3-03/11 to adjust PID target and feedback signal scaling.
Reverse drive output frequency and speed detection. When output frequency rises, the sensor detects a speed decrease.	Set PID output for reverse characteristics (b5-09 = "1").

■ Insufficient Motor Torque

Cause	Possible Solutions
Auto-Tuning has not yet been performed (required for OLV Control).	Perform Auto-Tuning.
The control mode was changed after performing Auto-Tuning.	Perform Auto-Tuning again.
Only Line-to-Line Resistance Auto-Tuning was performed.	Perform Rotational Auto-Tuning.

■ Motor Rotates After the Drive Output is Shut Off

Cause	Possible Solutions
Low DC Injection Braking and the drive cannot decelerate properly.	<ul style="list-style-type: none"> • Adjust the DC Injection braking settings. • Increase the value of b2-02 (DC Injection Braking Current). • Increase the b2-04 (DC Injection Braking Time at Stop).

■ **Over or Speed Loss Occurs When Starting into a Rotating Load**

Cause	Possible Solutions
The load is already rotating when the drive is trying to start it.	<ul style="list-style-type: none"> • Stop the motor using DC Injection braking. Restart the motor. • Increase the value of b2-03 (DC Injection Braking Time at start). • Enable Speed Search at start (b3-01 = "1"). • Set a multi-function input terminal for external Speed Search command (H1-□□="61" or "62" during restart).

■ **Output Frequency is not as High as Frequency Reference**

Cause	Possible Solutions
Frequency reference is set within the range of the Jump Frequency.	<ul style="list-style-type: none"> • Adjust the parameters used for the Jump Frequency function (d3-01, d3-02, d3-03). • Enabling the Jump Frequency prevents the drive from outputting the frequencies specified in the Jump Frequency range.
Upper limit for the frequency reference has been exceeded.	<ul style="list-style-type: none"> • Set the maximum output frequency and the upper limit for the frequency reference to more appropriate values (E1-04, d2-01). • The following calculation yields the upper value for the output frequency = E1-04 x d2-01 / 100
Large load triggered Stall Prevention function during acceleration.	<ul style="list-style-type: none"> • Reduce the load. • Adjust the Stall Prevention level during acceleration (L3-02).

■ **Buzzing Sound from Motor at 2 kHz**

Cause	Possible Solutions
Exceeded 110% of the rated output current of the drive while operating at low speeds.	<ul style="list-style-type: none"> • If the output current rises too high at low speeds, the carrier frequency automatically reduces and causes a whining or buzzing sound. • If the sound is coming from the motor, disable carrier frequency derating (L8-38 = "0"). • Disabling the automatic carrier frequency derating increases the chances of an overload fault (oL2). Switch to a larger capacity motor if oL2 faults occur too frequently.

■ **Unstable Motor Speed when Using PM or IPM**

Cause	Possible Solutions
The motor code for PM (E5-01) is set incorrectly. (Yaskawa motors only)	Set parameter E5-01 in accordance with the motor being used.
The drive is operating at less than 10% of the speed reference.	Consult with Yaskawa about using a different type of motor when attempting to operate at 10% of the speed reference.
Motor hunting occurs.	Set and carefully adjust the following parameters in the order listed: <ul style="list-style-type: none"> • n8-45 (Speed Feedback Detection Suppression Gain) • n8-55 (Load Inertia for PM Motors) • C4-02 (Torque Compensation Primary Delay Time)
Hunting occurs at start.	Increase the S-curve time at the start of acceleration (C2-01).
Too much current is flowing through the drive.	<ul style="list-style-type: none"> • If using a PM motor, set the correct motor code to E5-01. • If using a specialized motor, set parameter E5-xx to the correct value according to the Motor Test Report.

■ **Motor Does Not Operate When the RUN Button on the Digital Operator is Pressed**

Cause	Possible Solutions
The LOCAL/REMOTE mode is not selected properly.	Press the LOCAL/REMOTE button to switch. The LO/RE LED should be on for LOCAL mode.
The drive is not in drive mode.	A run command will not be issued. Exit to the drive mode and cycle the run command.
The frequency reference is too low.	<ul style="list-style-type: none"> • If the frequency reference is set below the frequency set in E1-09 (Minimum Output Frequency), the drive will not operate. • Raise the frequency reference to at least the minimum output frequency.

■ **Motor Does Not Operate When an External Run Command is Input**

Cause	Possible Solutions
The LOCAL/REMOTE mode is not selected properly.	Press the LOCAL/REMOTE button to switch. The LO/RE LED should be off for REMOTE mode.
The drive is not in Drive Mode.	A run command will not be issued. Exit to the Drive mode and cycle the run command.

6.9 Troubleshooting without Fault Display

Cause	Possible Solutions
The frequency reference is too low.	<ul style="list-style-type: none"> If the frequency reference is set below the frequency set in E1-09 (Minimum Output Frequency), the drive will not operate. Raise the frequency reference to at least the minimum output frequency.

■ Motor Stops During Acceleration or When a Load is Connected

Cause	Possible Solution
<ul style="list-style-type: none"> The load is too heavy. The limit of motor response may be reached during rapid acceleration. This may be a result of improper stall prevention or automatic torque boost function adjustment. 	Increase the acceleration time (C1-01) or reduce the motor load. Also, consider increasing the motor size and/or drive size.

■ Motor Rotates in One Direction Only

Cause	Possible Solutions
"Reverse run prohibited" is selected. If b1-04 (Reverse Prohibit Operation) is set to 1 (reverse run prohibited), the drive will not accept a reverse run command.	Set b1-04 = "0" to allow reverse run operation.
The drive prohibits reverse rotation.	<ul style="list-style-type: none"> Check parameter b1-04. Set the drive to allow the motor to rotate in reverse (b1-04 = "0").
A Reverse run signal has not been entered, although 3-Wire sequence is selected.	<ul style="list-style-type: none"> Make sure that one of the input terminals S3 to S5 used for the 3-Wire sequence has been set for reverse.

■ Motor Operates at a Higher Speed than the Speed Command

Cause	Possible Solution
PID is enabled. If the PID mode is enabled (b5-01 = 1 to 4), the drive output frequency will change to regulate the process variable to the target setpoint. The PID can command a speed up to maximum output frequency (E1-04).	If PID operation is not target, disable PID by setting b5-01 = "0".

■ Poor Speed Control Accuracy Above Base Speed in Open Loop Vector Motor Control Method

Cause	Possible Solution
The maximum output voltage of the drive is determined by its input voltage. Vector control uses voltage to control the currents within the motor. If the vector control voltage reference value exceeds the drive output voltage capability, the speed control accuracy will decrease because the motor currents cannot be properly controlled.	Use a motor with a lower rated voltage compared to the input voltage.

■ Peripheral Devices Affected by Drive Operation

Cause	Possible Solutions
Radio frequency interference may be generated by drive output PWM waveform.	<ul style="list-style-type: none"> Change the Carrier Frequency Selection (C6-02) to lower the carrier frequency. This will help to reduce the amount of transistor switching noise. Install an Input Noise Filter at the input power terminals. Install an Output Noise Filter at the motor terminals. Use conduit. Metal can shield electrical noise. Ground the drive and motor. Separate main circuit wiring from control wiring.

■ Ground Fault Interrupter Activates When Drive is Running

Cause	Possible Solutions
The output of the drive is a series of high frequency pulses (PWM), so there is a certain amount of leakage current. This may cause the ground fault interrupter to operate and cut off the drive input power.	<ul style="list-style-type: none"> Change to a ground fault interrupter with a higher leakage current detection level (such as, a sensitivity current of 200 mA or greater per Unit, with an operating time of 0.1 s or more), or one that incorporates high-frequency corrective actions. Change the Carrier Frequency Selection (C6-02) to lower the carrier frequency. Note: Leakage current increases in proportion to cable length.

Periodic Inspection & Maintenance

This chapter describes the periodic inspection and maintenance of the drive to ensure that it receives the proper care to maintain overall performance.

7.1	SECTION SAFETY	310
7.2	INSPECTION	312
7.3	PERIODIC MAINTENANCE	314
7.4	DRIVE COOLING FANS	316
7.5	DRIVE REPLACEMENT	319

DMC

Drives Motors Controls

7.1 Section Safety

DANGER

Electrical Shock Hazard

Do not connect or disconnect wiring while the power is on.

Failure to comply will result in death or serious injury.

WARNING

Electrical Shock Hazard

Do not operate equipment with covers removed.

Failure to comply could result in death or serious injury.

The diagrams in this section may show drives without covers or safety shields to show details. Be sure to reinstall covers or shields before operating the drives and run the drives according to the instructions described in this manual.

Always ground the motor-side grounding terminal.

Improper equipment grounding could result in death or serious injury by contacting the motor case.

Do not remove covers or touch circuit boards while the power is on.

Failure to comply could result in death or serious injury.

Do not allow unqualified personnel to perform work on the drive.

Failure to comply could result in death or serious injury.

Installation, maintenance, inspection, and servicing must be performed only by authorized personnel familiar with installation, adjustment, and maintenance of AC drives.

Do not perform work on the drive while wearing loose clothing, jewelry or without eye protection.

Failure to comply could result in death or serious injury.

Remove all metal objects such as watches and rings, secure loose clothing, and wear eye protection before beginning work on the drive.

Do not touch any terminals before the capacitors have fully discharged.

Failure to comply could result in death or serious injury.

Before wiring terminals, disconnect all power to the equipment. The internal capacitor remains charged even after the power supply is turned off. The charge indicator LED will extinguish when the DC bus voltage is below 50 Vdc. To prevent electric shock, wait at least five minutes after all indicators are off and measure the DC bus voltage level to confirm safe level.

Fire Hazard

Tighten all terminal screws to the specified tightening torque.

Loose electrical connections could result in death or serious injury by fire due to overheating of electrical connections.

Do not use an improper voltage source.

Failure to comply could result in death or serious injury by fire.

Verify that the rated voltage of the drive matches the voltage of the incoming power supply before applying power.

Do not use improper combustible materials.

Failure to comply could result in death or serious injury by fire.

Attach the drive to metal or other noncombustible material.

NOTICE

Observe proper electrostatic discharge procedures (ESD) when handling the drive and circuit boards.

Failure to comply may result in ESD damage to the drive circuitry.

Never connect or disconnect the motor from the drive while the drive is outputting voltage.

Improper equipment sequencing could result in damage to the drive.

Do not use unshielded cable for control wiring.

Failure to comply may cause electrical interference resulting in poor system performance. Use shielded, twisted-pair wires and ground the shield to the ground terminal of the drive.

Do not allow unqualified personnel to use the product.

Failure to comply could result in damage to the drive or braking circuit.

Carefully review instruction manual TOBPC72060000 when connecting a braking option to the drive.

Do not modify the drive circuitry.

Failure to comply could result in damage to the drive and will void warranty.

Yaskawa is not responsible for any modification of the product made by the user. This product must not be modified.

Check all the wiring to ensure that all connections are correct after installing the drive and connecting any other devices.

Failure to comply could result in damage to the drive.

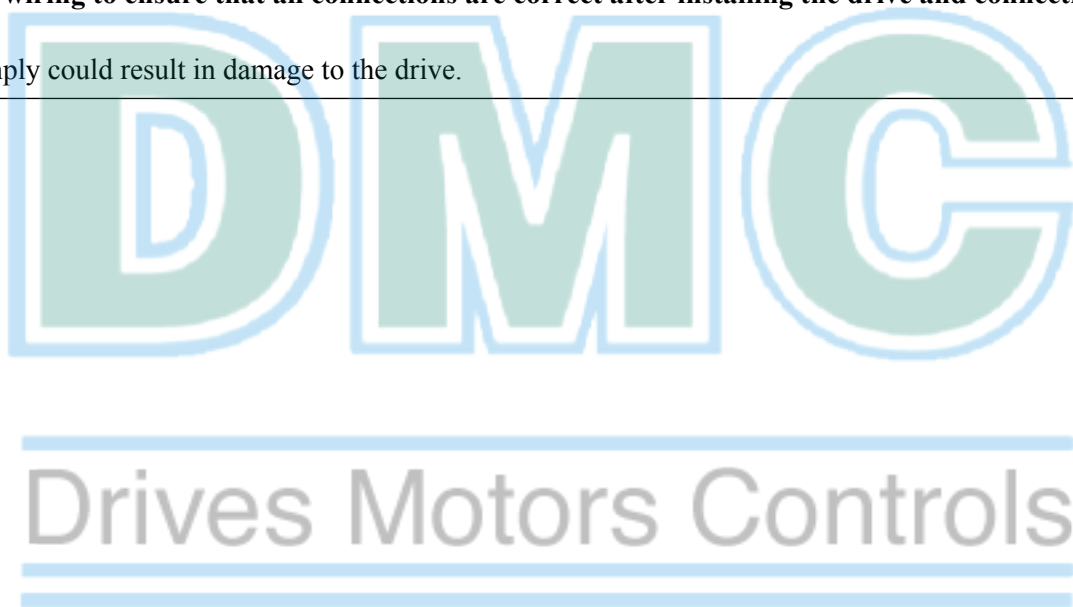

7.2 Inspection

Power electronics have limited life and may exhibit changed characteristics or performance deterioration after years of use under normal conditions. To help avoid such problems, it is important to perform preventive maintenance and periodic inspection on the drive.

Drives contain a variety of power electronics such as power transistors, semiconductors, capacitors, resistors, fans, and relays. The electronics in the drive serve a critical role in maintaining proper motor control.

Follow the inspection lists provided in this chapter as a part of a regular maintenance program.

Note: The drive will require more frequent inspection if it is placed in harsh environments, such as:

- High ambient temperatures
- Frequent starting and stopping
- Fluctuations in the AC supply or load
- Excessive vibrations or shock loading
- Dust, metal dust, salt, sulfuric acid, chlorine atmospheres
- Poor storage conditions.

Perform the first equipment inspection 3 months after installation.

◆ Recommended Daily Inspection

Table 7.1 outlines the recommended daily inspection for Yaskawa drives. Check the following items on a daily basis to avoid premature deterioration in performance or product failure. Copy this checklist and mark the “Checked” column after each inspection.

WARNING! Electrical Shock Hazard. Do not connect or disconnect wiring while the power is on. Failure to comply can result in serious personal injury. Before servicing the drive, disconnect all power to the equipment. The internal capacitor remains charged even after the power supply is turned off. The charge indicator LED will extinguish when the DC bus voltage is below 50 Vdc. To prevent electric shock, wait at least five minutes after all indicators are OFF and measure the DC bus voltage level to confirm safe level.

Table 7.1 General Recommended Daily Inspection Checklist

Inspection Category	Inspection Points	Corrective Action	Checked
Motor	<ul style="list-style-type: none"> • Inspect for abnormal oscillation or noise coming from the motor. 	<ul style="list-style-type: none"> • Check the load coupling. • Measure motor vibration. • Tighten all loose components. 	
Cooling	<ul style="list-style-type: none"> • Inspect for abnormal heat generated from the drive or motor and visible discoloration. 	<ul style="list-style-type: none"> • Check for excessive load. • Loose connections • Check for dirty heatsink or motor. • Ambient temperature 	
Cooling Fan	<ul style="list-style-type: none"> • Inspect drive cooling fan operation. 	<ul style="list-style-type: none"> • Check for clogged or dirty fan. • Check fan operation drive parameter. 	
Environment	<ul style="list-style-type: none"> • Verify the drive environment complies with the specifications listed in the Installation section of this manual. 	<ul style="list-style-type: none"> • Eliminate the source of contaminants or correct poor environment. 	
Load	<ul style="list-style-type: none"> • The drive output current should not be higher than the motor or drive rating for an extended period of time. 	<ul style="list-style-type: none"> • Check for excessive load. • Check the motor parameter settings of the drive. 	
Power Supply Voltage	<ul style="list-style-type: none"> • Check main power supply and control voltages. 	<ul style="list-style-type: none"> • Correct the voltage or power supply to within nameplate specifications. • Verify all main circuit phases. 	

◆ Recommended Periodic Inspection

Table 7.2 outlines the recommended periodic inspections for Yaskawa drive installations. Periodic inspections should generally be checked every 3-6 months; however, the drive may require more frequent inspection due to poor environments or rigorous use. Operating and environmental conditions, along with experience in each application, will determine the actual inspection frequency for each installation. Periodic inspection will help to avoid premature deterioration in performance or product failure. Copy this checklist and mark the “Checked” column after each inspection.

■ Periodic Inspection

WARNING! Electrical Shock Hazard. Do not connect or disconnect wiring while the power is on. Failure to comply can result in serious personal injury. Before servicing the drive, disconnect all power to the equipment. The internal capacitor remains charged even after the power supply is turned off. The charge indicator LED will extinguish when the DC bus voltage is below 50 Vdc. To prevent electric shock, wait at least five minutes after all indicators are OFF and measure the DC bus voltage level to confirm safe level.

Table 7.2 Periodic Inspection Checklist

Inspection Area	Inspection Points	Corrective Action	Checked
Main Circuit Periodic Inspection			
General	<ul style="list-style-type: none"> Overall check of the main power circuit and ground terminals 	Take appropriate actions (e.g., tightening loose connections).	
	<ul style="list-style-type: none"> Inspect equipment for discoloration from overheating or deterioration. Inspect for damaged or deformed parts. 	<ul style="list-style-type: none"> Replace damaged components as required. The drive has few serviceable parts and may require complete drive replacement. 	
	<ul style="list-style-type: none"> Inspect for dirt, foreign particles, or dust collection on components. 	<ul style="list-style-type: none"> Inspect enclosure door seal if present. Replace components if cleaning is not possible. Remove foreign particles and dust with a vacuum cleaner to avoid touching parts. 	
Conductors and Wiring	<ul style="list-style-type: none"> Inspect wiring and connections for discoloration, damage, or heat stress. Inspect wire insulation and shielding for wear. 	<ul style="list-style-type: none"> Repair or replace damaged wiring. 	
Terminals	<ul style="list-style-type: none"> Inspect terminals for stripped, damaged, or loose connections. 	<ul style="list-style-type: none"> Tighten loose screws and replace damaged screws or terminals. 	
Relays and Contactors	<ul style="list-style-type: none"> Inspect contactors and relays for excessive noise during operation. Inspect coils for signs of overheating such as melted or cracked insulation. 	<ul style="list-style-type: none"> Check coil voltage for over or under voltage conditions. Replace damaged removable relays contactors or circuit board. 	
Braking Resistors	<ul style="list-style-type: none"> Inspect for discoloration of heat stress on or around resistors. 	<ul style="list-style-type: none"> Minor discoloration may be acceptable. If discoloration exists check for loose connections. 	
Motor Periodic Inspection			
Operation Check	<ul style="list-style-type: none"> Check for increased vibration or abnormal noise. 	<ul style="list-style-type: none"> Stop the motor and contact qualified maintenance personnel as required. 	
Control Circuit Periodic Inspection			
General	<ul style="list-style-type: none"> Inspect terminals for stripped, damaged or loose connections. Check for tightness. 	<ul style="list-style-type: none"> Tighten loose screws and replace damaged screws or terminals. If terminals are integral to a circuit board then board or drive replacement may be required. 	
Cooling System Periodic Inspection			
Cooling Fan	<ul style="list-style-type: none"> Check for abnormal oscillation or unusual noise. Check for damaged or missing fan blades. 	<ul style="list-style-type: none"> Replace as required. <i>Refer to Drive Cooling Fans on page 316</i> for information on cleaning or replacing the cooling fan. 	
Heatsink	<ul style="list-style-type: none"> Inspect for dust or other foreign material collected on the surface. 	<ul style="list-style-type: none"> Remove foreign particles and dust with a vacuum cleaner to avoid touching parts. 	
Air Duct	<ul style="list-style-type: none"> Inspect air intake and exhaust openings. They must be free from obstruction and properly installed. 	<ul style="list-style-type: none"> Visually inspect the area. Clear obstructions and clean air duct as required. 	
LED Periodic Inspection			
LEDs	<ul style="list-style-type: none"> Make sure the LED lights correctly. Inspect for dust or other foreign material that may have collected on surrounding components. 	<ul style="list-style-type: none"> Contact your Yaskawa representative if there is any trouble with the LED or keypad. Clean the LED. 	

Note: Periodic inspections should be performed every one or two years. The drive, however, may require more frequent inspection due to poor environments or rigorous use.

7.3 Periodic Maintenance

The drive has various "maintenance monitors." This feature provides advance maintenance warning and eliminates the need to shut down the entire system for unexpected problems. The drive allows the user to check the following maintenance periods.

- Cooling Fan
- Electrolytic Capacitors (Main Circuit)
- Inrush Prevention Circuit
- IGBT

◆ Replacement Parts

Table 7.3 contains the estimated performance life of components that require replacement during the life of the drive. Only use Yaskawa replacement parts for the appropriate drive model and revision.

Table 7.3 Estimated Performance Life

Component	Estimated Performance Life
Cooling Fan	10 years
Electrolytic Capacitors (Main Circuit)	10 years <1>

<1> The drive has few serviceable parts and may require complete drive replacement.

NOTICE: *Estimated performance life based on specific usage conditions. These conditions are provided for the purpose of replacing parts to maintain performance. Some parts may require more frequent replacement due to poor environments or rigorous use.*

Usage conditions for estimated performance life:

- Ambient temperature: Yearly average of 40 °C
- Load factor: 80% maximum
- Operation time: 24 hours a day

■ Performance Life Monitors

The drive calculates the maintenance period for components that may require replacement during the life of the drive. A percentage of the maintenance period is displayed on the LED digital operator by viewing the appropriate monitor parameter. When the maintenance period reaches 100%, there is increased risk that the drive may malfunction. Yaskawa recommends checking the maintenance period regularly to ensure maximum performance life.

Refer to Recommended Periodic Inspection on page 313 for more details.

Table 7.4 Performance Life Monitors Used for Component Replacement

Parameter	Component	Contents
U4-03	Cooling Fan	Displays the accumulated operation time of the cooling fan, from 0 to 99999 hours. This value is automatically reset to 0 once it reaches 99999.
U4-04		Displays the accumulated cooling fan operation time as a percentage of the specified maintenance period (displayed in percent %).
U4-05	Main Circuit (DC bus) Electrolytic Capacitors	Displays the accumulated time the capacitors are used as a percentage of the specified maintenance period.
U4-06	Inrush (pre-charge) relay	Displays the number of times the drive is powered up as a percentage of the performance life of the inrush circuit.
U4-07	IGBT	Displays the percentage of the maintenance period reached by the IGBTs.

■ Alarm Outputs for Maintenance Monitors

An output can be set up to inform the user when a specific components has neared its expected performance life.

When one of multi-function digital output terminals has been assigned the maintenance monitor function (H2-□□ = 2F), the terminal will close when the cooling fan, DC bus capacitors, or DC bus pre-charge relay reach 90% of the expected performance life, or when the IGBTs have reached 50% of their expected performance life. Additionally the digital operator will display an alarm like shown in [Table 7.5](#) to indicate the specific components that may need maintenance.

Table 7.5 Maintenance Alarms

Digital Operator Alarm Display	Function	Function	Corrective Action
LF-1 <>	LT-1	The cooling fans have reached 90% of their designated life time.	Replace the cooling fan.
LF-2 <>	LT-2	The DC bus capacitors have reached 90% of their designated life time.	Contact a Yaskawa representative or the nearest Yaskawa sales office on possible drive replacement.
LF-3 <>	LT-3	The DC bus charge circuit has reached 90% of its designated life time.	Contact a Yaskawa representative or the nearest Yaskawa sales office on possible drive replacement.
LF-4 <>	LT-4	The IGBTs have reached 50% of their designated life time.	Check the load, carrier frequency, and output frequency.
TrPC <>	TrPC	The IGBTs have reached 90% of their designated life time.	Contact a Yaskawa representative or the nearest Yaskawa sales office on possible drive replacement.

<1> This alarm message will be output only if the Maintenance Monitor function is assigned to one of the digital outputs (H2-□□ = 2F). The alarm will also trigger a digital output that is programmed for alarm indication (H2-□□ = 10).

<2> This alarm message will always be output, even if the Maintenance Monitor function is not assigned to any of the digital outputs (H2-□□ = 2F). The alarm will also trigger a digital output that is programmed for alarm indication (H2-□□ = 10).

■ Related Drive Parameters

Use parameters o4-03, o4-05, o4-07, and o4-09 to reset a Maintenance Monitor to zero after replacing a specific component. [Refer to Parameter List on page 353](#) for details on parameter settings.

NOTICE: *If these parameters are not reset after the corresponding parts have been replaced, the Maintenance Monitor function will continue to count down the performance life from the value that was reached with the old part. If the Maintenance Monitor is not reset, the drive will not have the correct value of the performance life for the new component.*

Drives Motors Controls

7.4 Drive Cooling Fans

NOTICE: Follow cooling fan replacement instructions. The cooling fan cannot operate properly when installed incorrectly and could seriously damage the drive. To ensure maximum useful product life, replace all cooling fans when performing maintenance.

Contact your Yaskawa representative or supplier to order replacement cooling fans as required.

Some drive models have multiple cooling fans.

For drives with multiple cooling fans, replace all the fans when performing maintenance to ensure maximum useful product life.

◆ Number of Cooling Fans

Drive Model	Cooling Fans
Single-Phase 200 V Class	
BA0001	–
BA0002	–
BA0003	–
BA0006	–
BA0010	1
BA0012	1
BA0018	2
Three-Phase 200 V Class	
2A0001	–
2A0002	–
2A0004	–
2A0006	1
2A0010	1
2A0012	1
2A0020	1
2A0030	2
2A0040	2
2A0056	2
2A0069	2
Three-Phase 400 V Class	
4A0001	–
4A0002	–
4A0004	–
4A0005	1
4A0007	1
4A0009	1
4A0011	1
4A0018	2
4A0023	2
4A0031	2
4A0038	2

◆ Cooling Fan Replacement

The cooling fan is installed on the top of the drive. The cooling fan can easily be replaced without tools or removal of the drive or enclosure parts.

WARNING! *Electrical Shock Hazard. Do not connect or disconnect wiring while the power is on. Failure to comply can result in serious personal injury. Before servicing the drive, disconnect all power to the equipment. The internal capacitor remains charged even after the power supply is turned off. The charge indicator LED will extinguish when the DC bus voltage is below 50 Vdc. To prevent electric shock, wait at least five minutes after all indicators are OFF and measure the DC bus voltage level to confirm safe level.*

CAUTION! *Burn Hazard. Do not touch a hot drive heatsink. Failure to comply could result in minor or moderate injury. Shut off the power to the drive when replacing the cooling fan. To prevent burns, wait at least 15 minutes and ensure the heatsink has cooled down.*

■ Removing the Cooling Fan

1. Depress the right and left sides of the fan cover tabs and pull upward. Remove the fan cover from the top of the drive. The following figure illustrates a drive with a single cooling fan.

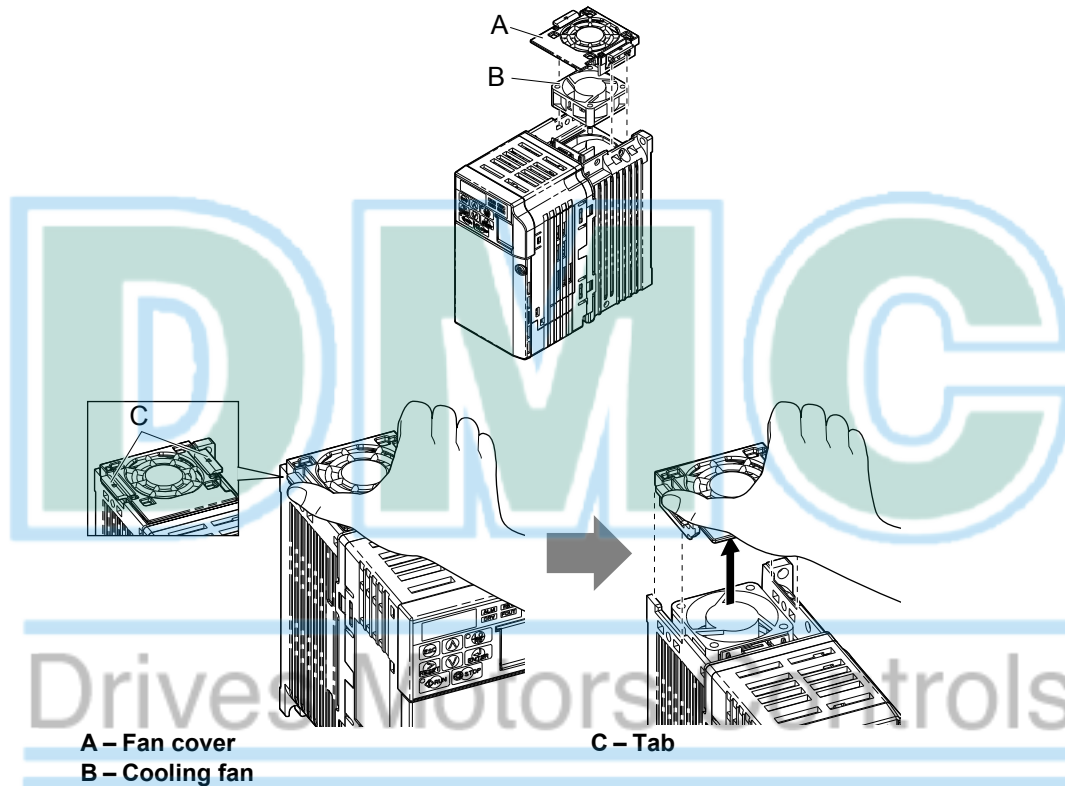

Figure 7.1 Remove the Cooling Fan Cover

2. Remove the fan cable carefully, disconnect the pluggable connector and remove the fan.

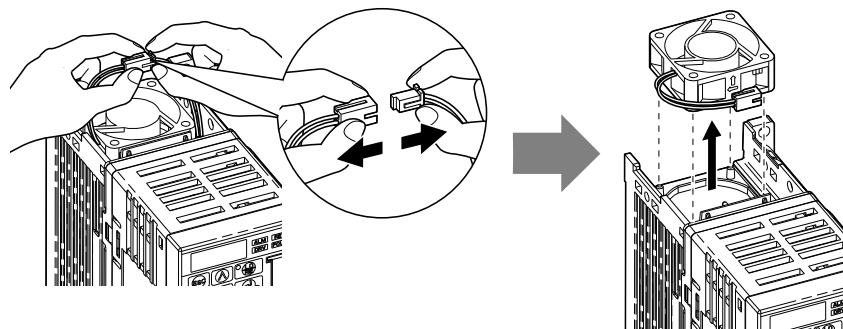

Figure 7.2 Disconnect and Remove the Fan

7.4 Drive Cooling Fans

■ Installing the Cooling Fan

NOTICE: Prevent Equipment Damage. Follow cooling fan replacement instructions. Improper cooling fan replacement could result in damage to equipment. When installing the replacement cooling fan into the drive, make sure the fan is facing upwards. To ensure maximum useful product life, replace all cooling fans when performing maintenance.

1. Install the replacement cooling fan into the drive, ensuring the alignment pins line up, as shown in the figure below:

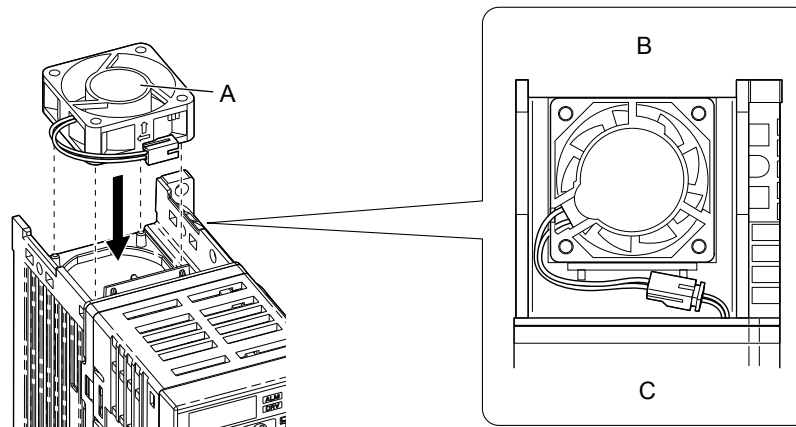

A – Label facing up
B – Back

C – Front

Figure 7.3 Cooling Fan Orientation

2. Ensure the connectors are properly connected and place the cable back into the recess of the drive.

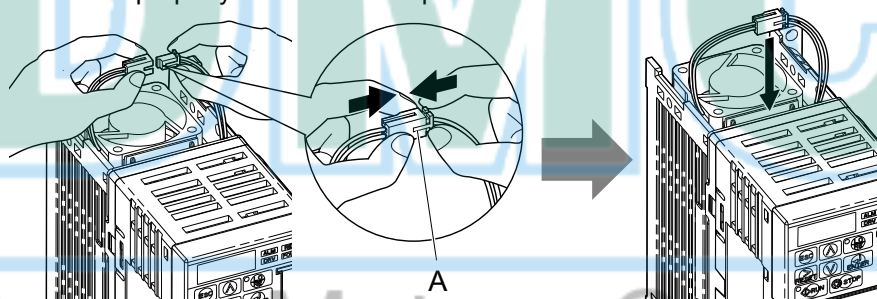

A – Push the connectors together so no space remains between them.

Figure 7.4 Connectors

Note: Ensure that the left and right tabs are locked back into place.

3. Align the left and right cover tabs to install the fan cover back on the top of the drive.

7.5 Drive Replacement

◆ Serviceable Parts

The drive contains few serviceable parts. The following parts are considered replacement parts on the drive:

- Main control board and I/O Terminal board I/O PCBs.
- Cooling fan(s)
- Front cover

Replace the drive if the main power circuitry is damaged. Contact your local Yaskawa representative before replacing parts if the drive is still under warranty. Yaskawa reserves the right to replace or repair the drive according to Yaskawa warranty policy.

WARNING! Electrical Shock Hazard. Do not connect or disconnect wiring while the power is on. Failure to comply can result in serious personal injury. Before servicing the drive, disconnect all power to the equipment. The internal capacitor remains charged even after the power supply is turned off. The charge indicator LED will extinguish when the DC bus voltage is below 50 Vdc. To prevent electric shock, wait at least five minutes after all indicators are OFF and measure the DC bus voltage level to confirm safe level.

◆ Terminal Board Overview

The drive has a modular I/O terminal block that facilitates quick drive replacement. The terminal board contains on-board memory that stores all drive parameter settings and allows the parameters to be saved and transferred to the replacement drive by disconnecting the terminal board from the damaged drive then reconnecting the terminal board to the replacement drive. There is no need to manually reprogram the replacement drive.

Note: When transferring the removable terminal block with backup memory to a drive with a different voltage class or different output capacity, set A1-03 to 2220 to initialize the drive after installing the terminal block.

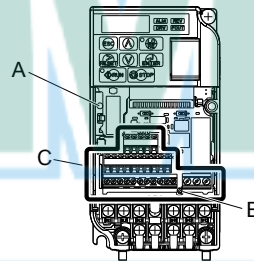

A – Charge LED

B – Terminal Board Locking Pin

C – Removable Terminal Board

Figure 7.5 Terminal Board

◆ Dismantling the Removable Terminal Block

WARNING! Electrical Shock Hazard. Never connect or disconnect wiring, remove connectors or option cards, or replace the cooling fan while the power is on. Failure to comply may result in serious injury. Before servicing, disconnect all power to the equipment. The internal capacitor remains charged even after the power supply is turned off.

WARNING! Electrical Shock Hazard. Do not allow unqualified personnel to perform work on the drive. Failure to comply could result in serious injury. Installation, maintenance, inspection and servicing must be performed only by authorized personnel familiar with installation, adjustment and maintenance of AC drives.

NOTICE: Damage to Equipment. Observe proper electrostatic discharge procedures (ESD) when handling the drive and circuit boards. Failure to comply may result in ESD damage to the drive circuitry.

1. Loosen the screw on the front of the drive and remove the front cover.

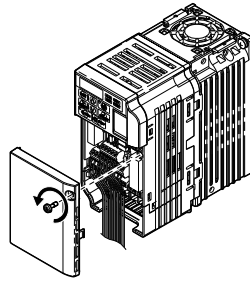

Figure 7.6 Remove the Front Cover

2. Pull the pin on the ground terminal out of the removable terminal block.

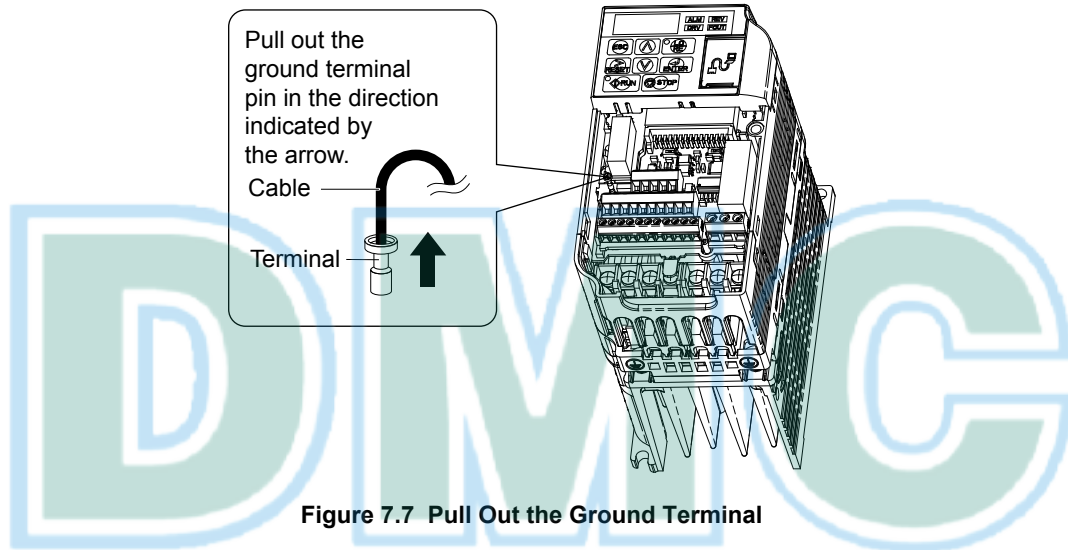

Figure 7.7 Pull Out the Ground Terminal

3. Push down the installation pin on the terminal board with a screwdriver

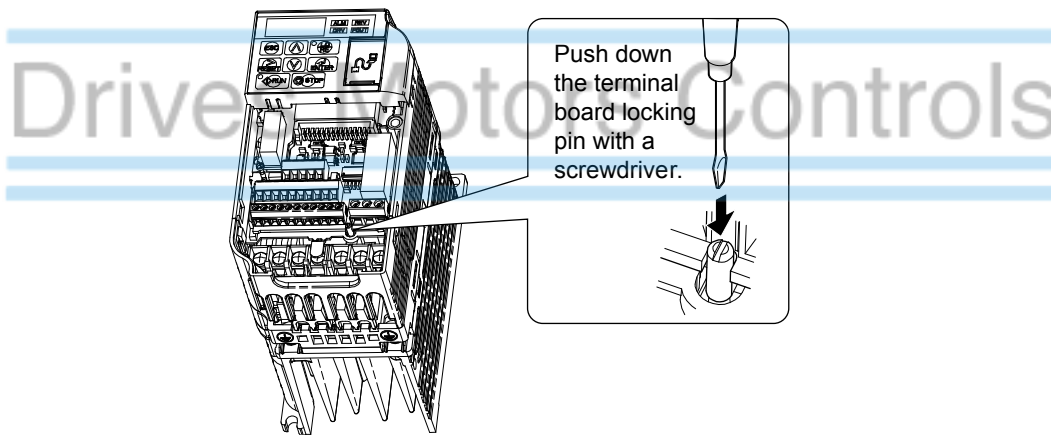

Figure 7.8 Depress the Plastic Tab

4. While holding down the locking pin from step 3, slide the removable terminal block in the direction of the arrows in [Figure 7.9](#).

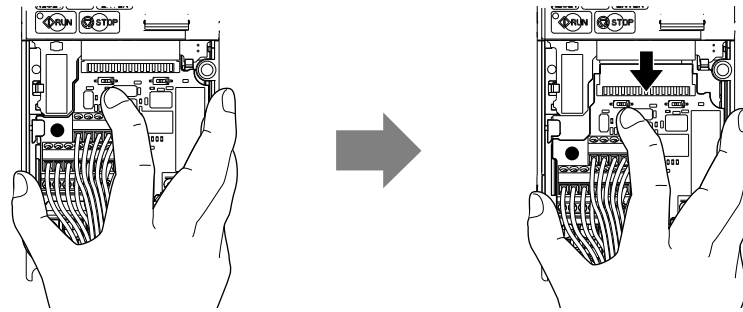

Figure 7.9 Remove the Terminal Board

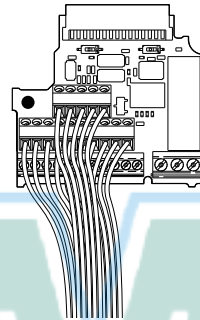

Figure 7.10 Removable Terminal Board Disconnected from the Drive

■ Reinstalling the Terminal Board

1. Reinstall the removable terminal block on the drive according to [Figure 7.11](#).

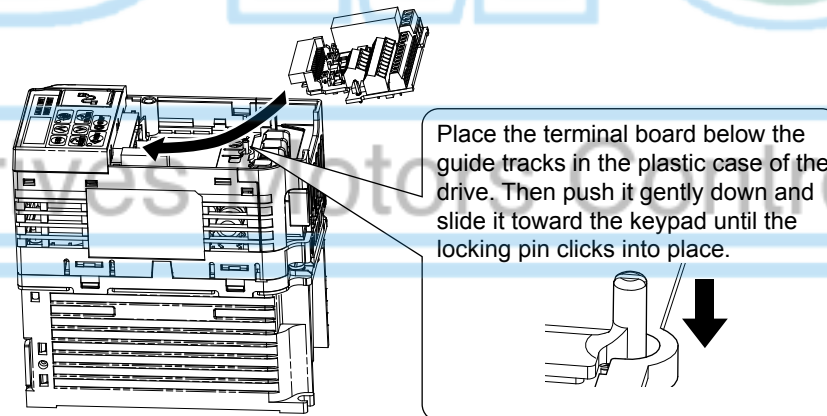

Figure 7.11 Terminal Board Reinstallation

2. Ensure the terminal block is firmly fastened to the connector.

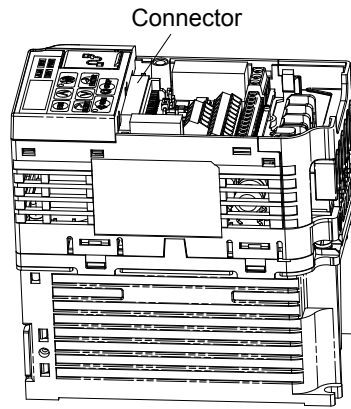

Figure 7.12 Terminal Board Reinstalled

3. Put the lower cover and the terminal cover back in place.
4. After replacing the drive, check the drive unit selection setting in o2-04. [Refer to Defaults by Drive Model and Duty Rating \(ND/HD\) on page 409](#) for more information.
5. An oPE04 error may occur when replacing the drive or the removable terminal block. If the data saved to the terminal block is compatible, set A1-03 to 5550 to write the parameter settings stored in the terminal block to the new drive. Reset the appropriate maintenance monitors using parameters o4-01 to o4-13.

◆ Details on Terminal Board (TB) or Control Board (CNT) Replacement

The drive Terminal Board retains drive parameter settings to significantly improve the ease of drive replacement. [Refer to Troubleshooting Terminal Board or Control Board Replacement on page 323](#) for a flowchart to assist in board replacement. When replacing the drive, or changing the Control Board or Terminal Board, the following error codes may be encountered upon application of power:

- oPE04 Drive parameter settings need to be initialized or uploaded from the TB.
- CPF06 Drive specification does not match the replaced drive.
- oPE01 Drive parameter o2-04 kVA requires setting.

Procedural Notes:

1. When replacing the drive, control board or terminal board, make sure to confirm the kVA setting, parameter o2-04 is correct upon initial power-up.
2. Perform an initialization (via parameter A1-03) to obtain the desired parameter settings.
3. In cases where a previously programmed terminal board is retained, initializing the drive with a setting of A1-03 = 5550 may be desired to program the drive with previously programmed settings (settings used prior to replacing the drive or control board).

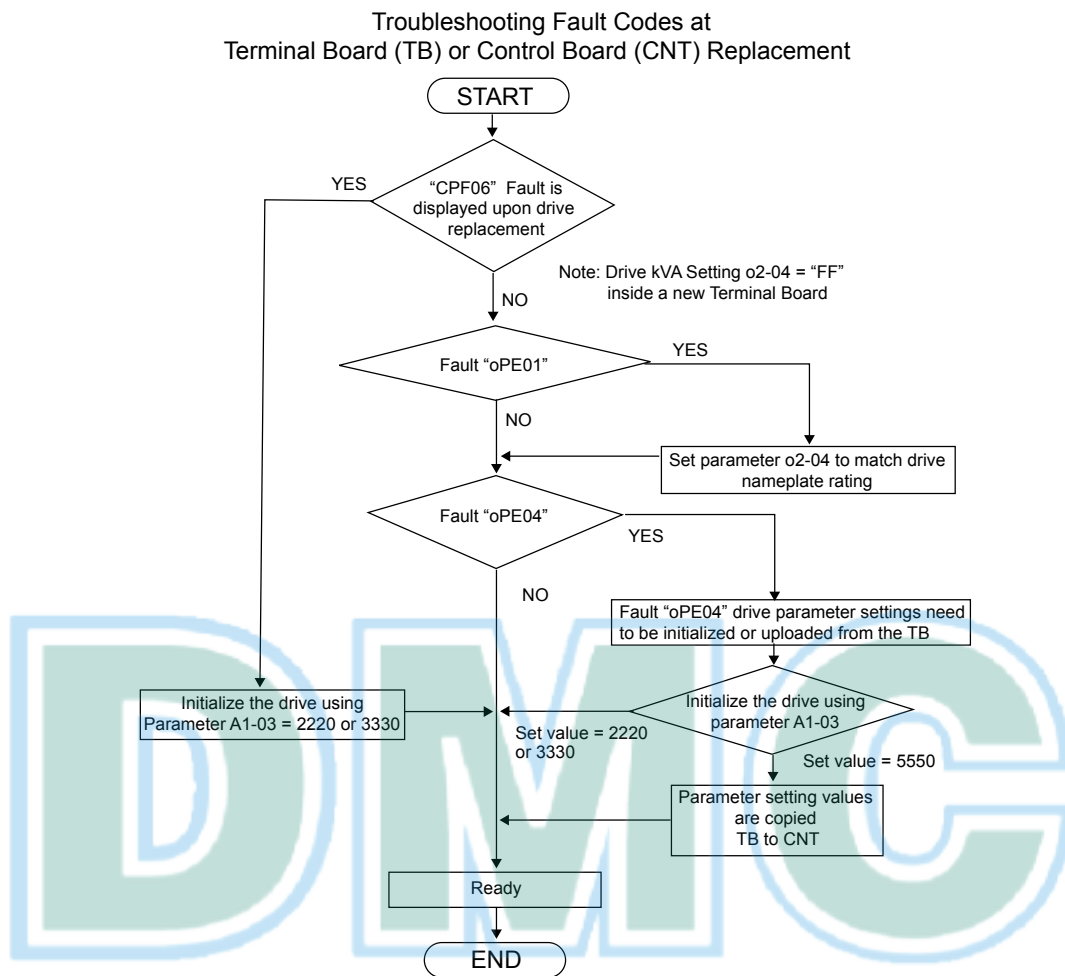

Figure 7.13 Troubleshooting Terminal Board or Control Board Replacement

Drives Motors Controls

This Page Intentionally Blank

The logo consists of the letters 'D', 'M', and 'C' in a large, bold, sans-serif font. Each letter is filled with a light teal color and has a thick, light blue outline. The letters are spaced out horizontally.

Drives Motors Controls

The slogan 'Drives Motors Controls' is written in a grey, sans-serif font. It is positioned below the 'DMC' logo and is framed by two horizontal light blue lines, one above and one below the text.

Peripheral Devices & Options

This chapter explains the installation of available peripheral devices and options for the drive.

8.1	SECTION SAFETY.....	326
8.2	DRIVE OPTIONS AND PERIPHERAL DEVICES.....	327
8.3	CONNECTING PERIPHERAL DEVICES.....	329
8.4	INSTALLING PERIPHERAL DEVICES.....	330
8.5	COMMUNICATION OPTIONS.....	337
8.6	CONNECTING AN OPTION CARD.....	338

Drives Motors Controls

8.1 Section Safety

DANGER

Electrical Shock Hazard

Do not connect or disconnect wiring while the power is on.

Failure to comply will result in death or serious injury.

Disconnect all power to the drive, wait at least five minutes after all indicators are off, measure the DC bus voltage to confirm safe level, and check for unsafe voltages before servicing to prevent electric shock. The internal capacitor remains charged even after the power supply is turned off. The charge indicator LED will extinguish when the DC bus voltage is below 50 Vdc.

WARNING

Electrical Shock Hazard

Do not operate equipment with covers removed.

Failure to comply could result in death or serious injury.

The diagrams in this section may show drives without covers or safety shields to show details. Be sure to reinstall covers or shields before operating the drives and run the drives according to the instructions described in this manual.

Do not remove covers or touch circuit boards while the power is on.

Failure to comply could result in death or serious injury.

Do not touch any terminals before the capacitors have fully discharged.

Failure to comply could result in death or serious injury.

Before wiring terminals, disconnect all power to the equipment. The internal capacitor remains charged even after the power supply is turned off. The charge indicator LED will extinguish when the DC bus voltage is below 50 Vdc. To prevent electric shock, wait at least five minutes after all indicators are off and measure the DC bus voltage level to confirm safe level.

Do not allow unqualified personnel to perform work on the drive.

Failure to comply could result in death or serious injury.

Installation, maintenance, inspection and servicing must be performed only by authorized personnel familiar with installation, adjustment and maintenance of AC drives.

Do not perform work on the drive while wearing loose clothing, jewelry or without eye protection.

Failure to comply could result in death or serious injury.

Remove all metal objects such as watches and rings, secure loose clothing and wear eye protection before beginning work on the drive.

Always ground the motor-side grounding terminal.

Improper equipment grounding could result in death or serious injury by contacting the motor case.

Do not change wiring or remove option unit while power is running through the drive.

Failure to comply could result in death or serious injury.

Disconnect all power to the drive and check for unsafe voltages before servicing.

Tighten all terminal screws to the specified tightening torque.

Loose electrical connections could result in death or serious injury by fire due to overheating of electrical connections.

NOTICE

Observe proper electrostatic discharge procedures (ESD) when handling the drive and circuit boards.

Failure to comply may result in ESD damage to the drive circuitry.

Never connect or disconnect the motor from the drive while the drive is outputting voltage.

Improper equipment sequencing could result in damage to the drive.

8.2 Drive Options and Peripheral Devices

The following table of peripheral devices lists the names of the various devices/options available for Yaskawa drives. Contact Yaskawa or your Yaskawa agent to order these peripheral devices.

- **Peripheral Device Selection:** Refer to Yaskawa catalog for selection and part numbers.
- **Peripheral Device Installation:** Refer to option manual for option installation instructions.

Table 8.1 Available Peripheral Devices

Option	Model Number	Description
Power Options		
DC Link Choke	UZDA Series	DC link choke to improve power factor
AC Reactor	UZBA Series	AC reactor to improve power factor
Braking Resistor	ERF-150WJ Series	3% ED, 150 W braking resistor
Braking Chopper	CDBR Series	External braking transistor
Surge Absorber	200 V class: DCR2-□A 400 V class: RFN3AL-504KD	Suppresses surge voltage caused by switching magnetic contactors
Molded Case Circuit Breaker	NF Series	Circuit breaker for short circuit or overload protection Note: Yaskawa recommends installing an MCCB to the power supply side to protect drive wiring and to prevent other damage in the event of component failure. Install an MCCB if permitted by the power system.
Ground Fault Circuit Interrupter (GFCI)	NV, EG, or SG Series	Provides protection against potentially harmful leakage currents Note: Yaskawa recommends installing a GFCI to the power supply side to protect drive wiring and to prevent other damage in the event of component failure. An MCCB can also be used if permitted by the power system.
Magnetic Contactor (Input)	SC Series	Prevents potential damage to the braking resistor and other internal circuitry by ensuring that power to drive is completely shut off when necessary. Install an MCCB when using a braking resistor to prevent the braking resistor from overheating. Wire the MC so that it opens when a fault output terminal is triggered to protect internal components from sudden high levels of input current.
Interface Options		
Remote LCD Operator	JVOP-180	Remote operator with 8 languages clear text LCD display and copy function; Cable length max. 3 m
USB/Copy Unit	JVOP-181	Allows the user to copy and verify parameter settings between drives. Can also be used as adapter to connect the drive to a PC USB port
Mechanical Options		
Heatsink External Mounting Attachment	EZZ020568□	Installation kit for mounting the drive with the heatsink outside of the panel (side-by-side mounting possible)
DIN Rail Attachment	EZZ08122□	Installation kit for mounting the drive on a DIN rail
NEMA Type 1 Kit </>	EZZ020564□	Parts to make the drive conform to NEMA Type 1 enclosure
Others		
24 Vdc Control Power Supply Option	PS-V10□	Provides power to the control circuit and option boards in the event of a power loss. Allows the user to monitor drive settings and fault information when the main circuit has no power.
Drive Wizard Plus	—	PC tool for drive setup and parameter management The installation files can be obtained at no charge from: http://www.yaskawa.com
DriveWorksEZ	—	PC tool for enhanced programming of the drive
Communication Options		
CANopen Communications Option	SI-S3/V	Connects to a CANopen network
CC-Link Communications Option	SI-C3/V	Connects to a CC-Link network

8.2 Drive Options and Peripheral Devices

Option	Model Number	Description
CompoNet Communications Option	SI-M3/V	Connects to a CompoNet network
DeviceNet Communications Option	SI-N3/V	Connects to a DeviceNet network
EtherCAT Communications Option	SI-ES3/V	Connects to an EtherCAT network
EtherNet/IP Communications Option	SI-EN3/V	Connects to an EtherNet/IP network
MECHATROLINK-II Communications Option	SI-T3/V	Connects to a MECHATROLINK-II network
MECHATROLINK-III Communications Option	SI-ET3/V	Connects to a MECHATROLINK-III network
Modbus TCP/IP Communications Option	SI-EM3/V	Connects to a Modbus/TCP network
PROFIBUS-DP Communications Option	SI-P3/V	Connects to a PROFIBUS-DP network
PROFINET Communications Option	SI-EP3/V	Connects to a PROFINET network

<1> Available for models: BA0001 to BA0018, 2A0001 to 2A0020, and 4A0001 to 4A0011.



8.3 Connecting Peripheral Devices

Figure 8.1 illustrates how the drive and motor connect together with various peripheral devices. Refer to peripheral device option manual for detailed installation instructions.

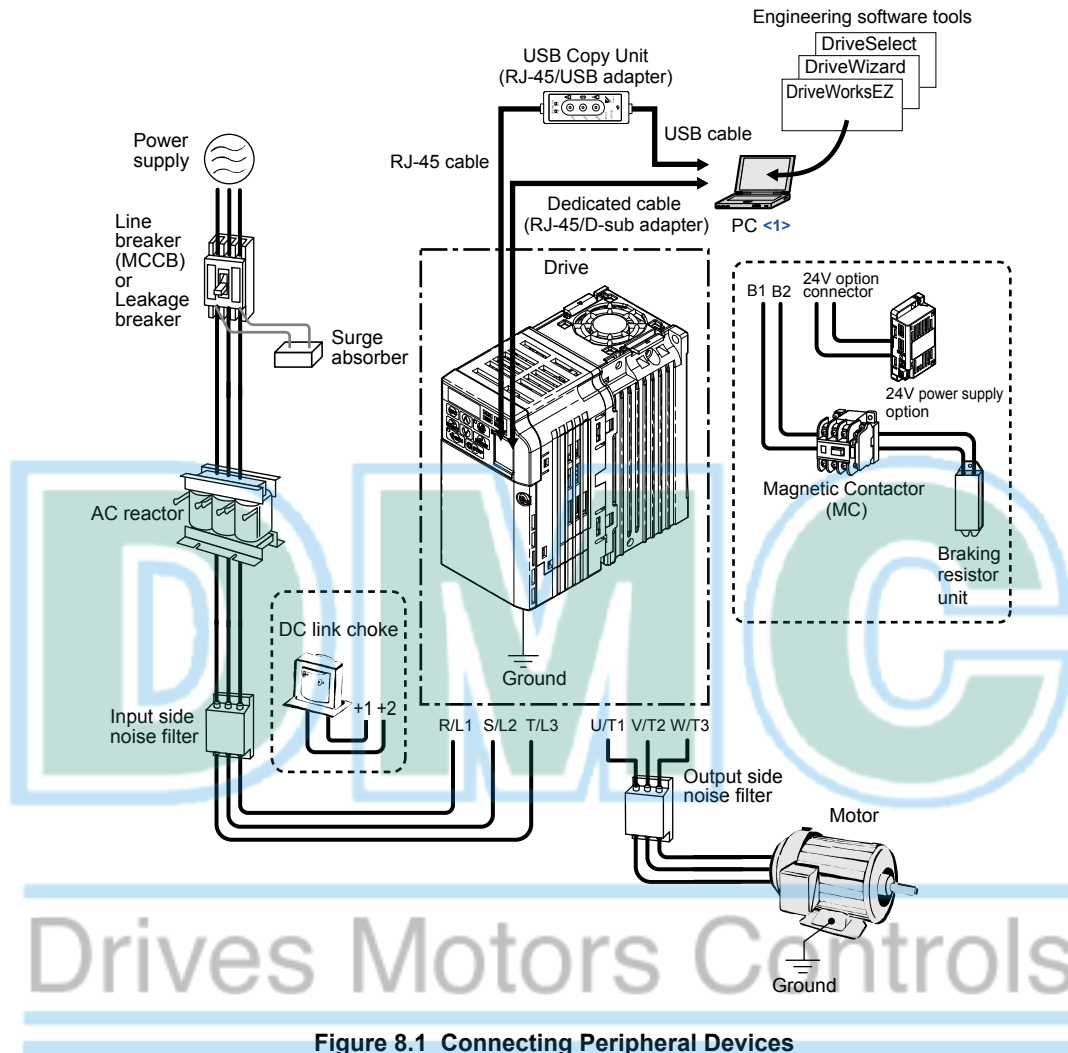

Figure 8.1 Connecting Peripheral Devices

<1> **NOTICE:** Do not connect the LAN port on a PC and the comm. port of the drive. Failure to comply may damage the drive and the PC.

Note: If the drive is set to trigger an output terminal when performing a fault restart (L5-02 = 1), the power supply will be shut off during fault restart as the drive outputs a fault signal. Keep this in mind when designing a wiring sequence to interrupt the power to the drive. The default setting for the drive is to not trigger an output terminal that indicates a fault restart is being performed (L5-02 = 0).

8.4 Installing Peripheral Devices

This section describes the proper steps and precautions to take when installing or connecting various peripheral devices to the drive.

Refer to peripheral device manual for detailed installation instructions.

NOTICE: Use a class 2 power supply (UL standard) when connecting to the control terminals. Improper application of peripheral devices could result in drive performance degradation due to improper power supply.

◆ Installing a Molded Case Circuit Breaker (MCCB) and Earth Leakage Circuit Breaker (ELCB)

Install an MCCB or ELCB for line protection between the power supply and the main circuit power supply input terminals R/L1, S/L2 and T/L3. This protects the main circuit and devices wired to the main circuit while also providing overload protection.

Consider the following when selecting and installing an MCCB or ELCB:

- The rated current of the MCCB or ELCB should be 1.5 to 2 times the rated output current of the drive. Use an MCCB or ELCB with operation characteristics that do not trip the MCCB or ELCB faster than the drive overload protection (shuts off the drive after 1 minute of operation at 150% of the drive rated current).
- If several drives are connected to one MCCB or an ELCB that is shared with other equipment, use a sequence that shuts the power OFF when errors are output by using magnetic contactor (MC) as shown in the following figure.

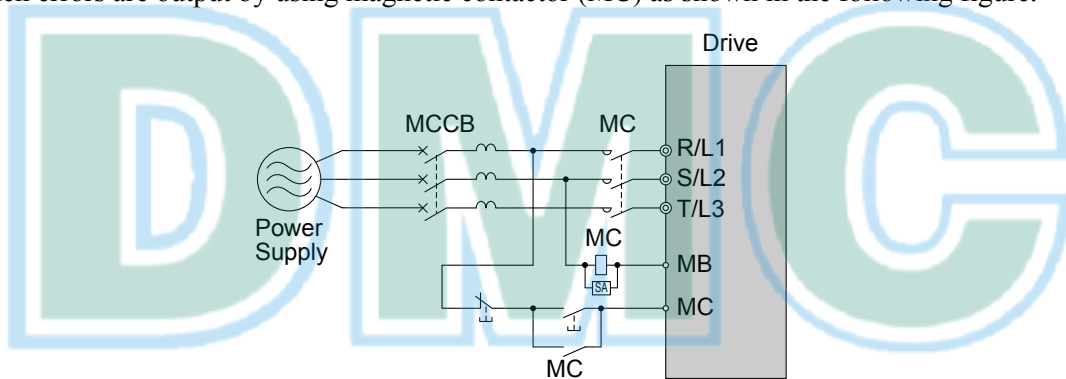

Figure 8.2 Connecting an MCCB

WARNING! Electrical Shock Hazard. Disconnect the MCCB (or ELCB) and MC before wiring terminals. Failure to comply may result in serious injury or death.

◆ Installing a Leakage Breaker

Drive outputs generate high-frequency leakage current as a result of high-speed switching. Install a GFCI on the input side of the drive to switch off potentially harmful leakage current.

Factors in determining leakage current:

- Size of the AC drive
- AC drive carrier frequency
- Motor cable type and length
- EMI/RFI filter

If the GFCI trips spuriously, consider changing these items or use a GFCI with a higher trip level.

Note: Choose a GFCI designed specifically for an AC drive. The operation time should be at least 0.1 s with sensitivity amperage of at least 200 mA per drive. The output waveform of the drive may cause an increase in leakage current. This may in turn cause the leakage breaker to malfunction. Increase the sensitivity amperage or lower the carrier frequency to correct the problem.

◆ Installing a Magnetic Contactor

■ Disconnecting the Power Supply

The drive should be shut off in the case of a fault in external equipment such as braking resistors through use of a Magnetic Contactor (MC).

NOTICE: Do not connect electromagnetic switches or MCs to the output motor circuits without proper sequencing. Improper sequencing of output motor circuits may cause damage to the drive.

NOTICE: Install an MC on the input side of the drive when the drive should not automatically restart after power loss. To get the full performance life out of the electrolytic capacitors and circuit relays, refrain from switching the MC more than once every 30 minutes. Frequent use can damage the drive. Use the drive to stop and start the motor.

- Note:**
1. Install an MC to the drive output to prevent the drive from restarting automatically when the power is restored after momentary power loss.
 2. Set up a delay for the MC so that it does not open prematurely for the drive to continue operating through momentary power loss.

■ Protecting the Braking Resistor or Braking Resistor Unit

Use an MC on the input side of the drive to protect a braking resistor or braking resistor unit from overheat or fire.

WARNING! Fire Hazard. When using a braking unit, use a thermal relay on the braking resistors and configure a fault contact output for the braking resistor unit to disconnect drive main power via an input contactor. Inadequate braking circuit protection could result in death or serious injury by fire from overheating resistors.

◆ Connecting an AC Reactor or DC Link Choke

AC reactors and DC link chokes suppress surges in current and improve the power factor on the input side of the drive.

Use an AC reactor, DC link choke, or both:

- To suppress harmonic current or improve the power factor of the power supply.
- When using a phase advancing capacitor switch.
- With a large capacity power supply transformer (over 600 kVA).

Note: Use an AC reactor or DC link choke when also connecting a thyristor converter (such as a DC drive) to the same power supply system, regardless of the conditions of the power supply.

■ Connecting an AC Reactor

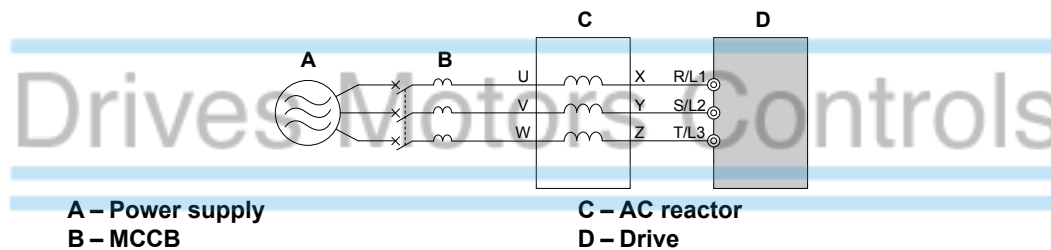

Figure 8.3 Connecting an AC Reactor

8.4 Installing Peripheral Devices

■ Connecting a DC Link Choke

Ensure the jumper between terminals +1 and +2 (terminals are jumpered for shipment) is removed when connecting a DC link choke. The jumper must be installed if no DC link choke is used. [Refer to Connecting a DC Link Choke on page 332](#) for an example of DC link choke wiring.

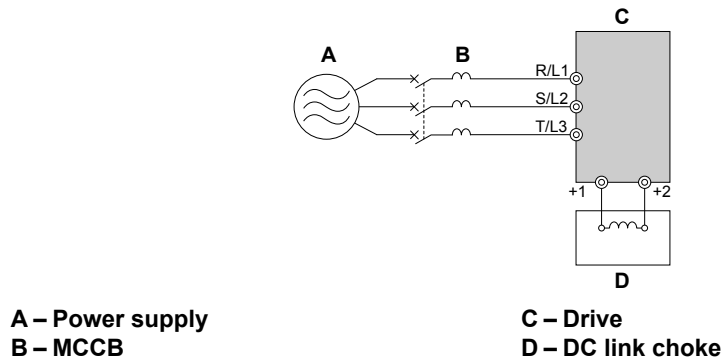

Figure 8.4 Connecting a DC Link Choke

◆ Connecting a Surge Suppressor

A surge suppressor suppresses transient voltages generated from switching an inductive load near the drive. Inductive loads include magnetic contactors, relays, valves, solenoids and brakes. Always use a surge suppressor or diode when operating with an inductive load.

Note: Never connect a surge suppressor to the drive output.

◆ Connecting a Noise Filter

■ Input-Side Noise Filter

Drive outputs generate noise as a result of high-speed switching. This noise flows from inside the drive back toward the power supply, possibly affecting other equipment. Installing a noise filter to the input side of the drive can reduce the amount of noise flowing back into the power supply. This also prevents noise from entering the drive from the power supply.

- Use a noise filter specifically designed for AC drives.
- Install the noise filter as close as possible to the drive.

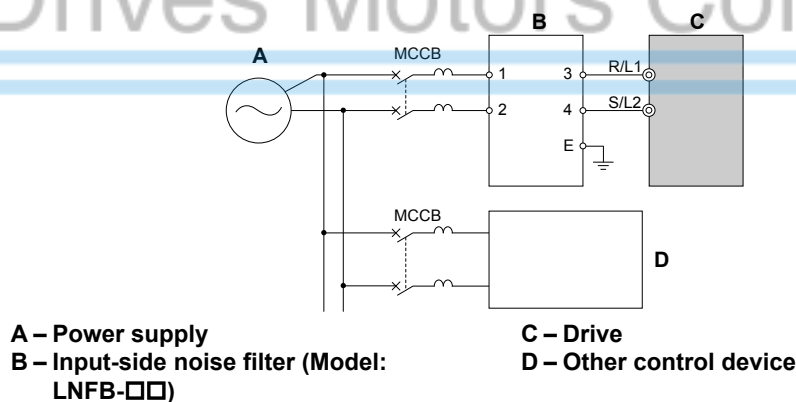

Figure 8.5 Input-Side Noise Filter (Single-Phase 200 V)

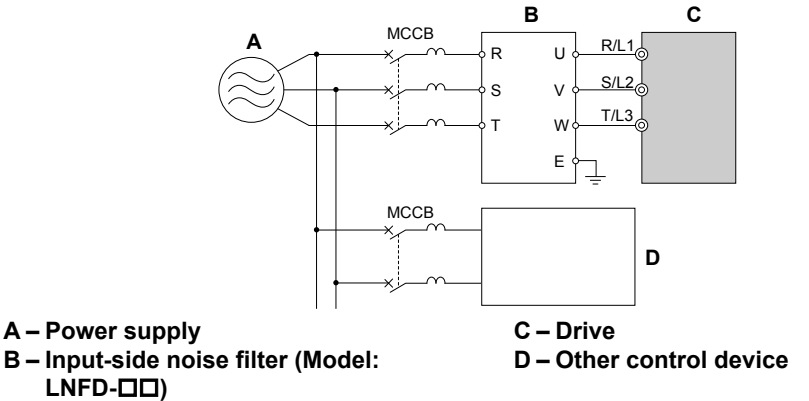

Figure 8.6 Input-Side Noise Filter (Three-Phase 200/400 V)

Refer to *EMC Filter Installation on page 469* for details about EMC filter selection and installation in order to make the drive compliant with European standards EN 61800-3:2004/A1:2012 and the EMC guidelines.

Output-Side Noise Filter

A noise filter on the output side of the drive reduces inductive noise and radiated noise. *Figure 8.7* illustrates an example of output-side noise filter wiring.

NOTICE: Do not connect phase-advancing capacitors or LC/RC noise filters to the output circuits. Improper application of noise filters could result in damage to the drive.

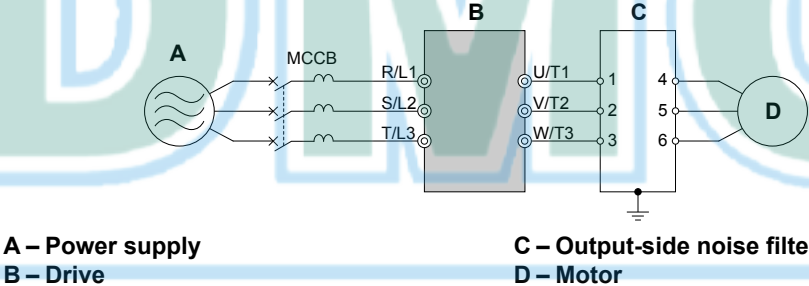

Figure 8.7 Output-Side Noise Filter

- **Radiated Noise:** Electromagnetic waves radiated from the drive and cables create noise throughout the radio bandwidth that can affect devices.
- **Induced Noise:** Noise generated by electromagnetic induction can affect the signal line and may cause the controller to malfunction.

Preventing Induced Noise

Use a noise filter on the output side or use shielded cables. Lay the cables at least 30 cm away from the signal line to prevent induced noise.

8.4 Installing Peripheral Devices

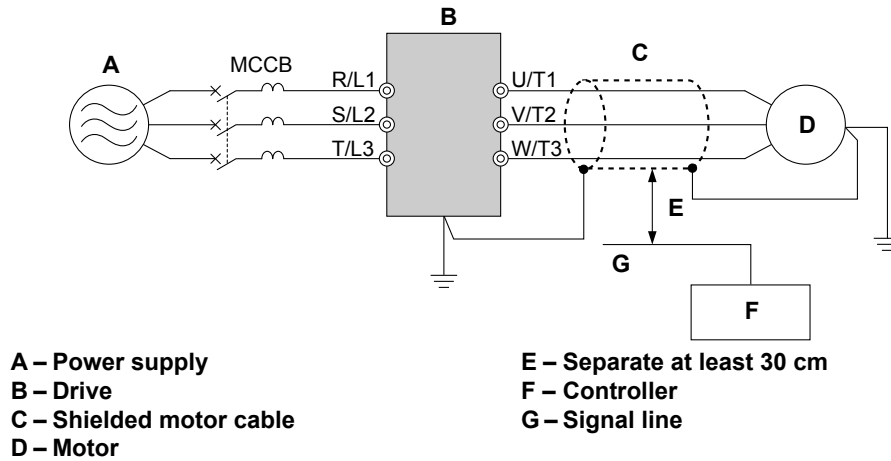

Figure 8.8 Preventing Induced Noise

Reducing Radiated/Radio Frequency Noise

The drive, input lines, and output lines generate radio frequency noise. Use noise filters on input and output sides and install the drive in a metal enclosure panel to reduce radio frequency noise.

Note: The cable running between the drive and motor should be as short as possible.

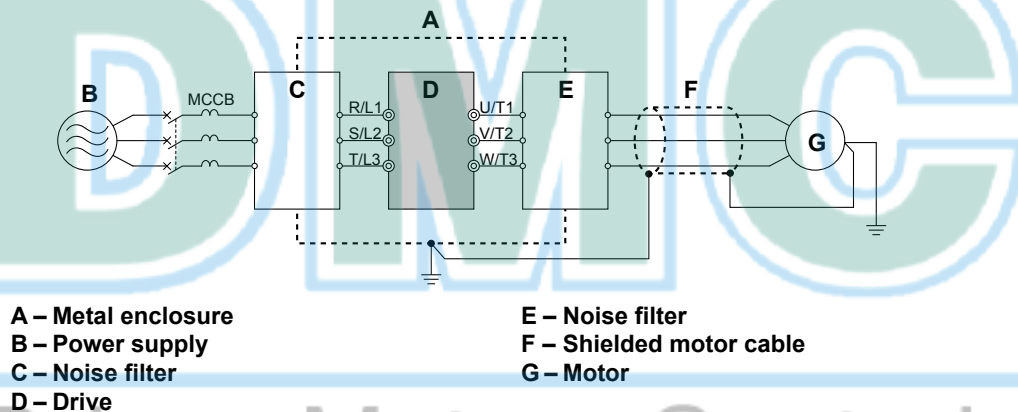

Figure 8.9 Reducing Radio Frequency Noise

◆ EMC Filter Installation

This drive is tested according to European standards IEC/EN 61800-5-1 and it complies with the EMC guidelines. [Refer to EMC Filter Installation on page 469](#) for details about EMC filter selection and installation.

◆ Zero-Phase Reactor

A zero-phase reactor can be used to reduce the noise on the input and output sides of the drive.

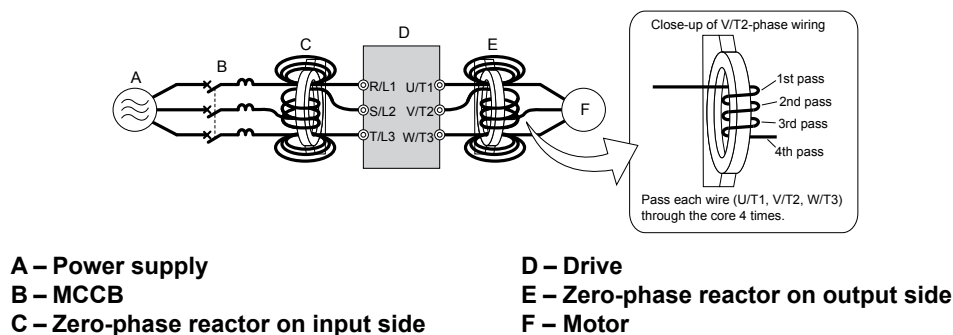

Figure 8.10 Zero-Phase Reactor

◆ Installing Fuses on the Input Side

Always install input fuses to the input side of the as a protective measure against damage caused by a short circuit.

Refer to Standards Compliance on page 463 for details on input fuse selection.

◆ Attachment for External Heatsink

An external attachment can be used to project the heatsink outside of an enclosure to ensure that there is sufficient air circulation around the heatsink. This installation method still requires a certain amount of airflow over the drive case. *Refer to Output Current Derating Due to Ambient Temperature on page 351* if derating is required. Contact a Yaskawa sales representative for more information.

◆ Noise Filter Installation

This drive has undergone testing in conformance with IEC/EN 61800-5-1 and is in compliance with low voltage directives.

Refer to EMC Guidelines Compliance on page 469 for information on selecting a noise filter.

◆ Installing a Motor Thermal Overload (oL) Relay on the Drive Output

Motor thermal overload relays protect the motor by disconnecting power lines to the motor due to a motor overload condition.

Install a motor thermal overload relay between the drive and motor:

- When operating multiple motors on a single AC drive.
- When using a power line bypass to operate the motor directly from the power line.

It is not necessary to install a motor thermal overload relay when operating a single motor from a single AC drive. The AC drive has UL recognized electronic motor overload protection built into the drive software.

Note: Disable the motor protection function (L1-0 1 = "0") when using an external motor thermal overload relay. The relay should shut off main power on the input side of the main circuit when triggered.

■ General Precautions when Using Thermal Overload Relays

The following application precautions should be considered when using motor thermal overload relays on the output of AC drives in order to prevent nuisance trips or overheat of the motor at low speeds:

- Low speed motor operation
- Use of multiple motors on a single AC drive
- Motor cable length
- Nuisance tripping resulting from high AC drive carrier frequency

Low Speed Operation and Motor Thermal oL Relays

Generally, thermal relays are applied on general-purpose motors. When general-purpose motors are driven by AC drives, the motor current is approximately 5 to 10% greater than if driven by the commercial power supply. In addition, the cooling capacity of a motor with a shaft-driven fan decreases when operating at low speeds. Even if the load current is within the motor rated value, motor overheating may occur. A thermal relay cannot effectively protect the motor due to the reduction of cooling at low speeds. For this reason, apply the UL recognized electronic thermal overload protection function built into the drive whenever possible.

UL recognized electronic thermal overload function of the drive: Speed-dependent heat characteristics are simulated using data from standard motors and force-ventilated motors. The motor is protected from overload using this function.

Using One Drive with Multiple Motors

Turn off the electronic thermal overload function. Please refer to the appropriate product instruction manual to determine which parameter disables this function.

The UL recognized electronic thermal overload function of the drive cannot be applied when using multiple motors on one drive.

Long Motor Cables

When long motor cables and high carrier frequency are used, nuisance tripping of the thermal relay may occur due to increased leakage current. Therefore, reduce the carrier frequency or increase the tripping level of the thermal overload relay.

Nuisance Tripping Resulting from High AC Drive Carrier Frequency

Current waveforms generated by high carrier frequency PWM drives tend to create additional temperature rise in overload relays. Therefore, it may be necessary to increase the trip level setting when encountering nuisance triggering of the relay.

8.4 Installing Peripheral Devices

WARNING! *Fire Hazard. Confirm an actual motor overload condition is not present prior to increasing the thermal oL trip setting. Check local electrical codes before making adjustments to motor thermal overload settings.*



8.5 Communication Options

Table 8.2 gives detailed information about the available options that allow Yaskawa drives to connect to communication networks. A host controller can control and monitor the drive, read and change parameters by using a communication option. Contact Yaskawa or your Yaskawa agent to order options.

- **Option Selection:** Refer to Yaskawa catalog for more details on option selection and part numbers.
- **Option Installation:** Refer to option manual for option installation instructions.

Table 8.2 Available Communication Options

Option	Model	Function
PROFIBUS-DP Communications Option	SI-P3/V	Connects to a PROFIBUS-DP network
CC-Link Communications Option	SI-C3/V	Connects to a CC-Link network
DeviceNet Communications Option	SI-N3/V	Connects to a DeviceNet network
CompoNet Communications Option	SI-M3/V	Connects to a CompoNet network
CANopen Communications Option	SI-S3/V	Connects to a CANopen network
EtherNet/IP Communications Option	SI-EN3/V	Connects to an EtherNet/IP network
MECHATROLINK-II Communications Option	SI-T3/V	Connects to a MECHATROLINK-II network
MECHATROLINK-III Communications Option	SI-ET3/V	Connects to a MECHATROLINK-III network
EtherCAT Communications Option	SI-ES3/V	Connects to an EtherCAT network
PROFINET Communications Option	SI-EP3/V	Connects to a PROFINET network
Modbus TCP/IP Communications Option	SI-EM3/V	Connects to a Modbus TCP network

Drives Motors Controls

8.6 Connecting an Option Card

The drive can communicate with other devices through a specially designed option card. The following section describes how to install an option card.

Refer to option card manual for detailed installation instructions.

Note: Refer to *Available Communication Options on page 337* for a list of option cards for use with this product.

◆ Verifying the Option Card and Product Type

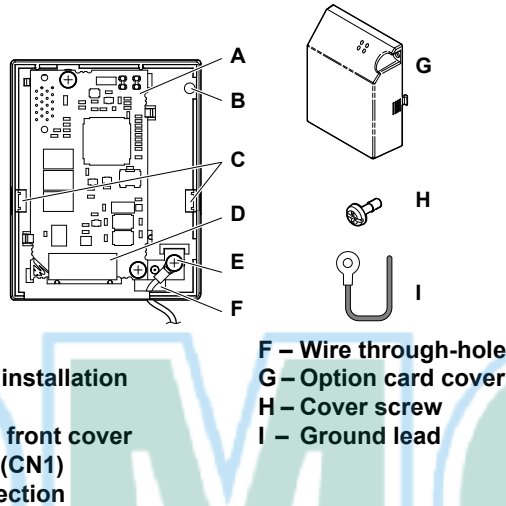

- A – Option card
- B – Option card cover installation screw holes
- C – Tabs for mounting front cover
- D – Comm. connector (CN1)
- E – Ground lead connection
- F – Wire through-hole
- G – Option card cover
- H – Cover screw
- I – Ground lead

Figure 8.11 Option Card

◆ Connecting the Option Card

1. Loosen the screw on the front cover of the drive to remove the cover.

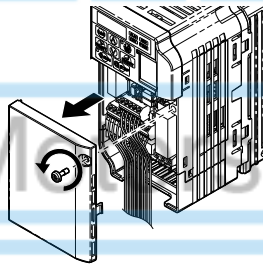
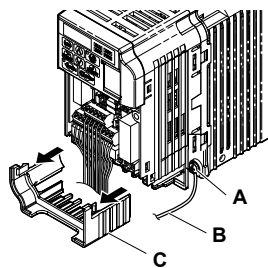

Figure 8.12 Remove Cover

2. Remove the terminal cover. Connect the lead from the option card to the drive ground terminal.



- A – Ground terminal
- B – Ground lead
- C – Terminal cover

Figure 8.13 Connect Lead

3. Reattach the terminal cover.

4. Attach the option card to the drive.

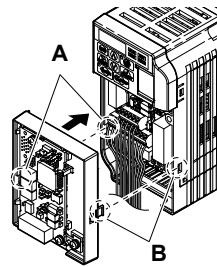

A – Line up the tab with the mounting hole.

B – Line up the tab with the mounting hole.

Figure 8.14 Attach Option Card

Note: Gently pack wires to fit behind the left and right side of the cover into the provided recess.

5. Connect the lead from the drive ground terminal to the same terminal as the option card lead.

The option card lead should exit through the holes provided on the underside of the drive as it gets routed passed the ground terminal.

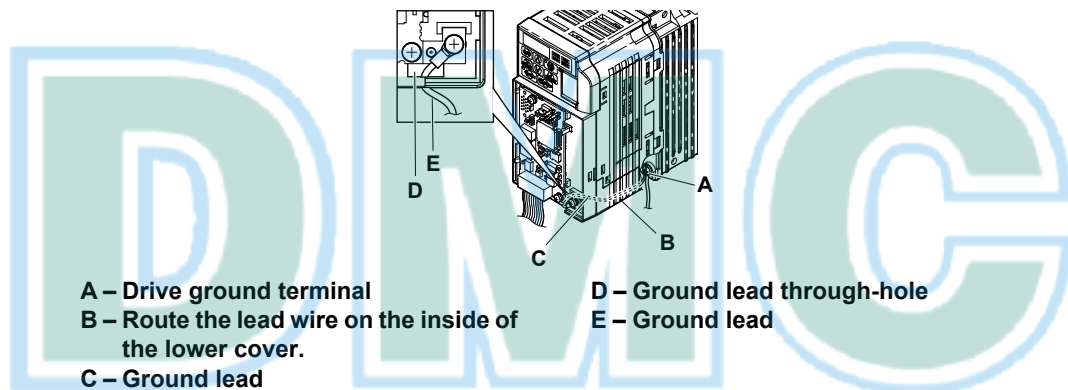

A – Drive ground terminal

B – Route the lead wire on the inside of the lower cover.

C – Ground lead

D – Ground lead through-hole

E – Ground lead

Figure 8.15 Lead Wire Connection

6. Reattach the option card cover.

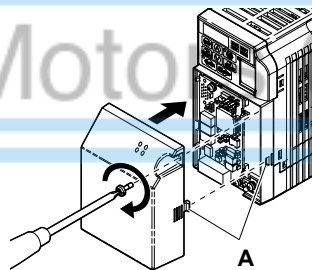

A –Align the tab with the mounting hole.

Figure 8.16 Reattach Cover

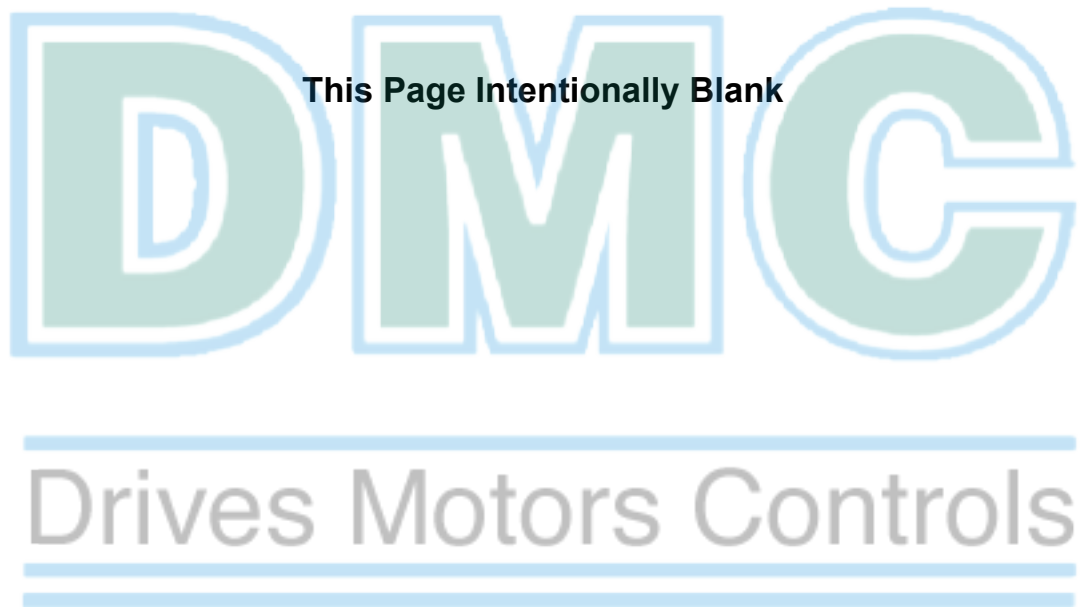

Appendix: A

Specifications

A.1	HEAVY DUTY AND NORMAL DUTY RATINGS.....	342
A.2	SINGLE/THREE-PHASE 200 V CLASS DRIVES.....	343
A.3	THREE-PHASE 400 V CLASS DRIVES.....	345
A.4	DRIVE SPECIFICATIONS.....	347
A.5	DRIVE WATT LOSS DATA.....	350
A.6	DRIVE DERATING DATA.....	351

DMC

Drives Motors Controls

A.1 Heavy Duty and Normal Duty Ratings

The capacity of the drive is based on two types of load characteristics: Heavy Duty (HD) and Normal Duty (ND).

Refer to [Selecting the Appropriate Load Rating on page 342](#) for the differences between HD and ND. Specifications for capacity ratings are listed on the following pages.

Table A.1 Selecting the Appropriate Load Rating

Setting Parameter C6-01	Rated Output Current	Overload Tolerance	Default Carrier Frequency
0: Heavy Duty	HD Rating varies by model </>	150% rated output current for 60 s	8/10 kHz varies by model
1: Normal Duty (default)	ND Rating varies by model </>	120% rated output current for 60 s varies by model	2 kHz, Swing PWM

<1> The following pages list information on rating changes based on drive model.



- **HD and ND:** HD refers to applications requiring constant torque output, while ND refers to applications with variable torque needs. The drive allows the user to select HD or ND torque depending on the application. Fans, pumps, and blowers should use ND (C6-01 = 1), and other applications generally use HD (C6-01 = 0).
- **Swing PWM:** Swing PWM equivalent to a 2 kHz audible noise. This function turns the motor noise into a less obtrusive white noise.

Note: Differences between HD ratings and ND ratings for the drive include rated input and output current, overload capacity, carrier frequency, and current limit. The default setting is for ND (C6-01 = 1).

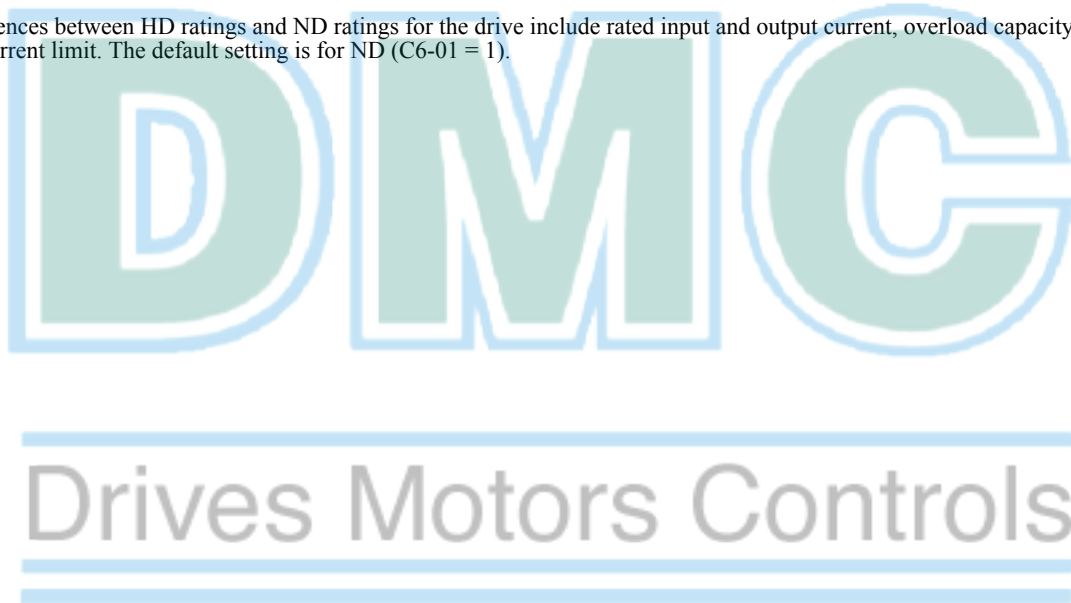

A.2 Single/Three-Phase 200 V Class Drives

Note: Differences between Heavy Duty (HD) ratings and Normal Duty (ND) ratings for the drive include rated input and output current, overload capacity, carrier frequency and current limit. Set parameter C6-01 to 0 for HD or 1 for ND (default).

Table A.2 Power Ratings

Item			Specification							
Three-Phase Drive Model			2A0001	2A0002	2A0004	2A0006	2A0010	2A0012	2A0020	
Single-Phase Drive Model <1>			BA0001	BA0002	BA0003	BA0006	BA0010	BA0012	BA0018	
Maximum Motor Size Allowed (HP) <2>		ND Rating	0.13	0.25	0.5/ 0.75	1.0/ 1.5	2.0/ 3.0	3.0	5.0 <2>	
		HD Rating	0.13	0.25	0.5	0.75/ 1.0	1.5/ 2.0	3.0	5.0	
Input	Input Current (A) <4>	Three-phase	ND Rating	1.1	1.9	3.9	7.3	10.8	13.9	24.0 <2>
			HD Rating	0.7	1.5	2.9	5.8	7.5	11.0	18.9
		Single-phase	ND Rating	2.0	3.6	7.3	13.8	20.2	24.0	–
			HD Rating	1.4	2.8	5.5	11.0	14.1	20.6	35.0
Output	Rated Output Capacity (kVA) <5>		ND Rating	0.5	0.7	1.3	2.3	3.7	4.6	7.5 <2>
			HD Rating	0.3	0.6	1.1	1.9	3.0	4.2	6.7
	Output Current (A)		ND Rating <6>	1.2	1.9	3.5 (3.3)	6.0	9.6	12.0	19.6 <2>
			HD Rating	0.8 <7>	1.6 <7>	3.0 <7>	5.0 <7>	8.0 <8>	11.0 <8>	17.5 <8>
	Overload Tolerance		ND Rating: 120% of rated output current for 1 minute HD Rating: 150% of rated output current for 1 minute (Derating may be required for applications that start and stop frequently)							
	Carrier Frequency		User-adjustable 2 to 15 kHz							
	Max Output Voltage (V)		Three-phase power: 200 to 240 V Single-phase power: 200 to 240 V (both proportional to input voltage)							
	Max Output Frequency (Hz)		400 Hz (user-adjustable)							
	Rated Voltage Rated Frequency		Three-phase power: 200 to 240 V 50/60 Hz Single-phase power: 200 to 240 V 50/60 Hz DC power supply: 270 to 340 V <9>							
	Allowable Voltage Fluctuation		-15 to 10%							
Allowable Frequency Fluctuation		±5%								
Harmonic Corrective Actions		DC Link Choke		Optional						

- <1> Drives with single-phase power supply input will output three-phase power and cannot run a single-phase motor.
- <2> 2A0020 only. BA0018 is available with a Heavy Duty rating only.
- <3> The motor capacity (HP) refers to a NEC rated 4-pole motor. The rated output current of the drive output amps should be equal to or greater than the motor rated current.
- <4> Input current rating varies depending on the power supply transformer, input reactor, wiring connections, and power supply impedance.
- <5> Rated motor capacity is calculated with a rated output voltage of 230 V.
- <6> Carrier frequency is set to 2 kHz (Swing PWM). Current derating is required in order to raise the carrier frequency.
- <7> Carrier frequency is set to 10 kHz. Current derating is required in order to raise the carrier frequency.
- <8> Carrier frequency is set to 8 kHz. Current derating is required in order to raise the carrier frequency.
- <9> DC is not available for UL standards.

A.2 Single/Three-Phase 200 V Class Drives

Table A.3 Power Ratings Continued

Item			Specification				
Three-Phase Model			2A0030	2A0040	2A0056	2A0069	
Single-Phase Model <1>			-	-	-	-	
Maximum Motor Size Allowed (HP) <2>			ND Rating	7.5/10.0	10.0	20.0	25.0
			HD Rating	7.5	10.0	15.0	20.0
Input	Input Current (A) <3>	Three-Phase	ND Rating	37.0	52.0	68.0	80.0
			HD Rating	24.0	37.0	52.0	68.0
		Single-Phase	ND Rating	-	-	-	-
			HD Rating	-	-	-	-
Output	Rated Output Capacity (kVA) <4>		ND Rating	11.4	15.2	21.3	26.3
			HD Rating	9.5	12.6	17.9	22.9
	Output Current (A)		ND Rating <5>	30.0	40.0	56.0	69.0
			HD Rating	25.0 <6>	33.0 <6>	47.0 <6>	60.0 <6>
	Overload Tolerance			ND Rating: 120% of rated output current for 1 minute HD Rating: 150% of rated output current for 1 minute (Derating may be required for applications that start and stop frequently)			
	Carrier Frequency			User-adjustable 2 to 15 kHz			
	Max Output Voltage (V)			Three-phase power: 200 to 240 V Single-phase power: 200 to 240 V (both proportional to input voltage)			
	Max Output Frequency (Hz)			400 Hz (user-adjustable)			
Power Supply	Rated Voltage Rated Frequency		Three-phase power: 200 to 240 V 50/60 Hz Single-phase power: 200 to 240 V 50/60 Hz DC power supply: 270 to 340 V <7>				
	Allowable Voltage Fluctuation		-15 to 10%				
	Allowable Frequency Fluctuation		±5%				
Harmonic Corrective Actions		DC Link Choke	Optional				

- <1> Drives with single-phase power supply input will output three-phase power and cannot run a single-phase motor.
- <2> The motor capacity (HP) refers to a NEC rated 4-pole motor. The rated output current of the drive output amps should be equal to or greater than the motor rated current.
- <3> Input current rating varies depending on the power supply transformer, input reactor, wiring connections, and power supply impedance.
- <4> Rated motor capacity is calculated with a rated output voltage of 220 V.
- <5> Carrier frequency is set to 2 kHz (Swing PWM). Current derating is required in order to raise the carrier frequency.
- <6> Carrier frequency is set to 8 kHz. Current derating is required in order to raise the carrier frequency.
- <7> DC is not available for UL standards.

A.3 Three-Phase 400 V Class Drives

Note: Differences between Heavy Duty (HD) ratings and Normal Duty (ND) ratings for the drive include rated input and output current, overload capacity, carrier frequency and current limit. Set parameter C6-01 to 0 for HD or 1 for ND (default).

Table A.4 Power Ratings

Item		Specification						
Three-Phase Model		4A0001	4A0002	4A0004	4A0005	4A0007	4A0009	
Maximum Applicable Motor Capacity (HP) <1>	ND Rating	0.5	0.75/1.0	1.5/2.0	3.0	3.0	5.0	
	HD Rating	0.5	0.75	1.0/1.5/2.0	3.0	3.0	3.0	
Input	Input Current (A) <2>	ND Rating	1.2	2.1	4.3	5.9	8.1	9.4
		HD Rating	1.2	1.8	3.2	4.4	6.0	8.2
Output	Output Current (kVA) <3>	ND Rating <4>	0.9	1.6	3.1	4.1	5.3	6.7
		HD Rating <5>	0.9	1.4	2.6	3.7	4.2	5.5
	Output Current (A)	ND Rating <4>	1.2	2.1	4.1	5.4	6.9	8.8
		HD Rating <5>	1.2	1.8	3.4	4.8	5.5	7.2
	Overload Tolerance		ND Rating: 120% of rated output current for 60 s HD Rating: 150% of rated output current for 60 s (Derating may be required for applications that start and stop frequently)					
	Carrier Frequency		User-adjustable 2 to 15 kHz					
Max Output Voltage (V)		Three-phase power: 380 to 480 V (proportional to input voltage)						
Max Output Frequency (Hz)		400 Hz (user-adjustable)						
Power Supply	Rated Voltage Rated Frequency		Three-phase power: 380 to 480 V 50/60 Hz DC power supply: 510 to 680 V <6>					
	Allowable Voltage Fluctuation		-15 to 10%					
	Allowable Frequency Fluctuation		±5%					
Harmonic Corrective Actions		DC Link Choke		Optional				

- <1> The motor capacity (HP) refers to a NEC 4-pole motor. The rated output current of the drive output amps should be equal to or greater than the motor rated current.
- <2> Input current rating varies depending on the power supply transformer, input reactor, wiring conditions, and power supply impedance.
- <3> Rated motor capacity is calculated with a rated output voltage of 460 V.
- <4> Carrier frequency is set to 2 kHz (Swing PWM). Current derating is required to raise the carrier frequency.
- <5> Carrier frequency is set to 8 kHz. Current derating is required to raise the carrier frequency.
- <6> DC is not available for UL standards.

A.3 Three-Phase 400 V Class Drives

Table A.5 Power Ratings Continued

Item		Specification					
Three-Phase Model		4A0011	4A0018	4A0023	4A0031	4A0038	
Maximum Applicable Motor Capacity (HP) <1>	ND Rating	7.5	10.0	15.0	20.0	25.0	
	HD Rating	5.0	10.0	10.0	15.0	20.0	
Input	Input Current (A) <2>	ND Rating	14.0	20.0	24.0	38.0	44.0
		HD Rating	10.4	15.0	20.0	29.0	39.0
Output	Output Current (kVA) <3>	ND Rating <4>	8.5	13.3	17.5	23.6	29.0
		HD Rating <5>	7.0	11.3	13.7	18.3	23.6
	Output Current (A)	ND Rating <4>	11.1	17.5	23.0	31.0	38.0
		HD Rating <5>	9.2	14.8	18.0	24.0	31.0
	Overload Tolerance		ND Rating: 120% of rated output current for 60 s HD Rating: 150% of rated output current for 60 s (Derating may be required for applications that start and stop frequently)				
	Carrier Frequency		User-adjustable 2 to 15 kHz				
	Max Output Voltage (V)		Three-phase power: 380 to 480 V (proportional to input voltage)				
	Max Output Frequency (Hz)		400 Hz (user-adjustable)				
Power Supply	Rated Voltage Rated Frequency		Three-phase power: 380 to 480 V 50/60 Hz DC power supply: 510 to 680 V <6>				
	Allowable Voltage Fluctuation		-15 to 10%				
	Allowable Frequency Fluctuation		±5%				
Harmonic Corrective Actions		DC Link Choke		Optional			

- <1> The motor capacity (HP) refers to a NEC 4-pole motor. The rated output current of the drive output amps should be equal to or greater than the motor rated current.
- <2> Input current rating varies depending on the power supply transformer, input reactor, wiring conditions, and power supply impedance.
- <3> Rated motor capacity is calculated with a rated output voltage of 440 V.
- <4> Carrier frequency is set to 2 kHz (Swing PWM). Current derating is required to raise the carrier frequency.
- <5> Carrier frequency is set to 8 kHz. Current derating is required to raise the carrier frequency.
- <6> DC is not available for UL standards.

Drives Motors Controls

A.4 Drive Specifications

- Note:**
1. Perform rotational Auto-Tuning to obtain OLV performance specifications.
 2. For optimum performance life of the drive, install the drive in an environment that meets the environmental conditions.

Item		Specification
Control Characteristics	Control Method	The following control methods are available: Open Loop Vector Control (current vector), V/f Control, and PM Open Loop Vector (for use with SPM and IPM)
	Frequency Control Range	0.01 to 400 Hz
	Frequency Accuracy	Digital input: within ±0.01% of the max output frequency (-10 to +50 °C) Analog input: within ±0.5% of the max output frequency (25 °C ±10 °C)
	Frequency Setting Resolution	Digital inputs: 0.01 Hz Analog inputs: 1/1000 of maximum output frequency
	Output Frequency Calculation Resolution	1/2 ²⁰ x Maximum output frequency (E1-04)
	Frequency Setting Signal	Main frequency reference: 0 to +10 Vdc (20 kΩ), 4 to 20 mA (250 Ω), 0 to 20 mA (250 Ω) Main speed reference: Pulse Train Input (max 32 kHz)
	Starting Torque	200%/0.5 Hz (OLV Control, HD rating, IM of 3.7 kW or smaller), 50%/6 Hz (OLV/PM Control)
	Speed Control Range	1:100 (OLV Control), 1:40 (V/f Control), 1:10 (OLV/PM Control)
	Speed Control Accuracy	±0.2% in Open Loop Vector Control <math>\lt;/math>
	Speed Response	5 Hz (25 °C ±10 °C) in Open Loop Vector Control (excludes temperature fluctuation when performing Rotational Auto-Tuning)
	Torque Limit	Open Loop Vector Control only. Adjustable in 4 quadrants.
	Accel/Decel Time	0.00 to 6000.0 s (allows four separate settings for accel and decel)
	Braking Torque	Instantaneous Average Decel Torque <math>\lt;/math>: 0.1/0.2 kW: over 150%, 0.4/0.75 kW: over 100%, 1.5 kW: over 50%, 2.2 kW and above: over 20% Continuous Regen Torque: 20%, 125% with a Braking Resistor Unit <math>\lt;/math>: (10% ED) 10 s with an internal braking transistor.
	V/f Characteristics	Preset V/f patterns and user-set program available.
Control Characteristics	Functions	Momentary Power Loss Ride-Thru Speed Search Over/Undertorque Detection Torque Limit, Multi-Step Speed (17 steps max) Accel/Decel Time Switch S-Curve Accel/Decel, 2-Wire/3-Wire Sequence Rotational Auto-Tuning Stationary Auto-Tuning of Line-to-Line Resistance Dwell Cooling Fan ON/OFF Slip Compensation Torque Compensation Jump Frequencies (reference dead band) Frequency Reference Upper/Lower Limit DC Injection Braking (start and stop), High Slip Braking PID Control (with Sleep Function) Energy Saving MEMOBUS/Modbus (RS-485/RS-422 Max 115.2 kbps) Fault Reset Parameter Copy DriveWorksEZ Fault Restart Removable Terminals with Parameter Backup Function

A.4 Drive Specifications

Item		Specification
Protection Functions	Motor Protection	Motor overheat protection via output current sensor
	Overcurrent Protection	Drives stops when output exceeds 200% of the rated current (Heavy Duty)
	Overload Protection	A stop command will be entered after operating at 150% for 60 s (Heavy Duty) <4>
	Overvoltage Specification	200 V Class: Stops when DC bus voltage exceeds approx. 410 V 400 V Class: Stops when DC bus voltage exceeds approx. 820 V
	Low Voltage Protection	Drive stops when DC bus voltage falls below the levels indicated: <5> 190 V (3-phase 200 V), 160 V (single-phase 200 V), 380 V (3-phase 400 V), 350 V (3-phase 380 V)
	Momentary Power Loss Ride-Thru	3 selections available: Ride-Thru disabled (stops after 15 ms), time base of 0.5 s, and continue running as long as the drive control board is powered up. <6>
	Heatsink Overheat Protection	Protected by thermistor
	Braking Resistor Overheat Protection	Overheat input signal for braking resistor (Optional ERF-type, 3% ED)
	Stall Prevention	Stall prevention is available during acceleration, deceleration, and during run. Separate settings for each type of stall prevention determine the current level at which stall prevention is triggered.
	Cooling Fan Failure Protection	Circuit protection (“fan-lock” sensor)
	Ground Fault Protection	Electronic circuit protection <7>
	DC Bus Charge LED	Remains lit until DC bus voltage falls below 50 V
Environment	Storage/Installation Area	Indoors
	Ambient Temperature	IP20/NEMA Type 1 enclosure: -10 °C to +40 °C (14 °F to 104 °F) IP20/IP00 Open-Chassis enclosure: -10 °C to +50 °C (14 °F to 122 °F) Finless Type: IP20/IP00 enclosure: -10 °C to +50 °C (14 °F to 122 °F) NEMA Type 4X/IP66 enclosure: -10 °C to +40 °C (14 °F to 104 °F)
	Humidity	95% RH or less with no condensation
	Storage Temperature	-20 to +60 °C (-4 to +140 °F) allowed for short-term transport of the product
	Altitude	Up to 1000 meters without derating; up to 3000 meters with output current and voltage derating. <i>Refer to Altitude Derating on page 352</i> for details.
	Shock, Impact	10 to 20 Hz: 9.8 m/s ² 20 to 55 Hz: 5.9 m/s ²
	Surrounding Area	Install the drive in an area free from: <ul style="list-style-type: none"> oil mist and dust metal shavings, oil, water or other foreign materials radioactive materials combustible materials harmful gases and liquids excessive vibration chlorides direct sunlight
Orientation	Install the drive vertically to maintain maximum cooling effects	
Standards	<ul style="list-style-type: none"> UL508C EN 61800-3:2004/A1:2012, IEC/EN 61800-5-1 ISO/EN 13849-1 Cat.3 PLd, IEC/EN 61508 SIL2 Time from input open to drive output stop is less than 1 ms.	
Protective Enclosure	IP20/Open-Chassis or IP00/Open-Chassis <8> IP20/NEMA Type 1 <9>	
Cooling Method	BA0001 to BA0006: self-cooled BA0010 to BA0018: cooling fan 2A0001 to 2A0004: self-cooled 2A0006 to 2A0069: cooling fan 4A0001 to 4A0004: self-cooled 4A0005 to 4A0038: cooling fan	

<1> Speed control accuracy varies somewhat according to the type of motor and drive settings.

<2> Instantaneous average deceleration torque refers to the torque required to decelerate the motor (uncoupled from the load) from the rated motor speed down to zero in the shortest time.

<3> Ensure that Stall Prevention Selection during Deceleration is disabled (L3-04 = 0) or set to 3 when using a braking resistor or the Braking Resistor Unit. The default setting for the stall prevention function will interfere with the braking transistor.

<4> Overload protection may be triggered when operating with 150% of the rated output current if the output frequency is less than 6 Hz.

- <5> Parameter settings allow up to 150 V.
- <6> A Momentary Power Loss Ride-Thru Unit is required for 200/400 V class drives 7.5 kW and less if the application needs to continue running during a momentary power loss up to 2 seconds.
- <7> Ground protection cannot be provided under the following circumstances when a ground fault is likely in the motor windings during run: Low ground resistance for the motor cable and terminal block; low ground resistance for the motor cable and terminal block; or the drive is powered up from a ground short.
- <8> The following models have an IP20/Open-Chassis enclosure as standard. Customers may convert these models to IP20/NEMA Type 1 enclosures using the IP20/NEMA Type 1 Kit Option:
2A0030 to 2A0069
4A0018 to 4A0038
- <9> The following models have an IP20/NEMA Type 1 enclosure as standard. For an IP20/Open-Chassis or IP00/Open-Chassis design, remove the top and bottom covers:
BA0001 to BA0018
2A0001 to 2A0020
4A0001 to 4A0011

Note: Time from input open to drive output stop is less than 1 ms.



A.5 Drive Watt Loss Data

Table A.6 Watt Loss 200 V Class Single-Phase Models

Drive Model	Heavy Duty (Carrier Frequency 8 kHz) <1>				Normal Duty (Swing PWM equal 2 kHz)			
	Rated Amps (A)	Heatsink Loss (W)	Interior Unit Loss (W)	Total Loss (W)	Rated Amps (A)	Heatsink Loss (W)	Interior Unit Loss (W)	Total Loss (W)
BA0001	0.8	4.3	7.4	11.7	1.2	5.0	8.5	13.5
BA0002	1.6	7.9	8.9	16.7	1.9	7.6	9.7	17.3
BA0003	3.0	16.1	11.5	27.7	3.2	14.6	14.4	29.1
BA0006	5.0	33.7	16.8	50.5	6.0	30.1	19.4	49.5
BA0010	8.0	54.8	25.9	80.7	9.6	51.7	29.8	81.4
BA0012	11.0	70.7	34.1	104.8	12.0	61.3	37.1	98.4
BA0018	17.5	110.5	51.4	161.9	—	—	—	—

<1> 10 kHz for BA0001 to BA0006

Table A.7 Watt Loss 200 V Class Three-Phase Models

Drive Model	Heavy Duty (Carrier Frequency 8 kHz) <1>				Normal Duty (Swing PWM equal 2 kHz)			
	Rated Amps (A)	Heatsink Loss (W)	Interior Unit Loss (W)	Total Loss (W)	Rated Amps (A)	Heatsink Loss (W)	Interior Unit Loss (W)	Total Loss (W)
2A0001	0.8	4.3	7.3	11.6	1.2	5.0	8.0	13.0
2A0002	1.6	7.9	8.8	16.7	1.9	7.6	9.5	17.1
2A0004	3.0	16.2	11.5	27.7	3.5	15.8	13.6	29.4
2A0006	5.0	27.4	15.9	43.3	6.0	27.5	17.2	44.7
2A0010	8.0	54.8	23.8	78.6	9.6	51.7	25.8	77.5
2A0012	11.0	70.7	29.9	100.6	12.0	61.3	30.4	91.7
2A0020	17.5	110.5	43.3	153.8	19.6	98.7	46.3	145.0
2A0030	25.0	231.5	72.2	303.7	30.0	246.4	88.9	335.3
2A0040	33.0	339.5	82.8	321.3	40.0	266.7	112.8	379.6
2A0056	47.0	347.6	117.6	465.2	56.0	357.9	151.8	509.7
2A0069	60.0	437.7	151.4	589.1	69.0	461.7	184.5	646.2

<1> 10 kHz for 2A0001 to 2A0006

Table A.8 Watt Loss 400 V Class Three-Phase Models

Drive Model	Heavy Duty (Carrier Frequency 8 kHz)				Normal Duty (Swing PWM equal 2 kHz)			
	Rated Amps (A)	Heatsink Loss (W)	Interior Unit Loss (W)	Total Loss (W)	Rated Amps (A)	Heatsink Loss (W)	Interior Unit Loss (W)	Total Loss (W)
4A0001	1.2	19.2	11.5	30.7	1.2	10.0	9.6	19.6
4A0002	1.8	28.9	14.8	43.7	2.1	18.5	13.9	32.4
4A0004	3.4	42.3	17.9	60.2	4.1	30.5	16.8	47.3
4A0005	4.8	70.7	26.2	96.9	5.4	44.5	21.8	66.3
4A0007	5.5	81.0	30.7	111.7	6.9	58.5	28.4	86.9
4A0009	7.2	84.6	32.9	117.5	8.8	63.7	31.4	95.1
4A0011	9.2	107.2	41.5	148.7	11.1	81.7	46.0	127.7
4A0018	14.8	166.0	62.7	228.7	17.5	181.2	80.1	261.3
4A0023	18.0	207.1	78.1	285.2	23.0	213.4	107.7	321.1
4A0031	24.0	266.9	105.9	372.8	31.0	287.5	146.1	433.6
4A0038	31.0	319.1	126.6	445.7	38.0	319.2	155.8	475.0

A.6 Drive Derating Data

The drive can be operated at above rated temperature, altitude and default carrier frequency by derating the drive capacity.

◆ Carrier Frequency Derating

Derate drive capacity using *Figure A.1* as the carrier frequency of the drive increases above the factory setting.

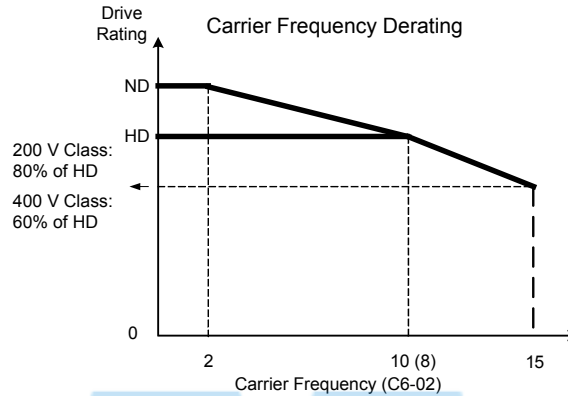

Figure A.1 Carrier Frequency Derating

◆ Temperature Derating

As the ambient temperature for the drive is increased above the drive specification the drive should be derated. Additionally parameter L8-35 Installation Method Selection on page 351 should be set according to enclosure type and mounting method as illustrated in *Figure A.2*.

■ Output Current Derating Due to Ambient Temperature

Set L8-12 and L8-35 according to the installation conditions when the ambient temperature is above the drive specification or when drives are mounted side-by-side in a cabinet. The output current is derated as shown in *Figure A.2*.

No.	Name	Description	Range	Def.
L8-12	Ambient Temperature Setting	Adjust the drive overload (oL2) protection level when the drive is installed in an environment that exceeds its ambient temperature rating.	-10 to 50	40 °C
L8-35	Installation Method Selection	0: IP20/IP00 Drive 1: Side-by-Side Mounting 2: NEMA Type 1 Drive 3: Finless Drive or External Heatsink Installation	0 to 3	0

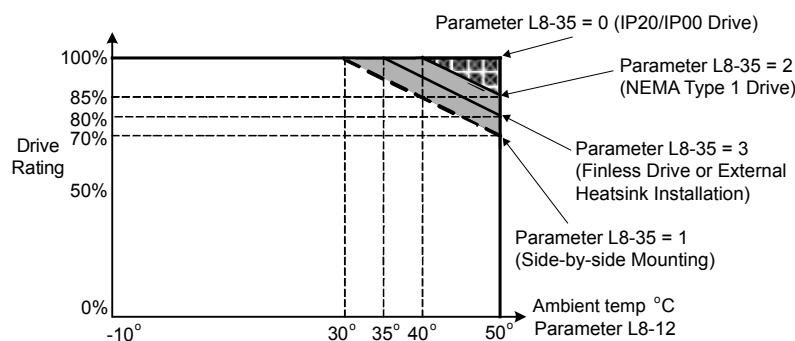

Figure A.2 Ambient Temperature and Installation Method Derating

◆ Altitude Derating

The drive standard ratings are valid for an installation altitude up to 1000 m. If the altitude exceeds 1000 m, both the drive input voltage and the rated output current must be derated for 1% per 100 m. The maximum altitude is 3000 m.

The logo consists of the letters 'D', 'M', and 'C' in a large, bold, sans-serif font. Each letter is filled with a light teal color and has a thick, light blue outline. The letters are spaced out horizontally.The tagline 'Drives Motors Controls' is written in a grey, sans-serif font. It is positioned below the logo and is framed by two horizontal light blue lines, one above and one below the text.

Appendix: B

Parameter List

This appendix contains a full listing of all parameters and settings available in the drive.

B.1	PARAMETER GROUPS.....	354
B.2	PARAMETER TABLE.....	355
B.3	CONTROL MODE DEPENDENT PARAMETER DEFAULT VALUES.....	406
B.4	V/F PATTERN DEFAULT VALUES.....	408
B.5	DEFAULTS BY DRIVE MODEL AND DUTY RATING (ND/HD).....	409
B.6	PARAMETERS THAT CHANGE WITH THE MOTOR CODE SELECTION	417

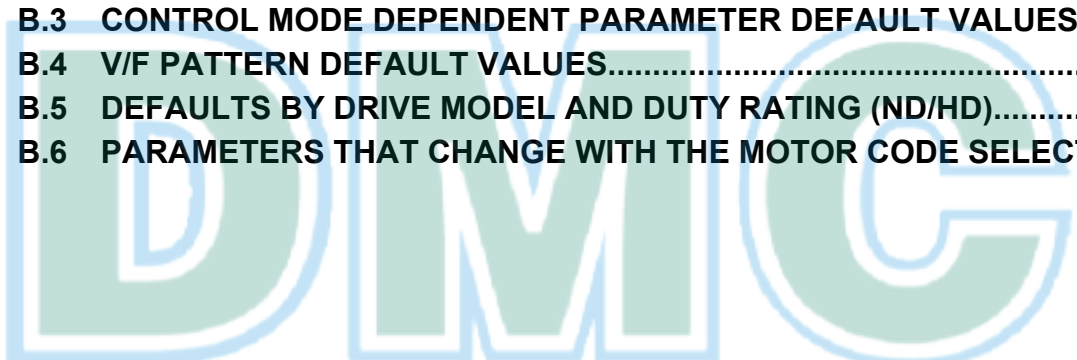

Drives Motors Controls

B.1 Parameter Groups

Parameter Group	Name	Page
A1	Initialization	355
A2	User Parameters	356
b1	Operation Mode Selection	356
b2	DC Injection Braking	357
b3	Speed Search	358
b4	Delay Timer	358
b5	PID Control	358
b6	Dwell Function	360
b8	Energy Saving	360
C1	Acceleration/Deceleration Time	361
C2	S-Curve Accel/Decel	362
C3	Motor Slip Compensation	362
C4	Motor Torque Compensation	362
C5	Speed Control (ASR)	363
C6	Carrier Frequency	363
d1	Frequency Reference	364
d2	Reference Limits	365
d3	Jump Frequencies	365
d4	Frequency Reference Hold	365
d7	Off-Set Frequency	366
E1	V/f Pattern	367
E2	Motor Setup	367
E3	Motor 2 V/f Pattern	368
E4	Motor Setup 2	369
E5	PM Motor Setup	370
F1	Fault Detection during PG Speed Control	371
F6	Network Communications	372
F7	EtherNet/IP and Modbus TCP/IP Communications	374
H1	Digital Inputs	376
H2	Digital Outputs	378

Parameter Group	Name	Page
H3	Analog Inputs	381
H4	Analog Outputs	382
H5	Serial Communications Setup	382
H6	Pulse Train I/O Setup	383
L1	Motor Overload	384
L2	Power Loss Ride-Thru	384
L3	Stall Prevention	385
L4	Reference Detection	387
L5	Fault Restart	387
L6	Overtorque Detection	387
L7	Torque Limit	389
L8	Hardware Protection	389
n1	Hunting Prevention	391
n2	Speed Feedback Detection	392
n3	High-Slip Braking	392
n6	Motor Line-to-Line Resistance Online Tuning	392
n8	PM Motor Control	392
o1	Monitor Display Selection	394
o2	Operator Keypad Functions	394
o4	Maintenance Functions	395
q	DWEZ Parameters	396
r	DriveWorksEZ Connection	396
T1	Auto-Tuning	398
U1	Status Monitor	399
U2	Fault Trace	400
U3	Fault History	401
U4	Maintenance Monitor	402
U5	PID Monitor	403
U6	Control Monitor	404
U8	Custom Monitors for DriveWorksEZ	404

B.2 Parameter Table

An “A” in the “Control Mode” column indicates that the parameter is available in the Advanced menu of the respective control mode.

An “S” in the “Control Mode” column indicates that the parameter is available in the Startup menu of the respective control mode.

A “-” in the “Control Mode” column indicates that the parameter is NOT available in the respective control mode.

An “O” in the “Control Mode” column indicates that the multi-function selection is available in the respective control mode.

◆ A: Initialization Parameters

The A parameter group creates the operating environment for the drive. This includes the parameter Access Level, Motor Control Method, Password, User Parameters and more.

No.	Name	Description	Range	Def.	Control Mode			Addr. Hex	Pg.
					V/f	OLV	PM		
A1: Initialization Parameters									
Use A1 parameters to configure the basic environment for drive operation.									
A1-00 <1> <2>	Language Selection	0: English 1: Japanese 2: German 3: French 4: Italian 5: Spanish 6: Portuguese 7: Chinese	0 to 7	0	A	A	A	100	116
A1-01 <1> <3>	Access Level Selection	Selects which parameters are accessible via the digital operator. 0: Operation only 1: User Parameters (access to a set of parameters selected by the user) 2: Advanced Access Level	0 to 2	2	A	A	A	101	116
A1-02 <2>	Control Method Selection	Selects the Control Method of the drive. Auto-Tuning must be performed when selecting one of the vector control modes. 0: V/f Control without PG 2: Open Loop Vector (OLV) 5: PM Open Loop Vector (PM) Note: 1. Does not return to the default setting after initialization. 2. If using Open Loop Vector Control (A1-02 = 2), then Auto-Tuning must be performed again after the drive is initialized. <i>Refer to Auto-Tuning on page 102</i> for details.	0, 2, 5	0	S	S	S	102	116
A1-03	Initialize Parameters	Resets all parameters to factory default settings. (Initializes the drive then returns A1-03 to 0) 0: No Initialization 1110: User Initialize (First set user parameter values must be stored using parameter o2-03) 2220: 2-Wire Initialization 3330: 3-Wire Initialization 5550: oPE04 Error Reset	0 to 5550	0	A	A	A	103	117
A1-04	Password		0 to 9999	0	A	A	A	104	118
A1-05	Password Setting	When the value set into A1-04 does not match the value set into A1-05, parameters A1-01 through A1-03, A1-06, and A2-01 through A2-32 cannot be changed.	0 to 9999	0	A	A	A	105	118
									—
									This parameter is hidden from view. To access A1-05, first display A1-04. Then press the STOP key while holding down the up arrow key. Parameter A1-05 will appear.

B.2 Parameter Table

No.	Name	Description	Range	Def.	Control Mode			Addr. Hex	Pg.
					V/f	OLV	PM		
A1-06	Application Preset	Sets parameters that are commonly used in certain applications to A2-01 through A2-16 for easier access. 0: General-purpose (A2 parameters are not affected) 1: Water supply pump 2: Conveyor 3: Exhaust fan 4: HVAC fan 5: Air compressor 8: Conveyor 2 <4> Note: Application Preset settings 6 and 7 are only present in drive software versions PRG: 1011 and earlier.	0 to 5; 8	0	A	A	A	127	96
A1-07 <2>	DriveWorksEZ Function Selection	0: Disabled 1: Enabled 2: Multi-function input (enabled when H1-□□ = 9F)	0 to 2	0	A	A	A	128	119
A2: User Parameters Use A2 parameters to program the drive.									
A2-01 to A2-32	User Parameters, 1 to 32	Parameters that were recently edited are listed here. The user can also select parameters to appear here for quick access. Parameters will be stored here for quick access when A1-01 = 1.	A1-00 to o2-08	<2>	A	A	A	106 to 125	120
A2-33	User Parameter Automatic Selection	0: Parameters A2-01 through A2-32 are reserved for the user to create a list of User Parameters. 1: Save history of recently viewed parameters. Recently edited parameters will be saved to A2-17 through A2-32 for quick access.	0, 1	<2>	A	A	A	126	120

<1> Parameter can be changed during run.

<2> Parameter setting value is not reset to the default value during drive initialization, A1-03 = 1110, 2220, 3330.

<3> Default setting value is dependent on parameter A1-06, Application Selection.

<4> Available in drive software versions PRG: 1020 and later.

<5> Default setting value is dependent on parameter A1-06. This setting value is 0 when A1-06 = 0, and 1 when A1-06 ≠ 0.

◆ b: Application

Application parameters configure the Run Command Source, DC Injection Braking, Speed Search, Timer functions, PID control, the Dwell function, Energy Savings and a variety of other application-related settings.

No.	Name	Description	Range	Def.	Control Mode			Addr. Hex	Pg.
					V/f	OLV	PM		
b1: Operation Mode Selection Use b1 parameters to configure the operation mode.									
b1-01	Frequency Reference Selection 1	Selects the frequency reference input source. 0: Digital operator - Digital preset speed d1-01 to d1-17. 1: Terminals - Analog input terminal A1 or A2. 2: MEMOBUS communications 3: Option PCB 4: Pulse Input (Terminal RP)	0 to 4	1	S	S	S	180	121
b1-02	Run Command Selection 1	Selects the run command input source. 0: Digital operator - RUN and STOP keys on the digital operator. 1: Digital input terminals 2: MEMOBUS communications 3: Option PCB.	0 to 3	1	S	S	S	181	123

No.	Name	Description	Range	Def.	Control Mode			Addr. Hex	Pg.
					V/f	OLV	PM		
b1-03	Stopping Method Selection	Selects the stopping method when the run command is removed. 0: Ramp to Stop 1: Coast to Stop 2: DC Injection Braking to Stop 3: Coast with Timer (A new run command is ignored if received before the timer expires)	0 to 3	0	S	S	S	182	124
			DC Injection Braking at Stop cannot be selected when using Open Loop Vector for PM motors.						
b1-04	Reverse Operation Selection	Permits or prohibits reverse operation. 0: Reverse enabled. 1: Reverse disabled.	0, 1	0	A	A	A	183	126
b1-07	LOCAL/REMOTE Run Selection	Determines the operation when the Run command source is switched from LOCAL to REMOTE or between Run source 1 and 2 while an external Run command is active at the new source. 0: External Run command has to be cycled at the new source to be activated. 1: External Run command at new source is accepted immediately.	0, 1	0	A	A	A	186	127
b1-08	Run Command Selection while in Programming Mode	0: Run command accepted only in the operation menu. 1: Run command accepted in all menus. 2: Prohibit entering Programming Mode during Run	0 to 2	0	A	A	A	187	127
b1-14	Phase Order Selection	Sets the phase order for drive output terminals U/T1, V/T2 and W/T3. 0 : Standard 1 : Switch phase order	0, 1	0	A	A	A	1C3	127
b1-15	Frequency Reference Selection 2	Selects the frequency reference input source 2. 0: Operator - Digital preset speed d1-01 to d1-17. 1: Terminals - Analog input terminal A1 or A2 2: MEMOBUS communications 3: Option PCB 4: Pulse Input (Terminal RP)	0 to 4	0	A	A	A	1C4	128
b1-16	Run Command Selection 2	Selects the run command input source 2. 0: Operator - RUN and STOP keys on the digital operator. 1: Digital input terminals 2: MEMOBUS communications 3: Option PCB	0 to 3	0	A	A	A	1C5	128
b1-17	Run Command at Power Up	Determines the operation when a Run command is active at power up of the drive. 0: Run command not issued, needs to be cycled 1: Run command issued, motor operation start	0, 1	0	A	A	A	1C6	128
b2: DC Injection Braking									
Use b2 parameters to configure DC Injection Braking operation									
b2-01	DC Injection Braking Start Frequency	Sets the frequency at which DC Injection Braking starts when Ramp to Stop (b1-03 = 0) is selected. If b2-01 < E1-09, DC Injection Braking starts at E1-09.	0.0 to 10.0	0.5 Hz	A	A	A	189	128
b2-02	DC Injection Braking Current	Sets the DC Injection Braking current as a percentage of the drive rated current.	0 to 75	50%	A	A	A	18A	129
b2-03	DC Injection Braking Time/DC Excitation Time at Start	Sets DC Injection Braking time at start. Disabled when set to 0.00 seconds.	0.00 to 10.00	0.00 s <2>	A	A	A	18B	129
b2-04	DC Injection Braking Time at Stop	Sets DC Injection Braking time at stop. When b1-03 = 2, actual DC Injection time is calculated as follows: (b2-04) x 10 x (Output Freq)/(E1-04). When b1-03 = 0, this parameter sets the amount of DC Injection time applied to the motor at the end of the decel ramp or High Slip Braking. Disabled when set to 0.00.	0.00 to 10.00	0.50 s	A	A	-	18C	129
b2-08	Magnetic Flux Compensation Value	Sets the magnetic flux compensation as a percentage of the no-load current value (E2-03).	0 to 1000	0%	-	A	-	190	129
b2-12	Short Circuit Brake Time at Start	Sets the time for Short-Circuit brake operation at start. Disabled when set to 0.00. <2>	0.00 to 25.50	0.00 s	-	-	A	1BA	129

B.2 Parameter Table

No.	Name	Description	Range	Def.	Control Mode			Addr. Hex	Pg.
					V/f	OLV	PM		
b2-13	Short Circuit Brake Time at Stop	Sets the Short-Circuit brake operation time at stop. Used to stop a motor rotating due to inertia. Disabled when set to 0.00 seconds. <>	0.00 to 25.50	0.50 s	-	-	A	1BB	129
b3: Speed Search									
Use b3 parameters to configure Speed Search function operation.									
b3-01	Speed Search Selection at Start	Enables/disables the Speed Search function at start. 0: Disabled - Speed Search is not automatically performed at start. 1: Enabled - Speed Search is automatically performed at start.	0, 1	0	A	A	A	191	133
b3-02	Speed Search Deactivation Current	Sets the current level at which the speed is assumed to be detected and Speed Search is ended. Set as a percentage of the drive rated current.	0 to 200	120 <3>	A	A	-	192	133
b3-03	Speed Search Deceleration Time	Sets the time constant used to reduce the output frequency during Speed Search. Related to a change from max. output frequency to 0.	0.1 to 10.0	2.0 s	A	A	-	193	133
b3-05	Speed Search Delay Time	Delays the Speed Search operation after a momentary power loss to allow time for an external output contactor to close.	0.0 to 100	0.2 s	A	A	A	195	133
b3-06	Output Current 1 during Speed Search	Sets the current injected to the motor at the beginning of Estimation type Speed Search. Set as a factor of the motor rated current.	0.0 to 2.0	<4>	A	A	-	196	134
b3-08 <11>	Current Control Gain during Speed Search (Speed Estimation Type)	Sets the proportional gain for the current controller during Speed Search. There is normally no need to change this parameter from the default value.	0.00 to 6.00	<12>	A	A	A	198	134
b3-10	Speed Search Detection Compensation Gain	Sets the gain which is applied to the speed detected by Speed Estimation Speed Search before the motor is reaccelerated. Increase this setting if ov occurs when performing Speed Search.	1.00 to 1.20	1.05	A	A	-	19A	134
b3-14	Bi-Directional Speed Search Selection	Selects if Speed Search detects the motor rotation direction during Speed Search. 0: Disabled-Frequency reference direction used 1: Enabled-Detected direction used	0, 1	0	A	A	-	19E	134
b3-17	Speed Search Restart Current Level	Sets the Speed Search restart current level as a percentage of the drive rated current.	0 to 200	150%	A	A	-	1F0	134
b3-18	Speed Search Restart Detection Time	Sets the time in seconds for Speed Search restart to be detected.	0.00 to 1.00	0.10 s	A	A	-	1F1	134
b3-19	Number of Speed Search Restarts	Sets the number of restarts possible for Speed Search restart operations.	0 to 10	3	A	A	-	1F2	135
b3-24	Speed Search Method Selection	Sets the Speed Search detection mode. 0: Current Detection Type 1: Speed Estimation Type	0, 1	0	A	A	-	1C0	135
b3-25	Speed Search Retry Interval Time	Sets the wait time before Speed Search restarts.	0 to 30.0	0.5 s	A	A	A	1C8	135
b3-29 <5>	Speed Search Induced Voltage Level	Performs Speed Search when the motor induced voltage exceeds the set level. This setting rarely needs to be changed. If changes are necessary, try lowering this value in small increments. If set too low, then the drive will not perform Speed Search.	0 to 10	10%	-	-	A	77C	135
b4: Timer Function									
Use b4 parameters to configure timer function operation.									
b4-01	Timer Function On-Delay Time	Used in conjunction with a multi-function digital input (H1-□□ = 18) and a multi-function digital output (H2-□□ = 12) programmed for the timer function. This sets the amount of time between digital input closure and digital output activation.	0.0 to 300.0	0.0 s	A	A	A	1A3	135
b4-02	Timer Function Off-Delay Time	Used in conjunction with a multi-function digital input (H1-□□ = 18) and a multi-function digital output programmed for the timer function. This sets the amount of time the output remains activated after the digital input is opened.	0.0 to 300.0	0.0 s	A	A	A	1A4	135
b5: PID Control									
Use b5 parameters to configure the PID control drive function.									

No.	Name	Description	Range	Def.	Control Mode			Addr. Hex	Pg.
					V/f	OLV	PM		
b5-01	PID Function Setting	Sets the PID control mode. 0: Disabled 1: Enable (PID output = freq. ref., PID input is D-controlled) 2: (PID output = freq. ref., PID feedback is D-controlled) 3: Enable (PID output added to freq. ref., PID input is D-controlled) 4: Enable (PID output added to freq. ref., PID feedback is D-controlled)	0 to 4	0	A	A	A	1A5	139
b5-02 <6>	Proportional Gain Setting (P)	Sets the proportional gain of the PID controller. A setting of 0.00 disables P control.	0.00 to 25.00	1.00	A	A	A	1A6	139
b5-03 <6>	Integral Time Setting (I)	Sets the integral time for the PID controller. A setting of 0.0 s disables integral control.	0.0 to 360.0	1.0 s	A	A	A	1A7	139
b5-04 <6>	Integral Limit Setting	Sets the maximum output possible from the integrator.	0.0 to 100.0	100.0 %	A	A	A	1A8	139
b5-05 <6>	Derivative Time (D)	Sets D control derivative time. A setting of 0.00 s disables derivative control.	0.00 to 10.00	0.00 s	A	A	A	1A9	140
b5-06 <6>	PID Output Limit	Sets the maximum output possible from the entire PID controller.	0.0 to 100.0	100.0 %	A	A	A	1AA	140
b5-07 <6>	PID Offset Adjustment	Applies an offset to the PID controller output.	-100.0 to +100.0	0.0%	A	A	A	1AB	140
b5-08 <6>	PID Primary Delay Time Constant	Sets the amount of time for the filter on the output of the PID controller.	0.00 to 10.00	0.00 s	A	A	A	1AC	140
b5-09	PID Output Level Selection	Sets the PID controller output direction. 0: Normal Output (direct acting) 1: Reverse Output (reverse acting)	0, 1	0	A	A	A	1AD	140
b5-10	PID Output Gain Setting	Sets the gain applied to the PID output.	0.00 to 25.00	1.00	A	A	A	1AE	140
b5-11	PID Output Reverse Selection	Sets the drive operation with negative PID output. 0: Negative PID output triggers zero limit and drive stops. 1: Rotation direction reverses with negative PID output. When using setting 1 make sure, reverse operation is permitted by parameter b1-04.	0, 1	0	A	A	A	1AF	140
b5-12	PID Feedback Reference Missing Detection Selection	Configures the PID feedback loss detection. With all setting a digital output programmed for H2-01/02/03 = 3E/3F (PID feedback low/PID feedback high) is operated when the detection condition becomes true. 0: Digital output only. 1: Feedback loss detected when PID enabled. Alarm output, operation is continued without triggering a fault contact. 2: Feedback loss detected when PID enabled. Fault output, operation is stopped and a fault contact is triggered. 3: Feedback loss detection even when PID is disabled by digital input. No alarm/fault output. 4: PID Feedback error detection even when PID is disabled by digital input. An alarm is triggered and the drive continues to run. 5: PID Feedback error detection even when PID is disabled by digital input. Fault is triggered and output is shut off.	0 to 5	0	A	A	A	1B0	141
b5-13	PID Feedback Loss Detection Level	Sets the PID feedback loss detection level.	0 to 100	0%	A	A	A	1B1	142
b5-14	PID Feedback Loss Detection Time	Sets the PID feedback loss detection delay time in terms of seconds.	0.0 to 25.5	1.0 s	A	A	A	1B2	142
b5-15	PID Sleep Function Start Level	Sets the sleep function start frequency. Note: Also enabled when PID is not active.	0.0 to 400.0	0.0 Hz	A	A	A	1B3	142
b5-16	PID Sleep Delay Time	Sets the sleep function delay time.	0.0 to 25.5	0.0 s	A	A	A	1B4	143
b5-17	PID Accel/Decel Time	Applies an accel/decel time to the PID setpoint.	0 to 255	0 s	A	A	A	1B5	143
b5-18	PID Setpoint Selection	Selects b5-19 as PID setpoint value. 0: Disabled 1: Enabled, b5-19 becomes PID target	0, 1	0	A	A	A	1DC	143

B.2 Parameter Table

No.	Name	Description	Range	Def.	Control Mode			Addr. Hex	Pg.
					V/f	OLV	PM		
b5-19	PID Setpoint Value	Sets the PID target value when b5-18 = 1.	0.00 to 100.00	0.00 %	A	A	A	1DD	143
b5-20	PID Setpoint Scaling	Sets the units for setting/display b5-19, and for parameter monitors U5-01 (PID Feedback) and U5-04 (PID Setpoint). 0: 0.01Hz units 1: 0.01% units (100% = max output frequency) 2: r/min (number of motor poles must be set up) 3: User-set (set to b5-38 and b5-39)	0 to 3	1	A	A	A	1E2	143
b5-34 <6>	PID Output Lower Limit	Sets the minimum output possible from the PID controller.	-100.0 to +100.0	0.00 %	A	A	A	19F	144
b5-35 <6>	PID Input Limit	Limits the PID control input (deviation signal). Acts as a bipolar limit.	0.0 to 1000.0	1000.0 %	A	A	A	1A0	144
b5-36	PID Feedback High Detection Level	Sets the PID feedback high detection level.	0 to 100	100%	A	A	A	1A1	142
b5-37	PID Feedback High Level Detection Time	Sets the PID feedback high level detection delay time.	0.0 to 25.5	1.0 s	A	A	A	1A2	142
b5-38	PID Setpoint / User Display	Sets the display value of U5-01 and U5-04 when the maximum frequency is output. Changeable only if b5-20 = 3. 0 to 60000: User-Set Display if b5-20 = 3	1 to 60000	<7>	A	A	A	1FE	144
b5-39	PID Setpoint Display Digits	Sets the number of digits of U5-01 and U5-04. Changeable only if b5-20 = 3. 0: No decimal places 1: One decimal places 2: Two decimal places 3: Three decimal places	0 to 3	<7>	A	A	A	1FF	144
b5-40 <6>	Frequency Reference Monitor Content during PID	0: Display the frequency reference (U1-01) after PID compensation has been added. 1: Display the frequency reference (U1-01) before PID compensation has been added.	0, 1	0	A	A	A	17F	144
b5-47 <5>	Reverse Operation Selection 2 by PID Output	Reverses operation selection when b5-01 = 3 or 4 0: Zero limit when PID output is a negative value 1: Reverse operation when PID output is a negative value (Zero limit if the reverse operation is prohibited by b1-04)	0, 1	1	A	A	A	17D	144
b6: Dwell Function Use b6 parameters to configure dwell function operation.									
b6-01	Dwell Reference at Start	The Dwell function is used to temporarily hold the frequency when driving a motor with a heavy load.	0.0 to 400.0	0.0 Hz	A	A	A	1B6	145
b6-02	Dwell Time at Start	Parameters b6-01 and b6-02 set the frequency to hold and the time to maintain that frequency at start.	0.0 to 10.0	0.0 s	A	A	A	1B7	145
b6-03	Dwell Frequency at Stop	Parameters b6-03 and b6-04 set the frequency to hold and the time to maintain that frequency at stop.	0.0 to 400.0	0.0 Hz	A	A	A	1B8	145
b6-04	Dwell Time at Stop		0.0 to 10.0	0.0 s	A	A	A	1B9	145
b8: Energy Saving Use b8 parameters to configure the energy saving/conservation drive function.									
b8-01	Energy Saving Control Selection	Selects the Energy Savings function. 0: Disabled 1: Enabled	0, 1	0	A	A	-	1CC	145
b8-02 <6>	Energy Saving Gain	Sets energy savings control gain when in Open Loop Vector Control.	0.0 to 10.0	0.7	-	A	-	1CD	145
b8-03 <6>	Energy Saving Control Filter Time Constant	Sets energy saving control filter time constant when in Open Loop Vector Control.	0.00 to 10.00	0.50 <4>	-	A	-	1CE	145
b8-04	Energy Saving Coefficient Value	Sets the Energy Saving coefficient and is used to fine adjustments in V/f Control.	0.0 to 655.00	<9> <10>	A	-	-	1CF	146

No.	Name	Description	Range	Def.	Control Mode			Addr. Hex	Pg.
					V/f	OLV	PM		
b8-05	Power Detection Filter Time	Sets a filter time for the Power Detection used by Energy Savings in V/f Control.	0 to 2000	20 ms	A	-	-	1D0	146
b8-06	Search Operation Voltage Limit	Sets the limit for the voltage search operation performed by Energy Savings in V/f Control. Set as a percentage of the motor base voltage. Disabled when set to 0%.	0 to 100	0%	A	-	-	1D1	146

- <1> Default setting value is dependent on parameter A1-02, Control Method Selection. The value shown is for A1-02 = 2-OLV control.
- <2> A coasting motor may require a braking resistor circuit to bring the motor to a stop in the required time.
- <3> Default setting value is dependent on parameter A1-02, Control Method Selection. The value shown is for A1-02 = 0-V/f Control.
- <4> Default setting value is dependent on parameter o2-04, Drive Model Selection.
- <5> Available in drive software versions PRG: 1020 and later.
- <6> Parameter can be changed during Run.
- <7> Default setting is dependent on parameter b5-20, PID Setpoint Scaling.
- <8> Available in drive software versions PRG: 1014 and later.
- <9> Default setting value is dependent on parameter o2-04, Drive Model Selection and C6-01, Drive Duty Selection.
- <10> Parameter value is changed if E2-11 is manually changed or changed by Auto-Tuning.
- <11> Available in drive software versions PRG: 1022 and later.
- <12> Default setting is determined by A1-02, Control Method Selection

◆ C: Tuning

C parameters are used to adjust the acceleration and deceleration times, S-curves, slip and torque compensation functions and carrier frequency selections.

No.	Name	Description	Range	Def.	Control Mode			Addr. Hex	Pg.		
					V/f	OLV	PM				
C1: Acceleration and Deceleration Times											
Use C1 parameters to configure motor acceleration and deceleration.											
C1-01 </>	Acceleration Time 1	Sets the time to accelerate from 0 to maximum frequency.	0.0 to 6000.0 <2>	10.0 s	S	S	S	200	147		
C1-02 </>	Deceleration Time 1	Sets the time to decelerate from maximum frequency to 0.			S	S	S	201	147		
C1-03 </>	Acceleration Time 2	Sets the time to accelerate from 0 to maximum frequency when Accel/Decel times 2 are selected by a digital input.			A	A	A	202	147		
C1-04 </>	Deceleration Time 2	Sets the time to decelerate from maximum frequency to 0 when Accel/Decel times 2 are selected by a digital input.			A	A	A	203	147		
C1-05 </>	Acceleration Time 3 (Motor 2 Accel Time 1)	Sets the time to accelerate from 0 to maximum frequency when Accel/Decel times 3 are selected by a digital input.			A	A	A	204	147		
C1-06 </>	Deceleration Time 3 (Motor 2 Decel Time 1)	Sets the time to decelerate from maximum frequency to 0 when Accel/Decel times 3 are selected by a digital input.			A	A	A	205	147		
C1-07 </>	Acceleration Time 4 (Motor 2 Accel Time 2)	Sets the time to accelerate from 0 to maximum frequency when Accel/Decel times 4 are selected by a digital input.			A	A	A	206	147		
C1-08 </>	Deceleration Time 4 (Motor 2 Decel Time 2)	Sets the time to decelerate from maximum frequency to 0 when Accel/Decel times 4 are selected by a digital input.			A	A	A	207	147		
C1-09	Fast-Stop Time	Sets the time to decelerate from maximum frequency to 0 for the multi-function input fast-stop function. Note: This parameter is also used by selecting "Fast-Stop" as a Stop Method when a fault is detected.			0.0 to 6000.0 <2>	10.0 s	A	A	A	208	148
C1-10	Accel/Decel Time Setting Units	Sets the resolution of C1-01 to C1-09. 0: 0.01 s (0.00 to 600.00 s) 1: 0.1 s (0.0 to 6000.0 s)			0, 1	1	A	A	A	209	148

Parameter List

B

B.2 Parameter Table

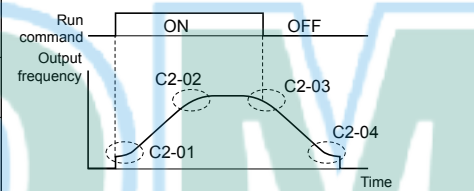
No.	Name	Description	Range	Def.	Control Mode			Addr. Hex	Pg.
					V/f	OLV	PM		
C1-11	Accel/Decel Time Switching Frequency	Sets the frequency for automatic acceleration/deceleration switching. Below set frequency: Accel/Decel Time 4 Above set frequency: Accel/Decel Time 1 The multi-function input "Accel/Decel Time 1" or "Accel/Decel Time 2" take priority.	0.0 to 400.0 Hz	0.0 Hz	A	A	A	20A	149
C1-14 <>	Accel/Decel Rate Frequency	Sets the base frequency used to calculate acceleration and deceleration times. When set to 0.0 Hz, the drive calculates the time required to accelerate from 0 Hz to E1-04, and decelerate from E1-04 down to 0 Hz (conventional setting). When set to any other value above 0.0 Hz, the drive calculates the time required to accelerate from 0 Hz to C1-14, and to decelerate from C1-14 down to 0 Hz.	0.0 to 400.0 Hz	0.0 Hz	A	A	A	264	149
C2: S-Curve Characteristics Use C2 parameters to configure S-curve operation.									
C2-01	S-Curve Characteristic at Accel Start	<p>The S-curve can be controlled in the four points shown below.</p>  <p>S-curve is used to further soften the starting and stopping ramp. The longer the S-curve time, the softer the starting and stopping ramp.</p>	0.00 to 10.00	0.20 s <>	A	A	A	20B	150
C2-02	S-Curve Characteristic at Accel End		0.00 to 10.0	0.20 s	A	A	A	20C	150
C2-03	S-Curve Characteristic at Decel Start		0.00 to 10.0	0.20 s	A	A	A	20D	150
C2-04	S-Curve Characteristic at Decel End		0.00 to 10.0	0.00 s	A	A	A	20E	150
C3: Slip Compensation Use C3 parameters to configure the slip compensation function.									
C3-01 </>	Slip Compensation Gain	Sets the slip compensation gain. Decides for what amount the output frequency is boosted in order to compensate the slip. Note: Adjustment is not normally required.	0.0 to 2.5	0.0 <>	A	A	-	20F	151
C3-02	Slip Compensation Primary Delay Time	Adjusts the slip compensation function delay time. Decrease the setting when the slip compensation response is too slow, increase it when the speed is not stable. Disabled when Simple V/f Control with PG (H6-01 = 3) is used.	0 to 10000	2000 ms <>	A	A	-	210	151
C3-03	Slip Compensation Limit	Sets the slip compensation upper limit. Set as a percentage of motor rated slip (E2-02). Disabled when Simple V/f Control with PG (H6-01 = 3) is used.	0 to 250	200%	A	A	-	211	151
C3-04	Slip Compensation Selection during Regeneration	Selects slip compensation during regenerative operation. 0: Disabled 1: Enabled Using the Slip Compensation function during regeneration may require a braking option to handle momentary increasing regenerative energy.	0, 1	0	A	A	-	212	152
C3-05	Output Voltage Limit Operation Selection	Selects if the motor magnetic flux is reduced during output voltage saturation. 0: Disabled 1: Enabled	0, 1	0 <>	-	A	-	213	152
C3-18 <10>	Output Voltage Limit Level	Sets the maximum percentage of output voltage reduction when C3-05 is enabled.	70.0 to 100.0	90.0%	-	A	-	263	152
C4: Torque Compensation Use C4 parameters to configure Torque Compensation function.									

No.	Name	Description	Range	Def.	Control Mode			Addr. Hex	Pg.
					V/f	OLV	PM		
C4-01 <5>	Torque Compensation Gain	V/f Control: Sets the gain for the automatic torque (voltage) boost function and helps to produce better starting torque. Increase this setting when using a long motor cable or when the motor is significantly smaller than the drive capacity. Decrease this setting when motor oscillation occurs. Set the value so that the current at low speed does not exceeds the drives rated current. Open Loop Vector: Sets the torque compensation function gain. Normally no change is required.	0.00 to 2.50	1.00 <4>	A	A	A	215	152
C4-02	Torque Compensation Primary Delay Time	Sets the torque compensation filter time. Increase this setting when motor oscillation occurs. Reduce the setting if there is not enough response from the motor.	0 to 60000	200 ms <6>	A	A	A	216	153
C4-03	Torque Compensation at Forward Start	Sets torque compensation at forward start as a percentage of motor torque.	0.0 to 200.0	0.0%	-	A	-	217	153
C4-04	Torque Compensation at Reverse Start	Sets torque compensation at reverse start as a percentage of motor torque.	-200.0 to 0.0	0.0%	-	A	-	218	153
C4-05	Torque Compensation Time Constant	Sets the time constant for torque compensation at forward start and reverse start (C4-03 and C4-04). The filter is disabled if the time is set to 4 ms or less.	0 to 200	10 ms	-	A	-	219	153
C4-06	Torque Compensation Primary Delay Time 2	Sets the torque compensation time 2. When an ov fault occurs with sudden load changes or at the end of an acceleration, increase the setting. Note: Adjustment is not normally required. If adjusted then AFR time 2 (n2-03) should be adjusted too.	0 to 10000	150 ms	-	A	-	21AH	153
C5: Speed Control (ASR) Use C5 parameters to configure the Automatic Speed Regulator (ASR). C5 parameters are available only when using V/f Control with Simple PG Feedback (H6-01 = 3).									
C5-01 <1>	ASR Proportional Gain 1	Sets the proportional gain of the speed control loop (ASR).	0.00 to 300.00	0.20	A	-	-	21B	155
C5-02 <1>	ASR Integral Time 1	Sets the integral time of the speed control loop (ASR).	0.000 to 10.000	0.200	A	-	-	21C	155
C5-03 <1>	ASR Proportional Gain 2	Sets the speed control gain 2 of the speed control loop (ASR).	0.00 to 300.00	0.02	A	-	-	21D	155
C5-04 <1>	ASR Integral Time 2	Sets the integral time 2 of the speed control loop (ASR).	0.000 to 10.000	0.050 s	A	-	-	21E	155
C5-05 <1>	ASR Limit	Sets the upper limit for the speed control loop (ASR) as a percentage of the maximum output frequency (E1-04).	0.0 to 20.0	5.0%	A	-	-	21F	155
C6: Carrier Frequency Use C6 parameters to configure the carrier frequency drive settings.									
C6-01	Drive Duty Selection	Selects the load rating for the drive. 0: Heavy Duty (HD) for constant torque applications. 1: Normal Duty (ND) for variable torque applications. This setting affects the Rated output current and overload tolerance of the drive.	0, 1	1	S	S	S	223	155
C6-02	Carrier Frequency Selection	Selects the carrier frequency 1 : 2.0 kHz 2 : 5.0 kHz 3 : 8.0 kHz 4 : 10.0 kHz 5 : 12.5 kHz 6 : 15.0 kHz 7 : Swing PWM1 (Audible sound 1) 8 : Swing PWM2 (Audible sound 2) 9 : Swing PWM3 (Audible sound 3) A : Swing PWM4 (Audible sound 4) B: Leakage Current Rejection PWM <3> C to E: No setting possible F : User defined (determined by C6-03 through C6-05)	<3>	<8>	S	S	S	224	156

B.2 Parameter Table

No.	Name	Description	Range	Def.	Control Mode			Addr. Hex	Pg.
					V/f	OLV	PM		
C6-03	Carrier Frequency Upper Limit	Note: Set C6-02 to F before setting C6-03. Open Loop Vector: C6-03 defines the fixed carrier frequency if C6-02 = F. V/f Control: C6-03 and C6-04 set upper and lower limits for the carrier frequency.	1.0 to 15.0	<9>	A	A	A	225	157
C6-04	Carrier Frequency Lower Limit	<p>The coefficient K depends on C6-03: C6-03 ≥ 10.0 kHz: K = 3 10.0 kHz > C6-03 ≥ 5.0 kHz: K = 2 5.0 kHz > C6-03: K = 1 When C6-05 ≤ 6, C6-04 is disabled (makes the carrier frequency C6-03 value).</p>	1.0 to 15.0	<9>	A	-	-	226	157
C6-05	Carrier Frequency Proportional Gain	Sets the relationship of output frequency to carrier frequency when C6-02 = F.	00 to 99	<9>	A	-	-	227	157

- <1> Parameter can be changed during run.
- <2> Setting range value is dependent on parameter C1-10, Accel/Decel Time Setting Units. When C1-10 = 0 (units of 0.01 seconds), the setting range becomes 0.00 to 600.00 seconds.
- <3> Available in drive software versions PRG: 1020 and later.
- <4> Default setting value is dependent on parameter A1-02, Control Method Selection. The value shown is for A1-02 = 0-V/f Control.
- <5> Parameter cannot be changed during run when parameter A1-02 = 5-PM OLV Control.
- <6> Default setting value is dependent on parameter A1-02, Control Method Selection. The value shown is for A1-02 = 2-OLV control.
- <7> Setting range is determined by the drive software version.
PRG: 1020 and later: 1 to B; F
PRG: 1018 and earlier: 1 to A; F
- <8> Default setting value is dependent on parameters o2-04, Drive Model Selection, A1-02, Control Method Selection and C6-01, Drive Duty Selection.
- <9> Default setting value is dependent on parameter C6-02, Carrier Frequency Selection.
- <10> Available in drive software versions PRG: 1024 and later.

◆ d: References

Reference parameters are used to set the various frequency reference values during operation.

No.	Name	Description	Range	Def.	Control Mode			Addr. Hex	Pg.
					V/f	OLV	PM		
d1: Frequency Reference Use d1 parameters to configure the drive frequency reference.									
d1-01 <1>	Frequency Reference 1	Frequency reference. <i>Refer to b1-01: Frequency Reference Selection 1 on page 121</i> for instructions to use d1-01 as the main frequency reference.	0.00 to 400.00 Hz	0.00 Hz	S	S	S	280	160
d1-02 <1>	Frequency Reference 2	Frequency reference when digital input "Multi-Step Speed Reference 1" (H1-□□ = 3) is on.	<2> <3>	0.00 Hz	S	S	S	281	160
d1-03 <1>	Frequency Reference 3	Frequency reference when digital input "Multi-Step Speed Reference 2" (H1-□□ = 4) is on.	0.00 to 400.00 Hz	0.00 Hz	S	S	S	282	160
d1-04 <1>	Frequency Reference 4	Frequency reference when digital inputs "Multi-Step Speed Reference 1, 2" (H1-□□ = 3 and 4) are on.	<2> <3>	0.00 Hz	S	S	S	283	160
d1-05 <1>	Frequency Reference 5	Frequency reference when digital input "Multi-Step Speed Reference 3" (H1-□□ = 5) is on.	0.00 to 400.00 Hz	0.00 Hz	A	A	A	284	160
d1-06 <1>	Frequency Reference 6	Frequency reference when digital inputs "Multi-Step Speed Reference 1, 3" (H1-□□ = 3 and 5) are on.	<2> <3>	0.00 Hz	A	A	A	285	160

No.	Name	Description	Range	Def.	Control Mode			Addr. Hex	Pg.
					V/f	OLV	PM		
d1-07 </>	Frequency Reference 7	Frequency reference when digital inputs "Multi-Step Speed Reference 2, 3" (H1-□□ = 4 and 5) are on.	0.00 to 400.00 Hz	0.00 Hz	A	A	A	286	160
d1-08 </>	Frequency Reference 8	Frequency reference when multi-function input "Multi-Step speed reference 1, 2, 3" (H1-□□ = 3, 4, 5) are on.	<?> <?>	0.00 Hz	A	A	A	287	160
d1-09 </>	Frequency Reference 9	Frequency reference when multi-function input "Multi-Step Speed Reference 4" (H1-□□ = 32) is on.	0.00 to 400.00 Hz	0.00 Hz	A	A	A	288	160
d1-10 </>	Frequency Reference 10	Frequency reference when digital input "Multi-Step Speed Reference 1, 4" (H1-□□ = 3 and 32) are on.	<?> <?>	0.00 Hz	A	A	A	28B	160
d1-11 </>	Frequency Reference 11	Frequency reference when digital inputs "Multi-Step Speed Reference 2, 4" (H1-□□ = 4 and 32) are on.	0.00 to 400.00 Hz	0.00 Hz	A	A	A	28C	160
d1-12 </>	Frequency Reference 12	Frequency reference when digital inputs "Multi-Step Speed Reference 1, 2, 4" (H1-□□ = 3, 4, 32) are on.	<?> <?>	0.00 Hz	A	A	A	28D	160
d1-13 </>	Frequency Reference 13	Frequency reference when digital inputs "Multi-Step Speed Reference 3, 4" (H1-□□ = 5 and 32) are on.	0.00 to 400.00 Hz	0.00 Hz	A	A	A	28E	160
d1-14 </>	Frequency Reference 14	Frequency reference when digital inputs "Multi-Step Speed Reference 1, 3, 4" (H1-□□ = 3, 5, 32) are on.	<?> <?>	0.00 Hz	A	A	A	28F	160
d1-15 </>	Frequency Reference 15	Frequency reference when digital inputs "Multi-Step Speed Reference 2, 3, 4" (H1-□□ = 4, 5, 32) are on.	0.00 to 400.00 Hz	0.00 Hz	A	A	A	290	160
d1-16 </>	Frequency Reference 16	Frequency reference when digital inputs "Multi-Step Speed Reference 1, 2, 3, 4" (H1-□□ = 3, 4, 5, 32) are on.	<?> <?>	0.00 Hz	A	A	A	291	160
d1-17 </>	Jog Frequency Reference	Frequency reference when digital inputs "Jog Frequency Reference", "Forward Jog", or "Reverse Jog." are on. "Jog Frequency Reference" has priority over "Multi-Step Speed Reference 1 to 16".	0.00 to 400.00 Hz	6.00 Hz	S	S	S	292	160
d2: Frequency Upper and Lower Limits Use d2 parameters to configure the frequency reference limits.									
d2-01	Frequency Reference Upper Limit	Sets the frequency reference upper limit as a percentage of maximum output frequency (E1-04). Output speed is limited to this value even if the frequency reference is higher. This limit applies to all frequency reference sources.	0.0 to 110.0	100.0 %	A	A	A	289	161
d2-02	Frequency Reference Lower Limit	Sets the frequency reference lower limit as a percentage of maximum output frequency (E1-04). Output speed is limited to this value even if the frequency reference is lower. This limit applies to all frequency reference sources.	0.0 to 110.0	0.0%	A	A	A	28A	161
d2-03	Master Speed Reference Lower Limit	Sets the minimum frequency reference lower limit if the frequency reference is input using an analog input. Set as a percentage of maximum output frequency (E1-04). The higher of both values d2-02 and d2-03 will be the lower limit.	0.0 to 110.0	0.0%	A	A	A	293	162
d3: Jump Frequency Use d3 parameters to configure the drive Jump Frequency settings.									
d3-01	Jump Frequency 1	d3-01 to d3-04 allow programming of three prohibited frequency reference points for eliminating problems with resonant vibration of the motor / machine. This feature does not eliminate the selected frequency values, but accelerates and decelerates the motor through the prohibited bandwidth. The parameters must be according to the rule d3-01 ≥ d3-02 ≥ d3-03.	0.0 to 400.0	0.0 Hz	A	A	A	294	162
d3-02	Jump Frequency 2			0.0 Hz	A	A	A	295	162
d3-03	Jump Frequency 3			0.0 Hz	A	A	A	296	162
d3-04	Jump Frequency Width	This parameter sets the dead-band width around each selected prohibited frequency reference point. The bandwidth becomes the designated Jump frequency, plus or minus d3-04.	0.0 to 20.0	1.0 Hz	A	A	A	297	162
d4: Frequency Reference Hold Use d4 parameters to configure the drive frequency reference hold function.									

B.2 Parameter Table

No.	Name	Description	Range	Def.	Control Mode			Addr. Hex	Pg.
					V/f	OLV	PM		
d4-01	Frequency Reference Hold Function Selection	Determines if the frequency reference or frequency reference bias is saved when the Run command is removed or the power goes off. 0: Disabled 1: Enabled This parameter is effective when the multi-function inputs "Accel/Decel Ramp Hold", "Up/Down" or "Up/Down 2" commands are selected (H1-□□ = A or 10/11 or 75/76).	0, 1	0	A	A	A	298	162
d4-03 <1>	Frequency Reference Bias Step (Up/Down 2)	Sets the bias added to the frequency reference when the Up/Down 2 digital inputs are set. When set to 0.00 Hz, the bias value is increased or decreased according to d4-04. When greater than 0.0 Hz, the bias value d4-03 is added or subtracted to/from the frequency reference. The acceleration or deceleration rate is ultimately determined by d4-04.	0.00 to 99.99 Hz	0.00 Hz	A	A	A	2AA	165
d4-04 <1>	Frequency Reference Bias Accel/Decel (Up/Down 2)	Selects how the bias or frequency reference is increased when using the Up/Down 2 function. 0: Use selected accel/decel time. 1: Use Accel/Decel Time 4 (C1-07 and C1-08).	0, 1	0	A	A	A	2AB	165
d4-05 <1>	Frequency Reference Bias Operation Mode Selection (Up/Down 2)	0: Bias value is held if no input Up 2 or Down 2 is active. 1: When the Up 2 reference and Down 2 reference are both on or both off, the applied bias becomes 0. Currently selected accel / decel. times are used. Enabled only when d4-03 = 0.	0, 1	0	A	A	A	2AC	166
d4-06	Frequency Reference Bias (Up/Down 2)	The Up/Down 2 bias value is saved in d4-06 when the frequency reference is not input by the digital operator. The function depends on the setting of d4-01. It is limited by d4-08 and d4-09.	-99.9 to +100.0	0.0%	A	A	A	2AD	166
d4-07 <1>	Analog Frequency Reference Fluctuation Limit (Up/Down 2)	When an Up 2 or Down 2 input is active and the frequency reference value from analog or pulse input changes for more than the level set in d4-07, the bias value is hold and the frequency reference is changed to the new value. After the speed reaches the frequency reference the bias hold is released.	0.1 to +100.0	1.0%	A	A	A	2AE	166
d4-08 <1>	Frequency Reference Bias Upper Limit (Up/Down 2)	Sets the upper limit for the bias and the value that can be saved in d4-06. Set as a percentage of the maximum output frequency E1-04.	0.1 to 100.0	<4>	A	A	A	2AF	166
d4-09 <1>	Frequency Reference Bias Lower Limit (Up/Down 2)	Sets the lower limit for the bias and the value that can be saved in d4-06. Set as a percentage of the maximum output frequency E1-04.	-99.9 to 0.0	0.0%	A	A	A	2B0	167
d4-10	Up/Down Frequency Reference Limit Selection	Selects which value is used as frequency reference lower limit if the Up/Down function is used. 0: The lower limit is determined by d2-02 or analog input (H3-02/10 = 0). The higher of both values becomes the reference limit. 1: The lower limit is determined by d2-02.	0 or 1	0	A	A	A	2B6	167
d7: Offset Frequency Use d7 parameters to set the offset frequency.									
d7-01 <1>	Offset Frequency 1	Added to the frequency reference when the digital input "Frequency Offset 1" (H1-□□ = 44) is switched on.	-100.0 to +100.0	0.0%	A	A	A	2B2	167
d7-02 <1>	Offset Frequency 2	Added to the frequency reference when the digital input "Frequency Offset 2" (H1-□□ = 45) is switched on.	-100.0 to +100.0	0.0%	A	A	A	2B3	167
d7-03 <1>	Offset Frequency 3	Added to the frequency reference when the digital input "Frequency Offset 3" (H1-□□ = 46) is switched on.	-100.0 to +100.0	0.0%	A	A	A	2B4	167

<1> Parameter can be changed during Run.

<2> Default setting value is dependent on parameter o1-03, Digital Operator Display Selection.

<3> Range upper limit is dependent on parameters E1-04, Maximum Output Frequency, and d2-01, Frequency Reference Upper Limit.

<4> Default setting is determined by the drive software version.

PRG: 1016 and later: 100.00%

PRG: 1015 and earlier: 0.00 %

◆ E: Motor Parameters

No.	Name	Description	Range	Def.	Control Mode			Addr. Hex	Pg.
					V/f	O LV	PM		
E1: V/f Pattern Characteristics Use E1 parameters to set V/f characteristics for the motor.									
E1-01 </>	Input Voltage Setting	This parameter must be set to the power supply voltage. It sets the maximum and base voltage used by preset V/f patterns (E1-03 = 0 to E) and adjusts levels used by certain functions. WARNING! Electrical Shock Hazard. Drive input voltage (not motor voltage) must be set in E1-01 for the protective features of the drive to function properly. Failure to do so may result in equipment damage and/or death or personal injury.	155 to 255	230 V	S	S	S	300	169
E1-03 </>	V/f Pattern Selection	Selects a preset V/f pattern. 0: 50 Hz Constant torque 1 1: 60 Hz Constant torque 2 2: 60 Hz Constant torque 3 (50 Hz base) 3: 72 Hz Constant torque 4 (60 Hz base) 4: 50 Hz Variable torque 1 5: 50 Hz Variable torque 2 6: 60 Hz Variable torque 3 7: 60 Hz Variable torque 4 8: 50 Hz High starting torque 1 9: 50 Hz High starting torque 2 A: 60 Hz High starting torque 3 B: 60 Hz High starting torque 4 C: 90 Hz (60 Hz base) D: 120 Hz (60 Hz base) E: 180 Hz (60 Hz base) F: Custom V/f. E1-04 through E1-13 settings define the V/f pattern	0 to F	F	A	A	-	302	169
E1-04	Maximum Output Frequency	E1-04 and E1-06 to E1-13 can only be changed when E1-03 is set to F. To set linear V/f characteristics, set the same values for E1-07 and E1-09. In this case, the setting for E1-08 will be disregarded. When E1-13 = 0.0 V, then the drive uses the value set to E1-05 to control the voltage level. Ensure that the five frequencies are set according to these rules to prevent triggering an oPE10 fault: E1-09 ≤ E1-07 < E1-06 ≤ E1-11 ≤ E1-04 Note: Setting E1-11 to 0 disables both E1-11 and E1-12, and the above conditions do not apply.	40.0 to 400.0 </>	60 Hz </>	S	S	S	303	172
E1-05 </>	Maximum Output Voltage		0.0 to 255.0	230 V </>	S	S	S	304	172
E1-06	Base Frequency		0.0 to E1-04 </>	60 Hz </>	S	S	S	305	172
E1-07	Middle Output Frequency		0.0 to E1-04 </>	3.0 Hz </>	A	A	-	306	172
E1-08 </>	Middle Output Frequency Voltage		0.0 to 255.0 </>	18.4 V </>	A	A	-	307	172
E1-09	Minimum Output Frequency		0.0 to E1-04 </>	1.5 Hz </>	S	S	S	308	172
E1-10 </>	Minimum Output Frequency Voltage		0.0 to 255.0 </>	13.8 V </>	A	A	-	309	172
E1-11	Middle Output Frequency 2		0.0 to E1-04 </>	0.0 Hz	A	A	-	30A	172
E1-12 </> </>	Middle Output Frequency Voltage 2		0.0 to 255.0 </>	0.0 V	A	A	-	30B	172
E1-13 </> </>	Base Voltage		0.0 to 255.0 </>	0.0 V	A	S	-	30C	172
E2: Motor Parameters Use E2 parameters to set motor-related data.									
E2-01 </>	Motor Rated Current	Sets the motor nameplate full load current in amperes (A). Automatically set during Auto-Tuning. Note: Set E2-03 (Motor No-Load Current) before making changes to E2-01. An oPE01 error will be triggered if E2-01 < E2-03.	10 to 200% of drive rated current </>	</>	S	S	-	30E	173
E2-02	Motor Rated Slip	Sets the motor rated slip in Hertz. Automatically set during rotational Auto-Tuning.	0.00 to 20.00	</>	A	A	-	30F	173

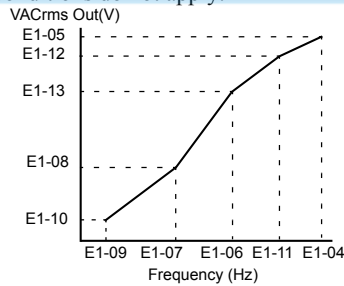

Parameter List

B

B.2 Parameter Table

No.	Name	Description	Range	Def.	Control Mode			Addr. Hex	Pg.
					V/f	O LV	PM		
E2-03	Motor No-Load Current	Sets the magnetizing current of the motor in Ampere. Automatically set during rotational Auto-Tuning. Note: Set E2-03 (Motor No-Load Current) before making changes to E2-01. An oPE01 error will be triggered if E2-01 < E2-03.	0 to less than E2-01	<10>	A	A	–	310	173
E2-04	Number of Motor Poles	Sets the number of motor poles. Automatically set during Auto-Tuning.	2 to 48	4 poles	A	A	–	311	173
E2-05	Motor Line-to-Line Resistance	Sets the phase-to-phase motor resistance in ohms. Automatically set during Auto-Tuning.	0.000 to 65.000 <11>	<10>	A	A	–	312	173
E2-06	Motor Leakage Inductance	Sets the voltage drop due to motor leakage inductance as a percentage of motor rated voltage. Automatically set during Auto-Tuning.	0.0 to 40.0	<10>	A	A	–	313	174
E2-07	Motor Iron-Core Saturation Coefficient 1	Sets the motor iron saturation coefficient at 50% of magnetic flux. Automatically set during Auto-Tuning.	0.00 to 0.50	0.50	–	A	–	314	174
E2-08	Motor Iron-Core Saturation Coefficient 2	Sets the motor iron saturation coefficient at 75% of magnetic flux. Automatically set during Auto-Tuning.	E2-07 to 0.75	0.75	–	A	–	315	174
E2-09	Motor Mechanical Loss	Sets the motor mechanical loss as a percentage of motor rated power (kW). Adjust in the following circumstances: When there is a large amount of torque loss due to motor bearing friction. When there is a large amount of torque loss.	0.0 to 10.0	0.0%	–	A	–	316	174
E2-10	Motor Iron Loss for Torque Compensation	Sets the motor iron loss in watts (W).	0 to 65535	<10>	A	–	–	317	174
E2-11	Motor Rated Output	Sets the motor rated power in kilowatts (kW). Automatically set during Auto-Tuning. (1 HP = 0.746 kW).	0.00 to 650.00	0.40 kW <6>	S	S	–	318	174
E2-12	Motor Iron-Core Saturation Coefficient 3	Set to the motor iron saturation coefficient at 130% of magnetic flux. Automatically set during rotational Auto-Tuning.	1.30 to 5.00	1.30	–	A	–	328	174
E3: Motor 2 V/f Characteristics									
Use E3 parameters to set the V/f pattern for a second motor.									
E3-01	Motor 2 Control Method	0: V/f Control 2: Open Loop Vector (OLV)	0 or 2	0	A	A	–	319	175

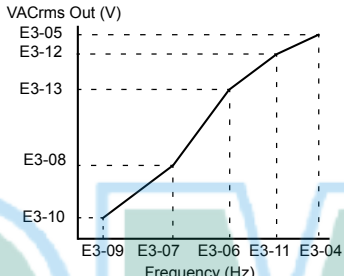
No.	Name	Description	Range	Def.	Control Mode			Addr. Hex	Pg.
					V/f	O LV	PM		
E3-04	Motor 2 Max Output Frequency	<p>To set linear V/f characteristics, set the same values for E3-07 and E3-09. In this case, the setting for E3-08 will be disregarded.</p> <p>Ensure that the five frequencies are set according to these rules to prevent triggering an oPE10 fault: $E3-09 \leq E3-07 < E3-06 \leq E3-11 \leq E3-04$</p> <p>Note: Setting E3-11 to 0 disables both E3-11 and E3-12, and the above conditions do not apply.</p> 	40.0 to 400.0	60 Hz	A	A	-	31A	175
E3-05 </>	Motor 2 Max Voltage		0.0 to 255.0	230.0 V	A	A	-	31B	175
E3-06	Motor 2 Base Frequency		0.0 to E3-04	60 Hz	A	A	-	31C	175
E3-07	Motor 2 Mid Output Freq.		0.0 to E3-04	3.0 Hz <12>	A	A	-	31D	175
E3-08 </>	Motor 2 Mid Output Freq. Voltage		0.0 to 255.0	18.4 V <6> <12>	A	A	-	31E	175
E3-09	Motor 2 Min. Output Freq.		0.0 to E3-04	1.5 Hz <12>	A	A	-	31F	175
E3-10 </>	Motor 2 Min. Output Freq. Voltage		0.0 to 255.0	13.8 V <6> <12>	A	A	-	320	175
E3-11 </>	Motor 2 Mid Output Frequency 2		0.0 to E3-04	0.0 Hz	A	A	-	345	175
E3-12 </> <13>	Motor 2 Mid Output Frequency Voltage 2		0.0 to 255.0 </>	0.0 Vac	A	A	-	346	175
E3-13 </> <9>	Motor 2 Base Voltage		0.0 to 255.0 </>	0.0 Vac	A	S	-	347	175
E4: Motor 2 Parameters Use E4 parameters to control a second motor operating on the same drive.									
E4-01	Motor 2 Rated Current	Sets the motor 2 nameplate full load current in amperes (A). This value is automatically set during Auto-Tuning.	10 to 200% of drive rated current	<10>	A	A	-	321	176
E4-02	Motor 2 Rated Slip	Sets the motor 2 rated slip in Hz. Automatically set during Auto-Tuning.	0.00 to 20.00	<10>	A	A	-	322	176
E4-03	Motor 2 Rated No-Load Current	Sets the magnetizing current of motor 2 in Ampere. Automatically set during Rotational Auto-Tuning.	0 to less than E4-01	<10> <9>	A	A	-	323	176
E4-04	Motor 2 Motor Poles	Sets the number of poles of motor 2. This value is automatically set during Auto-Tuning.	2 to 48	4 poles	A	A	-	324	176
E4-05	Motor 2 Line-to-Line Resistance	Sets the phase-to-phase resistance of motor 2 in ohms. Automatically during Auto-Tuning.	0.000 to 65.000 <11>	<10>	A	A	-	325	176
E4-06	Motor 2 Leakage Inductance	Sets the voltage drop due to motor leakage inductance as a percentage of rated voltage of motor 2. Automatically set during Auto-Tuning.	0.0 to 40.0	<10>	A	A	-	326	176
E4-07	Motor 2 Motor Iron-Core Saturation Coefficient 1	Set to the motor iron saturation coefficient at 50% of magnetic flux. Automatically set during Rotational Auto-Tuning.	0.00 to 0.50	0.50	-	A	-	343	177
E4-08	Motor 2 Motor Iron-Core Saturation Coefficient 2	Set to the motor iron saturation coefficient at 75% of magnetic flux. This value is automatically set during Rotational Auto-Tuning.	Setting for E4-07 to 0.75	0.75	-	A	-	344	177
E4-09	Motor 2 Mechanical Loss	Sets the motor mechanical loss as a percentage of motor rated power (kW) capacity. Adjust in the following circumstances: • When there is a large amount of torque loss due to motor bearing friction. • When there is a large amount of torque loss.	0.00 to 10.0	0.0	-	A	-	33F	177
E4-10	Motor 2 Iron Loss	Sets the motor iron loss in watts.	0 to 65535	<10>	A	-	-	340	177
E4-11	Motor 2 Rated Capacity	Sets the motor rated capacity in kW. Automatically set during Auto-Tuning.	0.00 to 650.00	<6>	A	A	-	327	177

B.2 Parameter Table

No.	Name	Description	Range	Def.	Control Mode			Addr. Hex	Pg.
					V/f	O LV	PM		
E4-12	Motor 2 Iron-Core Saturation Coefficient 3	Set to the motor iron saturation coefficient at 130% of magnetic flux. Automatically set during Rotational Auto-Tuning.	1.30 to 5.00	1.30	-	A	-	342	177
E4-14 <14>	Motor 2 Slip Compensation Gain	Sets the slip compensation gain for motor 2. The function is the same as C3-01 for motor 1. <i>Refer to C3-01: Slip Compensation Gain on page 151.</i>	0.0 to 2.5	0.0 <12>	A	A	-	341	177
E4-15	Torque Compensation Gain - Motor 2	Sets the torque compensation gain for motor 2. The function is the same as C4-01 for motor 1. <i>Refer to C4-01: Torque Compensation Gain on page 152.</i>	1.00 to 2.50	1.00	A	A	-	341	177
E5: PM Motor Parameters									
E5-01 <2>	Motor Code Selection (for PM motor)	<p>Enter the Yaskawa motor code for the PM motor being used. Various motor parameters are automatically set based on the value of this parameter.</p> <p>Note: Set to FFFF when using a specialized, custom, or non-Yaskawa motor. For all other motors:</p> <div style="text-align: center;"> <p>0: Pico Motor (SMRA Series) 1: Derated Torque for IPM Motors (SSR 1 Series) 2: 1800 r/min Series 3: 1750 r/min Series 4: 1150 r/min Series F: Special Motor</p> </div> <p>All motor parameters are reinitialized to factory settings when this parameter is set.</p>	0000 to FFFF	<6> <15>	-	-	S	329	178
E5-02 <2>	Motor Rated Capacity (for PM motor)	Sets the rated capacity of the motor.	0.10 to 18.50	<4>	-	-	S	32A	178
E5-03 <2>	Motor Rated Current	Sets the motor rated current in amps.	10 to 200% of drive rated current <9>	<16>	-	-	S	32B	178
E5-04 <2>	Motor Poles	Sets the number of motor poles.	2 to 48	<4>	-	-	S	32C	178
E5-05 <2>	Motor Stator Resistance	Set the resistance for each motor phase in units of 0.001 Ω.	0.000 to 65.000	<4>	-	-	S	32D	179
E5-06 <2>	Motor d Axis Inductance	Sets the d axis inductance in units of 0.01 mH.	0.00 to 300.00	<4>	-	-	S	32E	179
E5-07 <2>	Motor q Axis Inductance	Sets the q axis inductance in units of 0.01 mH.	0.00 to 600.00	<4>	-	-	S	32F	179
E5-09 <2>	Motor Induction Voltage Constant 1	Set the induced phase peak voltage in units of 0.1 mV (rad/s) [electrical angle]. Set this parameter when using a Yaskawa SSR1 series PM motor with derate torque, or a Yaskawa SST4 series motor with constant torque. When setting this parameter, E5-24 should be set to 0. An alarm will be triggered if both E5-09 and E5-24 are set to 0, or if neither parameter is set to 0.	0.0 to 2000.0	<4>	-	-	S	331	179
E5-24 <2>	Motor Induction Voltage Constant 2	Set the induced phase-to-phase rms voltage in units of 0.1 mV/(r/min) [mechanical angle]. Set this parameter when using a Yaskawa SMRA Series SPM Motor. When setting this parameter, E5-09 should be set to 0. An alarm will be triggered if both E5-09 and E5-24 are set to 0, or if neither parameter is set to 0. If E5-03 (Motor Rated Current) is set to 0, however, then an alarm will not be triggered when both E5-09 and E5-24 are set to 0.	<17>	<4>	-	-	S	353	179
E5-39 <18>	Current Detection Delay Time	Sets the current detection delay time at the time of d-Axis and q-Axis current feedback calculation. Changing this parameter from the default setting is not normally required.	-1000 to 1000	0 μs	A	A	A	5E2	179

<1> Values shown here are for 200 V class drives. Double the value when using a 400 V class drive.

- <2> Parameter setting value is not reset to the default value during drive initialization, A1-03 = 1110, 2220, 3330.
- <3> Range upper limit is dependent on parameter E4-01 Motor 2 Rated Current.
- <4> Default setting value is dependent on parameter E5-01, Motor Code Selection.
- <5> Default setting value is dependent on parameter A1-02, Control Method Selection. The value shown is for A1-02 = 0-V/f Control.
- <6> Default setting value is dependent on parameter o2-04, Drive Model Selection.
- <7> Parameter ignored when E1-11, Motor 1 Mid Output Frequency 2, and E1-12, Motor 1 Mid Output Frequency Voltage 2, are set to 0.0.
- <8> When setting motor parameters, the motor rated current must be set to a value greater than the motor no-load current (E2-01 > E2-03).
- <9> Display is in the following units: BA0001 to BA0018, 2A0001 to 2A0040, and 4A0001 to 4A0023: 0.01 A units.
2A0056 to 2A0069, 4A0031 to 4A0038: 0.1 A units.
- <10> Default setting value is dependent on parameter o2-04, Drive Model Selection and C6-01, Drive Duty Selection.
- <11> Setting range becomes 0.00 to 130.00 for drives 0.2 kW and smaller.
- <12> Default setting depends on the control mode for motor 2 set in parameter E3-01. The given value is for V/f Control.
- <13> Parameter ignored when E3-11, Motor 2 Mid Output Frequency 2, and E3-12, Motor 2 Mid Output Frequency Voltage 2, are set to 0.
- <14> Parameter can be changed during Run.
- <15> If using a Yaskawa SMRA Series SPM Motor, the default setting is 1800 r/min.
- <16> Default setting value is dependent on parameter A1-06. This setting value is 0 when A1-06 = 0, and 1 when A1-06 ≠ 0.
- <17> Default setting is determined by drive software version.
PRG: 1018 and later: 0.0 to 6500.0 mV/(r/min)
PRG: 1017 and earlier: 0.0 to 2000.0 mV/(r/min)
- <18> Available in drive software versions PRG: 1022 and later.

◆ F: Options

F parameters are used to program the drive for PG feedback and to function with option cards.

No.	Name	Description	Range	Def.	Control Mode			Addr. Hex	Pg.
					V/f	OLV	PM		
F1: V/f Control with Simple PG Feedback - PG Setup Parameters Use F1 parameters to set up the drive for V/f Control with Simple PG Feedback. These parameters are enabled only when H6-01 = 03									
F1-02	Operation Selection at PG Open Circuit (PGo)	Sets stopping method when a PG open circuit fault (PGo) occurs. Refer to parameter F1-14. 0: Ramp to Stop - Decelerate to stop using the active deceleration time. 1: Coast to Stop 2: Fast-stop - Decelerate to stop using the deceleration time in C1-09. 3: Alarm only - Drive continues operation.	0 to 3	1	A	-	-	381	181
F1-03	Operation Selection at Overspeed (oS)	Sets the stopping method when an overspeed (oS) fault occurs. Refer to F1-08 and F1-09. 0: Ramp to stop - Decelerate to stop using the active deceleration time. 1: Coast to stop 2: Fast-stop - Decelerate to stop using the deceleration time in C1-09. 3: Alarm Only - Drive continues operation.	0 to 3	1	A	-	-	382	181
F1-04	Operation Selection at Deviation	Sets the stopping method when a speed deviation (dEv) fault occurs. Refer to F1-10 and F1-11. 0: Ramp to stop - Decelerate to stop using the active deceleration time. 1: Coast to stop 2: Fast-stop - Decelerate to stop using the deceleration time in C1-09. 3: Alarm only - Drive continues operation.	0 to 3	3	A	-	-	383	181
F1-08	Overspeed Detection Level	Sets the speed feedback level which has to be exceeded for the time set in F1-09 before an oS fault will occur. Set as a percentage of the maximum output frequency (E1-04).	0 to 120	115%	A	-	-	387	181
F1-09	Overspeed Detection Delay Time	Sets the time in seconds for which the speed feedback has to exceed the overspeed detection level F1-08 before an oS fault will occur.	0.0 to 2.0	1.0	A	-	-	388	181

Parameter List

B

B.2 Parameter Table

No.	Name	Description	Range	Def.	Control Mode			Addr. Hex	Pg.
					V/f	OLV	PM		
F1-10	Excessive Speed Deviation Detection Level	Sets the allowable deviation between motor speed and frequency reference before a speed deviation fault (dEv) is triggered. Set as a percentage of the maximum output frequency (E1-04).	0 to 50	10%	A	–	–	389	181
F1-11	Excessive Speed Deviation Detection Delay Time	Sets the time in seconds for which a deviation between motor speed and frequency reference has to exceed the speed deviation detection level F1-10 before a dEv fault will occur.	0.0 to 10.0	0.5 s	A	–	–	38A	181
F1-14	PG Open-Circuit Detection Time	Sets the time for which no PG pulses must be detected before a PG Open (PGo) fault is triggered.	0.0 to 10.0	2.0 s	A	–	–	38D	182
F6: Serial Communications Option Card Settings Use F6 parameters to program the drive for serial communication.									
F6-01	Communications Error operation Selection	Selects the operation after a communications error occurred. 0: Ramp to stop using current accel/decel time 1: Coast to stop 2: Fast-stop using C1-09 3: Alarm only 4: Alarm and Run at d1-04 <9> <10> 5: Alarm and Ramp to stop <9>	0 to 5	1	A	A	A	3A2	182
F6-02	External fault from comm. option selection	Sets when an external fault from a comm option is detected. 0: Always detected 1: Detection during Run only	0, 1	0	A	A	A	3A3	182
F6-03	External fault from comm. option operation selection	Selects the operation after an external fault set by a communications option (EF0). 0: Ramp to stop using current accel/decel time 1: Coast to stop 2: Fast-stop using C1-09 3: Alarm only	0 to 3	1	A	A	A	3A4	182
F6-04	Bus Error Detection Time	Set the delay time for error detection if a bus error occurs.	0.0 to 5.0	2.0 s	A	A	A	3A5	–
F6-07 <6>	NetRef/ComRef Function Selection	0: Multi-step reference disabled (same as F7) 1: Multi-step reference enabled (same as V7)	0, 1	0	A	A	A	3A8	182
F6-08 <6>	Reset Communication Parameters	0: Communication-related parameters (F6-□□ and F7-□□) are not reset when the drive is initialized using A1-03. 1: Reset all communication-related parameters (F6-□□ and F7-□□) when the drive is initialized using A1-03.	0, 1	0 <7>	A	A	A	36A	183
F6-10	CC-Link Node Address	Sets the node address if a CC-Link option card is installed.	0 to 63	0	A	A	A	3E6	–
F6-11	CC-Link communications speed	0: 156 Kbps 1: 625 Kbps 2: 2.5 Mbps 3: 5 Mbps 4: 10 Mbps	0 to 4	0	A	A	A	3E7	–
F6-14	BUS Error Auto Reset	Selects if a BUS fault can be automatically reset. 0: Disabled 1: Enabled	0, 1	0	A	A	A	3BB	–
F6-20 <7>	MECHATROLINK Station Address	Sets the station address when the MECHATROLINK option has been installed.	<8>	21	A	A	A	36B	–
F6-21 <7>	MECHATROLINK Frame Size	MECHATROLINK-II 0: 32 byte 1: 17 byte MECHATROLINK-III 0: 64 byte 1: 32 byte	0, 1	0	A	A	A	36C	–
F6-22 <7>	MECHATROLINK Link Speed	0: 10 Mbps 1: 4 Mbps Note: Available only for MECHATROLINK-II.	0, 1	0	A	A	A	36D	–
F6-23 <7>	MECHATROLINK Monitor Selection (E)	Sets the MECHATROLINK monitor (E).	0 to FFFFH	0	A	A	A	36E	–
F6-24 <7>	MECHATROLINK Monitor Selection (F)	Sets the MECHATROLINK monitor (F).	0 to FFFFH	0	A	A	A	36F	–

No.	Name	Description	Range	Def.	Control Mode			Addr. Hex	Pg.
					V/f	OLV	PM		
F6-25 ↔	Operation Selection at MECHATROLINK Watchdog Timer Error (E5)	0: Ramp to stop. Decelerate using the deceleration time in C1-02. 1: Coast to stop 2: Fast stop. Decelerate using the deceleration time in C1-09. 3: Alarm only	0 to 3	1	A	A	A	3C9	–
F6-26 ↔	MECHATROLINK bUS Errors Detected	Sets the number of option communication errors (bUS).	2 to 10	2	A	A	A	3CA	–
F6-30	PROFIBUS node address	Sets the node address for a PROFIBUS option.	0 to 125	0	A	A	A	3CB	–
F6-31	PROFIBUS Clear Mode Selection	Selects the operation when a "Clear Mode" command is received. 0: Resets drive operation. 1: Maintains the previous operation state.	0, 1	0	A	A	A	3CC	–
F6-32	PROFIBUS Data Format Selections	0: PPO Type 1: Conventional	0, 1	0	A	A	A	3CD	–
F6-35	CANopen Node ID selection	Sets the Node ID for a CANopen option	↔	99	A	A	A	3D0	–
F6-36	CANopen Communications speed	0: Auto-adjust 1: 10 kbps 2: 20 kbps 3: 50 kbps 4: 125 kbps 5: 250 kbps 6: 500 kbps 7: 800 kbps 8: 1 Mbps	0 to 8	6	A	A	A	3D1	–
F6-40	CompoNet Node ID	Sets the Node ID for a CompoNet option.	0 to 63	0	A	A	A	3D5	–
F6-41	CompoNet Speed	0: 93.75 kbps 1: Reserved 2: 1.5 Mbps 3: 3 Mbps 4: 4 Mbps 5-255: Reserved	0 to 255	0	A	A	A	3D6	–
F6-50 ↔	DeviceNet MAC Address	Selects the drives MAC address for DeviceNet.	0 to 64	64	A	A	A	3C1	–
F6-51 ↔	Device Net Communications Speed	0: 125 kbps 1: 250 kbps 2: 500 kbps 3: Adjustable from Network 4: Detect automatically	0 to 4	4	A	A	A	3C2	–
F6-52 ↔	DeviceNet PCA setting	I/O Polled Consuming Assembly Data Instance	0 to 255	21	A	A	A	3C3	–
F6-53 ↔	DeviceNet PPA setting	I/O Polled Producing Assembly Data Instance	0 to 255	71	A	A	A	3C4	–
F6-54 ↔	DeviceNet Idle Mode Fault Detection	Selects if an EF0 fault is detected when no data are received from the master. ↔ 0: Detection enabled 1: No detection	0, 1	0	A	A	A	3C5	–
F6-55	DeviceNet Baud Rate Monitor	Verifies the baud rate running on the network. 0: 125 kbps 1: 250 kbps 2: 500 kbps	0 to 2	0	A	A	A	3C6	–
F6-56 ↔	DeviceNet Speed Scaling Factor	Sets the scaling factor for the speed monitor in DeviceNet Class ID 2AH Object.	-15 to 15	0	A	A	A	3D7	–
F6-57 ↔	DeviceNet Current Scaling Factor	Sets the scaling factor for the output current monitor in DeviceNet Class ID 2AH Object.	-15 to 15	0	A	A	A	3D8	–
F6-58 ↔	DeviceNet Torque Scaling Factor	Sets the scaling factor for the torque monitor in DeviceNet Class ID 2AH Object.	-15 to 15	0	A	A	A	3D9	–
F6-59 ↔	DeviceNet Power Scaling Factor	Sets the scaling factor for the power monitor in DeviceNet Class ID 2AH Object.	-15 to 15	0	A	A	A	3DA	–

B.2 Parameter Table

No.	Name	Description	Range	Def.	Control Mode			Addr. Hex	Pg.
					V/f	OLV	PM		
F6-60 <3>	DeviceNet Voltage Scaling Factor	Sets the scaling factor for the voltage monitor in DeviceNet Class ID 2AH Object.	-15 to 15	0	A	A	A	3DB	-
F6-61 <3>	DeviceNet Time Scaling Factor	Sets the scaling factor for the time monitor in DeviceNet Class ID 2AH Object.	-15 to 15	0	A	A	A	3DC	-
F6-62 <3>	DeviceNet Heartbeat Interval	Sets the heartbeat interval for DeviceNet communications.	0 to 10	0	A	A	A	3DD	-
F6-63	Dynamic Output Assembly 109 Parameter 1 <5>	Dynamic Output Assembly 109 Parameter 1	0x0 to 0xFFFF	0	A	A	A	3DE	-
	MAC ID Memory <6>	Sets the MAC ID memory (Read only)	0 to 63	-	A	A	A	3DE	-
F6-64	Dynamic Output Assembly 109 Parameter 2 <5>	Dynamic Output Assembly 109 Parameter 2	0x0 to 0xFFFF	0	A	A	A	3DF	-
	Dynamic Output Assembly 109 Parameter 1 <6>	Dynamic Output Assembly 109 Parameter 1	0x0 to 0xFFFF	0	A	A	A	3DF	-
F6-65	Dynamic Output Assembly 109 Parameter 3 <5>	Dynamic Output Assembly 109 Parameter 3	0x0 to 0xFFFF	0	A	A	A	3E0	-
	Dynamic Output Assembly 109 Parameter 2 <6>	Dynamic Output Assembly 109 Parameter 2	0x0 to 0xFFFF	0	A	A	A	3E0	-
F6-66	Dynamic Output Assembly 109 Parameter 4 <5>	Dynamic Output Assembly 109 Parameter 4	0x0 to 0xFFFF	0	A	A	A	3E1	-
	Dynamic Output Assembly 109 Parameter 3 <6>	Dynamic Output Assembly 109 Parameter 3	0x0 to 0xFFFF	0	A	A	A	3E1	-
F6-67	Dynamic Output Assembly 159 Parameter 1 <5>	Dynamic Output Assembly 159 Parameter 1	0x0 to 0xFFFF	0	A	A	A	3E2	-
	Dynamic Output Assembly 109 Parameter 4 <6>	Dynamic Output Assembly 109 Parameter 4	0x0 to 0xFFFF	0	A	A	A	3E2	-
F6-68	Dynamic Output Assembly 159 Parameter 2 <5>	Dynamic Output Assembly 159 Parameter 2	0x0 to 0xFFFF	0	A	A	A	3E3	-
	Dynamic Output Assembly 159 Parameter 1 <6>	Dynamic Output Assembly 159 Parameter 1	0x0 to 0xFFFF	0	A	A	A	3E3	-
F6-69	Dynamic Output Assembly 159 Parameter 3 <5>	Dynamic Output Assembly 159 Parameter 3	0x0 to 0xFFFF	0	A	A	A	3E4	-
	Dynamic Output Assembly 159 Parameter 2 <6>	Dynamic Output Assembly 159 Parameter 2	0x0 to 0xFFFF	0	A	A	A	3E4	-
F6-70	Dynamic Output Assembly 159 Parameter 4 <5>	Dynamic Output Assembly 159 Parameter 4	0x0 to 0xFFFF	0	A	A	A	3C7	-
	Dynamic Output Assembly 159 Parameter 3 <6>	Dynamic Output Assembly 159 Parameter 3	0x0 to 0xFFFF	0	A	A	A	3C7	-
F6-71 <6>	Dynamic Output Assembly 159 Parameter 4	Dynamic Output Assembly 159 Parameter 4	0x0 to 0xFFFF	0	A	A	A	3C8	-
F7: EtherNet/IP and Modbus TCP/IP Option Parameters Use F7 parameters to program the drive for EtherNet communication.									

No.	Name	Description	Range	Def.	Control Mode			Addr. Hex	Pg.
					V/f	OLV	PM		
F7-01 to F7-42	EtherNet/IP and Modbus TCP/IP Option Parameters	F7 parameters are reserved for use with SI-EN3/V and SI-EM3/V options. Refer to the respective Option Installation Manuals for details.	–	–	–	–	–	–	

- <1> Parameter setting value is not reset to the default value during drive initialization, A1-03 = 1110, 2220, 3330.
- <2> Setting range is determined by the drive software version.
PRG: 1016 and later: 0 to 126
PRG: 1015 and earlier: 0 to 127
- <3> Parameter available in drive software versions PRG: 1011 and later.
- <4> The following parameter settings apply to drive software versions 1015 and earlier:
0: Disabled
1: Enabled
- <5> Parameter available in drive software versions PRG: 1012 and later.
- <6> Parameter available in drive software versions PRG: 1014 and later.
- <7> Parameter available in drive software versions PRG: 1023 and later.
- <8> Setting range is determined by the option.
MECHATROLINK-II: 20H to 3FH
MECHATROLINK-III: 03H to EFH
- <9> Available in drive software version PRG: 1024 and later.
- <10> Take proper safety measures, such as installing an emergency stop switch, as the drive will continue operation when detecting an bUS error.

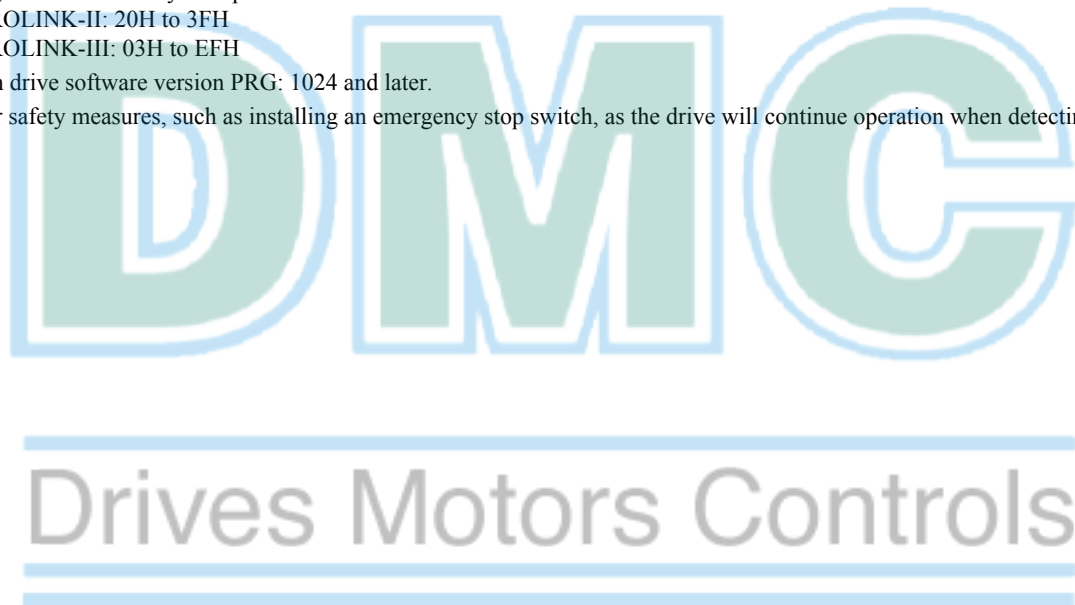

B.2 Parameter Table

◆ H Parameters: Multi-Function Terminals

H parameters assign functions to the multi-function input and output terminals.

No.	Name	Description	Range	Def.	Control Mode			Addr. Hex	Pg.
					V/f	OLV	PM		
H1: Multi-Function Digital Input									
H1 parameters to assign functions to the multi-function digital input terminals. Unused terminals should be set to "F".									
H1-01	Multi-Function Digital Input Terminal S1 Function Selection	Assigns a function to the multi-function digital inputs. Refer to H1 Multi-Function Digital Input Selections on page 376 for a description of setting values.	1 to 9F <1>	40	A	A	A	438	184
H1-02	Multi-Function Digital Input Terminal S2 Function Selection			41	A	A	A	439	184
H1-03	Multi-Function Digital Input Terminal S3 Function Selection			24	A	A	A	400	184
H1-04	Multi-Function Digital Input Terminal S4 Function Selection			14	A	A	A	401	184
H1-05	Multi-Function Digital Input Terminal S5 Function Selection			3 (0) <2>	A	A	A	402	184
H1-06	Multi-Function Digital Input Terminal S6 Function Selection			4 (3) <2>	A	A	A	403	184
H1-07	Multi-Function Digital Input Terminal S7 Function Selection			6 (4) <2>	A	A	A	404	184

<1> The availability of certain functions depends on the control method used.

<2> Parenthetical value is the default when parameter A1-03 = 3330 3-Wire Initialization.

H1 Multi-Function Digital Input Selections									
H1-□□ Setting	Function	Description	Control Mode			Pg.			
			V/f	OLV	PM				
0	3-Wire Sequence	Closed: Reverse rotation (only if the drive is set up for 3-Wire sequence)	O	O	O	185			
1	LOCAL/REMOTE Selection	Open: REMOTE, Reference 1 or 2 (b1-01/02 or b1-15/16) Closed: LOCAL, LED operator is run and reference source	O	O	O	185			
2	External Reference 1/2	Open: Run and frequency reference source 1 (b1-01/02) Closed: Run and frequency reference source 2 (b1-15/16)	O	O	O	186			
3	Multi-Step Speed Reference 1		O	O	O	186			
4	Multi-Step Speed Reference 2	Used to select Multi-Step Speeds set in d1-01 to d1-16	O	O	O	186			
5	Multi-Step Speed Reference 3		O	O	O	186			
6	Jog Reference Selection	Open: Selected speed reference Closed: Jog Frequency reference (d1-17). Jog has priority over all other reference sources.	O	O	O	186			
7	Accel/Decel Time 1	Used to switch between Accel/Decel. Time 1/2	O	O	O	186			
8	Baseblock Command (N.O.)	Open: Normal operation Closed: No drive output	O	O	O	186			
9	Baseblock Command (N.C.)	Open: No drive output Closed: Normal operation	O	O	O	186			
A	Accel/Decel Ramp Hold	Closed: The drive pauses during acceleration or deceleration and maintains the output frequency.	O	O	O	186			
B	Drive Overheat Alarm (oH2)	Closed: Closes when an oH2 alarm occurs.	O	O	O	187			
C	Terminal A1/A2 Enable	Terminal status differs depending on drive software version. PRG: 1016 and later: Open: Analog input selected by H3-14 is disabled. Closed: Analog input selected by H3-14 is enabled. PRG: 1015 and earlier: Open: Analog inputs selected for terminals A1 and A2 are disabled. Closed: Analog inputs selected for terminals A1 and A2 are enabled.	O	O	O	187			

H1 Multi-Function Digital Input Selections						
H1-□□ Setting	Function	Description	Control Mode			Pg.
			V/f	OLV	PM	
F	Not used	Select this setting when not using the terminal or when using the terminal in a pass-through mode.	0	0	0	187
10	Up Command	Open: Maintains the current frequency reference Closed: Increases or decreases the current frequency reference.	0	0	0	187
11	Down Command	Ensure that the increase and decrease commands are set in conjunction with one another.	0	0	0	187
12	Forward Jog	Closed: Runs forward at the Jog Frequency d1-17.	0	0	0	188
13	Reverse Jog	Closed: Runs reverse at the Jog Frequency d1-17.	0	0	0	188
14	Fault Reset	Closed: Resets faults if the cause is cleared and the Run command is removed.	0	0	0	188
15	Fast-Stop (N.O.)	Closed: Decelerates at the Fast-Stop time C1-09. To restart the Fast-Stop input must be released and Run must be cycled.	0	0	0	188
16	Motor 2 Selection	Open: Motor 1 (E1-□□, E2-□□) Closed: Motor 2 (E3-□□, E4-□□)	0	0	0	189
17	Fast-stop (N.C.)	Open: Decelerates according to C1-09 (Fast-stop Time)	0	0	0	188
18	Timer Function Input	Set the timer delay using parameters b4-01 and b4-02. Ensure this function is set in conjunction with the multi-function output timer (H2-□□ = 12).	0	0	0	189
19	PID Disable	Closed: PID control disabled	0	0	0	189
1A	Accel/Decel Time Selection 2	Switches Accel/Decel times.	0	0	0	189
1B	Program Lockout	Open: Parameters can not be edited. (except U1-01 if reference source is set for operator) Closed: Parameters may be edited and saved.	0	0	0	189
1E	Reference Sample Hold	Closed: Samples the analog frequency reference and operates the drive at that speed.	0	0	0	190
20 to 2F	External Fault	20: N.O., Always Detected, Ramp To Stop 21: N.C., Always Detected, Ramp To Stop 22: N.O., During Run, Ramp To Stop 23: N.C., During Run, Ramp To Stop 24: N.O., Always Detected, Coast To Stop 25: N.C., Always Detected, Coast To Stop 26: N.O., During Run, Coast To Stop 27: N.C., During Run, Coast To Stop 28: N.O., Always Detected, Fast-stop 29: N.C., Always Detected, Fast-stop 2A: N.O., During Run, Fast-stop 2B: N.C., During Run, Fast-stop 2C: N.O., Always Detected, Alarm Only (continue running) 2D: N.C., Always Detected, Alarm Only (continue running) 2E: N.O., During Run, Alarm Only (continue running) 2F: N.C., During Run, Alarm Only (continue running)	0	0	0	190
30	PID Integral Reset	Closed: Resets the PID control integral value.	0	0	0	191
31	PID Integral Hold	Closed: Maintains the current PID control integral value.	0	0	0	191
32	Multi-Step Speed Reference 4	Used to select Multi-Step Speeds set in d1-01 to d1-16	0	0	0	191
34	PID Soft Starter	Closed: Disables the PID soft starter b5-17.	0	0	0	191
35	PID Input Switch	Closed: Inverses the PID input signal	0	0	0	191
40	Forward Run Command (2-Wire sequence)	Open: Stop Closed: Forward run Note: Can not be set together with Settings 42 or 43.	0	0	0	191
41	Reverse Run Command (2-Wire sequence)	Open: Stop Closed: Reverse run Note: Can not be set together with Settings 42 or 43.	0	0	0	191
42	Run Command (2-Wire sequence 2)	Open: Stop Closed: Run Note: Can not be set together with Settings 40 or 41.	0	0	0	191
43	FWD/REV Command (2-Wire sequence 2)	Open: Forward Closed: Reverse Note: Can not be set together with Settings 40 or 41.	0	0	0	191

B.2 Parameter Table

H1 Multi-Function Digital Input Selections						
H1-□□ Setting	Function	Description	Control Mode			Pg.
			V/f	OLV	PM	
44	Offset Frequency 1 Addition	Closed: Adds d7-01 to the frequency reference.	O	O	O	192
45	Offset Frequency 2 Addition	Closed: Adds d7-02 to the frequency reference.	O	O	O	192
46	Offset Frequency 3 Addition	Closed: Adds d7-03 to the frequency reference.	O	O	O	192
47 <1>	Node Setup	Closed: Node setup for SI-S3/V enabled.	O	O	O	192
60	DC Injection Braking Command	Closed: Triggers DC Injection Braking (b2-02)	O	O	-	192
61	External Search Command 1	Closed: Activates Current Detection Speed Search from the max. output frequency (E1-04) if b3-01 = 0. Activates Speed Estimation Type Speed search if b3-01 = 0.	O	O	O	192
62	External Search Command 2	Closed: Activates Current Detection Speed Search from the frequency reference b3-01 = 0. Activates Speed Estimation Type Speed search if b3-01 = 0.	O	O	O	192
65	KEB Ride-Thru 1 (N.C.)	Open: KEB Ride-Thru 1 enabled Closed: Normal operation	O	O	O	192
66	KEB Ride-Thru 1 (N.O.)	Open: Normal operation Closed: KEB Ride-Thru 1 enabled	O	O	O	192
67	Communications Test Mode	Tests the MEMOBUS/Modbus RS-485/422 interface.	O	O	O	192
68	High-Slip Braking	Closed: High-Slip braking is executed. Drive stops.	O	-	-	192
6A	Drive Enable	Open: Drive disabled. If this input is opened during run, then the drive will stop as specified by parameter b1-03. Closed: Ready for operation.	O	O	O	192
75	Up 2 Command	Open: Maintains the current frequency reference. Closed: Increases or decreases the frequency reference.	O	O	O	193
76	Down 2 Command	UP 2 and Down 2 commands must be set in combination with each other. The frequency reference source must be assigned to the operator (b1-01 = "0").	O	O	O	193
7A	KEB Ride-Thru 2 (N.C.)	Open: KEB Ride-Thru 2 enabled Closed: Normal operation	O	O	O	194
7B	KEB Ride-Thru 2 (N.O.)	Open: Normal operation Closed: KEB Ride-Thru 2 enabled	O	O	O	194
7C	Short-Circuit Braking (N.O.)	Open: Normal operation Closed: Short-Circuit Braking	-	-	O	194
7D	Short-Circuit Braking (N.C.)	Open: Short-Circuit Braking Closed: Normal operation	-	-	O	194
7E	Forward/Reverse Detection	Direction of rotation detection (for V/f with Simple PG Feedback)	O	-	-	194
90 to 96	DWEZ Digital Inputs 1 to 7	Reserved for DWEZ input functions	O	O	O	194
9F	DriveWorksEZ enable	Open: DWEZ enabled Closed: DWEZ disabled	O	O	O	194

<1> Available in drive software versions PRG: 1016 and later.

No.	Name	Description	Range	Def.	Control Mode			Addr. Hex	Pg.
					V/f	OLV	PM		
H2: Multi-Function Digital Outputs									
Use H2 parameters to assign functions to the multi-function digital outputs.									
H2-01	Terminal MA, MB and MC Function Selection (relay)	Refer to H2 Multi-Function Digital Output Settings on page 379 for a description of setting values.	0 to 192 <1>	E	A	A	A	40B	195
H2-02	Terminal P1 Function Selection (open-collector)			0	A	A	A	40C	195
H2-03	Terminal P2 Function Selection (open-collector)			2	A	A	A	40D	195

No.	Name	Description	Range	Def.	Control Mode			Addr. Hex	Pg.
					V/f	OLV	PM		
H2-06	Watt Hour Output Unit Selection	Sets the output units for the watt hours when Watt Hour Pulse Output is selected as the digital output (H2-01, H2-02, or H2-03 = 39). Outputs a 200 ms pulse signal when the watt-hour counter increases by the units selected. 0: 0.1 kWh units 1: 1 kWh units 2: 10 kWh units 3: 100 kWh units 4: 1000 kWh units	0 to 4	0	A	A	A	437	204

<1> The availability of certain functions depends on the control method used.

H2 Multi-Function Digital Output Settings									
H2-□□ Setting	Function	Description	Control Mode			Pg.			
			V/f	OLV	PM				
0	During Run	Closed: A Run command is active or voltage is output.	0	0	0	195			
1	Zero Speed	Closed: Output frequency is 0.	0	0	0	196			
2	Speed Agree 1	Closed: Output frequency equals the speed reference (plus or minus the hysteresis set to L4-02).	0	0	0	196			
3	User Set Speed Agree 1	Closed: Output frequency and speed reference equal the value in L4-01 (plus or minus the hysteresis of L4-02).	0	0	0	196			
4	Frequency Detection 1	Closed: Output frequency is less than or equal to the value in L4-01 with hysteresis determined by L4-02.	0	0	0	197			
5	Frequency Detection 2	Closed: Output frequency is greater than or equal to the value in L4-01, with hysteresis determined by L4-02.	0	0	0	197			
6	Drive Ready	Closed: Drive Ready. The drive is powered up, not in a fault state, and in the Drive mode.	0	0	0	198			
7	DC Bus Undervoltage	Closed: DC bus voltage is below the Uv trip level set in L2-05.	0	0	0	198			
8	During Baseblock (N.O.)	Closed: There is no output voltage	0	0	0	198			
9	Frequency reference selection	Open: External Reference 1 or 2 supplies the frequency reference Closed: Digital operator supplies the frequency reference.	0	0	0	198			
A	Run command selection	Open: External Reference 1 or 2 supplies the Run command Closed: Digital operator supplies the Run command.	0	0	0	198			
B	Torque Detection 1 (N.O.)	Closed: Output current/torque exceeds the torque value set in parameter L6-02 for longer than the time set in parameter L6-03.	0	0	0	198			
C	Frequency Reference Loss	Closed: Loss of the analog frequency reference detected. Enabled when L4-05 = 1.	0	0	0	199			
D	Braking Resistor Fault	Closed: Braking resistor or transistor is overheated or faulted out. This selection requires that braking resistor protection parameter be set for ERF (L8-01 = "1").	0	0	0	199			
E	Fault	Closed: Fault occurred (other than CPF00 and CPF01).	0	0	0	199			
F	Not used/Through Mode	Set this value when the terminal is not used, or when using the terminal in the pass-through mode.	0	0	0	199			
10	Minor Fault	Closed: An alarm is triggered.	0	0	0	199			
11	Reset Command Active	Closed: The drive has received a reset command from the multi-function input terminals or from serial network, or the digital operator RESET key has been pressed.	0	0	0	199			
12	Timer Output	Timer output, controlled by b4-01 and b4-02. Used in conjunction with the digital input (H1-□□ = 18 "timer function").	0	0	0	199			
13	Speed Agree 2	Closed: When drive output frequency equals the frequency reference +/- L4-04.	0	0	0	199			
14	User Set Speed Agree 2	Closed: When the drive output frequency is equal to the value in L4-03 (plus or minus L4-04).	0	0	0	200			
15	Frequency Detection 3	Closed: When the drive output frequency is less than or equal to the value in L4-03 with the hysteresis determined by L4-04.	0	0	0	200			
16	Frequency Detection 4	Closed: When the output frequency is greater than or equal to the value in L4-03 with the hysteresis determined by L4-04.	0	0	0	201			

B.2 Parameter Table

H2 Multi-Function Digital Output Settings						
H2-□□ Setting	Function	Description	Control Mode			Pg.
			V/f	OLV	PM	
17	Torque Detection 1 (N.C.)	Open: When the output current/torque exceeds the value set in parameter L6-02 for more time than is set in parameter L6-03.	0	0	0	198
18	Torque Detection 2 (N.O.)	Closed: When the output current/torque exceeds the value set in parameter L6-05 for more time than is set in parameter L6-06.	0	0	0	198
19	Torque Detection 2 (N.C.)	Open: Output current/torque exceeds the value set in parameter L6-05 for more time than is set in parameter L6-06.	0	0	0	198
1A	Reverse Direction	Closed: Drive is running in the reverse direction.	0	0	0	201
1B	During Baseblock (N.C.)	Open: Drive is in Baseblock condition. Output is disabled.	0	0	0	202
1C	Motor 2 Selection	Closed: Motor 2 is selected by a digital input (H1-□□ = 16)	0	0	-	202
1E	Restart Enabled	Closed: An automatic restart is performed	0	0	0	202
1F	Overload Alarm oL1	Closed: oL1 is at 90% of its trip point or greater.	0	0	0	202
20	oH Pre alarm	Closed: Heatsink temperature exceeds the parameter L8-02 value.	0	0	0	202
22	Mechanical Weakening (N.O.)	Closed: Mechanical Weakening detected.	0	0	0	202
2F </>	Maintenance Period	Closed: Cooling fan, electrolytic capacitors, IGBTs, or the soft charge bypass relay may require maintenance.	0	0	0	202
30	During Torque Limit	Closed: When the torque limit has been reached.	-	0	-	202
37	During Frequency Output	Open: No frequency output from drive if stopped, with baseblock, with DC injection braking during initial excitation, or with short-circuit braking. Closed: Drive is outputting a frequency	0	0	0	202
38	Drive Enable	Closed: Multi-function input closes (H1-□□ = 6A)	0	0	0	203
39	Watt Hour Pulse Output	Output units are determined by H2-06, outputs 200 ms pulse for each incremented kWh count.	0	0	0	203
3C	LOCAL/REMOTE Status	Closed: LOCAL Open: REMOTE	0	0	0	203
3D	Speed Search	Closed: Speed search is being executed.	0	0	0	203
3E	PID Feedback Loss Low	Closed: PID Feedback Loss Low. PID feedback value is below the level set to b5-13 for longer than the time set in b5-14.	0	0	0	203
3F	PID Feedback Loss High	Closed: PID Feedback Loss High. PID feedback value exceeds the level set to b5-36 for longer than the time set to b5-37.	0	0	0	203
4A	KEB Operation	Closed: KEB is being performed.	0	0	0	203
4B	Short-Circuit Brake	Closed: Short-Circuit Braking is active.	-	-	0	203
4C	During Fast-stop	Closed: Fast-stop command is entered	0	0	0	203
4D	oH Pre-alarm Time Limit	Closed: oH Pre-alarm time limit is passed.	0	0	0	203
4E </>	Braking Transistor Fault (rr)	Closed: The built-in dynamic braking transistor failed.	0	0	0	203
4F </>	Braking Resistor Overheat (oH)	Closed: The dynamic braking resistor has overheated.	0	0	0	203
90 to 92	DWEZ Digital Outputs 1 to 3	Reserved for DWEZ digital output functions.	0	0	0	204
100 to 192	H2 Parameter Functions Reversed Output Switching of 0 to 92	Reverse the output switching of the multi-function output functions. Set the last two digits of 1□□ to reverse the output signal of that specific function. Examples: Setting "108" reverses the output of "During baseblock," which is setting value 08. Setting "14A" reverses the output of "During KEB operation", which is setting "4A".	0	0	0	204

<1> Available in drive software versions PRG: 1016 and later.

No.	Name	Description	Range	Def.	Control Mode			Addr. Hex	Pg.
					V/f	OLV	PM		
H3: Analog Inputs									
Use H3 parameters to set the multi-function analog input terminals.									
H3-01	Terminal A1 Signal Level Selection	Sets the input level for terminal A1. 0: 0 to +10 V (lower limit) 1: 0 to +10 V (no lower limit)	0, 1	0	A	A	A	410	204
H3-02	Terminal A1 Function Selection	Sets the function of terminal A1. When terminal A1 is not used or is used as a through terminal, this parameter must be set to "F".	0 to 31 <f>	0	A	A	A	434	205
H3-03 <2>	Terminal A1 Gain Setting	Sets the level of the input value selected in H3-02 when 10 V is input at terminal A1.	-999.9 to 999.9	100.0 %	A	A	A	411	205
H3-04 <2>	Terminal A1 Bias Setting	Sets the level of the input value selected in H3-02 when 0 V is input at terminal A1.	-999.9 to 999.9	0.0%	A	A	A	412	205
H3-09	Terminal A2 Signal Level Selection	Sets the input signal level for terminal A2. 0: 0 to +10 V (with lower limit) 1: 0 to +10 V (no lower limit) 2: 4 to 20 mA 3: 0 to 20 mA	0 to 3	2	A	A	A	417	207
			Use DIP switch S1 to set input terminal A2 for a current or a voltage input signal.						
H3-10	Terminal A2 Function Selection	Sets the function of terminal A2. When terminal A2 is not used or is used as a through terminal, this parameter must be set to "F".	0 to 31 <f>	0	A	A	A	418	207
H3-11 <2>	Terminal A2 Gain Setting	Sets the level of the input value selected in H3-10 when 10 V (20 mA) is input at terminal A2.	-999.9 to 999.9	100.0 %	A	A	A	419	207
H3-12 <2>	Terminal A2 Bias Setting	Sets the level of the input value selected in H3-10 when 0 V (0 or 4 mA) is input at terminal A2.	-999.9 to 999.9	0.0%	A	A	A	41A	207
H3-13	Analog Input Filter Time Constant	Sets the primary delay filter time constant for terminals A1 and A2. Used for noise filtering.	0.00 to 2.00	0.03 s	A	A	A	41B	207
H3-14 <3>	Analog Input Terminal Enable Selection	Determines which analog input terminal will be enabled when a digital input programmed for "Analog input enable" (H1-□□ = C) is activated. 1: Terminal A1 only 2: Terminal A2 only 7: All terminals enabled	1, 2, 7	7	A	A	A	41C	209
H3-16 <3>	Terminal A1 Offset	Enter a 0 V signal to terminal A1. Next adjust the offset in H3-16 until the monitor U1-13 for the terminal A1 input voltage reads 0.0%. The process is the same for terminal A2.	-500 to 500	0	A	A	A	440	209
H3-17 <3>	Terminal A2 offset	Enter a 0 V signal, and adjust the offset for terminal A2 in H3-17 until the monitor U1-14 for terminal A2 input voltage reads 0.0%.	-500 to 500	0	A	A	A	441	209

<1> The availability of certain parameters depends on the control method used.

<2> Parameter can be changed during Run.

<3> Parameter available in drive software versions PRG: 1016 and later.

H3 Multi-Function Analog Input Settings									
H3-□□ Setting	Function	Maximum Input Level Possible	Control Mode			Pg.			
			V/f	OLV	PM				
0	Frequency Bias	Max output frequency (E1-04). Same value can be set using H3-02 and H3-10.	O	O	O	208			
1	Frequency Gain	10 V = 100%	O	O	O	208			
2	Auxiliary Frequency Reference (used as a Multi-Step Speed 2)	Maximum output frequency (E1-04)	O	O	O	208			
4	Output Voltage Bias	Motor rated voltage (E1-05).	O	-	-	208			
7	Overtorque/Undertorque Detection Level	Open Loop Vector: Motor rated torque V/f Control: Drive rated current	O	O	O	208			
B	PID Feedback	10 V = 100%	O	O	O	208			

B.2 Parameter Table

H3 Multi-Function Analog Input Settings						
H3-□□ Setting	Function	Maximum Input Level Possible	Control Mode			Pg.
			V/f	OLV	PM	
C	PID Set Point	10 V = 100%	O	O	O	208
E	Motor Temperature (PTC input)	10 V = 100.00%	O	O	O	208
F	Not used/Through Mode	–	O	O	O	209
10	FWD Torque Limit	Motor rated torque	–	O	–	209
11	REV Torque Limit	Motor rated torque	–	O	–	209
12	Regenerative Torque Limit	Motor rated torque	–	O	–	209
15	FWD/REV Torque Limit	Motor rated torque	–	O	–	209
16	Differential PID Feedback	10 V = 100%	O	O	O	209
30/31	DWEZ Analog Input 1/2	Depending on function.	O	O	O	209
41 <1>	Output Voltage Gain	10 V = 100%	O	–	–	209

<1> Parameter available in drive software versions PRG: 1016 and later.

No.	Name	Description	Range	Def.	Control Mode			Addr. Hex	Pg.
					V/f	OLV	PM		
H4: Multi-Function Analog Outputs									
Use H4 parameters to configure the multi-function analog output terminals.									
H4-01	Multi-Function Analog Output Terminal AM	Selects the data to be output through multi-function analog output terminal AM. Set the desired monitor parameter to the digits available in U□-□□. For example, enter “103” for U1-03. When using this terminal in through mode or when not using it at all, set “000” or “031”.	000 to 999 <1>	102	A	A	A	41D	210
H4-02 <2>	Multi-Function Analog Output Terminal AM Gain	Sets terminal AM output gain. Maximum output voltage is 10 V.	-999.9 to 999.9	100.0 %	S	S	S	41E	210
H4-03 <2>	Multi-Function Analog Output Terminal AM Bias	Sets terminal AM output bias.	-999.9 to 999.9	0.0%	A	A	A	41F	210
H5: MEMOBUS/Modbus Communications									
Use H5 Parameters to connect the drive to a MEMOBUS/Modbus network. The settings for MEMOBUS/Modbus communications become effective when the drive is restarted.									
H5-01 <3>	Drive Node Address	Selects drive station node number (address) for MEMOBUS/Modbus terminals R+, R-, S+, S-. Cycle power for the setting to take effect.	0 to 20 H	1F	A	A	A	425	439
H5-02	Communication Speed Selection	Selects the baud rate for MEMOBUS/Modbus terminals R+, R-, S+ and S-. Cycle power for the setting to take effect. 0 : 1200 bps 1 : 2400 bps 2 : 4800 bps 3 : 9600 bps 4 : 19200 bps 5 : 38400 bps 6 : 57600 bps 7 : 76800 bps 8 : 115200 bps	0 to 8	3	A	A	A	426	439
H5-03	Communication Parity Selection	Selects the communication parity for MEMOBUS/Modbus terminals R+, R-, S+ and S-. Cycle power for the setting to take effect. 0: No parity 1: Even parity 2: Odd parity	0 to 2	0	A	A	A	427	439

No.	Name	Description	Range	Def.	Control Mode			Addr. Hex	Pg.
					V/f	OLV	PM		
H5-04	Stopping Method After Communication Error	Selects the stopping method when a communication time-out fault (CE) is detected. 0: Ramp to stop 1: Coast to stop 2: Fast-stop 3: Alarm only	0 to 3	3	A	A	A	428	439
H5-05	Communication Fault Detection Selection	Enables or disables the communications time-out fault (CE) detection. 0: Disabled 1: Enabled - If communication is lost for more than two seconds, a CE fault will occur.	0, 1	1	A	A	A	429	440
H5-06	Drive Transmit Wait Time	Set the wait time between receiving and sending data.	5 to 65	5 ms	A	A	A	42A	440
H5-07	RTS Control Selection	Selects "request to send" (RTS) control: 0: Disabled - RTS is always on. 1: Enabled - RTS turns on only when sending.	0, 1	1	A	A	A	42B	440
H5-09	CE Detection Time	Sets the time required to detect a communications error. Adjustment may be need when networking several drives.	0.0 to 10.0 s	2.0 s	A	A	A	435	440
H5-10	Unit Selection for MEMOBUS/Modbus Register 0025H	Selects the units used for MEMOBUS/Modbus register 0025H (Output Voltage Reference Monitor). 0: 0.1 V units 1: 1 V units	0, 1	0	A	A	A	436	440
H5-11	Communications ENTER Function Selection	Select the function for the enter command that saves parameter data to the drive. 0: Parameter changes are activated when ENTER command is entered. 1: Parameter changes are activated immediately without ENTER command (compatible with Varispeed VS606-V7).	0, 1	1	A	A	A	43C	441
H5-12	Run Command Method Selection	0: FWD/STOP, REV/STOP Method 1: RUN/STOP, FWD/REV Method	0, 1	0	A	A	A	43D	441
H6: Pulse Train Input/Output Use H6 parameters to configure Pulse Train I/O operation.									
H6-01	Pulse Train Input Terminal RP Function Selection	Selects pulse train input function. 0: Frequency reference 1: PID feedback value 2: PID setpoint value 3: V/fControl with Simple PG Feedback (can be set only when using motor 1 in V/f Control)	0 to 3	0	A	A	A	42C	211
H6-02 <2>	Pulse Train Input Scaling	Sets the terminal RP input signal frequency that is equal to 100% of the value selected in H6-01.	<2>	1440 Hz	A	A	A	42D	211
H6-03 <2>	Pulse Train Input Gain	Sets the level of the value selected in H6-01 when a frequency with the value set in H6-02 is input.	0.0 to 1000.0	100.0 %	A	A	A	42E	211
H6-04 <2>	Pulse Train Input Bias	Sets the level of the value selected in H6-01 when 0 Hz is input.	-100.0 to +100.0	0.0%	A	A	A	42F	211
H6-05 <2>	Pulse Train Input Filter Time	Sets the pulse train input filter time constant.	0.00 to 2.00	0.10 s	A	A	A	430	211
H6-06 <2>	Pulse Train Monitor Terminal MP Selection	Select the pulse train monitor output function (value of the □-□□ part of U□-□□). Refer to U: Monitors on page 399 for the list of U monitors. Example: To select U5-01, set "501." When not using this parameter or when using in the through mode, set "000". <2>	000, 031, 101, 102, 105, 116, 501, 502, 801 to 809	102	A	A	A	431	212
H6-07 <2>	Pulse Train Monitor Scaling	Sets the terminal MP output signal frequency when the monitor value is 100%. Set H6-06 to 102 and H6-07 to 0 to make the pulse train monitor output equal to the output frequency.	0 to 32000	1440 Hz	A	A	A	432	212

- <1> The availability of certain functions depends on the control method used.
- <2> Parameter can be changed during Run.
- <3> If this parameter is set to 0, the drive will be unable to respond to MEMOBUS/Modbus commands.
- <4> Default setting is determined by drive software version.
PRG: 1016 and later: 100 to 32000 Hz

B.2 Parameter Table

PRG: 1015 and earlier: 1000 to 32000 Hz

<5> When set for sourcing, +5 V/1.5 kΩ or higher, +8 V/3.5 kΩ or higher, +10 V/10 kΩ or higher. When set for sinking, the external power supply should be +12 Vdc, ±5% with 16 mA or less.

Note: Cycle power to the drive to enable MEMOBUS/Modbus settings.

◆ L: Protection Function

L parameters provide protection to the drive and motor, such as: control during momentary power loss, Stall Prevention, frequency detection, fault restarts, overtorque detection, torque limits and other types of hardware protection.

No.	Name	Description	Range	Def.	Control Mode			Addr. Hex	Pg.
					V/f	OLV	PM		
L1: Motor Protection Functions									
Use L1 parameters to configure motor protective functions.									
L1-01	Motor Overload Protection Selection	Sets the motor thermal overload protection (oL1) based on the cooling capacity of the motor. 0: Disabled 1: General Purpose Motor (Standard Fan Cooled) 2: Drive Dedicated Motor with a Speed Range of 1:10 3: Vector Motor with a Speed Range of 1:100 4: PM Motor with Variable Torque 6: General Purpose Motor (50 Hz) <1> Note: When using multiple motors the drive may not be able to provide protection, even if overload is enabled in L1-01. Set L1-01 to 0 and ensure each motor has separate thermal relays installed.	0 to 4; 6	1 <2>	S	S	S	480	213
L1-02	Motor Overload Protection Time	Sets the motor thermal overload protection (oL1) time. A larger L1-02 time will increase the time for an oL1 fault to occur. This parameter does not typically require adjustment. Should be set in accordance with the overload tolerance of the motor.	0.1 to 20.0	8.0 min	A	A	A	481	215
L1-03	Motor Overheat Alarm Operation Selection (PTC input)	Sets operation when the motor temperature analog input (H3-02/10 = E) exceeds the oH3 alarm level. 0: Ramp to Stop 1: Coast to Stop 2: Fast-stop using C1-09 3: Alarm Only ("oH3" will flash)	0 to 3	3	A	A	A	482	216
L1-04	Motor Overheat Fault Operation Selection (PTC input)	Sets stopping method when the motor temperature analog input (H3-02/10 = E) exceeds the oH4 fault level. 0: Ramp to Stop 1: Coast to Stop 2: Fast-stop	0 to 2	1	A	A	A	483	217
L1-05	Motor Temperature Input Filter Time (PTC input)	This parameter adjusts the filter on the motor temperature analog input (H3-02 or H3-10 = E). Increase to add stability, decrease to improve response.	0.00 to 10.00	0.20 s	A	A	A	484	217
L1-13	Continuous Electrothermal Operation Selection	Determines whether or not to hold the electrothermal value when the power supply is interrupted. 0: Disabled 1: Enabled	0, 1	1	A	A	A	46D	217
L1-22 <16> <17>	Leakage Current Filter Time Constant 1	Sets the time constant for reducing the sensitivity level when detecting leakage current. Set in seconds and used when operating at constant speed. Note: This parameter is available only when C6-02 is set to B. To display this parameter, first set C6-02 = B.	0.0 to 60.0	20.0 s	A	A	A	768	217
L1-23 <16> <17>	Leakage Current Filter Time Constant 2	Sets the time constant for reducing the sensitivity level when detecting leakage current. Set in seconds and used during acceleration and deceleration operation. Note: This parameter is available only when C6-02 is set to B. To display this parameter, first set C6-02 = B.	0.0 to 60.0	1.0 s	A	A	A	769	217
L2: Momentary Power Loss									
Use L2 parameters to configure drive functions for momentary power loss conditions.									

No.	Name	Description	Range	Def.	Control Mode			Addr. Hex	Pg.
					V/f	OLV	PM		
L2-01	Momentary Power Loss Operation Selection	Enables and disables the momentary power loss function. 0: Disabled - Drive trips on (Uv1) fault when power is lost. 1: Power Loss Ride-Thru Time - Drive will restart if power returns within the time set in L2-02. 2: CPU Power Active - Drive will restart if power returns as long as the CPU is working.	0 to 2	0	A	A	A	485	218
			For a restart to occur, the run command must be maintained throughout the Ride-Thru period.						
L2-02	Momentary Power Loss Ride-Thru Time	Sets the Power Loss Ride-Thru time. Only effective when L2-01 = 1.	0.0 to 25.5	<>	A	A	A	486	218
L2-03	Momentary Power Loss Minimum Baseblock Time	Sets the minimum wait time for residual motor voltage decay before the drive output reenergizes after power loss Ride-Thru. If L2-03 is greater than L2-02, operation resumes after the time set in L2-03.	0.1 to 5.0	<>	A	A	A	487	218
L2-04	Momentary Power Loss Voltage Recovery Ramp Time	Sets the time for the output voltage to return to the preset V/f pattern during Speed Search.	0.0 to 5.0	<>	A	A	A	488	218
L2-05 <>	Undervoltage Detection Level (Uv)	Sets the DC Bus undervoltage trip level. If this is set lower than the default setting, additional AC input impedance or DC bus reactance may be necessary. This value is used for KEB activation if L2-01 > 0.	150 to 210	<> <>	A	A	A	489	218
L2-06	KEB Deceleration Time	Sets the time required to decelerate from the speed when KEB was activated to zero speed.	0.0 to 200.0	0.0 s	A	A	A	48A	220
L2-07	KEB Acceleration Time	Sets the time to accelerate to the frequency reference when momentary power loss is over. If set to 0.0, the active acceleration time (C1-01, C1-03, C1-05, or C1-07) is used.	0.0 to 25.5	0.0 s	A	A	A	48B	220
L2-08	KEB Start Output Frequency Reduction	Sets the percentage of output frequency reduction at the beginning of deceleration when the KEB function is started. Reduction = (slip frequency before KEB) x (L2-08/100) x 2	0 to 300	100%	A	A	A	48C	221
L2-11 <>	Desired DC Bus Voltage during KEB	Sets the desired value of the DC bus voltage during KEB.	150 to 400 V	E1-01 x 1.22	A	A	A	461	221
L3: Stall Prevention Function									
Use L3 parameters to configure the Stall Prevention function.									
L3-01	Stall Prevention Selection during Acceleration	Selects the Stall Prevention method used to prevent excessive current during acceleration. 0: Disabled - Motor accelerates at active acceleration rate. The motor may stall if load is too heavy or accel time is too short. 1: General Purpose - When output current exceeds L3-02 level, acceleration stops. Acceleration will continue when the output current level falls below the L3-02 level. 2: Intelligent - The active acceleration rate is ignored. Acceleration is completed in the shortest amount of time without exceeding the current value set in L3-02.	0 to 2 <>	1	A	A	A	48F	221
L3-02	Stall Prevention Level during Acceleration	Used when L3-01 = 1 or 2. 100% is equal to the drive rated current. Decrease the set value if stalling or excessive current occurs with default setting.	0 to 150 <18>	<> <18>	A	A	A	490	222
L3-03	Stall Prevention Limit during Acceleration	Sets Stall Prevention lower limit during acceleration when operating in the constant power range. Set as a percentage of the drive's rated current.	0 to 100	50%	A	A	A	491	223

B.2 Parameter Table

No.	Name	Description	Range	Def.	Control Mode			Addr. Hex	Pg.
					V/f	OLV	PM		
L3-04	Stall Prevention Selection during Deceleration	When using a braking resistor, use setting "0". Setting "3" is used in specific applications. 0: Disabled - The drive decelerates at the active deceleration rate. If the load is too large or the deceleration time is too short, an ov fault may occur. 1: General Purpose - The drive decelerates at the active deceleration rate, but if the main circuit DC bus voltage reaches the Stall Prevention level, deceleration will stop. Deceleration will continue once the DC bus level drops below the Stall Prevention level. 2: Intelligent - The active deceleration rate is ignored and the drive decelerates as fast as possible without hitting ov fault level. Range: C1-02 / 10. 3: Stall Prevention with Braking Resistor - Stall Prevention during deceleration is enabled in coordination with dynamic braking. 4: Overexcitation Deceleration - Decelerates with the flux level determined by n3-13 (Overexcitation Gain). 7: Overexcitation Deceleration 3 - Applies more braking power than normal overexcitation deceleration. Yaskawa recommends extra caution due to the heavy load on the motor.	0 to 4; 7 <9>	1	S	S	S	492	223
L3-05	Stall Prevention Selection during Run	Selects the Stall Prevention method to use to prevent drive faults during run. 0: Disabled - Drive runs a set frequency. A heavy load may cause the drive to trip on an oC or oL fault. 1: Decel Time 1 - The drive will decelerate at Decel Time 1 (C1-02) if the output current exceeds the level set by L3-06. Once the current level drops below the L3-06 level, the drive will accelerate back to its frequency reference at the active acceleration rate. 2: Decel Time 2 - Same as setting 1 except the drive decelerates at Decel Time 2 (C1-04). When output frequency is 6 Hz or less, Stall Prevention during run is disabled regardless of the setting in L3-05.	0 to 2	1	A	-	A	493	224
L3-06	Stall Prevention Level during Run	Enabled when L3-05 is set to "1" or "2". 100% is equal to the drive rated current. Decrease the set value if stalling or excessive current occurs with the default settings.	30 to 150 <18>	<8> <18>	A	-	A	494	225
L3-11	ov Suppression Function Selection	Enables or disables ov suppression function, which allows the drive to change the output frequency as the load changes, thus preventing an ov fault. 0: Disabled 1: Enabled Note: The frequency reference and motor speed diverge as the regenerative energy begins to flow back into the DC bus and triggers the ov suppression function. Disable this function when using a braking resistor.	0, 1	0	A	A	A	4C7	225
L3-17 <5>	Overvoltage Suppression and Stall Prevention Desired DC Bus Voltage	Sets the desired value for the DC bus voltage during overvoltage suppression and Stall Prevention during deceleration. Enabled only when L3-04 = 2 or L3-11 = 1.	150 to 400 V	370 V <6>	A	A	A	462	226
L3-20	Main Power Circuit Voltage Adjustment Gain	Sets the proportional gain used by KEB, Stall Prevention and overvoltage suppression. If ov or Uv1 occurs at the beginning of KEB deceleration, slowly increase this setting by 0.1.	0.00 to 5.00	1.00	A	A	A	465	226
L3-21	Accel/Decel Rate Calculation Gain	Sets the proportional gain used to calculate the deceleration rate during KEB, ov suppression function and Stall Prevention during deceleration (L3-04 = 2). This parameter does not typically require adjustment. Increase the value in steps of 1.0 if overcurrent and overvoltage occur.	0.00 to 200.00	1.00	A	A	A	466	226
L3-22	Deceleration Time at Stall Prevention during Acceleration	Sets the deceleration time used for Stall Prevention during acceleration in Open Loop Vector Control for PM motors. When set to 0, the drive decelerates at the normal deceleration time.	0.0 to 6000.0	0.0 s	-	-	A	4F9	223

No.	Name	Description	Range	Def.	Control Mode			Addr. Hex	Pg.
					V/f	OLV	PM		
L3-23	Automatic Reduction Selection for Stall Prevention during Run	0: Sets the Stall Prevention level throughout the entire frequency range to the value in parameter L3-06. 1: Automatically lowers the Stall Prevention level in the constant output range. The lower limit value is 40% of L3-06.	0, 1	0	A	A	A	4FD	225
L3-24	Motor Acceleration Time for Inertia Calculations	Sets the time needed to accelerate the uncoupled motor at rated torque from stop to the maximum frequency. Setting the drive capacity to parameter o2-04 or changing E2-11 will automatically set this parameter for a 4-pole motor.	0.001 to 10.000	<4> <10> <11>	A	A	A	46E	226
L3-25	Load Inertia Ratio	Sets the ratio between the motor and machine inertia.	0.0 to 1000.0	1.0	A	A	A	46F	227
L4: Frequency Detection Use L4 parameters to configure frequency detection operation.									
L4-01	Speed Agreement Detection Level	These parameters configure the multi-function output (H2-□□ = 2, 3, 4, 5) settings "Speed Agree 1", "User Set Speed Agree 1", "Frequency Detection 1," and "Frequency detection 2".	0.0 to 400.0	0.0 Hz	A	A	A	499	227
L4-02	Speed Agreement Detection Width	Parameter L4-01 sets the level while parameter L4-02 sets the hysteresis for the Speed Detection Output Function.	0.0 to 20.0	2.0 Hz	A	A	A	49A	227
L4-03	Speed Agreement Detection Level (+/-)	These parameters configure the Multi-Function Output (H2-□□ = 13, 14, 15, 16) settings "Speed Agree 2", "User Set Speed Agree 2", "Frequency Detection 3," or "Frequency Detection 4".	-400.0 to +400.0	0.0 Hz	A	A	A	49B	227
L4-04	Speed Agreement Detection Width (+/-)	Parameter L4-03 sets the level while parameter L4-04 sets the hysteresis for the Speed Detection Output Function.	0.0 to 20.0	2.0 Hz	A	A	A	49C	227
L4-05	Frequency Reference Loss Detection Selection	Sets operation when the frequency reference is lost (reference drops 90% or more within 400 ms). 0: Stop - Drive will stop. 1: Run at L4-06 Level - Drive will run at the percentage set in L4-06 of the frequency reference before loss.	0, 1	0	A	A	A	49D	227
L4-06	Frequency Reference at Reference Loss	Sets the frequency reference when a reference loss was detected and L4-05 = 1. Reference will be: Fref = Fref at time of loss x L4-06.	0.0 to 100.0	80.0%	A	A	A	4C2	228
L4-07	Frequency Detection Conditions	0: No detection during baseblock. 1: Detection always enabled.	0, 1	0	A	A	A	470	228
L4-08 <12>	Speed Agreement Detection Conditions	0: Match speed with the soft-starter output 1: Match frequency reference and motor speed Note: In V/f Control, the drive ignores the value set to L4-08 and refers to the soft-starter output to determine whether a speed agree situation has been reached.	0, 1	0	A	A	A	47F	228
L5: Fault Reset Use L5 parameters to configure Automatic Restart after fault.									
L5-01	Number of Auto Restart Attempts	Sets the counter for the number of times the drive attempts to restart when one of the following faults occurs: GF, LF, oC, oH1, ov, PF, rH, rr, oL1, oL2, oL3, oL4, STo, Uv1. Parameter L5-05 determines the how the restart counter is incremented. When the drive operates without fault for 10 minutes, the counter will be reset.	0 to 10	0	A	A	A	49E	230
L5-02	Auto Restart Operation Selection	Sets fault contact (H2-□□ = E) activation during automatic restart attempts. 0: Fault output not active. 1: Fault output active during restart attempt.	0, 1	0	A	A	A	49F	230
L5-04	Fault Reset Interval Time	Sets the amount of time to wait between performing fault restarts. Enabled when L5-05 is set to 1.	0.5 to 600.0 s	10.0 s	A	A	A	46C	231
L5-05	Fault Reset Operation Selection	Selects the method of incrementing the restart counter. 0: Continuously attempt to restart and increment counter after successful restart (same as Varispeed VS616-F7/G7) 1: Attempt to restart with the interval time set in L5-04. Every trial increments the counter. (same as Varispeed VS606-V7)	0, 1	0	A	A	A	467	231
L6: Overtorque Detection Use L6 parameters to configure overtorque detection.									

B.2 Parameter Table

No.	Name	Description	Range	Def.	Control Mode			Addr. Hex	Pg.
					V/f	OLV	PM		
L6-01	Torque Detection Selection 1	<p>Selects the overtorque/undertorque operation. overtorque and undertorque are determined by the settings in parameters L6-02 and L6-03. The multi-function output settings (H2-□□= B and 17) are also active if programmed.</p> <p>0: Disabled</p> <p>1: oL3 at Speed Agree - Alarm (overtorque detection only active during Speed Agree and operation continues after detection).</p> <p>2: oL3 at RUN - Alarm (overtorque detection is always active and operation continues after detection).</p> <p>3: oL3 at Speed Agree - Fault (overtorque detection only active during Speed Agree and drive output will shut down on an oL3 fault).</p> <p>4: oL3 at RUN - Fault (overtorque detection is always active and drive output will shut down on an oL3 fault).</p> <p>5: UL3 at Speed Agree - Alarm (undertorque detection is only active during Speed Agree and operation continues after detection).</p> <p>6: UL3 at RUN - Alarm (undertorque detection is always active and operation continues after detection).</p> <p>7: UL3 at Speed Agree - Fault (undertorque detection only active during Speed Agree and drive output will shut down on an oL3 fault).</p> <p>8: UL3 at RUN - Fault (undertorque detection is always active and drive output will shut down on an oL3 fault).</p>	0 to 8	0	A	A	A	4A1	231
L6-02	Torque Detection Level 1	Sets the overtorque/undertorque detection level. 100% is equal to the motor rated current in V/f Control and the motor rated torque in Open Loop Vector Control.	0 to 300	150%	A	A	A	4A2	232
L6-03	Torque Detection Time 1	Sets the length of time an overtorque/undertorque condition must exist before Torque Detection 1 is triggered.	0.0 to 10.0	0.1 s	A	A	A	4A3	233
L6-04	Torque Detection Selection 2	<p>Sets the response to an overtorque/undertorque condition. overtorque and undertorque are determined by the settings in parameters L6-05 and L6-06. The multi-function output settings (H2-□□ = 18 and 19).</p> <p>0: Disabled</p> <p>1: oL4 at Speed Agree - Alarm (overtorque Detection only active during Speed Agree and Operation continues after detection).</p> <p>2: oL4 at RUN - Alarm (overtorque Detection is always active and operation continues after detection).</p> <p>3: oL4 at Speed Agree - Fault (overtorque Detection only active during Speed Agree and drive output will shut down on an oL4 fault).</p> <p>4: oL4 at RUN - Fault (overtorque Detection is always active and drive output will shut down on an oL4 fault).</p> <p>5: UL4 at Speed Agree - Alarm (undertorque Detection is only active during Speed Agree and operation continues after detection).</p> <p>6: UL4 at RUN - Alarm (undertorque Detection is always active and operation continues after detection).</p> <p>7: UL4 at Speed Agree - Fault (undertorque Detection only active during Speed Agree and drive output will shut down on an oL4 fault).</p> <p>8: UL4 at RUN - Fault (undertorque Detection is always active and drive output will shut down on an oL4 fault).</p>	0 to 8	0	A	A	A	4A4	232
L6-05	Torque Detection Level 2	Sets the overtorque/undertorque detection level. 100% is equal to the motor rated current in V/f Control or PM OLV and equal to the motor rated torque in Open Loop Vector Control.	0 to 300	150%	A	A	A	4A5	232
L6-06	Torque Detection Time 2	Sets the length of time an overtorque/undertorque condition must exist before torque detection 2 is recognized by the drive.	0.0 to 10.0	0.1 s	A	A	A	4A6	233

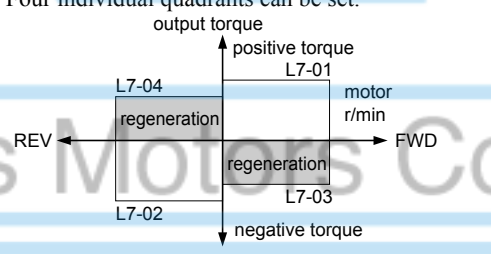
No.	Name	Description	Range	Def.	Control Mode			Addr. Hex	Pg.
					V/f	OLV	PM		
L6-08	Mechanical Weakening (oL5) Detection Operation	This function can detect an over/undertorque in a certain speed range as a result of machine fatigue. It is triggered by a certain operation time and uses the oL1 detection settings (L6-01 to L6-02) 0: Mechanical Weakening Detection disabled. 1: Continue running (alarm only). Detected when the speed (signed) is greater than L6-09. 2: Continue running (alarm only). Detected when the speed (not signed) is greater than L6-09. 3: Interrupt drive output (fault). Detected when the speed (signed) is greater than L6-09. 4: Interrupt drive output (fault). Detected when the speed (not signed) is greater than L6-09. 5: Continue running (alarm only). Detected when the speed (signed) is less than L6-09. 6: Continue running (alarm only). Detected when the speed (not signed) is less than L6-09. 7: Interrupt drive output (fault). Detected when the speed (signed) is less than L6-09. 8: Interrupt drive output (fault). Detected when the speed (not signed) is less than L6-09.	0 to 8	0	A	A	A	468	233
L6-09	Mechanical Weakening Detection Speed Level	Sets the speed that triggers mechanical weakening detection. When L6-08 is set for an unsigned value, the absolute value is used even if the setting is negative.	-110.0 to +110.0%	110%	A	A	A	469	233
L6-10	Mechanical Weakening Detection Time	Sets the time a mechanical weakening has to be detected before an Alarm/Fault is triggered.	0.0 to 10.0 s	0.1 s	A	A	A	46A	234
L6-11	Mechanical Weakening Detection Start Time	Sets the operation time (U1-04) that has to be passed before Mechanical weakening detection is active.	0 to 65535	0	A	A	A	46B	234
L7: Torque Limit Use L7 parameters to configure the torque limit function.									
L7-01	Forward Torque Limit	Sets the torque limit value as a percentage of the motor rated torque. Four individual quadrants can be set. 	0 to 300	200%	-	A	-	4A7	234
L7-02	Reverse Torque Limit		0 to 300	200%	-	A	-	4A8	234
L7-03	Forward Regenerative Torque Limit		0 to 300	200%	-	A	-	4A9	234
L7-04	Reverse Regenerative Torque Limit	0 to 300	200%	-	A	-	4AA	234	
L7-06	Torque Limit Integral Time Constant	Sets the integral time constant for the torque limit.	5 to 10000	200 ms	-	A	-	4AC	234
L7-07	Torque Limit Control Method Selection during Accel/Decel	Selects the method of torque limit control during accel/decel. 0: Proportional Control (change to integral controls at fixed speeds). Use this setting when acceleration to the desired speed has priority over torque limitation. 1: Integral Control. Use this setting if the torque limitation has priority. When torque limit is applied to the motor, accel/decel time may increase and motor speed may not meet the speed reference.	0, 1	0	-	A	-	4C9	234
L8: Hardware Protection Use L8 parameters to configure hardware protection functions.									
L8-01	Internal Dynamic Braking Resistor Protection Selection (ERF type)	Selects the Braking resistor when using a 3% duty cycle heatsink mounted braking resistor. This parameter does not enable or disable the braking transistor of the drive. 0: Resistor overheat protection disabled 1: Resistor overheat protection enabled	0, 1	0	A	A	A	4AD	235
L8-02	Overheat Alarm Level	When the heatsink temperature exceeds the value set in this parameter, an Overheat Alarm (oH) will occur.	50 to 130	<>	A	A	A	4AE	235

B.2 Parameter Table

No.	Name	Description	Range	Def.	Control Mode			Addr. Hex	Pg.
					V/f	OLV	PM		
L8-03	Overheat Pre-Alarm Operation Selection	Sets the drive operation when an overheat alarm oH is detected. 0: Ramp to Stop using the active decel time. 1: Coast to Stop. 2: Fast-stop using the time set in C1-09. 3: Alarm Only. Drive continues running, but displays an alarm. 4: Reduced Speed Operation. Drive continues to run with reduced frequency reference as specified in L8-19. Settings 0 through 2 trigger a fault relay if the heatsink becomes too hot.	0 to 4	3	A	A	A	4AF	235
L8-05	Input Phase Loss Protection Selection	Selects the detection of input current phase loss, power supply voltage imbalance, or main circuit electrolytic capacitor deterioration. 0: Disabled 1: Enabled Note: This parameter is disabled in 200 V single-phase drives.	0, 1	1	A	A	A	4B1	236
L8-07	Output Phase Loss Protection Selection	Selects the output phase loss detection. 0: Disabled 1: Enabled (triggered by a single phase loss) 2: Enabled (triggered when two phases are lost) Output phase loss is detected when operating with less than 5% of the drive rated current. Detection can mistakenly occur if the motor is small relative to the drive capacity rating (this parameter should be disabled in such cases).	0 to 2	1	A	A	A	4B3	236
L8-09	Output Ground Fault Detection Selection	Selects the output ground fault detection. 0: Disabled 1: Enabled	0, 1	<3>	A	A	A	4B5	237
L8-10	Heatsink Cooling Fan Operation Selection	Controls the heatsink cooling fan operation. 0: Run with timer (Fan operates only during run and for L8-11 seconds after stop.) 1: Run always (Cooling fan operates whenever the drive is powered up.)	0, 1	0	A	A	A	4B6	237
L8-11	Heatsink Cooling Fan Operation Delay Time	This parameter sets the delay time for the cooling fan to shut off after the run command is removed when L8-10 = 0.	0 to 300	60 s	A	A	A	4B7	237
L8-12	Ambient Temperature Setting	Used to input the ambient temperature. This value adjusts the drives oL2 detection level.	-10 to 50	40 °C	A	A	A	4B8	237
L8-15	oL2 Characteristics Selection at Low Speeds	Sets the oL2 characteristics at output frequencies below 6 Hz. 0: No oL2 level reduction below 6 Hz. 1: oL2 level is reduced linearly below 6 Hz. It is halved at 0 Hz.	0, 1	1	A	A	A	4BB	237
L8-18	Soft Current Limit Selection	Selects the software current limit function. Typically no adjustment is required. 0: Disabled 1: Enabled	0, 1	<15>	A	A	-	4BE	238
L8-19	Frequency Reduction Rate during oH Pre-Alarm	Specifies the frequency reference reduction gain at overheat pre-alarm when L8-03 = 4.	0.1 to 1.0	0.8	A	A	A	4BF	236
L8-29	Current Unbalance Detection (LF2)	Selects the detection of unbalanced output currents caused by faulty devices in the output circuit. 0: Disabled 1: Enabled	0, 1	1	-	-	A	4DF	238
L8-35	Installation Method Selection	Selects the installation type: 0: IP20/Open-Chassis Drive, IP00/Open-Chassis Drive 1: Side-by-Side Mounting 2: NEMA Type 1 Drive 3: Finless Drive or External Heatsink Installation	0 to 3	2 <13>	A	A	A	4EC	238
L8-38	Carrier Frequency Reduction	Provides protection to the IGBTs by reducing the carrier frequency at low speeds. 0: Disabled 1: Enabled below 6 Hz 2: Enabled for the whole speed range	0 to 2	<3>	A	A	A	4EF	238

No.	Name	Description	Range	Def.	Control Mode			Addr. Hex	Pg.
					V/f	OLV	PM		
L8-40	Carrier Frequency Reduction Time	Sets the time for that the drive continues running with reduced carrier frequency after the carrier reduction condition has gone (see also L8-38). A setting of 0.00 s disables the carrier frequency reduction time.	0.00 to 2.00	0.50	A	A	A	4F1	239
L8-41	High Current Alarm Selection	Configures an alarm when the output current exceeds 150% of the drive rated current. 0: Alarm disabled. 1: Alarm enabled.	0, 1	0	A	A	A	4F2	239
L8-51 <14>	STo Fault Detection Level	Sets the STo detection level as a percentage of the motor rated current. Increase this value to detect pull-out more quickly during acceleration. The drive calculates this value automatically when L8-51 is set to 0.0%.	0.0 to 150.0%	0.0%	-	-	A	471	239
L8-54 <14>	STo Deviation Detection	0: Disabled. 1: Enabled.	0, 1	1	-	-	A	474	239

- <1> Setting 6 available in drive software versions PRG: 1016 and later.
- <2> Default setting value is dependent on parameter A1-02, Control Method Selection. The value shown is for A1-02 = 0-V/f Control.
- <3> Default setting value is dependent on parameter o2-04, Drive Model Selection.
- <4> Default setting value is dependent on parameter o2-04, Drive Model Selection and C6-01, Drive Duty Selection.
- <5> Values shown here are for 200 V class drives. Double the value when using a 400 V class drive.
- <6> Default setting value is dependent on parameter E1-01, Input Voltage Setting.
- <7> Setting value 2 is not available A1-02 = 5-PM OLV Control. When enabled, the drive stops accelerating when it exceeds the value of L3-02, Stall Prevention Level. The drive decelerates after 100 ms and begins accelerating again after restoring the current level.
- <8> Default setting value is 120% when C6-01 is set to 1 (ND) and 150% when C6-01 is set to 0 (HD).
- <9> The setting range depends on the control mode set in A1-02. For PM OLV Control the setting range is 0 to 2 and 7.
- <10> Default setting value is dependent on parameter E5-01, Motor Code Selection.
- <11> Parameter value is changed if E2-11 is manually changed or changed by Auto-Tuning.
- <12> Available in drive software versions PRG: 1016 and later.
- <13> Parameter setting value is not reset to the default value during drive initialization, A1-03 = 1110, 2220, 3330.
- <14> Available in drive software versions PRG: 1018 and later. There is normally no need to change this parameter from the default value.
- <15> Default setting is determined by drive software version and C6-02 setting. Drive software versions PRG: 1021 and later have a default setting of 0 when the carrier frequency is set for Leakage Current Rejection PWM (C6-02 = B), and 1 when C6-02 is set to any other value.
- <16> Parameter can be changed during Run.
- <17> Available in drive software versions PRG: 1021 and later.
- <18> The default setting and the upper limit of the setting range are determined by C6-01, Drive Duty Mode, and L8-38, Carrier Frequency Reduction Selection.

◆ n: Advanced Performance Set-Up

The n parameters are used to adjust more advanced performance characteristics such as hunting prevention, speed feedback detection, high-slip braking and R1 online tuning.

No.	Name	Description	Range	Def.	Control Mode			Addr. Hex	Pg.
					V/f	OLV	PM		
n1: Hunting Prevention Use n1 parameters to configure hunting prevention operation.									
n1-01	Hunting Prevention Selection	If the motor vibrates while lightly loaded, Hunting Prevention may reduce the vibration. 0: Disabled 1: Enabled When quick response is needed disable Hunting Prevention.	0, 1	1	A	-	-	580	240

B.2 Parameter Table

No.	Name	Description	Range	Def.	Control Mode			Addr. Hex	Pg.
					V/f	OLV	PM		
n1-02	Hunting Prevention Gain Setting	Sets the gain for the Hunting Prevention Function. If the motor vibrates while lightly loaded and n1-01 = 1, increase the gain by 0.1 until vibration ceases. If the motor stalls while n1-01 = 1, decrease the gain by 0.1 until the stalling ceases.	0.00 to 2.50	1.00	A	-	-	581	240
n1-03	Hunting Prevention Time Constant	Sets the time constant used for hunting prevention.	0 to 500	<I>	A	-	-	582	240
n1-05	Hunting Prevention Gain while in Reverse	Sets the gain used for Hunting Prevention. When set to 0, the gain n1-02 is used for operation in reverse direction.	0.00 to 2.50	0.00	A	-	-	530	240
n2: Speed Feedback Detection Control Function Use n2 parameters to configure the Speed Feedback Detection Control function operation.									
n2-01	Speed Feedback Detection Control (AFR) Gain	Sets the internal speed feedback detection control gain in the automatic frequency regulator (AFR). This parameter does not typically require adjustment. Adjust this parameter as follows: If hunting occurs, increase the set value. If response is low, decrease the set value.	0.00 to 10.00	<8>	-	A	-	584	240
			Adjust the setting by 0.05 units at a time, while checking the response.						
n2-02	Speed Feedback Detection Control (AFR) Time Constant	Sets the AFR time constant 1.	0 to 2000	50 ms	-	A	-	585	241
n2-03	Speed Feedback Detection Control (AFR) Time Constant 2	Sets the AFR time constant 2. Increase the setting if overvoltage occurs during sudden load changes or the speed overshoots during fast acceleration.	0 to 2000	750 ms	-	A	-	586	241
n3: High-Slip Braking Use n3 parameters to configure the high-slip braking function.									
n3-01	High-Slip Braking Deceleration Frequency Width	Sets the output frequency reduction step width when the drive stops the motor using high-slip braking (HSB). If Overvoltage (ov) faults occur during HSB, this parameter may need to be increased.	1 to 20	5%	A	-	-	588	241
n3-02	High-Slip Braking Current Limit	Sets the current limit during HSB. Higher n3-02 settings will shorten motor stopping times but increase the motor current, and therefore motor heating.	100 to 200	150%	A	-	-	589	242
n3-03	High-Slip Braking Dwell Time at Stop	Sets the time the drive will run with minimum frequency (E1-09) at the end of deceleration. If this time is set too low, the machine inertia can cause the motor to rotate slightly after HSB completion.	0.0 to 10.0	1.0 s	A	-	-	58A	242
n3-04	High-Slip Braking Overload Time	Sets the time required for an HSB overload fault (oL7) to occur when the drive output frequency does not change during an HSB stop. This parameter does not typically require adjustment.	30 to 1200	40 s	A	-	-	58B	242
n3-13	Overexcitation Deceleration Gain	Applies a gain to the V/f pattern during deceleration (L3-04 = 4). Returns to normal values after ramp to stop or at re-acceleration. To increase the braking power of overexcitation, increase the gain by 1.25 to 1.30.	1.00 to 1.40	1.10	A	A	-	531	242
n3-21	High-Slip Suppression Current Level	If overcurrent or overload occur during high-slip deceleration, reduce the high-slip suppression current level. Set as a percentage of the drive rated current.	0 to 150	100%	A	A	-	579	242
n3-23	Overexcitation Operation Selection	0: Enabled in both directions 1: Enabled only when rotating forward 2: Enabled only when in reverse	0 to 2	0	A	A	-	57B	242
n6: Online Tuning of Motor Line-to-Line Resistance Use n6 parameters to adjust the motor line-to-line resistance while the drive is online.									
n6-01	Line-to-Line Motor Resistance Online Tuning	Tunes the line-to-line motor resistance continuously during operation. 0: Disabled 1: Enabled	0, 1	1	-	A	-	570	243
n8: Permanent Magnet (PM) Motor Control Use n8 parameters to control the PM motor control.									

No.	Name	Description	Range	Def.	Control Mode			Addr. Hex	Pg.
					V/f	OLV	PM		
n8-45	Speed Feedback Detection Control Gain	Sets the gain for internal speed feedback detection control. This parameter does not typically require adjustment. Increase this setting if hunting occurs. Decrease to lower the response.	0.00 to 10.00	0.80	-	-	A	538	243
n8-47	Pull-In Current Compensation Time Constant	Sets the time constant to make the pull-in current and actual current value agree. Decrease the value if the motor begins to oscillate. Increase the value if it takes too long for the current reference to equal the output current.	0.0 to 100.0 s	5.0 s	-	-	A	53A	243
n8-48 <2>	Pull-In Current	Defines the amount of current provided to the motor during no-load operation at a constant speed. Set as a percentage of the motor rated current. Increase this setting when hunting occurs while running at a constant speed.	<3>	30%	-	-	A	53B	243
n8-49 <2>	d-Axis Current for High-Efficiency Control	Sets the amount of d-Axis current when using Energy Saving control.	<4>	0%	-	-	A	53C	243
n8-51	Acceleration Pull-In Current	Sets the pull-in current during acceleration as a percentage of the motor rated current (E5-03). Set to a high value when more starting torque is needed.	0 to 200%	50%	-	-	A	53E	244
n8-54	Voltage Error Compensation Time Constant	Sets the time constant for voltage error compensation. Adjust the value when hunting occurs at low speed. Increase in steps of 0.1 or disable the compensation by setting n8-45 to 0 when hunting occurs with sudden load changes or when oscillations occur at start.	0.00 to 10.00 s	1.00 s	-	-	A	56D	244
n8-55	Load Inertia	Sets the ratio between motor and machine inertia. 0: less than 1:10. 1: between 1:10 to 1:30. 2: between 1:30 to 1:50. 3: higher than 1:50.	0 to 3	0	-	-	A	56E	244
n8-62 <5>	Output Voltage Limit	Sets the limit for the output voltage. Adjustment is normally needed only if the input voltage is below the n8-62 set value. In this case set n8-62 to the input voltage.	0.0 to 230.0	200 Vac	-	-	A	57D	244
n8-63 <6>	Output Voltage Limit Gain 1	Sets the gain used for output voltage limit.	0.00 to 100.00	1.00	-	-	A	57E	245
n8-65 <7>	Speed Feedback Detection Control Gain during ov Suppression	Sets the gain used for internal speed feedback detection during ov Suppression	0.00 to 10.00	1.50	-	-	A	65C	245
n8-68 <6>	Output Voltage Limit Gain 2	Sets the voltage detection level adjustment gain.	0.50 to 1.50	0.95	-	-	A	237	245
n8-87 <6>	Output Voltage Limit Selection	Determines the method of the output voltage limit. 0: Feedback method 1: Feed forward method Use the feed forward method if oscillation occurs in the constant output range.	0, 1	0	-	-	A	2BC	245
n8-88 <6>	Output Voltage Limit Switching Current Level	Sets the current level to switch the output voltage limit sequence. Set as a percentage of the motor rated current (E5-03).	0 to 400%	400%	-	-	A	2BD	245
n8-89 <6>	Output Voltage Limit Switching Current Hysteresis Width	Determines the hysteresis of the current level to switch the output voltage limit sequence. Set as a percentage of the motor rated current (E5-03).	0 to [n8-88]	3%	-	-	A	2BE	245
n8-90 <6>	Output Voltage Limit Switching Speed	Sets the speed level to switch the output voltage limit sequence. Set as a percentage of the maximum output frequency (E1-04).	0 to 200%	200%	-	-	A	2BF	245
n8-91 <6>	Id Limit for Output Voltage Limit Control	Sets the amount of pull-in current that flows through the motor while operating at constant speed. Set as a percentage of the motor rated current (E5-03). Increase this setting if hunting occurs at constant speed.	-200 to 0%	-50%	-	-	A	2F7	246

<1> Default setting value is dependent on parameter o2-04, Drive Model Selection.

<2> Parameter can be changed during Run.

<3> Setting range varies depending on drive software version. Software versions PRG: 1018 and later disable pull-in current when n8-48 = 0 and allow this parameter to be changed during run.

PRG: 1018 and later: 0% or 20 to 200%

PRG: 1017 and earlier: 20 to 200%

B.2 Parameter Table

- <4> Setting range varies depending on drive software version. Software versions PRG: 1018 and later allow this parameter to be changed during run.
PRG: 1018 and later: -200.0 to 200.0%
PRG: 1017 and earlier: -200.0 to 0.0%
- <5> Values shown here are for 200 V class drives. Double the value when using a 400 V class drive.
- <6> Available in drive software versions PRG: 1018 and later. There is normally no need to change this parameter from the default value.
- <7> Parameter available in drive software versions PRG: 1011 and later.
- <8> Default setting is determined by drive model.
Models BA0001 to BA0012, 2A0001 to 2A0020, and 4A0001 to 4A0011: Setting 1.00.
Models BA0018, 2A0030 to 2A0069, and 4A0018 to 4A0038: Setting 1.50.

◆ o: Operator Related Parameters

o parameters are used to set up the LED digital operator displays.

No.	Name	Description	Range	Def.	Control Mode			Addr. Hex	Pg.
					V/f	OLV	PM		
o1: Display Settings Use o1 parameters to configure the digital operator display.									
o1-01 </>	Drive Mode Unit Monitor Selection	Switches the display after the power has been turned on. When using an LED operator, pressing the up arrow key will display the following data: frequency reference → rotational direction → output frequency → output current → output voltage → U1-□□. (This is done by entering the 1□□ part of U1-□□. Certain monitors are not available in some control modes.)	<2>	106	A	A	A	500	247
			Set to U1-06 as a default (Output Voltage Reference).						
o1-02 </>	User Monitor Selection After Power Up	Selects the information that is displayed when the power is turned on. 1: Frequency Reference (U1-01) 2: Forward/Reverse 3: Output Frequency (U1-02) 4: Output Current (U1-03) 5: User Monitor (set by o1-01)	1 to 5	1	A	A	A	501	247
o1-03	Digital Operator Display Selection	Sets the units to display the frequency reference and output frequency. 0: Hz 1: % (100% = E1-04) 2: r/min (enter the number of motor poles into E2-04/E4-04/E5-04) 3: User defined by parameters o1-10 and o1-11	0 to 3	0	A	A	A	502	247
o1-05 </> </>	LCD Contrast Control	Sets the brightness of the optional LCD operator.	0 to 5	3	A	A	A	504	248
o1-10	Frequency Reference Setting and User-Set Display	These settings define the display values when o1-03 is set to 3. o1-10 sets display values when operating at the maximum output frequency.	1 to 60000	<3>	A	A	A	520	248
o1-11	Frequency Reference Setting / Decimal Display	o1-11 sets the position of the decimal positions.	0 to 3	<3>	A	A	A	521	248
o2: Operator Keypad Functions Use o2 parameters to configure LED digital operator key functions.									
o2-01	LO/RE Key Function Selection	Enables/Disables the digital operator LO/RE key. 0: Disabled 1: Enabled	0, 1	1	A	A	A	505	248
o2-02	STOP Key Function Selection	Enables/Disables the operator panel STOP key when the drive is operated from external sources (not operator). 0: Disabled 1: Enabled	0, 1	1	A	A	A	506	248

No.	Name	Description	Range	Def.	Control Mode			Addr. Hex	Pg.
					V/f	OLV	PM		
o2-03	User Parameter Default Value	Allows storing of parameter settings as a User Initialization Selection (value 1110 for A1-03). The value returns to 0 after entering 1 or 2. 0: No Change 1: Set Defaults - Saves current parameter settings as user initialization. 2: Clear All - Clears the currently saved user initialization.	0 to 2	0	A	A	A	507	249
o2-04 <->	Drive Model Selection	Sets the drive model. This parameter only needs to be set when installing a new control board. Do not change for other reason.	0 to FF	<->	A	A	A	508	249
o2-05	Frequency Reference Setting Method Selection	Selects if the ENTER key must be pressed when inputting the frequency reference by the operator keypad. 0: Data/Enter key must be pressed to enter a frequency reference. 1: Data/Enter key is not required. The output frequency changes immediately when the reference is changed by the UP or DOWN keys on the digital operator. The ENTER key does not need to be pressed.	0, 1	0	A	A	A	509	249
o2-06	Operation Selection when Digital Operator is Disconnected	Sets drive action when the digital operator is removed in LOCAL mode or with b1-02 = 0. 0: The drive will continue operation 1: The drive will trigger a fault (oPr) and the motor will coast to stop	0, 1	0	A	A	A	50A	250
o2-07	Motor Direction at Power Up when Using Operator	0: Forward 1: Reverse This parameter requires that drive operation be assigned to the digital operator.	0, 1	0	A	A	A	527	250
o2-09	-	Factory use.	-	-	-	-	-	-	-
o3: Copy Function Use o3 parameters to Read, Copy and Verify the parameter settings to and from the drive.									
o3-01	Copy Function Selection	0: Copy select 1: INV → OP READ (Read parameters from the drive, saving them onto the digital operator.) 2: OP → INV WRITE (Copy parameters from the digital operator, writing them to the drive.) 3: OP → INV VERIFY (Verify parameter settings on the drive to check if they match the data saved on the operator.) To read the drive parameter settings into the digital operator, set o3-02 to 1 (to allow reading).	0 to 3	0	A	A	A	515	—
o3-02	Copy Allowed Selection	Locks the READ operation to prevent accidental overwriting of the data stored in the LED operator. 0: READ operation prohibited 1: READ operation allowed	0, 1	0	A	A	A	516	—
o4: Maintenance Period Use o4 parameters to perform maintenance.									
o4-01	Accumulated Operation Time Setting	Sets the value for the cumulative operation time of the drive in units of 10 h.	0 to 9999	0	A	A	A	50B	251
o4-02	Accumulated Operation Time Selection	Determines, how the cumulative operation time (U4-01) is counted. 0: Logs power-on time 1: Logs operation time when the drive output is active (output operation time).	0, 1	0	A	A	A	50C	251
o4-03	Cooling Fan Operation Time Setting	Sets the value of the fan operation time monitor U4-03 in units of 10 h. <6>	0 to 9999	0	A	A	A	50E	251
o4-05	Capacitor Maintenance Setting	Sets the value of the capacitor maintenance time monitor U4-05.	0 to 150	0%	A	A	A	51D	251
o4-07	DC Bus Pre-Charge Relay Maintenance Setting	Sets the value of the Soft Charge Bypass Relay Maintenance monitor U4-06.	0 to 150	0%	A	A	A	523	251
o4-09	IGBT Maintenance Setting	Sets the value of the IGBT Maintenance monitor U4-07.	0 to 150	0%	A	A	A	525	252

B.2 Parameter Table

No.	Name	Description	Range	Def.	Control Mode			Addr. Hex	Pg.
					V/f	OLV	PM		
o4-11	U2, U3 Initialization	0: U2-□□ and U3-□□ monitor data are not reset when the drive is initialized using A1-03. 1: U2-□□ and U3-□□ monitor data are reset when the drive is initialized using A1-03. (The value of o4-11 is automatically returned to 0.)	0, 1	0	A	A	A	510	252
o4-12	kWh Monitor Initialization	0: U4-10 and U4-11 monitor data are not reset when the drive is initialized using A1-03. 1: U4-10 and U4-11 monitor data are reset when the drive is initialized using A1-03. (The value of o4-12 is automatically returned to 0.)	0, 1	0	A	A	A	512	252
o4-13	Number of Run Commands Initialize Selection	0: U4-02 monitor data is not reset when the drive is initialized using A1-03. 1: U4-02 monitor data is reset when the drive is initialized using A1-03. (The value of o4-13 is automatically returned to 0.)	0, 1	0	A	A	A	528	252

<1> Parameter can be changed during run.

<2> Setting range is determined by drive software version.

PRG: 1016 and later: 104 to 810

PRG: 1015 and earlier: 104 to 621

<3> Default setting value is dependent on parameter o1-03, Digital Operator Display Selection.

<4> Parameter setting value is not reset to the default value during drive initialization, A1-03 = 1110, 2220, 3330

<5> Default setting value is dependent on parameter o2-04, Drive Model Selection.

<6> Available in drive software versions PRG: 1011 and later. Parameter o4-03 is set in 10 h units. When o4-03 = 30, the operation time for the cooling fan will start counting from 300 hours, and monitor U4-03 will display “300 H”. Earlier software versions set o4-03 in 1 h units.

<7> Available in drive software versions PRG: 1022 and later.

◆ q: DriveWorksEZ Parameters

No.	Name	Description	Range	Def.	Control Mode			Addr. Hex	Pg.
					V/f	OLV	PM		
q1-01 to q6-07	DriveWorksEZ Parameters	Reserved for DriveWorksEZ.	-	-	A	A	A	-	—

◆ r: DriveWorksEZ Connection Parameters

No.	Name	Description	Range	Def.	Control Mode			Addr. Hex	Pg.
					V/f	OLV	PM		
r1-01	DriveWorksEZ Connection Parameter 1 (upper)	Parameter 1 for connecting DriveWorksEZ (upper).	0 to FFFFH	0	-	A	A	1840	—
r1-02	DriveWorksEZ Connection Parameter 1 (lower)	Parameter 1 for connecting DriveWorksEZ (lower).	0 to FFFFH	0	-	A	A	1841	—
r1-03	DriveWorksEZ Connection Parameter 2 (upper)	Parameter 2 for connecting DriveWorksEZ (upper).	0 to FFFFH	0	-	A	A	1842	—
r1-04	DriveWorksEZ Connection Parameter 2 (lower)	Parameter 1 for connecting DriveWorksEZ (lower).	0 to FFFFH	0	-	A	A	1843	—
r1-05	DriveWorksEZ Connection Parameter 3 (upper)	Parameter 1 for connecting DriveWorksEZ (upper).	0 to FFFFH	0	-	A	A	1844	—
r1-06	DriveWorksEZ Connection Parameter 3 (lower)	Parameter 3 for connecting DriveWorksEZ (lower).	0 to FFFFH	0	-	A	A	1845	—
r1-07	DriveWorksEZ Connection Parameter 4 (upper)	Parameter 4 for connecting DriveWorksEZ (upper).	0 to FFFFH	0	-	A	A	1846	—

No.	Name	Description	Range	Def.	Control Mode			Addr. Hex	Pg.
					V/f	OLV	PM		
r1-08	DriveWorksEZ Connection Parameter 4 (lower)	Parameter 4 for connecting DriveWorksEZ (lower).	0 to FFFFH	0	-	A	A	1847	—
r1-09	DriveWorksEZ Connection Parameter 5 (upper)	Parameter 5 for connecting DriveWorksEZ (upper).	0 to FFFFH	0	-	A	A	1848	—
r1-10	DriveWorksEZ Connection Parameter 5 (lower)	Parameter 5 for connecting DriveWorksEZ (lower).	0 to FFFFH	0	-	A	A	1849	—
r1-11	DriveWorksEZ Connection Parameter 6 (upper)	Parameter 6 for connecting DriveWorksEZ (upper).	0 to FFFFH	0	-	A	A	184A	—
r1-12	DriveWorksEZ Connection Parameter 6 (lower)	Parameter 6 for connecting DriveWorksEZ (lower).	0 to FFFFH	0	-	A	A	184BH	—
r1-13	DriveWorksEZ Connection Parameter 7 (upper)	Parameter 7 for connecting DriveWorksEZ (upper).	0 to FFFFH	0	-	A	A	184C	—
r1-14	DriveWorksEZ Connection Parameter 7 (lower)	Parameter 7 for connecting DriveWorksEZ (lower).	0 to FFFFH	0	-	A	A	184D	—
r1-15	DriveWorksEZ Connection Parameter 8 (upper)	Parameter 8 for connecting DriveWorksEZ (upper).	0 to FFFFH	0	-	A	A	184E	—
r1-16	DriveWorksEZ Connection Parameter 8 (lower)	Parameter 8 for connecting DriveWorksEZ (lower).	0 to FFFFH	0	-	A	A	184F	—
r1-17	DriveWorksEZ Connection Parameter 9 (upper)	Parameter 9 for connecting DriveWorksEZ (upper).	0 to FFFFH	0	-	A	A	1850	—
r1-18	DriveWorksEZ Connection Parameter 9 (lower)	Parameter 9 for connecting DriveWorksEZ (lower).	0 to FFFFH	0	-	A	A	1851	—
r1-19	DriveWorksEZ Connection Parameter 10 (upper)	Parameter 10 for connecting DriveWorksEZ (upper).	0 to FFFFH	0	-	A	A	1852	—
r1-20	DriveWorksEZ Connection Parameter 10 (lower)	Parameter 10 for connecting DriveWorksEZ (lower).	0 to FFFFH	0	-	A	A	1853	—
r1-21	DriveWorksEZ Connection Parameter 11 (upper)	Parameter 11 for connecting DriveWorksEZ (upper).	0 to FFFFH	0	-	A	A	1854	—
r1-22	DriveWorksEZ Connection Parameter 11 (lower)	Parameter 11 for connecting DriveWorksEZ (lower).	0 to FFFFH	0	-	A	A	1855	—
r1-23	DriveWorksEZ Connection Parameter 12 (upper)	Parameter 12 for connecting DriveWorksEZ (upper).	0 to FFFFH	0	-	A	A	1856	—
r1-24	DriveWorksEZ Connection Parameter 12 (lower)	Parameter 12 for connecting DriveWorksEZ (lower).	0 to FFFFH	0	-	A	A	1857	—
r1-25	DriveWorksEZ Connection Parameter 13 (upper)	Parameter 13 for connecting DriveWorksEZ (upper).	0 to FFFFH	0	-	A	A	1858	—
r1-26	DriveWorksEZ Connection Parameter 13 (lower)	Parameter 13 for connecting DriveWorksEZ (lower).	0 to FFFFH	0	-	A	A	1859	—
r1-27	DriveWorksEZ Connection Parameter 14 (upper)	Parameter 14 for connecting DriveWorksEZ (upper).	0 to FFFFH	0	-	A	A	185A	—
r1-28	DriveWorksEZ Connection Parameter 14 (lower)	Parameter 14 for connecting DriveWorksEZ (lower).	0 to FFFFH	0	-	A	A	185B	—
r1-29	DriveWorksEZ Connection Parameter 15 (upper)	Parameter 15 for connecting DriveWorksEZ (upper).	0 to FFFFH	0	-	A	A	185C	—
r1-30	DriveWorksEZ Connection Parameter 15 (lower)	Parameter 15 for connecting DriveWorksEZ (lower).	0 to FFFFH	0	-	A	A	185D	—
r1-31	DriveWorksEZ Connection Parameter 16 (upper)	Parameter 16 for connecting DriveWorksEZ (upper).	0 to FFFFH	0	-	A	A	185E	—
r1-32	DriveWorksEZ Connection Parameter 16 (lower)	Parameter 16 for connecting DriveWorksEZ (lower).	0 to FFFFH	0	-	A	A	185F	—
r1-33	DriveWorksEZ Connection Parameter 17 (upper)	Parameter 17 for connecting DriveWorksEZ (upper).	0 to FFFFH	0	-	A	A	1860	—
r1-34	DriveWorksEZ Connection Parameter 17 (lower)	Parameter 17 for connecting DriveWorksEZ (lower).	0 to FFFFH	0	-	A	A	1861	—
r1-35	DriveWorksEZ Connection Parameter 18 (upper)	Parameter 18 for connecting DriveWorksEZ (upper).	0 to FFFFH	0	-	A	A	1862	—

B.2 Parameter Table

No.	Name	Description	Range	Def.	Control Mode			Addr. Hex	Pg.
					V/f	OLV	PM		
r1-36	DriveWorksEZ Connection Parameter 18 (lower)	Parameter 18 for connecting DriveWorksEZ (lower).	0 to FFFFH	0	-	A	A	1863	—
r1-37	DriveWorksEZ Connection Parameter 19 (upper)	Parameter 19 for connecting DriveWorksEZ (upper).	0 to FFFFH	0	-	A	A	1864	—
r1-38	DriveWorksEZ Connection Parameter 19 (lower)	Parameter 19 for connecting DriveWorksEZ (lower).	0 to FFFFH	0	-	A	A	1865	—
r1-39	DriveWorksEZ Connection Parameter 20 (upper)	Parameter 20 for connecting DriveWorksEZ (upper).	0 to FFFFH	0	-	A	A	1866	—
r1-40	DriveWorksEZ Connection Parameter 20 (lower)	Parameter 20 for connecting DriveWorksEZ (lower).	0 to FFFFH	0	-	A	A	1867	—

◆ T: Motor Tuning

Enter data into the following parameters to tune the motor and drive for optimal performance

No.	Name	Description	Range	Def.	Control Mode			Addr. Hex	Pg.
					V/f	OLV	PM		
T1-00	Motor Selection 1/2	Selects which set of motor parameters are used and set during Auto-Tuning. If Motor 2 selection (H1-□□ = 16) is not selected, this parameter will not be displayed. 1: Motor 1 (sets E1-□□, E2-□□) 2: Motor 2 (sets E3-□□, E4-□□. This selection is not displayed if motor 2 has not been selected.)	1, 2	1	A	A	-	700	106
T1-01	Auto-Tuning Mode Selection	Selects the Auto-Tuning mode. 0: Rotational Auto-Tuning 2: Stationary Auto-Tuning for Line-to-Line Resistance 3: Rotational Auto-Tuning for V/f Control (necessary for Energy Savings and Speed Estimation type Speed Search)	0, 2, 3 <2>	2 or 3 in V/f 0 or 2 in OLV 2 in Motor 2	A	A	-	701	106
T1-02	Motor Rated Power	Sets the motor rated power in kilowatts (kW). Note: If motor power is given in horsepower, power in kW can be calculated using the following formula: kW = HP x 0.746.	<2>	<3>	A	A	-	702	106
T1-03 <4>	Motor Rated Voltage	Sets the motor rated voltage in volts (V).	0.0 to 255.5	200.0 V	A	A	-	703	107
T1-04	Motor Rated Current	Sets the motor rated current in amperes (A).	10 to 200% of drive rated current	<3>	A	A	-	704	107
T1-05	Motor Base Frequency	Sets the base frequency of the motor in Hertz (Hz).	0.0 to 400.0	60.0 Hz	A	A	-	705	107
T1-06	Number of Motor Poles	Sets the number of motor poles.	2 to 48	4	A	A	-	706	107
T1-07	Motor Base Speed	Sets the base speed of the motor in revolutions per minute r/min (RPM).	0 to 24000	1750 r/min	A	A	-	707	107
T1-11	Motor Iron Loss	Provides the iron loss for determining the Energy Saving coefficient. The value set to E2-10 (motor iron loss) when the power is cycled. If T1-02 is changed, an initial value valid for the selected capacity will be shown.	0 to 65535	14 W	A	-	-	70B	107

<1> The available tuning methods depend on control mode. Select values 2 or 3 in V/f Control, 0 or 2 in OLV control, and 2 for Motor 2 control.

<2> Setting range varies depending on drive software version.

PRG: 1016 and later: 0.03 to 650.00 kW

PRG: 1015 and earlier: 0.00 to 650.00 kW

<3> Default setting value is dependent on parameter o2-04, Drive Model Selection.

<4> Values shown here are for 200 V class drives. Double the value when using a 400 V class drive.

◆ U: Monitors

Monitor parameters allow the user to view drive status, fault information, and other information about drive operation.

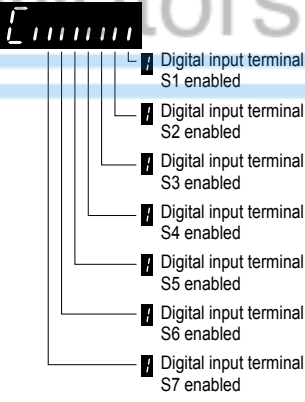
No.	Name	Description	Analog Output Level	Unit	Control Mode			Addr. Hex
					V/f	OLV	PM	
U1: Operation Status Monitors Use U1 monitors to display the operation status of the drive.								
U1-01	Frequency Reference	Monitors the frequency	10 V: Max frequency	0.01 Hz	A	A	A	40
U1-02	Output Frequency	Displays the output frequency. Display units are determined by o1-03.	10 V: Max frequency	0.01 Hz	A	A	A	41
U1-03	Output Current	Displays the output current.	10 V: Drive rated current	0.01 A <-> <->	A	A	A	42
U1-04	Control Mode	Control method set in A1-02. 0: V/f without PG 2: Open Loop Vector (OLV) 5: PM Open Loop Vector (PM)	No output signal available	–	A	A	A	43
U1-05	Motor Speed	Displays the motor speed feedback. Display units are determined by o1-03.	10 V: Maximum speed	0.01 Hz	–	A	–	44
U1-06	Output Voltage Reference	Displays the output voltage.	10 V: 200 Vrms (400 Vrms)	0.1 V	A	A	A	45
U1-07	DC Bus Voltage	Displays the DC bus voltage.	10 V: 400 V (800 V)	1 V	A	A	A	46
U1-08	Output Power	Displays the output power (this value is determined internally).	10 V: Drive capacity (kW) (rated motor capacity)	<->	A	A	A	47
U1-09	Torque Reference	Monitor of internal torque reference value for Open Loop Vector (OLV) control	10 V: Motor rated torque	–	–	A	–	48
U1-10	Input Terminal Status	Displays the input terminal status. 	No output signal available	–	A	A	A	49

B.2 Parameter Table

No.	Name	Description	Analog Output Level	Unit	Control Mode			Addr. Hex
					V/f	OLV	PM	
U1-11	Output Terminal Status	Displays the output terminal status. 	No output signal available	–	A	A	A	4A
U1-12	Drive Status	Verifies the drive operation status. 	No output signal available	–	A	A	A	4B
U1-13	Terminal A1 Input Level	Displays analog input A1 level: 100% when input is 10 V.	10 V: 100%	0.1%	A	A	A	4E
U1-14	Terminal A2 Input Level	Displays analog input A2 level: 100% when input is 10 V.	10 V: 100%	0.1%	A	A	A	4F
U1-16	Output Frequency after Soft Starter	Displays output frequency with ramp time and S-curves. Units determined by o1-03.	10 V: Max frequency	0.01 Hz	A	A	A	53
U1-18	oPE Fault Parameter	Displays parameter no. for oPE□□ or Err where error occurred.	No output signal available	–	A	A	A	61
U1-19	MEMOBUS/Modbus Error Code	Displays the contents of a MEMOBUS/Modbus error. 	No output signal available	–	A	A	A	66
U1-24	Input Pulse Monitor	Displays the Pulse Train input RP frequency.	32000	1 Hz	A	A	A	7D
U1-25	Software No. (Flash)	Flash ID	No signal output avail.	–	A	A	A	4D
U1-26	Software No. (ROM)	ROM ID	No signal output avail.	–	A	A	A	5B
U1-27	Operator Message ID	Displays the numeric code of the remote operator (for use by the manufacturer).	No signal output avail.	–	A	A	A	7A8
U1-28	Drive Message ID	Displays the numeric code of the drive (for use by the manufacturer)	No signal output avail.	–	A	A	A	7A9
U2: Fault Trace Use U2 monitors to view fault trace data. <>								
U2-01	Current Fault	Displays the current fault.	No signal output avail.	–	A	A	A	80

No.	Name	Description	Analog Output Level	Unit	Control Mode			Addr. Hex
					V/f	OLV	PM	
U2-02	Previous Fault	Displays the previous fault.	No signal output avail.	–	A	A	A	81
U2-03	Frequency Reference at Previous Fault	Displays the frequency reference at the previous fault.	No signal output avail.	0.01 Hz	A	A	A	82
U2-04	Output Frequency at Previous Fault	Displays the output frequency at the previous fault.	No signal output avail.	0.01 Hz	A	A	A	83
U2-05	Output Current at Previous Fault	Displays the output current at the previous fault.	No signal output avail.	<v> <v>	A	A	A	84
U2-06	Motor Speed at Previous Fault	Displays the motor speed at the previous fault.	No signal output avail.	0.01 Hz	–	A	–	85
U2-07	Output Voltage at Previous Fault	Displays the output voltage at the previous fault.	No signal output avail.	0.1 V	A	A	A	86
U2-08	DC Bus Voltage at Previous Fault	Displays the DC bus voltage at the previous fault.	No signal output avail.	1 V	A	A	A	87
U2-09	Output Power at Previous Fault	Displays the output power at the previous fault.	No signal output avail.	0.1 kW	A	A	A	88
U2-10	Torque Reference at Previous Fault	Displays the torque reference at the previous fault.	No signal output avail.	0.1%	–	A	–	89
U2-11	Input Terminal Status at Previous Fault	Displays the input terminal status at the previous fault. Displayed as in U1-10.	No signal output avail.	–	A	A	A	8A
U2-12	Output Terminal Status at Previous Fault	Displays the output status at the previous fault. Displays the same status displayed in U1-11.	No signal output avail.	–	A	A	A	8B
U2-13	Drive Operation Status at Previous Fault	Displays the operation status of the drive at the previous fault. Displays the same status displayed in U1-12.	No signal output avail.	–	A	A	A	8C
U2-14	Cumulative Operation Time at Previous Fault	Displays the cumulative operation time at the previous fault.	No signal output avail.	1 H	A	A	A	8D
U2-15	Soft Starter Speed Reference at Previous Fault	Displays the run speed after a soft start when a previous fault occurred. Displayed as in U1-16.	No signal output avail.	0.01 %	A	A	A	7E0
U2-16	Motor q-Axis Current at Previous Fault	Displays the q-axis current for the motor at the previous fault.	No signal output avail.	0.10 %	A	A	A	7E1
U2-17	Motor d-Axis Current at Previous Fault	Displays the d-axis current for the motor at the previous fault.	No signal output avail.	0.10 %	–	A	A	7E2
U3: Fault History Use U3 monitors to display fault data. <v>								
U3-01	Most Recent Fault	Displays the most recent fault.	No signal output avail.	–	A	A	A	90 (800)
U3-02	2nd Most Recent Fault	Displays the second most recent fault.	No signal output avail.	–	A	A	A	91 (801)
U3-03	3rd Most Recent Fault	Displays the third most recent fault.	No signal output avail.	–	A	A	A	92 (802)
U3-04	4th Most Recent Fault	Displays the fourth most recent fault.	No signal output avail.	–	A	A	A	93 (803)
U3-05	5th Most Recent Fault	Displays the fifth most recent fault.	No signal output avail.	–	A	A	A	804
U3-06	6th Most Recent Fault	Displays the sixth most recent fault.	No signal output avail.	–	A	A	A	805
U3-07	7th Most Recent Fault	Displays the seventh most recent fault.	No signal output avail.	–	A	A	A	806
U3-08	8th Most Recent Fault	Displays the eighth most recent fault.	No signal output avail.	–	A	A	A	807
U3-09	9th Most Recent Fault	Displays the ninth most recent fault.	No signal output avail.	–	A	A	A	808
U3-10	10th Most Recent Fault	Displays the tenth most recent fault.	No signal output avail.	–	A	A	A	809
U3-11	Cumulative Operation Time at Most Recent Fault	Displays the cumulative operation time at the most recent fault.	No signal output avail.	1 h	A	A	A	94 (80A)

B.2 Parameter Table

No.	Name	Description	Analog Output Level	Unit	Control Mode			Addr. Hex
					V/f	OLV	PM	
U3-12	Cumulative Operation Time at 2nd Most Recent Fault	Displays the cumulative operation time at the second most recent fault.	No signal output avail.	1 h	A	A	A	95 (80B)
U3-13	Cumulative Operation Time at 3rd Most Recent Fault	Displays the cumulative operation time at the third most recent fault.	No signal output avail.	1 h	A	A	A	96 (80C)
U3-14	Cumulative Operation Time at 4th Most Recent Fault	Displays the cumulative operation time at the fourth most recent fault.	No signal output avail.	1 h	A	A	A	97 (80D)
U3-15	Cumulative Operation Time at 5th Most Recent Fault	Displays the cumulative operation time at the fifth most recent fault.	No signal output avail.	1 h	A	A	A	80E
U3-16	Cumulative Operation Time at 6th Most Recent Fault	Displays the cumulative operation time at the sixth most recent fault.	No signal output avail.	1 h	A	A	A	80F
U3-17	Cumulative Operation Time at 7th Most Recent Fault	Displays the cumulative operation time at the seventh most recent fault.	No signal output avail.	1 h	A	A	A	810
U3-18	Cumulative Operation Time at 8th Most Recent Fault	Displays the cumulative operation time at the eighth most recent fault.	No signal output avail.	1 h	A	A	A	811
U3-19	Cumulative Operation Time at 9th Most Recent Fault	Displays the cumulative operation time at the ninth most recent fault.	No signal output avail.	1 h	A	A	A	812
U3-20	Cumulative Operation Time at 10th Most Recent Fault	Displays the cumulative operation time at the tenth most recent fault.	No signal output avail.	1 h	A	A	A	813
U4: Maintenance Monitors Use U4 monitors to display drive maintenance information.								
U4-01 <>	Accumulated Operation Time	Displays the cumulative operation time of the drive. The value for the cumulative operation time counter can be reset in parameter o4-01. Use parameter o4-02 to determine if the operation time should start as soon as the power is switched on or only while the run command is present. The maximum number displayed is 99999, after which the value is reset to 0.	No signal output avail.	1 h	A	A	A	4C
U4-02	Number of Run Commands	Displays the number of times the run command is entered. Reset the number of run commands using parameter o4-13. This value will reset to 0 and start counting again after reaching 65535.	No signal output avail.	–	A	A	A	75
U4-03 <> <>	Cooling Fan Operation Time	Displays the cumulative operation time of the cooling fan. The default value for the fan operation time is reset in parameter o4-03. This value will reset to 0 and start counting again after reaching 99999. <>	No signal output avail.	1 h	A	A	A	67
U4-04	Cooling Fan Maintenance	Displays main cooling fan usage time in as a percentage of their expected performance life. Parameter o4-03 can be used to reset this monitor.	No signal output avail.	1%	A	A	A	7E
U4-05	Capacitor Maintenance	Displays main circuit capacitor usage time in as a percentage of their expected performance life. Parameter o4-05 can be used to reset this monitor.	No signal output avail.	1%	A	A	A	7C
U4-06 <>	Soft Charge Bypass Relay Maintenance	Displays the soft charge bypass relay maintenance time as a percentage of the estimated product life. Parameter o4-07 can be used to reset this monitor.	No signal output avail.	1%	A	A	A	7D6
U4-07 <>	IGBT Maintenance	Displays IGBT usage time as a percent of expected performance life. Parameter o4-09 can be used to reset this monitor.	No signal output avail.	1%	A	A	A	7D7
U4-08 <>	Heatsink Temperature	Displays the heatsink temperature.	10 V: 100 °C	1 °C	A	A	A	68
U4-09	LED Check	Lights all segments of the LED to verify that the display is working properly.	No signal output avail.	–	A	A	A	3C
U4-10	kWh, Lower 4 Digits	Monitors the drive output power. The value is shown as a 9 digit number displayed across two monitor parameters, U4-10 and U4-11. Example: 12345678.9 kWh is displayed as: U4-10: 678.9 kWh U4-11: 12345 MWh	No signal output avail.	kWh	A	A	A	5C
U4-11	kWh, Upper 5 Digits			MWh	A	A	A	5D

No.	Name	Description	Analog Output Level	Unit	Control Mode			Addr. Hex
					V/f	OLV	PM	
U4-13	Peak Hold Current	Displays the peak hold current during run.	No signal output avail.	0.01 A ↔	A	A	A	7CF
U4-14	Peak Hold Output Frequency	Displays the output frequency when operating at the peak hold current.	No signal output avail.	0.01 Hz	A	A	A	7D0
U4-16	Motor Overload Estimate (oL1)	100% = oL1 detection level	100% = oL1 detection level	0.1%	A	A	A	7D8
U4-18	Frequency Reference Source Selection	Displays the source for the frequency reference as XY-nn. X: indicates which reference is used: 1 = Reference 1 (b1-01) 2 = Reference 2 (b1-15) Y-nn: indicates the reference source 0-01 = Operator (d1-01) 1-01 = Analog (terminal A1) 1-02 = Analog (terminal A2) 2-02 to 17 = Multi-step speed (d1-02 to 17) 3-01 = MEMOBUS/Modbus comm. 4-01 = Option 5-01 = Pulse Input 6-01 = CASE 7-01 = DWEZ	-	-	A	A	A	7DA
U4-19	Frequency Reference from MEMOBUS/Modbus Comm.	Displays the frequency reference provided by MEMOBUS/Modbus (decimal).	-	-	A	A	A	7DB
U4-20	Option Frequency Reference	Displays the frequency reference input by an option card (decimal).	-	-	A	A	A	7DD
U4-21	Run Command Source Selection	Displays the source for the Run command as XY-nn. X: Indicates which Run source is used: 1 = Reference 1 (b1-02) 2 = Reference 2 (b1-16) Y: Input power supply data 0 = Operator 1 = External terminals 2 = Not used 3 = MEMOBUS/Modbus communications 4 = Option 5 = Not used 6 = CASE 7 = DWEZ nn: Run command limit status data 00: No limit status. 01: Run command was left on when stopped in the PRG mode. 02: Run command was left on when switching from LOCAL to REMOTE operation. 03: Waiting for the soft charge bypass contactor after the power is switched on (Uv or Uv1 flashes after 10 seconds). 04: Waiting for "Run Command Prohibited" time period to end. 05: Fast-stop (digital input (H1-□□ = 15), operator) 06: b1-17 (run command given at power-up). 07: During Baseblock while coast to stop with timer 08: Frequency reference is below minimal reference during Baseblock 09: Waiting for Enter command 10: Run command was switched on while copying parameters	-	-	A	A	A	7DD
U4-22	MEMOBUS/Modbus Communications Reference	Displays the drive control data set by MEMOBUS/Modbus communications register No. 0001H as a 4 digit hexadecimal number.	-	-	A	A	A	7DE
U4-23	Option Card Reference	Displays drive control data set by an option card as a 4 digit hexadecimal number.	-	-	A	A	A	7DF

U5: PID Monitor

Use U5 monitors to view application-specific settings.

B.2 Parameter Table

No.	Name	Description	Analog Output Level	Unit	Control Mode			Addr. Hex
					V/f	OLV	PM	
U5-01	PID Feedback	Displays the PID feedback value in.	10 V: 100% (max. freq.)	0.01 %	A	A	A	57
U5-02	PID Input	Displays the amount of PID input (deviation between PID target and feedback).		0.01 %	A	A	A	63
U5-03	PID Output	Displays PID control output.		0.01 %	A	A	A	64
U5-04	PID Setpoint	Displays the PID setpoint.		0.01 %	A	A	A	65
U5-05	PID Differential Feedback	Displays the 2nd PID feedback value if differential feedback is used.		0.01 %	A	A	A	7D2
U5-06	PID Adjusted Feedback	Displays the difference of both feedback values if differential feedback is used (U5-01) - (U5-05). If differential feedback is not used, then U5-01 and U5-06 will be the same.		0.01 %	A	A	A	7D3
U6: Control Monitor Use U6 monitors to display drive control information.								
U6-01	Motor Secondary Current (Iq)	Displays the value of the motor secondary current (Iq).	10 V: 100%	0.1%	A	A	A	51
U6-02	Motor Excitation Current (Id)	Displays the value calculated for the motor excitation current (Id).	10 V: 100%	0.1%	–	A	A	52
U6-03	ASR Input	Displays the ASR input value if V/f Control with Simple PG Feedback is enabled.	10 V: 100% (max. freq.)	0.1%	A	–	–	54
U6-04	ASR Output	Displays the ASR output value if V/f Control with Simple PG Feedback is enabled.	10 V: 100% (max. freq.)	0.1%	A	–	–	55
U6-05	Output voltage reference (Vq)	Output voltage reference (Vq). (q-axis)	10 V: 200 V (400 V)	0.1 Vac	–	A	A	59
U6-06	Output Voltage Reference (Vd)	Output voltage reference (Vd). (d-axis)	10 V: 200 V (400 V)	0.1 Vac	–	A	A	5A
U6-07	q-axis ACR Output	Displays the current control (ACR) output of for the motor secondary current (Iq).	10 V: 100%	0.1%	–	A	–	5F
U6-08	d-Axis ACR Output	Displays the current control (ACR) output of for the motor excitation current (Id).	10 V: 100%	0.1%	–	A	–	60
U6-20	Frequency Reference Bias (Up/Down 2)	Displays the bias value used to adjust the frequency reference.	10 V: max. frequency	0.1%	A	A	A	7D4
U6-21	Offset Frequency	The total value of the offset frequencies d7-01, d7-02 and d7-03 selected with digital inputs 44 to 46 is displayed.	10 V: max. frequency	0.1%	A	A	A	7D5
U6-80 to U6-99	Option Monitors 1 to 20	Monitors reserved for use by the communication option card. Monitor content varies based on the communication option connected to the drive. Refer to the instruction manual for the option card for more information..	No signal output avail.	–	A	A	A	7B0 to 7F9
U8: Custom Monitors for DriveWorksEZ U8 monitors are reserved for DriveWorksEZ								
U8-01	–	Reserved for DriveWorksEZ, Monitor 1.	–	0.01 %	A	A	A	1950
U8-02	–	Reserved for DriveWorksEZ, Monitor 2.	–	0.01 %	A	A	A	1951
U8-03	–	Reserved for DriveWorksEZ, Monitor 3.	–	0.01 %	A	A	A	1952
U8-04	–	Reserved for DriveWorksEZ, Monitor 4.	–	0.01 %	A	A	A	1953
U8-05	–	Reserved for DriveWorksEZ, Monitor 5.	–	0.01 %	A	A	A	1954
U8-06	–	Reserved for DriveWorksEZ, Monitor 6.	–	0.01 %	A	A	A	1955
U8-07	–	Reserved for DriveWorksEZ, Monitor 7.	–	0.01 %	A	A	A	1956

No.	Name	Description	Analog Output Level	Unit	Control Mode			Addr. Hex
					V/f	OLV	PM	
U8-08	–	Reserved for DriveWorksEZ, Monitor 8.	–	0.01 %	A	A	A	1957
U8-09	–	Reserved for DriveWorksEZ, Monitor 9.	–	0.01 %	A	A	A	1958
U8-10	–	Reserved for DriveWorksEZ, Monitor 10.	–	0.01 %	A	A	A	1959

- <1> Display is in the following units: BA0001 to BA0018, 2A0001 to 2A0040, and 4A0001 to 4A0023: 0.01 A units.
2A0056 to 2A0069, 4A0031 to 4A0038: 0.1 A units.
- <2> U1-03, U2-05, and U4-13 display monitor contents in amp units. When reading the value of these monitors via MEMOBUS/Modbus, a value of 8192 is equal to 100% of the drive rated output current.
- <3> Parameter setting value is not reset to the default value during drive initialization, A1-03 = 1110, 2220, 3330
- <4> Available in drive software versions PRG: 1011 and later. Maximum value is 65536 in drive software versions PRG: 1010 and earlier.
- <5> When this value reaches 100%, the maintenance period has been reached for the component in question and the drive is at risk of faulting out due to component failure. Periodically check the maintenance monitors to avoid this situation.
- <6> Available in drive software versions PRG: 1011 and later.
- <7> MEMOBUS/Modbus communications data is in 10 h units. If data in 1 h units are also required, refer to register 0099H.
- <8> MEMOBUS/Modbus communications data is in 10 h units. If data in 1 h units are also required, refer to register 009BH.

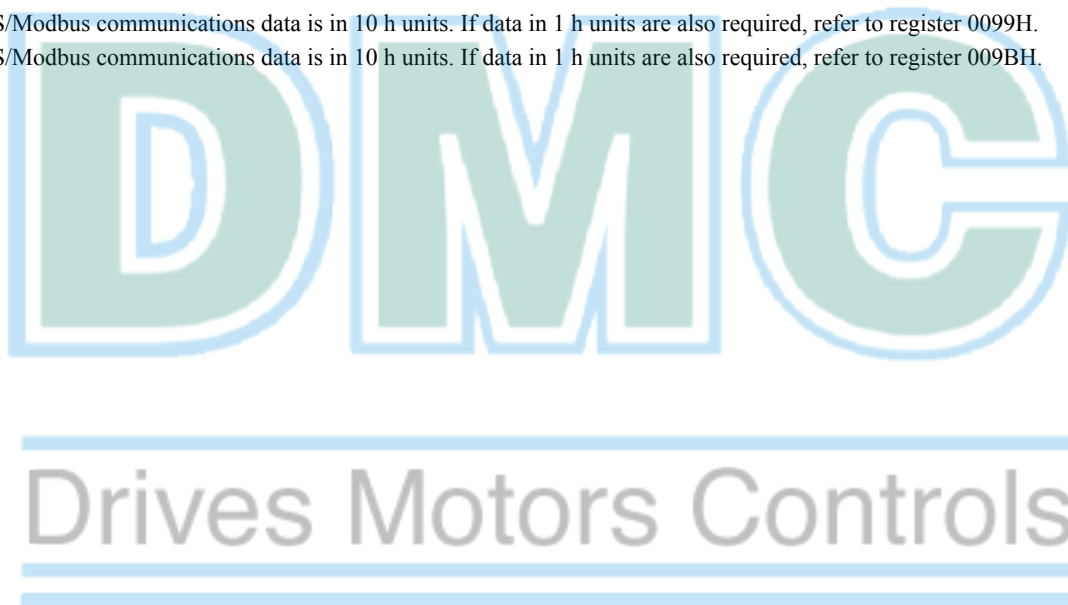

B.3 Control Mode Dependent Parameter Default Values

The tables below list parameters that depend on the control mode selection (A1-02 for motor 1, E3-01 for motor 2). These parameters are initialized to the shown values if the control mode is changed.

◆ A1-02 (Motor 1 Control Mode) Dependent Parameters

Table B.1 A1-02 (Motor 1 Control Mode) Dependent Parameters and Default Values

Parameter	Description	Setting Range	Resolution	Control Modes (A1-02)		
				V/f (0)	OLV (2)	PM (5)
b3-02	Speed Search deactivation current	0 to 200	1%	120	100	–
b3-08	Current Control Gain during Speed Search (Speed Estimation Type)	0.00 to 6.00	–	0.50 <1>	0.50 <1>	0.30
b8-02	Energy Saving gain	0.0 to 10.0	0.1	–	0.7	–
C2-01	S-curve time at acceleration start	0.00 to 10.00	0.01 s	0.20	0.20	1.00
C3-01	Slip compensation gain	0.0 to 2.5	0.1	0.0	1.0	–
C3-02	Slip compensation time constant	0 to 10000	1 ms	2000	200	–
C4-01	Torque compensation gain	0.00 to 2.50	0.01	1.00	1.00	0.00
C4-02	Torque comp. primary delay time	0 to 10000	1 ms	200	20	100
C6-02	Carrier frequency	1 to F	1	7 <1>	7 <1>	2
E1-04	Maximum output frequency	40.0 to 400.0	0.1 Hz	60.0	60.0	<3>
E1-05	Maximum output voltage <2>	0.0 to 255.0	0.1 V	230.0	230.0	<3>
E1-06	Base Frequency	0.0 to 400.0	0.1 Hz	60.0	60.0	<3>
E1-07	Middle output frequency	0.0 to 400.0	0.1 Hz	3.0	3.0	–
E1-08	Middle output freq. voltage <2>	0.0 to 255.0	0.1 V	18.4	13.8	–
E1-09	Minimum output frequency	0.0 to 400.0	0.1 Hz	1.5	0.5	<3>
E1-10	Minimum output voltage <2>	0.0 to 255.0	0.1 V	13.8	2.9	–
E1-11	Middle output frequency 2	0.0 to 400.0	0.1 Hz	0.0	0.0	–
E1-12	Middle output freq. voltage 2 <2>	0.0 to 255.0	0.1 V	0.0	0.0	–
E1-13	Base voltage <2>	0.0 to 255.0	0.1 V	0.0	0.0	–
L1-01	Motor protection selection	0 to 4	–	1	1	4
L3-20	Main power circuit voltage adjustment gain	0.00 to 5.00	0.01	1.00	0.30	0.65
L3-21	Accel/decel rate calculation gain	0.00 to 200.00	0.01	1.00	1.00	2.50

<1> Default setting value is dependent on parameter o2-04, Drive Model Selection.

<2> Values shown here are for 200 V class drives. Double the value when using a 400 V class drive.

<3> Default setting value is dependent on parameter E5-01, Motor Code Selection.

◆ E3-01 (Motor 2 Control Mode) Dependent Parameters

Table B.2 E3-01 (Motor 2 Control Mode) Dependent Parameters and Default Values

Parameter	Description	Setting Range	Resolution	Control Modes (E3-01)	
				V/f (0)	OLV (2)
E3-04	Maximum output frequency	40.0 to 400.0	0.1 Hz	60.0	60.0
E3-05	Maximum output voltage <1>	0.0 to 255.0	0.1 V	200.0	230.0
E3-06	Base Frequency	0.0 to 400.0	0.1 Hz	60.0	60.0
E3-07	Middle output frequency	0.0 to 400.0	0.1 Hz	3.0	3.0
E3-08	Middle output freq. voltage <1>	0.0 to 255.0	0.1 V	18.4	13.8
E3-09	Minimum output frequency	0.0 to 400.0	0.1 Hz	1.5	0.5
E3-10	Minimum output voltage <1>	0.0 to 255.0	0.1 V	13.8	2.9
E3-11	Middle output frequency 2	0.0 to 400.0	0.1 Hz	0.0	0.0
E3-12	Middle output freq. voltage 2 <1>	0.0 to 255.0	0.1 V	0.0	0.0
E3-13	Base voltage <1>	0.0 to 255.0	0.1 V	0.0	0.0
E3-14	Motor 2 Slip compensation gain	0.0 to 2.5	0.1	0.0	1.0

<1> Values shown here are for 200 V class drives. Double the value when using a 400 V class drive.

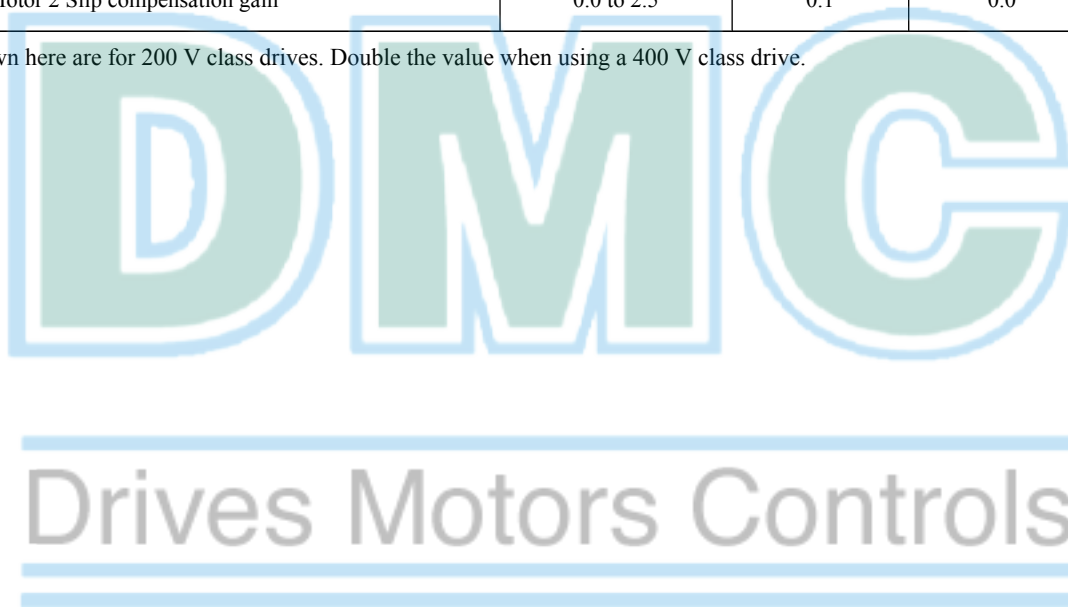

B.4 V/f Pattern Default Values

The tables below show the V/f pattern settings default values depending on the control mode (A1-02) and the V/f pattern selection (E1-03 in V/f Control).

Table B.3 E1-03 V/f Pattern Settings for Drive Capacity: Models BA0001 to BA0010, 2A0001 to 2A0010, and 4A0001 to 4A0005

No.	Unit	V/f Control																OLV
		0	1	2	3	4	5	6	7	8	9	A	B	C	D	E	F	
E1-03	-	0	1	2	3	4	5	6	7	8	9	A	B	C	D	E	F	OLV
E1-04	Hz	50.0	60.0	60.0	72.0	50.0	50.0	60.0	60.0	50.0	50.0	60.0	60.0	90.0	120	180	60.0	60.0
E1-05 </>	V	200	200	200	200	200	200	200	200	200	200	200	200	200	200	200	230	230
E1-06	Hz	50.0	60.0	50.0	60.0	50.0	50.0	60.0	60.0	50.0	50.0	60.0	60.0	60.0	60.0	60.0	60.0	60.0
E1-07	Hz	2.5	3.0	3.0	3.0	25.0	25.0	30.0	30.0	2.5	2.5	3.0	3.0	3.0	3.0	3.0	3.0	3.0
E1-08 </>	V	16.0	16.0	16.0	16.0	35.0	50.0	35.0	50.0	19.0	24.0	19.0	24.0	16.0	16.0	16.0	18.4	13.8
E1-09	Hz	1.3	1.5	1.5	1.5	1.3	1.3	1.5	1.5	1.3	1.3	1.5	1.5	1.5	1.5	1.5	1.5	0.5
E1-10 </>	V	12.0	12.0	12.0	12.0	8.0	9.0	8.0	9.0	12.0	13.0	12.0	15.0	12.0	12.0	12.0	13.8	2.9

<1> Values shown here are for 200 V class drives. Double the value when using a 400 V class drive.

Table B.4 E1-03 V/f Pattern Settings for Drive Capacity: Models BA0012 to BA0018, 2A0012 to 2A0069, and 4A0007 to 4A0038

No.	Unit	V/f Control																OLV
		0	1	2	3	4	5	6	7	8	9	A	B	C	D	E	F	
E1-03	-	0	1	2	3	4	5	6	7	8	9	A	B	C	D	E	F	OLV
E1-04	Hz	50.0	60.0	60.0	72.0	50.0	50.0	60.0	60.0	50.0	50.0	60.0	60.0	90.0	120	180	60.0	60.0
E1-05 </>	V	200	200	200	200	200	200	200	200	200	200	200	200	200	200	200	230	230
E1-06	Hz	50.0	60.0	50.0	60.0	50.0	50.0	60.0	60.0	50.0	50.0	60.0	60.0	60.0	60.0	60.0	60.0	60.0
E1-07	Hz	2.5	3.0	3.0	3.0	25.0	25.0	30.0	30.0	2.5	2.5	3.0	3.0	3.0	3.0	3.0	3.0	3.0
E1-08 </>	V	14.0	14.0	14.0	14.0	35.0	50.0	35.0	50.0	18.0	23.0	18.0	23.0	14.0	14.0	14.0	16.1	12.7
E1-09	Hz	1.3	1.5	1.5	1.5	1.3	1.3	1.5	1.5	1.3	1.3	1.5	1.5	1.5	1.5	1.5	1.5	0.5
E1-10 </>	V	7.0	7.0	7.0	7.0	6.0	7.0	6.0	7.0	9.0	11.0	9.0	13.0	7.0	7.0	7.0	7.0	2.3

<1> Values shown here are for 200 V class drives. Double the value when using a 400 V class drive.

B.5 Defaults by Drive Model and Duty Rating (ND/HD)

Table B.5 Single-Phase, 200 V Class Drives Default Settings by Drive Capacity and ND/HD Settings

No.	Description	Unit	Default Settings					
			BA0001		BA0002		BA0003	
–	Model	–	30		31		32	
o2-04	Drive Model Selection	Hex	30		31		32	
C6-01	Normal/Heavy Duty	–	HD	ND	HD	ND	HD	ND
			0	1	0	1	0	1
E2-11 (E4-11, T1-02)	Motor rated power	kW	0.1	0.2	0.2	0.4	0.4	0.75
b3-06	Speed Search current 1	–	1	1	1	1	1	1
b3-08	Current Control Gain during Speed Search (Speed Estimation Type)	–	0.5	0.5	0.5	0.5	0.5	0.5
b8-04	Energy saving coefficient	–	481.7	356.9	356.9	288.2	288.2	223.7
C6-02	Carrier frequency	–	4	7	4	7	4	7
E2-01 (E4-01, T1-04)	Motor rated current	A	0.6	1.1	1.1	1.9	1.9	3.3
E2-02 (E4-02)	Motor rated slip	Hz	2.5	2.6	2.6	2.9	2.9	2.5
E2-03 (E4-03)	Motor no-load current	A	0.4	0.8	0.8	1.2	1.2	1.8
E2-05 (E4-05)	Motor line-to-line resistance	Ω	35.98	20.56	20.56	9.84	9.842	5.156
E2-06 (E4-06)	Motor leakage inductance	%	21.6	20.1	20.1	18.2	18.2	13.8
E2-10 (E4-10)	Motor Iron Loss	W	6	11	11	14	14	26
E5-01	Motor code	hex	FFFF	FFFF	FFFF	FFFF	0002	0002
L2-02	Momentary power loss ride-through time	s	0.1	0.1	0.1	0.1	0.1	0.1
L2-03	Mom. power loss Baseblock time	s	0.2	0.2	0.2	0.2	0.2	0.3
L2-04	Momentary power loss voltage recovery time	s	0.3	0.3	0.3	0.3	0.3	0.3
L2-05	Uv detection voltage	V dc	160	160	160	160	160	160
L3-24	Motor acceleration time	s	0.178	0.178	0.178	0.178	0.178	0.142
L8-02	Overheat alarm level	°C	115	115	115	115	110	110
L8-09	Ground fault selection	–	0	0	0	0	0	0
L8-38	Carrier freq. reduction sel.	–	1	1	1	1	1	1
n1-03	Hunting Prev. Time Const.	ms	10	10	10	10	10	10
n2-01	Speed Feedback Detection Control (AFR) Gain	–	1.00	1.00	1.00	1.00	1.00	1.00

B.5 Defaults by Drive Model and Duty Rating (ND/HD)

No.	Description	Unit	Default Settings						
			BA0006		BA0010		BA0012		BA0018
-	Model	-	33		34		35		37
o2-04	Drive Model Selection	Hex	33		34		35		37
C6-01	Normal/Heavy Duty	-	HD	ND	HD	ND	HD	ND	HD
			0	1	0	1	0	1	0
E2-11 (E4-11, T1-02)	Motor rated power	kW	0.75	1.1	1.5	2.2	2.2	3.0	3.7
b3-06	Speed Search current 1	-	0.5	0.5	0.5	0.5	0.5	0.5	0.5
b3-08	Current Control Gain during Speed Search (Speed Estimation Type)	-	0.5	0.5	0.5	0.5	0.5	0.5	0.5
b8-04	Energy saving coefficient	-	223.7	169.4	169.4	156.8	156.8	136.4	122.9
C6-02	Carrier frequency	-	4	7	3	7	3	7	3
E2-01 (E4-01, T1-04)	Motor rated current	A	3.3	6.2	6.2	8.5	8.5	11.4	14.0
E2-02 (E4-02)	Motor rated slip	Hz	2.5	2.6	2.6	2.9	2.9	2.7	2.73
E2-03 (E4-03)	Motor no-load current	A	1.8	2.8	2.8	3	3	3.7	4.5
E2-05 (E4-05)	Motor line-to-line resistance	Ω	5.156	1.997	1.997	1.601	1.601	1.034	0.771
E2-06 (E4-06)	Motor leakage inductance	%	13.8	18.5	18.5	18.4	18.4	19	19.6
E2-10 (E4-10)	Motor Iron Loss	W	26	53	53	77	77	91	112
E5-01	Motor Code	hex	0003	0003	0005	0005	0006	0006	0008
L2-02	Momentary power loss ride-through time	s	0.2	0.2	0.3	0.3	0.5	0.5	1.0
L2-03	Momentary power loss Baseblock time	s	0.3	0.4	0.4	0.5	0.5	0.5	0.6
L2-04	Momentary power loss voltage recovery time	s	0.3	0.3	0.3	0.3	0.3	0.3	0.3
L2-05	Uv detection voltage	V dc	160	160	160	160	160	160	160
L3-24	Motor acceleration time	s	0.142	0.142	0.166	0.145	0.145	0.145	0.154
L8-02	Overheat alarm level	°C	105	105	100	100	95	95	100
L8-09	Ground fault selection	-	0	0	0	0	0	0	0
L8-38	Carrier frequency reduction selection	-	1	1	1	1	1	1	1
n1-03	Hunting Prevention Time Constant	ms	10	10	10	10	10	10	10
n2-01	Speed Feedback Detection Control (AFR) Gain	-	1.00	1.00	1.00	1.00	1.00	1.00	1.50

Table B.6 Three-Phase, 200 V Class Drives Default Settings by Drive Capacity and ND/HD Setting

No.	Description	Unit	Default Settings									
			2A0001		2A0002		2A0004		2A0006		2A0010	
o2-04	Drive Model Selection	Hex	60		61		62		63		65	
C6-01	Normal/Heavy Duty	-	HD	ND	HD	ND	HD	ND	HD	ND	HD	ND
			0	1	0	1	0	1	0	1	0	1
E2-11 (E4-11, T1-02)	Motor rated power	kW	0.1	0.2	0.2	0.4	0.4	0.75	0.75	1.1	1.5	2.2
b3-06	Speed Search current 1	-	1.0	1.0	1.0	1.0	1.0	1.0	0.5	0.5	0.5	0.5
b3-08	Current Control Gain during Speed Search (Speed Estimation Type)	-	0.5	0.5	0.5	0.5	0.5	0.5	0.5	0.5	0.5	0.5
b8-04	Energy saving coefficient	-	481.7	356.9	356.9	288.2	288.2	223.7	223.7	196.6	169.4	156.8
C6-02	Carrier frequency	-	4	7	4	7	4	7	4	7	3	7
E2-01 (E4-01, T1-04)	Motor rated current	A	0.6	1.1	1.1	1.9	1.9	3.3	3.3	4.9	6.2	8.5
E2-02 (E4-02)	Motor rated slip	Hz	2.5	2.6	2.6	2.9	2.9	2.5	2.5	2.6	2.6	2.9
E2-03 (E4-03)	Motor no-load current	A	0.4	0.8	0.8	1.2	1.2	1.8	1.8	2.3	2.8	3.0
E2-05 (E4-05)	Motor line-to-line resistance	Ω	35.98	20.56	20.56	9.84	9.842	5.156	5.156	3.577	1.997	1.601
E2-06 (E4-06)	Motor leakage inductance	%	21.6	20.1	20.1	18.2	18.2	13.8	13.8	18.5	18.5	18.4
E2-10 (E4-10)	Motor Iron Loss	W	6	11	11	14	14	26	26	38	53	77
E5-01	Motor Code	hex	FFFF	FFFF	FFFF	FFFF	0002	0002	0003	0003	0005	0005
L2-02	Momentary power loss ride-through time	s	0.1	0.1	0.1	0.1	0.1	0.1	0.2	0.2	0.3	0.3
L2-03	Momentary power loss Baseblock time	s	0.2	0.2	0.2	0.2	0.2	0.3	0.3	0.4	0.4	0.5
L2-04	Momentary power loss voltage recovery time	s	0.3	0.3	0.3	0.3	0.3	0.3	0.3	0.3	0.3	0.3
L2-05	Uv detection voltage	V dc	190	190	190	190	190	190	190	190	190	190
L3-24	Motor acceleration time	s	0.178	0.178	0.178	0.178	0.178	0.142	0.142	0.142	0.166	0.145
L8-02	Overheat alarm level	°C	110	110	110	110	115	115	100	100	100	100
L8-09	Ground fault selection	-	0	0	0	0	0	0	0	0	0	0
L8-38	Carrier frequency reduction selection	-	1	1	1	1	1	1	1	1	1	1
n1-03	Hunting Prevention Time Constant	ms	10	10	10	10	10	10	10	10	10	10
n2-01	Speed Feedback Detection Control (AFR) Gain	-	1.00	1.00	1.00	1.00	1.00	1.00	1.00	1.00	1.00	1.00

B.5 Defaults by Drive Model and Duty Rating (ND/HD)

No.	Description	Unit	Default Settings					
			2A0012		2A0020		2A0030	
-	Model	-	66		68		6A	
o2-04	Drive Model Selection	Hex	66		68		6A	
C6-01	Normal/Heavy Duty	-	HD	ND	HD	ND	HD	ND
			0	1	0	1	0	1
E2-11 (E4-11, T1-02)	Motor rated power	kW	2.2	3.0	3.7	5.5	5.5	7.5
b3-06	Speed Search current 1	-	0.5	0.5	0.5	0.5	0.5	0.5
b3-08	Current Control Gain during Speed Search (Speed Estimation Type)	-	0.5	0.5	0.5	0.5	0.5	0.5
b8-04	Energy saving coefficient	-	156.8	136.4	122.9	94.8	94.75	72.69
C6-02	Carrier frequency	-	3	7	3	7	3	7
E2-01 (E4-01, T1-04)	Motor rated current	A	8.5	11.4	14	19.6	19.6	26.6
E2-02 (E4-02)	Motor rated slip	Hz	2.9	2.7	2.73	1.5	1.5	1.3
E2-03 (E4-03)	Motor no-load current	A	3.0	3.7	4.5	5.1	5.1	8.0
E2-05 (E4-05)	Motor line-to-line resistance	Ω	1.601	1.034	0.771	0.399	0.399	0.288
E2-06 (E4-06)	Motor leakage inductance	%	18.4	19	19.6	18.2	18.2	15.5
E2-10 (E4-10)	Motor Iron Loss	W	77	91	112	172	172	262
E5-01	Motor Code	hex	0006	0006	0008	0008	FFFF	FFFF
L2-02	Momentary power loss ride-through time	s	0.5	0.5	1	1	1.0	1.0
L2-03	Momentary power loss Baseblock time	s	0.5	0.5	0.6	0.7	0.7	0.8
L2-04	Momentary power loss voltage recovery time	s	0.3	0.3	0.3	0.6	0.3	0.6
L2-05	Uv detection voltage	V dc	190	190	190	190	190	190
L3-24	Motor acceleration time	s	0.145	0.145	0.154	0.168	0.168	0.175
L8-02	Overheat alarm level	°C	100	100	110	110	115	115
L8-09	Ground fault selection	-	0	0	0	0	1	1
L8-38	Carrier frequency reduction selection	-	1	1	1	1	2	2
n1-03	Hunting Prevention Time Constant	ms	10	10	10	10	10	10
n2-01	Speed Feedback Detection Control (AFR) Gain	-	1.00	1.00	1.00	1.00	1.50	1.50

B.5 Defaults by Drive Model and Duty Rating (ND/HD)

No.	Description	Unit	Default Settings					
			2A0040		2A0056		2A0069	
o2-04	Drive Model Selection	Hex	6B		6D		6E	
C6-01	Normal/Heavy Duty	-	HD	ND	HD	ND	HD	ND
			0	1	0	1	0	1
E2-11 (E4-11, T1-02)	Motor rated power	kW	7.5	11.0	11.0	15.0	15.0	18.5
b3-06	Speed Search current 1	-	0.5	0.5	0.5	0.5	0.5	0.5
b3-08	Current Control Gain during Speed Search (Speed Estimation Type)	-	0.5	0.5	0.5	0.5	0.5	0.5
b8-04	Energy saving coefficient	-	72.69	70.44	70.44	63.13	63.13	57.87
C6-02	Carrier frequency	-	3	7	3	7	3	7
E2-01 (E4-01, T1-04)	Motor rated current	A	26.6	39.7	39.7	53	53	65.8
E2-02 (E4-02)	Motor rated slip	Hz	1.3	1.7	1.7	1.6	1.6	1.67
E2-03 (E4-03)	Motor no-load current	A	8.0	11.2	11.2	15.2	15.2	15.7
E2-05 (E4-05)	Motor line-to-line resistance	Ω	0.288	0.230	0.230	0.138	0.138	0.101
E2-06 (E4-06)	Motor leakage inductance	%	15.5	19.5	19.5	17.2	17.2	15.7
E2-10 (E4-10)	Motor Iron Loss	W	262	245	245	272	272	505
E5-01	Motor Code	hex	FFFF	FFFF	FFFF	FFFF	FFFF	FFFF
L2-02	Momentary power loss ride-through time	s	1.0	1.0	2.0	2.0	2.0	2.0
L2-03	Momentary power loss Baseblock time	s	0.8	0.9	0.9	1.0	1.0	1.0
L2-04	Momentary power loss voltage recovery time	s	0.3	0.3	0.3	0.3	0.6	0.6
L2-05	Uv detection voltage	V dc	190	190	190	190	190	190
L3-24	Motor acceleration time	s	0.175	0.265	0.265	0.244	0.244	0.317
L8-02	Overheat alarm level	°C	121	121	120	120	120	120
L8-09	Ground fault selection	-	1	1	1	1	1	1
L8-38	Carrier frequency reduction selection	-	2	2	2	2	2	2
n1-03	Hunting Prevention Time Constant	ms	10	10	10	10	10	10
n2-01	Speed Feedback Detection Control (AFR) Gain	-	1.50	1.50	1.50	1.50	1.50	1.50

B.5 Defaults by Drive Model and Duty Rating (ND/HD)

Table B.7 Three-Phase 400 V Class Drives Default Settings by Drive Capacity and ND/HD Setting

No.	Description	Unit	Default Settings							
			4A0001		4A0002		4A0004		4A0005	
–	Model	–	91		92		93		94	
o2-04	Drive Model Selection	Hex	91		92		93		94	
C6-01	Normal/Heavy Duty	–	HD	ND	HD	ND	HD	ND	HD	ND
			0	1	0	1	0	1	0	1
E2-11 (E4-11, T1-02)	Motor rated power	kW	0.2	0.4	0.4	0.75	0.75	1.5	1.5	2.2
b3-06	Speed Search current 1	–	1.0	1.0	0.5	0.5	0.5	0.5	0.5	0.5
b3-08	Current Control Gain during Speed Search (Speed Estimation Type)	–	0.5	0.5	0.5	0.5	0.5	0.5	0.5	0.5
b8-04	Energy saving coefficient	–	713.8	576.4	576.4	447.4	447.4	338.8	338.8	313.6
C6-02	Carrier frequency	–	3	7	3	7	3	7	3	7
E2-01 (E4-01, T1-04)	Motor rated current	A	0.6	1	1	1.6	1.6	3.1	3.1	4.2
E2-02 (E4-02)	Motor rated slip	Hz	2.5	2.9	2.9	2.6	2.6	2.5	2.5	3
E2-03 (E4-03)	Motor no-load current	A	0.4	0.6	0.6	0.8	0.8	1.4	1.4	1.5
E2-05 (E4-05)	Motor line-to-line resistance	Ω	83.94	38.20	38.198	22.459	22.459	10.1	10.1	6.495
E2-06 (E4-06)	Motor leakage inductance	%	21.9	18.2	18.2	14.3	14.3	18.3	18.3	18.7
E2-10 (E4-10)	Motor Iron Loss	W	12	14	14	26	26	53	53	77
E5-01	Motor Code	hex	FFFF	FFFF	FFFF	FFFF	FFFF	FFFF	FFFF	FFFF
L2-02	Momentary power loss ride-through time	s	0.1	0.1	0.1	0.1	0.2	0.2	0.3	0.3
L2-03	Momentary power loss Baseblock time	s	0.2	0.2	0.2	0.3	0.3	0.4	0.4	0.5
L2-04	Momentary power loss voltage recovery time	s	0.3	0.3	0.3	0.3	0.3	0.3	0.3	0.3
L2-05	Uv detection voltage	V dc	380	380	380	380	380	380	380	380
L3-24	Motor acceleration time	s	0.178	0.178	0.178	0.142	0.142	0.166	0.166	0.145
L8-02	Overheat alarm level	°C	110	110	110	110	110	110	90	90
L8-09	Ground fault selection	–	0	0	0	0	0	0	0	0
L8-38	Carrier frequency reduction selection	–	1	1	1	1	1	1	1	1
n1-03	Hunting Prevention Time Constant	ms	10	10	10	10	10	10	10	10
n2-01	Speed Feedback Detection Control (AFR) Gain	–	1.00	1.00	1.00	1.00	1.00	1.00	1.00	1.00

B.5 Defaults by Drive Model and Duty Rating (ND/HD)

No.	Description	Unit	Setting Range							
			4A0007		4A0009		4A0011		4A0018	
-	Model	-	95		96		97		99	
o2-04	Drive Model Selection	-	95		96		97		99	
C6-01	Normal/Heavy Duty	-	HD	ND	HD	ND	HD	ND	HD	ND
			0	1	0	1	0	1	0	1
E2-11 (E4-11, T1-02)	Motor rated power	kW	2.2	3.0	3.0	3.7	4.0	5.5	5.5	7.5
b3-06	Speed Search current 1	-	0.5	0.5	0.5	0.5	0.5	0.5	0.5	0.5
b3-08	Current Control Gain during Speed Search (Speed Estimation Type)	-	0.5	0.5	0.5	0.5	0.5	0.5	0.5	0.5
b8-04	Energy saving coefficient	-	313.6	265.7	265.7	245.8	245.8	189.5	189.5	145.38
C6-02	Carrier frequency	-	3	7	3	7	3	7	3	7
E2-01 (E4-01, T1-04)	Motor rated current	A	4.2	5.7	5.7	7	7	9.8	9.8	13.30
E2-02 (E4-02)	Motor rated slip	Hz	3	2.7	2.7	2.7	2.7	1.5	1.5	1.3
E2-03 (E4-03)	Motor no-load current	A	1.5	1.9	1.9	2.3	2.3	2.6	2.6	4.0
E2-05 (E4-05)	Motor line-to-line resistance	Ω	6.495	4.360	4.360	3.333	3.333	1.595	1.595	1.152
E2-06 (E4-06)	Motor leakage inductance	%	18.7	19	19	19.3	19.3	18.2	18.2	15.5
E2-10 (E4-10)	Motor Iron Loss	W	77	105	105	130	130	193	193	263
E5-01	Motor Code	hex	FFFF	FFFF	FFFF	FFFF	FFFF	FFFF	FFFF	FFFF
L2-02	Momentary power loss ride-through time	s	0.5	0.5	0.5	0.5	0.5	0.5	0.8	0.8
L2-03	Momentary power loss Baseblock time	s	0.5	0.5	0.5	0.6	0.6	0.7	0.7	0.8
L2-04	Momentary power loss voltage recovery time	s	0.3	0.3	0.3	0.3	0.3	0.3	0.3	0.3
L2-05	Uv detection voltage	V dc	380	380	380	380	380	380	380	380
L3-24	Motor acceleration time	s	0.145	0.145	0.145	0.154	0.154	0.154	0.168	0.175
L8-02	Overheat alarm level	°C	100	100	100	100	100	100	110	110
L8-09	Ground fault selection	-	0	0	0	0	0	0	1	1
L8-38	Carrier frequency reduction selection	-	1	1	1	1	1	1	2	2
n1-03	Hunting Prevention Time Constant	ms	10	10	10	10	10	10	10	10
n2-01	Speed Feedback Detection Control (AFR) Gain	-	1.00	1.00	1.00	1.00	1.00	1.00	1.50	1.50

B.5 Defaults by Drive Model and Duty Rating (ND/HD)

No.	Description	Unit	Setting Range					
			4A0023		4A0031		4A0038	
-	Model	-	9A		9C		9D	
o2-04	Drive Model Selection	-	9A		9C		9D	
C6-01	Normal/Heavy Duty	-	HD	ND	HD	ND	HD	ND
			0	1	0	1	0	1
E2-11 (E4-11, T1-02)	Motor rated power	kW	7.5	11.0	11.0	15.0	15.0	18.5
b3-06	Speed Search current 1	-	0.5	0.5	0.5	0.5	0.5	0.5
b3-08	Current Control Gain during Speed Search (Speed Estimation Type)	-	0.5	0.5	0.5	0.5	0.5	0.5
b8-04	Energy saving coefficient	-	145.38	140.88	140.88	126.26	126.26	115.74
C6-02	Carrier frequency	-	3	7	3	7	3	7
E2-01 (E4-01, T1-04)	Motor rated current	A	13.3	19.9	19.9	26.5	26.5	32.9
E2-02 (E4-02)	Motor rated slip	Hz	1.30	1.70	1.70	1.60	1.60	1.67
E2-03 (E4-03)	Motor no-load current	A	4.0	5.6	5.6	7.6	7.6	7.8
E2-05 (E4-05)	Motor line-to-line resistance	Ω	1.152	0.922	0.922	0.550	0.550	0.403
E2-06 (E4-06)	Motor leakage inductance	%	15.5	19.6	19.6	17.2	17.2	20.1
E2-10 (E4-10)	Motor Iron Loss	W	263	385	385	440	440	508
E5-01	Motor Code	hex	FFFF	FFFF	FFFF	FFFF	FFFF	FFFF
L2-02	Momentary power loss ride-through time	s	1	1	2	2	2	2
L2-03	Momentary power loss Baseblock time	s	0.8	0.9	0.9	1.0	1.0	1.0
L2-04	Momentary power loss voltage recovery time	s	0.3	0.3	0.3	0.6	0.6	0.6
L2-05	Uv detection voltage	V dc	380	380	380	380	380	380
L3-24	Motor acceleration time	s	0.175	0.265	0.265	0.244	0.244	0.317
L8-02	Overheat alarm level	°C	110	110	110	110	110	110
L8-09	Ground fault selection	-	1	1	1	1	1	1
L8-38	Carrier frequency reduction selection	-	2	2	2	2	2	2
n1-03	Hunting Prevention Time Constant	ms	10	10	10	10	10	10
n2-01	Speed Feedback Detection Control (AFR) Gain	-	1.50	1.50	1.50	1.50	1.50	1.50

B.6 Parameters that Change with the Motor Code Selection

The following tables show parameters and default settings that change with the motor code selection E5-01 when Open Loop Vector for PM motors is used.

◆ Yaskawa SMRA Series SPM Motor

Table B.8 1800 rpm Type Yaskawa SMRA Series SPM Motor Settings

Par.	Description	Unit	Default Settings				
E5-01	Motor Code	–	0002	0003	0005	0006	0008
	Voltage Class	–	200 Vac	200 Vac	200 Vac	200 Vac	200 Vac
	Rated Power	–	0.4 kW	0.75 kW	1.5 kW	2.2 kW	3.7 kW
	Rated Speed	r/min	1800	1800	1800	1800	1800
E5-02	Motor Rated Power	kW	0.4	0.75	1.5	2.2	3.7
E5-03	Motor Rated Current	A	2.1	4.0	6.9	10.8	17.4
E5-04	Motor Pole Number	–	8	8	8	8	8
E5-05	Motor Winding Resistance	Ω	2.47	1.02	0.679	0.291	0.169
E5-06	d-Axis Inductance	mH	12.7	4.8	3.9	3.6	2.5
E5-07	q-Axis Inductance	mH	12.7	4.8	3.9	3.6	2.5
E5-09	Induction Voltage Constant 1	mVs/rad	0	0	0	0	0
E5-24	Induction Voltage Constant 2	mV/(r/min)	62.0	64.1	73.4	69.6	72.2
E1-04	Maximum Output Frequency	Hz	120	120	120	120	120
E1-05	Maximum Output Voltage	V	200.0	200.0	200.0	200.0	200.0
E1-06	Base Frequency	Hz	120	120	120	120	120
E1-09	Minimum Output Frequency	Hz	6	6	6	6	6
L3-24	Motor Acceleration Time for Inertia Calculations	s	0.064	0.066	0.049	0.051	0.044
n8-49	d-Axis Current for High-Efficiency Control	%	0	0	0	0	0

Table B.9 3600 rpm Type Yaskawa SMRA Series SPM Motor Settings

Par.	Description	Unit	Default Settings			
E5-01	Motor Code	–	0103	0105	0106	0108
	Voltage Class	–	200 Vac	200 Vac	200 Vac	200 Vac
	Rated Power	–	0.75 kW	1.5 kW	2.2 kW	3.7 kW
	Rated Speed	r/min	3600	3600	3600	3600
E5-02	Motor Rated Power	kW	0.75	1.5	2.2	3.7
E5-03	Motor Rated Current	A	4.1	8.0	10.5	16.5
E5-04	Motor Pole Number	–	8	8	8	8
E5-05	Motor Winding Resistance	Ω	0.538	0.20	0.15	0.097
E5-06	d-Axis Inductance	mH	3.2	1.3	1.1	1.1
E5-07	q-Axis Inductance	mH	3.2	1.3	1.1	1.1
E5-09	Induction Voltage Constant 1	mVs/rad	0	0	0	0
E5-24	Induction Voltage Constant 2	mV/(r/min)	32.4	32.7	36.7	39.7
E1-04	Maximum Output Frequency	Hz	240	240	240	240
E1-05	Maximum Output Voltage	V	200.0	200.0	200.0	200.0
E1-06	Base Frequency	Hz	240	240	240	240
E1-09	Minimum Output Frequency	Hz	12	12	12	12
L3-24	Motor Acceleration Time for Inertia Calculations	s	0.137	0.132	0.132	0.122
n8-49	d-Axis Current for High-Efficiency Control	%	0	0	0	0

B.6 Parameters that Change with the Motor Code Selection

◆ SS5 Motor: Yaskawa SSR1 Series IPM Motor

Default values vary based on drive software version.

■ Drive Software Version PRG: 1017 and Earlier

Table B.10 200 V, 1750 rpm Type Yaskawa SSR1 Series Motor

Par.	Description	Unit	Default Settings									
			1202	1203	1205	1206	1208	120A	120B	120D	120E	120F
E5-01	Motor Code	–	1202	1203	1205	1206	1208	120A	120B	120D	120E	120F
	Voltage Class	–	200 Vac	200 Vac	200 Vac	200 Vac	200 Vac	200 Vac	200 Vac	200 Vac	200 Vac	200 Vac
	Rated Power	–	0.4 kW	0.75 kW	1.5 kW	2.2 kW	3.7 kW	5.5 kW	7.5 kW	11 kW	15 kW	18 kW
	Rated Speed	r/min	1750	1750	1750	1750	1750	1750	1750	1750	1750	1750
E5-02	Motor Rated Power	kW	0.4	0.75	1.5	2.2	3.7	5.5	7.5	11.0	15	18.0
E5-03	Motor Rated Current	A	1.65	2.97	5.50	8.10	13.40	19.80	27.00	39.7	53.2	65.5
E5-04	Motor Pole Number	–	6	6	6	6	6	6	6	6	6	6
E5-05	Motor Winding Resistance	Ω	8.233	2.284	1.501	0.827	0.455	0.246	0.198	0.094	0.066	0.052
E5-06	d-Axis Inductance	mH	54.84	23.02	17.08	8.61	7.20	4.86	4.15	3.40	2.65	2.17
E5-07	q-Axis Inductance	mH	64.10	29.89	21.39	13.50	10.02	7.43	5.91	3.91	3.11	2.55
E5-09	Induction Voltage Constant 1	mVs/rad	233.0	229.5	250.9	247.9	248.6	249.6	269.0	249.3	266.6	265.1
E5-24	Induction Voltage Constant 2	mV/(r/min)	0.0	0.0	0.0	0.0	0.0	0.0	0.0	0.0	0.0	0.0
E1-04	Maximum Output Frequency	Hz	87.5	87.5	87.5	87.5	87.5	87.5	87.5	87.5	87.5	87.5
E1-05	Maximum Output Voltage	V	190.0	190.0	190.0	190.0	190.0	190.0	190.0	190.0	190.0	190.0
E1-06	Base Frequency	Hz	87.5	87.5	87.5	87.5	87.5	87.5	87.5	87.5	87.5	87.5
E1-09	Minimum Output Frequency	Hz	4.4	4.4	4.4	4.4	4.4	4.4	4.4	4.4	4.4	4.4
L3-24 <1>	Motor Acceleration Time for Inertia Calculations	s	0.092	0.076	0.051	0.066	0.075	0.083	0.077	0.084	0.102	0.103
n8-49	d-Axis Current for High-Efficiency Control	%	-7.2	-10.8	-11.1	-17.8	-17.5	-22.0	-17.3	-10.1	-10.3	-10.1

<1> Default setting value is dependent on parameter o2-04, Drive Model Selection.

Drives Motors Controls

■ Drive Software Version PRG: 1018 and Later

Table B.11 200 V, 1750 rpm Type Yaskawa SSR1 Series Motor

Par.	Description	Unit	Default Settings									
E5-01	Motor Code	–	1202	1203	1205	1206	1208	120A	120B	120D	120E	120F
	Voltage Class	–	200 Vac	200 Vac	200 Vac	200 Vac	200 Vac	200 Vac	200 Vac	200 Vac	200 Vac	200 Vac
	Rated Power	–	0.4 kW	0.75 kW	1.5 kW	2.2 kW	3.7 kW	5.5 kW	7.5 kW	11 kW	15 kW	18 kW
	Rated Speed	r/min	1750	1750	1750	1750	1750	1750	1750	1750	1750	1750
E5-02	Motor Rated Power	kW	0.4	0.75	1.5	2.2	3.7	5.5	7.5	11	15	18.5
E5-03	Motor Rated Current	A	1.77	3.13	5.73	8.44	13.96	20.63	28.13	41.4	55.4	68.2
E5-04	Motor Pole Number	–	6	6	6	6	6	6	6	6	6	6
E5-05	Motor Winding Resistance	Ω	8.233	2.284	1.470	0.827	0.455	0.246	0.198	0.094	0.066	0.051
E5-06	d-Axis Inductance	mH	54.84	23.02	17.22	8.61	7.2	4.86	4.15	3.4	2.45	2.18
E5-07	q-Axis Inductance	mH	64.1	29.89	20.41	13.5	10.02	7.43	5.91	3.91	3.11	2.55
E5-09	Induction Voltage Constant 1	mVs/rad	223.7	220.3	240.8	238	238.7	239.6	258.2	239.3	248.1	253.6
E5-24	Induction Voltage Constant 2	mV/(r/min)	0	0	0	0	0	0	0	0	0	0
E1-04	Maximum Output Frequency	Hz	87.5	87.5	87.5	87.5	87.5	87.5	87.5	87.5	87.5	87.5
E1-05	Maximum Output Voltage	V	190	190	190	190	190	190	190	190	190	190
E1-06	Base Frequency	Hz	87.5	87.5	87.5	87.5	87.5	87.5	87.5	87.5	87.5	87.5
E1-09	Minimum Output Frequency	Hz	4.4	4.4	4.4	4.4	4.4	4.4	4.4	4.4	4.4	4.4
L3-24 </>	Motor Acceleration Time for Inertia Calculations	s	0.092	0.076	0.051	0.066	0.075	0.083	0.077	0.084	0.102	0.101
n8-49	d-Axis Current for High-Efficiency Control	%	-7.6	-11.5	-9.1	-19	-18.7	-23.4	-18.5	-10.9	-16.5	-11.3

<1> Default setting value is dependent on parameter o2-04, Drive Model Selection.



B.6 Parameters that Change with the Motor Code Selection

■ Drive Software Version PRG: 1017 and Earlier

Table B.12 400 V, 1750 rpm Type Yaskawa SSR1 Series Motor

Par.	Description	Unit	Default Settings									
E5-01	Motor Code	–	1232	1233	1235	1236	1238	123A	123B	123D	123E	123F
	Voltage Class	–	400 Vac	400 Vac	400 Vac	400 Vac	400 Vac	400 Vac	400 Vac	400 Vac	400 Vac	400 Vac
	Rated Power	–	0.4 kW	0.75 kW	1.5 kW	2.2 kW	3.7 kW	5.5 kW	7.5 kW	11 kW	15 kW	18 kW
	Rated Speed	r/min	1750	1750	1750	1750	1750	1750	1750	1750	1750	1750
E5-02	Motor Rated Power	kW	0.4	0.75	1.5	2.2	3.7	5.5	7.5	11.0	15	18.0
E5-03	Motor Rated Current	A	0.83	1.49	2.75	4.05	6.80	9.90	13.10	19.9	26.4	32.1
E5-04	Motor Pole Number	–	6	6	6	6	6	6	6	6	6	6
E5-05	Motor Winding Resistance	Ω	32.932	9.136	6.004	3.297	1.798	0.982	0.786	0.368	0.263	0.202
E5-06	d-Axis Inductance	mH	219.36	92.08	68.32	40.39	32.93	22.7	16.49	13.38	10.51	8.56
E5-07	q-Axis Inductance	mH	256.40	119.56	85.56	48.82	37.70	26.80	23.46	16.99	12.77	11.22
E5-09	Induction Voltage Constant 1	mVs/rad	466.0	459.0	501.8	485.7	498.7	498.0	541.7	508.7	531.9	536.4
E5-24	Induction Voltage Constant 2	mV/(r/min)	0.0	0.0	0.0	0.0	0.0	0.0	0.0	0.0	0.0	0.0
E1-04	Maximum Output Frequency	Hz	87.5	87.5	87.5	87.5	87.5	87.5	87.5	87.5	87.5	87.5
E1-05	Maximum Output Voltage	V	380.0	380.0	380.0	380.0	380.0	380.0	380.0	380.0	380.0	380.0
E1-06	Base Frequency	Hz	87.5	87.5	87.5	87.5	87.5	87.5	87.5	87.5	87.5	87.5
E1-09	Minimum Output Frequency	Hz	4.4	4.4	4.4	4.4	4.4	4.4	4.4	4.4	4.4	4.4
L3-24 <1>	Motor Acceleration Time for Inertia Calculations	s	0.092	0.076	0.051	0.066	0.075	0.083	0.077	0.084	0.102	0.103
n8-49	d-Axis Current for High-Efficiency Control	%	-7.2	-10.7	-11.1	-8.9	-7.9	-10.2	-17.4	-15.8	-12.6	-16.3

<1> Default setting value is dependent on parameter o2-04, Drive Model Selection.

Drives Motors Controls

■ Drive Software Version PRG: 1018 and Later

Table B.13 400 V, 1750 rpm Type Yaskawa SSR1 Series Motor

Par.	Description	Unit	Default Settings									
			1232	1233	1235	1236	1238	123A	123B	123D	123E	123F
E5-01	Motor Code	–	1232	1233	1235	1236	1238	123A	123B	123D	123E	123F
	Voltage Class	–	400 Vac	400 Vac	400 Vac	400 Vac	400 Vac	400 Vac	400 Vac	400 Vac	400 Vac	400 Vac
	Rated Power	–	0.4 kW	0.75 kW	1.5 kW	2.2 kW	3.7 kW	5.5 kW	7.5 kW	11 kW	15 kW	18 kW
	Rated Speed	r/min	1750	1750	1750	1750	1750	1750	1750	1750	1750	1750
E5-02	Motor Rated Power	kW	0.4	0.75	1.5	2.2	3.7	5.5	7.5	11	15	18.5
E5-03	Motor Rated Current	A	0.89	1.56	2.81	4.27	7.08	10.31	13.65	20.7	27.5	33.4
E5-04	Motor Pole Number	–	6	6	6	6	6	6	6	6	6	6
E5-05	Motor Winding Resistance	Ω	25.370	9.136	6.010	3.297	1.798	0.982	0.786	0.349	0.272	0.207
E5-06	d-Axis Inductance	mH	169.00	92.08	67.71	34.40	32.93	22.7	16.49	13.17	10.30	8.72
E5-07	q-Axis Inductance	mH	197.5	119.56	81.71	54.00	37.7	26.8	23.46	15.60	12.77	11.22
E5-09	Induction Voltage Constant 1	mVs/rad	392.6	440.6	478.3	466.3	478.8	478.1	520.0	481.5	498.8	509.5
E5-24	Induction Voltage Constant 2	mV/(r/min)	0	0	0	0	0	0	0	0	0	0
E1-04	Maximum Output Frequency	Hz	87.5	87.5	87.5	87.5	87.5	87.5	87.5	87.5	87.5	87.5
E1-05	Maximum Output Voltage	V	380	380	380	380	380	380	380	380	380	380
E1-06	Base Frequency	Hz	87.5	87.5	87.5	87.5	87.5	87.5	87.5	87.5	87.5	87.5
E1-09	Minimum Output Frequency	Hz	4.4	4.4	4.4	4.4	4.4	4.4	4.4	4.4	4.4	4.4
L3-24 </>	Motor Acceleration Time for Inertia Calculations	s	0.092	0.076	0.051	0.066	0.075	0.083	0.077	0.084	0.102	0.101
n8-49	d-Axis Current for High-Efficiency Control	%	-8.6	-11.5	-10.3	-19.8	-8.5	-11	-18.6	-12.5	-15.5	-17.9

<1> Default setting value is dependent on parameter o2-04, Drive Model Selection.



B.6 Parameters that Change with the Motor Code Selection

■ Drive Software Version PRG: 1017 and Earlier

Table B.14 200 V, 1450 rpm Type Yaskawa SSR1 Series Motor

Par.	Description	Unit	Default Settings									
			1302	1303	1305	1306	1308	130A	130B	130D	130E	130F
E5-01	Motor Code	–	1302	1303	1305	1306	1308	130A	130B	130D	130E	130F
	Voltage Class	–	200 Vac	200 Vac	200 Vac	200 Vac	200 Vac	200 Vac	200 Vac	200 Vac	200 Vac	200 Vac
	Rated Power	–	0.4 kW	0.75 kW	1.5 kW	2.2 kW	3.7 kW	5.5kW	7.5 kW	11 kW	15 kW	18 kW
	Rated Speed	r/min	1450	1450	1450	1450	1450	1450	1450	1450	1450	1450
E5-02	Motor Rated Power	kW	0.4	0.75	1.5	2.2	3.7	5.5	7.5	11.0	15	18.0
E5-03	Motor Rated Current	A	1.78	3.12	5.88	8.00	14.10	20.00	26.60	38.0	53.3	63.0
E5-04	Motor Pole Number	–	6	6	6	6	6	6	6	6	6	6
E5-05	Motor Winding Resistance	Ω	4.405	2.425	1.647	0.665	0.452	0.341	0.184	0.099	0.075	0.057
E5-06	d-Axis Inductance	mH	26.62	19.14	14.53	12.27	7.10	5.90	6.91	4.07	3.29	2.53
E5-07	q-Axis Inductance	mH	41.70	29.98	19.98	14.77	10.14	8.42	8.37	5.25	4.57	3.01
E5-09	Induction Voltage Constant 1	mVs/rad	262.6	276.3	291.0	299.1	294.3	306.6	325.1	316.6	332.2	313.4
E5-24	Induction Voltage Constant 2	mV/(r/min)	0.0	0.0	0.0	0.0	0.0	0.0	0.0	0.0	0.0	0.0
E1-04	Maximum Output Frequency	Hz	72.5	72.5	72.5	72.5	72.5	72.5	72.5	72.5	72.5	72.5
E1-05	Maximum Output Voltage	V	190.0	190.0	190.0	190.0	190.0	190.0	190.0	190.0	190.0	190.0
E1-06	Base Frequency	Hz	72.5	72.5	72.5	72.5	72.5	72.5	72.5	72.5	72.5	72.5
E1-09	Minimum Output Frequency	Hz	3.6	3.6	3.6	3.6	3.6	3.6	3.6	3.6	3.6	3.6
L3-24 </>	Motor Acceleration Time for Inertia Calculations	s	0.098	0.071	0.066	0.087	0.085	0.072	0.084	0.096	0.085	0.082
n8-49	d-Axis Current for High-Efficiency Control	%	-10.8	-13.1	-12.1	-8.4	-16.0	-17.8	-12.8	-16.3	-19.1	-11.6

<1> Default setting value is dependent on parameter o2-04, Drive Model Selection.

Drives Motors Controls

■ Drive Software Version PRG: 1018 and Later

Table B.15 200 V, 1450 rpm Type Yaskawa SSR1 Series Motor

Par.	Description	Unit	Default Settings									
E5-01	Motor Code	–	1302	1303	1305	1306	1308	130A	130B	130D	130E	130F
	Voltage Class	–	200 Vac	200 Vac	200 Vac	200 Vac	200 Vac	200 Vac	200 Vac	200 Vac	200 Vac	200 Vac
	Rated Power	–	0.4 kW	0.75 kW	1.5 kW	2.2 kW	3.7 kW	5.5 kW	7.5 kW	11 kW	15 kW	18 kW
	Rated Speed	r/min	1450	1450	1450	1450	1450	1450	1450	1450	1450	1450
E5-02	Motor Rated Power	kW	0.4	0.75	1.5	2.2	3.7	5.5	7.5	11	15	18.5
E5-03	Motor Rated Current	A	1.88	3.13	5.63	8.33	14.17	20.63	27.71	39.6	55.5	65.6
E5-04	Motor Pole Number	–	6	6	6	6	6	6	6	6	6	6
E5-05	Motor Winding Resistance	Ω	3.190	1.940	1.206	0.665	0.341	0.252	0.184	0.099	0.075	0.057
E5-06	d-Axis Inductance	mH	32.15	26.12	14.72	12.27	8.27	6.49	6.91	4.07	3.29	2.53
E5-07	q-Axis Inductance	mH	41.74	34.3	20.15	14.77	9.81	7.74	7.66	4.65	3.84	3.01
E5-09	Induction Voltage Constant 1	mVs/rad	264.3	269.6	284.3	287.1	284.5	298.0	335.0	303.9	311.2	300.9
E5-24	Induction Voltage Constant 2	mV/(r/min)	0	0	0	0	0	0	0	0	0	0
E1-04	Maximum Output Frequency	Hz	72.5	72.5	72.5	72.5	72.5	72.5	72.5	72.5	72.5	72.5
E1-05	Maximum Output Voltage	V	190	190	190	190	190	190	190	190	190	190
E1-06	Base Frequency	Hz	72.5	72.5	72.5	72.5	72.5	72.5	72.5	72.5	72.5	72.5
E1-09	Minimum Output Frequency	Hz	3.6	3.6	3.6	3.6	3.6	3.6	3.6	3.6	3.6	3.6
L3-24 </>	Motor Acceleration Time for Inertia Calculations	s	0.098	0.071	0.066	0.087	0.085	0.072	0.084	0.096	0.085	0.08
n8-49	d-Axis Current for High-Efficiency Control	%	–6.6	–10.9	–13.5	–9	–9.5	–10.1	–6	–9.3	–10.7	–13.2

<1> Default setting value is dependent on parameter o2-04, Drive Model Selection.



B.6 Parameters that Change with the Motor Code Selection

■ Drive Software Version PRG: 1017 and Earlier

Table B.16 400 V, 1450 rpm Type Yaskawa SSR1 Series Motor

Par.	Description	Unit	Default Settings									
E5-01	Motor Code	–	1332	1333	1335	1336	1338	133A	133B	133D	133E	133F
	Voltage Class	–	400 Vac	400 Vac	400 Vac	400 Vac	400 Vac	400 Vac	400 Vac	400 Vac	400 Vac	400 Vac
	Rated Power	–	0.4 kW	0.75 kW	1.5 kW	2.2 kW	3.7 kW	5.5 kW	7.5 kW	11 kW	15 kW	18 kW
	Rated Speed	r/min	1450	1450	1450	1450	1450	1450	1450	1450	1450	1450
E5-02	Motor Rated Power	kW	0.4	0.75	1.5	2.2	3.7	5.5	7.5	11.0	15	18.0
E5-03	Motor Rated Current	A	0.89	1.50	2.70	4.10	6.70	9.80	13.30	18.7	26.3	31.5
E5-04	Motor Pole Number	–	6	6	6	6	6	6	6	6	6	6
E5-05	Motor Winding Resistance	Ω	17.620	7.421	4.825	2.656	1.353	0.999	0.713	0.396	0.295	0.223
E5-06	d-Axis Inductance	mH	106.50	85.11	58.87	46.42	31.73	26.20	27.06	15.22	12.65	9.87
E5-07	q-Axis Inductance	mH	166.80	113.19	80.59	60.32	40.45	30.94	33.45	19.63	15.87	12.40
E5-09	Induction Voltage Constant 1	mVs/rad	525.2	566.9	592.2	579.4	586.4	612.1	640.4	643.5	650.6	635.8
E5-24	Induction Voltage Constant 2	mV/(r/min)	0.0	0.0	0.0	0.0	0.0	0.0	0.0	0.0	0.0	0.0
E1-04	Maximum Output Frequency	Hz	72.5	72.5	72.5	72.5	72.5	72.5	72.5	72.5	72.5	72.5
E1-05	Maximum Output Voltage	V	380.0	380.0	380.0	380.0	380.0	380.0	380.0	380.0	380.0	380.0
E1-06	Base Frequency	Hz	72.5	72.5	72.5	72.5	72.5	72.5	72.5	72.5	72.5	72.5
E1-09	Minimum Output Frequency	Hz	3.6	3.6	3.6	3.6	3.6	3.6	3.6	3.6	3.6	3.6
L3-24 </>	Motor Acceleration Time for Inertia Calculations	s	0.098	0.071	0.066	0.087	0.085	0.072	0.084	0.096	0.085	0.082
n8-49	d-Axis Current for High-Efficiency Control	%	-10.8	-8.5	-12.5	-12.2	-12.7	-9.4	-14.4	-15.0	-14.1	-14.3

<1> Default setting value is dependent on parameter o2-04, Drive Model Selection.

Drives Motors Controls

■ Drive Software Version PRG: 1018 and Later

Table B.17 400 V, 1450 rpm Type Yaskawa SSR1 Series Motor

Par.	Description	Unit	Default Settings									
			1332	1333	1335	1336	1338	133A	133B	133D	133E	133F
E5-01	Motor Code	–	1332	1333	1335	1336	1338	133A	133B	133D	133E	133F
	Voltage Class	–	400 Vac	400 Vac	400 Vac	400 Vac	400 Vac	400 Vac	400 Vac	400 Vac	400 Vac	400 Vac
	Rated Power	–	0.4 kW	0.75 kW	1.5 kW	2.2 kW	3.7 kW	5.5 kW	7.5 kW	11 kW	15 kW	18 kW
	Rated Speed	r/min	1450	1450	1450	1450	1450	1450	1450	1450	1450	1450
E5-02	Motor Rated Power	kW	0.4	0.75	1.5	2.2	3.7	5.5	7.5	11	15	18.5
E5-03	Motor Rated Current	A	0.94	1.56	2.81	4.27	6.98	10.21	13.85	19.5	27.4	32.9
E5-04	Motor Pole Number	–	6	6	6	6	6	6	6	6	6	6
E5-05	Motor Winding Resistance	Ω	12.76	7.421	4.825	2.656	1.353	0.999	0.713	0.393	0.295	0.223
E5-06	d-Axis Inductance	mH	128.6	85.11	58.87	46.42	31.73	26.2	27.06	15.51	12.65	9.87
E5-07	q-Axis Inductance	mH	166.96	113.19	80.59	60.32	40.45	30.94	33.45	19.63	15.87	12.4
E5-09	Induction Voltage Constant 1	mVs/rad	528.6	544.2	568.5	572.8	562.9	587.6	670.1	612.7	624.6	610.4
E5-24	Induction Voltage Constant 2	mV/(r/min)	0	0	0	0	0	0	0	0	0	0
E1-04	Maximum Output Frequency	Hz	72.5	72.5	72.5	72.5	72.5	72.5	72.5	72.5	72.5	72.5
E1-05	Maximum Output Voltage	V	380	380	380	380	380	380	380	380	380	380
E1-06	Base Frequency	Hz	72.5	72.5	72.5	72.5	72.5	72.5	72.5	72.5	72.5	72.5
E1-09	Minimum Output Frequency	Hz	3.6	3.6	3.6	3.6	3.6	3.6	3.6	3.6	3.6	3.6
L3-24 <1>	Motor Acceleration Time for Inertia Calculations	s	0.098	0.071	0.066	0.087	0.085	0.072	0.084	0.096	0.085	0.08
n8-49	d-Axis Current for High-Efficiency Control	%	–6.6	–9.2	–13.5	–12.1	–13.7	–10.1	–12.2	–15.5	–15.1	–16

<1> Default setting value is dependent on parameter o2-04, Drive Model Selection.



B.6 Parameters that Change with the Motor Code Selection

■ Drive Software Version PRG: 1017 and Earlier

Table B.18 200 V, 1150 rpm Type Yaskawa SSR1 Series Motor

Par.	Description	Unit	Default Settings									
			1402	1403	1405	1406	1408	140A	140B	140D	140E	140F
E5-01	Motor Code	–	1402	1403	1405	1406	1408	140A	140B	140D	140E	140F
	Voltage Class	–	200 Vac	200 Vac	200 Vac	200 Vac	200 Vac	200 Vac	200 Vac	200 Vac	200 Vac	200 Vac
	Rated Power	–	0.4 kW	0.75 kW	1.5 kW	2.2 kW	3.7 kW	5.5kW	7.5 kW	11 kW	15 kW	18 kW
	Rated Speed	r/min	1150	1150	1150	1150	1150	1150	1150	1150	1150	1150
E5-02	Motor Rated Power	kW	0.4	0.75	1.5	2.2	3.7	5.5	7.5	11.0	15.0	18.0
E5-03	Motor Rated Current	A	1.74	3.17	5.9	8.84	13.7	18.6	25.8	38.6	53.4	63.8
E5-04	Motor Pole Number	–	6	6	6	6	6	6	6	6	6	6
E5-05	Motor Winding Resistance	Ω	6.763	3.660	1.480	0.696	0.412	0.414	0.262	0.149	0.084	0.083
E5-06	d-Axis Inductance	mH	42.88	28.59	17.64	10.40	7.94	10.60	7.53	4.49	3.83	2.78
E5-07	q-Axis Inductance	mH	67.17	44.78	24.23	14.85	11.86	14.92	10.97	6.82	4.65	4.39
E5-09	Induction Voltage Constant 1	mVs/rad	333.3	337.7	365.5	356.2	359.2	428.2	410.0	389.8	387.6	392.6
E5-24	Induction Voltage Constant 2	mV/(r/min)	0.0	0.0	0.0	0.0	0.0	0.0	0.0	0.0	0.0	0.0
E1-04	Maximum Output Frequency	Hz	57.5	57.5	57.5	57.5	57.5	57.5	57.5	57.5	57.5	57.5
E1-05	Maximum Output Voltage	V	190.0	190.0	190.0	190.0	190.0	190.0	190.0	190.0	190.0	190.0
E1-06	Base Frequency	Hz	57.5	57.5	57.5	57.5	57.5	57.5	57.5	57.5	57.5	57.5
E1-09	Minimum Output Frequency	Hz	2.9	2.9	2.9	2.9	2.9	2.9	2.9	2.9	2.9	2.9
L3-24 </>	Motor Acceleration Time for Inertia Calculations	s	0.062	0.044	0.080	0.090	0.067	0.072	0.088	0.073	0.063	0.093
n8-49	d-Axis Current for High-Efficiency Control	%	-13.5	-16.3	-11.8	-12.3	-18.2	-18.7	-21.8	-24.0	-13.4	-25.4

<1> Default setting value is dependent on parameter o2-04, Drive Model Selection.

Drives Motors Controls

■ Drive Software Version PRG: 1018 and Later

Table B.19 200 V, 1150 rpm Type Yaskawa SSR1 Series Motor

Par.	Description	Unit	Default Settings									
			1402	1403	1405	1406	1408	140A	140B	140D	140E	140F
E5-01	Motor Code	–	1402	1403	1405	1406	1408	140A	140B	140D	140E	140F
	Voltage Class	–	200 Vac	200 Vac	200 Vac	200 Vac	200 Vac	200 Vac	200 Vac	200 Vac	200 Vac	200 Vac
	Rated Power	–	0.4 kW	0.75 kW	1.5 kW	2.2 kW	3.7 kW	5.5 kW	7.5 kW	11 kW	15 kW	18 kW
	Rated Speed	r/min	1150	1150	1150	1150	1150	1150	1150	1150	1150	1150
E5-02	Motor Rated Power	kW	0.4	0.75	1.5	2.2	3.7	5.5	7.5	11	15	18.5
E5-03	Motor Rated Current	A	1.88	3.02	6.00	8.85	14.27	20.21	26.67	39.9	55.6	63.5
E5-04	Motor Pole Number	–	6	6	6	6	6	6	6	6	6	6
E5-05	Motor Winding Resistance	Ω	4.832	2.704	1.114	0.511	0.412	0.303	0.165	0.113	0.084	0.066
E5-06	d-Axis Inductance	mH	48.68	32.31	19.22	12.15	7.94	11.13	6.59	4.96	3.83	3.33
E5-07	q-Axis Inductance	mH	63.21	40.24	24.38	15.35	11.86	14.06	8.55	6.12	4.65	4.5
E5-09	Induction Voltage Constant 1	mVs/rad	320.4	327.1	364.4	344.4	357.5	430.8	391.5	384.4	372.1	421.3
E5-24	Induction Voltage Constant 2	mV/(r/min)	0	0	0	0	0	0	0	0	0	0
E1-04	Maximum Output Frequency	Hz	57.5	57.5	57.5	57.5	57.5	57.5	57.5	57.5	57.5	57.5
E1-05	Maximum Output Voltage	V	190	190	190	190	190	190	190	190	190	190
E1-06	Base Frequency	Hz	57.5	57.5	57.5	57.5	57.5	57.5	57.5	57.5	57.5	57.5
E1-09	Minimum Output Frequency	Hz	2.9	2.9	2.9	2.9	2.9	2.9	2.9	2.9	2.9	2.9
L3-24 </>	Motor Acceleration Time for Inertia Calculations	s	0.062	0.044	0.08	0.09	0.067	0.072	0.088	0.073	0.062	0.091
n8-49	d-Axis Current for High-Efficiency Control	%	-8.8	-9.9	-9.3	-10	-17.7	-12.3	-15.3	-13.9	-14.4	-17.9

<1> Default setting value is dependent on parameter o2-04, Drive Model Selection.

Drives Motors Controls

B.6 Parameters that Change with the Motor Code Selection

■ Drive Software Version PRG: 1017 and Earlier

Table B.20 400 V, 1150 rpm Type Yaskawa SSR1 Series Motor

Par.	Description	Unit	Default Settings									
			1432	1433	1435	1436	1438	143A	143B	143D	143E	143F
E5-01	Motor Code	–	1432	1433	1435	1436	1438	143A	143B	143D	143E	143F
	Voltage Class	–	400 Vac	400 Vac	400 Vac	400 Vac	400 Vac	400 Vac	400 Vac	400 Vac	400 Vac	400 Vac
	Rated Power	–	0.4 kW	0.75 kW	1.5 kW	2.2 kW	3.7 kW	5.5kW	7.5 kW	11 kW	15 kW	18 kW
	Rated Speed	r/min	1150	1150	1150	1150	1150	1150	1150	1150	1150	1150
E5-02	Motor Rated Power	kW	0.4	0.75	1.5	2.2	3.7	5.5	7.5	11.0	15	18.0
E5-03	Motor Rated Current	A	0.87	1.59	2.95	4.42	6.80	9.70	12.60	19.1	26.7	31.9
E5-04	Motor Pole Number	–	6	6	6	6	6	6	6	6	6	6
E5-05	Motor Winding Resistance	Ω	27.050	14.640	5.291	2.783	1.480	1.220	0.655	0.443	0.334	0.332
E5-06	d-Axis Inductance	mH	171.50	114.40	70.56	41.61	38.39	45.97	25.46	18.84	15.27	11.10
E5-07	q-Axis Inductance	mH	268.70	179.10	96.90	59.41	47.65	56.26	33.63	24.68	18.56	17.56
E5-09	Induction Voltage Constant 1	mVs/rad	666.9	675.5	731.0	712.4	792.7	859.9	820.2	805.4	796.4	785.1
E5-24	Induction Voltage Constant 2	mV/(r/min)	0.0	0.0	0.0	0.0	0.0	0.0	0.0	0.0	0.0	0.0
E1-04	Maximum Output Frequency	Hz	57.5	57.5	57.5	57.5	57.5	57.5	57.5	57.5	57.5	57.5
E1-05	Maximum Output Voltage	V	380.0	380.0	380.0	380.0	380.0	380.0	380.0	380.0	380.0	380.0
E1-06	Base Frequency	Hz	57.5	57.5	57.5	57.5	57.5	57.5	57.5	57.5	57.5	57.5
E1-09	Minimum Output Frequency	Hz	2.9	2.9	2.9	2.9	2.9	2.9	2.9	2.9	2.9	2.9
L3-24 </>	Motor Acceleration Time for Inertia Calculations	s	0.062	0.044	0.080	0.090	0.067	0.072	0.088	0.073	0.062	0.093
n8-49	d-Axis Current for High-Efficiency Control	%	-13.5	-16.2	-11.8	-12.3	-8.8	-11.5	-14.8	-15.6	-12.5	-25.4

<1> Default setting value is dependent on parameter o2-04, Drive Model Selection.

Drives Motors Controls

■ Drive Software Version PRG: 1018 and Later

Table B.21 400 V, 1150 rpm Type Yaskawa SSR1 Series Motor

Par.	Description	Unit	Default Settings									
			1432	1433	1435	1436	1438	143A	143B	143D	143E	143F
E5-01	Motor Code	–	1432	1433	1435	1436	1438	143A	143B	143D	143E	143F
	Voltage Class	–	400 Vac	400 Vac	400 Vac	400 Vac	400 Vac	400 Vac	400 Vac	400 Vac	400 Vac	400 Vac
	Rated Power	–	0.4 kW	0.75 kW	1.5 kW	2.2 kW	3.7 kW	5.5 kW	7.5 kW	11 kW	15 kW	18 kW
	Rated Speed	r/min	1150	1150	1150	1150	1150	1150	1150	1150	1150	1150
E5-02	Motor Rated Power	kW	0.4	0.75	1.5	2.2	3.7	5.5	7.5	11	15	18.5
E5-03	Motor Rated Current	A	0.94	1.51	3.00	4.43	7.08	10.1	13.33	19.9	27.8	31.8
E5-04	Motor Pole Number	–	6	6	6	6	6	6	6	6	6	6
E5-05	Motor Winding Resistance	Ω	19.32	10.8	4.456	2.044	1.483	1.215	0.66	0.443	0.331	0.264
E5-06	d-Axis Inductance	mH	194.7	129.2	76.88	48.6	37.58	44.54	26.36	19.1	15.09	13.32
E5-07	q-Axis Inductance	mH	252.84	160.9	97.52	61.4	47.65	56.26	34.2	24.67	18.56	18
E5-09	Induction Voltage Constant 1	mVs/rad	640.9	654.1	728.8	688.9	702.0	861.5	783.0	762.2	749.6	842.7
E5-24	Induction Voltage Constant 2	mV/(r/min)	0	0	0	0	0	0	0	0	0	0
E1-04	Maximum Output Frequency	Hz	57.5	57.5	57.5	57.5	57.5	57.5	57.5	57.5	57.5	57.5
E1-05	Maximum Output Voltage	V	380	380	380	380	380	380	380	380	380	380
E1-06	Base Frequency	Hz	57.5	57.5	57.5	57.5	57.5	57.5	57.5	57.5	57.5	57.5
E1-09	Minimum Output Frequency	Hz	2.9	2.9	2.9	2.9	2.9	2.9	2.9	2.9	2.9	2.9
L3-24 </>	Motor Acceleration Time for Inertia Calculations	s	0.062	0.044	0.08	0.09	0.067	0.072	0.088	0.073	0.062	0.091
n8-49	d-Axis Current for High-Efficiency Control	%	-8.8	-9.9	-9.3	-10	-12.8	-12.3	-15.3	-16.7	-14.9	-17.9

<1> Default setting value is dependent on parameter o2-04, Drive Model Selection.

Drives Motors Controls

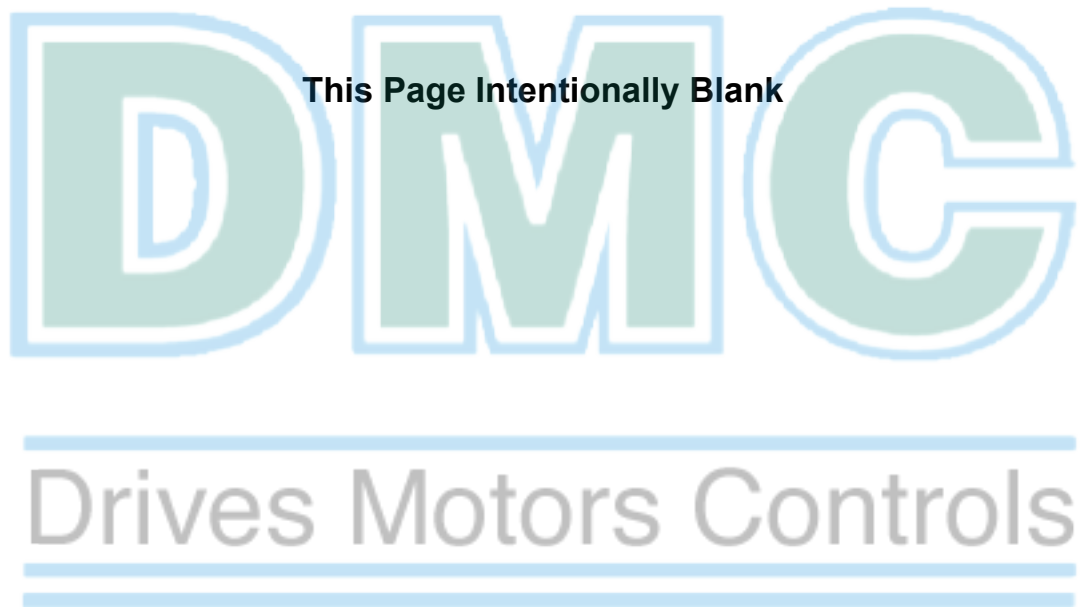

Appendix: C

MEMOBUS/Modbus Communications

C.1	SECTION SAFETY.....	432
C.2	MEMOBUS/MODBUS CONFIGURATION.....	433
C.3	COMMUNICATION SPECIFICATIONS.....	434
C.4	CONNECTING TO A NETWORK.....	435
C.5	MEMOBUS/MODBUS SETUP PARAMETERS.....	439
C.6	DRIVE OPERATIONS BY MEMOBUS/MODBUS.....	442
C.7	COMMUNICATIONS TIMING.....	443
C.8	MESSAGE FORMAT.....	444
C.9	MESSAGE EXAMPLES.....	446
C.10	MEMOBUS/MODBUS DATA TABLE.....	448
C.11	ENTER COMMAND.....	459
C.12	COMMUNICATION ERRORS.....	460
C.13	SELF-DIAGNOSTICS.....	461

Drives Motors Controls

C.1 Section Safety

DANGER

Electrical Shock Hazard

Do not connect or disconnect wiring while the power is on.

Failure to comply will result in death or serious injury.

Before servicing, disconnect all power to the equipment. The internal capacitor remains charged even after the power supply is turned off. The charge indicator LED will extinguish when the DC bus voltage is below 50 Vdc. To prevent electric shock, wait at least one minute after all indicators are OFF and measure the DC bus voltage level to confirm safe level.

WARNING

Do not operate equipment with covers removed.

Failure to comply could result in death or serious injury.

Do not perform work on the drive while wearing loose clothing, jewelry or without eye protection.

Failure to comply could result in death or serious injury.

Remove all metal objects such as watches and rings, secure loose clothing and wear eye protection before beginning work on the drive.

Do not remove covers or touch circuit boards while the power is on.

Failure to comply could result in death or serious injury.

Do not allow unqualified personnel to use equipment.

Failure to comply could result in death or serious injury.

Maintenance, inspection and replacement of parts must be performed only by authorized personnel familiar with installation, adjustment and maintenance of AC drives.

Before wiring terminals, disconnect all power to the equipment.

The internal capacitor remains charged even after the power supply is turned off. The charge indicator LED will extinguish when the DC bus voltage is below 50 Vdc. To prevent electric shock, wait at least one minute after all indicators are OFF and measure the DC bus voltage level to confirm safe level.

Fire Hazard

Tighten all terminal screws to the specified tightening torque.

Loose electrical connections could result in death or serious injury by fire due to overheating of electrical connections.

CAUTION

Crush Hazard

Do not carry the drive by the front cover.

Failure to comply may result in minor or moderate injury from the main body of the drive falling.

NOTICE

Observe proper electrostatic discharge procedures (ESD) when handling the drive and circuit boards.

Failure to comply may result in ESD damage to the drive circuitry.

Check all the wiring to ensure that all connections are correct after installing the drive and connecting any other devices.

Failure to comply could result in damage to the drive.

C.2 MEMOBUS/Modbus Configuration

Drives can be controlled from a PLC or other master device via serial communications using the MEMOBUS/Modbus protocol. MEMOBUS/Modbus communication can be configured using one master (PLC) and a maximum of 255 slaves. The drive has slave functionality only, meaning that serial communication is normally initiated from the master and responded to by the slaves.

The master performs serial communications with only one slave at a time. The address or node for each slave must be set beforehand so that the master can communicate with the slave at that address. A slave that receives a command from the master will perform the specified function and then send a response back to the master.

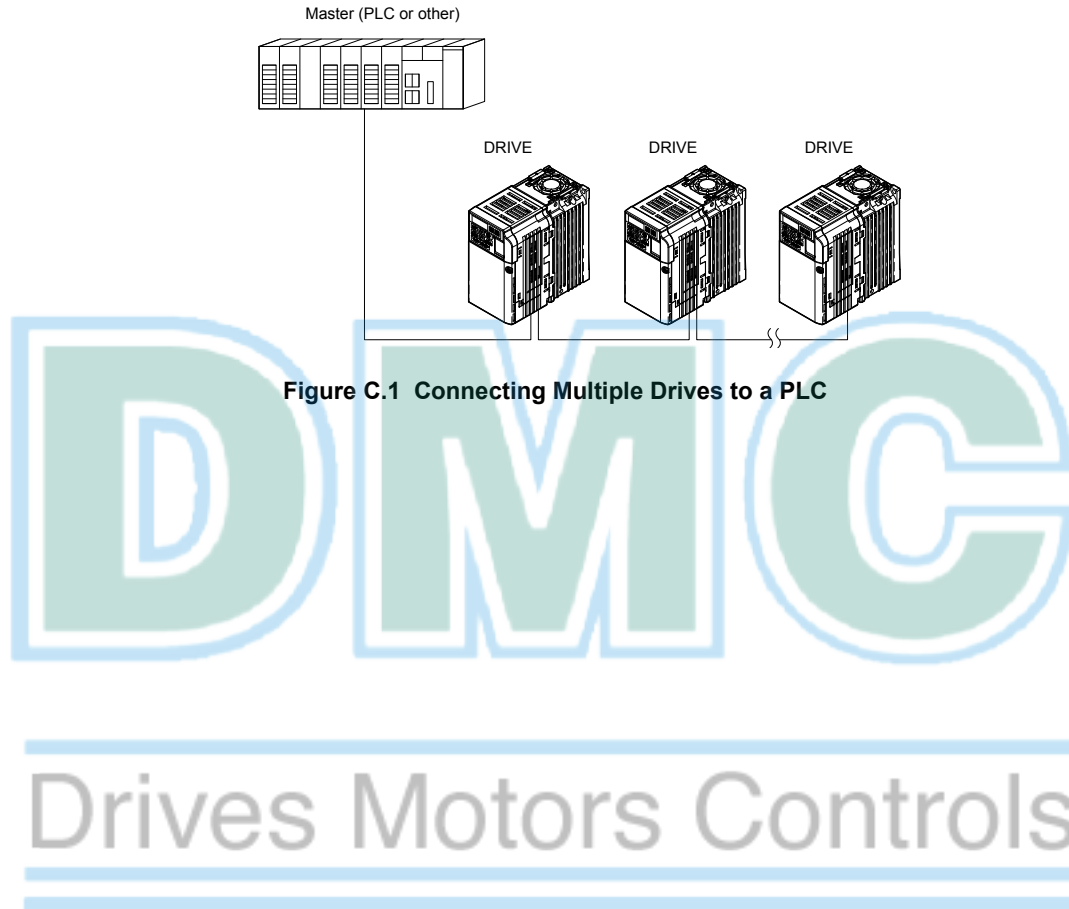

C.3 Communication Specifications

MEMOBUS/Modbus specifications appear in the following table:

Item	Specifications	
Interface	RS-422, RS-485	
Communications Cycle	Asynchronous (Start-stop synchronization)	
Communication Parameters	Communication Speeds Available	1.2; 2.4; 4.8; 9.6; 19.2; 38.4; 57.6; 76.8; 115.2 kbps
	Data length	8 bit (fixed)
	Parity	Select even, odd, or none
	Stop bit	1 bit (fixed)
Protocol	MEMOBUS/Modbus (using RTU mode only)	
Max Number of Slaves	31 drives	



Drives Motors Controls

C.4 Connecting to a Network

This section explains the connection of a drive to a MEMOBUS/Modbus network and the network termination.

◆ Network Cable Connection

Follow the instructions below to connect the drive to a MEMOBUS/Modbus network.

1. With the power shut off, connect the communications cable to the drive and the master. Use the terminals shown in the figure below for network cable connections.

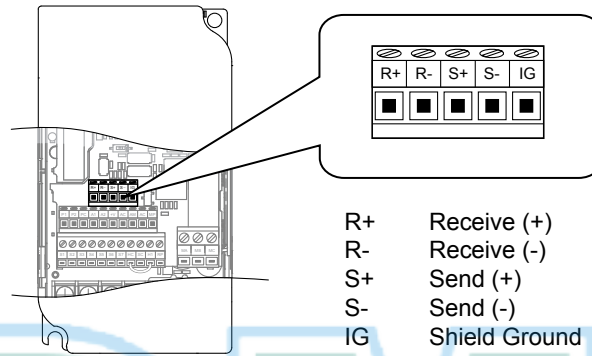

Figure C.2 Serial Communications Cable Connection Terminals

Note: Separate the communications cables from the main circuit cables and other wiring and power cables. Use shielded cables for the communications cables, and properly shielded clamps to prevent problems with noise. When using RS-485 communications, connect S+ to R+, and S- to R- as shown in the diagram below.

2. Check or set the terminating resistance at all slaves. Use the description in [Network Termination](#) for slaves that are 1000 series drives.
3. Switch the power on.
4. Set the parameters needed for serial communications (H5-01 through H5-12) using the LED operator.
5. Shut the power off and wait until the display on the LED operator goes out completely.
6. Turn the power back on.
7. The drive is now ready to begin communicating with the master.

Drives Motors Controls

◆ Wiring Diagram for Multiple Connections

Figure C.3 and *Figure C.4* explain the wiring diagrams for multiple connections using MEMOBUS/Modbus communication.

■ RS-485 Interface

Note: The isolated ground (IG) connection is optional but strongly recommended to improve network immunity to electrical interference.

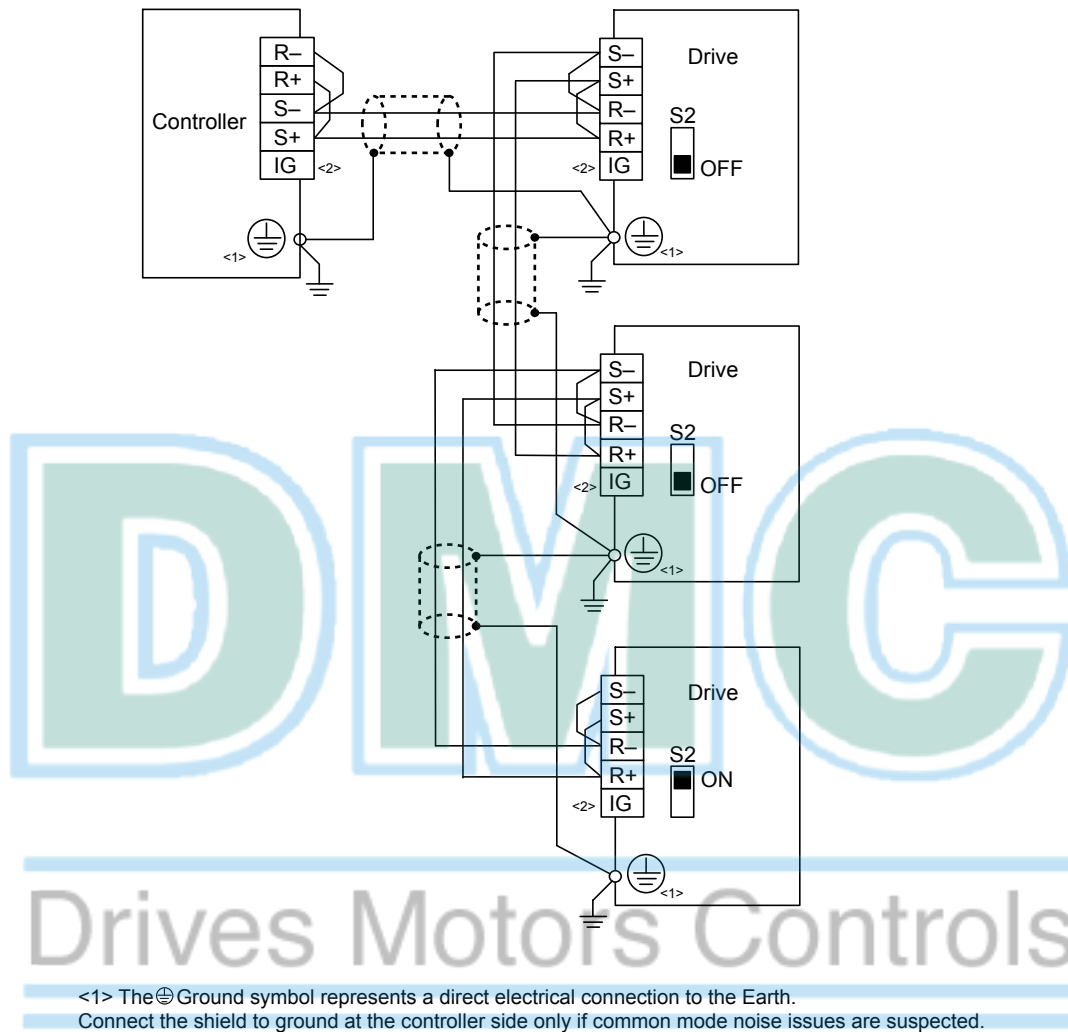

Figure C.3 RS-485 Interface

- Note:**
1. Set DIP switch S2 to the ON position on the drive located at the end of the network. Set DIP switch S2 to the OFF positions on all other slave devices.
 2. Set H5-07 to 1 when using the RS-485 interface.

■ RS-422 Interface

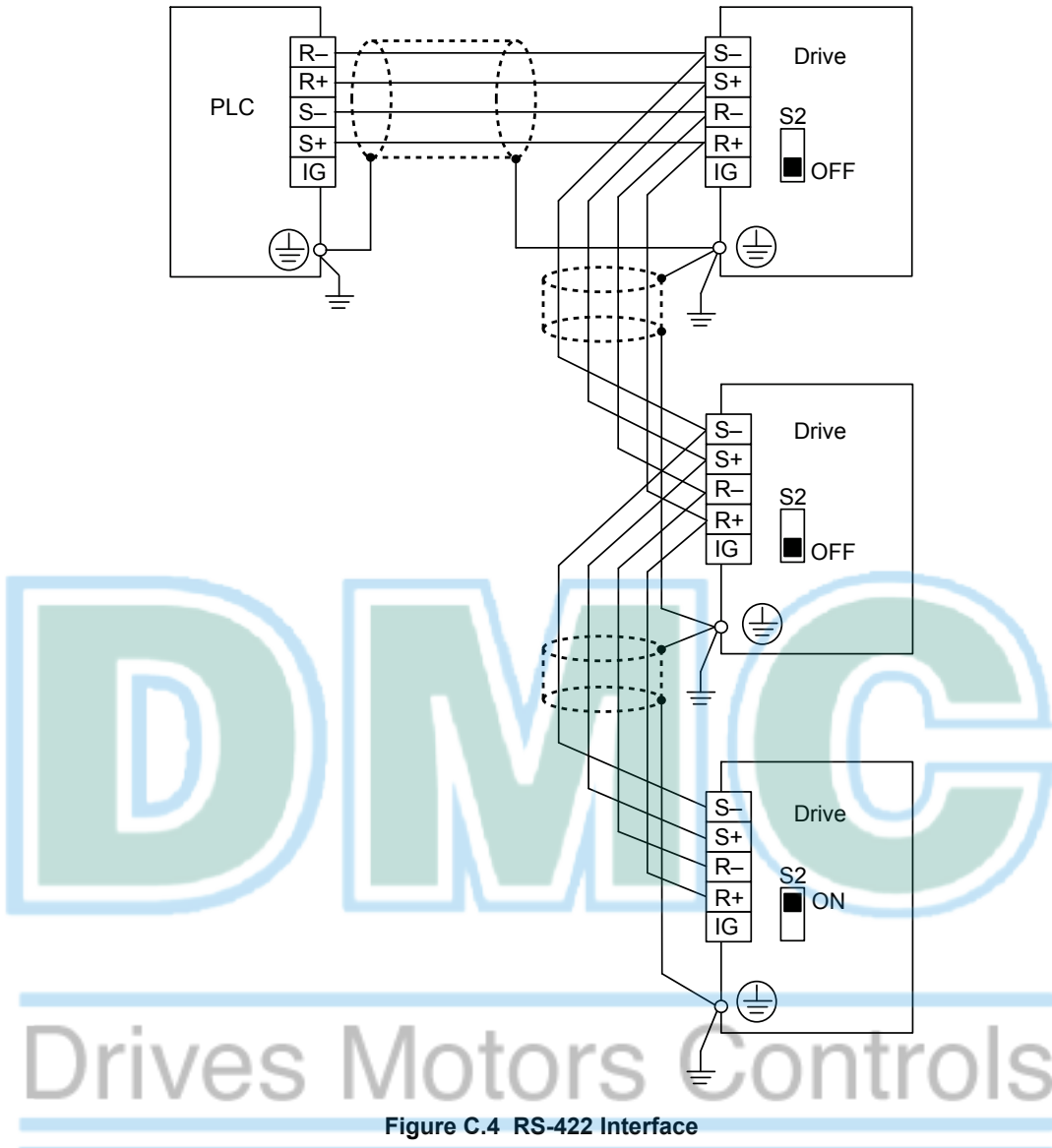

Figure C.4 RS-422 Interface

- Note:**
- 1. Set DIP switch S2 to the ON position on the drive located at the end of the network. Set DIP switch S2 to the OFF positions on all other slave devices.
 - 2. Set H5-07 to 1 when using the RS-422 interface in a multi-drop circuit. Set H5-07 to 0 when using the RS-422 interface in a point-to-point circuit.

◆ Network Termination

The two ends of the MEMOBUS/Modbus network line have to be terminated. The drive has a built in terminating resistance that can be enabled or disabled using DIP switch S2. If a drive is located at the end of a network line, enable the terminating resistance by setting DIP switch S2 to the ON position. Disable the terminating resistance on all slaves that are not located at the network line end. [Figure C.5](#) illustrates the setting of DIP switch S2.

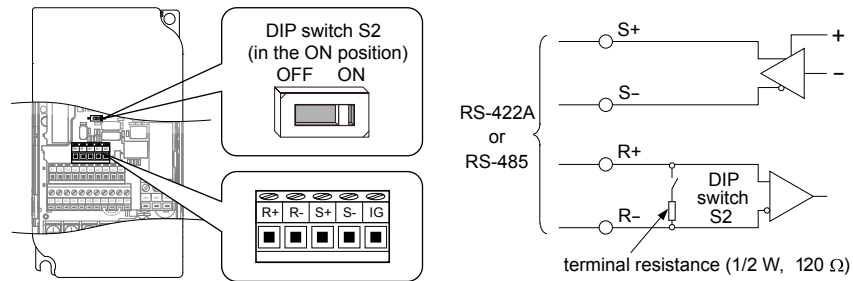

Figure C.5 Serial Communications Terminal and DIP Switch S2



C.5 MEMOBUS/Modbus Setup Parameters

◆ MEMOBUS/Modbus Serial Communication

This section describes parameters necessary to set up MEMOBUS/Modbus communications.

■ H5-01: Drive Slave Address

Sets the drive slave address used for MEMOBUS/Modbus communications.

Note: After changing this parameter, the power must be cycled to enable the new setting.

No.	Name	Setting Range	Default
H5-01	Drive Slave Address	0 to 20 H </>	1F

<1> If the address is set to 0, no response will be provided during communications.

For serial communications to work, each individual slave drive must be assigned a unique slave address. Setting H5-01 to any value besides 0 assigns the drive its address in the network. Slave address don't need to be assigned in sequential order, but each address needs to be unique so that no two drives have the same address.

■ H5-02: Communication Speed Selection

Sets the MEMOBUS/Modbus communications speed.

Note: After changing this parameter, the power must be cycled to enable the new setting.

No.	Name	Setting Range	Default
H5-02	Communication Speed Selection	0 to 5	3

H5-02	Communication Speed	H5-02	Communication Speed
0	1200 bps	5	38400 bps
1	2400 bps	6	57600 bps
2	4800 bps	7	76800 bps
3	9600 bps	8	115200 bps
4	19200 bps		–

■ H5-03: Communication Parity Selection

Sets the parity used for MEMOBUS/Modbus communications.

Note: After changing this parameter, the power must be cycled to enable the new setting.

No.	Name	Setting Range	Default
H5-03	Communication Parity Selection	0 to 2	0

Setting 0: No Parity

Setting 1: Even Parity

Setting 2: Odd Parity

■ H5-04: Stopping Method after Communication Error

Selects the stopping method after a communications error (CE) has occurred.

No.	Name	Setting Range	Default
H5-04	Stopping Method after Communication Error	0 to 3	3

Setting 0: Ramp to Stop Using Current Accel/Decel Time

Setting 1: Coast to Stop

Setting 2: Fast-stop Using C1-09

C.5 MEMOBUS/Modbus Setup Parameters

Setting 3: Alarm Only, Continue Operation

■ H5-05: Communication Fault Detection Selection

Enables or disabled the communication error (CE) detection for MEMOBUS/Modbus communications.

No.	Name	Setting Range	Default
H5-05	Communication Fault Detection Selection	0 or 1	1

Setting 0: Disabled

No error detection. The drive continues operation.

Setting 1: Enabled

If the drive does not receive data from the master for longer than the time set to H5-09, then a CE fault will be triggered and the drive will operate as determined by parameter H5-04.

■ H5-06: Drive Transmit Wait Time

Sets the time the drive waits after receiving data from a master until responding data.

No.	Name	Setting Range	Default
H5-06	Drive Transmit Wait Time	5 to 65 ms	5 ms

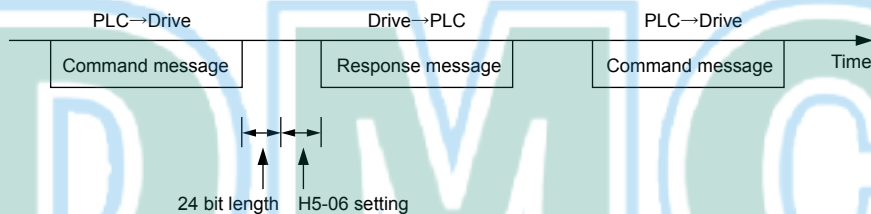

Figure C.6 Drive Transmit Wait Time Setting

■ H5-07: RTS Control Selection

Enables or disables RTS control.

No.	Name	Setting Range	Default
H5-07	RTS Control Selection	0 or 1	1

Setting 0: Disabled - RTS is Always ON

Use this setting when using RS-422 signals for communications (1:1).

Setting 1: Enabled - RTS Switches while Sending

Use this setting when using RS-485 signals for communications or when using the RS-422 signals for multi-drop communications.

■ H5-09: CE Detection Time

Sets the time the communications must be lost before the drive triggers a CE fault.

No.	Name	Setting Range	Default
H5-09	CE Detection Time	0.0 to 10.0 s	2.0 s

■ H5-10: Unit Selection for MEMOBUS/Modbus Register 0025H

Sets the unit for the output voltage monitor value in MEMOBUS/Modbus register 0025H.

No.	Name	Setting Range	Default
H5-10	Unit Selection for MEMOBUS/Modbus Register 0025H	0 or 1	0

Setting 0: 0.1 V Units

Setting 1: 1 V Units

■ H5-11: Communications Enter Function Selection

Selects if an Enter command is needed to change parameter values via MEMOBUS/Modbus communications. *Refer to Enter Command on page 459.*

No.	Name	Setting Range	Default
H5-11	Communications Enter Function Selection	0 or 1	1

Setting 0: Enter Command Necessary

Parameter changes become effective after an Enter command. An Enter command must only be sent after the last parameter change, not for each single parameter (such as in Varispeed F7).

Setting 1: Enter Command not Necessary

Parameter value changes become effective immediately without the need to send an Enter command (such as in Varispeed VS606-V7)

■ H5-12: Run Command Method Selection

Selects the type of sequence used when the Run command source is set to MEMOBUS/Modbus communications (b1-02/16 = 2).

No.	Name	Setting Range	Default
H5-12	Run Command Method Selection	0 or 1	0

Setting 0: FWD/Stop, REV/Stop

Bit 0 of MEMOBUS/Modbus register 0001H will start and stop the drive in the forward direction. Bit 1 will start and stop the drive in reverse.

Setting 1: Run/Stop, FWD/REV

Bit 0 of MEMOBUS/Modbus register 0001H will start and stop the drive. Bit 1 changes the direction.

Drives Motors Controls

C.6 Drive Operations by MEMOBUS/Modbus

The drive operations that can be performed by MEMOBUS/Modbus communication depend on drive parameter settings. This section explains the functions that can be used and related parameter settings.

◆ Observing the Drive Operation

A PLC can perform the following actions with MEMOBUS/Modbus communications at any time regardless of parameter settings (except H5-□□).

- Observe drive status and drive control terminal status from a PLC.
- Read and write parameters.
- Set and reset faults.
- Set multi-function inputs. Inputs settings from the input terminals S□ and from MEMOBUS/Modbus communications are both linked by an OR operation.

◆ Controlling the Drive

To start and stop the drive or set the frequency reference using MEMOBUS/Modbus communications, an external reference must be selected and the parameters listed below must be adjusted accordingly.

Table C.1 Setting Parameters for Drive Control from MEMOBUS/Modbus

Reference Source	Parameter	Name	Required Setting
External Reference 1	b1-01	Frequency Reference Selection 1	2
	b1-02	Run Command Selection 1	2
External Reference 2	b1-15	Frequency Reference Selection 2	2
	b1-16	Run Command Selection 2	2

Refer to b1-01: Frequency Reference Selection 1 on page 121 and Refer to b1-02: Run Command Selection 1 on page 123 for details on external reference parameter selections. Refer to Setting 2: External Reference 1/2 Selection on page 186 for instructions on how to select external reference 1 and 2.

Drives Motors Controls

C.7 Communications Timing

To prevent overrun in the slave drive, the master should wait a certain time between sending messages to the same drive. In the same way, the slave drive must wait before sending response messages to prevent an overrun in the master. This section explains the message timing.

◆ Command Messages from Master to Drive

In order to prevent overrun and data loss, the master must wait between receiving a response and sending the same type of command as before to the same slave drive. The minimum wait time depends on the command as shown in the table below.

Table C.2 Minimum Wait Time for Sending Messages

Command Type	Example	Minimum Wait Time
1	<ul style="list-style-type: none"> Control command (Run, Stop) Set inputs/outputs Read monitors and parameter values 	5 ms
2	<ul style="list-style-type: none"> Write parameters 	H5-11 = 0: 50 ms H5-11 = 1: 200 ms </>
3	<ul style="list-style-type: none"> Save changes using an Enter command 	200 ms to 2 s, depending on the number of changed parameters </>

<1> If the drive receives command type 1 data during the minimum wait time, it will perform the command and then respond. However, if it receives a command type 2 or 3 during that time, either a communication error will result or the command will be ignored.

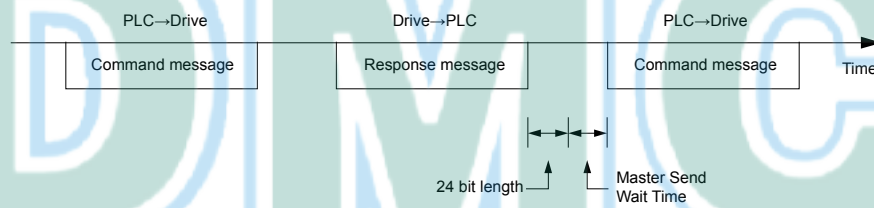

Figure C.7 Minimum Wait Time for Sending Messages

A timer should be set in the master to check how long it takes for the slave drive(s) to respond to the master. If no response is received within a certain amount of time, the master should try resending the message.

◆ Response Messages from Drive to Master

If the drive receives a command from the master, it will process the data received and wait for the time set in H5-06 until it responds. Increase H5-06 if the drive response causes overrun in the master.

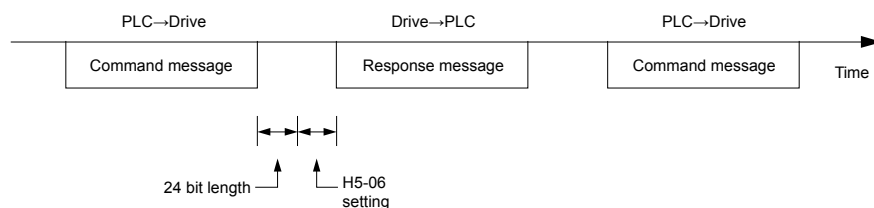

Figure C.8 Minimum Response Wait Time

C.8 Message Format

◆ Message Content

In MEMOBUS/Modbus communications, the master sends commands to the slave, and the slave responds. The message format is configured for both sending and receiving as shown below, and the length of data packets depends on the command (function) content.

SLAVE ADDRESS
FUNCTION CODE
DATA
ERROR CHECK

◆ Slave Address

The slave address in the message defines the note the message is sent to. Use addresses between 0 and 20H. If a message with slave address 0 is sent (broadcast), the command from the master will be received by all slaves. The slaves do not provide a response to a broadcast type message.

◆ Function Code

The three types of function codes are shown in the table below.

Function Code	Function Name	Data Length (bytes)			
		Command Message		Response Message	
		Minimum	Maximum	Minimum	Maximum
03H	Read MEMOBUS/Modbus registers	8	8	7	37
08H	Loopback test	8	8	8	8
10H	Write to multiple MEMOBUS/Modbus registers	11	41	8	8

◆ Data

Configure consecutive data by combining the MEMOBUS/Modbus register address (test code in case of a loopback test) and the data the register contains. The data length changes depending on the command details.

A drive MEMOBUS/Modbus register always has a data length of two bytes. Therefore data written into drive registers must also always have a length of two bytes. Register data read out from the drive will always consist of two bytes.

◆ Error Check

The drive uses a CRC-16 (cyclic redundancy check, checksum method) for checking data validity. Use the procedure described below when calculating the CRC-16 checksum for command data or when verifying response data.

■ Command Data

When the drive receives data, it calculates the CRC-16 checksum from the data and compares it to the CRC-16 value received within the message. Both must match before a command is processed.

An initial value of FFFFH (i.e., all 16 bits equal 1) must be used for CRC-16 calculations for the MEMOBUS/Modbus protocol.

Calculate the CRC-16 checksum using the following steps:

- The starting value is FFFFH.
- Perform an XOR operation of this value and the slave address.
- Right shift the result.
- When the overflow bit of the shift operation becomes 1, perform an XOR operation of the result from step 3 above and the fix value A001H.
- Repeat steps 3 and 4 until eight shift operations have been performed.
- After eight shift operations, perform an XOR operation with the result and the next data in the message (function code, register address, data). Continue with steps 3 to 5 until the last data has been processed.
- The result of the last shift or XOR operation is the checksum.

The example in *Table C.3* shows the CRC-16 calculation of the slave address 02H and the function code 03H, yielding the result D140H.

Note: This example does not show the calculation for a complete MEMOBUS/Modbus command. Normally data would follow in the calculation.

Table C.3 CRC-16 Checksum Calculation Example

Description	Calculation	Overflow	Description	Calculation	Overflow
Initial Value (FFFFH)	1111 1111 1111 1111		Function Code 03H	0000 0000 0000 0011	
Address 02H	0000 0000 0000 0010		XOR w result	1000 0001 0011 1101	
XOR w initial value	1111 1111 1111 1101		Shift 1	0100 0000 1001 1110	1
Shift 1	0111 1111 1111 1110	1	XOR w A001H	1010 0000 0000 0001	
XOR w A001H	1010 0000 0000 0001		XOR result	1110 0000 1001 1111	
XOR result	1101 1111 1111 1111		Shift 2	0111 0000 0100 1111	1
Shift 2	0110 1111 1111 1111	1	XOR w A001H	1010 0000 0000 0001	
XOR w A001H	1010 0000 0000 0001		XOR result	1101 0000 0100 1110	
XOR result	1100 1111 1111 1110		Shift 3	0110 1000 0010 0111	0
Shift 3	0110 0111 1111 1111	0	Shift 4	0011 0100 0001 0011	0
Shift 4	0011 0011 1111 1111	1	XOR w A001H	1010 0000 0000 0001	
XOR w A001H	1010 0000 0000 0001		XOR result	1001 0100 0001 0010	
XOR result	1001 0011 1111 1110		Shift 5	0100 1010 0000 1001	0
Shift 5	0100 1001 1111 1111	0	Shift 6	0010 0101 0000 0100	1
Shift 6	0010 0100 1111 1111	1	XOR w A001H	1010 0000 0000 0001	
XOR w A001H	1010 0000 0000 0001		XOR result	1000 0101 0000 0101	
XOR result	1000 0100 1111 1110		Shift 7	0100 0010 1000 0010	1
Shift 7	0100 0010 0111 1111	0	XOR w A001H	1010 0000 0000 0001	
Shift 8	0010 0001 0011 1111	1	XOR result	1110 0010 1000 0011	
XOR w A001H	1010 0000 0000 0001		Shift 8	0111 0001 0100 0001	1
XOR result	1000 0001 0011 1110		XOR w A001H	1010 0000 0000 0001	
			XOR result	1101 0001 0100 0000	
				1101 0001 0100 0000	
Perform operations with next data (function code)			CRC-16	D 1 4 0 (Lower) (Upper)	
			Continue from here with next data.		

Response Data

To be sure that the data is valid, perform a CRC-16 calculation on the response message data as described above. Compare the result to the CRC-16 checksum that was received within the response message. Both should match.

C.9 Message Examples

Below are some examples of command and response messages.

◆ Reading Drive MEMOBUS/Modbus Register Contents

Using the function code 03H (Read), a maximum of 16 MEMOBUS/Modbus registers can be read out at a time.

The following table shows message examples when reading status signals, error details, data link status, and frequency references from the slave 2 drive.

Command Message			Response Message (normal)			Response Message (fault)		
Slave Address		02H	Slave Address		02H	Slave Address		02H
Function Code		03H	Function Code		03H	Function Code		83H
Starting No.	Upper	00H	Data Quantity		08H	Error Code		03H
	Lower	20H	1st storage register	Upper	00H	CRC-16	Upper	F1H
Data Quantity	Upper	00H		Lower	65H		Lower	31H
	CRC-16	Upper	45H	Next storage register	Upper	00H		
Lower		FOH	Lower		00H			
CRC-16	Upper	45H	Next storage register	Upper	00H			
	Lower	FOH		Lower	00H			
CRC-16	Upper	45H	Next storage register	Upper	01H			
	Lower	FOH		Lower	F4H			
CRC-16	Upper	45H	CRC-16	Upper	AFH			
	Lower	FOH		Lower	82H			

◆ Loopback Test

Function code 08H performs a loopback test. This test returns a response message with exactly the same content as the command message and can be used to check the communications between the master and slave. User-defined test code and data values can be set.

The following table shows a message example when performing a loopback test with the slave 1 drive.

Command Message			Response Message (normal)			Response Message (fault)		
Slave Address		01H	Slave Address		01H	Slave Address		01H
Function Code		08H	Function Code		08H	Function Code		89H
Test Code	Upper	00H	Test Code	Upper	00H	Error Code		01H
	Lower	00H		Lower	00H	CRC-16	Upper	86H
Data	Upper	A5H	Data	Upper	A5H		Lower	50H
	Lower	37H		Lower	37H			
CRC-16	Upper	DAH	CRC-16	Upper	DAH			
	Lower	8DH		Lower	8DH			

◆ Writing to Multiple Registers

Function code 10h allows the user to write multiple drive MEMOBUS/Modbus registers with one message. This process works similar to reading registers, i.e., the address of the first register that is to be written and the data quantity must be set in the command message. The data to be written must be consecutive so that the register addresses are in order, starting from the specified address in the command message. The data order must be high byte, then lower byte.

The following table shows an example of a message where a forward operation has been set with a frequency reference of 60.00 Hz for the slave 1 drive.

If parameter values are changed using the Write command, depending on the setting of H5-11, an Enter command will be necessary to activate the data or save them. [Refer to H5-11: Communications Enter Function Selection on page 441](#) and [Refer to Enter Command on page 459](#) for detailed descriptions.

Command Message			Response Message (normal)			Response Message (fault)		
Slave Address		01H	Slave Address		01H	Slave Address		01H
Function Code		10H	Function Code		10H	Function Code		90H
Starting No.	Upper	00H	Starting No.	Upper	00H	Error Code		02H
	Lower	01H		Lower	01H	CRC-16	Upper	CDH
Data Quantity	Upper	00H	Data Quantity	Upper	00H		Lower	C1H
	Lower	02H		Lower	02H			
Number of Bytes		04H	CRC-16	Upper	10H			
Starting Data	Upper	00H		Lower	08H			
	Lower	01H						
Next Data	Upper	17H						
	Lower	70H						
CRC-16	Upper	6DH						
	Lower	67H						

Note: For the number of bytes in the command message, take double the number of the data quantity.

Drives Motors Controls

C.10 MEMOBUS/Modbus Data Table

Table below lists all MEMOBUS/Modbus data. There are three types of data: command data, monitor data, and broadcast data.

◆ Command Data

It is possible to both read and write command data.

Note: Bits that are not used should be set to 0. Refrain from writing to reserved registers.

Register No.	Contents	
0000H	Reserved	
0001H	Operation Signals and Multi-function Inputs	
	bit 0	H5-12 = 0: Forward Run Command (0 = Stop, 1 = Forward Run) H5-12 = 1: Run Command (0 = Stop, 1 = Run)
	bit 1	H5-12 = 0: Reverse Run Command (0 = Stop, 1 = Reverse Run) H5-12 = 1: Forward/Reverse (0 = Forward, 1 = Reverse)
	bit 2	External Fault (EF0)
	bit 3	Fault Reset
	bit 4	Multi-Function Input 1 Function is ComRef when H1-01 = 40 (Forward/Stop). Note: When the bit at ComRef is turned on, commands from MEMOBUS/Modbus communications take control of the frequency. When a communications option card is connected, that option card is given priority.
	bit 5	Multi-Function Input 2 Function is ComCtrl when H1-02 = 41 (Reverse/Stop).
	bit 6	Multi-Function Input 3
	bit 7	Multi-Function Input 4
	bit 8	Multi-Function Input 5
	bit 9	Multi-Function Input 6
	bit A	Multi-Function Input 7
	bit B to F	Reserved
	0002H	Frequency Reference
0003H	Output Voltage Gain	Set in units of 1 (0.1%) with a setting range of 20 to 2000 (2.0% to 200.0%) Note: Initial value at power up: 1000 (100.0%)
0004H-0005H	Reserved	
0006H	PID Target, 0.01% units, signed	
0007H	Analog Output Terminal AM Setting (10 V / 4000 H)	
0008H	Reserved	
0009H	Settings for Multi-Function Digital Outputs	
	bit 0	Contact Output (terminal MA/MB-MC)
	bit 1	Photocoupler Output 1 (terminal P1-PC)
	bit 2	Photocoupler Output 2 (terminal P2-PC)
	bit 3 to F	Reserved
000AH	Pulse Output Terminal MP Setting, 1 Hz units, Setting Range: 0 to 32000	
000BH-000EH	Reserved	
000FH	Control Selection Setting	
	bit 0	Reserved
	bit 1	PID Target Input
	bit 2 to B	Reserved
	bit C	Enable Terminal S5 Input for Broadcast Data
	bit D	Enable Terminal S6 Input for Broadcast Data
	bit E	Enable Terminal S7 Input for Broadcast Data
	bit F	Reserved

◆ Monitor Data

Monitor data can be read only.

Register No.	Contents	
0020H	Drive Status 1	
	bit 0	During Run
	bit 1	During Reverse
	bit 2	Drive Ready
	bit 3	Fault
	bit 4	Data Setting Error
	bit 5	Multi-Function Contact Output (terminal MA/MB-MC)
	bit 6	Multi-Function Photocoupler Output 1 (terminal P1 - PC)
	bit 7	Multi-Function Photocoupler Output 2 (terminal P2 - PC)
	bit 8 to bit D	Reserved
	bit E	When ComRef has been enabled
	bit F	When ComCtrl has been enabled
0021H	Fault Contents 1	
	bit 0	Overcurrent (oC), Ground fault (GF), IGBT Short Circuit or Ground Fault (SC)
	bit 1	Overvoltage (ov)
	bit 2	Drive Overload (oL2)
	bit 3	Overheat 1 (oH1), Drive Overheat Warning (oH2)
	bit 4	Dynamic Braking Transistor Fault (rr), Braking Resistor Overheat (rH)
	bit 5	Reserved
	bit 6	PID Feedback Loss (FbL/FbH)
	bit 7	EF0 to 7: External Fault
	bit 8	CPF□□: Hardware Fault (includes oFA□□)
	bit 9	Motor Overload (oL1), Overtorque Detection 1/2 (oL3/oL4), Undertorque Detection 1/2 (UL3/UL4)
	bit A	PG Disconnected (PGo), Overspeed (oS), Excessive Speed Deviation (dEv),
	bit B	Main Circuit Undervoltage (Uv)
	bit C	Undervoltage (Uv1), Control Power Supply Undervoltage (Uv2), Soft Charge Circuit Fault (Uv3)
bit D	Output Phase Loss (LF), Input Phase Loss (PF)	
bit E	MEMOBUS/Modbus Communication Error (CE), Option Communication Error (bUS)	
bit F	Operator Connection Fault (oPr)	
0022H	Data Link Status	
	bit 0	Writing data or switching motors
	bit 1	Reserved
	bit 2	Reserved
	bit 3	Upper or lower limit error
	bit 4	Data conformity error
	bit 5	Writing to EEPROM
bit 6 to bit F	Reserved	
0023H	Frequency Reference, <f>	
0024H	Output Frequency, <f>	
0025H	Output Voltage Reference, 0.1 V units (units are determined by parameter H5-10)	
0026H	Output Current, <f>	
0027H	Output Power	
0028H	Torque Reference (OLV only)	

C.10 MEMOBUS/Modbus Data Table

Register No.	Contents	
0029H	Fault Contents 2	
	bit 0	IGBT Short Circuit or Ground Fault (SC)
	bit 1	Ground Fault (GF)
	bit 2	Input Phase Loss (PF)
	bit 3	Output Phase Loss (LF)
	bit 4	Braking Resistor Overheat (rH)
	bit 5	Reserved
	bit 6	Motor Overheat 2 (PTC input) (oH4)
	bit 7 to bit F	Reserved
002AH	Alarm Contents1	
	bit 0 to bit 1	Reserved
	bit 2	Run Command Input Error (EF)
	bit 3	Drive Baseblock (bb)
	bit 4	Overtorque Detection 1 (oL3)
	bit 5	Heatsink Overheat (oH)
	bit 6	Overvoltage (ov)
	bit 7	Undervoltage (Uv)
	bit 8	Reserved
	bit 9	MEMOBUS/Modbus Communication Error (CE)
	bit A	Option Communication Error (bUS)
	bit B	Undertorque Detection 1/2 (UL3/UL4)
	bit C	Motor Overheat (oH3)
	bit D	PID Feedback Loss (FbL, FbH)
bit E	Reserved	
bit F	Serial Communication Transmission Error (CALL)	
002BH	Input Terminal Status	
	bit 0	Terminal S1 Closed
	bit 1	Terminal S2 Closed
	bit 2	Terminal S3 Closed
	bit 3	Terminal S4 Closed
	bit 4	Terminal S5 Closed
	bit 5	Terminal S6 Closed
	bit 6	Terminal S7 Closed
	bit 7 to bit F	Reserved

Register No.	Contents	
002CH	Drive Status 2	
	bit 0	During Run
	bit 1	Zero Speed
	bit 2	Speed Agree
	bit 3	User Speed Agree
	bit 4	Frequency Detection 1
	bit 5	Frequency Detection 2
	bit 6	Drive Ready
	bit 7	During Undervoltage
	bit 8	During Baseblock
	bit 9	Frequency Reference from Operator Keypad
	bit A	Run Command from Operator Keypad
	bit B	Over/Undertorque 1, 2
	bit C	Frequency Reference Loss
	bit D	During Fault Restart
bit E	Fault	
bit F	Communication Timeout	
002DH	Output Terminal Status	
	bit 0	Multi-Function Contact Output (terminal MA/MB-MC)
	bit 1	Multi-Function Photocoupler Output 1 (terminal P1 - PC)
	bit 2	Multi-Function Photocoupler Output 2 (terminal P2 - PC)
	bit 3 to bit F	Reserved
002EH	Reserved	
002FH	Frequency Reference Bias (from Up/Down 2 Function), 0.1% units	
0030H	Reserved	
0031H	DC Bus Voltage, 1 Vdc units	
0032H	Torque Monitor, 1% units	
0033H	Reserved	
0034H	Product Code 1 [ASCII], Product Type (V0 for V1000)	
0035H	Product Code 2 [ASCII], Region Code	
0036H to 0037H	Reserved	
0038H	PID Feedback, 0.1% units, unsigned, 100% / max. output frequency	
0039H	PID Input, 0.1% units, signed, 100% / max. output frequency	
003AH	PID Output, 0.1% units, signed, 100% / max. output frequency	
003BH to 003CH	Reserved	
003DH	Communications Error Log <>	
	bit 0	CRC Error
	bit 1	Data Length Error
	bit 2	Reserved
	bit 3	Parity Error
	bit 4	Overflow Error
	bit 5	Framing Error
	bit 6	Timeout
	bit 7 to bit F	Reserved
003EH	Output Frequency	r/min <4>
003FH		0.01% units
0040H to 004AH	Used for various monitors U1-□□. Refer to U: Monitors on page 399 for parameter details.	

C.10 MEMOBUS/Modbus Data Table

Register No.	Contents	
004BH	Drive status (U1-12)	
	bit 0	During Run
	bit 1	During Zero Speed
	bit 2	During Reverse Run
	bit 3	During Fault Reset Signal Input
	bit 4	During Speed Agree
	bit 5	Drive Ready
	bit 6	Alarm
	bit 7	Fault
	bit 8	During Operation Error (oPE□□)
	bit 9	During Momentary Power Loss
	bit A	Motor 2 selected
	bit B to D	Reserved
	bit E	ComRef status, NetRef status
bit F	ComCtrl status, NetCtrl status	
004CH to 007EH	Used for various monitors U1-□□, U4-□□, U5-□□ and U6-□□. <i>Refer to U: Monitors on page 399</i> for parameter details.	
007FH	Alarm Code, <i>Refer to Alarm Register Contents on page 458</i> for alarm codes.	
0080H to 0097H	Used for monitors U2-□□, U3-□□. <i>Refer to U: Monitors on page 399</i> for parameter details and <i>Refer to Fault Trace Contents on page 457</i> for register value descriptions.	
0098H, 0099H	U4-01 (Cumulative Operation Time) Example: When U4-01 (Cumulative Operation Time) is 12345 hours, then 0098H = 1234 and 0099H = 5.	
009AH, 009BH	U4-03 (Cooling Fan Operation Time) Example: When U4-03 (Cooling Fan Operation Time) is 12345 hours, then 009AH = 1234 and 009BH = 5.	
00ABH	Drive Rated Current <↔>	
00ACH	Motor Speed (Open Loop	r/min units <↔>
00ADH	Vector only)	0.01% units
00AEH, 00AFH	Reserved	
00B0H	Option Code	The following lists the 3 and 4 letter ASCII codes stored for each serial communication option: CANopen (Model: SI-S3/V): 5353H CC-Link (Model: SI-C3/V): 5343H DeviceNet (Model: SI-N3/V): 534EH PROFIBUS-DP (Model: SI-P3/V): 5350H MECHATROLINK-II (Model: SI-T3/V): 5354H MECHATROLINK-III (Model: SI-ET3/V): 1004H CompoNet (Model: SI-M3/V): 434EH Other options use their own unique codes. Refer to the communication option instruction manual for the option code.
00B1H to 00B4H	Reserved	
00B5H	Frequency Reference After	r/min units <↔>
00B6H	Soft-starter	0.01% units
00B7H	Frequency Reference	r/min <↔>
00B8H		0.01% units
00BFH	oPE Error Number	

Register No.	Contents	
00C0H	Fault contents 3	
	bit 0	Reserved
	bit 1	Undervoltage (Uv1)
	bit 2	Control Power Supply Undervoltage (Uv2)
	bit 3	Soft Charge Circuit Fault (Uv3)
	bit 4	IGBT Short Circuit or Ground Fault (SC)
	bit 5	Ground Fault (GF)
	bit 6	Overcurrent (oC)
	bit 7	Overvoltage (ov)
	bit 8	Heatsink Overheat (oH)
	bit 9	Heatsink Overheat (oH1)
	bit A	Motor Overload (oL1)
	bit B	Drive Overload (oL2)
	bit C	Overtorque Detection 1 (oL3)
	bit D	Overtorque Detection 2 (oL4)
	bit E	Dynamic Braking Transistor Fault (rr)
bit F	Braking Resistor Overheat (rH)	
00C1H	Fault contents 4	
	bit 0	External Fault at input terminal S3 (EF3)
	bit 1	External Fault at input terminal S4 (EF4)
	bit 2	External Fault at input terminal S5 (EF5)
	bit 3	External Fault at input terminal S6 (EF6)
	bit 4	External Fault at input terminal S7 (EF7)
	bit 5 to 6	Reserved
	bit 7	Overspeed (oS)
	bit 8	Excessive Speed Deviation (dEv)
	bit 9	PG Disconnected (PGo)
	bit A	Input Phase Loss (PF)
	bit B	Output Phase Loss (LF)
	bit C	Motor Overheat Alarm (PTC input) (oH3)
	bit D	Digital Operator Connection Fault (oPr)
	bit E	EEPROM Write Error (Err)
	bit F	Motor Overheat Fault (PTC input) (oH4)
00C2H	Fault contents 5	
	bit 0	MEMOBUS/Modbus Communication Error (CE)
	bit 1	Option Communication Error (bUS)
	bit 2 to 3	Reserved
	bit 4	Control Fault (CF)
	bit 5	Reserved
	bit 6	Option External Fault (EF0)
	bit 7	PID Feedback Loss (FbL)
	bit 8	Undertorque Detection 1 (UL3)
	bit 9	Undertorque Detection 2 (UL4)
	bit A	High Slip Braking Overload (oL7)
	bit B to E	Reserved
	bit F	Hardware fault (includes oFA□□)

C.10 MEMOBUS/Modbus Data Table

Register No.	Contents	
00C3H	Fault contents 6	
	bit 0 to 4	Reserved
	bit 5	Output Current Imbalance (LF2)
	bit 6	Pullout Detection (STo)
	bit 7	PG Disconnected (PGo)
	bit 8	MECHATROLINK Watchdog Timer Error (E5)
	bit 9	Reserved
	bit A	Too many speed search restarts (SEr)
	bit B to F	Reserved
00C4H	Fault contents 7	
	bit 0	PID Feedback Loss (FbH)
	bit 1	External Fault 1, input terminal S1 (EF1)
	bit 2	External Fault 2, input terminal S2 (EF2)
	bit 3	Mechanical Weakening Detection 1 (oL5)
	bit 4	Mechanical Weakening Detection 2 (UL5)
	bit 5	Current Offset Fault (CoF)
	bit 6	Reserved
	bit 7	Reserved
	bit 8	DriveWorksEZ fault (dWFL)
	bit 9 to F	Reserved
00C8H	Alarm contents 2	
	bit 0	Undervoltage (Uv)
	bit 1	Overvoltage (ov)
	bit 2	Heatsink Overheat (oH)
	bit 3	Drive Overheat (oH2)
	bit 4	Overtorque 1 (oL3)
	bit 5	Overtorque 2 (oL4)
	bit 6	Run Commands Input Error (EF)
	bit 7	Drive Baseblock (bb)
	bit 8	External Fault 3, input terminal S3 (EF3)
	bit 9	External Fault 4, input terminal S4 (EF4)
	bit A	External Fault 5, input terminal S5 (EF5)
	bit B	External Fault 6, input terminal S6 (EF6)
	bit C	External Fault 7, input terminal S7 (EF7)
	bit D, E	Reserved
	bit F	Overspeed (oS)

Register No.	Contents	
00C9H	Alarm contents 3	
	bit 0	Excessive Speed Deviation (dEv)
	bit 1	PG Disconnected (PGo)
	bit 2	Digital Operator Connection Fault (oPr)
	bit 3	MEMOBUS/Modbus Communication Error (CE)
	bit 4	Option Communication Error (bUS)
	bit 5	Serial Communication Transmission Error (CALL)
	bit 6	Motor Overload (oL1)
	bit 7	Drive Overload (oL2)
	bit 8	Reserved
	bit 9	Option Card External fault (EF0)
	bit A	Motor 2 Switch command input during run (rUn)
	bit B	Reserved
	bit C	Serial Communication Transmission Error (CALL)
	bit D	Undertorque Detection 1 (UL3)
	bit E	Undertorque Detection 2 (UL4)
bit F	MEMOBUS/Modbus Test Mode Fault (SE)	
00CAH	Alarm contents 4	
	bit 0	Reserved
	bit 1	Motor Overheat 1 (PTC Input) (oH3)
	bit 2 to 5	Reserved
	bit 6	PID Feedback Loss (FbL)
	bit 7	PID Feedback Loss (FbH)
	bit 9	Drive Disabled (dnE)
bit A to F	Reserved	
00CBH	Alarm contents 5	
	bit 0	MECHATROLINK Watchdog Timer Error (E5)
	bit 1	Reserved
	bit 2	MECHATROLINK Comm. Cycle Setting Error (CyC)
	bit 3	High Current Alarm (HCA)
	bit 4	Cooling Fan Maintenance Time (LT-1)
	bit 5	Soft Charge Bypass Relay Maintenance Time (LT-2)
	bit 6	Reserved
	bit 7	SI-S/V EEPROM Error (EEP)
	bit 8	External Fault 1 (input terminal S1) (EF1)
	bit 9	External Fault 2 (input terminal S2) (EF2)
	bit A	Safe Disable Input (HbbF)
	bit B	Safe Disable Input (Hbb)
	bit C	Mechanical Weakening Detection 1 (oL5)
	bit D	Mechanical Weakening Detection 2 (UL5)
bit E to F	Reserved	

C.10 MEMOBUS/Modbus Data Table

Register No.	Contents	
00D0H	CPF Contents 1	
	bit 0 to 1	Reserved
	bit 2	A/D Conversion Error (CPF02)
	bit 3	PWM Data Fault (CPF03)
	bit 4 to 5	Reserved
	bit 6	Drive specification mismatch during Terminal Board or Control Board replacement (CPF06)
	bit 7	Terminal Board Communications Fault (CPF07)
	bit 8	EEPROM Serial Communications Fault (CPF08)
	bit 9 to A	Reserved
	bit B	RAM Fault (CPF11)
	bit C	FLASH Memory Fault (CPF12)
	bit D	Watchdog Circuit Exception (CPF13)
	bit E	Control Circuit Fault (CPF14)
	bit F	Reserved
00D1H	CPF Contents 2	
	bit 0	Clock Fault (CPF16)
	bit 1	Timing Fault (CPF17)
	bit 2	Control Circuit Fault (CPF18)
	bit 3	Control Circuit Fault (CPF19)
	bit 4	Hardware fault at power up (CPF20)
	bit 5	Hardware fault at communication start up (CPF21)
	bit 6	A/D Conversion Fault (CPF22)
	bit 7	PWM Feedback Fault (CPF23)
	bit 8	Drive capacity signal fault (CPF24)
	bit 9	Terminal board is not properly connected (CPF25)
bit A to F	Reserved	
00D8H	Option Card Fault Contents	
	bit 0	Option Compatibility Error (oFA00)
	bit 1	Option not properly connected (oFA01)
	bit 3	Option Self-diagnostics Error (oFA03)
	bit 4	Option Flash Write Mode Error (oFA04)
	bit 5 to F	Reserved
00FBH	Output Current <2>	

<1> Units are determined by parameter o1-03.

<2> Display is in the following units: BA0001 to BA0018, 2A0001 to 2A0040, and 4A0001 to 4A0023: 0.01 A units.
2A0056 to 2A0069, 4A0031 to 4A0038: 0.1 A units.

<3> The communication error log is stored until the fault is reset.

<4> Depending on the motor used the correct motor pole number must be set to parameter E2-04, E4-04 or E5-05.

<5> Available in drive software versions PRG: 1011 and later.

◆ Broadcast Messages

Data can be written from the master to all slave devices at the same time.

The slave address in a broadcast command message must be set to 00H. All slaves will receive the message, but will not respond.

Register No.	Contents	
0001H	Digital Input Command	
	bit 0	Forward Run (0: Stop 1: Run)
	bit 1	Direction Command (0: Forward, 1: Reverse)
	bit 2, 3	Reserved
	bit 4	External Fault
	bit 5	Fault Reset
	bit 6 to B	Reserved
	bit C	Multi-Function Digital Input S5 (enabled when bit C of register 000FH is on)
	bit D	Multi-Function Digital Input S6 (enabled when bit D of register 000FH is on)
	bit E	Multi-Function Digital Input S7 (enabled when bit E of register 000FH is on)
bit F	Reserved	
0002H	Frequency Reference	30000/100%

◆ Fault Trace Contents

The table below shows the fault codes that can be read out by MEMOBUS/Modbus commands from the U2-□□ monitor parameters.

Note: Uv1 and Uv2 faults are not saved to the fault history.

Table C.4 Fault Trace / History Register Contents

Fault Code	Fault Name	Fault Code	Fault Name
0002H	Undervoltage (Uv1)	001DH	Motor Overheat (PTC input) (oH3)
0003H	Control Power Supply Undervoltage (Uv2)	001EH	Digital Operator Connection (oPr)
0004H	Soft Charge Circuit Fault (Uv3)	001FH	EEPROM Write Error (Err)
0005H <->	IGBT Short Circuit (SC)	0020H	Motor Overheat (PTC input) (oH4)
0006H	Ground Fault (GF)	0021H	MEMOBUS/Modbus Communication Error (CE)
0007H	Overcurrent (oC)	0022H	Option Communication Error (bUS)
0008H	Overvoltage (ov)	0025H	Control fault (CF)
0009H	Heatsink Overheat (oH)	0027H	PROFIBUS-DP Option External Fault (EF0)
000AH	Heatsink Overheat (oH1)	0028H	PID Feedback Loss (FbL)
000BH	Motor Overload (oL1)	0029H	Undertorque Detection 1 (UL3)
000CH	Drive Overload (oL2)	002AH	Undertorque Detection 2 (UL4)
000DH	Overtorque Detection 1 (oL3)	002BH	High Slip Braking Overload (oL7)
000EH	Overtorque Detection 2 (oL4)	0030H	Hardware Fault (including oFx)
000FH	Dynamic Braking Transistor (rr)	0036H	Output Current Imbalance (LF2)
0010H	Braking Resistor Overheat (rH)	0037H	Pullout Detection (Sto)
0011H	External Fault at input terminal S3 (EF3)	0038H	PG Disconnected (PGo)
0012H	External Fault at input terminal S4 (EF4)	0039H	MECHATROLINK Watchdog Timer Error (E5)
0013H	External Fault at input terminal S5 (EF5)	003BH	Too many speed search restarts (SEr)
0014H	External Fault at input terminal S6 (EF6)	0041H	PID Feedback Loss (FbH)
0015H	External Fault at input terminal S7 (EF7)	0042H	External Fault 1, input terminal S1 (EF1)
0018H	Overspeed (oS)	0043H	External Fault 2, input terminal S2 (EF2)
0019H	Excessive Speed Deviation (dEv)	0044H	Mechanical Weakening Detection 1 (oL5)
001AH	PG Disconnect (PGo)	0045H	Mechanical Weakening Detection 2 (UL5)
001BH	Input Phase Loss (PF)	0046H	Current Offset Fault (CoF)
001CH	Output Phase Loss (LF)	0049H	DriveWorksEZ Fault (dWFL)
		0083H	A/D Conversion Error (CPF02)

C.10 MEMOBUS/Modbus Data Table

Fault Code	Fault Name
0084H	PWM Data Fault (CPF03)
0087H	Drive specification mismatch during Terminal Board or Control Board replacement (CPF06)
0088H	Terminal Board Communication Fault (CPF07)
0089H	EEPROM Serial Communication Fault (CPF08)
008CH	RAM fault (CPF11)
008DH	Flash memory circuit exception (CPF12)
008EH	Watchdog circuit exception (CPF13)
008FH	Control Circuit Fault (CPF14)
0091H	Clock Fault (CPF16)
0092H	Timing Fault (CPF17)
0093H	Control Circuit Fault (CPF18)

Fault Code	Fault Name
0094H	Control Circuit Fault (CPF19)
0095H	Hardware fault at power up (CPF20)
0096H	Hardware fault at communication start up (CPF21)
0097H	A/D Conversion Fault (CPF22)
0098H	PWM Feedback Fault (CPF23)
0099H	Drive capacity signal fault (CPF24)
0101H	Option compatibility error (oFA00)
0102H	Option not properly connected (oFA01)
0104H	Option Self-diagnostics Error (oFA03)
0105H	Option Flash Write Mode Error (oFA04)

<1> Available in drive software versions PRG: 1020 and later.

◆ Alarm Register Contents

The table below shows the alarm codes that can be read out from MEMOBUS/Modbus register 007FH.

Table C.5 Alarm Register 007FH Contents

Alarm Code	Fault Name
0001H	Undervoltage (Uv)
0002H	Overvoltage (ov)
0003H	Heatsink Overheat (oH)
0004H	Drive Overheat (oH2)
0005H	Overtorque 1 (oL3)
0006H	Overtorque 2 (oL4)
0007H	Run commands input error (EF)
0008H	Drive Baseblock (bb)
0009H	External Fault 3, input terminal S3 (EF3)
000AH	External Fault 4, input terminal S4 (EF4)
000BH	External Fault 5, input terminal S5 (EF5)
000CH	External Fault 6, input terminal S6 (EF6)
000DH	External Fault 7, input terminal S7 (EF7)
000FH	Reserved
0010H	Overspeed (oS)
0011H	Excessive Speed Deviation (dEv)
0012H	PG Disconnected (PGo)
0013H	Digital operator connection fault (oPr)
0014H	MEMOBUS/Modbus Communication Error (CE)
0015H	Option Communication Error (bUS)
0016H	Serial Communication Transmission Error (CALL)
0017H	Motor Overload (oL1)
0018H	Drive Overload (oL2)

Alarm Code	Fault Name
001AH	Option Card External Fault (EF0)
001BH	Motor Switch command input during run (rUn)
001DH	Serial Communication Transmission Error (CALL)
001EH	Undertorque Detection 1 (UL3)
001FH	Undertorque Detection 2 (UL4)
0020H	MEMOBUS/Modbus Test Mode Fault (SE)
0022H	Motor Overheat (oH3)
0027H	PID Feedback Loss (FbL)
0028H	PID Feedback Loss (FbH)
002AH	Drive Disabled (dnE)
002BH	PG Disconnected (PGo)
0031H	MECHATROLINK Watchdog Timer Error (E5)
0032H	Station Address Setting Error (AEr)
0033H	MECHATROLINK Comm. Cycle Setting Error (CyC)
0034H	High Current Alarm (HCA)
0039H	External Fault (input terminal S1) (EF1)
003AH	External Fault (input terminal S2) (EF2)
003BH	Safe Disable Input (HbbF)
003CH	Safe Disable Input (Hbb)
003DH	Mechanical Weakening Detection 1 (oL5)
003EH	Mechanical Weakening Detection 2 (UL5)
0049H	DriveWorksEZ Alarm (dWAL)

C.11 Enter Command

When writing parameters to the drive from the PLC using MEMOBUS/Modbus communication it depends on the setting of parameter H5-11 if an Enter command must be used to enable these parameters or not. This sections explains Enter commands.

◆ Enter Command Types

The drive supports two types of Enter commands as shown in [Table C.6](#). An Enter command is enabled by writing 0 to register number 0900H or 0910H. These registers can be written to only. An error will occur if the user attempts to read from these registers.

Table C.6 Enter Command Types

Register No.	Description
0900H	Writes data into the EEPROM (non-volatile memory) of the drive and enables the data in RAM at the same time. Parameter changes remain even if the power supply is cycled.
0910H	Writes data in the RAM only. Parameter changes are lost when the drive is shut off.

- Note:**
1. Because the EEPROM can be written to a maximum of 100,000 times, refrain from writing to the EEPROM too often. The Enter command registers are write-only. Consequently, if these registers are read, then the register address will be invalid (Error code: 02H). An Enter command is not required if reference or broadcast data are sent to the drive.
 2. Parameter data cannot be written to EEPROM during undervoltage, even using 0900H.
 3. If **undervoltage occurs** when a making **several parameter changes issued with a single ENTER command**, the writing process may be aborted before all of the new changes have been written. Because all of the data has not yet been written, the EEPROM data error “CPF06” will be displayed the next time power to the drive is cycled. To prevent this problem, wait approximately 5 seconds after issuing the ENTER command before shutting off drive power.

◆ Enter Command Settings when Upgrading the Drive

When replacing earlier Yaskawa drive models with a V1000 and keeping the MEMOBUS/Modbus communications settings, parameter H5-11 needs to be set in accordance with how the Enter command functions in the older drive. H5-11 determines if an Enter command is needed to activate parameter changes in the drive.

- Set H5-11 to 0 when upgrading from a G7 or F7 series drive to V1000 series drive.
- Set H5-11 to 1 when upgrading from a V7 series drive to V1000 series drive.

■ H5-11 and the Enter Command

H5-11 Settings	H5-11 = 0	H5-11 = 1
Drive being replaced	G7, F7	V7
How parameter settings are enabled	When the Enter command is received from the master.	As soon as the value is changed.
Upper/lower limit check	Upper/lower limit check takes the settings of related parameters into account.	The upper/lower limit of the changed parameter is checked only.
Default value of related parameters	Not affected. The settings of related parameters remain unchanged. They must be changed manually if needed.	The default settings of related parameters are changed automatically.
Error handling when setting multiple parameters	Data is accepted even if one setting is invalid. The invalid setting will be discarded. No error message occurs.	Error occurs if only one setting is invalid. All data sent are discarded.

C.12 Communication Errors

◆ MEMOBUS/Modbus Error Codes

A list of MEMOBUS/Modbus errors appears below.

When an error occurs, remove whatever caused the error and restart communications.

Error Code	Error Name
	Cause
01H	Function Code Error
	<ul style="list-style-type: none"> Attempted to set a function code from a PLC other than 03H, 08H, and 10H.
02H	Register Number Error
	<ul style="list-style-type: none"> A register number specified in the command message does not exist. Attempted to send a broadcast message using other register numbers than 0001H or 0002H.
03H	Bit Count Error
	<ul style="list-style-type: none"> Read data or write data is greater than 16 bits. Invalid command message quantity. In a write message, the “Number of Data Items” contained within the message does not equal twice the amount of data words (i.e., the total of Data 1+ Data 2, etc.).
21H	Data Setting Error
	<ul style="list-style-type: none"> Control data or parameter write data is outside the allowable setting range. Attempted to write a contradictory parameter setting.
22H	Write Mode Error
	<ul style="list-style-type: none"> Attempted to write while the drive was operating to a parameter that cannot be written to during run. During an EEPROM data error (CPF06), the master attempted to write to a parameter other than A1-00 to -05, E1-03, or o2-04. Attempted to write to read-only data.
23H	DC Bus Undervoltage Write Error
	<ul style="list-style-type: none"> Attempted to write from the master during an undervoltage fault (Uv1). Attempted to execute and Enter command during Uv1.
24H	Write Error During Parameter Process
	<ul style="list-style-type: none"> Master attempted writing to the drive while the drive was processing parameter data.

◆ Slave Not Responding

In the following situations, the slave drive will ignore the command message sent from the master, and not send a response message:

- When a communications error (overrun, framing, parity or CRC-16) is detected in the command message.
- When the slave address in the command message and the slave address in the drive do not match (remember to set the slave address for the drive using H5-01).
- When the gap between two blocks (8 bit) of a message exceeds 24 bits.
- When the command message data length is invalid.

Note: If the slave address specified in the command message is 00H, all slaves execute the write function, but do not return response messages to the master.

C.13 Self-Diagnostics

The drive has a built-in self-diagnosing function of the serial communication interface circuits. To perform the self-diagnosis function, use the following procedure.

DANGER! Electrical Shock Hazard. Do not connect or disconnect wiring while the power is on. Failure to comply will result in death or serious injury. Before servicing, disconnect all power to the equipment. The internal capacitor remains charged even after the power supply is turned off. The charge indicator LED will extinguish when the DC bus voltage is below 50 Vdc. To prevent electric shock, wait at least one minute after all indicators are OFF and measure the DC bus voltage level to confirm safe level.

1. Turn on the power to the drive.
2. Note the present terminal S6 function selection setting (H1-06) and set it for the communications test mode (H1-06 = 67).
3. Turn off the power to the drive.
4. With the power off, wire the drive as shown in the following figure:

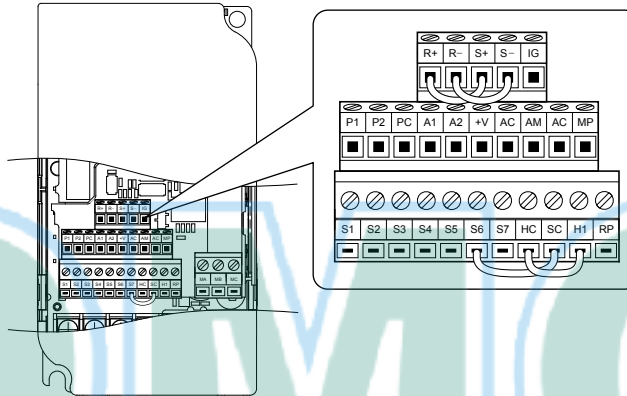
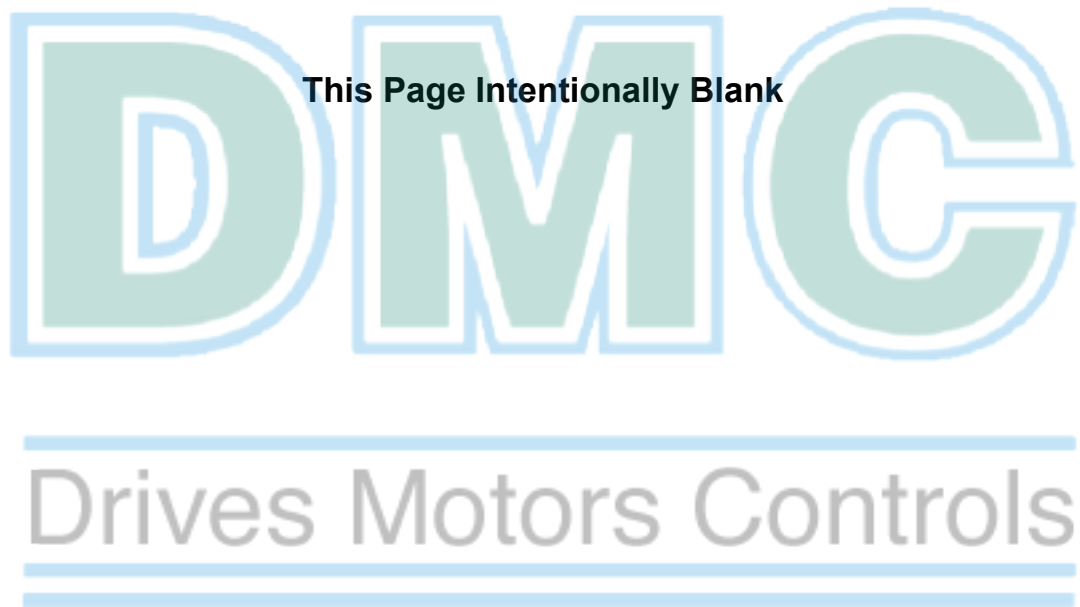

Figure C.9 Terminal Connections for Communication Self-Diagnostics

5. Check and note the setting of DIP switch S3. Set it to NPN if it is in the PNP position.
6. Turn the power to the drive back on.
7. During normal operation, the drive will display PASS. This indicates that the communications test mode is operating normally.

When a fault occurs, the drive will display “CE” on the keypad display.

8. Turn off the power supply.
9. Remove the wire jumpers from terminal R+, R-, S+, S- and, S6-SC and set back DIP switch S3 to its original position. Set terminal S6 to its original function.
10. Return to normal operation.



Appendix: D

Standards Compliance

This appendix explains the guidelines and criteria for maintaining CE and UL standards.

D.1 SECTION SAFETY.....	464
D.2 EUROPEAN STANDARDS.....	466
D.3 UL AND CSA STANDARDS.....	474
D.4 SAFE DISABLE INPUT.....	481



Drives Motors Controls

D.1 Section Safety

DANGER

Electrical Shock Hazard

Do not connect or disconnect wiring while the power is on.

Failure to comply will result in death or serious injury.

WARNING

Electrical Shock Hazard

Do not operate equipment with covers removed.

Failure to comply could result in death or serious injury.

The diagrams in this section may show drives without covers or safety shields to show details. Be sure to reinstall covers or shields before operating the drives and run the drives according to the instructions described in this manual.

Always ground the motor-side grounding terminal.

Improper equipment grounding could result in death or serious injury by contacting the motor case.

Do not touch any terminals before the capacitors have fully discharged.

Failure to comply could result in death or serious injury.

Before wiring terminals, disconnect all power to the equipment. The internal capacitor remains charged even after the power supply is turned off. The charge indicator LED will extinguish when the DC bus voltage is below 50 Vdc. To prevent electric shock, wait at least five minutes after all indicators are off and measure the DC bus voltage level to confirm safe level.

Do not allow unqualified personnel to perform work on the drive.

Failure to comply could result in death or serious injury.

Installation, maintenance, inspection, and servicing must be performed only by authorized personnel familiar with installation, adjustment and maintenance of AC drives.

Do not perform work on the drive while wearing loose clothing, jewelry or without eye protection.

Failure to comply could result in death or serious injury.

Remove all metal objects such as watches and rings, secure loose clothing, and wear eye protection before beginning work on the drive.

Do not remove covers or touch circuit boards while the power is on.

Failure to comply could result in death or serious injury.

Fire Hazard

Tighten all terminal screws to the specified tightening torque.

Loose electrical connections could result in death or serious injury by fire due to overheating of electrical connections.

Do not use an improper voltage source.

Failure to comply could result in death or serious injury by fire.

Verify that the rated voltage of the drive matches the voltage of the incoming power supply before applying power.

Do not use improper combustible materials.

Failure to comply could result in death or serious injury by fire.

Attach the drive to metal or other noncombustible material.

Install adequate branch circuit protection according to applicable local codes and this manual.

Failure to comply could result in fire and damage to the drive or injury to personnel. The device is suitable for use on a circuit capable of delivering not more than 31,000 RMS symmetrical amperes, 240 Vac maximum (200 V class) and 480 Vac maximum (400 V class) when protected by branch circuit protection devices specified in this manual.

NOTICE

Observe proper electrostatic discharge procedures (ESD) when handling the drive and circuit boards.

Failure to comply may result in ESD damage to the drive circuitry.

Never connect or disconnect the motor from the drive while the drive is outputting voltage.

Improper equipment sequencing could result in damage to the drive.

Do not use unshielded cable for control wiring.

Failure to comply may cause electrical interference resulting in poor system performance. Use shielded twisted-pair wires and ground the shield to the ground terminal of the drive.

Do not allow unqualified personnel to use the product.

Failure to comply could result in damage to the drive or braking circuit.

Carefully review instruction manual TOBPC72060000 when connecting a braking option to the drive.

Do not modify the drive circuitry.

Failure to comply could result in damage to the drive and will void warranty.

Yaskawa is not responsible for modification of the product made by the user. This product must not be modified.

Check all the wiring to ensure that all connections are correct after installing the drive and connecting other devices.

Failure to comply could result in damage to the drive.

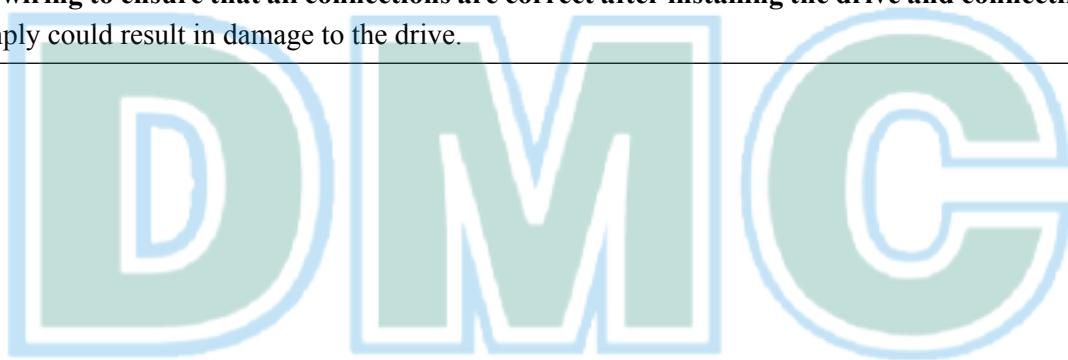
The logo for DMC (Drives Motors Controls) features the letters 'D', 'M', and 'C' in a large, bold, light blue font with a white outline. The letters are spaced out and centered horizontally.The tagline 'Drives Motors Controls' is written in a light blue, sans-serif font. It is positioned below the 'DMC' logo and is flanked by two horizontal light blue lines, one above and one below the text.

D.2 European Standards



Figure D.1 CE Mark

The CE mark indicates compliance with European safety and environmental regulations and is required for engaging in business and commerce in Europe.

European standards include the Machinery Directive for machine manufacturers, the Low Voltage Directive for electronics manufacturers and the EMC guidelines for controlling noise.

This drive displays the CE mark based on the EMC guidelines and the Low Voltage Directive.

- Devices used in combination with this drive must also be CE certified and display the CE mark. When using drives displaying the CE mark in combination with other devices, it is ultimately the responsibility of the user to ensure compliance with CE standards. After setting up the device, verify that conditions meet European standards.
- **Low Voltage Directive:** 73/23/EEC, 93/68/EEC

◆ CE Low Voltage Directive Compliance

This drive has been tested according to European standard IEC/EN 61800-5-1, and it fully complies with the Low Voltage Directive.

To comply with the Low Voltage Directive, be sure to meet the following conditions when combining this drive with other devices:

■ Area of Use

Do not use drives in areas with pollution higher than severity 2 and overvoltage category 3 in accordance with IEC/EN 664.

■ Factory Recommended Branch Circuit Protection

Yaskawa recommends installing one of the following types of branch circuit protection to maintain compliance with UL508C. Semiconductor protective type fuses are preferred. Alternate branch circuit protection devices are also listed in [Table D.1](#).

NOTICE: If a fuse is blown or a Ground Fault Circuit Interrupter (GFCI) is tripped, check the wiring and the selection of peripheral devices to identify the cause. Contact Yaskawa before restarting the drive or the peripheral devices if the cause cannot be identified.

Table D.1 Factory Recommended Drive Branch Circuit Protection

Drive Model	Fuse Type	
	Manufacturer: Bussmann	
	Model	Fuse Ampere Rating (A)
Single-Phase 200 V Class		
BA0001	FWH-25A14F	25
BA0002	FWH-25A14F	25
BA0003	FWH-60B	60
BA0006	FWH-80B	80
BA0010	FWH-100B	100
BA0012	FWH-125B	125
BA0018	FWH-175B	175
Three-Phase 200 V Class		
2A0001	FWH-25A14F	25
2A0002	FWH-25A14F	25
2A0004	FWH-25A14F	25
2A0006	FWH-25A14F	25
2A0010	FWH-70B	70
2A0012	FWH-70B	70
2A0020	FWH-90B	90
2A0030	FWH-100B	100

Drive Model	Fuse Type	
	Manufacturer: Bussmann	
	Model	Fuse Ampere Rating (A)
2A0040	FWH-200B	200
2A0056	FWH-200B	200
2A0069	FWH-200B	200
Three-Phase 400 V Class		
4A0001	FWH-40B	40
4A0002	FWH-40B	40
4A0004	FWH-50B	50
4A0005	FWH-70B	70
4A0007	FWH-70B	70
4A0009	FWH-90B	90
4A0011	FWH-90B	90
4A0018	FWH-80B	80
4A0023	FWH-100B	100
4A0031	FWH-125B	125
4A0038	FWH-200B	200

■ **Grounding**

The drive is designed to be used in T-N (grounded neutral point) networks. If installing the drive in other types of grounded systems, contact your dealer or Yaskawa for instructions.

■ **CE Standards Compliance for DC Power Supply Input**

Install the fuses in the following tables to meet CE standards.

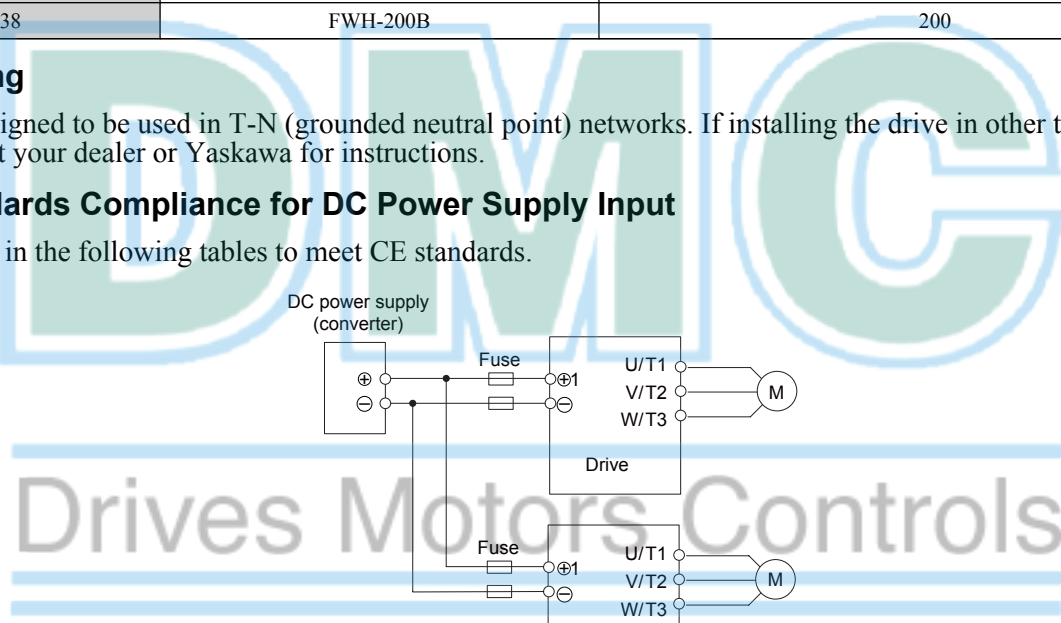

Figure D.2 Example of DC Power Supply Input (Two Drives Connected in Series)

- Note:**
1. When connecting multiple drives together, make sure that each drive has its own fuse. Replace all fuses when one fuse blows.
 2. Refer to on page 50 for an AC power supply.
 3. The recommended fuses and fuse holders are made by Fuji Electric.

D.2 European Standards

Table D.2 Single-Phase 200 V Class Fuses and Fuse Holders

Drive Model	DC Power Supply Input				
	Fuse			Fuse Holder	
	Manufacturer: Fuji Electric				
	Type	Rated Short Circuit Braking Current (kA)	Qty.	Type	Qty.
BA0001	CR6L-20/UL	100	2	CMS-4	2
BA0002	CR6L-30/UL			CMS-4	
BA0003	CR6L-50/UL			CMS-4	
BA0006	CR6L-75/UL			CMS-5	
BA0010	CR6L-100/UL			CMS-5	
BA0012	CR6L-100/UL			CMS-5	
BA0018	CR6L-150/UL			CMS-5	

Table D.3 Three-Phase 200 V Class Fuses and Fuse Holders

Drive Model	DC Power Supply Input					
	Fuse			Fuse Holder		
	Manufacturer: Fuji Electric					
	Type	Rated Short Circuit Braking Current (kA)	Qty.	Type	Qty.	
2A0001	CR6L-20/UL	100	2	CMS-4	2	
2A0002	CR6L-20/UL			CMS-4		
2A0004	CR6L-20/UL			CMS-4		
2A0006	CR6L-30/UL			CMS-4		
2A0010	CR6L-50/UL			CMS-4		
2A0012	CR6L-50/UL			CMS-4		
2A0020	CR6L-75/UL			CMS-5		
2A0030	CR6L-100/UL			CMS-5		
2A0040	CR6L-150/UL			CMS-5		
2A0056	CR6L-150/UL			CMS-5		
2A0069	CR6L-200/UL			<1>		-

<1> Manufacturer does not recommend a specific fuse holder for this fuse. Contact Yaskawa or your nearest sales representative for fuse dimensions.

Table D.4 Three-Phase 400 V Class Fuses and Fuse Holders

Drive Model	DC Power Supply Input				
	Fuse			Fuse Holder	
	Manufacturer: Fuji Electric				
	Type	Rated Short Circuit Braking Current (kA)	Qty.	Type	Qty.
4A0001	CR6L-20/UL	100	2	CMS-4	2
4A0002	CR6L-20/UL			CMS-4	
4A0004	CR6L-50/UL			CMS-4	
4A0005	CR6L-50/UL			CMS-4	
4A0007	CR6L-50/UL			CMS-4	
4A0009	CR6L-50/UL			CMS-4	
4A0011	CR6L-50/UL			CMS-4	
4A0018	CR6L-50/UL			CMS-4	
4A0023	CR6L-75/UL			CMS-5	
4A0031	CR6L-100/UL			CMS-5	
4A0038	CR6L-150/UL			CMS-5	

■ Guarding Against Harmful Materials

When installing IP20/Open-Chassis enclosure drives, use an enclosure that prevents foreign material from entering the drive from above or below.

◆ EMC Guidelines Compliance

This drive is tested according to European standards EN 61800-3:2004/A1:2012 and it complies with the EMC guidelines.

■ EMC Filter Installation

The following conditions must be met to ensure continued compliance with guidelines. *Refer to EMC Filters on page 471* for EMC filter selection.

Installation Method

Verify the following installation conditions to ensure that other devices and machinery used in combination with this drive also comply with EMC guidelines.

1. Install an EMC noise filter to the input side specified by Yaskawa for compliance with European standards.
2. Place the drive and EMC noise filter in the same enclosure.
3. Use braided shield cable for the drive and motor wiring or run the wiring through a metal conduit.
4. Keep wiring as short as possible. Ground the shield on both the drive side and the motor side.

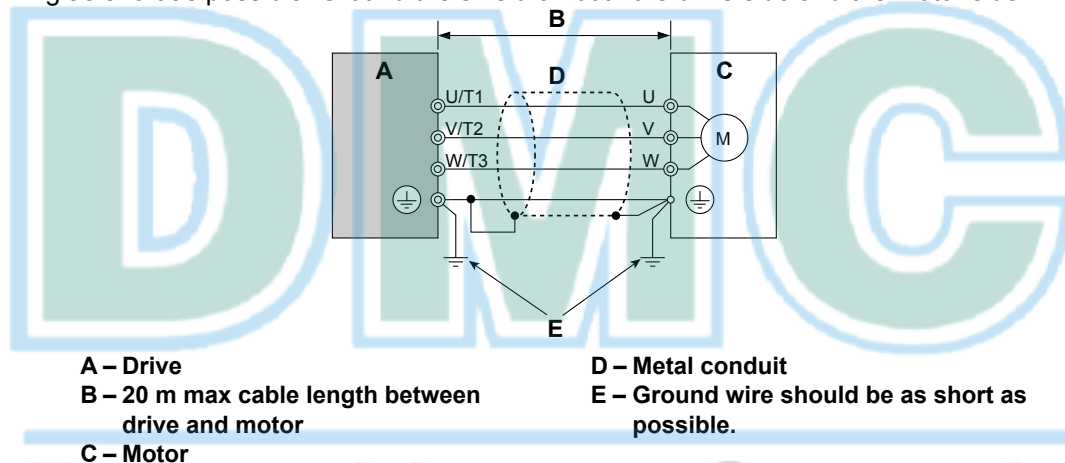

Figure D.3 Installation Method

5. Ground the largest possible surface area of the shield to the metal conduit when using braided shield cable. Yaskawa recommends using a cable clamp.

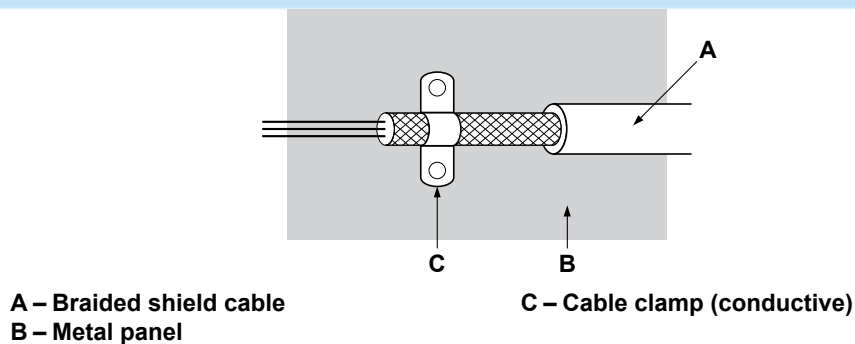

Figure D.4 Ground Area

Three-Phase 200 V / 400 V Class

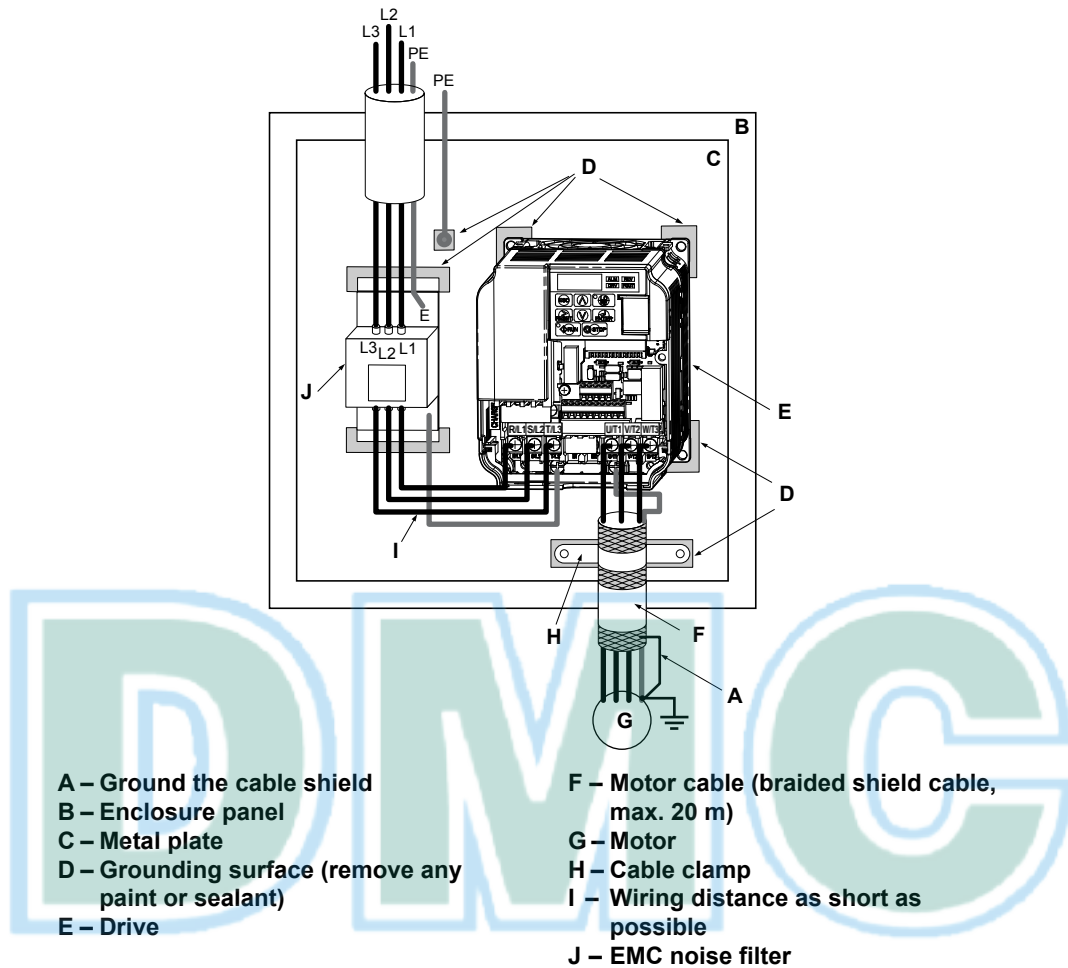

Figure D.5 EMC Filter and Drive Installation for CE Compliance
(Three-Phase 200 V / 400 V Class)

Drives Motors Controls

Single-Phase 200 V Class

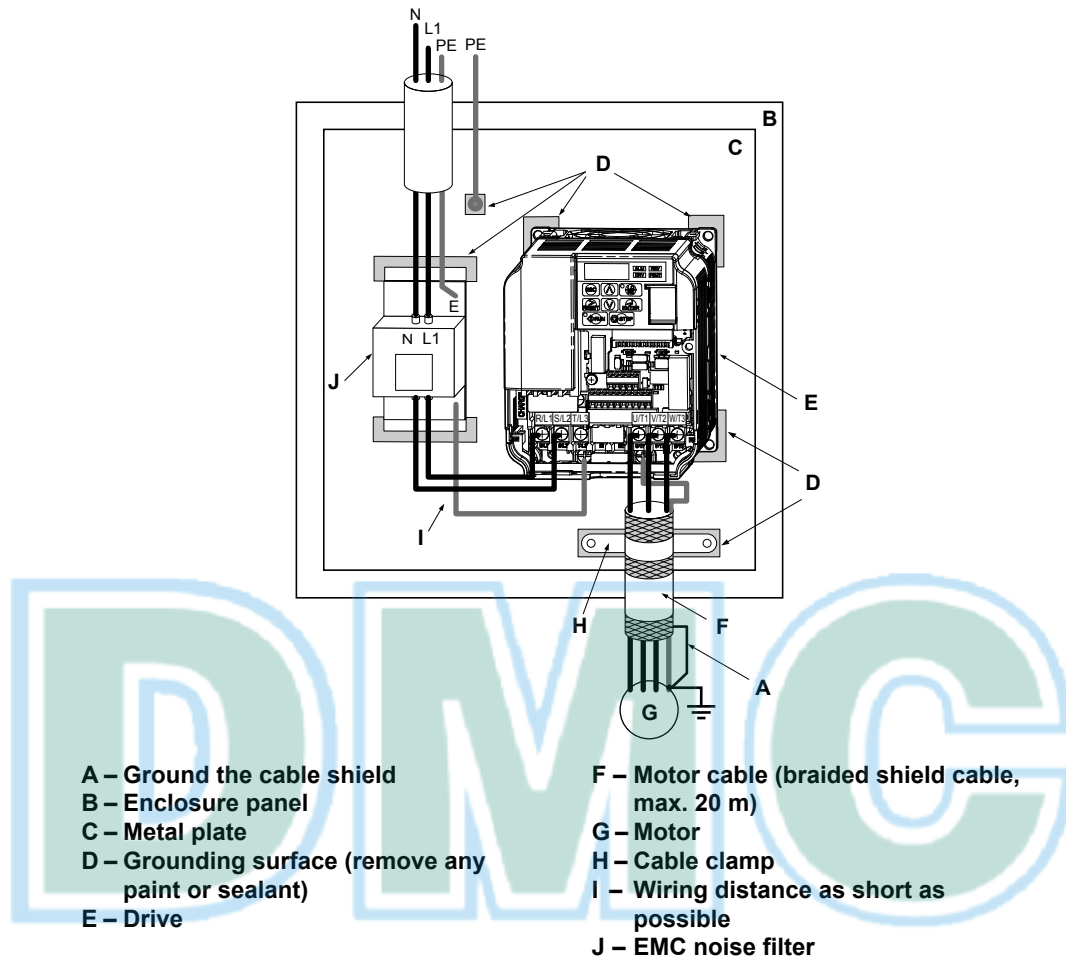

Figure D.6 EMC Filter and Drive Installation for CE Compliance (Single-Phase 200 V Class)

■ EMC Filters

The drive should be installed with the EMC filters listed below in order to comply with the EN 61800-3:2004/A1:2012, category C1 requirements.

Table D.5 EN 61800-3:2004/A1:2012 Category C1 Filters

Drive Model	Filter Data (Manufacturer: Schaffner)						
	Type	Rated Current (A)	Weight (lb)	Dimensions [W x L x H] (in)	Mounting Dimensions [Y x X] (in)	Drive Mounting Screw A	Filter Mounting Screw
200 V Class Single-Phase							
BA0001	FS23638-10-07	10	0.97	2.8 x 6.7 x 1.8	2.0 x 6.1	M4	M5
BA0002	FS23638-10-07	10	0.97	2.8 x 6.7 x 1.8	2.0 x 6.1	M4	M5
BA0003	FS23638-10-07	10	0.97	2.8 x 6.7 x 1.8	2.0 x 6.1	M4	M5
BA0006	FS23638-20-07	20	1.65	4.4 x 6.7 x 2.0	3.6 x 6.1	M4	M5
BA0010	FS23638-20-07	20	1.65	4.4 x 6.7 x 2.0	3.6 x 6.1	M4	M5
BA0012	FS23638-30-07	30	2.42	5.7 x 6.9 x 2.0	4.7 x 6.3	M4	M5
BA0018	FS23638-40-07	40	2.87	6.9 x 6.9 x 2.0	5.9 x 6.3	M4	M5
200 V Three-Phase							
2A0001	FS23637-8-07	7.3	0.88	2.8 x 6.7 x 1.6	2.0 x 6.1	M4	M5
2A0002	FS23637-8-07	7.3	0.88	2.8 x 6.7 x 1.6	2.0 x 6.1	M4	M5
2A0004	FS23637-8-07	7.3	0.88	2.8 x 6.7 x 1.6	2.0 x 6.1	M4	M5
2A0006	FS23637-8-07	7.3	0.88	2.8 x 6.7 x 1.6	2.0 x 6.1	M4	M5

D.2 European Standards

Drive Model	Filter Data (Manufacturer: Schaffner)						
	Type	Rated Current (A)	Weight (lb)	Dimensions [W x L x H] (in)	Mounting Dimensions [Y x X] (in)	Drive Mounting Screw A	Filter Mounting Screw
2A0010	FS23637-14-07	14	1.28	4.4 x 6.7 x 1.8	3.6 x 6.1	M4	M5
2A0012	FS23637-14-07	14	1.28	4.4 x 6.7 x 1.8	3.6 x 6.1	M4	M5
2A0020	FS23637-24-07	24	1.98	5.7 x 6.9 x 2.0	4.7 x 6.3	M4	M5
2A0030	FS23637-52-07	52	4.41	5.4 x 12.0 x 2.2	3.9 x 11.4	M5	M5
2A0040	FS23637-52-07	52	4.41	5.4 x 12.0 x 2.2	3.9 x 11.4	M5	M5
2A0056	FS23637-68-07	68	5.73	6.9 x 13.4 x 2.6	5.1 x 12.8	M5	M6
2A0069	FS23637-80-07	80	6.83	8.3 x 15.5 x 2.6	6.6 x 14.9	M6	M8
400 V Class Three-Phase							
4A0001	FS23639-5-07	5	1.10	4.4 x 6.7 x 1.8	3.6 x 6.1	M4	M5
4A0002	FS23639-5-07	5	1.10	4.4 x 6.7 x 1.8	3.6 x 6.1	M4	M5
4A0004	FS23639-5-07	5	1.10	4.4 x 6.7 x 1.8	3.6 x 6.1	M4	M5
4A0005	FS23639-10-07	10	1.54	4.4 x 6.7 x 1.8	3.6 x 6.1	M4	M5
4A0007	FS23639-10-07	10	1.54	4.4 x 6.7 x 1.8	3.6 x 6.1	M4	M5
4A0009	FS23639-10-07	10	1.54	4.4 x 6.7 x 1.8	3.6 x 6.1	M4	M5
4A0011	FS23639-15-07	15	1.98	5.7 x 6.9 x 2.0	4.7 x 6.3	M4	M5
4A0018	FS23639-30-07	30	4.0	5.4 x 12.0 x 2.2	3.9 x 11.4	M5	M5
4A0023	FS23639-30-07	30	4.0	5.4 x 12.0 x 2.2	3.9 x 11.4	M5	M5
4A0031	FS23639-50-07	50	6.0	6.9 x 13.4 x 2.6	5.1 x 12.8	M5	M6
4A0038	FS23639-50-07	50	6.0	6.9 x 13.4 x 2.6	5.1 x 12.8	M5	M6

Note: EMC filters for models BA0018 and 2A0030 through 2A0069 are in compliance with EN 61800-3:2004/A1:2012, Category 2. All other models comply with Category 1.

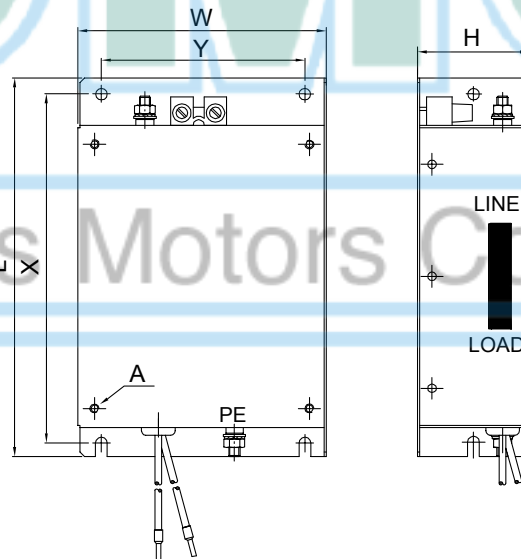

Figure D.7 EMC Filter Dimensions

■ DC Link Chokes for IEC/EN 61000-3-2 Compliance

Drive Model	DC Link Choke	
	Model	Rating
200V Three-Phase Units		
2A0004	UZDA-B	5.4 A 8 mH
2A0006		
400 V Three-Phase Units		
4A0002	UZDA-B	3.2 A 28 mH
4A0004		

Note: Models not listed in the above table do not require a DC link choke for EMC compliance.

DMC

Drives Motors Controls

D.3 UL and CSA Standards

◆ UL Standards Compliance

The UL/cUL mark applies to products in the United States and Canada and indicates that UL has performed product testing and evaluation and determined that their stringent standards for product safety have been met. For a product to receive UL certification, all components inside that product must also receive UL certification.



Figure D.8 UL/cUL Mark

This drive is tested in accordance with UL standard UL508C and complies with UL requirements. The following conditions must be met to maintain compliance when using this drive in combination with other equipment:

■ Installation Area

Do not install the drive to an area greater than pollution severity 2 (UL standard).

■ Ambient Temperature

IP20/NEMA 1, UL Type 1 enclosure: -10 °C to +40 °C (14 °F to 104 °F)

IP20/IP00 Open-Chassis enclosure: -10 °C to +50 °C (14 °F to 122 °F)

Finless Type: IP20/IP00 enclosure: -10 °C to +50 °C (14 °F to 122 °F)

NEMA 4X, UL Type 4X/IP66 enclosure: -10 °C to +40 °C (14 °F to 104 °F)

■ Main Circuit Terminal Wiring

Yaskawa recommends using closed-loop crimp terminals on all drive models. UL/cUL approval requires the use of UL Listed closed-loop crimp terminals when wiring the drive main circuit terminals. Use only the tools recommended by the terminal manufacturer for crimping. The wire gauges listed in [Table D.6](#), [Table D.7](#), and [Table D.8](#) are Yaskawa recommendations. Refer to local codes for proper wire gauge selections.

Table D.6 Wire Gauge and Torque Specifications

Drive Model	Terminal	Recomm. Gauge AWG, kcmil	Wire Range AWG, kcmil	Screw Size	Tightening Torque N•m (lb.in.)
BA0001 BA0002 BA0003	R/L1, S/L2, T/L3	14	18 to 14	M3.5	0.8 to 1.0 (7.1 to 8.9)
	U/T1, V/T2, W/T3	14	18 to 14		
	⊖, ⊕1, ⊕2	–	18 to 14		
	B1, B2	–	18 to 14		
	⊕	14	18 to 14		
BA0006	R/L1, S/L2, T/L3	12	14 to 10	M4	1.2 to 1.5 (10.6 to 13.3)
	U/T1, V/T2, W/T3	14	14 to 10		
	⊖, ⊕1, ⊕2	–	14 to 10		
	B1, B2	–	14 to 10		
	⊕	10	14 to 10		
BA0010	R/L1, S/L2, T/L3	10	14 to 10	M4	1.2 to 1.5 (10.6 to 13.3)
	U/T1, V/T2, W/T3	14	14 to 10		
	⊖, ⊕1, ⊕2	–	14 to 10		
	B1, B2	–	14 to 10		
	⊕	10	14 to 10		

Drive Model	Terminal	Recomm. Gauge AWG, kcmil	Wire Range AWG, kcmil	Screw Size	Tightening Torque N•m (lb.in.)
BA0012	R/L1, S/L2, T/L3	10	14 to 10	M4	2.3 to 2.5 (20.4 to 22.1)
	U/T1, V/T2, W/T3	14	14 to 10		
	⊖, ⊕1, ⊕2	–	14 to 10		
	B1, B2	–	14 to 10		
	⊕	10	14 to 10		
BA0018	R/L1, S/L2, T/L3	8	12 to 8	M5	2.3 to 2.5 (20.4 to 22.1)
	U/T1, V/T2, W/T3	10	12 to 8		
	⊖, ⊕1, ⊕2	–	12 to 8		
	B1, B2	–	12 to 8		
	⊕	8	12 to 8		2 to 2.5 (17.7 to 22.1)

Table D.7 Wire Gauge and Torque Specifications

Drive Model	Terminal	Recomm. Gauge AWG, kcmil	Wire Range AWG, kcmil	Screw Size	Tightening Torque N•m (lb.in.)
2A0001 2A0002 2A0004 2A0006	R/L1, S/L2, T/L3	14	18 to 14	M3.5	0.8 to 1.0 (7.1 to 8.9)
	U/T1, V/T2, W/T3	14	18 to 14		
	⊖, ⊕1, ⊕2	–	18 to 14		
	B1, B2	–	18 to 14		
	⊕	14	18 to 14		
2A0010	R/L1, S/L2, T/L3	12	14 to 10	M4	1.2 to 1.5 (10.6 to 13.3)
	U/T1, V/T2, W/T3	14	14 to 10		
	⊖, ⊕1, ⊕2	–	14 to 10		
	B1, B2	–	14 to 10		
	⊕	10	14 to 10		
2A0012	R/L1, S/L2, T/L3	12	14 to 10	M4	1.2 to 1.5 (10.6 to 13.3)
	U/T1, V/T2, W/T3	14	14 to 10		
	⊖, ⊕1, ⊕2	–	14 to 10		
	B1, B2	–	14 to 10		
	⊕	10	14 to 10		
2A0020	R/L1, S/L2, T/L3	10	14 to 10	M4	1.2 to 1.5 (10.6 to 13.3)
	U/T1, V/T2, W/T3	10	14 to 10		
	⊖, ⊕1, ⊕2	–	14 to 10		
	B1, B2	–	14 to 10		
	⊕	10	14 to 10		
2A0030	R/L1, S/L2, T/L3	8	10 to 6	M4	2.1 to 2.3 (18.6 to 20.4)
	U/T1, V/T2, W/T3	8	10 to 6		
	⊖, ⊕1, ⊕2	–	10 to 6		
	B1, B2	–	14 to 10		
	⊕	8 <->	10 to 6	M5	2 to 2.5 (17.7 to 22.1)
2A0040	R/L1, S/L2, T/L3	6	10 to 6	M4	2.1 to 2.3 (18.6 to 20.4)
	U/T1, V/T2, W/T3	8	10 to 6		
	–, +1, +2	–	10 to 6		
	B1, B2	–	14 to 10		
	⊕	6	10 to 6	M5	2 to 2.5 (17.7 to 22.1)

D.3 UL and CSA Standards

Drive Model	Terminal	Recomm. Gauge AWG, kcmil	Wire Range AWG, kcmil	Screw Size	Tightening Torque N•m (lb.in.)
2A0056	R/L1, S/L2, T/L3	4	6 to 4	M6	5.4 to 6.0 (47.8 to 53.1)
	U/T1, V/T2, W/T3	4	6 to 4		
	⊖, ⊕1, ⊕2	–	6 to 4		
	B1, B2	–	10 to 6	M5	2.7 to 3.0 (23.9 to 26.6)
	⊕	6	8 to 4	M6	5.4 to 6.0 (47.8 to 53.1)
2A0069	R/L1, S/L2, T/L3	3	8 to 2	M8	9.9 to 11 (87.6 to 97.4)
	U/T1, V/T2, W/T3	3	8 to 2		
	⊖, ⊕1, ⊕2	–	8 to 2		
	B1, B2	–	8 to 6	M5	2.7 to 3.0 (23.9 to 26.6)
	⊕	6	6 to 4	M6	5.4 to 6.0 (47.8 to 53.1)

<1> When an EMC filter is installed, additional measures must be taken to comply with IEC/EN 61800-5-1. [Refer to EMC Filter Installation on page 469](#) for details.

Table D.8 Wire Gauge and Torque Specifications

Drive Model	Terminal	Recomm. Gauge AWG, kcmil	Wire Range AWG, kcmil	Screw Size	Tightening Torque N•m (lb.in.)
4A0001 4A0002 4A0004	R/L1, S/L2, T/L3	14	14 to 10	M4	1.2 to 1.5 (10.6 to 13.3)
	U/T1, V/T2, W/T3	14	14 to 10		
	⊖, ⊕1, ⊕2	–	14 to 10		
	B1, B2	–	14 to 10		
	⊕	14	14 to 10		
4A0005 4A0007 4A0009	R/L1, S/L2, T/L3	14	14 to 10	M4	1.2 to 1.5 (10.6 to 13.3)
	U/T1, V/T2, W/T3	14	14 to 10		
	⊖, ⊕1, ⊕2	–	14 to 10		
	B1, B2	–	14 to 10		
	⊕	10	14 to 10		
4A0011	R/L1, S/L2, T/L3	12	14 to 10	M4	1.2 to 1.5 (10.6 to 13.3)
	U/T1, V/T2, W/T3	14	14 to 10		
	⊖, ⊕1, ⊕2	–	14 to 10		
	B1, B2	–	14 to 10		
	⊕	10	14 to 10		
4A0018	R/L1, S/L2, T/L3	10	14 to 6	M4	2.1 to 2.3 (18.6 to 20.4)
	U/T1, V/T2, W/T3	10	14 to 6		
	⊖, ⊕1, ⊕2	–	14 to 6		
	B1, B2	–	14 to 10	M5	2 to 2.5 (17.7 to 22.1)
	⊕	8	14 to 6		
4A0023	R/L1, S/L2, T/L3	10	10 to 6	M4	2.1 to 2.3 (18.6 to 20.4)
	U/T1, V/T2, W/T3	10	10 to 6		
	⊖, ⊕1, ⊕2	–	10 to 6		
	B1, B2	–	14 to 10	M5	2 to 2.5 (17.7 to 22.1)
	⊕	8	10 to 6		

Drive Model	Terminal	Recomm. Gauge AWG, kcmil	Wire Range AWG, kcmil	Screw Size	Tightening Torque N•m (lb.in.)
4A0031	R/L1, S/L2, T/L3	8	10 to 6	M5	3.6 to 4.0 (31.8 to 35.4)
	U/T1, V/T2, W/T3	8	10 to 6		
	⊖, ⊕1, ⊕2	–	10 to 6		
	B1, B2	–	14 to 10	M6	2.7 to 3.0 (23.9 to 26.6)
	⊕	6 <1>	10 to 6		
4A0038	R/L1, S/L2, T/L3	6	10 to 6	M5	3.6 to 4.0 (31.8 to 35.4)
	U/T1, V/T2, W/T3	8	10 to 6		
	⊖, ⊕1, ⊕2	–	10 to 6		
	B1, B2	–	10 to 8	M6	2.7 to 3.0 (23.9 to 26.6)
	⊕	6	10 to 6		

<1> When an EMC filter is installed, additional measures must be taken to comply with IEC/EN 61800-5-1. Refer to [EMC Filter Installation on page 469](#) for details.

Note: Use [crimp insulated terminals](#) or [insulated tubing for wiring these connections](#). Wires should have a continuous maximum allowable temperature of 75 °C 600 V UL approved vinyl sheathed insulation. Ambient temperature should not exceed 30 °C.

Closed-Loop Crimp Terminal Recommendations

Yaskawa recommends crimp terminals made by JST and Tokyo DIP for the insulation cap.

[Table D.9](#) matches the wire gauges and terminal screw sizes with Yaskawa-recommended crimp terminals, tools, and insulation caps. Refer to the appropriate Wire Gauge and Torque Specifications table for the wire gauge and screw size for your drive model. Place orders with a Yaskawa representative or the Yaskawa sales department.

The closed-loop crimp terminal sizes and values listed in [Table D.9](#) are Yaskawa recommendations. Refer to local codes for proper selections.

Table D.9 Closed-Loop Crimp Terminal Sizes

Wire Gauge	Terminal Screws	Crimp Terminal Model Number	Tool		Insulation Cap Model No.	Code <1>
			Machine No.	Die Jaw		
18 AWG	M3.5	R1.25-3.5	YA-4	AD-900	TP-003	100-066-217
16 AWG	M3.5	R1.25-3.5	YA-4	AD-900	TP-003	100-066-217
14 AWG	M3.5	R2-3.5	YA-4	AD-900	TP-003	100-066-218
	M4	R2-4	YA-4	AD-900	TP-003	100-054-028
12 / 10 AWG	M4	R5.5-4	YA-4	AD-900	TP-005	100-054-029
	M5	R5.5-5	YA-4	AD-900	TP-005	100-054-030
8 AWG	M4	8-4	YA-4	AD-901	TP-008	100-054-031
	M5	R8-5	YA-4	AD-901	TP-008	100-054-032
	M8	R8-8	YA-4	AD-901	TP-008	100-061-111
6 AWG	M4	14-4	YA-4	AD-902	TP-014	100-66-220
	M5	R14-5	YA-4	AD-902	TP-014	100-054-034
	M6	R14-6	YA-5	AD-952	TP-014	100-051-261
	M8	R14-8	YA-5	AD-952	TP-014	100-054-035
4 AWG	M6	R22-6	YA-5	AD-953	TP-022	100-051-262
	M8	R22-8	YA-5	AD-953	TP-022	100-051-263
3 AWG	M8	R38-8	YA-5	AD-954	TP-038	100-051-264
2 AWG	M8	R38-8	YA-5	AD-954	TP-038	100-051-264

<1> Codes refer to a set of three crimp terminals and three insulation caps. Prepare input and output wiring using two sets for each connection. Example: Models with 14 AWG for both input and output require one set for input terminals and one set for output terminals, so the user should order two sets of [100-066-218].

Note: Consider the amount of voltage drop when selecting wire gauges. Increase the wire gauge when the voltage drop is greater than 2% of motor rated voltage. Ensure the wire gauge is suitable for the terminal block. Use the following formula to calculate the amount of voltage drop: Line drop voltage (V) = $\sqrt{3} \times \text{wire resistance } (\Omega/\text{km}) \times \text{wire length (m)} \times \text{current (A)} \times 10^{-3}$

■ Factory Recommended Branch Circuit Protection

Yaskawa recommends installing one of the following types of branch circuit protection to maintain compliance with UL508C. Semiconductor protective type fuses are preferred.

Branch circuit protection shall be provided by any of the following according to [Table D.10](#).

- Non-time Delay Class J, T, or CC fuses.
- Time Delay Class J, T, CC, or RK5 fuses.
- Semiconductor fuses.
- Molded Case Circuit Breakers (MCCB).

Table D.10 Factory Recommended Drive Branch Circuit Protection

Drive Model	Non-time Delay Fuse Rating (A) <1>	Time Delay Fuses		Bussmann Semiconductor Fuse Part Number (Fuse Ampere) <4>	MCCB <5>	
		Class J, T, or CC Fuse Rating (A) <2>	Class RK5 Fuse Rating (A) <3>		Rating (A)	Minimum Enclosure Volume (in ³)
200 V Class Single-Phase Drives						
BA0001	6	3.5	4	FWH-25A14F (25)	15	600
BA0002	10	6	8	FWH-25A14F (25)	15	600
BA0003	20	10	15	FWH-60B (60)	15	600
BA0006	40	20	30	FWH-80B (80)	30	1152
BA0010	40	35	45	FWH-100B (100)	50	1152
BA0012	50	40	50	FWH-125B (125)	60	1152
BA0018	80	60	70	FWH-175B (175)	80	1152
200 V Class Three-Phase Drives						
2A0001	3	1.5	2	FWH-25A14F (25)	15	600
2A0002	6 <6>	3	3	FWH-25A14F (25)	15	600
2A0004	15 <7>	6	8	FWH-25A14F (25)	15	600
2A0006	20	10	15	FWH-25A14F (25)	15	1152
2A0010	25	15	20	FWH-70B (70)	25	1152
2A0012	25	20	30	FWH-70B (70)	30	1152
2A0020	40	40	50	FWH-90B (90)	60	1152
2A0030	–	60	80	FWH-100B (100)	90	1152
2A0040	–	90	110	FWH-200B (200)	125	1152
2A0056	–	110	150	FWH-200B (200)	150	2560
2A0069	–	125	175	FWH-200B (200)	200	2560
400 V Class Three-Phase Drives						
4A0001	3	2	2	FWH-40B (40)	15	1152
4A0002	6	3.5	3	FWH-40B (40)	15	1152
4A0004	15 <7>	7	8	FWH-50B (50)	15	1152
4A0005	20 <8>	10	10	FWH-70B (70)	15	1152
4A0007	25 <9>	12	15	FWH-70B (70)	20	1152
4A0009	25	15	20	FWH-90B (90)	20	1152
4A0011	30	20	30	FWH-90B (90)	35	1152
4A0018	–	35	45	FWH-80B (80)	50	1152
4A0023	–	40	50	FWH-100B (100)	60	1152
4A0031	–	60	80	FWH-125B (125)	90	1152
4A0038	–	70	90	FWH-200B (200)	110	1152

<1> Maximum 300% of drive input current rating for any Class J, T, or CC fuse except for models 2A0002, 2A0004, 4A0004, 4A0005, and 4A0007.

<2> Maximum 175% of drive input current rating for any Class J, T, or CC fuse.

<3> Maximum 225% of drive input current rating for any Class RK5 fuse.

<4> When using semiconductor fuses, Bussmann FWH are required for UL compliance.

- <5> Maximum MCCB Rating is 15 A or 200% of drive input current rating, whichever is larger. MCCB voltage rating must be 600 Vac or greater. Additionally, when using MCCBs for protection, the drive must be installed in a ventilated enclosure with minimum volume according the “Minimum Enclosure Volume” column.
- <6> Model 2A0002 requires Mersen (Ferraz) part number A6T6 for compliance.
- <7> Models 2A0004 and 4A0004 require Mersen (Ferraz) part number A6T15 for compliance.
- <8> Model 4A0005 requires Mersen (Ferraz) part number A6T20 for compliance.
- <9> Model 4A0007 requires Mersen (Ferraz) part number A6T25 for compliance.

■ Low Voltage Wiring for Control Circuit Terminals

Wire low voltage wires with NEC Class 1 circuit conductors. Refer to national state or local codes for wiring. The external power supply shall be a UL-Listed Class 2 power source or equivalent.

Table D.11 Control Circuit Terminal Power Supply

Input / Output	Terminal Signal	Power Supply Specifications
Multi-function photocoupler output	P1, P2, PC	Requires class 2 power supply
Multi-function digital inputs	S1, S2, S3, S4, S5, S6, S7, SC	Use the internal power supply of the drive. Use class 2 for external power supply.
Multi-function analog inputs	A1, A2, AC	Use the internal power supply of the drive. Use class 2 for external power supply.
Pulse train input	RP	Use the internal LVLC power supply of the drive. Use class 2 for external power supply.
Pulse train output	MP	Use the internal LVLC power supply of the drive. Use class 2 for external power supply.

■ Drive Short-Circuit Rating

This drive has undergone the UL short-circuit test, which certifies that during a short circuit in the power supply the current flow will not rise above 31,000 amps maximum at 240 V for 200 V class drives and 480 V for 400 V class drives.

- The MCCB and breaker protection and fuse ratings shall be equal to or greater than the short-circuit tolerance of the power supply being used.
- Suitable for use on a circuit capable of delivering not more than 31,000 RMS symmetrical amperes for 240 V in 200 V class drives (up to 480 V for 400 V class drives) motor overload protection.

◆ CSA Standards Compliance



Figure D.9 CSA Mark

■ CSA for Industrial Control Equipment

The drive is CSA-certified as Industrial Control Equipment Class 3211.

Specifically, the drive is certified to: CAN/CSA C22.2 No. 04-04 and CAN/CSA C22.2 No.14-05.

◆ Drive Motor Overload Protection

Set parameter E2-01 (motor rated current) to the appropriate value to enable motor overload protection. The internal motor overload protection is UL listed and in accordance with the NEC and CEC.

■ E2-01: Motor Rated Current

Setting Range: Model Dependent

Default Setting: Model Dependent

Parameter E2-01 (motor rated current) protects the motor if parameter L1-01 is not set to 0 (default is 1, standard induction motor protection enabled).

D.3 UL and CSA Standards

If Auto-Tuning has been performed successfully, the motor data that was entered in T1-04 is automatically written into parameter E2-01. If Auto-Tuning has not been performed, manually enter the correct motor rated current in parameter E2-01.

■ L1-01: Motor Overload Protection Selection

The drive has an electronic overload protection function (oL1) based on time, output current and output frequency, which protects the motor from overheating. The electronic thermal overload function is UL-recognized, so it does not require an external thermal overload relay for single motor operation.

This parameter selects the motor overload curve used according to the type of motor applied.

Table D.12 Overload Protection Settings

Setting	Description
0	Disabled
1	Standard Fan-Cooled Motor (Default)
2	Drive Duty Motor with a Speed Range of 1:10
3	Vector Motor with a Speed Range of 1:100
4	Permanent Magnet Motor with Variable Torque
6	Standard Fan-Cooled Motor (50 Hz)

Disable the electronic overload protection (L1-01 = 0: Disabled) and wire each motor with its own motor thermal overload when connecting the drive to more than one motor for simultaneous operation.

Enable the motor overload protection (L1-01 = "1", "2", or "3") when connecting the drive to a single motor unless there is another means of preventing motor thermal overload. The electronic thermal overload function causes an oL1 fault, which shuts off the output of the drive and prevents additional overheating of the motor. The motor temperature is continually calculated as long as the drive is powered up.

Setting L1-01 = 1 selects a motor with limited cooling capability below rated (base) speed when running at 100% load. The oL1 function derates the motor when it is running below base speed.

Setting L1-01 = 2 selects a motor capable of cooling itself over a 10:1 speed range when running at 100% load. The oL1 function derates the motor when it is running at 1/10 or less of its rated speed.

Setting L1-01 = 3 selects a motor capable of cooling itself at any speed — including zero speed — when running at 100% load. The oL1 function does not derate the motor at any speed.

Setting L1-01 = 4 selects protection for a PM motor with variable torque.

■ L1-02: Motor Overload Protection Time

Setting Range: 0.1 to 5.0 Minutes

Factory Default: 1.0 Minutes

The L1-02 parameter sets the allowed operation time before the oL1 fault occurs when the drive is running at 60 Hz and 150% of the full load amp rating (E2-01) of the motor. Adjusting the value of L1-02 can shift the set of oL1 curves up the Y-axis of the diagram below but will not change the shape of the curves.

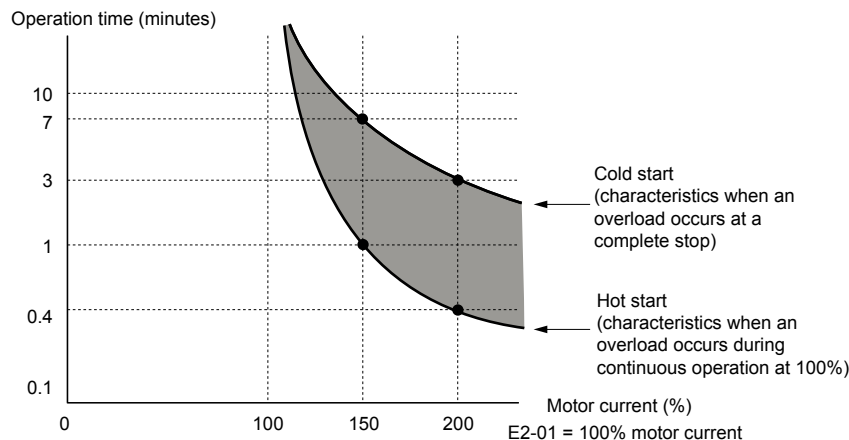

Figure D.10 Motor Overload Protection Time

D.4 Safe Disable Input



Figure D.11 TUV Mark

The TUV Mark indicates compliance with safety standards.

This section explains precautions regarding the Safe Disable input. Contact Yaskawa or your nearest sales representative for more information.

The Safety Disable function complies with the standards listed in [Table D.13](#).

Table D.13 Safety Standards and Applicable EU Standards

Safety Standards	Applicable EU Standards
Functional Safety	IEC 61508:2000/EN 61508:2001(SIL2)
	IEC/EN 61800-5-2: 2007 (SIL2)
Mechanical Safety	ISO 13849-1:2006 (Cat.III, PL d) / EN ISO 13849-1/AC:2009 (Cat.III, PL d)
EMC	EN 61800-3:2004/A1:2012
	EN 61800-5-1:2007

Note: SIL stands for Safety Integrity Level.

◆ Specifications

The Safe Disable input provides a stop function in compliance with the “Safe Torque Off” function defined in IEC/EN 61800-5-2:2007. The Safe Disable input satisfies the requirements in EN ISO 13849-1 and IEC/EN 61508, SIL2. [Table D.14](#) lists the specifications for the Safety Disable function.

Table D.14 Specifications for Safe Disable Function

Inputs/Outputs	<ul style="list-style-type: none"> Inputs: 1 Safe Disable input H1 Outputs: 0
Response Time from Input Open to Drive Output Stop	Shorter than 1 ms
Failure Probability	Demand Rate Low PFD = $1.24E^{-7}$
	Demand Rate High/Continuous PFH = $5.17E^{-10}$
Performance Level	The Safe Disable inputs satisfy the following requirements in consideration of the self-diagnostic function. Performance Level (PL) d according to EN ISO 13849-1
HFT (Hardware Fault Tolerance)	N = 1
Classification of Subsystem	Type B

Note: PFD = Probability of Failure on Demand
PFH = Probability of Dangerous Failure per Hour

◆ Precautions

DANGER! *Sudden Movement Hazard.* Make sure the whole system or machinery in which the Safe Disable function is used complies with safety requirements. When implementing the Safe Disable function into the safety system of a machine, perform a thorough risk assessment for the entire system to assure compliance with relevant safety norms. Improper use of the Safe Disable function will cause serious injury or even death.

DANGER! *Sudden Movement Hazard.* An external holding brake and dynamic brake are not considered to be safety components for drives. Even when using an external holding brake or dynamic brake with a drive output signal, it is still not considered a safe system because the drive output signal is not a safety component. A system is required that satisfies safety requirements. Failure to comply will cause death or serious injury.

DANGER! *Sudden Movement Hazard.* Connect the Safe Disable inputs to the devices in compliance with safety requirements. Failure to comply will cause death or serious injury.

WARNING! *Sudden Movement Hazard.* When using a PM motor, even if the drive output is shut off by the Safe Disable function, a breakdown of two output transistors can cause current to flow through the motor winding, resulting in a motor output axis movement for a maximum angle of 180 degrees (electrically). Make sure such a situation would have no effect on the safety of the application when using the Safe Disable function. Failure to comply could cause serious injury or death.

WARNING! *Electrical Shock Hazard.* The Safe Disable function can switch off the drive output, but does not cut the drive power supply and cannot electrically isolate the drive output from the input. Always shut off the drive power supply when performing maintenance or installations on the drive input side as well as the drive output side. Failure to comply could cause serious injury or death.

WARNING! *Sudden Movement Hazard.* The motor will move when an external gravitational force in the vertical axis is applied even if the Safe Disable function is in operation. Failure to comply could cause serious injury or death.

WARNING! *Sudden Movement Hazard.* When using the Safe Disable inputs, make sure to remove the wire links between terminals H1 and HC that were installed prior to shipment. Failure to do so will keep the Safe Disable circuit from operating properly and could cause death or serious injury.

WARNING! *Sudden Movement Hazard.* All safety features (including Safe Disable) should be inspected daily and periodically. If the system is not operating normally, this could cause death or serious injury.

WARNING! *Sudden Movement Hazard.* Only a qualified technician with a thorough understanding of the drive, the instruction manual, and safety standards should be permitted to wire, inspect, and maintain the Safe Disable input. Failure to comply could cause death or serious injury.

NOTICE: *From the moment terminal inputs H1 and HC have opened, it takes up to 1 ms for drive output to shut off completely. The sequence set up to trigger terminals H1-HC should make sure that terminals H1-HC remain open for at least 1 ms in order to properly interrupt drive output.*

NOTICE: *Drives with safety-related functions need to be replaced after 10 years of use.*

Drives Motors Controls

◆ Using the Safe Disable Function

■ Safe Disable Wiring

If the Safe Disable function is utilized, the wire link between the terminals HC and H1 that is installed at shipment must be removed entirely.

Connect the drive to an ISO/EN 13849-1, Safety Category 3 interrupting device so that in case of a Safe Disable request the connection between the terminals HC and H1 is opened.

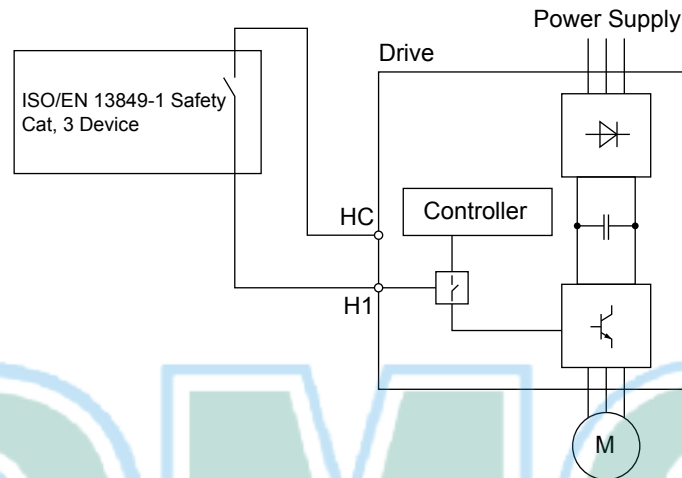

Figure D.12 Safe Disable Wiring Example

■ Disabling and Enabling the Drive Output (“Safe Torque Off”)

Refer to [Figure D.13](#) for an example of drive operation when switching from the “Safe Torque Off” status until reaching normal operation.

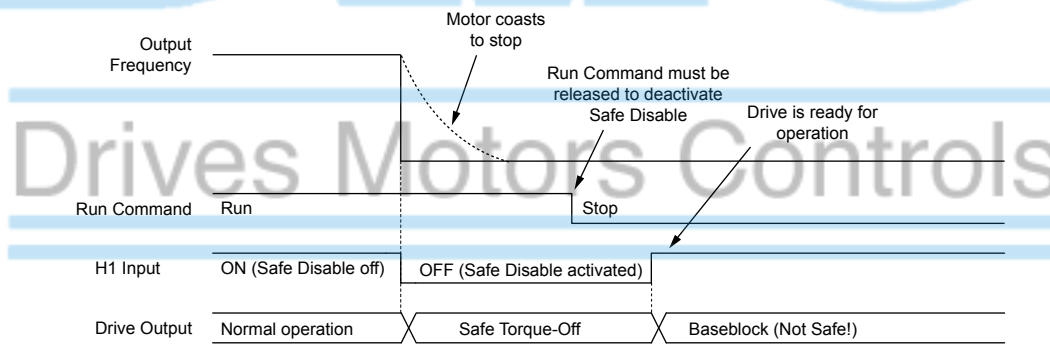

Figure D.13 Safe Disable Operation

Switching from Normal Operation to “Safe Torque Off”

Turning OFF (opening) safety input terminal H1-HC will enable the Safe Disable function.

Triggering the Safe Disable function while the motor is running will shut off the drive output and motor torque and the motor will coast to stop regardless of the b1-03 setting value.

The “Safe Torque Off” status is only possible when using the Safe Disable function. Clear the Run command to stop the drive. Shutting off the drive output, as in a baseblock condition, is not the same as “Safe Torque Off”.

Note: Switch OFF terminals H1-HC after the motor has come to a complete stop to prevent the motor from coasting to stop during normal operation.

Returning to Normal Operation from “Safe Torque Off”

The safety input releases only when the Run command is not present.

- During Stop:

Place short circuit between terminals H1 and HC to disable “Safe Torque Off” when the Safe Disable function is triggered during stop. Enter the Run command after the drive stops normally.

D.4 Safe Disable Input

- During run:

Place short circuit between terminals H1 and HC to disable "Safe Torque Off" after clearing the Run command when the Safe Disable function is triggered during stop. Enter the Run command after entering the STOP command regardless of whether terminals H1-HC are ON.

■ Validating Safe Disable Function

Always perform the validation test on the Safe Disable inputs after completing the wiring after start-up, when replacing parts, or when conducting maintenance. Maintain check results as a record of tests performed.

The logo consists of the letters 'D', 'M', and 'C' in a large, bold, sans-serif font. Each letter is filled with a light teal color and has a thick, light blue outline. The letters are spaced out horizontally.The tagline 'Drives Motors Controls' is written in a grey, sans-serif font. It is positioned below the 'DMC' logo and is framed by two horizontal light blue lines, one above and one below the text.

Appendix: E

Quick Reference Sheet

The following tables have been provided for the user's convenience. Fill in the cells that have been left blank as is appropriate for your drive, and keep this information as a quick reference guide for drive and motor data as well as parameter settings.

E.1	DRIVE AND MOTOR SPECIFICATIONS.....	486
E.2	BASIC PARAMETER SETTINGS.....	487
E.3	USER SETTING TABLE.....	489

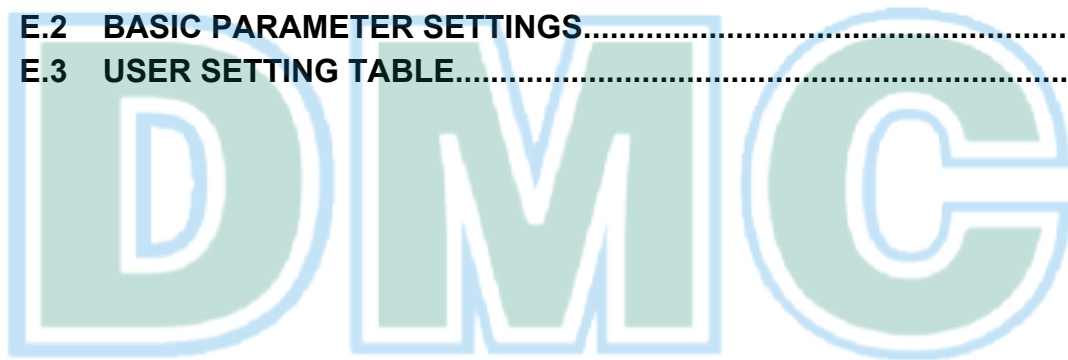

Drives Motors Controls

E.1 Drive and Motor Specifications

A separate record should be kept that lists drive specifications and motor specifications.

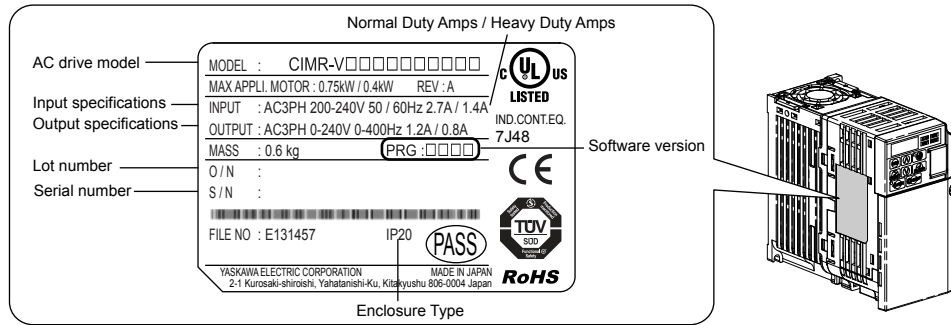

◆ Drive

Items	Description
Model	CIMR-V
Serial Number	
Software Version (PRG)	
Date of Usage	

◆ Motor

Items	Description	Items	Description
Manufacturer		Motor Rated Current (T1-04)	A
Model		Motor Base Frequency (T1-05)	Hz
Motor Rated Power (T1-02)	HP	Number of Motor Poles (T1-06)	
Motor Rated Voltage (T1-03)	V	Motor Base Speed (T1-07)	r/min

Note: These values must be entered as part of the Auto-Tuning process.

E.2 Basic Parameter Settings

Use the following tables to keep records of the most important parameters. Have these data available when contacting Yaskawa technical support.

◆ Basic Setup

Item	Setting Value	Memo
Control Mode	A1-02 =	
Normal/Heavy Duty Selection	C6-01 =	
Frequency Reference Source	b1-01 =	
Run Command Source	b1-02 =	

◆ V/f Pattern Setup

Item	Setting Value	Memo
V/f Pattern Selection	E1-03 =	
Maximum Output Frequency	E1-04 =	
Maximum Voltage	E1-05 =	
Base Frequency	E1-06 =	
Middle Output Frequency	E1-07 =	
Mid. Output Freq. Voltage	E1-08 =	
Minimum Output Frequency	E1-09 =	
Min. Output Freq. Voltage	E1-10 =	

◆ Motor Setup

Motor Type	Item	Setting Value	Memo
Induction Motor	Motor Rated Current	E2-01 =	
	Motor Rated Slip	E2-02 =	
	Motor No-Load Current	E2-03 =	
	Number of Motor Poles	E2-04 =	
	Line-to-Line Resistance	E2-05 =	
	Motor Leakage Inductance	E2-06 =	
Permanent Magnet Motor	Motor Code Selection	E5-01 =	
	Motor Rated Power	E5-02 =	
	Motor Rated Current	E5-03 =	
	Number of Motor Poles	E5-04 =	
	Motor Stator Resistance	E5-05 =	
	Motor d-Axis Inductance	E5-06 =	
	Motor q-Axis Inductance	E5-07 =	
	Encoder Z-Pulse Offset	E5-11 =	
Induction Voltage Constant 2	E5-24 =		

◆ Multi-Function Digital Outputs (SC Common)

Terminal	Used/Reserved	Setting Value and Function Name	Memo
S1		H1-01 =	
S2		H1-02 =	

E.2 Basic Parameter Settings

Terminal	Used/ Reserved	Setting Value and Function Name	Memo
S3		H1-03 =	
S4		H1-04 =	
S5		H1-05 =	
S6		H1-06 =	
S7		H1-07 =	

◆ Pulse Train Input/Analog Inputs (AC Common)

Terminal	Used/ Reserved	Setting Value and Function Name	Memo
RP		H6-01 =	
A1		H3-02 =	
A2		H3-10 =	

◆ Multi-Function Digital Outputs (MC Common)

Terminal	Used/ Reserved	Setting Value and Function Name	Memo
MA-MB		H2-01 =	

◆ Multi-Function Photocoupler Outputs (PC Common)

Terminal	Used/ Reserved	Setting Value and Function Name	Memo
P1		H2-02 =	
P2		H2-03 =	

◆ Monitor Outputs (AC Common)

Terminal	Used/ Reserved	Setting Value and Function Name	Memo
MP			
AM		H4-01 =	

E.3 User Setting Table

No.	Name	User Setting	No.	Name	User Setting
A1-00	Language Selection		b5-04	Integral Limit Setting	
A1-01	Access Level Selection		b5-05	Derivative Time	
A1-02	Control Method Selection		b5-06	PID Output Limit	
A1-03	Initialize Parameters		b5-07	PID Offset Adjustment	
A1-04	Password		b5-08	PID Primary Delay Time Constant	
A1-05	Password Setting		b5-09	PID Output Level Selection	
A1-06	Application Preset		b5-10	PID Output Gain Setting	
A1-07	DriveWorksEZ Function Selection		b5-11	PID Output Reverse Selection	
A2-02 to A2-32	User Parameters, 1 to 32		b5-12	PID Feedback Reference Missing Detection Selection	
A2-33	User Parameter Automatic Selection		b5-13	PID Feedback Loss Detection Level	
b1-01	Frequency Reference Selection 1		b5-14	PID Feedback Loss Detection Time	
b1-02	Run Command Selection 1		b5-15	PID Sleep Function Start Level	
b1-03	Stopping Method Selection		b5-16	PID Sleep Delay Time	
b1-04	Reverse Operation Selection		b5-17	PID Accel/Decel Time	
b1-07	Local/Remote Run Selection		b5-18	PID Setpoint Selection	
b1-08	Run Command Selection while in Programming Mode		b5-19	PID Setpoint Value	
b1-14	Phase Order Selection		b5-20	PID Setpoint Scaling	
b1-15	Frequency Reference Selection 2		b5-34	PID Output Lower Limit	
b1-16	Run Command Selection 2		b5-35	PID Input Limit	
b1-17	Run Command at Power Up		b5-36	PID Feedback High Detection Level	
b2-01	DC Injection Braking Start Frequency		b5-37	PID Feedback High Level Detection Time	
b2-02	DC Injection Braking Current		b5-38	PID Setpoint / User Display	
b2-03	DC Injection Braking Time/DC Excitation Time at Start		b5-39	PID Setpoint and Display Digits	
b2-04	DC Injection Braking Time at Stop		b5-40	Frequency Reference Monitor Content during PID	
b2-08	Magnetic Flux Compensation Value		b6-01	Dwell Reference at Start	
b2-12	Short Circuit Brake Time at Start		b6-02	Dwell Time at Start	
b2-13	Short Circuit Brake Time at Stop		b6-03	Dwell Frequency at Stop	
b3-01	Speed Search Selection		b6-04	Dwell Time at Stop	
b3-02	Speed Search Deactivation Current		b8-01	Energy Saving Control Selection	
b3-03	Speed Search Deceleration Time		b8-02	Energy Saving Gain	
b3-05	Speed Search Delay Time		b8-03	Energy Saving Control Filter Time Constant	
b3-06	Output Current 1 during Speed Search		b8-04	Energy Saving Coefficient Value	
b3-08	Current Control Gain during Speed Search (Speed Estimation Type)		b8-05	Power Detection Filter Time	
b3-10	Speed Search Detection Compensation Gain		b8-06	Search Operation Voltage Limit	
b3-14	Bi-Directional Speed Search Selection		C1-01	Acceleration Time 1	
b3-17	Speed Search Restart Current Level		C1-02	Deceleration Time 1	
b3-18	Speed Search Restart Detection Time		C1-03	Acceleration Time 2	
b3-19	Number of Speed Search Restarts		C1-04	Deceleration Time 2	
b3-24	Speed Search Method Selection		C1-05	Acceleration Time 3 (Motor 2 Accel Time 1)	
b3-25	Speed Search Retry Interval Time		C1-06	Deceleration Time 3 (Motor 2 Decel Time 1)	
b4-01	Timer Function On-Delay Time		C1-07	Acceleration Time 4 (Motor 2 Accel Time 2)	
b4-02	Timer Function Off-Delay Time		C1-08	Deceleration Time 4 (Motor 2 Decel Time 2)	
b5-01	PID Function Setting		C1-09	Fast-Stop Time	
b5-02	Proportional Gain Setting (P)		C1-10	Accel/Decel Time Setting Units	
b5-03	Integral Time Setting (I)		C1-11	Accel/Decel Time Switching Frequency	
			C2-01	S-Curve Characteristic at Accel Start	

E.3 User Setting Table

No.	Name	User Setting	No.	Name	User Setting
C2-02	S-Curve Characteristic at Accel End		d3-03	Jump Frequency 3	
C2-03	S-Curve Characteristic at Decel Start		d3-04	Jump Frequency Width	
C2-04	S-Curve Characteristic at Decel End		d4-01	Frequency Reference Hold Function Selection	
C3-01	Slip Compensation Gain		d4-03	Frequency Reference Bias Step (Up/Down 2)	
C3-02	Slip Compensation Primary Delay Time		d4-04	Frequency Reference Accel/Decel (Up/Down 2)	
C3-03	Slip Compensation Limit		d4-05	Frequency Reference Bias Operation Mode Selection (Up/Down 2)	
C3-04	Slip Compensation Selection during Regeneration		d4-06	Frequency Reference Bias (Up/Down 2)	
C3-05	Output Voltage Limit Operation Selection		d4-07	Analog Frequency Reference Fluctuation Limit (Up/Down 2)	
C4-01	Torque Compensation Gain		d4-08	Frequency Reference Bias Upper Limit (Up/Down 2)	
C4-02	Torque Compensation Primary Delay Time		d4-09	Frequency Reference Bias Lower Limit (Up/Down 2)	
C4-03	Torque Compensation at Forward Start		d4-10	Up/Down Frequency Reference Limit Selection	
C4-04	Torque Compensation at Reverse Start		d7-01	Offset Frequency 1	
C4-05	Torque Compensation Time Constant		d7-02	Offset Frequency 2	
C4-06	Torque Compensation Primary Delay Time 2		d7-03	Offset Frequency 3	
C5-01	ASR Proportional Gain 1 (for Simple PG V/f Control)		E1-01	Input Voltage Setting	
C5-02	ASR Integral Time 1 (for Simple PG V/f Control)		E1-03	V/f Pattern Selection	
C5-03	ASR Proportional Gain 2 (for Simple PG V/f Control)		E1-04	Max Output Frequency	
C5-04	ASR Integral Time 2 (for Simple PG V/f Control)		E1-05	Max Voltage	
C5-05	ASR Limit (for Simple PG V/f Control)		E1-06	Base Frequency	
C6-01	Duty Mode Selection		E1-07	Mid Output Frequency	
C6-02	Carrier Frequency Selection		E1-08	Mid Output Frequency Voltage	
C6-03	Carrier Frequency Upper Limit		E1-09	Minimum Output Freq.	
C6-04	Carrier Frequency Lower Limit		E1-10	Minimum Output Freq. Voltage	
C6-05	Carrier Frequency Proportional Gain		E1-11	Mid Output Frequency 2	
d1-01	Frequency Reference 1		E1-12	Mid Output Frequency Voltage 2	
d1-02	Frequency Reference 2		E1-13	Base Voltage	
d1-03	Frequency Reference 3		E2-01	Motor Rated Current	
d1-04	Frequency Reference 4		E2-02	Motor Rated Slip	
d1-05	Frequency Reference 5		E2-03	Motor No-Load Current	
d1-06	Frequency Reference 6		E2-04	Number of Motor Poles	
d1-07	Frequency Reference 7		E2-05	Motor Line-to-Line Resistance	
d1-08	Frequency Reference 8		E2-06	Motor Leakage Inductance	
d1-09	Frequency Reference 9		E2-07	Motor Iron-Core Saturation Coefficient 1	
d1-10	Frequency Reference 10		E2-08	Motor Iron-Core Saturation Coefficient 2	
d1-11	Frequency Reference 11		E2-09	Motor Mechanical Loss	
d1-12	Frequency Reference 12		E2-10	Motor Iron Loss for Torque Compensation	
d1-13	Frequency Reference 13		E2-11	Motor Rated Output	
d1-14	Frequency Reference 14		E2-12	Motor Iron-Core Saturation Coefficient 3	
d1-15	Frequency Reference 15		E3-01	Motor 2 Control Method Selection	
d1-16	Frequency Reference 16		E3-04	Motor 2 Max Output Frequency	
d1-17	Jog Frequency Reference		E3-05	Motor 2 Max Voltage	
d2-01	Frequency Reference Upper Limit		E3-06	Motor 2 Base Frequency	
d2-02	Frequency Reference Lower Limit		E3-07	Motor 2 Mid Output Frequency	
d2-03	Master Speed Reference Lower Limit		E3-08	Motor 2 Mid Output Frequency Voltage	
d3-01	Jump Frequency 1		E3-09	Motor 2 Minimum Output Freq	
d3-02	Jump Frequency 2		E3-10	Motor 2 Minimum Output Freq. Voltage	

No.	Name	User Setting	No.	Name	User Setting
E3-11	Motor 2 Mid Output Freq. 2		F6-11	CC-Link Communications Speed	
E3-12	Motor 2 Mid Output Freq. Voltage 2		F6-14	BUS Error Auto Reset	
E3-13	Motor 2 Base Voltage		F6-20	MECHATROLINK Station Address	
E4-01	Motor 2 Rated Current		F6-21	MECHATROLINK Frame Size	
E4-02	Motor 2 Rated Slip		F6-22	MECHATROLINK Link Speed	
E4-03	Motor 2 Rated No-Load Current		F6-23	MECHATROLINK Monitor Selection (E)	
E4-04	Motor 2 Motor Poles		F6-24	MECHATROLINK Monitor Selection (F)	
E4-05	Motor 2 Line-to-Line Resistance		F6-25	Operation Selection at MECHATROLINK Watchdog Timer Error (E5)	
E4-06	Motor 2 Leakage Inductance		F6-26	MECHATROLINK bUS Errors Detected	
E4-07	Motor 2 Motor Iron-Core Saturation Coefficient 1		F6-30	PROFIBUS-DP Node Address	
E4-08	Motor 2 Motor Iron-Core Saturation Coefficient 2		F6-31	PROFIBUS-DP Clear Mode Selection	
E4-09	Motor 2 Mechanical Loss		F6-32	PROFIBUS-DP Map Selections	
E4-10	Motor 2 Iron Loss		F6-35	CANopen Node ID Selection	
E4-11	Motor 2 Rated Capacity		F6-36	CANopen Communication Speed	
E4-12	Motor 2 Iron-Core Saturation Coefficient 3		F6-40	CompoNet Node ID	
E4-14	Motor 2 Slip Compensation Gain		F6-41	CompoNet Speed	
E4-15	Torque Compensation Gain - Motor 2		F6-50	DeviceNet MAC Address	
E5-01	Motor Code Selection (PM motor)		F6-51	DeviceNet Communication Speed	
E5-02	Motor Rated Capacity (PM motor)		F6-52	DeviceNet PCA Setting	
E5-03	Motor Rated Current (PM motor)		F6-53	DeviceNet PPA Setting	
E5-04	Motor Poles (PM motor)		F6-54	DeviceNet Idle Mode Fault Detection	
E5-05	Motor Stator Resistance (PM motor)		F6-56	DeviceNet Speed Scaling	
E5-06	Motor d Axis Inductance (PM motor)		F6-57	DeviceNet Current Scaling	
E5-07	Motor q Axis Inductance (PM motor)		F6-58	DeviceNet Torque Scaling	
E5-09	Motor Induction Voltage Constant 1 (PM motor)		F6-59	DeviceNet Power Scaling	
E5-24	Motor Induction Voltage Constant 2 (PM motor)		F6-60	DeviceNet Voltage Scaling	
E5-39	Current Detection Delay Time		F6-61	DeviceNet Time Scaling	
F1-02	Operation Selection at PG Open Circuit (PGO)		F6-62	DeviceNet Heartbeat Interval	
F1-03	Operation Selection at Overspeed (OS) (for Simple PG V/f)		F7-01	Ethernet IP Address 1	
F1-04	Operation Selection at Deviation (for Simple PG V/f Control)		F7-02	Ethernet IP Address 2	
F1-08	Overspeed Detection Level (for Simple PG V/f Control)		F7-03	Ethernet IP Address 3	
F1-09	Overspeed Detection Delay Time (for Simple PG V/f Control)		F7-04	Ethernet IP Address 4	
F1-10	Excessive Speed Deviation Detection Level (for Simple PG V/f Control)		F7-05	Subnet Mask 1	
F1-11	Excessive Speed Deviation Detection Delay Time (for Simple PG V/f Control)		F7-06	Subnet Mask 2	
F1-14	PG Open-Circuit Detection Time (for Simple PG V/f Control)		F7-07	Subnet Mask 3	
F6-01	Communications Error Operation Selection		F7-08	Subnet Mask 4	
F6-02	External Fault from Comm. Option Selection		F7-09	Gateway Address 1	
F6-03	External Fault from Comm. Option Operation Selection		F7-10	Gateway Address 2	
F6-04	Trace Sampling Rate		F7-11	Gateway Address 3	
F6-07	NetRef/ComRef Function Selection		F7-12	Gateway Address 4	
F6-08	Reset Communication Parameters		F7-13	Address Mode at Startup	
F6-10	CC-Link Node Address		F7-14	Security Password	
			F7-15	Duplex Mode Selection	
			F7-18	Communication Speed Selection	
			F7-19	Web Page Access	
			F7-20	Gateway Selection	
			F7-21	Communication Loss Time Out	
			H1-01	Multi-Function Digital Input Terminal S1 Function Selection	

E.3 User Setting Table

No.	Name	User Setting	No.	Name	User Setting
H1-02	Multi-Function Digital Input Terminal S2 Function Selection		H6-05	Pulse Train Input Filter Time	
H1-03	Multi-Function Digital Input Terminal S3 Function Selection		H6-06	(Terminal MP) Pulse Train Monitor Selection	
H1-04	Multi-Function Digital Input Terminal S4 Function Selection		H6-07	Pulse Train Monitor Scaling	
H1-05	Multi-Function Digital Input Terminal S5 Function Selection		L1-01	Motor Overload Protection Selection	
H1-06	Multi-Function Digital Input Terminal S6 Function Selection		L1-02	Motor Overload Protection Time	
H1-07	Multi-Function Digital Input Terminal S7 Function Selection		L1-03	Motor Overheat Alarm Operation Selection (PTC input)	
H2-01	Terminal MA, MB and MC Function Selection (relay)		L1-04	Motor Overheat Fault Operation Selection (PTC input)	
H2-02	Terminal P1 Function Selection (open-collector)		L1-05	Motor Temperature Input Filter Time (PTC input)	
H2-03	Terminal P2 Function Selection (open-collector)		L1-13	Continuous Electrothermal Operation Selection	
H2-06	Watt Hour Output Unit Selection		L1-22	Leakage Current Filter Time Constant 1	
H3-01	Terminal A1 Signal Level Selection		L1-23	Leakage Current Filter Time Constant 2	
H3-02	Terminal A1 Function Selection		L2-01	Momentary Power Loss Operation Selection	
H3-03	Terminal A1 Gain Setting		L2-02	Momentary Power Loss Ride-Thru Time	
H3-04	Terminal A1 Bias Setting		L2-03	Momentary Power Loss Minimum Baseblock Time	
H3-09	Terminal A2 Signal Level Selection		L2-04	Momentary Power Loss Voltage Recovery Ramp Time	
H3-10	Terminal A2 Function Selection		L2-05	Undervoltage Detection Level (Uv)	
H3-11	Terminal A2 Gain Setting		L2-06	KEB Deceleration Time	
H3-12	Frequency Reference (Current) Terminal A2 Input Bias		L2-07	Momentary Power Loss Ride-Thru Time	
H3-13	Analog Input Filter Time Constant		L2-08	Minimum Frequency Gain at KEB Start	
H3-14	Analog Input Terminal Enable Selection		L2-11	Desired DC Bus Voltage During KEB	
H3-16	Terminal A1 Offset		L3-01	Stall Prevention Selection during Acceleration	
H3-17	Terminal A2 Offset		L3-02	Stall Prevention Level during Acceleration	
H4-01	Multi-Function Analog Output (Terminal AM Monitor Selection)		L3-03	Stall Prevention Limit during Acceleration	
H4-02	Multi-Function Analog Output (Terminal AM Output Gain)		L3-04	Stall Prevention Selection during Deceleration	
H4-03	Multi-Function Analog Output (Terminal AM Output Bias)		L3-05	Stall Prevention Selection during Run	
H5-01	Drive Node Address		L3-06	Stall Prevention Level during Run	
H5-02	Communication Speed Selection		L3-11	ov Suppression Function Selection	
H5-03	Communication Parity Selection		L3-17	Overvoltage Suppression and Deceleration Stall (Desired DC Bus Voltage during Motor Stall)	
H5-04	Stopping Method After Communication Error		L3-20	Main Power Circuit Voltage Adjustment Gain	
H5-05	Communication Fault Detection Selection		L3-21	Accel/Decel Rate Calculation Gain	
H5-06	Drive Transmit Wait Time		L3-22	Deceleration Time at Stall Prevention during Acceleration	
H5-07	RTS Control Selection		L3-23	Automatic Reduction Selection for Stall Prevention during Run	
H5-09	CE Detection Time		L3-24	Motor Acceleration Time for Inertia Calculations	
H5-10	Unit Selection for MEMOBUS/Modbus Register 0025H		L3-25	Load Inertia Ratio	
H5-11	Communications ENTER Function Selection		L4-01	Speed Agreement Detection Level	
H5-12	Run Command Method Selection		L4-02	Speed Agreement Detection Width	
H6-01	(Terminal RP) Pulse Train Input Function Selection		L4-03	Speed Agreement Detection Level (+/-)	
H6-02	Pulse Train Input Scaling		L4-04	Speed Agreement Detection Width (+/-)	
H6-03	Pulse Train Input Gain		L4-05	Frequency Reference Loss Detection Selection	
H6-04	Pulse Train Input Bias		L4-06	Frequency Reference at Reference Loss	
			L4-07	Frequency Detection Conditions	
			L4-08	Speed Agreement Detection Conditions	

No.	Name	User Setting	No.	Name	User Setting
L5-01	Number of Auto Restart Attempts		n3-01	High-Slip Braking Deceleration Frequency Width	
L5-02	Auto Restart Operation Selection		n3-02	High-Slip Braking Current Limit	
L5-04	Fault Reset Interval Time		n3-03	High-Slip Braking Dwell Time at Stop	
L5-05	Fault Reset Operation Selection		n3-04	High-Slip Braking Overload Time	
L6-01	Torque Detection Selection 1		n3-13	Overexcitation Deceleration Gain	
L6-02	Torque Detection Level 1		n3-21	High-Slip Suppression Current Level	
L6-03	Torque Detection Time 1		n3-23	Overexcitation Operation Selection	
L6-04	Torque Detection Selection 2		n6-01	Line-to-Line Motor Resistance Online Tuning	
L6-05	Torque Detection Level 2		n8-45	Speed Feedback Detection Control Gain	
L6-06	Torque Detection Time 2		n8-47	Pull-In Current Compensation Time Constant	
L6-08	Mechanical Weakening Detection Operation		n8-48	Pull-In Current	
L6-09	Mechanical Weakening Detection Speed Level		n8-49	Load Current	
L6-10	Mechanical Weakening Detection Time		n8-51	Acceleration Time Pull-In Current	
L6-11	Mechanical Weakening Detection Start Time		n8-54	Voltage Error Compensation Time Constant	
L7-01	Forward Torque Limit		n8-55	Load Inertia	
L7-02	Reverse Torque Limit		n8-62	Output Voltage Limit	
L7-03	Forward Regenerative Torque Limit		n8-63	Output Voltage Limit Gain 1	
L7-04	Reverse Regenerative Torque Limit		n8-65	Speed Feedback Detection Control Gain during ov Suppression	
L7-06	Torque Limit Integral Time Constant		n8-68	Output Voltage Limit Gain 2	
L7-07	Torque Limit Control Method Selection during Accel/Decel		n8-87	Output Voltage Limit Selection	
L8-01	Internal Dynamic Braking Resistor Protection Selection (ERF type)		n8-88	Output Voltage Limit Switching Current Level	
L8-02	Overheat Alarm Level		n8-89	Output Voltage Limit Switching Current Hysteresis Width	
L8-03	Overheat Pre-Alarm Operation Selection		n8-90	Output Voltage Limit Switching Speed	
L8-05	Input Phase Loss Protection Selection		n8-91	Id Limit for Output Voltage Limit Control	
L8-07	Output Phase Loss Protection Selection		o1-01	Drive Mode Unit Monitor Selection	
L8-09	Output Ground Fault Detection Selection		o1-02	User Monitor Selection After Power Up	
L8-10	Heatsink Cooling Fan Operation Selection		o1-03	Digital Operator Display Selection	
L8-11	Heatsink Cooling Fan Operation Delay Time		o1-05	LCD Contrast Control	
L8-12	Ambient Temperature Setting		o1-10	Frequency Reference Setting and User-Set Display	
L8-15	oL2 Characteristics Selection at Low Speeds		o1-11	Frequency Reference Setting/Decimal Display	
L8-18	Soft Current Limit Selection		o2-01	LOCAL/REMOTE Key Function Selection	
L8-19	Frequency Reduction Rate during oH Pre-Alarm		o2-02	STOP Key Function Selection	
L8-29	Current Unbalance Detection (LF2)		o2-03	User Parameter Default Value	
L8-35	Side-by-Side Selection		o2-04	Drive/kVA Selection	
L8-38	Carrier Frequency Reduction		o2-05	Frequency Reference Setting Method Selection	
L8-41	Current Alarm Selection		o2-06	Operation Selection when Digital Operator is Disconnected	
L8-51	STo Fault Detection Level		o2-07	Motor Direction at Power Up when Using Operator	
L8-54	STo Deviation Detection		o4-01	Accumulated Operation Time Setting	
n1-01	Hunting Prevention Selection		o4-02	Accumulated Operation Time Selection	
n1-02	Hunting Prevention Gain Setting		o4-03	Cooling Fan Maintenance Setting (Operation Time)	
n1-03	Hunting Prevention Time Constant		o4-05	Capacitor Maintenance Setting	
n1-05	Hunting Prevention Gain while in Reverse		o4-07	DC Bus Pre-Charge Relay Maintenance Setting	
n2-01	Speed Feedback Detection Control (AFR) Gain		o4-09	IGBT Maintenance Setting	
n2-02	Speed Feedback Detection Control (AFR) Time Constant		o4-11	U2, U3 Initialization	
n2-03	Speed Feedback Detection Control (AFR) Time Constant 2				

E.3 User Setting Table

No.	Name	User Setting
o4-12	kWh Monitor Initial Value Selection	
o4-13	Motor r/min Reset	
r1-01	DWEZ Connection Parameter 1 (upr.)	
r1-02	DWEZ Connection Parameter 1 (lwr.)	
r1-03	DWEZ Connection Parameter 2 (upr.)	
r1-04	DWEZ Connection Parameter 2 (lwr.)	
r1-05	DWEZ Connection Parameter 3 (upr.)	
r1-06	DWEZ Connection Parameter 3 (lwr.)	
r1-07	DWEZ Connection Parameter 4 (upr.)	
r1-08	DWEZ Connection Parameter 4 (lwr.)	
r1-09	DWEZ Connection Parameter 5 (upr.)	
r1-10	DWEZ Connection Parameter 5 (lwr.)	
r1-11	DWEZ Connection Parameter 6 (upr.)	
r1-12	DWEZ Connection Parameter 6 (lwr.)	
r1-13	DWEZ Connection Parameter 7 (upr.)	
r1-14	DWEZ Connection Parameter 7 (lwr.)	
r1-15	DWEZ Connection Parameter 8 (upr.)	
r1-16	DWEZ Connection Parameter 8 (lwr.)	
r1-17	DWEZ Connection Parameter 9 (upr.)	
r1-18	DWEZ Connection Parameter 9 (lwr.)	
r1-19	DWEZ Connection Parameter 10 (upr.)	
r1-20	DWEZ Connection Parameter 10 (lwr.)	
r1-21	DWEZ Connection Parameter 11 (upr.)	
r1-22	DWEZ Connection Parameter 11 (lwr.)	
r1-23	DWEZ Connection Parameter 12 (upr.)	
r1-24	DWEZ Connection Parameter 12 (lwr.)	
r1-25	DWEZ Connection Parameter 13 (upr.)	
r1-26	DWEZ Connection Parameter 13 (lwr.)	
r1-27	DWEZ Connection Parameter 14 (upr.)	
r1-28	DWEZ Connection Parameter 14 (lwr.)	
r1-29	DWEZ Connection Parameter 15 (upr.)	
r1-30	DWEZ Connection Parameter 15 (lwr.)	
r1-31	DWEZ Connection Parameter 16 (upr.)	
r1-32	DWEZ Connection Parameter 16 (lwr.)	
r1-33	DWEZ Connection Parameter 17 (upr.)	
r1-34	DWEZ Connection Parameter 17 (lwr.)	

No.	Name	User Setting
r1-35	DWEZ Connection Parameter 18 (upr.)	
r1-36	DWEZ Connection Parameter 18 (lwr.)	
r1-37	DWEZ Connection Parameter 19 (upr.)	
r1-38	DWEZ Connection Parameter 19 (lwr.)	
r1-39	DWEZ Connection Parameter 20 (upr.)	
r1-40	DWEZ Connection Parameter 20 (lwr.)	
T1-00	Motor Selection 1/2	
T1-01	Auto-Tuning Mode Selection	
T1-02	Motor Rated Power	
T1-03	Motor Rated Voltage	
T1-04	Motor Rated Current	
T1-05	Motor Base Frequency	
T1-06	Number of Motor Poles	
T1-07	Motor Base Speed	
T1-11	Motor Iron Loss	
U6-80	Option Monitor 1	
U6-81	Option Monitor 2	
U6-82	Option Monitor 3	
U6-83	Option Monitor 4	
U6-84	Option Monitor 5	
U6-85	Option Monitor 6	
U6-86	Option Monitor 7	
U6-87	Option Monitor 8	
U6-88	Option Monitor 9	
U6-89	Option Monitor 10	
U6-90	Option Monitor 11	
U6-91	Option Monitor 12	
U6-92	Option Monitor 13	
U6-93	Option Monitor 14	
U6-94	Option Monitor 15	
U6-95	Option Monitor 16	
U6-96	Option Monitor 17	
U6-97	Option Monitor 18	
U6-98	Option Monitor 19	
U6-99	Option Monitor 20	

Index

Symbols

(Terminal MP) Pulse Train Monitor Selection	383
(Terminal RP) Pulse Train Input Function Selection	383

Numerics

10th Most Recent Fault	401
2nd Most Recent Fault	401
3rd Most Recent Fault	401
3-Wire Sequence	376
3-Wire Sequence Example	52
4th Most Recent Fault	401
5th Most Recent Fault	401
6th Most Recent Fault	401
7th Most Recent Fault	401
8th Most Recent Fault	401
9th Most Recent Fault	401

A

A/D Conversion Error	264, 268, 269
A1-00	355
A1-01	110, 355
A1-02	302, 304, 306, 355
A1-03	110, 355
A1-04	110, 300, 355
A1-05	110, 300, 355
A1-06	356
A1 Initialization Parameters	355
A2-01	110
A2-01 to A2-32	356
A2-32	110
A2-33	110, 356
A2 User Parameters	356
Accel/Decel Ramp Hold	376
Accel/Decel Rate Frequency	362
Accel/Decel Time	262
Accel/Decel Time 1	376
Accel/Decel Time Selection 2	377
Accel/Decel Time Setting Units	361
Accel/Decel Time Switching Frequency	362
Acceleration Error	266, 296
Acceleration Time 1	361
Acceleration Time 2	361
Acceleration Time 3 (Motor 2 Accel Time 1)	361
Acceleration Time 4	361
Acceleration Time Pull-In Current	393
Access Level Selection	110, 355
Accumulated Operation Time	402

Accumulated Operation Time Selection	395
Accumulated Operation Time Setting	395
AFR Gain	261
AFR Time Constant 1	261
AFR Time Constant 2	261
Alarm	266
Alarm Causes and Solutions	17
Alarm Displays	17
Alarm Outputs for Maintenance Monitors	315
Alarms and Errors	187
Allowable Frequency Fluctuation	343, 344, 345, 346
Allowable Voltage Fluctuation	343, 344, 345, 346
Altitude Derating	38
Ambient Temperature Setting	390
Analog Filter Time Constant	262
Analog Frequency Reference Fluctuation Limit (Up/Down 2)	366
Analog Input Filter Time Constant	381
Application Precautions	18
Application Selection	356
Applications with Specialized Motors	21
ASR Integral Time 1 (for Simple PG V/f Control)	363
ASR Integral Time 2 (for Simple PG V/f Control)	363
ASR Limit (for Simple PG V/f Control)	363
ASR Proportional Gain 1 (for Simple PG V/f Control)	363
ASR Proportional Gain 2 (for Simple PG V/f Control)	363
Automatic Reduction Selection for Stall Prevention during Run ...	387
Auto Restart Operation Selection	387
Auto-Tuning	16, 102, 103, 105, 106, 253
Auto-Tuning Fault Codes	103
Auto-Tuning for V/f Control	102
Auto-Tuning Mode Selection	398
Auxiliary Frequency Reference 1	381

B

b1-01	301, 356
b1-02	300, 356
b1-04	302, 308, 357
b1-07	357
b1-08	357
b1-14	357
b1-15	357
b1-16	357
b1-17	357
b1 Operation Mode Selection	356
b2-01	357
b2-02	305, 306, 357
b2-03	307, 357

b2-04.....	306, 357	Braking Resistor Fault	379
b2-08.....	357	Braking Resistor Overheat	278
b2-12.....	357	bUS	264, 265, 267, 282
b2-13.....	358	Buzzing Sound from Motor at 2 kHz	307
b2 DC Injection Braking.....	357	C	
b3-01.....	307, 358	C1-01	88, 308
b3-02.....	358	C1-02	267
b3-03.....	358	C1-09	361
b3-05.....	358	C1-10	361
b3-06.....	358	C1-11	362
b3-10.....	358	C1-14	362
b3-14.....	358	C1 Acceleration and Deceleration Times.....	361
b3-17.....	358	C2-01	362
b3-18.....	358	C2-01 through C2-04.....	262
b3-19.....	358	C2-02	362
b3-24.....	358	C2-03	362
b3-25.....	358	C2-04	362
b3-29.....	358	C2 S-Curve Characteristics.....	362
b3 Speed Search.....	358	C3-01	260, 261
b4-01.....	358	C3-02	261, 306, 362
b4-02.....	358	C3-03	304, 362
b4 Timer Function.....	358	C3-04	362
b5-01.....	308	C3-05	362
b5-09.....	306, 359	C3-16	362
b5-10.....	359	C3 Slip Compensation	362
b5-11.....	359	C4-01	260, 301
b5-12.....	359	C4-02	260, 261, 306, 307, 363
b5-13.....	359	C4-03	363
b5-14.....	359	C4-05	363
b5-15.....	359	C4-06	261
b5-16.....	359	C4 Torque Compensation.....	362
b5-17.....	359	C5 Speed Control (ASR)	363
b5-18.....	359	C6-01	260
b5-19.....	360	C6-02	74, 260, 261, 305, 308, 363
b5-20.....	360	C6-03	364
b5-36.....	360	C6-04	364
b5-37.....	360	C6-05	305, 364
b5-38.....	360	C6 Carrier Frequency	363
b5-39.....	360	Cable Length Between Drive and Motor	61
b5-40.....	360	CALL.....	265, 282
b5-47.....	360	Cannot Change Parameter Settings.....	300
b5 PID Control.....	358	Can Not Reset	265, 283
b6-01.....	360	Capacitor Maintenance.....	402
b6-01 through b6-04.....	262	Capacitor Maintenance Alarm	265
b6-02.....	360	Capacitor Maintenance Setting	395
b6-03.....	360	Capacitor Maintenance Time.....	286
b6-04.....	360	Carrier Frequency Lower Limit.....	364
b6 Dwell Function.....	360	Carrier Frequency Proportional Gain	364
b8-04.....	360	Carrier Frequency Reduction.....	390
b8-05.....	361	Carrier Frequency Reduction Time	391
b8-06.....	361	Carrier Frequency Selection.....	260, 261, 363
b8 Energy Saving.....	360	Carrier Frequency Setting Error	266, 294
Baseblock	282	Carrier Frequency Upper Limit	364
Baseblock Command (N.C.)	376	CE.....	264, 265, 267, 283
Baseblock Command (N.O.)	376	CE Detection Time	383
Baseblock Signal Input.....	265	CF	264, 267
bb.....	265, 282	clock error	269
Bi-Directional Speed Search Selection	358	Clock Fault	264, 269
Braking Resistor	72	Closed-Loop Crimp Terminal Sizes.....	477
Braking Resistor, Installation	72		

CoF	264, 267	Current Imbalance	264
Communication Fault Detection Selection	383	Current Offset Fault	264, 267
Communication Parity Selection	382	Current Unbalance Detection (LF2)	390
Communications ENTER Function Selection	383	CyC	265
Communication Speed Selection	382	D	
Communications Test Mode	378	d1 Frequency Reference	364
Connected Machinery Vibrates When Motor Rotates	305	d2-01	307, 365
Control Circuit Connection Diagram	63	d2-02	365
Control Circuit Fault	264, 269	d2-03	365
Control Circuit Input Terminals	64	d2 Frequency Upper and Lower Limits	365
Control Circuit Output Terminals	64	d3-01	305, 365
Control Circuit Terminal Block Configuration	65	d3-01 through d3-04	262
Control Circuit Terminal Block Functions	28	d3-02	365
Control Fault	264, 267	d3-03	365
Control Method Selection	355	d3-04	305, 365
Control Mode	399	d3 Jump Frequency	365
Control Power Supply Undervoltage	264	d4-01	366
Cooling Fan Maintenance Alarm	265	d4-03	366
Cooling Fan Maintenance Setting (Operation Time)	395	d4-04	366
Cooling Fan Maintenance Time	286	d4-05	366
Cooling Fan Operation Time	402	d4-06	366
Cooling Fan Replacement	287	d4-07	366
Copy Allowed Selection	395	d4-08	366
Copy Function Selection	395	d4-09	366
CPF02	268	d4-10	366
CPF03	268	d4 Frequency Reference Hold	365
CPF06	268	d7-01	366
CPF07	268	d7-02	366
CPF08	268	d7-03	366
CPF11	268	d7 Offset Frequency	366
CPF12	268	d-Axis ACR Output	404
CPF13	269	d Axis Current for High-Efficiency Control	393
CPF14	269	DC Bus Pre-Charge Relay Maintenance Setting	395
CPF17	269	DC Bus Undervoltage	280, 379
CPF18	269	DC Bus Voltage	399
CPF19	269	DC Bus Voltage at Previous Fault	401
CPF20	269	DC Injection Braking	305
CPF21	269	DC Injection Braking at start	307
CPF22	264, 269	DC Injection Braking at Stop	306
CPF23	264, 269	DC Injection Braking Command	378
CPF24	264, 270	DC Injection Braking Current	306, 357
CPF25	264, 270	DC Injection Braking Start Frequency	357
CrST	265, 283	DC Injection Braking Time/DC Excitation Time at Start	357
CSA Standards	479	Deceleration Rate Calculation Gain	386
C Tuning	361	Deceleration Time 1	361
Cumulative Operation Time at 10th Most Recent Fault	402	Deceleration Time 2	361
Cumulative Operation Time at 2nd Most Recent Fault	402	Deceleration Time 3 (Motor 2 Decel Time 1)	361
Cumulative Operation Time at 3rd Most Recent Fault	402	Deceleration Time 4	361
Cumulative Operation Time at 4th Most Recent Fault	402	Deceleration Time at Stall Prevention during Acceleration	386
Cumulative Operation Time at 5th Most Recent Fault	402	Derivative Time	359
Cumulative Operation Time at 6th Most Recent Fault	402	Desired DC Bus Voltage during KEB	385
Cumulative Operation Time at 7th Most Recent Fault	402	dEv	264, 265, 270, 283
Cumulative Operation Time at 8th Most Recent Fault	402	Differential PID Feedback	382
Cumulative Operation Time at 9th Most Recent Fault	402	Digital Operator Display Selection	394
Cumulative Operation Time at Most Recent Fault	401	DIP Switch S1	70
Cumulative Operation Time at Previous Fault	401	dnE	265, 284
Current Alarm	265, 285	Down 2 Command	378
Current Alarm Selection	391	Down Command	377
Current Detection Error	266, 296	d References	364
Current Fault	400		

Index

Drive/kVA Selection	395	E2-11	368
Drive Baseblock	265	E2-12	368
Drive Capacity Setting Fault	291	E2 Motor Parameters	367
Drive Capacity Signal Fault	264	E3-01	368
Drive Cooling Fans	313	E3 Motor 2 V/f Characteristics	368
Drive Disabled	265, 284	E4-01	369
Drive Does Not Allow Selection of Rotational Auto-Tuning	302	E4-02	369
Drive Enable	378, 380	E4-03	369
Drive Message ID	400	E4-04	369
Drive Mode	84, 85, 86	E4-05	369
Drive Models and Types	40	E4-06	369
Drive Mode Unit Monitor Selection	394	E4-07	369
Drive Motor Overload Protection	479	E4-08	369
Drive Node Address	382	E4-09	369
Drive Operation Status at Previous Fault	401	E4-10	369
Drive Overheat	265	E4-11	369
Drive Overheat Alarm (oH2)	376	E4-12	370
Drive Overheat Warning	287	E4-15	370
Drive Overload	264, 275	E4 Motor 2 Parameters	369
Drive Ready	379	E5	265, 284
Drive Short-Circuit Rating	479	E5-01	307, 370
Drive Status	400	E5-02	370
Drive Transmit Wait Time	383	E5-03	370
Drive Unit Setting Error	266	E5-04	370
Drive Watt Loss Data	350	E5-05	370
DriveWorksEZ Connection Parameters	396	E5-06	370
During Baseblock	379	E5-07	370
During Fast-stop	380	E5-09	370
During Run	379	E5-24	370
During Run 2, Motor Switch Command Input	265	E5 PM Motor Parameters	370
During Torque Limit	380	EEPROM Data Error	268
dWAL	265, 270	EEPROM Serial Communication Fault	268
Dwell Frequency at Stop	360	EEPROM Write Error	271
Dwell Function	262	EF	265, 284
Dwell Reference at Start	360	EF0	265, 270, 284
Dwell Time at Start	360	EF1	270, 284
Dwell Time at Stop	360	EF1 to EF7	265
dWFL	270	EF2	270, 284
Dynamic Braking Resistor	264	EF3	270, 284
Dynamic Braking Transistor	264, 279	EF4	271, 284
E		EF5	271, 284
E1-03	301, 303, 367, 408	EF6	271, 284
E1-04	303, 305, 307, 308, 408	EF7	271, 284
E1-06	305, 408	End1	266, 295
E1-07	408	End2	266, 295
E1-08	260, 262, 301	End3	266, 295
E1-09	301, 307, 308, 408	Energy Saving Coefficient Value	360
E1-10	260, 262, 301, 305	Energy Saving Control Filter Time Constant	360
E1 V/f Pattern Characteristics	367	Energy Saving Control Selection	360
E2-01	260, 367	Energy Saving Gain	360
E2-02	260, 367	Er-01	266, 295
E2-03	260, 368	Er-02	266, 295
E2-04	368	Er-03	266, 296
E2-05	368	Er-04	266, 296
E2-06	368	Er-05	266, 296
E2-07	368	Er-08	266, 296
E2-08	368	Er-09	266, 296
E2-09	368	Er-11	266, 296
E2-10	368	Er-12	266, 296
		Err	271

European Standards	466	Fast-stop (N.C.)	377
Excessive Motor Oscillation and Erratic Rotation	305	Fast-Stop (N.O.)	377
Excessive PID Feedback	264, 265, 271, 285	Fast-stop Time	361
Excessive Speed Deviation (for Simple V/f with PG)	264, 265	Fault	379
Excessive V/f Setting	266, 295	Fault Causes and Solutions	267
External Digital Operator Connection Fault	277	Fault Detection	267
External Fault (user selection possible)	377	Fault Displays	267
External Search Command 1	378	Fault History	298
External Search Command 2	378	Fault Reset	377
F		Fault Reset Example	263
F1-02	371	Fault Reset Interval Time	387
F1-03	371	Fault Reset Operation Selection	387
F1-04	371	Faults	263, 264
F1-08	371	Fault Trace Example	298
F1-09	371	FbH	264, 265, 271, 285
F1-10	372	FbL	264, 265, 271, 285
F1-11	372	Feedback Detection Control Time Constant 2	302
F1-14	372	FLASH memory error	269
F1 Simple PG V/f Parameters	371	FLASH Memory Fault	264, 268
F1 V/f Control with Simple PG Feedback - PG Setup Parameters	371	Forward/Reverse Run Command Input Error	284
F6-01	372	Forward Jog	377
F6-02	372	Forward Regenerative Torque Limit	389
F6-03	284, 372	Forward Run Command (2-Wire sequence)	377
F6-04	372	Forward Torque Limit	389
F6-07	372	Fref/Fout Agree 1	379
F6-08	372	Fref/Fout Agree 2	379
F6-10	372	Fref/Fset Agree 1	379
F6-11	372	Fref/Fset Agree 2	379
F6-14	372	Frequency (FOUT) Detection 1	379
F6-20	372	Frequency (FOUT) Detection 2	379
F6-21	372	Frequency Bias (A1)	381
F6-22	372	Frequency Detection 3	379
F6-23	372	Frequency Detection 4	379
F6-24	372	Frequency Gain	381
F6-25	373	Frequency Reduction Rate during oH Pre-Alarm	390
F6-26	373	Frequency Reference	399
F6-30	373	Frequency Reference 1	364
F6-31	373	Frequency Reference 10	365
F6-32	373	Frequency Reference 11	365
F6-35	373	Frequency Reference 12	365
F6-36	373	Frequency Reference 13	365
F6-40	373	Frequency Reference 14	365
F6-41	373	Frequency Reference 15	365
F6-50	373	Frequency Reference 16	365
F6-51	373	Frequency Reference 2	305, 364
F6-52	373	Frequency Reference 3	364
F6-53	373	Frequency Reference 4	364
F6-54	373	Frequency Reference 5	364
F6-55	373	Frequency Reference 6	364
F6-56	373	Frequency Reference 7	365
F6-57	373	Frequency Reference 8	365
F6-58	373	Frequency Reference 9	365
F6-59	373	Frequency Reference Accel/Decel (Up/Down 2)	366
F6-60	374	Frequency Reference at Previous Fault	401
F6-61	374	Frequency Reference at Reference Loss	387
F6-62	374	Frequency Reference Bias (Up/Down 2)	366, 404
F6-63	374	Frequency Reference Bias Operation Mode Selection (Up/Down 2)	366
F6 EtherNet/IP and Modbus TCP/IP Option Parameters	374	Frequency Reference Bias Step (Up/Down 2)	366
F6 Serial Communications Option Card Setting	372	Frequency Reference Hold Function Selection	366
		Frequency Reference Loss Detection Selection	387

Index

Frequency Reference Lower Limit (Up/Down 2)	366	H5-01	382
Frequency Reference Monitor Content during PID	360	H5-02	382
Frequency Reference Selection	356	H5-03	382
Frequency Reference Selection 1	301	H5-04	383
Frequency Reference Selection 2	357	H5-05	383
Frequency Reference Setting / Decimal Display	394	H5-06	383
Frequency Reference Setting and User-Set Display	394	H5-07	383
Frequency Reference Setting Method Selection	395	H5-09	383
Frequency Reference Upper Limit	365	H5-10	383
Frequency Reference Upper Limit (Up/Down 2)	366	H5-11	383
Frequency Reference Wiring	67	H5-12	383
Fuse (CE)	466, 468	H5 MEMOBUS/Modbus Communications	382
Fuse Holder (CE)	468	H6-01	383
Fuse Selection	466	H6-02	383
FWD/REV Command (2-wire sequence 2)	377	H6-03	383
FWD/REV Torque Limit	382	H6-04	383
FWD Torque Limit	382	H6-05	383
G			
General Safety Information	13	H6-06	383
GF	264, 271	H6-07	383
Ground Fault	264, 271	H6 Pulse Train Input/Output	383
Ground Fault Interrupter Activates When Drive is Running	308	Hbb	265, 285
Ground Wiring	62	HbbF	265, 285
H			
H1-01	376	HCA	265, 285
H1-02	376	Heatsink Cooling Fan Operation Delay Time	390
H1-03	376	Heatsink Cooling Fan Operation Selection	390
H1-04	376	Heatsink Overheat	264, 265, 274, 286
H1-05	52, 376	Heavy Duty Ratings	155
H1-06	376	High Slip Braking	378
H1-07	376	High-Slip Braking Current Limit	392
H1 Multi-Function Digital Input	376	High-Slip Braking Deceleration Frequency Width	392
H1 Multi-Function Digital Input Selections	376	High-Slip Braking Dwell Time at Stop	392
H2-01	305, 378	High Slip Braking oL	264
H2-01 to H2-03	282	High-slip Braking oL	276
H2-02	378	High-Slip Braking Overload Time	392
H2-03	378	High-Slip Suppression Current Level	392
H2-06	379	Hunting Prevention Gain	260
H2 Multi-Function Digital Outputs	378	Hunting Prevention Gain Setting	306, 392
H2 Multi-Function Digital Output Settings	379	Hunting Prevention Gain while in Reverse	392
H3-01	381	Hunting Prevention Selection	391
H3-02	303, 304, 306, 381	Hunting Prevention Time Constant	392
H3-03	381	Hunting Prevention Time Constant Setting	306
H3-04	381	I	
H3-09	70, 381	I/O Connections	50
H3-09 Details	70	Id Limit for Output Voltage Limit Control	393
H3-10	303, 304, 306, 381	IGBT Maintenance	402
H3-11	306, 381	IGBT Maintenance Setting	395
H3-12	381	IGBT Maintenance Time (50%)	265, 286
H3-13	262, 306, 381	IGBT Maintenance Time (90%)	289
H3-14	381	IGBT Short Circuit	264
H3-16	381	Initialize Parameters	355
H3-17	381	Initial Operation	90
H3 Analog Inputs	381	Input Current (A)	343, 344, 345, 346
H3 Multi-Function Analog Input Settings	381	Input Fuses	466
H4-01	382	Input Phase Loss	264, 278
H4-03	382	Input Pulse Monitor	400
H4 Multi-Function Analog Outputs	382	Input Terminals	89
		Input Terminal Status at Previous Fault	401
		Inrush Prevention Circuit Fault	280
		Inspection	312, 313

Installation Environment	38	L3-20	386
Installation Orientation	38	L3-21	386
Installation Spacing	39	L3-22	386
Installing Multiple Drives	39	L3-23	387
Integral Limit Setting	359	L3-24	387
Integral Time Setting (I)	359	L3-25	387
Internal Dynamic Braking Resistor Protection	73	L3 Stall Prevention Function	385
Internal Dynamic Braking Resistor Protection Selection (ERF type) ...	389	L4-01	305, 387
J		L4-02	305, 387
Jog Frequency Reference	365	L4-03	387
Jog Reference Selection	376	L4-04	387
Jump Frequency	262	L4-05	387
Jump Frequency 1	365	L4-06	387
Jump Frequency 2	365	L4-07	387
Jump Frequency 3	365	L4-08	387
Jump Frequency Width	365	L4 Frequency Detection	387
K		L5-01	387
KEB Acceleration Time	385	L5-02	387
KEB Deceleration Time	385	L5-04	387
KEB Operation	380	L5-05	387
KEB Ride-Thru (N.C.)	378	L5 Fault Reset	387
KEB Ride-Thru (N.O.)	378	L6-01	388
KEB Ride-Thru 2 (N.C.)	378	L6-02	388
KEB Ride-Thru 2 (N.O.)	378	L6-03	287, 388
KEB Start Output Frequency Reduction	385	L6-04	388
kWh, Lower 4 Digits	402	L6-05	388
kWh, Upper 5 Digits	402	L6-06	388
kWh Monitor Initialization	396	L6-08	389
L		L6-09	389
L1-01	384, 480	L6-10	389
L1-02	384, 480	L6-11	389
L1-03	384	L6 Overtorque Detection	387
L1-04	384	L7-01	389
L1-05	384	L7-01 through L3-04	262
L1-13	384	L7-01 through L7-04	267, 301, 303, 304
L1-22	384	L7-02	389
L1-23	384	L7-03	389
L1 Motor Protection Functions	384	L7-04	389
L2-01	385	L7-06	389
L2-02	385	L7-07	389
L2-03	385	L7 Torque Limit	389
L2-04	385	L8: Hardware Protection	389
L2-05	385	L8-01	73, 389
L2-06	385	L8-02	389
L2-07	385	L8-03	390
L2-08	385	L8-09	390
L2-11	385	L8-10	390
L2 Momentary Power Loss	384	L8-11	390
L3-01	385	L8-12	390
L3-01 through L3-06	262	L8-15	390
L3-02	303, 307, 385	L8-18	390
L3-03	385	L8-19	390
L3-04	73, 304, 386	L8-29	390
L3-05	386	L8-35	390
L3-06	262, 303, 386	L8-38	307, 390
L3-07	262	L8-40	391
L3-11	262, 386	L8-41	391
L3-17	386	L8-51	391
		L8-54	391
		Language Selection	355

LED Check	402	Minor Fault	295
LED Operator	28, 80, 81	Minor Faults	263, 264
LF	264, 272	Modes	84
LF2	264, 272	Momentary Power Loss Minimum Baseblock Time	385
Line-to-Line Motor Resistance Online Tuning	392	Momentary Power Loss Operation Selection	385
Line-to-Line Resistance Auto-Tuning	301	Momentary Power Loss Ride-Thru Time	385
Line-to-Line Resistance Error	266, 296	Momentary Power Loss Voltage Recovery Ramp Time	385
LO/RE	82, 89, 108	Monitor Output	64
Load Falls When Brake is Applied	305	Most Recent Fault	401
Load Inertia	393	Motor 2 Iron-Core Saturation Coefficient 3	370
Load Inertia Ratio	387	Motor 2 Iron Loss	369
LOCAL	88	Motor 2 Leakage Inductance	369
LOCAL/REMOTE Key Function Selection	394	Motor 2 Line-to-Line Resistance	369
Local/Remote Run Selection	357	Motor 2 Mechanical Loss	369
Local/Remote Selection	376	Motor 2 Motor Iron-Core Saturation Coefficient 1	369
Loss of Reference	379	Motor 2 Motor Iron-Core Saturation Coefficient 2	369
Low Voltage Directive	466	Motor 2 Motor Poles	369
Low Voltage Wiring for Control Circuit Terminals	479	Motor 2 Rated Capacity	369
L Protection Function	384	Motor 2 Rated Current	369
LT-1	265, 286	Motor 2 Rated No-Load Current	369
LT-2	265, 286	Motor 2 Rated Slip	369
LT-3	265, 286	Motor 2 Selection	377, 380
LT-4	265, 286	Motor 2 Torque Compensation Gain	370
M		Motor Acceleration Time for Inertia Calculations	387
Magnetic Flux Compensation Capacity	357	Motor Base Frequency	105, 398
Magnetic Flux Compensation Value	357	Motor Base Speed	105, 398
Main Circuit Connection Diagram	53, 62	Motor Data Error	266, 295
Main Circuit Terminal Functions	58	Motor d-Axis Current at Previous Fault	401
Main Circuit Terminal Power Supply	61	Motor d Axis Inductance (for PM motor)	370
Main Circuit Terminals Connection	53	Motor Direction at Power Up when Using Operator	395
Main Circuit Terminal Wiring	34, 474	Motor Does Not Operate When an External Run Command is Input	307
Main Frequency Reference	70	Motor Does Not Operate When Pressing RUN on Digital Operator	307
Main Frequency Reference Input	64	Motor Does Not Rotate	300
Main Power Circuit Voltage Adjustment Gain	386	Motor Excitation Current (Id)	404
Maintenance	315	Motor Hunting and Oscillation Control Parameters	262
Maintenance Alarms	315	Motor Hunting Occurs at Low Speeds	302
Master Speed Reference Lower Limit	365	Motor Hunting Occurs When Operating With a Light Load	305
Maximum Motor Size Allowed (kW)	343, 344, 345, 346	Motor Induction Voltage Constant 1 (for PM motor)	370
Mechanical Weakening (N.O.)	380	Motor Induction Voltage Constant 2 (for PM motor)	370
Mechanical Weakening Detection 1	264, 265, 288	Motor Iron-Core Saturation Coefficient	295
Mechanical Weakening Detection 2	289	Motor Iron-Core Saturation Coefficient 1	368
Mechanical Weakening Detection Operation	389	Motor Iron-Core Saturation Coefficient 2	368
Mechanical Weakening Detection Speed Level	389	Motor Iron-Core Saturation Coefficient 3	368
Mechanical Weakening Detection Start Time	389	Motor Iron Core Saturation Coefficient Error	266
Mechanical Weakening Detection Time	389	Motor Iron Loss	398
MECHATROLINK Watchdog Timer Error	284	Motor Iron Loss for Torque Compensation	368
MEMOBUS/Modbus Communication Error	264, 265, 267, 283	Motor is Too Hot	302
MEMOBUS/Modbus Communications Reference	403	Motor Leakage Inductance	368
MEMOBUS/Modbus Communications Test Mode Complete	288	Motor Line-to-Line Resistance	368
MEMOBUS/Modbus Communications Test Mode Error	289	Motor Mechanical Loss	368
MEMOBUS/Modbus Error Code	400	Motor No-Load Current	368
MEMOBUS/Modbus Switch Settings	71	Motor Operates at a Higher Speed than the Speed Command	308
MEMOBUS/Modbus Termination	34	Motor Overheat	265, 287
MEMOBUS/Modbus Test Mode Complete	265	Motor Overheat 1 (PTC input)	264
MEMOBUS/Modbus Test Mode Fault	266	Motor Overheat 2 (PTC input)	264
Mid Output Voltage A	260, 262	Motor Overheat Alarm (PTC Input)	274
Minimum Output Frequency	307, 308	Motor Overheat Alarm Operation Selection (PTC input)	384
Minimum Output Voltage	260, 262	Motor Overheat Fault (PTC Input)	275
Minor Alarms	264	Motor Overheat Fault Operation Selection (PTC input)	384
		Motor Overload	264, 275

Motor Overload Estimate (oL1)	403	n3-03	392
Motor Overload Protection Selection	384, 480	n3-04	392
Motor Overload Protection Time	215, 384, 480	n3-13	392
Motor Poles	105	n3-21	392
Motor Poles (for PM motor)	370	n3-23	392
Motor Produces Insufficient Torque	306	n3 High Slip Braking	392
Motor q-Axis Current at Previous Fault	401	n6-01	392
Motor Rated Capacity (for PM motor)	370	n6 Online Tuning of Resistance between Motor Lines	392
Motor Rated Current	105, 367, 398, 479	n8-45	307, 393
Motor Rated Current (for PM motor)	370	n8-47	307, 393
Motor Rated Output	368	n8-48	393
Motor Rated Power	398	n8-49	393
Motor Rated Slip	367	n8-51	393
Motor Rated Voltage	105, 398	n8-54	393
Motor Rotates After the Drive Output is Shut Off	306	n8-55	393
Motor Rotates Faster Than the Frequency Reference	304	n8-62	393
Motor Rotates in One Direction Only	302, 308	n8-63	393
Motor Secondary Current (Iq)	404	n8-65	393
Motor Selection 1/2	398	n8-68	393
Motor Speed	399	n8-87	393
Motor Speed at Previous Fault	401	n8-88	393
Motor Speed Error	266	n8-89	393
Motor Speed Fault	296	n8-90	393
Motor Stalls During Acceleration or With Large Loads	303	n8-91	393
Motor Stator Resistance	370	n8 Permanent Magnet (PM) Motor Control	392
Motor Stops During Acceleration or When a Load is Connected	308	n Advanced Performance Set Up	391
Motor Switch during Run	289	Node Setup	378
Motor Temperature (PTC input)	382	Node Setup Error	264, 272
Motor Temperature Input Filter Time (PTC input)	384	Noise From Drive or Output Lines When Drive is Powered On	305
Motor Wiring	61	No-Load Current Error	266, 296
Multi-Function Analog 1 (Terminal AM Monitor Selection)	382	No-Load Operation	108
Multi-Function Analog Input Selection Error	266, 292	Normal Duty Ratings	155
Multi-Function Digital Inputs	64	Notes on Motor Operation	20
Multi-Function Digital Input Terminal S1 Function Selection	376	nSE	264, 272
Multi-Function Digital Input Terminal S2 Function Selection	376	Number of Auto Restart Attempts	387
Multi-Function Digital Input Terminal S3 Function Selection	376	Number of Motor Poles	368, 398
Multi-Function Digital Input Terminal S4 Function Selection	376	Number of Run Commands	402
Multi-Function Digital Input Terminal S5 Function Selection	376	Number of Speed Search Restarts	358
Multi-Function Digital Input Terminal S6 Function Selection	376		
Multi-Function Digital Input Terminal S7 Function Selection	376	O	
Multi-Function Digital Output	64	o1-01	394
Multi-Function Input Selection Error	291	o1-02	394
Multi-Function Input Setting Error	266	o1-03	394
Multi-Function Photocoupler Output	64	o1-10	394
Multiple Drive Wiring	62	o1-11	394
Multi-Step Speed Reference	376	o1 Display Settings	394
Multi-Step Speed Reference 4	377	o2-01	300, 394
		o2-02	301, 394
		o2-03	110, 395
		o2-04	260, 395
		o2-05	395
		o2-06	395
		o2-07	395
		o2-09	395
		o2 Multi-Function Selections	394
		o3-01	395
		o3-02	395
		o4-01	395
		o4-02	395
		o4-03	395
N			
n1-01	391		
n1-02	260, 306, 392		
n1-03	392		
n1-05	392		
n1 Hunting Prevention	391		
n2-01	261, 305, 306, 392		
n2-02	261, 303, 305, 392		
n2-03	261, 302, 303, 392		
n2 Speed Feedback Detection Control Function	392		
n3-01	392		
n3-02	392		

o4-05.....	395	oPr	264, 277
o4-07.....	395	Option/Drive Selection.....	376
o4-09.....	395	Option Card Communications Error.....	265
o4-11.....	396	Option Card External Fault.....	270, 284
o4-12.....	396	Option Card Fault.....	264, 273, 274
o4-13.....	396	Option Card Fault (port A).....	273
o4 Maintenance Period.....	395	Option Card Reference.....	403
oC.....	264, 272	Option Communication Error.....	264, 267, 282
oFA00.....	264, 273	Option Frequency Reference.....	403
oFA01.....	264, 273	Option Monitors 1 to 20.....	404
oFA03.....	264, 273	Option Unit Fault.....	264
oFA04.....	264, 274	oS.....	264, 265, 277, 288
oFA30 to oFA43.....	264, 274	Oscillation or Hunting.....	306
Offset Frequency.....	404	Output Current.....	399
Offset Frequency 1.....	366	Output Current (A).....	343, 344, 345, 346
Offset Frequency 1 Addition.....	378	Output Current (kVA).....	345, 346
Offset Frequency 2.....	366	Output Current at Previous Fault.....	401
Offset Frequency 2 Addition.....	378	Output current imbalance.....	272
Offset Frequency 3.....	366	Output Frequency.....	399
Offset Frequency 3 Addition.....	378	Output Frequency after Soft Start.....	400
oH.....	264, 265, 274, 286	Output Frequency at Previous Fault.....	401
oH1.....	264, 274	Output Frequency is not as High as Frequency Reference.....	307
oH2.....	265, 287	Output Ground Fault Detection Selection.....	390
oH3.....	264, 265, 274, 287	Output of speed control (ASR) (for Simple V/f PG).....	404
oH4.....	264, 275	Output Phase Loss.....	264, 272
oH Pre alarm.....	380	Output Power.....	399
oH Pre-alarm Time Limit.....	380	Output Power at Previous Fault.....	401
oL1.....	264, 275	Output Terminal Status.....	400
oL2.....	264, 275, 307	Output Terminal Status at Previous Fault.....	401
oL2 Characteristics Selection at Low Speeds.....	390	Output Voltage at Previous Fault.....	401
oL3.....	264, 265, 276, 287	Output Voltage Bias.....	381
oL4.....	264, 265, 276, 287	Output Voltage Limit.....	393
oL5.....	264, 265, 276, 288	Output Voltage Limit Gain 1.....	393
oL7.....	264, 276	Output Voltage Limit Gain 2.....	393
o Operator Related Parameters.....	394	Output Voltage Limit Level.....	362
oPE.....	291	Output Voltage Limit Operation Selection.....	362
oPE01.....	266, 291	Output Voltage Limit Selection.....	393
oPE02.....	266, 291	Output Voltage Limit Switching Current Hysteresis Width.....	393
oPE03.....	266, 291	Output Voltage Limit Switching Current Level.....	393
oPE04.....	266, 292	Output Voltage Limit Switching Speed.....	393
oPE05.....	266, 292	Output Voltage Reference.....	399
oPE07.....	266, 292	Output Voltage Reference (Vd).....	404
oPE08.....	266, 293	Output voltage reference (Vq).....	404
oPE09.....	266, 293	ov.....	264, 265, 277, 288
oPE10.....	266, 294	Overcurrent.....	264, 272
oPE11.....	266, 294	Overexcitation Deceleration Gain.....	392
oPE13.....	266, 294	Overexcitation Operation Selection.....	392
oPE Fault Parameter.....	400	Overheat 1 (Heatsink Overheat).....	274
Open Loop Vector Control.....	262, 267, 301, 302, 303, 304, 306	Overheat Alarm Level.....	389
Open Loop Vector Control Mode Tuning.....	261	Overheat Pre-Alarm Operation Selection.....	390
Open Loop Vector Control Mode Tuning Parameters.....	261	Overload oL1 (oL1 Alarm).....	380
Operating with the Load Connected.....	109	Overload Tolerance.....	343, 344, 345, 346
Operation Errors.....	263, 266	Overspeed (for Simple V/f with PG).....	264, 265, 288
Operation Selection at Deviation (for Simple PG V/f Control).....	371	Overspeed (Simple V/f with PG).....	277
Operation Selection at Overspeed (OS) (for Simple PG V/f).....	371	Overtorque/Undertorque Detection Level.....	381
Operation Selection at PG Open Circuit (PGo).....	371	Overtorque 1.....	265, 287
Operation Selection when Digital Operator is Disconnected.....	395	Overtorque 2.....	265, 287
Operator Connection Fault.....	264	Overtorque Detection 1.....	264, 276
Operator Message ID.....	400	Overtorque Detection 2.....	264, 276
Operator Programming Errors.....	291	Overvoltage.....	264, 265, 277

Overvoltage Occurs When Running at a Constant Speed	303	Power Detection Filter Time	361
ov Occurs When Starting a Fan or Motor Speed Loss Occurs	307	Power Specifications 200 V Class Models	343, 344
ov Suppression Function Selection	386	Power Specifications 400 V Class Models	345, 346
P			
Parameter Range Setting Error	291	Previous Fault	401
Parameter Selection Error	266, 293	Program Lockout	377
Parameter Setting Range Error	266	Programming Mode	84, 86, 87
Parameter Settings	88	Proportional Gain Setting (P)	359
PASS	265, 288	Protective Covers, Reattaching	57
Password	355	Protective Covers, Removing	55, 56
Password Setting	355	Pull-In Current	393
Password Settings	110	Pull-In Current Compensation Time Constant	307, 393
Peak Hold Current	403	Pull Out Detection	279
Peak Hold Output Frequency	403	Pull-Out Detection	264
Performance Life	16	Pulse Train Input Bias	383
Peripheral Devices Affected by Drive Operation	308	Pulse Train Input Filter Time	383
Permanent Magnet Motor Control	16	Pulse Train Input Gain	383
PF	264, 278	Pulse Train Input Scaling	383
PG Disconnect (for Simple V/f with PG)	264, 265, 278, 288	Pulse Train Monitor Scaling	383
PGo	264, 265, 278, 288	PWM Data Error	268
PG Open-Circuit Detection Time (for Simple PG V/f Control)	372	PWM Feedback Data Fault	264
Phase Order Selection	357	PWM Feedback Fault	269
PID Accel/Decel Time	359	Q	
PID Control Selection Error	266	q1-01 to q6-07	396
PID Disable	377	q-axis ACR Output	404
PID Feedback	381, 404	R	
PID Feedback High Detection Level	360	RAM Fault	264, 269
PID Feedback High Level Detection Time	360	Rated Current Setting Alarm	266, 295
PID Feedback Loss	264, 265, 271, 285, 380	Rated Frequency	343, 344, 345, 346
PID Feedback Loss Detection Level	359	Rated Output Capacity (kVA)	343, 344
PID Feedback Loss Detection Time	359	Rated Slip Error	266, 296
PID Feedback Reference Missing Detection Selection	359	Rated Voltage	343, 344, 345, 346
PID Function Setting	359	Reference Sample Hold	377
PID Input (feedback)	404	Regenerative Torque Limit	382
PID Input Limit	360	REMOTE	88
PID Input Switch	377	Replacement Parts	314, 351, 57
PID Integral Hold	377	Reset Command Active	379
PID Integral Reset	377	Restart Enabled	380
PID Offset Adjustment	359	Reverse Direction	380
PID Output	404	Reverse Jog	377
PID output fault	306	Reverse Operation Selection	357
PID Output Gain Setting	359	Reverse Operation Selection 2 by PID Output	360
PID Output Level Selection	359	Reverse Regenerative Torque Limit	389
PID Output Limit	359	Reverse Run Command (2-Wire sequence)	377
PID Output Lower Limit	360	Reverse Torque Limit	389
PID Output Reverse Selection	359	REV Torque Limit	382
PID Primary Delay Time Constant	359	rH	264, 278
PID Setpoint	404	Rotational Auto-Tuning	102, 301
PID Set Point	382	rr	264, 279
PID Setpoint / User Display	360	RTS Control Selection	383
PID Setpoint and Display Digits	360	rUn	265, 289
PID Setpoint Scaling	360	Run Command (2-Wire sequence 2)	377
PID Setpoint Selection	359	Run Command at Power Up	357
PID Setpoint Value	360	Run Command Input Error	265
PID Sleep Delay Time	359	Run Command Selection	300, 356
PID Sleep Function Start Level	359	Run Command Selection 2	357
PID Soft Starter	377	Run Command Selection during Program	357
Poor Speed Control Accuracy	304	Run Command Selection Error	266
Poor Speed Control Accuracy Above Base Speed in OLV	308		

S	
Safe Disable Input	64, 481
Safe Disable Signal Input	285
Safety Hazard Definitions	13
Safety Information	13
SC	264, 279
S-Curve Characteristic at Accel End	362
S-Curve Characteristic at Accel Start	362
S-Curve Characteristic at Decel End	362
S-Curve Characteristic at Decel Start	362
S-Curve Characteristics	262
SE	266, 289
Search Operation Voltage Limit	361
SEr	264, 279
Serial Communication Terminals	65
Serial Communication Transmission Error	265, 282
Setup Mode	86, 89
Shielded Twisted-Pair Cables	67
Short-Circuit Brake	380
Short-Circuit Brake (N.C.)	378
Short-Circuit Brake (N.O.)	378
Short Circuit Brake Time at Start	357
Side-by-Side Setup	39
Sinking/Sourcing Mode Switch	34
Slip Compensation Gain	261, 362
Slip Compensation Limit	362
Slip Compensation Primary Delay Time	362
Slip Compensation Primary Delay Time Constant	261
Slip Compensation Selection during Regeneration	362
Soft Charge Bypass Relay Maintenance Time	265, 286
Soft Charge Circuit Fault	264
Soft Current Limit Selection	390
Soft Starter Speed Reference at Previous Fault	401
Software No. (Flash)	400
Software No. (ROM)	400
Speed Agreement Detection Level	387
Speed Agreement Detection Level (+/-)	387
Speed Agreement Detection Width	387
Speed Agreement Detection Width (+/-)	387
Speed Deviation (for Simple V/f with PG)	270, 283
Speed Feedback Detection Control (AFR) Gain	392
Speed Feedback Detection Control (AFR) Time Constant	392
Speed Feedback Detection Control (AFR) Time Constant 2	392
Speed Feedback Detection Control [AFR] Time Constant 1	306
Speed Feedback Detection Control Gain	393
Speed Feedback Detection Control Gain during ov Suppression	393
Speed Feedback Detection Suppression Gain	307
Speed Search	380
Speed Search Deactivation Current	358
Speed Search Deceleration Time	358
Speed Search Delay Time	358
Speed Search Induced Voltage Level	358
Speed Search Method Selection	358
Speed Search Restart Current Level	358
Speed Search Restart Detection Time	358
Speed Search Retry Interval Time	358
Speed Search Selection at Start	358
Stall Prevention	262
Stall Prevention During Deceleration	73
Stall Prevention Level during Acceleration	385
Stall Prevention Level during Run	386
Stall Prevention Limit during Acceleration	385
Stall Prevention Selection during Acceleration	385
Stall Prevention Selection during Deceleration	386
Stall Prevention Selection during Run	386
Standard Connection Diagram	50, 51
Stationary Auto-Tuning	103
STo	264, 279
STo Deviation Detection	391
STo Fault Detection Level	391
STOP button Input	266, 296
STOP Key Function Selection	394
Stopping Method After Communication Error	383
Suppression Diode Connection	65
T	
T1-00	398
T1-01	102, 398
T1-02	105, 398
T1-03	105, 398
T1-04	105, 398
T1-05	105, 398
T1-06	105, 398
T1-07	105, 106, 398
T1-11	398
Terminal A1/A2 Enable	376
Terminal A1 Bias Setting	381
Terminal A1 Gain Setting	381
Terminal A1 Signal Level Selection	381
Terminal A2 Bias Setting	381
Terminal A2 Function Selection	381
Terminal A2 Gain Setting	381
Terminal A2 Signal Level Selection	381
Terminal Block Configuration	54
Terminal Board	319
Terminal Board Communications Error	268
Terminal Board Not Connected	270
Terminal Board Wiring Guide	67
Terminal MA, MB and MC Function Selection (relay)	378
Terminal P1 Function Selection (open-collector)	378
Terminal P2 Function Selection (open-collector)	378
Test Run	102, 103, 104, 105, 106, 108
Tightening Torque	58
Timer Function Input	377
Timer Function Off-Delay Time	358
Timer Function On-Delay Time	358
Timer Output	379
Timing Fault	264, 269
T Motor Tuning	398
Too Many Speed Search Restarts	264, 279
Torque Compensation at Forward Start	363
Torque Compensation at Reverse Start	363
Torque Compensation Gain	260, 363
Torque Compensation Gain - Motor 2	370
Torque Compensation Primary Delay Time	260, 306, 307, 363
Torque Compensation Primary Delay Time Constant 1	261
Torque Compensation Primary Delay Time Constant 2	261
Torque Compensation Time Constant	363
Torque Detection 1 (N.O.)	379

Torque Detection 2 (N.C.)	380	U2-16	401
Torque Detection 2 (N.O.)	380	U2-17	401
Torque Detection Level 1	388	U2 Fault Trace	400
Torque Detection Level 2	388	U3-01	401
Torque Detection Selection 1	388	U3-02	401
Torque Detection Selection 2	388	U3-03	401
Torque Detection Time 1	388	U3-04	401
Torque Detection Time 2	388	U3-05	401
Torque Limit Control Method Selection during Accel/Decel	389	U3-06	401
Torque Limit Integral Time Constant	389	U3-07	401
Torque Limits	262	U3-08	401
Torque Reference	399	U3-09	401
Torque Reference at Previous Fault	401	U3-10	401
Torque Specifications, Single Phase 200 V Class	58, 474	U3-11	401
Torque Specifications, Three Phase 200 V Class	59, 475	U3-12	402
Torque Specifications, Three Phase 400 V Class	60, 476	U3-13	402
Transistor Input Signal	68, 69	U3-14	402
TrPC	266, 289	U3-15	402
Tuning Errors	263	U3-16	402
		U3-17	402
		U3-18	402
		U3-19	402
		U3-20	402
		U3 Fault History	401
		U4: Maintenance Monitors	402
		U4-01	402
		U4-02	402
		U4-03	402
		U4-04	402
		U4-05	402
		U4-06	402
		U4-07	402
		U4-08	402
		U4-09	402
		U4-10	402
		U4-11	402
		U4-13	403
		U4-14	403
		U4-16	403
		U4-19	403
		U4-20	403
		U4-22	403
		U4-23	403
		U5-01	404
		U5-02	404
		U5-03	404
		U5-04	404
		U5-05	404
		U5-06	404
		U5 PID Monitor	403
		U6-01	404
		U6-02	404
		U6-03	404
		U6-04	404
		U6-05	404
		U6-06	404
		U6-07	404
		U6-08	404
		U6-20	404
		U6-21	404
U			
U1-01	301, 303, 399		
U1-02	399		
U1-03	399		
U1-04	399		
U1-05	399		
U1-06	399		
U1-07	300, 399		
U1-08	399		
U1-09	300, 399		
U1-11	400		
U1-12	400		
U1-13	400		
U1-14	400		
U1-16	400		
U1-18	400		
U1-19	400		
U1-24	400		
U1-25	400		
U1-26	400		
U1-27	400		
U1-28	400		
U1 Operation Status Monitors	399		
U2, U3 Initialization	396		
U2-01	400		
U2-02	298, 401		
U2-03	401		
U2-03 through U2-17	298		
U2-04	401		
U2-05	401		
U2-06	401		
U2-07	401		
U2-08	401		
U2-09	401		
U2-10	401		
U2-11	401		
U2-12	401		
U2-13	401		
U2-14	401		
U2-15	401		

Index

U6-80 to U6-99	404
U6 Control Monitor	404
UL3	264, 266, 279, 289
UL4	264, 266, 280, 289
UL5	264, 266, 280, 289
UL Standards	474
Undertorque 1	266, 289
Undertorque 2	266, 289
Undertorque Detection 1	264, 279
Undertorque Detection 2	264, 280
Undervoltage	264, 266, 290
Undervoltage 3	280
Undervoltage Detection Level (Uv)	385
Unexpected Noise from Connected Machinery	305
Unit Selection for MEMOBUS/Modbus Register 0025H	383
Unstable Motor Speed when Using PM	307
Up 2 Command	378
Up Command	377
User Monitor Selection After Power Up	394
User Parameter Automatic Selection	110, 356
User Parameter Default Value	110, 395
User Parameters	110
User Parameters, 1 to 32	356
Uv	266, 290
Uv1	264, 280
Uv2	264, 280
Uv3	264, 280
V	
V/f Control Mode Tuning	260
V/f Control Mode Tuning Parameters	260
V/f Data Setting Error	266, 294
V/f Pattern Defaults	408
V/f Pattern Selection	303, 367
Verify Menu	86
Voltage Error Compensation Time Constant	393
W	
Watchdog Circuit Exception	264, 269
Watt Hour Output Unit Selection	379
Watt Hour Pulse Output	380
Watt Loss 200 V Class Single Phase Models	350
Watt Loss 200 V Class Three Phase Models	350
Watt Loss 400 V Class Three Phase Models	350
Wire Gauge, Single Phase 200 V Class	58, 474
Wire Gauge, Three Phase 200 V Class	59, 475
Wire Gauge, Three Phase 400 V Class	60, 476
Wire Gauges	58
Wiring Checklist	74
Wiring Procedure	52
Z	
Zero Speed	379

This Page Intentionally Blank



Drives Motors Controls

Revision History

The revision dates and the numbers of the revised manuals appear on the bottom of the back cover.

MANUAL NO. SIEP C710606 18B <1>
 Revision number
 Published in Japan December 2011
 Date of publication

Date of Publication	Revision Number	Section	Revised Content
December 2016	<6>	Appendix D	Correction: Safe Disable Input
		Back Cover	Revision: Address
August 2016	<5>	Front Cover	Revision: Format
		All	Revision: Reviewed and corrected documentation
		Appendix D	Revision: Safe Disable Input
		Back Cover	Revision: Format and address
May 2015	<4>	Front Cover, Spine	Revision: Format
		All	Revision: Reviewed and corrected documentation
		Chapter 3	Addition: Safety messages regarding motor leads and Safe Disable input
		Chapter 5	Addition: Parameter C3-18 and selections 4 and 5 to parameter F6-01
		Appendix B	Addition: Parameter C3-18 and selections 4 and 5 to parameter F6-01
		Appendix C	Revision: Wiring Diagram for Multiple Connections
		Appendix D	Revision: UL Factory Recommended Branch Circuit Protection
		Back Cover	Revision: Format and address
December 2014	<3>-1	Chapter 1	Revision: Model number definition
March 2014	<3>	All	Revision: Reviewed and corrected documentation Revision: Upgraded the software version from PRG: 1021 to PRG: 1023
		Chapter 3	Revision: Wire Gauge and Torque Specifications
		Appendix A	Revision: Standards
		Appendix D	Addition: Fuse List for European Standards Revision: Wire Gauge and Torque Specifications for UL Standards Revision: Standards
		Back Cover	Revision: Address
May 2012	<2>	Chapter 2	Revision: Ambient temperature
		Appendix A	Revision: Ambient temperature
		Appendix D	Addition: Ambient temperature Addition: CSA Standards Compliance Revision: Low Voltage Wiring for Control Circuit Terminals
December 2011	<1>	Front Cover	Revision: Format
		All	Revision: Reviewed and corrected documentation Upgraded the software version from PRG: 1011 to PRG: 1021
		Chapter 3	Revision: Wire Gauge and Torque Specifications Revision: Precautions on installing a leakage breaker
		Chapter 8	Revision: Precautions on installing a leakage breaker
		Appendix D	Revision: Wire Gauge and Torque Specifications Revision: Closed-Loop Crimp Terminal Size Revision: Fuse List
		Back Cover	Revision: Format and address
June 2008	-	-	First Edition

This Page Intentionally Blank

The logo for DMC consists of the letters 'D', 'M', and 'C' in a large, bold, sans-serif font. Each letter is filled with a light teal color and has a thick, light blue outline. The letters are spaced out horizontally.

Drives Motors Controls

YASKAWA AC Drive-V1000

Compact Vector Control Drive

Technical Manual

YASKAWA AMERICA, INC.

2121, Norman Drive South, Waukegan, IL 60085, U.S.A.
Phone: +1-800-YASKAWA (927-5292) or +1-847-887-7000 Fax: +1-847-887-7310
<http://www.yaskawa.com>

DRIVE CENTER (INVERTER PLANT)

2-13-1, Nishimiyaichi, Yukuhashi, Fukuoka, 824-8511, Japan
Phone: +81-930-25-2548 Fax: +81-930-25-3431
<http://www.yaskawa.co.jp>

YASKAWA ELECTRIC CORPORATION

New Pier Takeshiba South Tower, 1-16-1, Kaigan, Minatoku, Tokyo, 105-6891, Japan
Phone: +81-3-5402-4502 Fax: +81-3-5402-4580
<http://www.yaskawa.co.jp>

YASKAWA ELÉTRICO DO BRASIL LTDA.

777, Avenida Piraporinha, Diadema, São Paulo, 09950-000, Brasil
Phone: +55-11-3585-1100 Fax: +55-11-3585-1187
<http://www.yaskawa.com.br>

YASKAWA EUROPE GmbH

Hauptstraße 185, 65760 Eschborn, Germany
Phone: +49-6196-569-300 Fax: +49-6196-569-398
<http://www.yaskawa.eu.com> E-mail: info@yaskawa.eu.com

YASKAWA ELECTRIC KOREA CORPORATION

35F, Three IFC, 10 Gukjegeumyung-ro, Yeongdeungpo-gu, Seoul, 07326, Korea
Phone: +82-2-784-7844 Fax: +82-2-784-8495
<http://www.yaskawa.co.kr>

YASKAWA ELECTRIC (SINGAPORE) PTE. LTD.

151, Lorong Chuan, #04-02A, New Tech Park, 556741, Singapore
Phone: +65-6282-3003 Fax: +65-6289-3003
<http://www.yaskawa.com.sg>

YASKAWA ELECTRIC (THAILAND) CO., LTD.

59, 1st-5th Floor, Flourish Building, Soi Ratchadapisek 18, Ratchadapisek Road, Huaykwang, Bangkok, 10310, Thailand
Phone: +66-2-017-0099 Fax: +66-2-017-0799
<http://www.yaskawa.co.th>

YASKAWA ELECTRIC (CHINA) CO., LTD.

22F, One Corporate Avenue, No.222, Hubin Road, Shanghai, 200021, China
Phone: +86-21-5385-2200 Fax: +86-21-5385-3299
<http://www.yaskawa.com.cn>

YASKAWA ELECTRIC (CHINA) CO., LTD. BEIJING OFFICE

Room 1011, Tower W3 Oriental Plaza, No. 1, East Chang An Ave.,
Dong Cheng District, Beijing, 100738, China
Phone: +86-10-8518-4086 Fax: +86-10-8518-4082

YASKAWA ELECTRIC TAIWAN CORPORATION

9F, 16, Nanking E. Rd., Sec. 3, Taipei, 104, Taiwan
Phone: +886-2-2502-5003 Fax: +886-2-2505-1280
<http://www.yaskawa.com.tw>

YASKAWA INDIA PRIVATE LIMITED

#17/A, Electronics City, Hosur Road, Bangalore, 560 100 (Karnataka), India
Phone: +91-80-4244-1900 Fax: +91-80-4244-1901
<http://www.yaskawaindia.in>

YASKAWA

YASKAWA ELECTRIC CORPORATION

In the event that the end user of this product is to be the military and said product is to be employed in any weapons systems or the manufacture thereof, the export will fall under the relevant regulations as stipulated in the Foreign Exchange and Foreign Trade Regulations. Therefore, be sure to follow all procedures and submit all relevant documentation according to any and all rules, regulations and laws that may apply.

Specifications are subject to change without notice for ongoing product modifications and improvements.

© 2008-2016 YASKAWA ELECTRIC CORPORATION

MANUAL NO. SIEP C710606 18F <6>

Published in Japan December 2016

16-8-17_YAI

Original instructions