

Variable Speed Microdrive Catalog



A World of Power in the Palm of your Hand! Great Things Come in Small Packages

The **V1000** is a world-class compact current vector microdrive that defines a new world standard. Demands for efficient production and better maintainability are being driven by global competition.

The **V1000-4X** is a member of the standard V1000 family that also features a design that meets NEMA 4X 12 inch enclosure requirements, UL type 12 standards, and the operating of 100°C. The enclosure provides the protection required for use in high voltage and high temperature environments.

The **J1000** is the solution to our pursuit to create drives optimized for variable speed needs in compact applications. This microdrive is simple and reliable with Yaskawa quality.

The **VS mini** drives a full-featured, high-performance “microsize” design for single-phase inputs. The significant size reduction has been accomplished without sacrificing the essential programming features of our larger drives.

Yaskawa microdrives have earned a reputation for high performance, high functionality, and high quality.



- V1000 and V1000-4X**
- 240V, 1-phase: 1/8 to 5 HP
- 480V, 3-phase: 1/8 to 25 HP
- 480V, 3-phase: 1/2 to 25 HP
- J1000**
- 240V, 1-phase: 1/8 to 5 HP
- 480V, 3-phase: 1/8 to 5 HP
- 480V, 3-phase: 1/2 to 7.5 HP

- VS mini**
- 115V, 1-phase: 1/8 to 1 HP

Drives Motors Controls

DMC

Drives Motors Controls

		Page
	VS mini Drive	
	Description	3
	Standard Drives	5
	Dimensions and Data	6
	Dimension Drawing	7
	J1000 Drive (J1000)	
	Description	9
	Standard Drives	11
	Dimensions and Data	12
	Dimension Drawing	13
	V1000 Drive (V1000)	
	Description	23
	Standard Drives	25
	V1000 Drive Variants	26
	Dimensions and Data	28
	Dimension Drawings	29
	Options	33
Drives Motors Controls		
	V1000-4X Drive (V1000-4X)	
	Description	43
	Standard Drives	45
	Dimensions and Data	46
	Dimension Drawings	47
	Options	51
Technical Training	53	
Terms and Conditions	54	

This catalog may describe trademarked equipment, which is the property of other companies. These trademarks are the property of the registered owner companies and may include the following:

DeviceNet™, trademark of ODVA.
Profibus®, trademark of PROFIBUS International
Modbus®, trademark of Schneider Automation, Inc.

Other Documents and Manuals are available to support special use or installation of this product. These documents may be provided with the product or upon request. Contact Yaskawa America, Inc. or visit www.yaskawa.com, as required. Documents may include the following:

VS mini

TOE-S606-10.20C .. Technical Manual for VS mini Drive

J1000

TOEPC7100006... J1000 Quick Start Guide
SIEPC7100635... J1000 Technical Manual
TM.J1000.01... J1000 Cheat Sheet
TOBPC73060023... R-23 Control Technical Manual (SI-23/V and S-23/V)
TOBPC73060048... R-48 Motor BL S Motors Interface Technical Manual (SI-48/J)
TOBPC73060049... R-48 Motor BL S Motors Interface Technical Manual (SI-48/J)
TOBPC73060050... LCD Operator Installation Manual (JVOP-180)
TOEPC73060051... LED Operator Installation Manual (JVOP-182)
TOBPC73060081... USB Copy Unit (V-Stick) Technical Manual (JVOP-181)



V1000

TOEPC71060614.... V1000 Quick Start Guide
SIEPC71060618.... V1000 Technical Manual
TM.V1000.01..... V1000 Cheat Sheet
TOBPC73060023... Profibus-DP Installation Manual (SI-P3/V)
SIEPC73060023.... Profibus-DP Technical Manual (SI-P3/V)
TOBPC73060025.... USB Copy Unit (Y-Stick) Technical Manual (JVOP-181)
TOEPC73060028.... DeviceNet Installation Manual (SI-N3/V)
SIEPC73060028.... DeviceNet Technical Manual (SI-N3/V)
TOEPC73060020.... DriveWizard Plus Instruction Manual
TOBPC73060029.... LCD Operator Installation Manual (JVOP-180)
TOBPC73060035.... LED Operator Installation Manual (JVOP-182)
TOEPYEACOM01 ... Ethernet/IP Installation Manual (SI-EN3/V)
SIEPYEACOM01 Ethernet/IP Technical Manual (SI-EN3/V)
TOEPYEACOM02... Modbus TCP/IP Installation Manual (SI-EM3/V)
SIEPYEACOM02 Modbus TCP/IP Technical Manual (SI-EM3/V)
TOBPC73060049.... MECHATROLINK-II Installation Manual (SI-T3/V)
SIEPC73060049 MECHATROLINK-II Technical Manual (SI-T3/V)
TOBPC73060027.... V1000 24V Control Power Unit
TOBPC71060621.... V1000 Finless Type Installation Guide
TOEPYEAOPT02.... 1000 Series Operator Mounting Kit NEMA Type 4X/IP66 Installation Manual
TOEPYEAOPT03.... V1000 120VAC Interface (D1-100)

Drives Motors Controls

V1000-4X

TOBPC71060635.... V1000-4X Installation Manual



The VS mini drive is a full-featured, high-performance, “microsize” design. This significant size reduction has been accomplished without sacrificing the essential programming features of our larger drives.

The VS mini offers power and versatility for a wide range of applications including material handling, packaging, mixing, pumping, HVAC, commercial wash machines, recreation equipment (tread mills), overhead doors and general industrial applications. Available in both standard protected chassis and optional Din rail designs.

The “microsize” design features application-specific intelligent power module (ASIPM) devices and circuitry, a 16-bit microprocessor, surface-mounted devices for reliability and strength, and second generation insulated-gate bipolar transistor (IGBT) technology.

The VS mini is available in 1/8 through 1 HP, 115 VAC single-phase, 50/60 Hz models. Output is 3-phase, 0 to 230 VAC.

Performance Features

- Ratings: 1/8 to 1 HP at 115 VAC
- Constant torque overload rating: 150% for 60 sec (6000% overload)
- DC injection braking
- Electronic speed feedback
- Adjustable acceleration: 0.1 to 9
- Controlled speed range: 40:1
- Drive efficiency: 95%
- Displacement factor: 0.98
- Output frequency: 0 to 400 Hz
- Output voltage: 0 to 230 VAC
- Frequency resolution: 0.1 Hz with digital command, 0.06 /60 Hz with analog command
- Frequency accuracy (-10° to 50°C): 0.01% with digital command, 0.1% with analog command
- Volts / hertz ratio: infinitely adjustable pattern
- DC injection braking: adjustable amplitude, duration, and current limit
- Torque boost: full range auto
- Power loss ride-through: 1 sec/min
- Speed search
- Auto restart
- 3 Critical frequency limits
- Slip Compensation

Design Features

- 16-bit microprocessor logic
- Digital keypad operator
- Programmable form C contact for current limit: 1 A at 250 VDC
- 24-bit analog logic
- Current limit: 1.5
- 8 speed settings
- 8 speed reference
- 0-10 VDC (200 ohm)
- 4-20 mA (250 ohm)
- Slave follow with speed gain
- Analog input for speed reference
- 0-10 VDC stop to pulse frequency output
- Over 70 programmable functions
- Fully EMC compliant when optional RFI filter connected
- MTBF: exceeds 28 years
- Protected chassis

Standards

- UL listed
- CE marked
- IEEE STD 444 (ANSI-C343)
- IEC: 150A

Protective Features

- Current limited stall prevention during accel, decel and run
 - DC bus overvoltage indicator
 - 100°C programmable electronic motor overload
 - Phase sequence insensitive
 - Phase sequence insensitive
- Operating Conditions**
- Ambient service temperature: -20° to 50° C (-4° to 122° F)
 - Storage temperature: -20° to 140° F
 - Humidity: to 90% non-condensing
 - Altitude: to 3500 ft; higher by derating
 - Service factor: 1.0
 - Input voltage: single phase 115V, ±10%
 - Input frequency: 50/60 Hz ± 5%
 - Phase sequence insensitive

Options

- Dynamic braking resistor (external)
- DIN Rail Kit
- Auxiliary potentiometer card
- Remote keypad

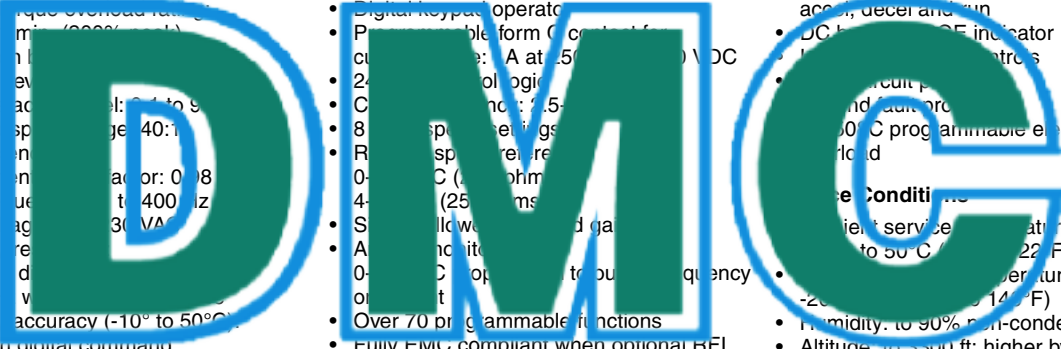

Drives Motors Controls

This page intentionally left blank

DMC

Drives Motors Controls



VS mini Drives - 1/8-1HP, 115V, 1-phase input, protected chassis enclosure, 230V, 3-phase output.

Rated Input Voltage	Drive Model Number CIMR-XCBM	Old Model Number GPD205-	Rated Output Current (Amps)	Nominal HP ⁽¹⁾
115V, 1-Phase	AOP10	10P1	0.8	1/8
	AOP20	10P2	1.5	1/4
	AOP40	10P7	3.0	1/2 & 3/4
	AOP70	1001	5.0	1

(1) Horsepower rating is based on standard NEMA B 4-pole motor design as represented in NEC table 430.150 Full-Load Current, Three-Phase Alternating Current Motors



Drives Motors Controls

**VS
mini**

Dimensions and Data

Rated Input Voltage	Drive Model Number CIMR-XCBM	Rated Output Current (Amps)	Nominal HP (¹)	Physical Dimensions (in.)			Mounting Dimensions (in.)		Weight (lbs) (²)	Standard Enclosure	Heat Loss (watts)	
				H	W	D	H1	W1				
115V, 1-Phase	A0P10	0.8	1/8	5.04	2.68	3.74	4.64	2.20	1.3	Protected Chassis	13	
	A0P20	1.5	1/4			4.25					22	
	A0P40	3.0	1/2 & 3/4		4.25	5.12	4.64	3.78			2.9	39
	A0P70	5.0	1			6.10					3.1	61

(1) Horsepower rating is based on standard NEMA B 4-pole motor design as represented in NEC table 430.150 Full-Load Current, Three-Phase Alternating Current Motors

(2) This data represents the drive weight only, not shipping weight.

DMC

Drives Motors Controls



Fig. 1

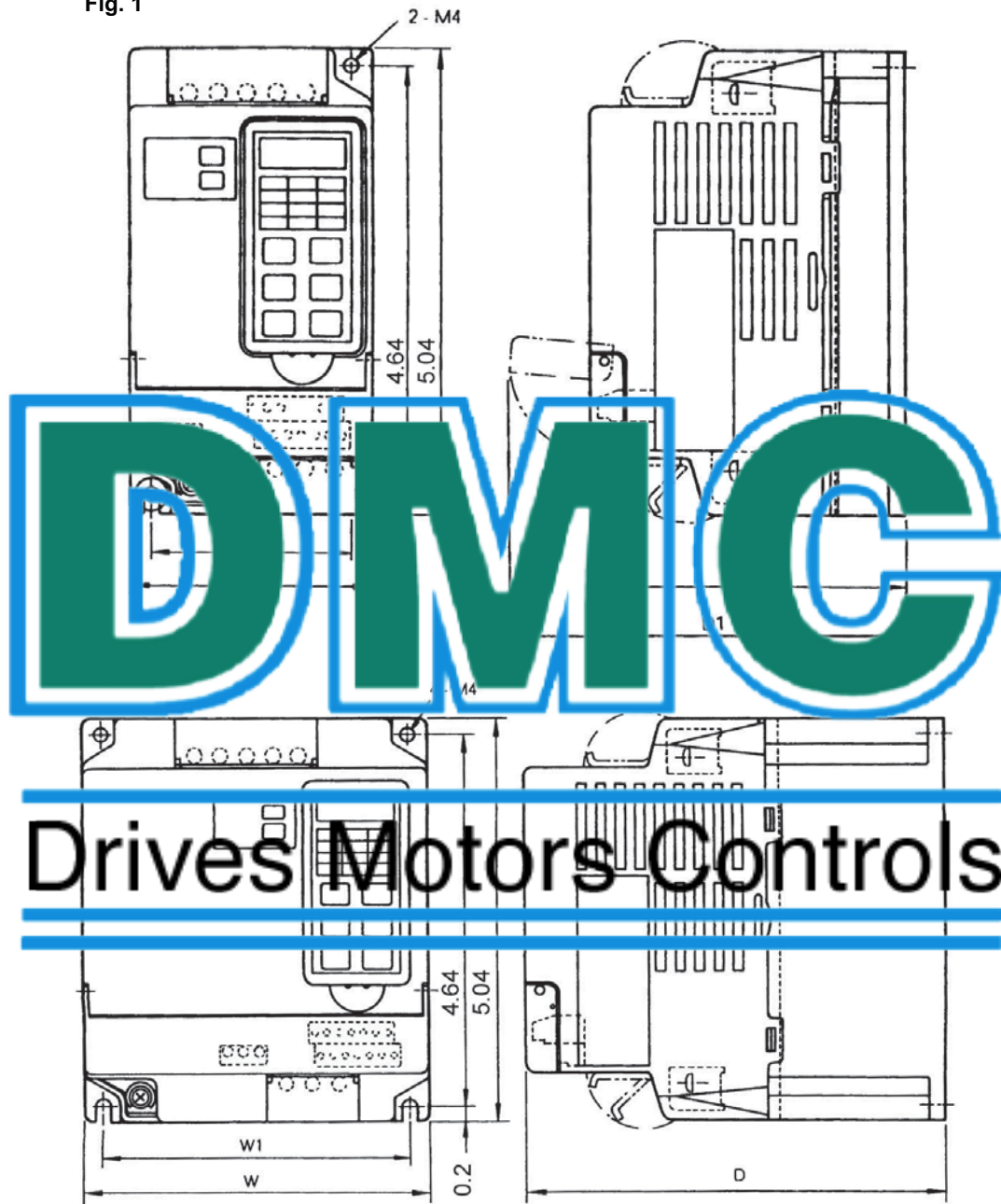

Voltage	Model CIMR-XCBM	Output Current Rating (Amps)	HP	Dimensions in Inches						Figure	Approx. Weight (Lbs.)	Heat Loss (Watts)
				Mounting		H	W	D	D1			
				H1	W1							
115V, 1-Phase	A0P10	0.8	1/8	4.64	2.20	5.04	2.68	3.74	4.57	1	1.3	13
	A0P20	1.5	1/4	4.64	2.20	5.04	2.68	4.25	5.09	1	1.3	22
	A0P40	3.0	1/2 & 3/4	4.64	3.78	5.04	4.25	5.12	5.94	2	2.9	39
	A0P70	5.0	1	4.64	3.78	5.04	4.25	6.10	6.93		3.1	61

This page intentionally left blank

DMC

Drives Motors Controls



In our pursuit to create drives optimized for variable speed needs in compact applications, the J1000 is the solution. This micro-drive is simple and reliable with Yaskawa quality. Demand continues to increase for compact drives with hassle-free maintenance. Yaskawa drives have earned a reputation for high performance, high functionality, and high quality.

Great Things Come in Small Packages!

Performance Features

- Ratings:
 - 1/8 to 3 HP at 200 VAC 3-Ph
 - 1/8 to 5 HP at 200-240 VAC 3-Ph
 - 1/2 to 7.5 HP at 200-240 VAC 3-Ph
- Overload capacity:
 - 150% for 0.5 sec (avg. Duty)
 - 120% for 0.5 sec (max. Duty)
- Control Methods: V/F Control
- DC injection braking ramp to stop
- Electronic reverse ramp to stop
- Adjustable acceleration: 0.1 to 60 seconds
- Controlled speed ramp to stop
- Speed Reversal:
 - ± 0.5 to 1 Hz with slip compensation
- Displacement power factor: 0.98
- Output frequency: 0 to 400 Hz
- Frequency resolution:
 - 0.01 Hz with digital reference
 - 0.06 / 60 Hz with analog reference
- Frequency accuracy:
 - 0.01% with digital command
 - 0.5% with analog command
- Volts / hertz ratio: infinitely adjustable pattern
- DC Injection:
 - duration, current limited
- Torque boost: full range, auto
- Power loss ride-thru: 0.5 sec.
- Speed search
- Auto restart
- 2 Critical frequency rejection settings
- Slip Compensation

Design Features

- 16-bit microprocessor logic
- Digital keypad operator, 9 digits
- LED status display
- Remote Control Keypad
- 5 digit 7-segment digital display
- 16-bit digital output
- Programmable for:
 - Control output (V/A) to 0 VDC
 - 24-bit logic compatible with sensors or speed outputs (counter I/P)
 - Control output (Hz) motor nameplate
- 8 speed ramp profiles just one sec
- 1 sec speed reference:
 - 0-10 VDC (2 kohms) or isolated
 - 4-20 mA (250 ohms)
- Signal follower: bias and gain
- Analog monitor output:
 - 0-10 VDC proportional to output frequency or output current
- Approximately 140 parameters and monitor
- Cooling fan controlled by drive run/stop
- UL recognized electronic overload
- MTBF: 25 years
- Protected Chassis
- Side-by-Side mounting
- Maintenance monitors

Protective Features

- Current limit, stall prevention during accel, decel, and run
- Motor overcurrent
- Motor overtemperature function
- Simultaneous overcurrent
- Overvoltage
- Sink overheat
- Overhaul protection
- Under torque
- Short circuit current rating 30kA rms sym.
- Ambient temperature:
 - 10° to 50°C (+14° to 122°F)
- Ambient storage temperature:
 - 20° to 60°C (-4° to 140°F)
- Humidity: to 95% non-condensing
- Altitude: to 3300 ft; higher by derating
- Service factor: 1.0
- Input voltage: -15% to +10%
 - 200 to 240 VAC, 300 to 480 VAC
- Input frequency: +5%, 50/60 Hz
- Input phase sequence insensitive
- Dynamic Braking resistor (external)
- Remote LED Operator w/ copy function
- Modbus 232/422/485 Communications
- Analog Potentiometer Card
- DriveWizard Plus
- DIN rail mounting kit
- USB Copy Unit (Y-Stick)
- Reactors, 3% and 5%
- EMC filters, C1 and C3

Standards

- UL 508C (Power Conversion)
- CSA 22.2 No. 14-95 (Industrial Control Equipment)
- UL, cUL listed; CE marked
- RoHS compliant
- EN 50178 (LVD)
- EN 50081-2, EN 50082-2 (EMC)
- EN 61800-3
- IEC 529, 146
- FCC CFR 47 Part 15 Subpart B (w/ External Filter)

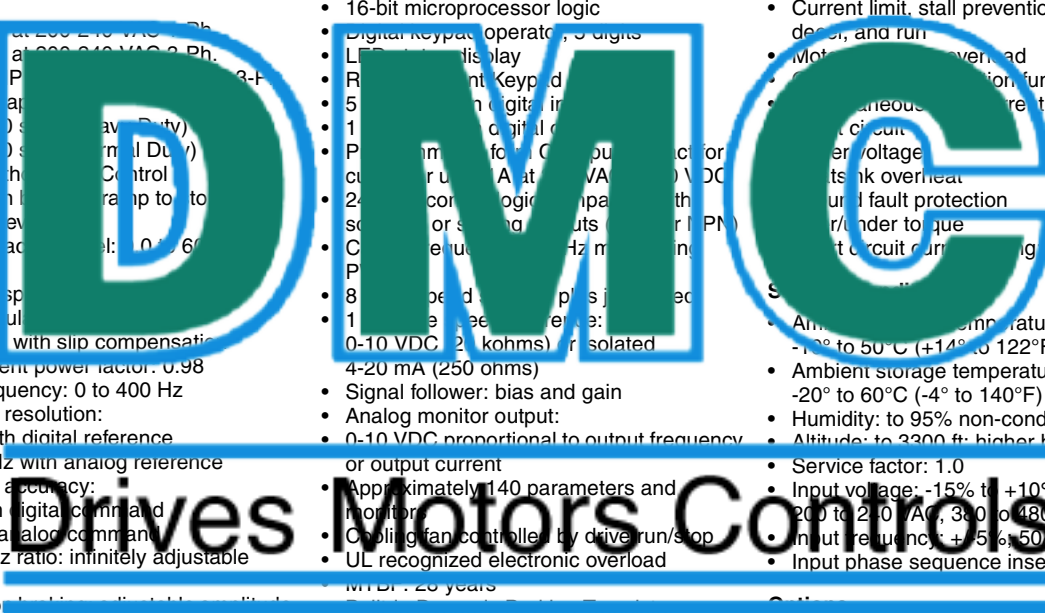

Drives Motors Controls

This page intentionally left blank

DMC

Drives Motors Controls

Rated Input Voltage	Drive Model Number CIMR-JU	Normal Duty ⁽¹⁾		Heavy Duty ⁽¹⁾	
		Rated Output Current (Amps)	Nominal HP ⁽²⁾	Rated Output Current (Amps)	Nominal HP ⁽²⁾
200-240V 1-Phase	BA0001BAA	1.2	1/8 & 1/4	0.8	1/8
	BA0002BAA	1.9	1/4	1.6	1/4
	BA0003BAA	3.3	1/2 & 3/4	3.0	1/2
	BA0006BAA	6.0	1	5.0	3/4 & 1
	BA0010BAA	9.6	2 & 3	8.0	2
200-240V 3-Phase	2A0001BAA	1.2	1/8 & 1/4	0.8	1/8
	2A0002BAA	1.9	1/4	1.6	1/4
	2A0004BAA	3.3	1/2 & 3/4	3.0	1/2
	2A0006BAA	6.0	1	5.0	3/4 & 1
	2A0010BAA	9.6	2 & 3	8.0	2
380-480V 3-Phase	4A0001BAA	1.2	1/8 & 1/4	0.8	1/8
	4A0002BAA	1.9	1/4	1.6	1/4
	4A0004BAA	3.3	1/2 & 3/4	3.0	1/2
	4A0006BAA	6.0	1	5.0	3/4 & 1
	4A0010BAA	9.6	2 & 3	8.0	2

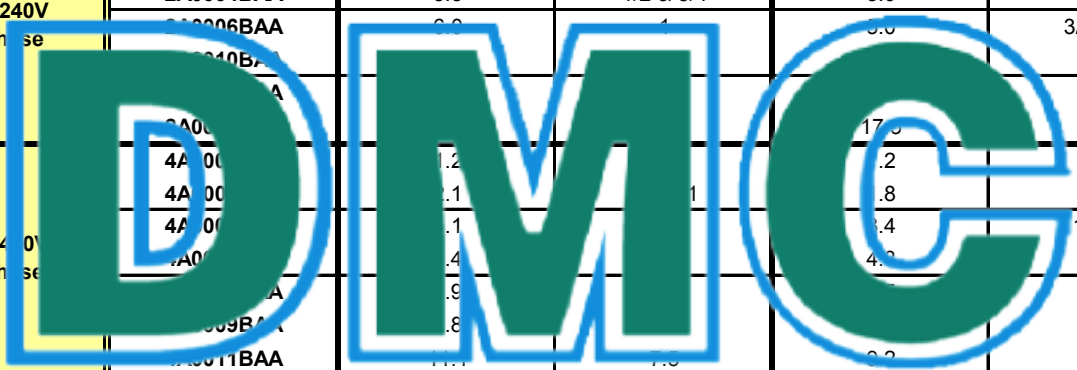

(1) Normal Duty overload current rating is 120% of rated output current for 60 seconds; Heavy Duty overload current rating is 150% of rated output current for 60 seconds.

(2) Horsepower rating is based on 230-volt and 480-volt induction-type squirrel-cage NEMA B 4-pole motors as represented in NEC table 430.250 Full-Load Current, Three-Phase Alternating Current Motor.

Drives Motors Controls

J1000

Dimensions and Data

Rated Input Voltage	Drive Model Number CIMR-JU	Normal Duty		Heavy Duty		Physical Dimensions (in.)			Mounting Dimensions (in.)		Weight (lbs.) ⁽¹⁾
		Rated Output Current (Amps)	Nominal HP	Rated Output Current (Amps)	Nominal HP	H	W	D	H1	W1	
200-240V 1-Phase	BA0001BAA	1.2	1/8 & 1/4	0.8	1/8	5.00	2.68	2.99	4.60	2.20	1.3
	BA0002BAA	1.9	1/4	1.6	1/4	5.00	2.68	2.99	4.60	2.20	1.3
	BA0003BAA	3.3	1/2 & 3/4	3.0	1/2	5.00	2.68	4.65	4.60	2.20	2.2
	BA0006BAA	6.0	1 & 1.5	5.0	3/4 & 1	5.00	4.25	5.41	4.60	3.78	3.5
	BA0010BAA	9.6	2 & 3	8.0	2	5.00	4.25	6.06	4.60	3.78	4.0
200-240V 3-Phase	2A0001BAA	1.2	1/8 & 1/4	0.8	1/8	5.00	2.68	2.99	4.60	2.20	1.3
	2A0002BAA	1.9	1/4	1.6	1/4	5.00	2.68	2.99	4.60	2.20	1.3
	2A0003BAA	3.3	1/2 & 3/4	3.0	1/2	5.00	2.68	4.65	4.60	2.20	2.0
	2A0006BAA	6.0	1 & 1.5	5.0	3/4 & 1	5.00	2.68	5.04	4.60	2.20	2.4
	2A0010BAA	9.6	2 & 3	8.0	2	5.00	4.25	6.06	4.60	3.78	3.8
380-480V 3-Phase	4A0001BAA	1.2	1/8 & 1/4	0.8	1/8	5.00	2.68	2.99	4.60	2.20	1.3
	4A0002BAA	1.9	1/4	1.6	1/4	5.00	2.68	2.99	4.60	2.20	1.3
	4A0003BAA	3.3	1/2 & 3/4	3.0	1/2	5.00	2.68	4.65	4.60	2.20	2.2
	4A0006BAA	6.0	1 & 1.5	5.0	3/4 & 1	5.00	4.25	5.41	4.60	3.78	3.5
	4A0010BAA	9.6	2 & 3	8.0	2	5.00	4.25	6.06	4.60	3.78	4.0

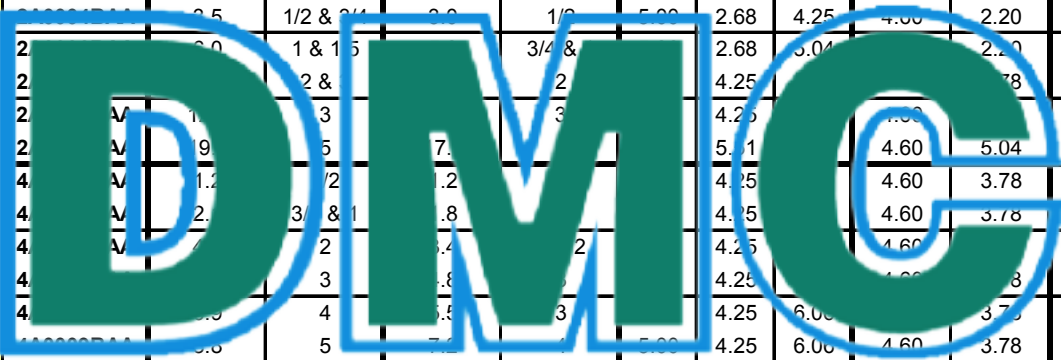

(1) This data represents typical values and is subject to change without notice.

Drives Motors Controls

Dimension Drawing

DD.J1000.01

Protected Chassis

J1000

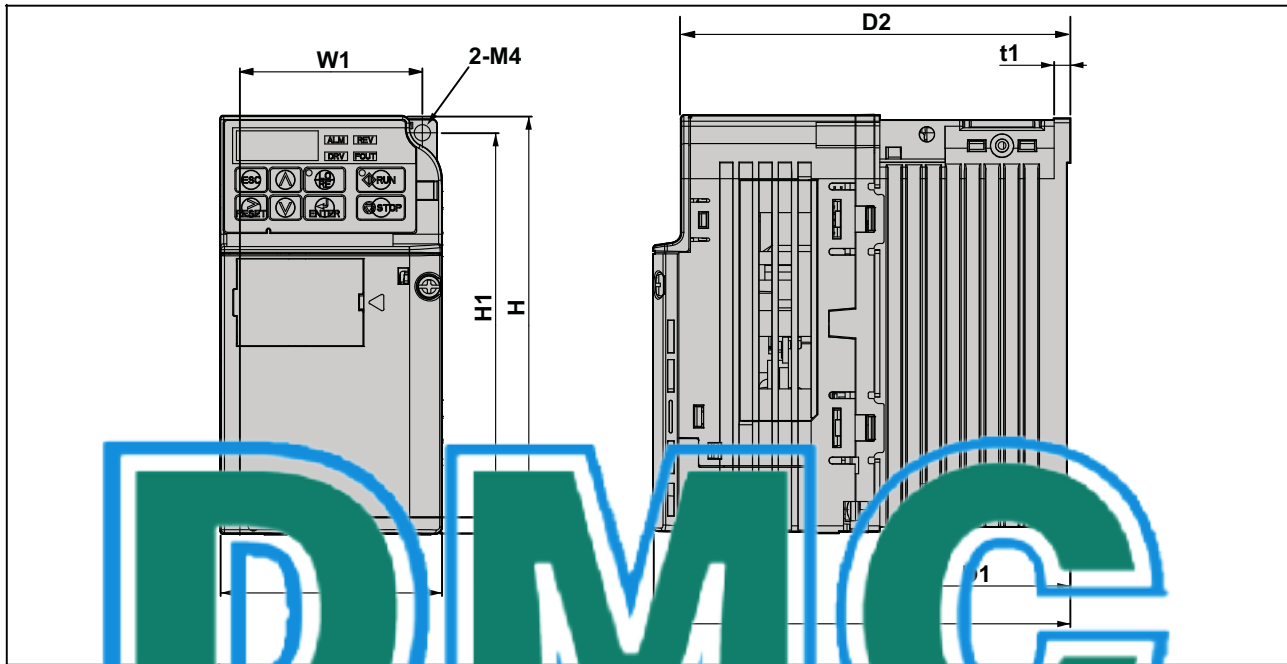

Voltage Class	Drive Model	Dimensions (inches)									Weight (lb.)
		W1	H1	H	D2	t1	2-M4	1	1	1	
Single-Phase 200 V Class	BA0001B	2.7	5.0	3.0	2.2	4.6	0.2	0.3	2.7	0.1	1.3
	BA0002B	2.7	5.0	3.0	2.2	4.6	0.2	0.3	2.7	0.1	1.3
	BA0003B	2.7	5.0	4.6	2.2	4.6	0.2	1.5	4.3	0.2	2.2
Three-Phase 200 V Class	2A0001B	2.7	5.0	3.0	2.2	4.6	0.2	0.3	2.7	0.1	1.3
	2A0002B	2.7	5.0	3.0	2.2	4.6	0.2	0.3	2.7	0.1	1.3
	2A0004B	2.7	5.0	4.6	2.2	4.6	0.2	1.5	3.9	0.2	2.0
	2A0006B	2.7	5.0	5.0	2.2	4.6	0.2	2.5	4.7	0.2	2.4

DMC

Drives Motors Controls

J1000

Dimension Drawing

DD.J1000.02
Protected Chassis

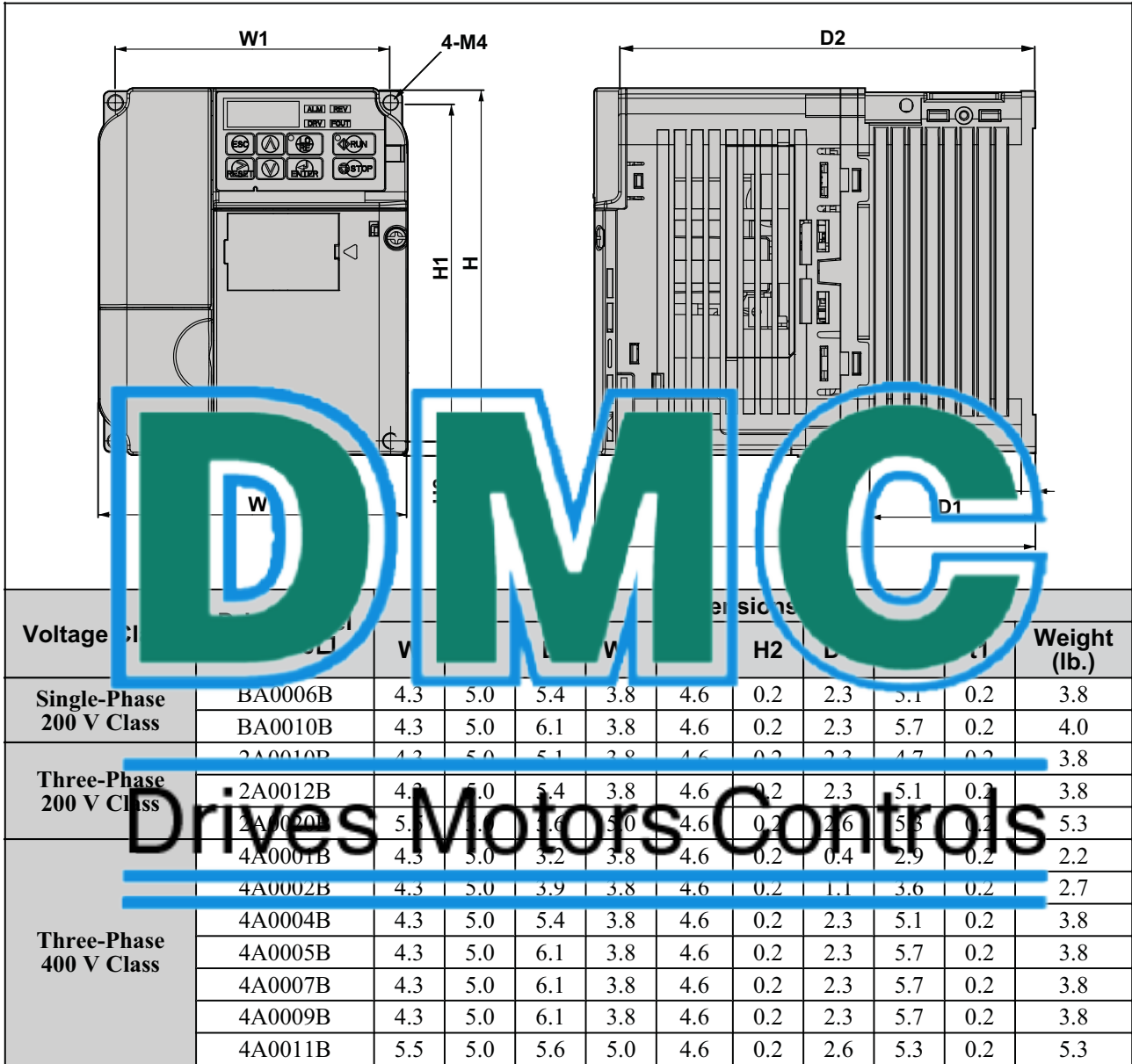



Reactor, 3% and 5% Impedance - may be used on either the input or output of a drive to reduce the effect of load or line side transients on the drive. The three-phase reactors are available loose in a separate NEMA 1 enclosure.

Rated Input Voltage	Drive Model Number CIMR-JU	Rated Output Current (Amps)	Nominal HP	3% Enclosed Reactor			5% Enclosed Reactor				
				Part Number 05P00620-	Dimensions (in.)			Part Number 05P00620-	Dimensions (in.)		
					H	L	W		H	L	W
200-240V 1-Phase	BA0001BAA	1.2	1/8 & 1/4	0020	8.0	8.0	6.0	0015	8.0	8.0	6.0
	BA0002BAA	1.9	1/4	0020	8.0	8.0	6.0	0021	8.0	8.0	6.0
	BA0003BAA	3.3	1/2 & 3/4	0020	8.0	8.0	6.0	0021	8.0	8.0	6.0
	BA0006BAA	6.0	1	0027	8.0	8.0	6.0	0028	8.0	8.0	6.0
	BA0010BAA	9.6	2 & 3	0027	8.0	8.0	6.0	0028	8.0	8.0	6.0
200-240V 3-Phase	2A0001BAA	1.2	1/8 & 1/4	0020	8.0	8.0	6.0	0015	8.0	8.0	6.0
	2A0002BAA	1.9	1/4	0020	8.0	8.0	6.0	0021	8.0	8.0	6.0
	2A0003BAA	3.3	1/2 & 3/4	0020	8.0	8.0	6.0	0021	8.0	8.0	6.0
	2A0006BAA	6.0	1	0027	8.0	8.0	6.0	0028	8.0	8.0	6.0
	2A0010BAA	9.6	2 & 3	0027	8.0	8.0	6.0	0028	8.0	8.0	6.0
	2A0012BAA	12.0	3	0033	8.0	8.0	6.0	0033	8.0	8.0	6.0
380-480V 3-Phase	4A0001BAA	1.2	1/8 & 1/4	0020	8.0	8.0	6.0	0015	8.0	8.0	6.0
	4A0002BAA	1.9	1/4	0020	8.0	8.0	6.0	0021	8.0	8.0	6.0
	4A0003BAA	3.3	1/2 & 3/4	0020	8.0	8.0	6.0	0021	8.0	8.0	6.0
	4A0006BAA	6.0	1	0027	8.0	8.0	6.0	0028	8.0	8.0	6.0
	4A0010BAA	9.6	2 & 3	0027	8.0	8.0	6.0	0028	8.0	8.0	6.0
4A0011BAA	11.1	2.5	0036	8.0	8.0	6.0	0037	8.0	8.0	6.0	
4A0012BAA	12.0	3	0033	8.0	8.0	6.0	0033	8.0	8.0	6.0	
4A0014BAA	14.4	3.4	0043	13.0	13.0	13.0	0043	13.0	13.0	13.0	
4A0015BAA	15.0	3.4	0043	13.0	13.0	13.0	0043	13.0	13.0	13.0	
4A0016BAA	16.0	3.4	0043	13.0	13.0	13.0	0043	13.0	13.0	13.0	
4A0017BAA	17.0	3.4	0043	13.0	13.0	13.0	0043	13.0	13.0	13.0	
4A0018BAA	18.0	3.4	0043	13.0	13.0	13.0	0043	13.0	13.0	13.0	
4A0019BAA	19.0	3.4	0043	13.0	13.0	13.0	0043	13.0	13.0	13.0	
4A0020BAA	20.0	3.4	0043	13.0	13.0	13.0	0043	13.0	13.0	13.0	
4A0021BAA	21.0	3.4	0043	13.0	13.0	13.0	0043	13.0	13.0	13.0	
4A0022BAA	22.0	3.4	0043	13.0	13.0	13.0	0043	13.0	13.0	13.0	
4A0023BAA	23.0	3.4	0043	13.0	13.0	13.0	0043	13.0	13.0	13.0	
4A0024BAA	24.0	3.4	0043	13.0	13.0	13.0	0043	13.0	13.0	13.0	
4A0025BAA	25.0	3.4	0043	13.0	13.0	13.0	0043	13.0	13.0	13.0	
4A0026BAA	26.0	3.4	0043	13.0	13.0	13.0	0043	13.0	13.0	13.0	
4A0027BAA	27.0	3.4	0043	13.0	13.0	13.0	0043	13.0	13.0	13.0	
4A0028BAA	28.0	3.4	0043	13.0	13.0	13.0	0043	13.0	13.0	13.0	
4A0029BAA	29.0	3.4	0043	13.0	13.0	13.0	0043	13.0	13.0	13.0	
4A0030BAA	30.0	3.4	0043	13.0	13.0	13.0	0043	13.0	13.0	13.0	
4A0031BAA	31.0	3.4	0043	13.0	13.0	13.0	0043	13.0	13.0	13.0	
4A0032BAA	32.0	3.4	0043	13.0	13.0	13.0	0043	13.0	13.0	13.0	
4A0033BAA	33.0	3.4	0043	13.0	13.0	13.0	0043	13.0	13.0	13.0	
4A0034BAA	34.0	3.4	0043	13.0	13.0	13.0	0043	13.0	13.0	13.0	
4A0035BAA	35.0	3.4	0043	13.0	13.0	13.0	0043	13.0	13.0	13.0	
4A0036BAA	36.0	3.4	0043	13.0	13.0	13.0	0043	13.0	13.0	13.0	
4A0037BAA	37.0	3.4	0043	13.0	13.0	13.0	0043	13.0	13.0	13.0	
4A0038BAA	38.0	3.4	0043	13.0	13.0	13.0	0043	13.0	13.0	13.0	
4A0039BAA	39.0	3.4	0043	13.0	13.0	13.0	0043	13.0	13.0	13.0	
4A0040BAA	40.0	3.4	0043	13.0	13.0	13.0	0043	13.0	13.0	13.0	
4A0041BAA	41.0	3.4	0043	13.0	13.0	13.0	0043	13.0	13.0	13.0	
4A0042BAA	42.0	3.4	0043	13.0	13.0	13.0	0043	13.0	13.0	13.0	
4A0043BAA	43.0	3.4	0043	13.0	13.0	13.0	0043	13.0	13.0	13.0	
4A0044BAA	44.0	3.4	0043	13.0	13.0	13.0	0043	13.0	13.0	13.0	
4A0045BAA	45.0	3.4	0043	13.0	13.0	13.0	0043	13.0	13.0	13.0	
4A0046BAA	46.0	3.4	0043	13.0	13.0	13.0	0043	13.0	13.0	13.0	
4A0047BAA	47.0	3.4	0043	13.0	13.0	13.0	0043	13.0	13.0	13.0	
4A0048BAA	48.0	3.4	0043	13.0	13.0	13.0	0043	13.0	13.0	13.0	
4A0049BAA	49.0	3.4	0043	13.0	13.0	13.0	0043	13.0	13.0	13.0	
4A0050BAA	50.0	3.4	0043	13.0	13.0	13.0	0043	13.0	13.0	13.0	

Drives Motors Controls



Options
J1000 Drive

EMC C1 Filters - may be used on the input of the drive to attenuate possible drive-generated noise. Filters should always be mounted as close to the drive as possible; these are designed such that the drive can be mounted to it, pancake-style. The drive should be installed with the EMC filters listed below in order to comply with the EN 61800-3, category C1 requirements. These C1 filters meet the requirements for CE.

Rated Input Voltage	Drive Model Number CIMR-JU	Rated Output Current (Amps)	Nominal HP	C1 Filter					
				Part Number	Rated Current (A)	Dimensions (in.)			Weight (lbs)
						H	W	D	
200-240V 1-Phase	BA0001BAA	1.2	1/8 & 1/4						
	BA0002BAA	1.9	1/4	FS23638-10-07	10	6.65	2.80	1.77	0.97
	BA0003BAA	3.3	1/2 & 3/4						
	BA0006BAA	6.0	1	FS23638-20-07	20	6.65	4.37	1.97	1.76
	BA0010BAA	9.6	2 & 3						
200-240V 3-Phase	2A0001BAA	1.2	1/8 & 1/4						
	2A0004BAA	1.9	1/4	FS23638-10-07	8	6.65	2.80	1.77	0.88
	2A0007BAA	3.3	1/2 & 3/4	FS23638-10-07	14	6.65	4.37	1.77	1.28
	2A0010BAA	6.0	1	FS23638-20-07	24	6.65	5.67	1.97	1.98
	2A0015BAA	9.6	2 & 3						
380-480V 3-Phase	4A0001BAA	1.2	1/8 & 1/4						
	4A0004BAA	4.1	1/2	FS23639-10-07	5	6.65	4.37	1.77	1.10
	4A0005BAA	5.4	3/4						
	4A0007BAA	6.9	1	FS23639-10-07	10	6.65	4.37	1.77	1.54
	4A0011BAA	11.1	2.5	FS23639-15-07	15	6.85	5.67	1.97	1.98

Drives Motors Controls



EMC C3 Filters (Conducted Interference Voltage Limits) - may be used on the input of a drive to attenuate possible drive-generated noise. An input filter with proper shielding, routing and grounding between itself and the drive is designed to reduce line-conducted noise levels within the limits of EN61800-3 Category C3, I ≤ 100A (second environment for industrial low-voltage supply network), when the drive's output conductors are properly routed and shielded in grounded steel conduit all the way to the motor. Filters should always be mounted as close to the drive as possible. The filters in combination with the drive meet UL and CE.

Rated Input Voltage	Drive Model Number CIMR-JU	Rated Output Current (Amps)	Nominal HP	C3 Filter Kit	
				Part Number	Rated Current (A)
200-240V 1-Phase	BA0001BAA	1.2	1/8 & 1/4	FS22800-5-A	5
	BA0002BAA	1.9	1/4		
	BA0003BAA	3.3	1/2 & 3/4	FS22800-9-A	9
	BA0004BAA	6.0	1	FS22800-16-A	16
200-240V 3-Phase	2A0001BAA	1.2	1/8	Consult Factor	Consult Factory
	2A0002BAA	1.9	1/4		
	2A0003BAA	3.3	3/8		
	2A0004BAA	6.0	3/4		
	2A0005BAA	9.6	1		
	2A0006BAA	12.0	1 1/2		
380-480V 3-Phase	4A0001BAA	1.2	1/2	FS22801-3-A	3
	4A0002BAA	2.1	3/4 & 1		
	4A0004BAA	4.1	2	FS22801-6-A	6
	4A0005BAA	5.4	3	FS22801-12-A	12
	4A0007BAA	6.9	4	FS22801-12-A	12
	4A0011BAA	11.0	7.5	FS22801-16-A	16

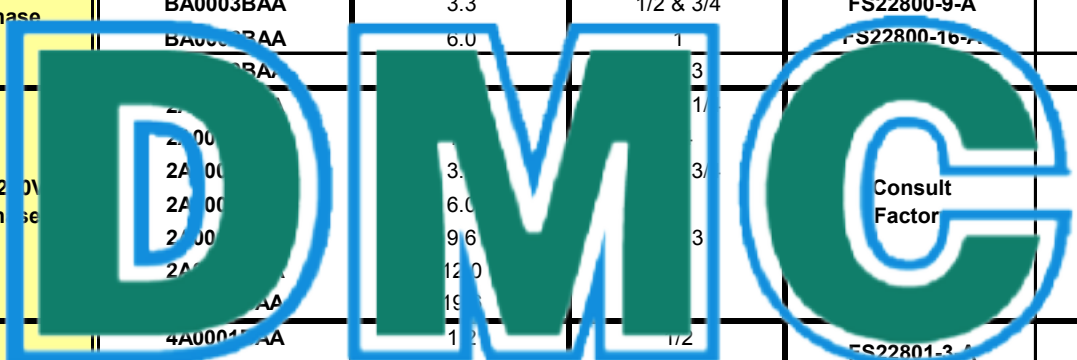

Drives Motors Controls

Note: Kit contains filter capacitor and mounting hardware.



Options
J1000 Drive

Dynamic Braking Resistor, 3% Duty Cycle - are rated for 3% duty cycle over a 100-second interval. Approximate braking torque for each rating is listed. These resistors are designed for separate panel mounting.

Rated Input Voltage	Drive Model Number CIMR-JU	Normal Duty		Heavy Duty		3% DB Resistor					Dimensions (in.)		
		Rated Output Current (Amps)	Nominal HP	Rated Output Current (Amps)	Nominal HP	Part Number	Qty Reqd	Resistance (Ohms) (Each)	Power (Watts) (Each)	Approx. Braking Torque (%)	H	W	D
200-240V 1-Phase	BA0001BAA	1.2	1/8 & 1/4	0.8	1/8	R7507	1	400	150	125	7.16	1.73	0.51
	BA0002BAA	1.9	1/4	1.6	1/4	R7507	1	400	150	125	7.16	1.73	0.51
	BA0003BAA	3.5	1/2 & 3/4	3.0	1/2	R7505	1	200	150	230	7.16	1.73	0.51
	BA0006BAA	6.0	1	5.0	3/4 & 1	R7505	1	200	150	230	7.16	1.73	0.51
	BA0010BAA	9.6	2 & 3	8.0	2	R7504	1	100	150	125	7.16	1.73	0.51
200-240V 3-Phase	BA0001BAA	1.2	1/8 & 1/4	0.8	1/8	R7507	1	400	150	125	7.16	1.73	0.51
	BA0002BAA	1.9	1/4	1.6	1/4	R7507	1	400	150	125	7.16	1.73	0.51
	BA0003BAA	3.5	1/2 & 3/4	3.0	1/2	R7505	1	200	150	230	7.16	1.73	0.51
	BA0006BAA	6.0	1	5.0	3/4 & 1	R7505	1	200	150	230	7.16	1.73	0.51
	BA0010BAA	9.6	2 & 3	8.0	2	R7504	1	100	150	125	7.16	1.73	0.51
380-480V 3-Phase	BA0001BAA	1.2	1/8 & 1/4	0.8	1/8	R7507	1	400	150	125	7.16	1.73	0.51
	BA0002BAA	1.9	1/4	1.6	1/4	R7507	1	400	150	125	7.16	1.73	0.51
	BA0003BAA	3.5	1/2 & 3/4	3.0	1/2	R7505	1	200	150	230	7.16	1.73	0.51
	BA0006BAA	6.0	1	5.0	3/4 & 1	R7505	1	200	150	230	7.16	1.73	0.51
	BA0010BAA	9.6	2 & 3	8.0	2	R7504	1	100	150	125	7.16	1.73	0.51

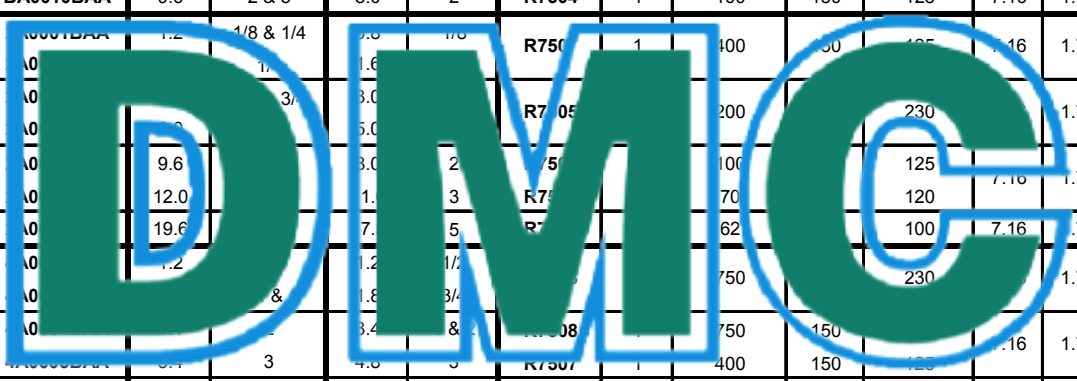

Drives Motors Controls



Dynamic Braking Resistor, 10% Duty Cycle - are rated for 10% duty cycle over a 100-second interval. Approximate braking torque for each rating is listed. These resistors are designed in vented NEMA 1 enclosures for separate panel mounting. The built-in braking module supports the 3% and 10% duty cycle resistors listed here and on the previous page.

Rated Input Voltage	Drive Model Number CIMR-JU	Normal Duty		Heavy Duty		10% DB Resistor						Dimensions (in.)		
		Rated Output Current (Amps)	Nominal HP	Rated Output Current (Amps)	Nominal HP	New Part No. USR000	Qty Reqd	Resistance (Ohms) (Each)	Power (Watts) (Each)	Approx. Braking Torque (%)				
										ND	HD	L	W	H
200-240V 1-Phase	BA0001BAA	1.2	1/8 & 1/4	0.8	1/8	032	1	750	600	120	150	12	7	5
	BA0002BAA	1.9	1/4	1.6	1/4	033	1	400	350	120	150	12	7	5
	BA0003BAA	3.5	1/2 & 3/4	3.0	1/2	022	1	200	250	120	150	12	5	5
	BA0006BAA	6.0	1	5.0	3/4 & 1	035	1	150	350	102	150	12	7	5
	BA0010BAA	9.6	2 & 3	8.0	2	024	1	70	250	107	150	12	5	5
200-240V 3-Phase	A0001BAA	1.2	1/8 & 1/4	0.8	1/8	032	1	750	600	120	150	12	7	5
	A0002BAA	1.9	1/4	1.6	1/4	033	1	400	350	120	150	12	7	5
	A0003BAA	3.5	1/2 & 3/4	3.0	1/2	022	1	200	250	120	150	12	5	5
	A0006BAA	6.0	1	5.0	3/4 & 1	035	1	150	350	102	150	12	7	5
	A0010BAA	9.6	2 & 3	8.0	2	024	1	70	250	107	150	12	5	5
	A0012BAA	12.0	3	10.0	3	025	1	40	250	107	107	12	5	5
	A0015BAA	15.0	4	12.0	4	025	1	40	250	111	111	12	7	5
380-480V 3-Phase	A0012BAA	12.0	3	10.0	3	032	1	750	600	120	150	12	7	5
	A0004BAA	4.1	2	3.4	1 & 2	022	1	250	200	119	119	12	7	5
	4A0005BAA	5.4	3	4.8	3	034	1	250	350	119	119	12	7	5
	4A0007BAA	6.9	4	5.5	3	034	1	250	350	119	119	12	7	5
	4A0009BAA	8.8	5	7.2	4	035	1	150	350	118	150	12	7	5
	4A0011BAA	11.1	7.5	9.2	5	035	1	150	350	118	150	12	7	5

Drives Motors Controls



Options
J1000 Drive

DIN Rail Mounting Kits - The DIN rail attachment kit allows the drive to be mounted on a 35 mm DIN rail. The DIN rail itself is not included in the kit. Option kit for customer mounting.

Rated Input Voltage	Drive Model Number CIMR-JU	Rated Output Current (Amps)	Nominal HP	DIN Rail Kit
				Part Number 72606-EZZ08122
200-240V 1-Phase	BA0001BAA	1.2	1/8 & 1/4	A
	BA0002BAA	1.9	1/4	
	BA0003BAA	3.3	1/2 & 3/4	B
	BA0006BAA	6.0	1	
	BA0010BAA	9.6	2 & 3	
200-240V 3-Phase	2A0001BAA	1.2	1/8 & 1/4	A
	2A0002BAA	1.9	1/4	
	2A0004BAA	3.5	1/2 & 3/4	B
	2A0006BAA	6.0	1	
	2A0010BAA	9.6	2 & 3	
380-480V 3-Phase	4A0001BAA	1.2	1/8 & 1/4	B
	4A0002BAA	1.9	1/4	
	4A0004BAA	3.5	1/2 & 3/4	C
	4A0006BAA	6.0	1	
	4A0010BAA	9.6	2 & 3	

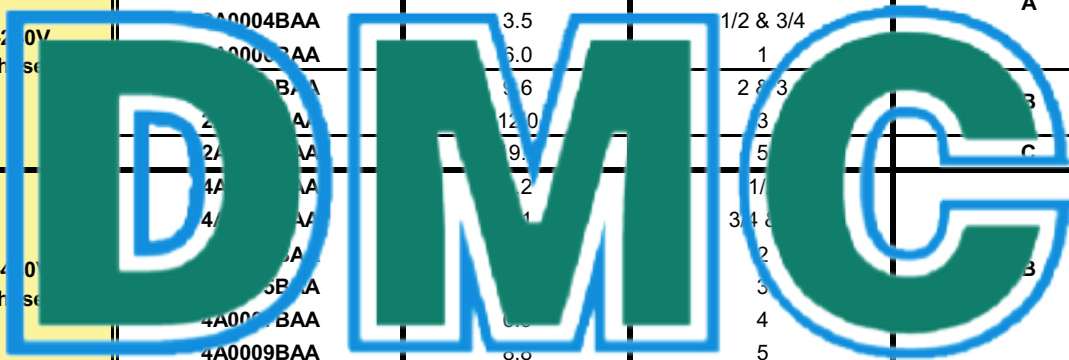

Drives Motors Controls



NEMA 1 Enclosure Kits - These kits provide a bottom metal box to protect fingers from hazardous voltages, and a top plastic cover to protect the drive from falling debris. Option kit for customer mounting.

Rated Input Voltage	Drive Model Number CIMR-JU	Rated Output Current (Amps)	Nominal HP	NEMA 1 Enclosure Kit
				Part Number EZZ020564__
200-240V 1-Phase	BA0001BAA	1.2	1/8 & 1/4	A
	BA0002BAA	1.9	1/4	
	BA0003BAA	3.3	1/2 & 3/4	
	BA0006BAA	6.0	1	
	BA0010BAA	9.6	2 & 3	
200-240V 3-Phase	2A0001BAA	1.2	1/8 & 1/4	A
	2A0002BAA	1.9	1/4	
	2A0004BAA	3.5	1/2 & 3/4	
	2A0006BAA	6.0	1	
	2A0010BAA	9.6	2 & 3	
	2A0012BAA	12.0	3	
	2A0016BAA	16.0	4	
	2A0020BAA	20.0	5	
	2A0025BAA	25.0	6	
	2A0030BAA	30.0	7.5	
	2A0037BAA	37.0	10	
380-480V 3-Phase	4A0003BAA	3.0	3/4	C
	4A0004BAA	4.0	1	
	4A0007BAA	7.0	2	
	4A0009BAA	9.0	3	
	4A0011BAA	11.1	3.5	

Drives Motors Controls



Options J1000 Drive

Remote Interface, RS232C. This option allows for RS232 communication to a Remote LED Digital Operator (JVOP-182).
Model No. SI-232/J

Remote Interface, RS232C. This option allows for RS232 communication to PC software such as DriveWizard Plus or USB Copy Unit (Y-Stick, JVOP-181).
Model No. SI-232/JC

Remote Interface, RS485/422. This option allows the drive to realize RS485/422 network communication with Modbus protocol.
Model No. SI-485/J

Analog Potentiometer Card. This option provides an analog potentiometer for frequency control, mounted to the front of the J1000 drive.
Model No. AI-232/J

USB Copy Unit (Y-Stick). This option allows the drive to store the USB port of a computer and load, copy, or save drive parameters from one drive to another. The unit ports to RS232C Remote Interface (SI-232/JC), sold separately.
Model No. JVOP-181

CopyUnitManager. This option allows the user to copy, save, and load parameters from a Copy Unit (JVOP-181), sold separately, to a PC and vice versa.
No Model No.

UL Rated Remote Operator. This option allows an existing Digital Operator to the wall of a separately priced, oversized UL Type 1, 3R, 4, 4X, or 12 enclosure (NEMA environment). Price includes a faceplate bezel with digital operator brackets and membrane to cover the operator cutout in the enclosure door, a 6-foot cable, a 10-foot cable, and a 1:1 template for cutting the necessary cutouts in the enclosure. Keypad can be removed after kit installation. Designed for use with the LED Operator (JVOP-182) sold separately.
Connects to RJ45 port and mounts to enclosure wall.
Model No. UUX000526 (Blank Membrane)
Model No. UUX000527 (Yaskawa Logo Membrane)

Operator, LED Digital Remote. This option allows the drive to be operated from a remote location. It requires the RS232C Remote Interface (SI-232/J), sold separately. This option also requires Installation Set A (EZZ020642A) for panel or door mounting and Remote Operator Cable (UWR0051 or UWR0052), each sold separately.
Model No. JVOP-182

Operator Cable, Remote. These cables are used to connect the Remote LED Digital Operator (JVOP-182). They are available in one (1) or three (3) meter lengths.
Model No. UWR0051 (1 meter)
Model No. UWR0052 (3 meter)

LED Keypad Installation Set A (Remote Operator Mounting Bracket Kit). This is a bracket to which the LED Digital Remote Operator (JVOP-182) attaches, and has (4) threaded holes and screws to attach to the cover of an enclosure. The kit contains (2) screws to mount the Operator and (4) screws to attach the keypad to the enclosure.
Model No. EZZ020642A

Keypad Installation Set B (Remote Operator Mounting Bracket Kit). Contains a mounting bracket that the keypad attaches to. The kit has (4) pre-drilled holes for mounting to an enclosure that has screws attached to the enclosure area. The kit contains (2) screws to mount the keypad and (4) screws to attach the keypad to the enclosure. The kit also includes a customer supplied template to be attached to the enclosure.
Model No. EZZ020642B

DriveWizard Plus Software. This optional software package allows upload and download of parameters via PC for data storage and for programming multiple drives. The software also includes graphing and monitoring tools. It is a Windows-based program designed to make startup, commissioning and troubleshooting of the J1000 as simple as possible. Refer to our website at www.yaskawa.com to download the software, and for more information, including minimum system requirements and cable information to interface a PC to the drive.
No Model No.

PC Interface Cable. This 6-foot cable interconnects the drive keypad port to the 9-pin communication port on a PC. It requires the RS232C Remote Interface (SI-232/JC), sold separately. This cable is used in conjunction with DriveWizard Plus software.
Model No. UWR00468-2



Drives Motors Controls



The V1000 is a world-class compact current vector drive that defines a new world standard. Demands for efficient production and better maintainability are on the rise, spurred by global competition. Yaskawa drives have earned a reputation for high performance, high functionality, and high quality.

Performance Features

- Ratings:
 - 1/8 to 5 HP (at 200 VAC, 50/60 Hz)
 - 1/8 to 25 HP (at 400 VAC, 50/60 Hz)
 - 1/2 to 25 HP (at 480 VAC, 50/60 Hz)
- Overload capacity:
 - 150% for 10 seconds (average duty)
 - 120% for 10 seconds (normal duty)
- Control Methods:
 - Open Loop Current Vector Control
 - PM Open Loop Current Vector Control
 - Simple closed loop speed control
- DC injection braking ramp to 0
- Electronic speed feedback control
- Adjustable acceleration and deceleration times up to 300 seconds
- Controlled speed range:
 - 40:1⁽¹⁾ 100:1⁽²⁾
- Speed Regulation:
 - ± 0.5 to 1% with slip compensation⁽¹⁾
 - ± 0.2%⁽²⁾
- Displacement power factor: 0.98
- Output frequency: 0 to 400 Hz
- Frequency resolution:
 - 0.01 Hz with digital reference
 - 0.06 / 60 Hz with analog reference
- Frequency accuracy:
 - 0.01% with digital command
 - 0.5% with analog command
- Volts / hertz ratio: infinitely adjustable pattern
- DC Injection braking: adjustable amplitude, duration, current limited
- Torque boost: full range, auto
- Power loss ride-thru: 0.5 sec.
- Speed search
- Auto restart
- 3 Critical frequency rejection settings
- Slip Compensation
- Energy Savings Function
- Enhanced PID with loss of feedback function

(1) V/f Mode
(2) Open Loop Current Vector Mode

Design Features

- Dual microprocessor logic
- Digital keypad operator, 8 digits
- LED status display
- Remote Control Keypad
- Remote Digital Open Stop Detector
- 7 bit digital input
- 3 bit digital output
- High resolution analog output: 54 bits, 3 bits
- Programmable output current for current limiting
- 24 bit digital input compatible with 16 bit digital input (PNP)
- 16 multi-speed settings plus load speed
- 2 Remote speed references:
 - 0-10 VDC (20 kohms) or isolated 4-20 mA (250 ohms)
- Signal follower: bias and gain
- 2 programmable open collector outputs
- Analog monitor output:
 - 0-1 VDC proportional to output frequency
 - 0 output current
- Approx. 400 parameters and monitors
- Digital pulse train input (50 kHz max.)
- RS-422/485 Modbus 115 kbps
- UL recognized electronic overload
- MTBF: 28 years
- Built-in Dynamic Braking Transistor
- NEMA 1 enclosure
- Side-by-Side mounting
- Application presets
- Maintenance monitors

Protective Features

- Current limit, stall prevention during accel, decel, and run
- Motor and drive overload
- Over voltage prevention function
- Instantaneous over current
- Short circuit
- Under voltage
- Heatsink overheat
- Ground fault protection
- Over/under torque
- Short circuit current rating: 30kA rms sym.

Service Conditions

- Ambient service temperature:
 - 10° to 40° C (+14° to 104°F) NEMA 1
 - 10° to 40° C (+14° to 104°F) Open Chassis
- Storage temperature:
 - 30° to 70° C (-22° to 158°F)
- Humidity:
 - Relative humidity up to 95% non-condensing
 - Altitude: to 3300 ft, higher by derating
 - Service factor: 1.0
- Input voltage: -15% to +10%
- Output voltage: 240 VAC, 380 to 480 VAC
- Output frequency: 50/60 Hz
- Phase sequence sensitive
- Dynamic Braking Transistor (external)
- Multi-lingual, full-text remote LCD w/ copy
- Profibus-DP, DeviceNet Communications
- Modbus TCP/IP, EtherNet/IP Communications
- MECHATROLINK-II communications
- DriveWizard Plus
- CASE software
- DIN rail mounting kit
- USB Copy Unit (Y-Stick)
- Reactors, 3% and 5%
- Adapter plates
- External heatsink kits
- 24V control power unit
- Remote LED operator
- Remote LCD operator
- 120V interface

Standards

- UL 508C (Power Conversion)
- CSA 22.2 No. 14-95 (Industrial Control Equipment)
- UL, cUL listed; CE marked
- RoHS compliant
- EN 50178 (LVD)
- EN 50081-2, EN 50082-2 (EMC)
- EN 954-1, Category 3 Safety Standard
- EN 61800-3
- IEC 529, 146
- FCC CFR 47 Part 15 Subpart B (w/ External Filter)
- TUV

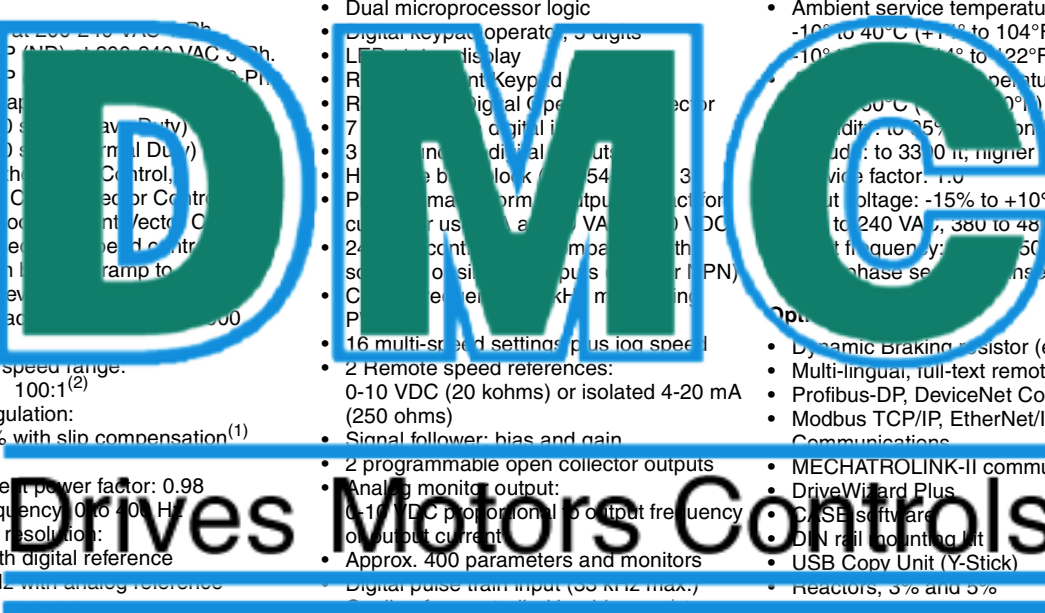

Drives Motors Controls

This page intentionally left blank

DMC

Drives Motors Controls

Rated Input Voltage	Drive Model Number CIMR-VU ⁽³⁾	Normal Duty ⁽¹⁾		Heavy Duty ⁽¹⁾	
		Rated Output Current (Amps)	Nominal HP ⁽²⁾	Rated Output Current (Amps)	Nominal HP ⁽²⁾
200-240V 1-Phase	BA0001FAA	1.2	1/8 & 1/4	0.8	1/8
	BA0002FAA	1.9	1/4	1.6	1/4
	BA0003FAA	3.3	1/2 & 3/4	3.0	1/2
	BA0006FAA	6.0	1	5.0	3/4 & 1
	BA0010FAA	9.6	2 & 3	8.0	2
	BA0012FAA	12.0	3	11.0	3
	BA0018FAA	17.5	5	17.5	5
200-240V 3-Phase	2A0001FAA	1.2	1/8 & 1/4	0.8	1/8
	2A0002FAA	1.9	1/4	1.6	1/4
	2A0003FAA	3.3	1/2 & 3/4	3.0	1/2
	2A0006FAA	6.0	1	5.0	3/4 & 1
	2A0010FAA	9.6	2 & 3	8.0	2
	2A0012FAA	12.0	3	11.0	3
	2A0018FAA	17.5	5	17.5	5
	2A0030FAA	30.0	10	30.0	10
	2A0040FAA	40.0	15	40.0	15
	2A0060FAA	60.0	20	60.0	20
380-480V 3-Phase	4A0001FAA	1.2	1/8 & 1/4	0.8	1/8
	4A0002FAA	2.1	3/4 & 1	1.8	3/4
	4A0004FAA	4.1	2	3.4	1 & 2
	4A0005FAA	5.4	3	4.5	3
	4A0007FAA	6.9	4	5.5	3
	4A0009FAA	8.3	5	7.2	4
	4A0011FAA	11.1	7.5	9.2	5
	4A0018FAA	17.5	10	14.8	7.5 & 10
	4A0023FAA	23.0	15	18.0	10
	4A0031FAA	31.0	20	24.0	15
4A0038FAA	38.0	25	31.0	20	



Drives Motors Controls

- (1) Normal Duty overload current rating is 120% of rated output current for 60 seconds; Heavy Duty overload current rating is 150% of rated output current for 60 seconds
- (2) Horsepower rating is based on 230-volt and 460-volt induction-type squirrel-cage NEMA B 4-pole motors as represented in NEC table 430.250 Full-Load Current, Three-Phase Alternating Current Motors
- (3) All standard V1000 ratings are typically in stock.

V1000

V1000 Drive Variants

V1000 Finless - Finless (flat heatsink) drives are intended to be installed in a customer's enclosure with an external heatsink. Replace standard "FAA" at end of drive model number with "JAA" (or "LAA").

V1000 Open Chassis - Open chassis drives are intended to be installed in a customer's enclosure and meet IP20 ("BAA") or IP00 ("AAA"). Replace standard "FAA" at end of drive model number with "BAA" (or "AAA").

V1000 w/ C3 Filter - These drives include a built-in C3 filter; see "EMC C3 Filters" on page 29. Replace standard "FAA" at end of drive model number with "EAA."

Rated Input Voltage	Normal Duty ⁽¹⁾		Heavy Duty ⁽¹⁾		Finless ^(3, 4)	Open ^(3, 4)	w/ C3 Filter ^(3, 4)
	Rated Output Current (Amps)	Nominal HP ⁽²⁾	Rated Output Current (Amps)	Nominal HP ⁽²⁾	Drive Model Number CIMR-VU	Drive Model Number CIMR-VU	Drive Model Number CIMR-VU
200V, 1-Phase	1.2	1/8 & 1/4	0.8	1/8	BA0001JAA	BA0001BAA	BA0001EAA
	1.6	1/4	1.6	1/4	BA0002JAA	BA0002BAA	BA0002EAA
	3.0	3/8	3.0	3/8	BA0003JAA	BA0003BAA	BA0003EAA
	5.0	3/4	5.0	3/4	BA0006JAA	BA0006BAA	BA0006EAA
	7.5	1 & 1 1/2	7.5	1	BA0010JAA	BA0010BAA	BA0010EAA
	11.0	1 1/2 & 2	11.0	1 1/2	BA0012JAA	BA0012BAA	BA0012EAA
	18.0	3	18.0	3	BA0018JAA	BA0018BAA	Consult Factory
200V, 3-Phase	6.0	3/4	6.0	3/4	2A0006JAA	2A0006BAA	2A0006EAA
	9.6	2 & 3	9.6	2	2A0010JAA	2A0010BAA	2A0010EAA
	12.0	3	12.0	3	2A0012JAA	2A0012BAA	Consult Factory
	25.0	7.5 & 10	25.0	7.5	2A0030JAA	2A0030AAA	2A0030EAA
	33.0	10	33.0	10	2A0040JAA	2A0040AAA	2A0040EAA
	47.0	15	47.0	15	2A0060JAA	2A0060AAA	2A0060EAA
	55.0	20	55.0	20	2A0080JAA	2A0080AAA	2A0080EAA
400V, 3-Phase	1.2	1/2	1.2	1/2	4A0001JAA	4A0001BAA	4A0001EAA
	2.1	3/4 & 1	1.8	3/4	4A0002JAA	4A0002BAA	4A0002EAA
	4.1	2	3.4	1 & 2	4A0004JAA	4A0004BAA	4A0004EAA
	5.4	3	4.8	3	4A0005JAA	4A0005BAA	4A0005EAA
	6.9	4	5.5	3	4A0007JAA	4A0007BAA	4A0007EAA
	8.8	5	7.2	4	4A0009JAA	4A0009BAA	4A0009EAA
	11.1	7.5	9.2	5	4A0011JAA	4A0011BAA	4A0011EAA
	18.0	10	15.0	7.5 & 10	4A0018JAA	4A0018AAA	4A0018EAA
	23.0	15	18.0	10	4A0023JAA	4A0023AAA	4A0023EAA
31.0	20	25.8	15	4A0031JAA	4A0031AAA	Consult Factory	
38.0	25	31.7	20	4A0038JAA	4A0038AAA	4A0038EAA	

(1) Normal Duty overload current rating is 120% of rated output current for 60 seconds; Heavy Duty overload current rating is 150% of rated output current for 60 seconds

(2) Horsepower rating is based on standard NEMA B 4-pole motor design and NEC table 430.150 Full-Load Current, Three-Phase Alternating Current Motors

(3) All variant drives have a 16-week lead time unless a forecast is provided

(4) Consult factory to ensure any desired options are compatible with variant drives



V1000 Conformal Coat - These drives include circuit boards that have been conformally coated with Humiseal™ for humidity and dust resistance. Note that this variant is only available in open chassis at this time. Replace standard “FAA” at end of drive model number with “BMA” (or “AMA”).

V1000 Shakeproof - These drives include components that have been strengthened for increased vibration resistance. Note that this variant is only available in finless version at this time. Replace standard “FAA” at end of drive model number with “JSA.”

V1000 w/ 1167 Hz Software - These drives include custom software that allows output frequencies up to 1167 Hz. Delete “CIMR-” prefix and add “-134” at end of drive model number.

Rated Input Voltage	Normal Duty ⁽¹⁾		Heavy Duty ⁽¹⁾		Conformal Coat ^(3, 4)	Shakeproof ^(3, 4)	1167 Hz ^(3, 4)
	Rated Output Current (Amps)	Nominal HP ⁽²⁾	Rated Output Current (Amps)	Nominal HP ⁽²⁾	Drive Model Number CIMR-VU	Drive Model Number CIMR-VU	Drive Model Number VU
200V, 1-Phase	0.75	1/4	0.75	3/8	Consult Factory	Consult Factory	EA0001FAA-134
	1.1	1/2	1.1	1/2	Consult Factory	Consult Factory	EA0002FAA-134
	1.5	3/4	1.5	3/4	Consult Factory	Consult Factory	EA0003FAA-134
	2.2	1	2.2	1	Consult Factory	Consult Factory	EA0006FAA-134
	3.0	1 & 1/2	3.0	1 & 1/2	Consult Factory	Consult Factory	EA0010FAA-134
	3.7	2	3.7	2	Consult Factory	Consult Factory	EA0012FAA-134
200V, 3-Phase	0.75	1/4	0.75	3/8	Consult Factory	Consult Factory	2A0001FAA-134
	1.1	1/2	1.1	1/2	2A0002BMA	Consult Factory	2A0002FAA-134
	1.5	3/4	1.5	3/4	2A0004BMA	Consult Factory	2A0004FAA-134
	2.2	1	2.2	1	2A0006BMA	2A0006JSA	2A0006FAA-134
	3.0	1 & 1/2	3.0	1 & 1/2	2A0010BMA	2A0010JSA	2A0010FAA-134
	3.7	2	3.7	2	2A0012BMA	2A0012JSA	2A0012FAA-134
	5.5	3	5.5	3	2A0020BMA	2A0020JSA	2A0020FAA-134
	7.5	5	7.5	5	2A0030BMA	2A0030JSA	2A0030FAA-134
	11.0	7.5 & 10	11.0	7.5	2A0040BMA	Consult Factory	2A0040FAA-134
	15.0	10	15.0	10	Consult Factory	Consult Factory	2A0069FAA-134
400V, 3-Phase	1.2	1/2	1.2	1/2	Consult Factory	Consult Factory	4A0001FAA-134
	1.8	3/4	1.8	3/4	4A0002BMA	Consult Factory	4A0002FAA-134
	3.0	1	3.0	1	4A0004BMA	4A0004JSA	4A0004FAA-134
	4.2	1 & 1/2	4.2	1 & 1/2	4A0005BMA	4A0005JSA	4A0005FAA-134
	6.0	2	6.0	2	4A0007BMA	4A0007JSA	4A0007FAA-134
	8.4	3	8.4	3	4A0009BMA	4A0009JSA	4A0009FAA-134
	11.1	4	11.1	4	4A0011BMA	4A0011JSA	4A0011FAA-134
	15.0	5	15.0	5	4A0018AMA	Consult Factory	4A0018FAA-134
	20.0	7.5 & 10	20.0	7.5 & 10	4A0023AMA	Consult Factory	4A0023FAA-134
	25.8	10	25.8	10	Consult Factory	Consult Factory	4A0031FAA-134
31.7	15	31.7	15	Consult Factory	Consult Factory	4A0038FAA-134	

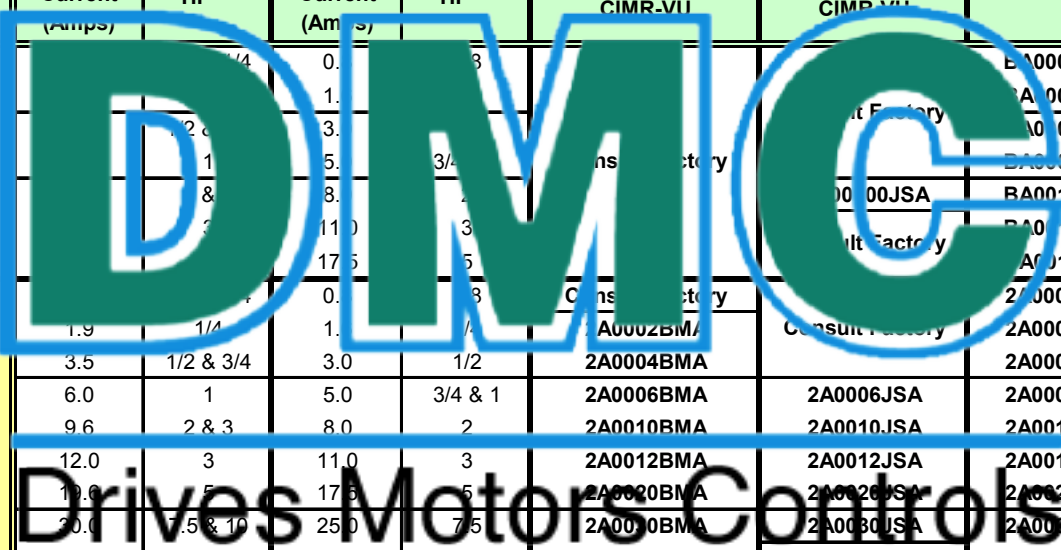

- (1) Normal Duty overload current rating is 120% of rated output current for 60 seconds; Heavy Duty overload current rating is 150% of rated output current for 60 seconds
- (2) Horsepower rating is based on standard NEMA B 4-pole motor design and NEC table 430.150 Full-Load Current, Three-Phase Alternating Current Motors
- (3) All variant drives have a 16-week lead time unless a forecast is provided
- (4) Consult factory to ensure any desired options are compatible with variant drives

Dimensions and Data

Rated Input Voltage	Drive Model Number CIMR-VU	Normal Duty		Heavy Duty		Physical Dimensions (in.)			Mounting Dimensions		Weight (lbs.) ⁽¹⁾	Drawing Number DD.V1K.FR_
		Rated Output Current (Amps)	Nominal HP	Rated Output Current (Amps)	Nominal HP	H	W	D	H1	W1		
200-240V 1-Phase	BA0001_A	1.2	1/8 & 1/4	0.8	1/8	5.89	2.68	2.99	5.10	2.20	1.8	1
	BA0002_A	1.9	1/4	1.6	1/4	5.89	2.68	2.99	5.10	2.20	1.8	1
	BA0003_A	3.3	1/2 & 3/4	3.0	1/2	5.89	2.68	4.65	5.10	2.20	2.6	3
	BA0006_A	6.0	1	5.0	3/4 & 1	5.89	4.25	5.41	5.10	3.78	4.2	8
	BA0010_A	9.6	2 & 3	8.0	2	5.89	4.25	6.06	5.10	3.78	4.4	10
	BA0012_A	12.0	3	11.0	3	6.02	5.51	6.42	5.24	5.04	5.7	12
	BA0018_A	17.5	5	17.5	5	6.02	6.69	7.09	5.24	6.22	6.6	13
200-240V 3-Phase	BA0001_A	1.2	1/8 & 1/4	0.8	1/8	5.89	2.68	2.99	5.10	2.20	1.8	1
	BA0002_A	1.9	1/4	1.6	1/4	5.89	2.68	2.99	5.10	2.20	1.8	1
	BA0003_A	3.3	1/2 & 3/4	3.0	1/2	5.89	2.68	4.65	5.10	2.20	2.6	2
	BA0006_A	6.0	1	5.0	3/4 & 1	5.89	4.25	5.41	5.10	3.78	4.2	4
	BA0010_A	9.6	2 & 3	8.0	2	5.89	4.25	6.06	5.10	3.78	4.2	7
	BA0012_A	12.0	3	11.0	3	6.02	5.51	6.42	5.24	5.04	5.7	8
	BA0018_A	17.5	5	17.5	5	6.02	6.69	7.09	5.24	6.22	6.6	11
	BA0023_A	24.0	7.5 & 10	19.2	7.5 & 10	10.00	5.51	5.51	9.21	4.80	8.4	14
	BA0031_A	31.0	20	25.8	15	11.42	7.09	5.63	10.63	6.30	11.4	14
	BA0038_A	38.0	25	31.7	20	11.42	7.09	6.42	10.63	6.30	12.1	16
380-480V 3-Phase	4A0001_A	1.2	1/2	1.2	1/2	5.89	4.25	3.19	5.10	3.78	2.6	5
	4A0002_A	2.1	3/4 & 1	1.8	3/4	5.89	4.25	3.90	5.10	3.78	3.1	6
	4A0004_A	4.1	2	3.7	1.5 & 2	5.89	4.25	3.77	5.10	3.78	3.3	8
	4A0005_A	5.4	3	4.8	3	5.89	4.25	6.06	5.10	3.78	4.2	9
	4A0007_A	6.9	4	5.5	3	5.89	4.25	6.06	5.10	3.78	4.2	9
	4A0009_A	8.8	5	7.2	4	5.89	4.25	6.06	5.10	3.78	4.2	9
	4A0011_A	11.1	7.5	9.2	5	6.02	5.51	6.63	5.24	5.04	5.7	11
	4A0018_A	18.0	10	15.0	7.5 & 10	10.00	5.51	5.51	9.21	4.80	8.4	14
4A0023_A	24.0	15	19.2	10	10.00	5.51	5.51	9.21	4.80	8.4	14	
4A0031_A	31.0	20	25.8	15	11.42	7.09	5.63	10.63	6.30	11.4	15	
4A0038_A	38.0	25	31.7	20	11.42	7.09	6.42	10.63	6.30	12.1	16	

(1) This data represents the drive weight only, not shipping weight.

Dimension Drawing

DD.V1000.01
V1000 NEMA 1

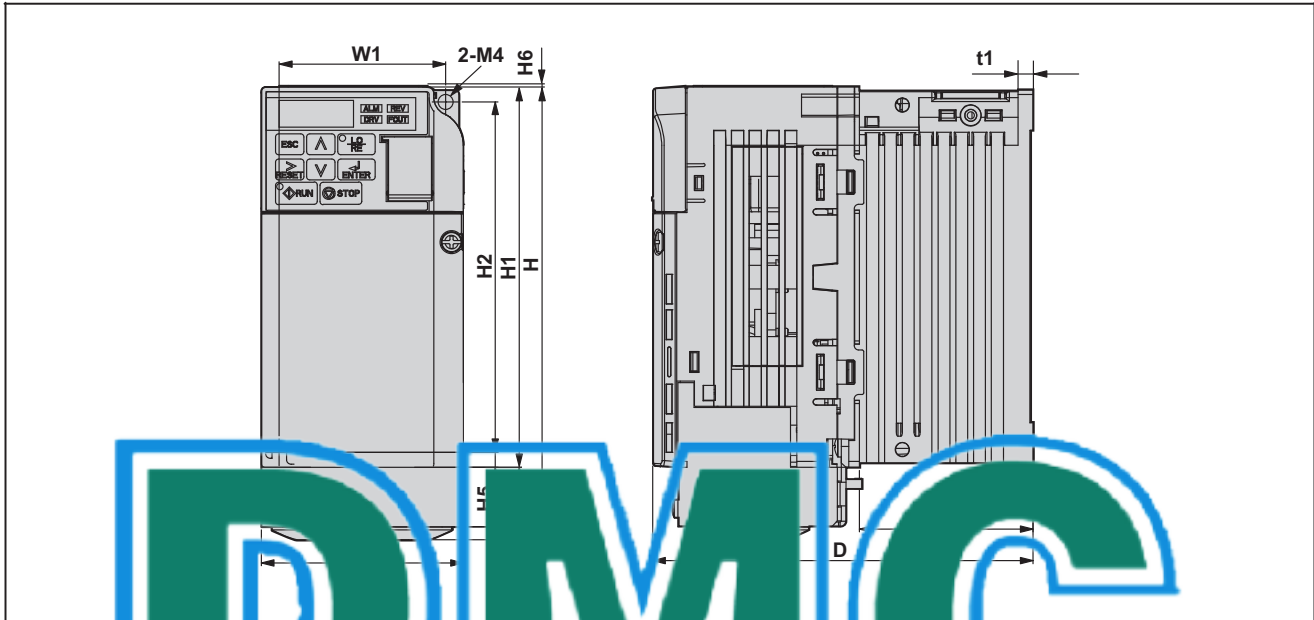

Voltage Class	Drive Model	W1	H2	H1	H	t1	D	D1	H3	H4	H5	Weight (lb.)		
Single-Phase 200 V Class	BA0002F	2.20	4.65	2.68	5.03	2.99	0.12	0.20	0.26	5.89	0.79	0.16	0.06	1.8
	BA0003F	2.20	4.65	2.68	5.03	2.99	0.12	0.20	0.26	5.89	0.79	0.16	0.06	1.8
	2A0001F	2.20	4.65	2.68	5.03	2.99	0.12	0.20	0.26	5.89	0.79	0.16	0.06	2.6
Three-Phase 200 V Class	2A0002F	2.20	4.65	2.68	5.03	2.99	0.12	0.20	0.26	5.89	0.79	0.16	0.06	1.8
	2A0004F	2.20	4.65	2.68	5.03	4.25	0.20	0.20	1.54	5.89	0.79	0.16	0.06	2.4
	2A0006F	2.20	4.65	2.68	5.03	4.04	0.10	0.20	2.32	5.89	0.79	0.16	0.06	2.9

Drives Motors Controls

V1000

Dimension Drawing

DD.V1000.02

V1000 NEMA 1

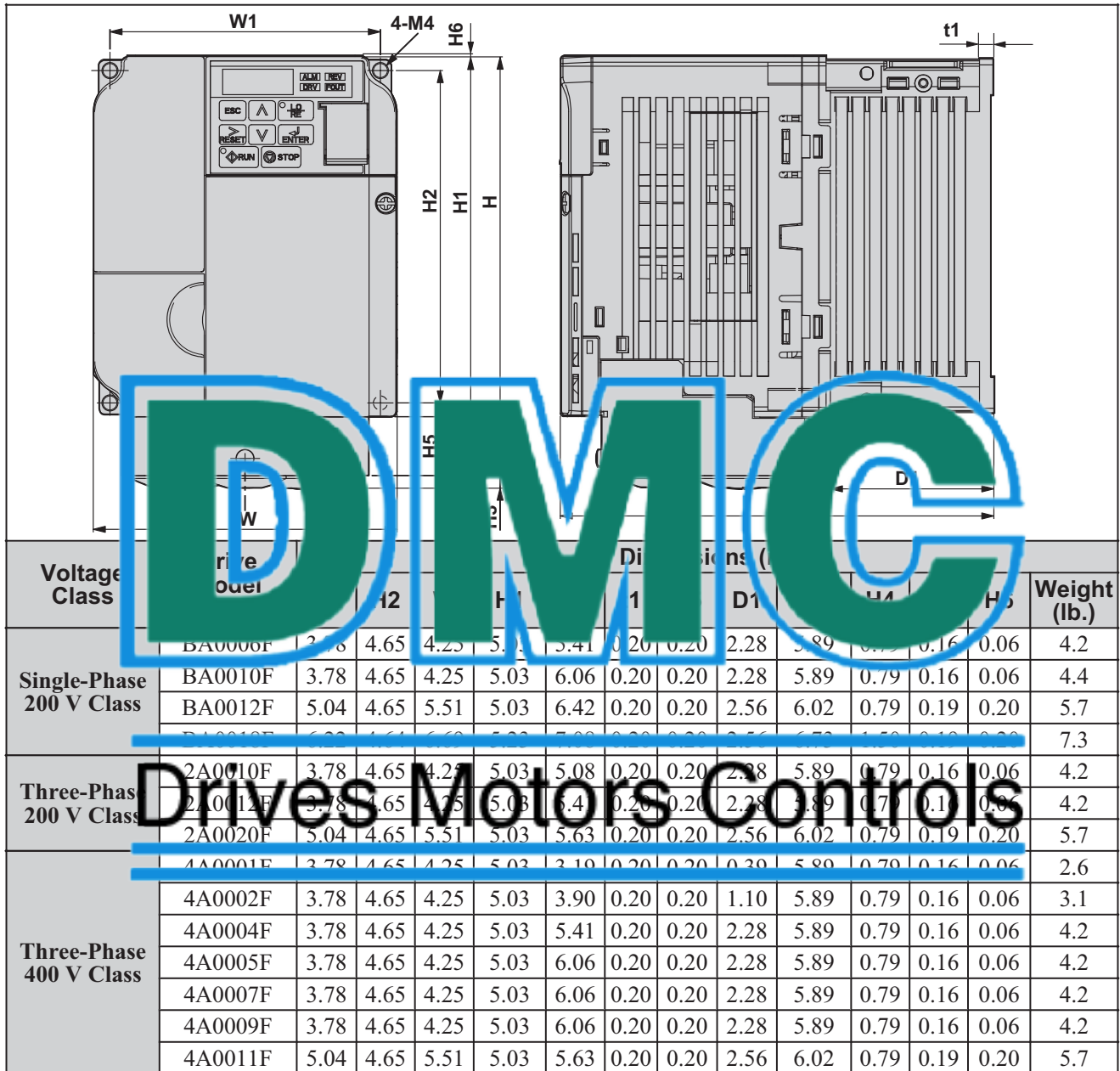

Dimension Drawing

DD.V1000.03
V1000 NEMA 1

V1000

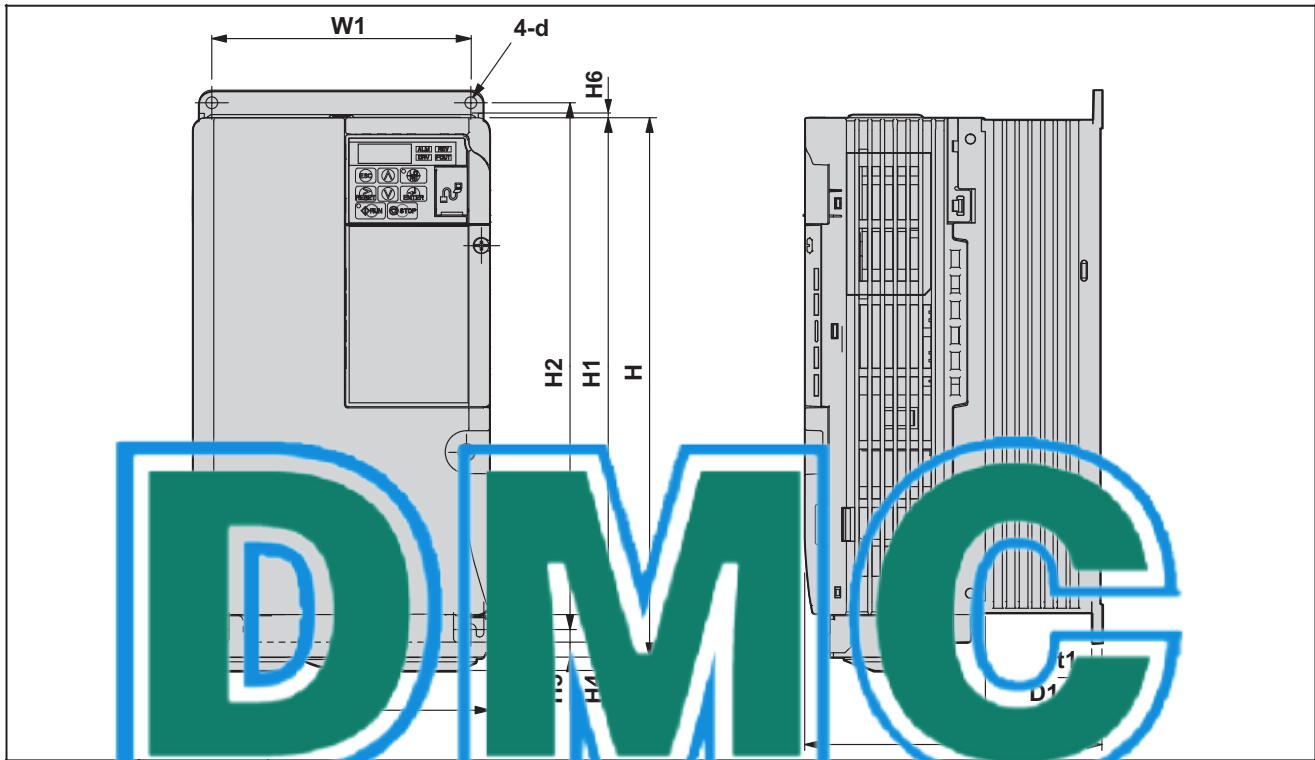

Voltage Class	Model CIMR-VU	Dimensions (in)													Weight (lb.)
		W1	H2	W	H1	D	t1	H5	D1	H	H4	H3	H6	d	
Three-Phase 200 V Class	2A0030F	4.80	9.76	5.51	9.21	5.51	0.20	0.51	2.17	10.00	0.51	0.24	0.06	M5	8.4
	2A0040F	4.80	9.76	5.51	9.21	5.51	0.20	0.51	2.17	10.00	0.51	0.24	0.06	M5	8.4
	2A0056F	6.30	11.18	7.09	10.63	6.42	0.20	0.51	2.95	11.42	0.59	0.24	0.06	M5	12.1
	2A0069F	7.56	13.23	8.66	12.60	7.36	0.20	0.87	3.07	13.78	0.59	0.28	0.06	M5	20.3
Three-Phase 400 V Class	4A0018F	4.80	9.76	5.51	9.21	5.51	0.20	0.51	2.17	10.00	0.51	0.24	0.06	M5	8.4
	4A0023F	4.80	9.76	5.51	9.21	5.51	0.20	0.51	2.17	10.00	0.51	0.24	0.06	M5	8.4
	4A0031F	6.30	11.18	7.09	10.63	5.63	0.20	0.51	2.17	11.42	0.59	0.24	0.06	M5	11.5
	4A0038F	6.30	11.18	7.09	10.63	6.42	0.20	0.51	2.95	11.42	0.51	0.24	0.06	M5	12.1

Drives Motors Controls

This page intentionally left blank

DMC

Drives Motors Controls



Reactor, 3% and 5% Impedance - may be used on either the input or output of a drive to reduce the effect of load or line side transients on the drive. The three-phase reactors are available loose in a separate NEMA 1 enclosure.

Rated Input Voltage	Drive Model Number CIMR-VU	Rated Output Current (Amps)	Nominal HP	3% Enclosed Reactor			5% Enclosed Reactor				
				Part Number 05P00620-	Dimensions (in.)			Part Number 05P00620-	Dimensions (in.)		
					H	L	W		H	L	W
200-240V 1-Phase	BA0001_A	1.2	1/8 & 1/4		8.0	8.0	6.0	0015	8.0	8.0	6.0
	BA0002_A	1.9	1/4	0020	8.0	8.0	6.0	0021	8.0	8.0	6.0
	BA0003_A	3.3	1/2 & 3/4	0020	8.0	8.0	6.0	0021	8.0	8.0	6.0
	BA0006_A	6.0	1	0027	8.0	8.0	6.0	0028	8.0	8.0	6.0
	BA0010_A	9.6	2 & 3	0027	8.0	8.0	6.0	0028	8.0	8.0	6.0
	BA0012_A	12.0	3	0032	8.0	8.0	6.0	0033	8.0	8.0	6.0
200-240V 3-Phase	BA0018_A	17.5	5	0036	8.0	8.0	6.0	0037	8.0	8.0	6.0
	2A0002_A	1.9	1/4	0020	8.0	8.0	6.0	0021	8.0	8.0	6.0
	2A0004_A	3.3	1/2 & 3/4	0020	8.0	8.0	6.0	0021	8.0	8.0	6.0
	2A0006_A	6.0	1	0027	8.0	8.0	6.0	0028	8.0	8.0	6.0
	2A0010_A	9.6	2 & 3	0027	8.0	8.0	6.0	0028	8.0	8.0	6.0
	2A0012_A	12.0	3	0032	8.0	8.0	6.0	0033	8.0	8.0	6.0
380-480V 3-Phase	2A0020_A	19.0	5	0036	8.0	8.0	6.0	0037	8.0	8.0	6.0
	2A0040_A	40.0	10	0046	13.0	13.0	13.0	0047	13.0	13.0	13.0
	2A0056_A	56.0	20	0054	13.0	13.0	13.0	0055	13.0	13.0	13.0
	2A0069_A	69.0	25	0058	13.0	13.0	13.0	0059	13.0	13.0	13.0
	4A0001_A	1.2	1/2	0015	8.0	8.0	6.0	0016	8.0	8.0	6.0
	4A0002_A	2.1	3/4 & 1	0021	8.0	8.0	6.0	0022	8.0	8.0	6.0
380-480V 3-Phase	4A0003_A	4.0	1	0028	8.0	8.0	6.0	0029	8.0	8.0	6.0
	4A0005_A	5.0	1	0033	8.0	8.0	6.0	0034	8.0	8.0	6.0
	4A0007_A	7.5	1	0036	8.0	8.0	6.0	0037	8.0	8.0	6.0
	4A0011_A	11.1	7.5	0042	13.0	13.0	13.0	0043	13.0	13.0	13.0
	4A0018_A	17.5	10	0042	13.0	13.0	13.0	0043	13.0	13.0	13.0
	4A0023_A	23.0	15	0047	13.0	13.0	13.0	0048	13.0	13.0	13.0
4A0031_A	31.0	20	0047	13.0	13.0	13.0	0048	13.0	13.0	13.0	
4A0038_A	38.0	25	0051	13.0	13.0	13.0	0052	13.0	13.0	13.0	

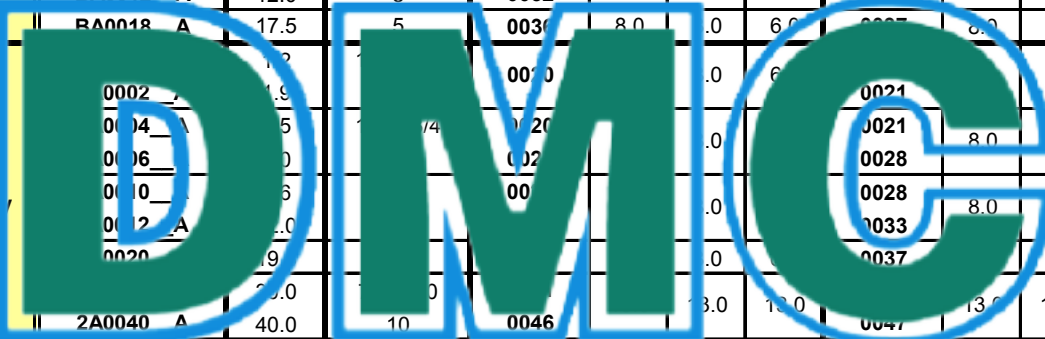

Drives Motors Controls



Options

V1000 Drive

EMC C1 Filters - may be used on the input of the drive to attenuate possible drive-generated noise. Filters should always be mounted as close to the drive as possible; these are designed such that the drive can be mounted to it, pancake-style. The drive should be installed with the EMC filters listed below in order to comply with the EN 61800-3, category C1 requirements. These C1 filters meet the requirements for CE. Note: EMC filters for models CIMR-VU2A0030 through 0069 are in compliance with EN 61800-3, Category 2. All other models comply with Category 1.

Rated Input Voltage	Drive Model Number CIMR-VU	Rated Output Current (Amps)	Nominal HP	C1 Filter					
				Part Number	Rated Current (A)	Dimensions (in.)			Weight (lbs)
						H	W	D	
200-240V 1-Phase	BA0001__A	1.2	1/8 & 1/4						
	BA0002__A	1.9	1/4	FS23638-10-07	10	6.65	2.80	1.77	0.97
	BA0003__A	3.3	1/2 & 3/4						
	BA0006__A	6.0	1	FS23638-20-07	20	6.65	3.07	1.97	1.76
	BA0010__A	9.6	2 & 3						
	BA0012__A	12.0	3	FS23638-30-07	30	6.65	3.34	1.97	2.64
200-240V 3-Phase	BA0015__A	15.0	3 & 4						
	BA0020__A	20.0	3 & 4	FS23637-8-07	8	6.65	2.80	1.57	0.88
	BA0030__A	30.0	5						
	BA0040__A	40.0	7.5 & 10	FS23637-14-07	14	6.65	3.07	1.77	1.28
	2A0020__A	19.6	5	FS23637-24-07	24	6.85	3.07	1.97	1.98
	2A0030__A	30.0	7.5 & 10	FS23637-52-07	52	11.97	5.39	2.20	4.41
	2A0040__A	40.0	10						
	2A0056__A	56.0	20	FS23637-68-07	68	13.39	6.89	2.56	5.73
380-480V 3-Phase	4A0069__A	69.0	25	FS23637-80-07	80	15.47	8.35	2.56	6.83
	4A0001__A	1.2	1/8 & 1/4						
	4A0002__A	1.9	1/4	FS23639-5-07	5	6.65	4.37	1.77	1.10
	4A0004__A	3.3	1/2 & 3/4						
	4A0005__A	5.0	3/4						
	4A0007__A	6.9	1	FS23639-10-07	10	6.65	4.37	1.77	1.54
	4A0009__A	8.8	1.5						
	4A0011__A	11.1	2	FS23639-15-07	15	6.85	5.67	1.97	1.98
	4A0018__A	17.5	2.5	FS23639-30-07	30	11.97	5.39	2.20	3.97
	4A0023__A	23.0	3						
4A0031__A	31.0	4							
4A0038__A	38.0	5	FS23639-50-07	50	13.39	6.89	2.56	5.95	

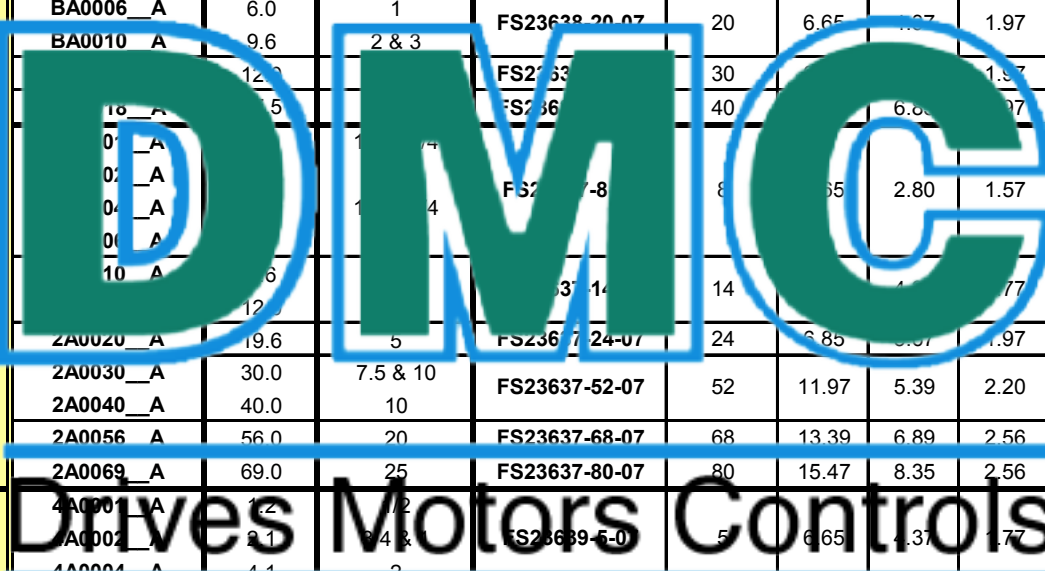

Drives Motors Controls



EMC C3 Filters (Conducted Interference Voltage Limits) - may be used on the input of a drive to attenuate possible drive-generated noise. An input filter with proper shielding, routing and grounding between itself and the drive is designed to reduce line-conducted noise levels within the limits of EN61800-3 Category C3, I ≤ 100A (second environment for industrial low-voltage supply network), when the drive's output conductors are properly routed and shielded in grounded steel conduit all the way to the motor. The filters in combination with the drive meet UL and CE.

Rated Input Voltage	Drive Model Number CIMR-VU	Rated Output Current (Amps)	Nominal HP	C3 Filter Kit	
				Part Number	Rated Current (A)
200-240V 1-Phase	BA0001_A	1.2	1/8 & 1/4	FS22800-5-B	5
	BA0002_A	1.9	1/4		
	BA0003_A	3.3	1/2 & 3/4		
	BA0006_A	6.0	1		
	BA0011_A	9.6	2 & 3		
	BA0012_A	12.0	3		
200-240V 3-Phase	2A0001_A	1.2	1/8 & 1/4	Consult Factory	Consult Factory
	2A0002_A	1.9	1/4		
	2A0003_A	3.5	1/4		
	2A0004_A	5.0	1/4		
	2A0005_A	9.0	1/2		
	2A0012_A	12.0	3		
	2A0020_A	19.0	5		
	2A0030_A	30.0	7.5 & 10		
	2A0040_A	40.0	10		
	2A0056_A	56.0	20		
2A0069_A	69.0	25			
380-480V 3-Phase	4A0001_A	1.2	1/2	FS22801-3-B	3
	4A0002_A	2.1	3/4 & 1		
	4A0004_A	4.1	2		
	4A0005_A	5.4	3		
	4A0007_A	6.9	4		
	4A0009_A	8.8	5		
	4A0011_A	11.1	7.5		
	4A0018_A	17.5	10		
	4A0023_A	23.0	15		
4A0031_A	31.0	20	FS22801-44-B	44	
4A0038_A	38.0	25			

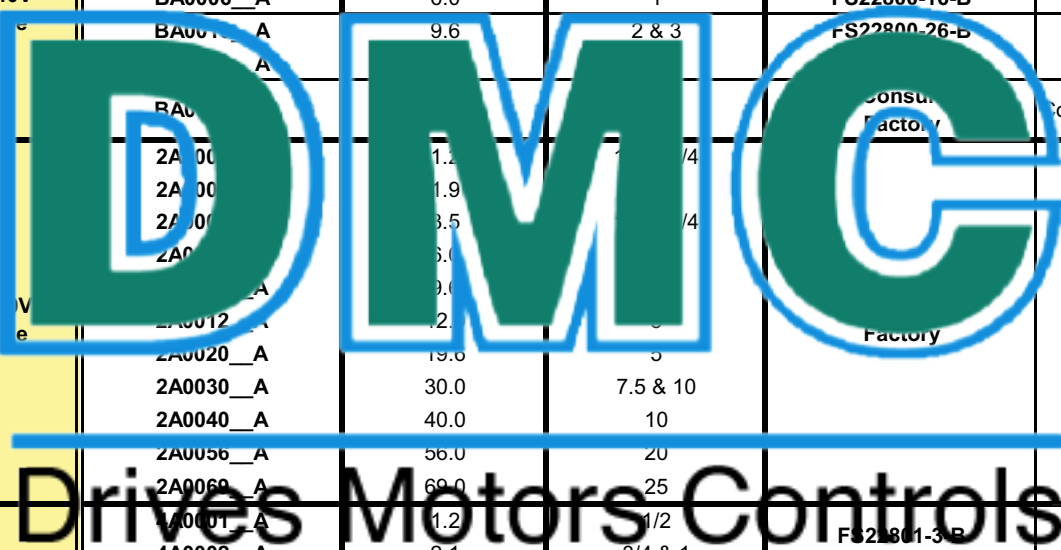

Drives Motors Controls

Note: Kit contains filter, cover, and mounting hardware.



Options
V1000 Drive

Dynamic Braking Resistor, 3% Duty Cycle - are rated for 3% duty cycle over a 100-second interval. Approximate braking torque for each rating is listed. These resistors are designed for separate panel mounting.

Rated Input Voltage	Drive Model Number CIMR-VU	Normal Duty		Heavy Duty		3% DB Resistor					Dimensions (in.)		
		Rated Output Current (Amps)	Nominal HP	Rated Output Current (Amps)	Nominal HP	Part Number	Qty Reqd	Resistance (Ohms) (Each)	Power (Watts) (Each)	Approx. Braking Torque (%)	H	W	D
200-240V 1-Phase	BA0001_A	1.2	1/8 & 1/4	0.8	1/8								
	BA0002_A	1.9	1/4	1.6	1/4	R7507	1	400	150	125	7.16	1.73	0.51
	BA0003_A	3.5	1/2 & 3/4	3.0	1/2								
	BA0006_A	6.0	1	5.0	3/4 & 1	R7505	1	200	150	230	7.16	1.73	0.51
	BA0010_A	9.6	2 & 3	8.0	2	R7504	1	100	150	125	7.16	1.73	0.51
	BA0011_A	12.0	3	11.0	3	R7503	1	70	150	120	7.16	1.73	0.51
200-240V 3-Phase	2A0001_A	1.2	1/8	0.8	1/8	R7507	1	400	150	125	7.16	1.73	0.51
	2A0002_A	1.9	1/4	1.6	1/4								
	2A0003_A	3.5	1/2 & 3/4	3.0	1/2								
	2A0006_A	6.0	1	5.0	3/4 & 1	R7505	1	200	150	230	7.16	1.73	0.51
	2A0010_A	9.6	2 & 3	8.0	2	R7504	1	100	150	125	7.16	1.73	0.51
	2A0011_A	12.0	3	11.0	3	R7503	1	70	150	120	7.16	1.73	0.51
	2A0012_A	15.0	3	14.0	3	R7503	1	70	150	120	7.16	1.73	0.51
	2A0013_A	17.5	3	17.0	3	R7503	1	62	150	120	7.16	1.73	0.51
	2A0014_A	20.0	3	19.0	3	R7503	1	62	150	120	7.16	1.73	0.51
	2A0015_A	25.0	7.5 & 10	25.0	10	N/A	N/A	N/A	N/A	N/A	N/A	N/A	N/A
2A0056_A	56	20	47.0	15	N/A	N/A	N/A	N/A	N/A	N/A	N/A	N/A	
2A0069_A	69	25	60.0	20	N/A	N/A	N/A	N/A	N/A	N/A	N/A	N/A	
380-480V 3-Phase	4A0001_A	1.2	1/2	1.2	1/2	R7508	1	750	150	230	7.16	1.73	0.51
	4A0002_A	2.1	3/4 & 1	1.8	3/4								
	4A0004_A	4.1	2	3.9	1 & 2	R7508	1	750	150	230	7.16	1.73	0.51
	4A0005_A	5.4	3	4.8	3	R7507	1	400	150	125	7.16	1.73	0.51
	4A0007_A	6.9	4	5.5	3								
	4A0009_A	8.8	5	7.2	4								
	4A0011_A	11.1	7.5	9.2	5	N/A	N/A	N/A	N/A	N/A	N/A	N/A	N/A
	4A0018_A	17.5	10	14.8	7.5 & 10	N/A	N/A	N/A	N/A	N/A	N/A	N/A	N/A
	4A0023_A	23.0	15	18.0	10								
	4A0031_A	31.0	20	24.0	15	N/A	N/A	N/A	N/A	N/A	N/A	N/A	N/A
4A0038_A	38.0	25	31.0	20									

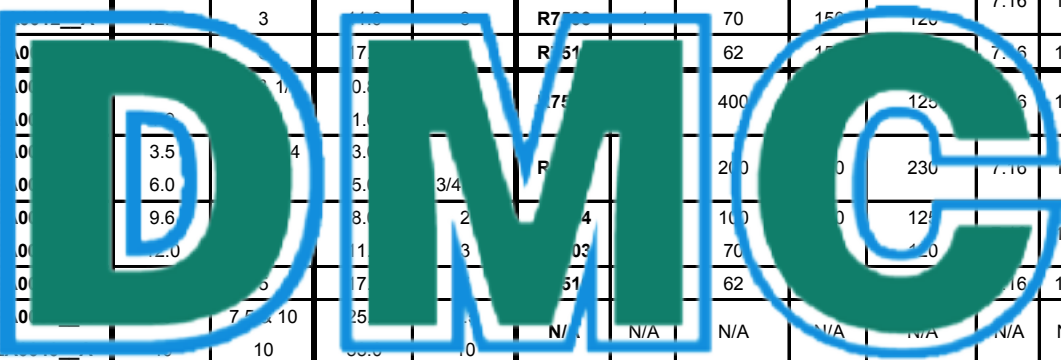

Drives Motors Controls



Dynamic Braking Resistor, 10% Duty Cycle - are rated for 10% duty cycle over a 100-second interval. Approximate braking torque for each rating is listed. These resistors are designed in vented NEMA 1 enclosures for separate panel mounting. The built-in braking module supports the 3% and 10% duty cycle resistors listed here and on the previous page. Resistors for applications requiring 50% and 100% duty cycle can be supported; please consult Yaskawa for duty cycles above 10%.

Rated Input Voltage	Drive Model Number CIMR-VU	Normal Duty		Heavy Duty		10% DB Resistor							Minimum Resistance (Ohms)		
		Rated Output Current (Amps)	Nominal HP	Rated Output Current (Amps)	Nominal HP	Part No.	Qty Reqd	Resistance (Ohms) (Each)	Power (Watts) (Each)	Approx. Braking Torque (%)		Dimensions (in.)			
										ND	HD	L		W	H
200-240V 1-Phase	BA0001_A	1.2	1/8 & 1/4	0.8	1/8	USR000032	1	750	600	120	150	12	7	5	300
	BA0002_A	1.9	1/4	1.6	1/4	USR000033	1	400	500	120	150	12	7	5	300
	BA0003_A	3.5	1/2 & 3/4	3.0	1/2	USR000022	1	200	250	120	150	12	5	5	200
	BA0006_A	6.0	1	5	3/4 & 1	USR000035	1	150	500	102	150	12	7	5	120
	BA0008_A	8.0	1 & 3/4	8	1	USR000036	1	70	250	111	150	12	5	5	60
	BA0010_A	11.0	1 1/2	11.0	1 1/2	USR000037	1	40	1000	111	150	12	5	5	32
200-240V 3-Phase	2A0001_A	1.2	1/8 & 1/4	0.8	1/8	URS000148	1	750	600	120	150	12	7	5	300
	2A0002_A	1.9	1/4	1.6	1/4	URS000149	1	400	500	120	150	12	7	5	300
	2A0003_A	3.5	1/2 & 3/4	3.0	1/2	URS000150	1	200	250	120	150	12	5	5	200
	2A0004_A	6.0	1	5	3/4 & 1	URS000151	1	150	500	102	150	12	7	5	120
	2A0005_A	8.0	1 & 3/4	8	1	URS000152	1	70	250	111	150	12	5	5	60
	2A0006_A	11.0	1 1/2	11.0	1 1/2	URS000153	1	40	1000	111	150	12	5	5	32
	2A0020_A	19.6	5	17.5	5	USR000025	1	40	846	111	111	12	7	5	32
	2A0030_A	30	7.5 & 10	25.0	7.5	URS000148	1	18	1301	120	150	12	10	5	16
	2A0040_A	40	10	33.0	10	URS000140	1	13.6	1646	120	150	12	13	5	9.6
	2A0056_A	56	20	47.0	15	URS000136	1	13.5	3402	101	135	27	10	5	9.6
380-480V 3-Phase	4A0001_A	1.2	1/8 & 1/4	0.8	1/8	USR000032	1	750	600	120	150	12	7	5	750
	4A0002_A	2.1	3/4 & 1	1.8	3/4	USR000033	1	400	500	120	150	12	7	5	750
	4A0004_A	4.1	1	3.4	1 & 2	USR000032	1	750	600	61	61	12	7	5	510
	4A0005_A	5.4	3	4.8	3	USR000034	1	250	500	119	119	12	7	5	240
	4A0007_A	6.9	4	5.5	3	USR000034	1	250	500	119	119	12	7	5	200
	4A0009_A	8.8	5	7.2	4	USR000035	1	150	500	118	150	12	7	5	100
	4A0011_A	11.1	7.5	9.2	5	USR000036	1	100	975	117	150	12	10	5	100
	4A0018_A	17.5	10	14.8	7.5 & 10	USR000038	1	50	1600	120	150	12	13	5	32
	4A0023_A	23.0	15	18.0	10	USR000038	1	50	1600	113	150	12	13	5	32
	4A0031_A	31.0	20	24.0	15	USR000039	1	40	2050	106	142	12	16	5	20
4A0038_A	38.0	25	31.0	20	URS000154	1	27.2	2720	120	150	19	13	5	20	

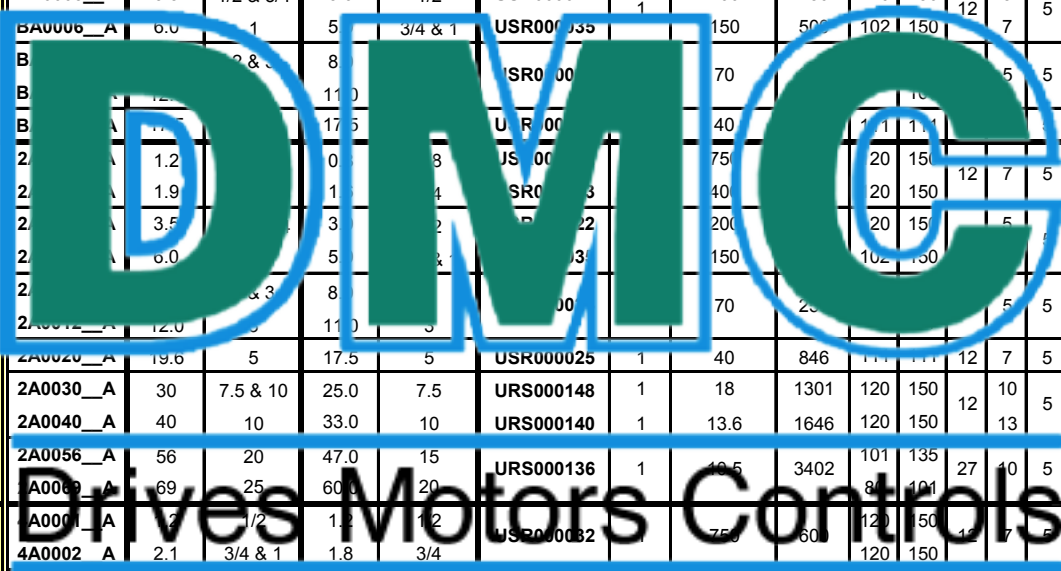



Options
V1000 Drive

DIN Rail Mounting Kits - The DIN rail attachment kit allows the drive to be mounted on a 35 mm DIN rail. The DIN rail itself is not included in the kit. Option kit for customer mounting.

Rated Input Voltage	Drive Model Number CIMR-VU	Rated Output Current (Amps)	Nominal HP	DIN Rail Kit
				Part Number 72606-EZZ08122
200-240V 1-Phase	BA0001_A	1.2	1/8 & 1/4	A
	BA0002_A	1.9	1/4	
	BA0003_A	3.3	1/2 & 3/4	
	BA0006_A	6.0	1	B
	BA0010_A	9.6	2 & 3	
	BA0012_A	12.0	3	
	BA0018_A	17.5	5	
200-480V 3-Phase	2A0001_A	1.2	1/8 & 1/4	A
	2A0002_A	1.9	1/4	
	2A0003_A	3.5	1/2 & 3/4	
	2A0006_A	6.0	1	B
	2A0010_A	9.6	2 & 3	
	2A0012_A	12.0	3	
	2A0018_A	17.5	5	
	2A0030_A	23.0	7.5	C
	2A0040_A	30.0	10	
	2A0056_A	30.0	20	
2A0069_A	33.0	25	Not Available	
380-480V 3-Phase	4A0001_A	1.2	1/2	A
	4A0002_A	2.1	3/4 & 1	
	4A0004_A	4.1	2	
	4A0005_A	5.4	3	B
	4A0007_A	6.9	4	
	4A0009_A	8.8	5	C
	4A0011_A	11.1	7.5	
	4A0018_A	18.0	10	
	4A0023_A	23.0	15	
4A0031_A	31.0	20	Not Available	
4A0038_A	38.0	25		

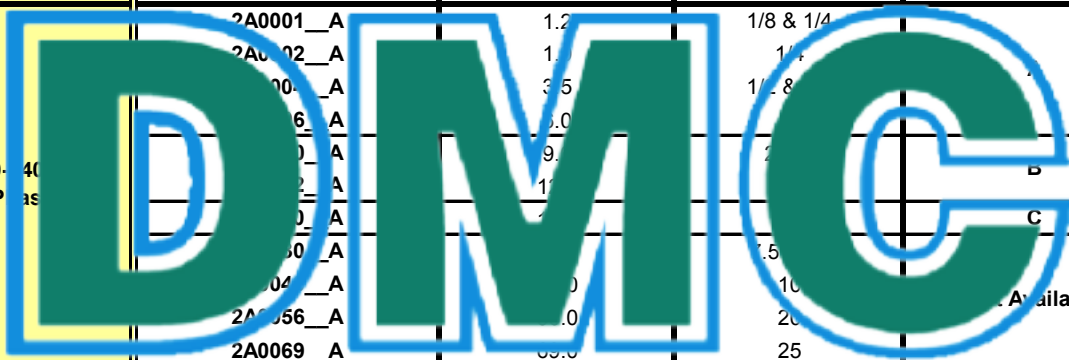

Drives Motors Controls



Adapter Plate - Conversion kit used to mount a V1000 on the same footprint as a V7 drive. Not available for J1000 drives.

External Heatsink Kit - Allow for V1000 drives to be mounted with the drive's heatsink external to the enclosure. Not available for J1000 drives. Option kit for customer mounting.

Rated Input Voltage	Drive Model Number CIMR-VU	Rated Output Current (Amps)	Nominal HP	External Heatsink Kit	Adapter Kit		
				Part Number EZZ020568_	Part Number EZZ020572_		
230V, 1-Phase	BA0001_A	1.2	1/8 & 1/4	A	Not Required		
	BA0002_A	1.9	1/4				
	BA0003_A	3.3	1/2 & 3/4				
	BA0006_A	6.0	1				
	BA0010_A	9.6	2 & 3				
	BA0012_A	2.0	3				
230V, 3-Phase	2A0001_A	1.2	1/8 & 1/4	A	Not Required		
	2A0002_A	1.9	1/4				
	2A0003_A	3.3	1/2 & 3/4				
	2A0006_A	6.0	1				
	2A0010_A	9.6	2 & 3				
	2A0012_A	2.0	3				
	2A0015_A	2.9	3/4				
	2A0030_A	10.0	7.5 & 10				
	2A0040_A	40.0	10				
	2A0056_A	56.0	20				
2A0069_A	69.0	25	K	Not Required			
460V	4A0001_A	1.2	1/2	L	Not Required		
	4A0002_A	2.1	3/4 & 1				
	4A0004_A	4.0	2				
	4A0005_A	5.4	3				
	4A0007_A	6.0	4				
	4A0009_A	8.8	5				
	4A0011_A	11.1	7.5			E	Not Required
	4A0018_A	18.0	10			H	B
4A0023_A	23.0	15					
4A0031_A	31.0	20	J	Not Required			
4A0038_A	38.0	25					

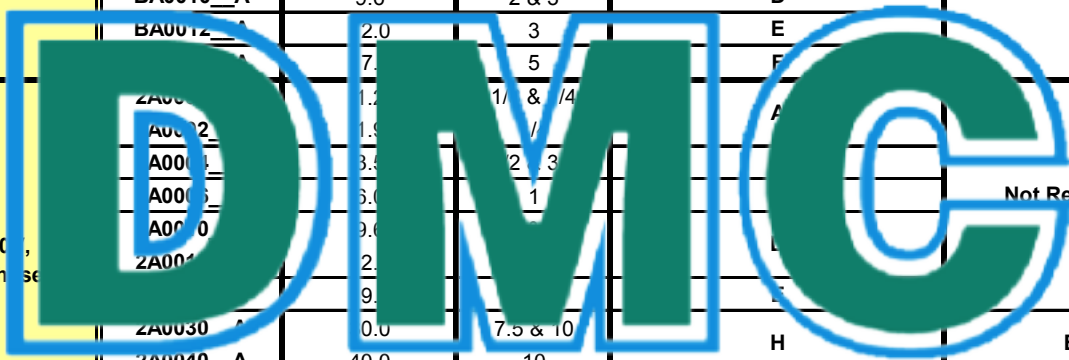

Drives Motors Controls



Options
V1000 Drive

24VDC Control Power Unit - This option provides board-level component voltages for the V1000 drive when provided with 24VDC from an external, customer-supplied source. It is used to maintain both drive control power and network communications (when utilized). Both a Control Power Unit and a Bracket Kit are required for proper operation and certification. Option kit for customer mounting.

Rated Input Voltage	Drive Model Number CIMR-VU	Rated Output Current (Amps)	Nominal HP ⁽¹⁾	Control Power Unit	Bracket Kit
				Part Number	Part Number EZZ020639_
200-240V 1-Phase	BA0001__A	1.2	1/8 & 1/4	PS-V10S	A
	BA0002__A	1.9	1/4		
	BA0003__A	3.3	1/2 & 3/4		
	BA0006__A	6.0	1	PS-V10S	B
	BA0010__A	9.0	2 & 3		
	BA0015__A	13.5	3		
200-240V 3-Phase	2A0001__A	1.2	1/8 & 1/4	PS-V10S	A
	2A0002__A	1.9	1/4		
	2A0003__A	3.3	1/2 & 3/4		
	2A0006__A	6.0	1	PS-V10S	B
	2A0010__A	9.0	2 & 3		
	2A0015__A	13.5	3		
	2A0030__A	30.0	7.5 & 10	PV-V10M	B
	2A0040__A	40.0	10		
2A0056__A	56.0	20			
380-480V 3-Phase	4A0001__A	1.2	1/2	PS-V10S	B
	4A0002__A	1.9	3/4 & 1		
	4A0004__A	4.1	2		
	4A0005__A	5.4	3	PS-V10S	B
	4A0007__A	6.9	4		
	4A0009__A	8.8	5		
	4A0011__A	11.1	7.5	PS-V10M	B
	4A0018__A	18.0	10		
	4A0023__A	23.0	15		
	4A0031__A	31.0	20	PS-V10M	C
4A0038__A	38.0	25			

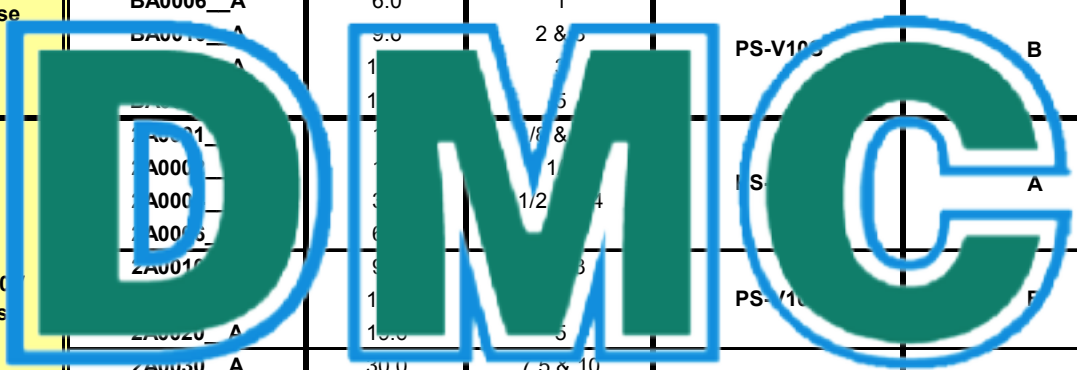

Drives Motors Controls



Operator, LCD Digital Remote, NEMA Type 1. This option allows the drive to be operated from a remote location, and provides a 16-character, 5-line alpha-numeric LCD. This option requires Installation Set A (EZZ020642A) for panel or door mounting and Remote Operator Cable (UWR0051 or UWR0052), each sold separately.

Note: This option requires the V1000 drive to contain 1012 software or later; please consult your Yaskawa representative to ensure proper operation.

Model No. JVOP-180

Operator, LED Digital Remote, NEMA Type 1. This option allows the drive to be operated from a remote location. This option requires Installation Set A (EZZ020642A) for panel or door mounting and Remote Operator Cable (UWR0051 or UWR0052), each sold separately.

Note: This option requires the V1000 drive to contain 1016 software or later; please consult your Yaskawa representative to ensure proper operation.

Model No. JVO-

LCD/LED Keypad Installation Set A (Remote Operator Mounting Bracket Kit). This is a bracket which the LCD Digital Remote Operator (JVOP-180) attaches to. It has (4) pre-drilled holes and screws to attach the cover of the enclosure. The kit contains (2) screws to mount the Operator to the bracket and (2) screws to attach the bracket to the enclosure.

Model No. EZ-

LCD/LED Keypad Installation Set B (Remote Operator Mounting Bracket Kit). Contains a similar bracket that the keypad attaches to and has non-threaded holes for mounting to an enclosure that has the screws attached to the enclosure already.

The kit contains (2) screws to mount the keypad to the bracket and (4) nuts to attach the bracket to the customer supplied screws attached to the enclosure.

Model No. EZ020642B

Operator Cable. Remote LCD Digital Operator (JVOP-180) or Remote LED Operator (JVOP-182). They are available in one (1) or three (3) meter lengths.

Model No. UWR0051 (1 meter)

Model No. UWR0052 (3 meter)

Operator Kits, NEMA Type 3R/4X. This option is used to extend an LCD or LED Digital Remote Operator to the wall of a separately priced, oversized UL Type 3R, 4, 4X, or 12 enclosure (IPX6 environment). Price includes a faceplate bezel with digital operator brackets and membrane to cover the operator cutout in the enclosure door, a 3-foot cable, a 10-foot cable, and a 1:1 template for cutting the necessary cutouts in the enclosure. Keypad can be removed after kit installation. Designed for use with the LCD Operator JVOP-180 or the LED Operator JVOP-182 sold separately. Connects to RJ45 port and mounts to enclosure wall.

Model No. UUX000526 (Blank Membrane)

Model No. UUX000527 (Yaskawa Logo Membrane)

DriveWizard Plus Software. This optional software package allows upload and download of parameters via PC for data storage and for programming multiple drives. The software also includes graphing and monitoring tools. It is a Windows-based program designed to make startup, commissioning, and troubleshooting of the J1000 as simple as possible. Refer to our website at www.yaskawa.com to download the software, and for more information, including minimum system requirements and cable information to interface a PC to V1000 or J1000 drives.

No Model No.

PC Interface Cable. This 6-foot cable interconnects the drive keypad port to the 9-pin communication port on a PC. This cable is used in conjunction with DriveWizard Plus software.

Model No. UWR00468-2

USB Copy Unit (Y-Stick). This option allows the drive to connect to the USB port on a PC. It can read, copy and verify drive parameter settings on the drive to a USB copy unit. The unit plugs into the front panel of the drive. Refer to our website at www.yaskawa.com to download the software. **Model No. JVOP-81**

Copy Manager Software for USB Copy Unit (Y-Stick). This option allows the use of the USB copy unit to transfer files from the drive to a PC (VOP-131) and vice versa. Refer to our website at www.yaskawa.com to download the software. **Model No. UWR00468-2**

120 VAC Interface. This option mounts directly to the control terminal block on the drive and allows the use of 120 VAC control logic circuits to produce multi-function control input signals for the drive.

Model No. DI-100

DriveWorksEZ (DWEZ) Standard and Pro. A software system that provides the means to create custom drive functionality in the V1000 using function block programming to distribute control away from a PLC.

DWEZ Standard can be downloaded from www.yaskawa.com with a valid partner login. DWEZ Pro requires attending a factory training class - see below for details.

DriveWorksEZ (DWEZ) Standard. The V1000 provides for 118 basic function blocks and up to 20 block connections. Available via web download only.

Valid www.yaskawa.com Partner Login required

DriveWorksEZ (DWEZ) Pro Certification. A two-day DWEZ-specific training class (TRM020-DriveWorksEZ) must be attended to become certified. This class is intended for those well-versed in V1000 programming. DWEZ Pro provides increased functionality, with 50 connections and 225 function blocks compared to the Standard version.

Model No. CD.DWEZ.03

To enroll in class, call Technical Training Services at 847-887-7228.

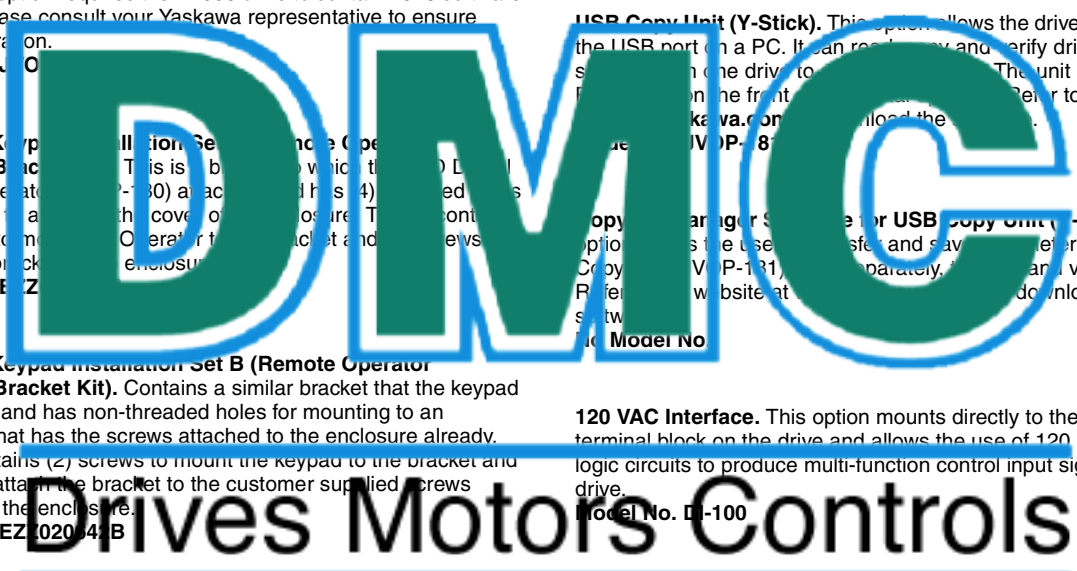

Drives Motors Controls



Options V1000 Drive

DeviceNet™ With ADR. This option complies with all pertinent aspects of the ODVA (Open DeviceNet Vendor Association) specification and AC drive profile. All parameters, diagnostics and operational commands are accessible via DeviceNet. Automatic Device Replacement (ADR) is supported in this DeviceNet option, including the functions of Auto Baud Rate sensing and Faulted Node Recovery (using Group 4 messaging). Each DeviceNet network supports up to 63 drives. Controllers are available from many PLC and/or PC suppliers. The board mounts integrally in the drive and provides a DeviceNet standard open tap connector. The option is configured using parameters within the drive, which allows for easy configuration eliminating the use of hardware switches. Status LEDs are viewable through the front cover and a monitor has been added to allow for improved diagnostics.

Note: This option requires the V1000 drive to contain 1012 software or later; please consult your Yaskawa representative to ensure proper operation.

Mounts at option connector CN5.

Model No. SI-N3/V

EtherNet/IP. This option complies with the EtherNet/IP specification, and provides for communication over 10/100 Ethernet networks. This option has the ability to configure an IP address from a BootP host, a DHCP server, or from the network parameters. Diagnostic and operational commands are accessible via Ethernet. The web browser allows for management of drive parameters through a standard web browser. The embedded web page provides the main drive status page, new web browser documentation.

Note: This option requires the V1000 drive to contain 1015 software or later; please consult your Yaskawa representative to ensure proper operation.

Mounts at option connector CN5.

Model No. SI-EN3/V

PROFINET. This option complies to PROFINET I/O device and PROFIDrive profile specifications. It allows connection of a PROFINET network and facilitates the exchange of data via a simple, networking solution that has the advantages of being and install factory automation devices, while providing interchangeability of like components from multiple vendors. This is a PROFINET Conformance Class A certified interface.

This interface makes it possible to perform the following from a PROFINET master device:

- Operate the drive
- Monitor the operation status of the drive
- Change parameter settings

Note: This option requires the V1000 to contain 1012 software or later; please consult your Yaskawa representative to ensure proper operation.

Mounts at option connector CN5.

Model No. SI-EP3/V

Profibus DP. This option complies with the Profibus DP protocol specification. All parameters, diagnostics and operational commands are accessible via Profibus. The option board provides a 9-pin (F) type D-Sub connector for easily connecting to a standard Profibus style, shielded twisted-pair cable. Each Profibus network supports up to 99 drives. This option supports all of the Profibus data rates from 9.6 Kbps to 12 Mbps. Up to 32 bytes of input data and 32 bytes of output data are provided per message transaction. Sync and Freeze modes are supported for groups. Profibus DP-V1 support (cyclic and acyclic data exchange). Configurable PPO read and write parameters. The option is configured using parameters within the drive, which allows for easy configuration eliminating the use of hardware switches. Status LEDs are viewable through the front cover, and a monitor has been added to allow for improved diagnostics. Option is backwards compatible with the previous generation option cards.

Note: This option requires the V1000 drive to contain 1010 software or later; please consult your Yaskawa representative to ensure proper operation.

Mounts at option connector CN5.

Model No. SI-P3/V

Modbus TCP/IP. This option complies with the Modbus TCP/IP protocol specification. This option allows for Modbus communication over Ethernet networks. This option has the ability to configure a user-specified IP address, from a BootP host, a DHCP server, or from the network parameters. Diagnostic and operational commands are accessible via Modbus TCP/IP. This option supports up to 10 simultaneous connections.

Note: This option requires the V1000 drive to contain 1015 software or later; please consult your Yaskawa representative to ensure proper operation.

Mounts at option connector CN5.

Model No. SI-EM3/V

MECHATROLINK II. This option is designed for connecting a drive to a field network using the MECHATROLINK protocol. The MECHATROLINK-II option allows the user to operate the drive, monitor the status, and change parameters from a MECHATROLINK master device at a communication speed up to 10 Mbps.

Note: This option requires the V1000 drive to contain 1016 software or later; please consult your Yaskawa representative to ensure proper operation.

Mounts at option connector CN5.

Model No. SI-T3/V

Drives Motors Controls

This page intentionally left blank

DMC

Drives Motors Controls

Rated Input Voltage	Drive Model Number CIMR-VU	Normal Duty ⁽¹⁾		Heavy Duty ⁽¹⁾	
		Rated Output Current (Amps)	Nominal HP ⁽²⁾	Rated Output Current (Amps)	Nominal HP ⁽²⁾
200-240V 1-Phase	BA0001GAA	1.2	1/8 & 1/4	0.8	1/8
	BA0002GAA	1.9	1/4	1.6	1/4
	BA0003GAA	3.3	1/2 & 3/4	3.0	1/2
	BA0006GAA	6.0	1	5.0	3/4 & 1
	BA0010GAA	9.6	2 & 3	8.0	2
	BA0012GAA	12.0	3	11.0	3
200-240V 3-Phase	2A0001GAA	1.2	1/8 & 1/4	0.8	1/8
	2A0002GAA	1.9	1/4	1.6	1/4
	2A0003GAA	3.3	1/2 & 3/4	3.0	1/2
	2A0006GAA	6.0	1	5.0	3/4 & 1
	2A0012GAA	12.0	3	11.0	3
	2A0018GAA	18.0	5	17.5	5
380-480V 3-Phase	4A0001GAA	1.2	1/8 & 1/4	0.8	1/8
	4A0002GAA	1.9	1/4	1.6	1/4
	4A0003GAA	3.3	1/2 & 3/4	3.0	1/2
	4A0004GAA	4.1	2	3.4	1 & 2
	4A0005GAA	5.4	3	4.8	3
	4A0007GAA	7.5	7.5	7.2	7.5
	4A0009GAA	9.6	10	9.2	10
	4A0018GAA	17.5	15	14.8	15
	4A0023GAA	24.0	20	24.0	20
	4A0031GAA	31.0	25	31.0	25



Drives Motors Controls

- (1) Normal Duty overload current rating is 120% of rated output current for 60 seconds; Heavy Duty overload current rating is 150% of rated output current for 60 seconds
- (2) Horsepower rating is based on standard NEMA B 4-pole motor design and NEC table 430.150 Full-Load Current, Three-Phase Alternating Current Motors

V1000-4X

Dimensions and Data

Rated Input Voltage	Drive Model Number CIMR-VU	Normal Duty		Heavy Duty		Physical Dimensions (in.)			Mounting Dimensions (in.)		Weight (lbs.) ⁽¹⁾
		Rated Output Current (Amps)	Nominal HP	Rated Output Current (Amps)	Nominal HP	H	W	D	H1	W1	
200-240V 1-Phase	BA0001GAA	1.2	1/8 & 1/4	0.8	1/8	8.74	6.38	7.28	8.27	5.32	10.4
	BA0002GAA	1.9	1/4	1.6	1/4	8.74	6.38	7.28	8.27	5.32	10.4
	BA0003GAA	3.3	1/2 & 3/4	3.0	1/2	8.74	6.38	7.28	8.27	5.32	10.8
	BA0006GAA	6.0	1	5.0	3/4 & 1	10.04	7.36	9.25	9.49	6.22	17.2
	BA0010GAA	9.6	2 & 3	8.0	2	10.04	7.36	9.25	9.49	6.22	17.2
	BA0012GAA	12.0	3	11.0	3	10.04	7.36	9.25	9.49	6.22	18.1
200-240V 3-Phase	2A0001GAA	1.2	1/8 & 1/4	0.8	1/8	8.74	6.38	7.28	8.27	5.32	10.4
	2A0002GAA	1.9	1/4	1.6	1/4	8.74	6.38	7.28	8.27	5.32	10.4
	2A0003GAA	3.3	1/2 & 3/4	3.0	1/2	8.74	6.38	7.28	8.27	5.32	10.6
	2A0006GAA	6.0	1	5.0	3/4 & 1	10.04	7.36	9.25	9.49	6.22	10.6
	2A0010GAA	9.6	2 & 3	8.0	2	10.04	7.36	9.25	9.49	6.22	17.0
	2A0015GAA	14.4	3 & 4	11.0	3	10.04	7.36	9.25	9.49	6.22	17.0
	2A0020GAA	19.2	5	15.0	4	10.04	7.36	9.25	9.49	6.22	17.9
	2A0030GAA	28.8	7.5 & 10	22.0	6	11.42	8.74	10.12	15.75	10.43	48.1
	2A0040GAA	38.4	10	29.0	8	11.42	8.74	10.12	15.75	10.43	48.1
	2A0050GAA	48.0	15	36.0	10	11.42	12.01	12.01	15.75	10.43	51.2
380-480V 3-Phase	4A0001GAA	1.2	1/2	1.0	1/2	8.74	6.38	7.28	8.27	5.32	11.1
	4A0002GAA	2.1	3/4 & 1	1.8	3/4	8.74	6.38	7.28	8.27	5.32	11.1
	4A0004GAA	4.1	2	3.4	1 & 2	8.74	6.38	7.28	8.27	5.32	11.3
	4A0006GAA	6.1	3	5.0	3	10.04	7.36	9.25	9.49	6.22	17.0
	4A0007GAA	6.9	4	5.5	3	10.04	7.36	9.25	9.49	6.22	17.5
	4A0009GAA	8.8	5	7.2	4	10.04	7.36	9.25	9.49	6.22	17.5
	4A0011GAA	11.1	7.5	9.2	5	10.04	7.36	9.25	9.49	6.22	17.9
	4A0016GAA	17.5	10	14.8	7.5 & 10	16.54	11.42	12.01	15.75	10.43	47.9
	4A0023GAA	24.0	15	18.0	10	16.54	11.42	12.01	15.75	10.43	48.1
	4A0031GAA	31.0	20	24.0	15	16.54	11.42	12.01	15.75	10.43	50.5
4A0038GAA	38.0	25	31.0	20	16.54	11.42	12.01	15.75	10.43	51.2	

(1) This data represents the drive weight only, not shipping weight

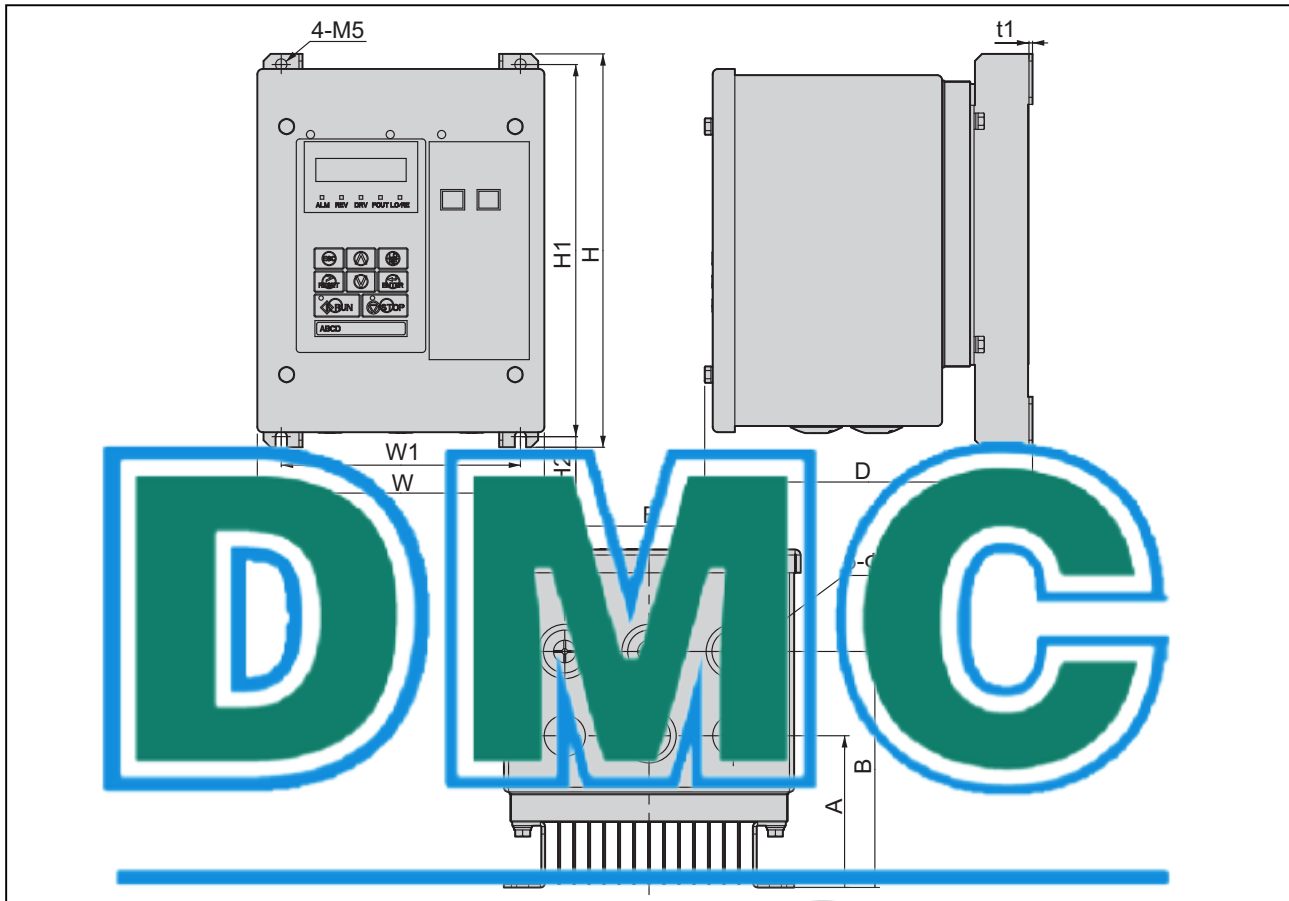

DMC

Voltage Class	Drive Model	Dimensions mm (in)										Weight kg (lb.)	
		W	H	D	W1	H1	H2	t1	A	B	E		
Single-Phase 200 V Class	BA0001G												4.7 (10.36)
	BA0002G												4.7 (10.36)
	BA0003G												4.9 (10.80)
Three-Phase 200 V Class	2A0001G												4.7 (10.36)
	2A0002G	162	222	185	135	210	6	2	81	126	90	4.7 (10.36)	
	2A0004G	(6.38)	(8.74)	(7.28)	(5.32)	(8.27)	(0.24)	(0.08)	(3.19)	(4.96)	(3.54)	4.8 (10.58)	
Three-Phase 400 V Class	2A0006G												4.8 (10.58)
	4A0001G												5.0 (11.02)
	4A0002G												5.0 (11.02)
	4A0004G												5.1 (11.24)

**V1000-
4X**

Dimension Drawing

DD.V1000-4X.02

NEMA 4X/IP66

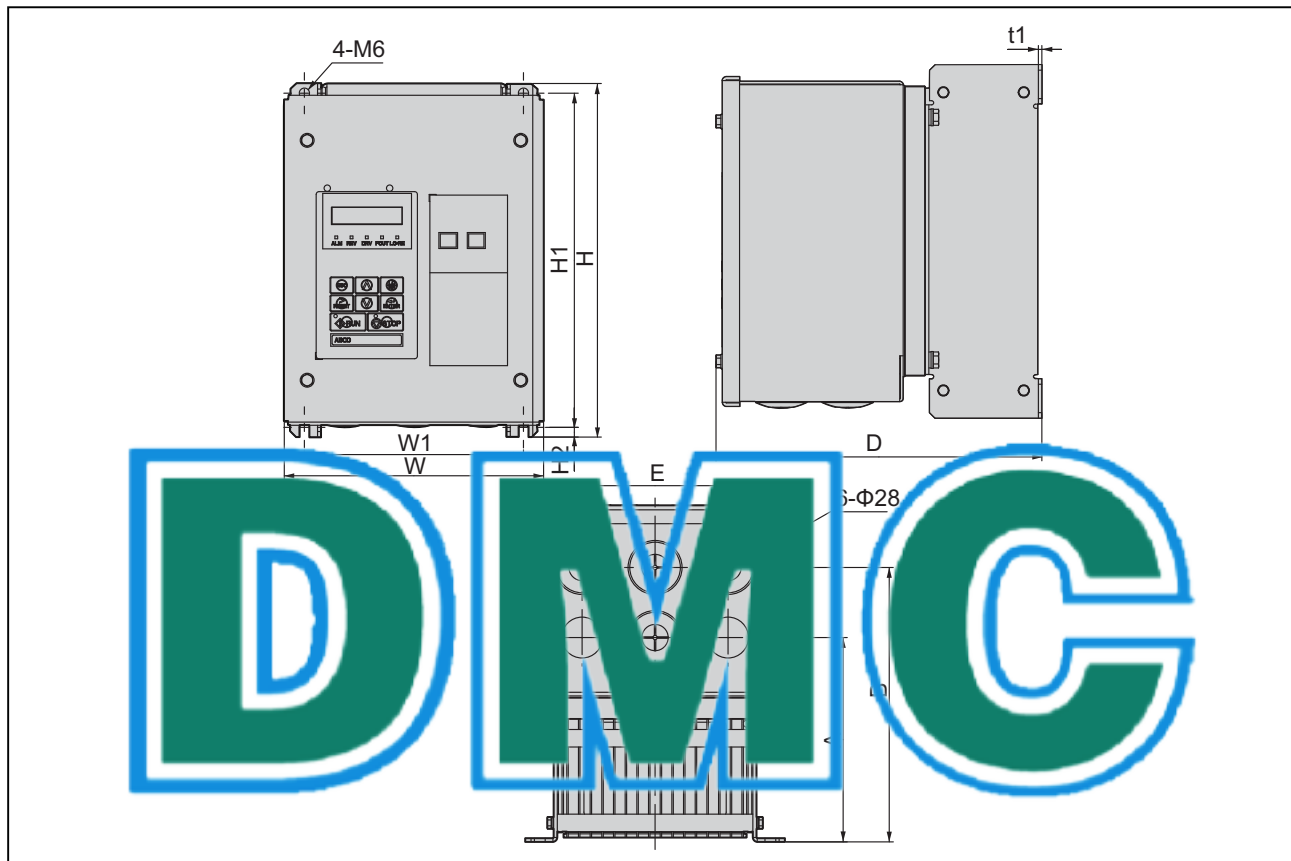

Voltage Class	Drive Model	Dimensions mm (in)										Weight kg (lb.)	
		W	H	D	W1	H1	t1	A	B	E			
Single-Phase 200 V Class	BA0006G												7.8 (17.2)
	BA0010G												7.8 (17.2)
Three-Phase 200 V Class	BA0012G												8.2 (18.08)
	2A0010G												7.7 (16.98)
	2A0012G	187	255	235	158	241	7	2.5	140	188	100		7.7 (16.98)
	2A0020G	(7.36)	(10.04)	(9.25)	(6.22)	(9.49)	(0.28)	(0.10)	(5.51)	(7.40)	(3.94)		8.1 (17.86)
Three-Phase 400 V Class	4A0005G												7.7 (16.98)
	4A0007G												7.9 (17.42)
	4A0009G												7.9 (17.42)
	4A0011G												8.1 (17.86)

Dimension Drawing

DD.V1000-4X.03

NEMA 4X/IP66

V1000-4X

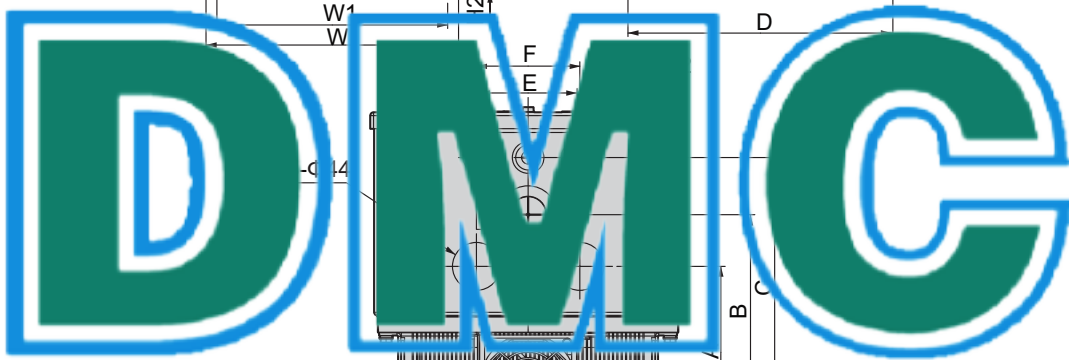
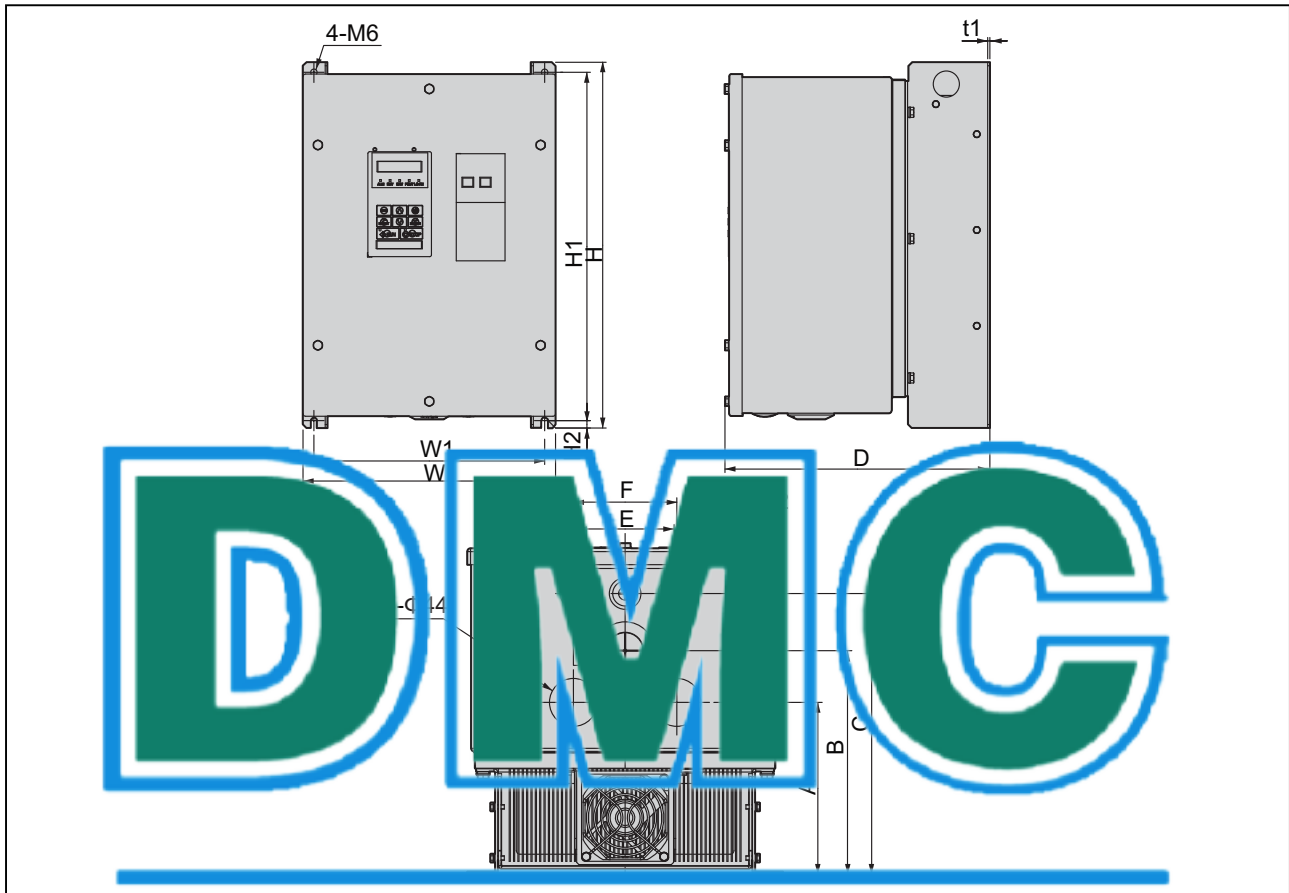

Voltage Class	Drive Model	Dimensions mm (in)												Weight kg (lb.)	
		W	N	D	F	H1	H2	t1	A	B	C	E	F		
Three-Phase 200 V Class	2A0020G														21.8 (48.06)
	2A0040G														21.8 (48.06)
	2A0056G														23.2 (51.15)
Three-Phase 400 V Class	4A0018G	290 (11.42)	420 (16.54)	305 (12.01)	265 (10.43)	400 (15.75)	8.5 (0.33)	2.5 (0.10)	158 (6.22)	205.5 (8.09)	258 (10.16)	90 (3.54)	95 (3.74)	21.7 (47.84)	
	4A0023G													21.8 (48.06)	
	4A0031G													22.9 (50.49)	
	4A0038G													23.2 (51.15)	

V1000-4X

Dimension Drawing

DD.V1000-4X.04
NEMA 4X/IP66

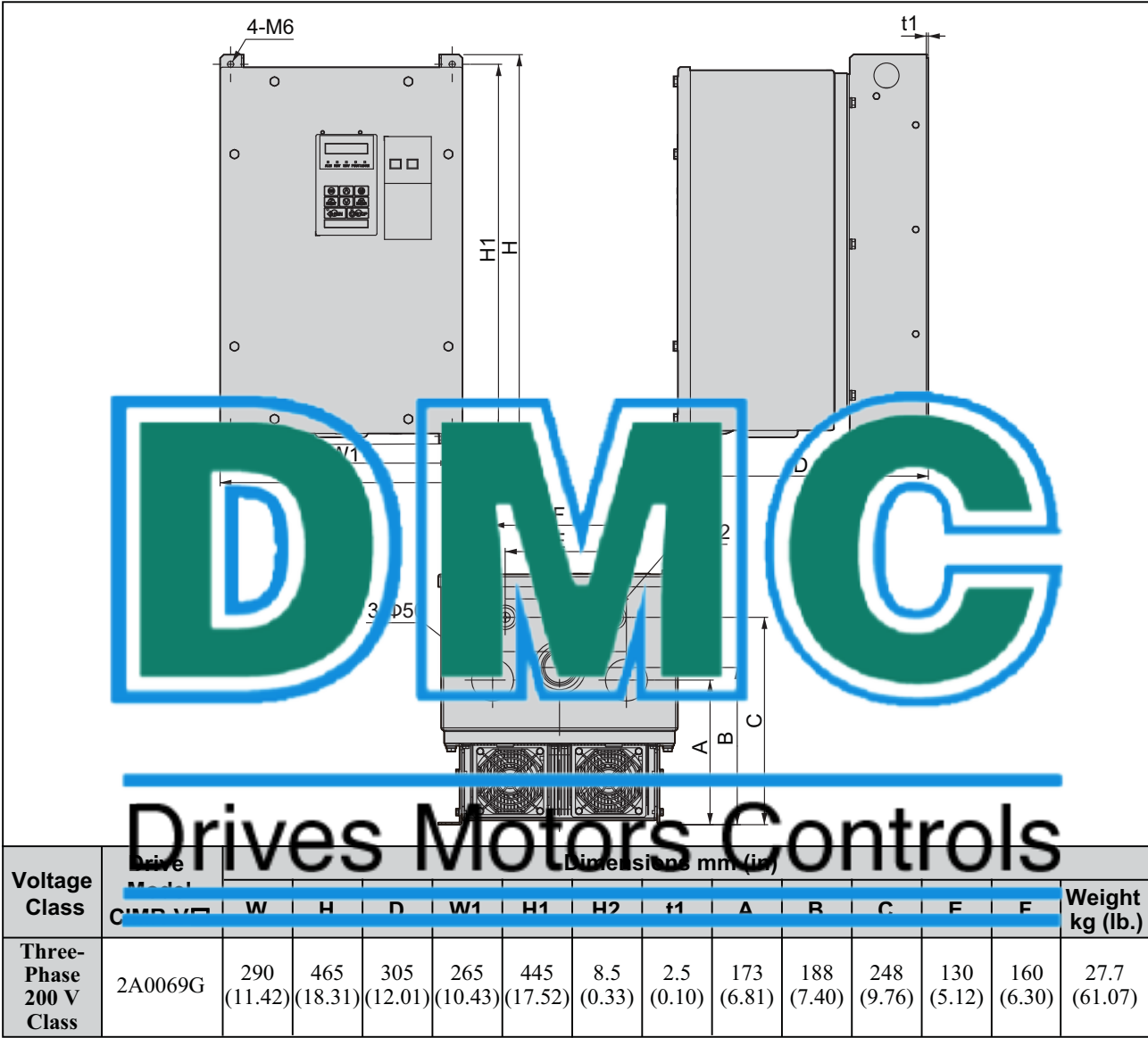



Operator, LCD Digital Remote, NEMA Type 1. This option allows the drive to be programmed before installation from a remote location, and provides a 16-character, 5-line alpha-numeric LCD. This option requires Remote Operator Cable (UWR0051 or UWR0052), sold separately.

Note: This option requires the V1000 drive to contain 1012 software or later; please consult your Yaskawa representative to ensure proper operation.

Model No. JVOP-180

Operator Cable, Remote. These cables are used to connect the Remote LCD Digital Operator (JVOP-180). They are available in one (1) or three (3) meter lengths.

Model No. UWR0051 (1 meter)

Model No. UWR0052 (3 meter)

Operator Kit, NEMA Type 3R/4X. This option is used to extend an LCD Digital Remote Operator to the wall of a separately priced, oversized UL Type 1 enclosure (IFX6000). Price includes a blank membrane to connect operator to the enclosure, a 3-foot cable, a 0.5" x 1" x 1" plate for mounting, and necessary components for enclosure. Kit includes necessary components for use with the LCD Operator (JVOP-180) sold separately. Mounts to RJ-45 ports on the enclosure wall.

Model No. UWX (Blank Membrane)

Model No. UWX (Membrane)

DriveWizard Plus Software. This optional software package allows upload and download of parameters via PC for data storage and for programming multiple drives. The software also includes graphing and monitoring tools. It is a Windows-based program designed to make startup, commissioning, and troubleshooting of the J1000 as simple as possible. Refer to our website at www.yaskawa.com to download the software and for more information, including minimum system requirements and cable information to interface a PC to V1000 or J1000 drives.

No Model No.

PC Interface Cable. This 6-foot cable interconnects the drive keypad port to the 9-pin communication port on a PC. This cable is used in conjunction with DriveWizard Plus software.

Model No. UWR00468-2

USB Copy Unit (Y-Stick). This option allows the drive to connect to the USB port on a PC. It can read, copy and verify drive parameter settings from one drive to another like drive. The unit plugs into the RJ-45 port on the front of the digital operator. Refer to our website at www.yaskawa.com to download the software.

Model No. JVOP-181

CopyUnitManager Software for USB Copy Unit (Y-Stick). This option allows the user to transfer and save parameter files from the Copy Unit (JVOP-181), sold separately, to a PC and vice versa. Refer to our website at www.yaskawa.com to download the software.

No Model No.

DriveWizard Plus Software. This optional software package allows upload and download of parameters via PC for data storage and for programming multiple drives. The software also includes graphing and monitoring tools. It is a Windows-based program designed to make startup, commissioning, and troubleshooting of the J1000 as simple as possible. Refer to our website at www.yaskawa.com to download the software and for more information, including minimum system requirements and cable information to interface a PC to V1000 or J1000 drives.

Model No. CD.DW01

DriveWizard Plus Software. This optional software system that provides means to create and distribute control away from a PLC. Must attend one of the two classes below to obtain software CD.

DriveWorkEZ (DWEZ) Standard Certification. A 3-day V1000 Application Programming training class (TRM010-V1000) must be attended to become certified. Provides 20 connections and 119 basic functions.

Model No. CD.DWEZ.01

DriveWorkSEZ (DWEZ) Pro Certification. A 2-day DWEZ-specific training class (TRM020-DriveWorkSEZ) must be attended to become certified. This class is intended for those well-versed in V1000 programming. DWEZ Pro provides increased functionality, with 50 connections and 225 function blocks compared to the Standard version.

Model No. CD.DWEZ.03

To enroll in class, call Technical Training Services at 847-887-7228.





Options V1000-4X Drive

DeviceNet™ With ADR. This option complies with all pertinent aspects of the ODVA (Open DeviceNet Vendor Association) specification and AC drive profile. All parameters, diagnostics and operational commands are accessible via DeviceNet. Automatic Device Replacement (ADR) is supported in this DeviceNet option, including the functions of Auto Baud Rate sensing and Faulted Node Recovery (using Group 4 messaging). Each DeviceNet network supports up to 63 drives. Controllers are available from many PLC and/or PC suppliers. The board mounts integrally in the drive and provides a DeviceNet standard open tap connector. The option is configured using parameters within the drive, which allows for easy configuration eliminating the use of hardware switches. Status LEDs are viewable through the front cover and a monitor has been added to allow for improved diagnostics.

Note: This option requires the V1000 drive to contain 1012 software or later; please consult your Yaskawa representative to ensure proper operation.

Model No. SI-N3/V

Profibus DP. This option complies with the Profibus DP protocol specification. All parameters, diagnostics and operational commands are accessible via Profibus. The option board provides a 9-pin (F) type D-Sub connector for easily connecting to a standard Profibus style, shielded twisted-pair cable. Each Profibus network supports up to 99 drives. This option supports all of the Profibus data rates from 9.6 Kbps to 12 Mbps. Up to 32 bytes of input data and 32 bytes of output data are provided per message transaction. Sync and Freeze modes are supported for groups. Profibus DP-V1 support (cyclic and acyclic data exchange). Configurable PPO read and write parameters. The option is configured using parameters within the drive, which allows for easy configuration eliminating the use of hardware switches. Status LEDs are viewable through the front cover, and a monitor has been added to allow for improved diagnostics. Option is backwards compatible with the previous generation option cards.

Note: This option requires the V1000 drive to contain 1010 software or later; please consult your Yaskawa representative to ensure proper operation.

Model No. SI-P3/V

EtherNet/IP. This option complies with the EtherNet/IP specification, and provides for communication over 10/100 Ethernet networks. Configuration has been simplified by configuring the IP address from a user-specified IP address, from a BootP host address, or from the network parameter. Diagnostics and operational commands are accessible via EtherNet/IP. The option allows for management of drive information through a standard web browser. The embedded pages of the main page of the drive status page, new web pages for parameter information.

Note: This option requires the V1000 drive to contain 1015 software or later; please consult your Yaskawa representative to ensure proper operation.

Model No. SI-EN3/V

Modbus TCP/IP. This option complies with the Modbus TCP/IP protocol specification. This option provides for Modbus communication over 10/100 Ethernet networks. This option has the ability to configure the IP address of a user-specified IP address, from a BootP host address, or from a BootP host address. All parameters, diagnostics and operational commands are accessible via Modbus TCP/IP. This option supports up to 100 drives. The option requires the V1000 drive to contain 1015 software or later; please consult your Yaskawa representative to ensure proper operation.

Note: This option requires the V1000 drive to contain 1015 software or later; please consult your Yaskawa representative to ensure proper operation.

Mounts at optional connector CN5

Model No. SI-EM3/V



Drives Motors Controls

In today's world of global competition, it is impossible for a company to survive without "state-of-the-art" technically trained associates and customers. Yaskawa America, Inc. Technical Training Service's mission is to provide inverter drives training classes to our customers that are "right on target" with knowledge they need to perform their jobs.

Yaskawa America, Inc. has three training facilities in the United States. The primary training facility is in Yaskawa America, Inc.'s North American Headquarters in Waukegan, Illinois (45 miles north of Chicago, 50 miles south of Milwaukee). This facility has four training rooms: two lecture halls and two training labs. Two additional facilities are located in Cypress, California, and Plain City, Ohio.

Besides the possibility of attending training classes in Waukegan, Yaskawa America, Inc. can also bring training to the customer. On-site classes are available in two varieties. The first is to duplicate the official training classes at the customer's location. Full functioning demo units, data projector, computer and documentation can be shipped to recreate the official class on-site. The second variety is road show training. Road show training is a one-day training class that is specifically tailored to the students' needs and questions. Only basic demos are used and the topics covered in class are generated by the students in attendance.

The Yaskawa eLearning Module (eLM) is an on-line training option that you need internet connection and a telephone. The eLM is available in two varieties: one which gives you the ability to link to the instructor as well as other students. The internet instructor also uses a slide projector and demo software packages. The telephone is used for audio portion of the training class. Web classes can be scheduled to fit the Yaskawa formal training schedule and can also be done on-site for the convenience of the customer.

Finally, the eLM (eLM™) is a computer module for available frequently seminars. They are modular in nature, pinpoint specific topics, can be completed on or offline, and only takes about 30 minutes to complete.

The eLM is a perfect fit for an experienced engineer who needs to understand a specific topic. The eLM does not allow for some typical training practices such as hands-on exercises or student discussions. Students with limited prior experience, and who require a broader and long-term understanding of our products, are advised to take a traditional factory training class.

This list contains available classes at Yaskawa for the J1000 and V1000. If your training need cannot be met by the current training schedule, please contact the Yaskawa Training Coordinator.

Product	eLearning Modules	Factory Classes	List
J1000	eLM.J1000.01	Not Available	N/A
V1000 V1000-4X	eLM.V1000.01	V1000 Installation and Startup Class Number: TRM015-V1000	\$460
		V1000 Application Programming Class Number: TRM010-V1000	\$690

To enroll, contact Technical Training Services.

Phone: 1-800-Yaskawa (1-800-927-5292) and (then dial 2 for "Drives" and 4 for "Training")
 Fax: 847-785-2724
 E-mail: training@yaskawa.com

Check out the latest class schedule and cut sheets at www.yaskawa.com

Terms and Conditions

YASKAWA AMERICA, INC. ("YAI"), DRIVES & MOTION DIVISION - TERMS AND CONDITIONS OF SALE

1. GENERAL:

(a) All sales of products or services by Yaskawa America, Inc., Drives & Motion Division (hereinafter "D&M"), is governed exclusively by these Terms and Conditions of Sale ("Terms"), which supersede all inconsistent or additional terms on Buyer's purchase order or any other document. These Terms constitute the final, complete and exclusive agreement between the parties as to the subject matter hereof. These Terms may be amended only in writing signed by an authorized representative of D&M.

(b) Orders must be submitted in the form of a written purchase order or letter from Buyer, setting forth all information necessary for D&M to fill the Order, if accepted. All proposals, quotations or similar communications from D&M are considered invitations to submit an Order. A binding sales contract will result only when D&M accepts Buyer's Order, at D&M's office in Waukegan, Illinois or such other place as designated by D&M.

2. PRICES:

(a) D&M's quoted prices are firm for thirty (30) days from the date of D&M's written quotation. Applicable price changes will be in effect at the time of shipment. D&M reserves the right to notify Buyer of any price changes to the quotation on the Order prior to acceptance by D&M. Price adjustments or volume discounts is subject to D&M's approval. All prices are in U.S. dollars. Clerical errors in a quotation or purchase order or contract are not binding on D&M.

3. TERMS OF SALE:

(a) All payments are due within thirty (30) days from date of invoice. Payment shall be made in the currency indicated on D&M's invoice. D&M reserves the right to require payment in advance, or satisfactory security, for any shipment or sale. D&M reserves the right to seek any other remedy available at law or equity and Buyer shall be liable for all expenses, including attorney's fees, in connection with the collection of past due amounts. Buyer's default constitutes a waiver of Buyer's right to demand D&M's performance under the contract.

(b) When an amount becomes past due according to its payment terms, Buyer shall pay interest on the balance due, at the greater of 1.50% per month (18% per annum) or the maximum permitted by law, until paid in full.

(c) If delivery and/or payment in installments is accepted by D&M, Buyer's failure to pay any installment when due shall give D&M the right to suspend work or delivery until such payment is made. In the event that any such default by Buyer continues for more than fifteen (15) days, D&M may then cancel the contract by written notice to Buyer.

(d) All duties, tariffs, fees, costs and other charges connected with shipment, insurance, exportation and importation of the products are the responsibility of Buyer, and, if paid by D&M, such expenses may be recovered by D&M from Buyer, and Buyer shall indemnify D&M against claims for the same. Buyer is responsible for all taxes applicable or related to this transaction, including all sales, use and excise taxes.

4. SECURITY INTEREST:

To secure any indebtedness due and owing from Buyer from time to time, Buyer hereby grants to D&M, and D&M hereby reserves, a continuing purchase money security interest in all Yaskawa-brand and other products heretofore or hereafter sold and delivered to Buyer by D&M, and all related parts, components and accessories therefor, and all proceeds arising from the sale or other disposition of the foregoing, including, but not limited to, cash, accounts, contract rights, accounts receivable, instruments and chattel paper.

Buyer shall at no time grant any security interest that conflicts with that granted to D&M herein. Buyer shall cooperate with D&M, and hereby appoints D&M as its attorney-in-fact, to execute and file, on Buyer's behalf, any documents necessary to evidence and perfect D&M's security interest. D&M reserves all rights and remedies available to it under the Uniform Commercial Code and other applicable law in the event of Buyer's default.

5. SHIPMENT, FORCE MAJEURE, AND ERROR:

(a) Shipment/delivery dates are approximations only. D&M shall not be liable to pay any penalty or damages, including consequential damages, for any delay in shipment.

(b) All shipments are F.O.B. D&M's (or its suppliers') manufacturing plant or warehouse. D&M will, at Buyer's expense, arrange for the transportation of the products from the manufacturing plant or warehouse designated by D&M. All products shall be packaged for domestic shipment in accordance with D&M's standard specifications. If special packaging is required, it must be clearly requested on Buyer's Order. The price for any special packaging shall be added to Buyer's Order. Buyer shall timely procure all necessary insurance and importation and transportation required for the shipment of the products. D&M's liability for loss or damage to products shipped by D&M shall be limited to the value of the products at the time of shipment. Risk of loss and damage to products shall pass to Buyer upon delivery of the products to the carrier, to a carrier for shipment by Buyer or its designated customer, or to a carrier for the Freight Forwarder. D&M shall not be liable for any damage to products in transit, including consequential damages, or for any delay in performance of the contract or related to the shipment, other than causes beyond D&M's reasonable control, including, but not limited to, war, blockade, civil disturbances, strikes and lockouts, labor shortages, fire and other casualties, acts of nature, accidents and governmental acts (including regulations concerning export and import licensing and currency exchange). In case of non-delivery, D&M's obligation shall be limited to the refund of any advance payment received from Buyer.

(c) All claims for loss of or damage to products, whether concealed or obvious, must be made, in writing, to the carrier and to D&M by Buyer as soon as possible after receipt of shipment, and in no case later than 90 days following receipt of shipment. All claims shall be waived. D&M will render reasonable assistance in providing information necessary for Buyer to process such damage claims with the carrier or any insurance company.

(e) Buyer agrees to accept delivery within fifteen (15) days following the anticipated date of delivery. If Buyer refuses to take delivery within the fifteen (15) day period, D&M reserves the right to charge Buyer for storage charges plus interest.

6. RETURNS/CANCELLATION CHARGES:

Buyer shall not return products to D&M without the written consent of, and upon terms agreed to, by D&M. If Buyer refuses to accept delivery, or improperly revokes acceptance of product, Buyer shall be responsible for D&M's cancellation charges and expenses. Before any returns, a Return Merchandise Authorization ("R.M.A.") number must be obtained from D&M. Products returned without an R.M.A. number clearly marked on the outside of the shipping carton will be refused. Except for approved warranty returns, D&M will only accept for return and credit new, unused, undamaged, current stock items, in the original packaging. Buyer shall be responsible for all freight charges, import/export charges, duties, tariffs, taxes, insurance and risk of loss/damage regarding return shipment to D&M.

7. **DRAWINGS/MEASUREMENTS:**

All ratings, drawings, tables, graphs and the like submitted by D&M or set forth in written materials or on the company's website are approximations only. Weights, measurements, capacities and all other particulars of products or services offered by D&M are approximations only. D&M is not responsible for such approximations, including, in particular, based on data supplied by Buyer.

8. **LIMITED WARRANTY:**

(a) At the time of shipment, new and unused product sold by D&M shall be free from defects in materials and workmanship. D&M warrants that for a period of one (1) year from the date the product is first used by Buyer, or 18 months from the date of shipment, whichever occurs first, if any product or part is found by D&M to be defective, D&M will, at its sole discretion and as Buyer's exclusive remedy, either repair, replace or return the purchase price paid to D&M; provided that the subject product is used under normal conditions for which it was designed and installed, operated and maintained in accordance with D&M's instruction and in accordance with generally accepted industrial practices. Product repaired or replaced within the warranty period shall be repaired by the foregoing warranty period of the original product. If the product is repaired or replaced within the warranty period, the replacement warranty shall be extended for a period of ninety (90) days. D&M's warranty shall be in lieu of and excludes all other warranties, whether express, implied or statutory, including, but not limited to, any implied warranties of merchantability and/or fitness for a particular purpose or use. Buyer, at Seller's option, shall have the right to return the product to D&M of written notice within sixty (60) days after discovery of the defect. D&M shall not be responsible for any products which have been altered, abused, misused, or improperly installed or repaired, or for any loss, damage, defect, claim or non-performance resulting from or attributable to Buyer's specifications. D&M does not guarantee production rates or the quality of goods made using D&M's products or services, nor shall any longer warranty periods apply, except as agreed in writing signed by an authorized D&M representative.

(b) D&M's warranty obligation shall be conditioned upon receipt by Buyer of written notice of defect within sixty (60) days after discovery of the defect. D&M shall not be responsible for any products which have been altered, abused, misused, or improperly installed or repaired, or for any loss, damage, defect, claim or non-performance resulting from or attributable to Buyer's specifications. D&M does not guarantee production rates or the quality of goods made using D&M's products or services, nor shall any longer warranty periods apply, except as agreed in writing signed by an authorized D&M representative.

(c) Where Buyer orders non-stock products or parts manufactured by a third-party, D&M will, to the extent permitted, pass through to Buyer any warranty of the manufacturer. In no event, however, shall the sole remedy for a defect in such products be the remedy offered by and available from the manufacturer, if any.

(d) **D&M'S WARRANTY HEREIN IS IN LIEU OF AND EXCLUDES ALL OTHER WARRANTIES OF D&M AND ANY PARENT OR AFFILIATED COMPANIES OF D&M. D&M DISCLAIMS ALL OTHER WARRANTIES, WHETHER EXPRESS, IMPLIED OR STATUTORY, INCLUDING, BUT NOT LIMITED TO, ANY IMPLIED WARRANTIES OF MERCHANTABILITY AND/OR FITNESS FOR A PARTICULAR PURPOSE OR USE.**

(e) **UNDER NO CIRCUMSTANCES SHALL D&M, OR ANY PARENT OR AFFILIATED COMPANY OF D&M, BE LIABLE TO BUYER OR ANY ENTITY FOR ANY SPECIAL, INDIRECT OR CONSEQUENTIAL DAMAGES, WHETHER ARISING FROM BREACH OF CONTRACT, TORT, NEGLIGENCE, MISREPRESENTATION, STRICT LIABILITY OR OTHERWISE, INCLUDING FOR LOST PROFITS, IMPAIRMENT OF GOODS, WORK STOPPAGE OR OTHERWISE, IN ANY WAY ARISING OUT OF OR RELATED TO PRODUCTS OR SERVICES SUPPLIED BY D&M OR ANY TRANSACTION TO WHICH THESE STANDARD TERMS APPLY. THE MAXIMUM LIABILITY OF D&M, INCLUDING, BUT NOT LIMITED TO, WITH RESPECT TO THE DESIGN, MANUFACTURE, SALE, DELIVERY, RESALE, INSPECTION, ASSEMBLY, INSTALLATION, TESTING, REPAIR, REPLACEMENT, MAINTENANCE OR USE OF ANY PRODUCT OR THE PERFORMANCE OF ANY SERVICE, SHALL NOT EXCEED THE PURCHASE PRICE PAID TO D&M.**

9. **INFRINGEMENT:**

The liability of D&M, any parent or affiliated company for patent infringement is limited to D&M's defense of proceeding brought against Buyer based on a claim that products, when employed in the manner intended by D&M, constitutes an infringement of any U.S. patent. If Buyer's use of the products in the manner intended by D&M is finally enjoined in such action, D&M shall, at its option, procure for Buyer the right to continue using the products, replace the same with non-infringing products, modify the products so that they become non-infringing equivalent products, or refund the purchase price (less allowance for use, damage or obsolescence). D&M makes no warranty against patent infringement resulting from portions of the products made to Buyer's specifications or the use of products in combination with any other goods or in the practice of any process, and if a claim is brought against D&M or any parent or affiliate of D&M, Buyer shall defend, indemnify and hold D&M (and its parent/affiliates) harmless from and against any and all claims, losses or damages arising therefrom.

10. **GOVERNING LAW, FORUM AND JURY WAIVER:**

These Terms and the relationship between the parties are governed by the laws of the State of Illinois. Without regard to its conflict of laws rules, for all purposes arising out of or resulting from the sale of products or services by D&M and/or the performance of the parties hereunder, Buyer shall file any and all lawsuits or claims, whether in state or federal courts located in Cook County, Illinois. Buyer hereby submits to the personal jurisdiction of the court in Cook County, Illinois, and waives its claim of improper or inconvenient venue. Buyer hereby agrees to waive its right to trial by jury for all claims and disputes arising out of or resulting from the sale of products or services by D&M and/or the performance of Buyer and D&M. Buyer hereby agrees that U.N. Convention of Contracts for the International Sale of Goods shall not apply to their relationship or the sale of products by D&M.

11. **EXPORT CONTROL:**

Buyer acknowledges that the products and related software and documentation are controlled by the U.S. Government, including the Export Administration Regulations of the U.S. Department of Commerce. Buyer shall comply with all applicable laws, regulations, treaties and agreements regarding the use, import, export or re-export of the products and shall be solely responsible for obtaining all required licenses or approvals. The products are not intended for use in any nuclear, chemical or weapons production or environmental damage or for export, re-export, or distribution to any restricted or embargoed country or to a person or entity whose privilege to participate in exports has been denied or restricted by the U.S. Government. Buyer shall indemnify, hold harmless and defend D&M, its parent and affiliated companies from any violation of this section by Buyer or its employees, consultants, agents and customers.

12. **MISCELLANEOUS:**

- (a) Failure on the part of D&M to enforce any of its rights derived from these Terms shall never be construed as a waiver of any of D&M's rights.
- (b) The invalidity of one or more of the clauses herein shall not affect the validity of the other clauses, which for this purpose are considered severable.
- (c) Any use by Buyer of any YAI trademark must be approved by YAI in writing.
- (d) Buyer may not delegate its performance or assign its rights under these Terms except upon the express written consent of D&M. In any case, these Terms shall be binding upon the successors and legal representatives of Buyer.



DMC

Drives Motors Controls

DMC

Drives Motors Controls

Variable Speed Microdrive Catalog

DMC

Drives Motors Controls