

# W21

## Three Phase LV Motors

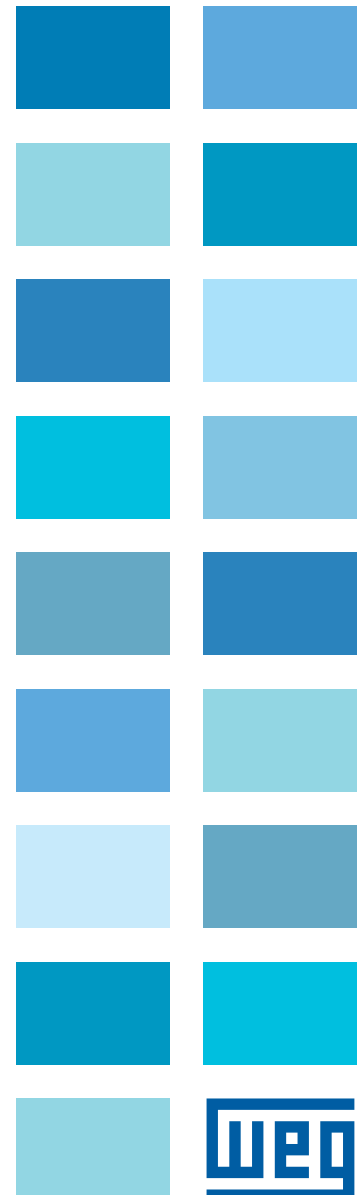

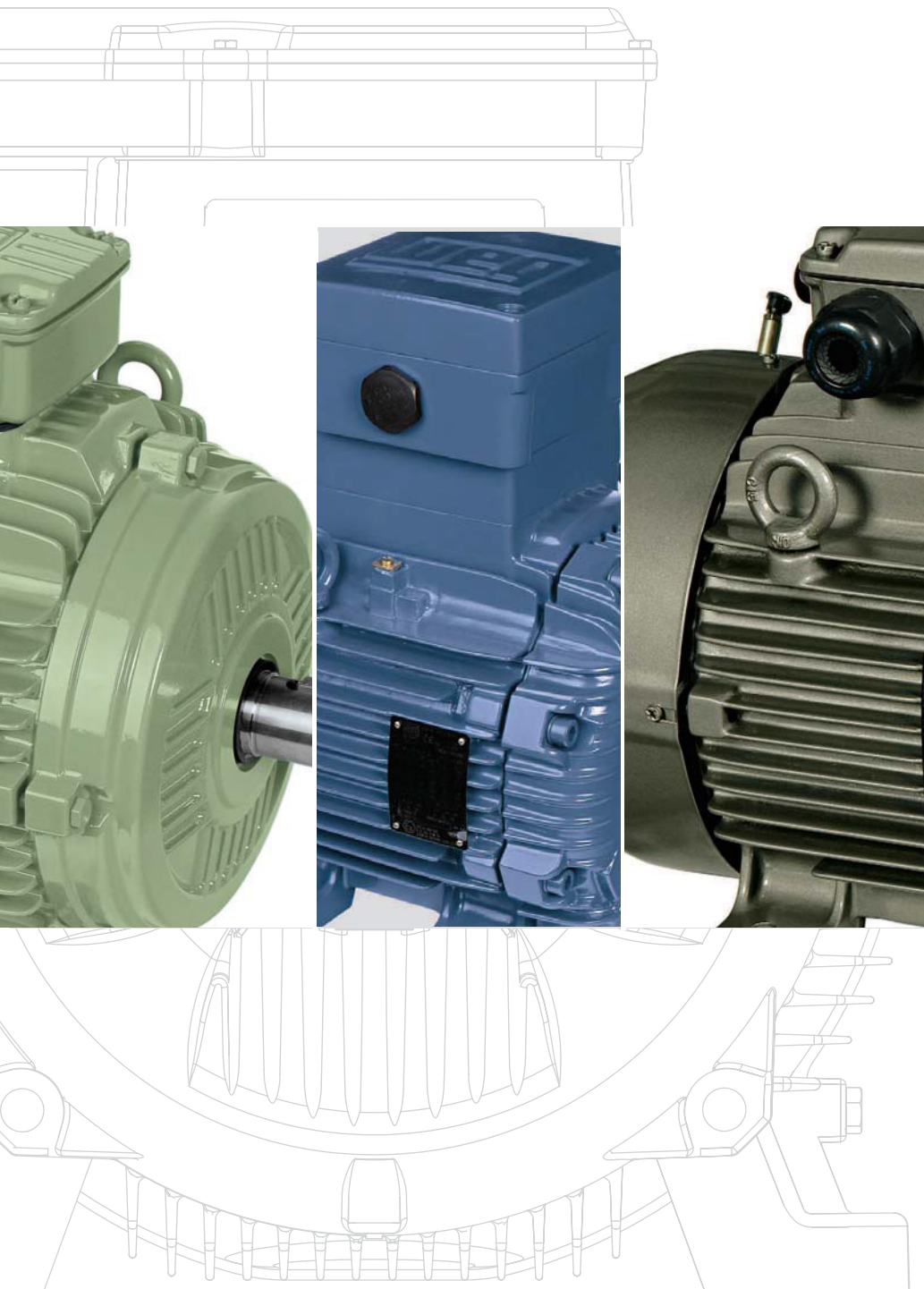
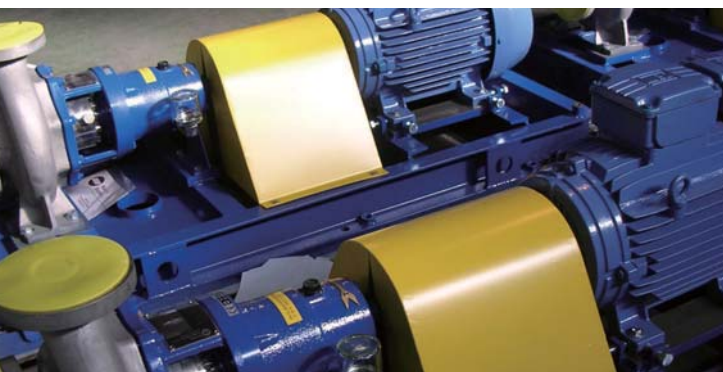

## W21 - Cast Iron Frame

Three phase asynchronous motor, with lower acquisition cost and high technology. Easy to adapt to the most application types, allowing to your company agility during installation, easy operation and low maintenance cost. The project is according to IEC34 standards, which guarantees higher energy savings. The following types of W21 motors are available: IE1, IE2, IE3, IE4 and suitable for the use with Frequency Inverters.

### Motor Features:

- Output: 0.18 up to 330kW
- Poles: II, IV, VI and VIII
- Frame: 80 up to 355M/L
- Three-phase multivoltage, IP55, 50Hz and 60Hz
- Totally Enclosed Fan Cooled (TEFC)

### Applications

Pumps, fans, crusher, conveyors, machine tools, milling machines, centrifugal machines, presses, elevators, looms, grinders, woodworking, cooling, packaging equipment, other severe duty application.

Features	Benefits
WISE Insulation System	Increase the electrical strength of the stator, allowing the motor to operate with frequency inverters, without damaging by the voltage peaks*.
Efficiency	IE3 and Top Premium IE4 motors, guarantee a fast return of investment.
Painting Plan for Industrial Environments	Suitable for the use in slightly severe and sheltered environments, with low average humidity, regular temperature variations.
Cast Iron Frames	More strength for your application
State-of-the-art Ventilation System	Uniform refrigeration of the motor with significant temperature reduction in the external surface and bearings, guarantee high performance and energy saving to your application.
Customization	Product suitable to meet the most demanded applications in the industry.

\* Notes:

Motor rated Voltage	Insulation System	Technical criteria for use of motors fed by inverters F(F)			
		Voltage peak in the motor (Maximum)	dV/dt Inverter outlet (Maximum)	Rise Time(*) Of Inverter (minimum)	MTBP(*) Time between pulses (minimum)
$V_{NOM} \leq 460V$	Standard Insulation	$\leq 1600V$	$\leq 5200 V/\mu s$	$\geq 0,1 \mu s$	$\geq 6 \mu s$
$460 V < V_{NOM} \leq 575V$	Reinforced Insulation	$\leq 2000V$	$\leq 6500 V/\mu s$		



## W21 - Cast Iron Frame Inverter Duty

WEG TEBC Cast Iron motors were designed to meet several applications where wide speed range variation is required. The windings are enameled with class H varnish and exclusive patented WISE insulation, which allows 3 times longer motor. The independent fan system offers low voice level and maximum cooling at low speeds. As additional feature, the WEG TEBC motor can be supplied with encoder which allows perfect motor speed control for critical applications.

### Motor Features:

- Output: 0.18 up to 330kW
- Poles: II,IV,VI, and VIII
- Frame: 80 up to 355M/L
- Three-phase, IP55, 50Hz and 60Hz
- Totally Enclosed Blower Cooled (TEBC)
- Reinforced insulation

### Applications

Grinders, conveyors, mixers, fans, pumps, extruders, winding, recoilers.



Features	Benefits
WISE Insulation system	Increase the electrical strength of the stator, allowing the motor to operate with frequency inverters, without damaging by the voltage peaks*.
Efficiency	IE2 and IE3 motors, guarantee a fast return of investment
Independent Ventilation System	Low noise level by means of efficient cooling provided by a separate motor having maximum cooling flux over main motor, even at low speed operation
Efficiency	IE2 and IE3 motors, guarantee a fast return of investment.
Painting Plan for Industrial Environments	Suitable for the use in slightly severe and sheltered environments, with lowaverage humidity, regular temperature variations
Cast Iron Frames	More strength for your application
Customization	Product suitable to meet the most demanded applications in the industry.

\* Notes:

Motor rated Voltage	Technical criteria for use of motors fed by inverters			
	Voltage peak in the motor (Maximum)	dV/dt Inverter outlet (Maximum)	Rise Time(*) Of Inverter (minimum)	MTBP(*) Time between pulses (minimum)
$V_{NOM} \leq 460V$	$\leq 1600V$	$\leq 5200 V/\mu s$	$\geq 0,1 \mu s$	$\geq 6 \mu s$
$460V < V_{NOM} \leq 575V$	$\leq 2000V$	$\leq 6500 V/\mu s$	$\geq 0,1 \mu s$	
$575V < V_{NOM} \leq 690V$	$\leq 2400V$	$\leq 7800 V/\mu s$	$\geq 0,1 \mu s$	

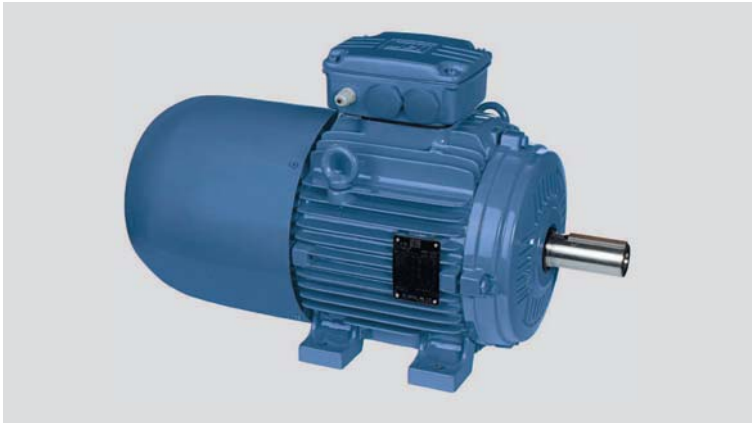

## Brake motor

In order to have a company working with high performance it is necessary to have equipments working according to its needs.

WEG brake motor is perfect to equipments where fast safety stops are required, positioning and time saving. WEG braking solutions allows synergy in the production process, helping with agility and safety. WEG brake motors are available in versions: IE1,IE2,IE3 and they are suitable for the use with frequency inverters\*.

### Motor Features:

- Output: 0,12 up to 37kW
- Poles: II, IV, VI and VIII
- Frame: 63 up to 200L
- Three-phase, IP55, TEFC, 50Hz and 60 Hz
- Cast Iron Frame or Aluminum Frame

### Applications

These motors can be used on any machine that requires quick stops and time savings during installation: machine tools, looms, packing machines, gates, wood machines, cranes, other severe duty applications.



Features	Benefits
High performance braking system	Guarantee precision braking, fast and safe with easy maintenance.
Manual brake release	Possibility to keep the motor free during emergency situations or whenever necessary.
WISE Insulation System	Increase the electrical strength of the stator, allowing the motor to operate with frequency inverters, without damaging by the voltage peaks*.
Efficiency	IE2,IE3 motors, guarantee a fast return of investment.
Painting Plan for Industrial Environments	Suitable for the use in slightly severe and sheltered environments, with low average humidity, regular temperature variations.
State-of-the-art Ventilation System	Uniform refrigeration of the motor with significant temperature reduction in the external surface and bearings, guarantee high performance and economy to your application.
Customization	Product suitable to meet the most demanded applications in the industry.

\* Notes:

Motor rated Voltage	Insulation System	Technical criteria for use of motors fed by inverters F(F)			
		Voltage peak in the motor (Maximum)	dV/dt Inverter outlet (Maximum)	Rise Time(*) Of Inverter (minimum)	MTBP(*) Time between pulses (minimum)
$V_{NOM} \leq 460V$	Standard Insulation	$\leq 1600V$	$\leq 5200 V/\mu s$	$\geq 0,1 \mu s$	$\geq 6 \mu s$
$460 V < V_{NOM} \leq 575V$	Reinforced Insulation	$\leq 2000V$	$\leq 6500 V/\mu s$		





## Ex nA Non Sparking

The installation of electric motors where a flammable mixture is not frequently present but may represent risks, must comply to the most demanded safety standards for the protection of life, machines and environment.

Following to the highest safety standards WEG Ex nA motors are flexible to adapt to various applications allowing to your company agility during installation, easy operation, low maintenance cost and safety. WEG Ex nA motors are available in versions: IE1,IE2,IE3 and suitable for the use with Frequency Inverters.

### Motor Features:

- Output: 0.12 up to 315kW
- Poles: II, IV, VI and VIII
- Frames: 63 up to 355 M/L
- Three-phase, IP55, TEFC, 50Hz and 60 Hz.

### Applications

Pumps, fans, milling applications, centrifugal machines, presses, elevators, machine tools, woodworking, grinders, looms, cooling, packaging machines, conveyors, wash and bottling machines.

Features	Benefits
Reduced motor external surface temperature	Do not allow conductive dust ignition in contact with the motor or during suspension in the air.
Certification for the use with frequency inverters	Guarantee in speed variation applications and hazardous areas such Zone 2, according to certification.
Efficiency	IE2,IE3 motors, guarantee a fast return of investment.
WISE Insulation System	Increase the electrical strength of the stator, allowing the motor to operate with frequency inverters, without damaging by the voltage peaks.
Painting Plan for Severe Environments	Special for industrial severe environments, sheltered or not, which may contain SO <sub>2</sub> , steam, solid contaminants and high humidity.
Flexibility	Product suitable to meet the most demanded applications in the industry.

#### Notes:

Classification: WEG Ex nA motor line, which was up to now designed to operate at areas classified as Zone 2 (combustible gas), are now suitable to operate also at Zone 22 containing non-conductive combustible dusts. Based on a careful design carried out in conformance with pre-established requirements of applicable European Standards and Directives these motors offer you the reliability and safety that you need.

IEC Standard: CENELEC Standard:

IEC Standard:

CENELEC Standard:

Zone 2 (gas) and 22 (non-conductive dust); Group IIC

Group IIC; Category 3G (gas) and 3D (non-conductive dust)

The classification in Group IIC means that the motor is suitable to operate also in Groups IIA and IIB once Group IIC represents an operating condition worse than Groups IIA and IIB.

Certification: WEG non sparking motors meet ATEX Directive 94/4EC certified by PTB - Physikalisch-Technische Bundesanstalt as per EN50014 / EN50021 and are now BASEEFA Certified.



## Smoke Extraction

Assure safety where a large concentration of people in commercial and industrial facilities is present is one of the main concerns of designers and company owners during the project of shopping centers, factories, warehouses, covered parking lots, tunnels and other places which concentrate a large number of people. The Smoke motors are certified\* for high temperatures and guarantee a rapid smoke and heat extraction and delay in fire propagation, allowing free access to the emergency exits.

### Applications

Large buildings, shopping malls, factories, warehouses, enclosed parking lots, other ventilation systems.

Duty	F200	F300	F400
	S1 - 40°C	S1 - 40°C	S1 - 40°C
	S2* - 200°C - 2 hours	S2* - 300°C - 1 hours	S2* - 400°C - 2 hours
Certification	WEG Self Declaration	BSRIA - U.K. Frames: 80 to 250 Also available certification for 300° C/2 hours	BSRIA – U.K. Frames: 80 to 180 Outputs: 0.75kW – 27kW
			CTICM – France Frames: 90 to 280 Pole:IV, VI, VIII, VI/IV, VIII/IV, VIII/VI poles
Insulation Class	Ins. Class F; Temp. Rise 80K	Ins. Class H; Temp. Rise 80K or 105K	
Standard	EN 12101-3		
Pole / Frame sizes available	II, IV/II (frame sizes 80 up to 315S/M)		
	IV, VI, VIII, VIII/IV, VI/IV pole (frame sizes 80 up to 355M/L)		
Construction	TEFC or TEAO (foot or flange mounted / pad mounted for frame sizes 80 up to 250)		

\*Continuously rated for normal ambient and emergency duty at rated temperature and time.

Features	Benefits
WISE Insulation System	Increase the electrical strength of the stator, allowing the motor to operate with frequency inverters, without damaging by the voltage peaks.
Painting Plan for Industrial Environments	Suitable for the use in slightly severe and sheltered environments, with low average humidity, regular temperature variations.
Cast Iron Frame	More strength for your application
State-of-the-art Ventilation System	Uniform refrigeration of the motor with significant temperature reduction in the external surface and bearings, guarantee high performance and energy saving to your application.
Customization	Product suitable to meet the most demanded applications in the industry.

## 1. General information

The WEG W21 series motors are designed to meet specific requirements of some markets. These motors are available in frame sizes IEC 63 to 355M/L. They are suitable for 3 Phase, 50 Hz Supply and are also suitable to operate at tolerances of  $\pm 10\%$  in voltage,  $\pm 5\%$  in frequency and  $\pm 10\%$  combined variation of both voltage and frequency. Additionally, they can operate continuously with a 2% unbalance on power supply voltage.

These motors are supplied with six terminals and are suitable for DOL starting and Star-Delta (except for output ratings below 1.5 kW, which are supplied with internally star-connected windings with three terminals in the terminal box). The minimum Pull Out torque is 210% of the rated torque and the starting current corresponds to 6 times the rated current value. All performance parameters are at rated supply conditions and are subject to tolerance as per IEC standard.

## 2. Standards

The W21 motors meet the requirement and regulations of updated version of the following standards:

IEC60034-1 Rotating electrical machines – Part 1: Rating and performance.

IEC60034-2 Rotating electrical machines – Part 2: Standard methods for determining losses and efficiency from tests (excluding machines for traction vehicles).

IEC60034-5 Rotating electrical machines – Part 5: Degrees of protection provided by the integral design of rotating electrical machines (IP code) – classification.

IEC60034-6 Rotating electrical machines – Part 6: Methods of cooling (IC code).

IEC60034-7 Rotating electrical machines – Part 7: Classification of types of enclosures and mounting arrangements (IM code).

IEC60034-8 Rotating electrical machines – Part 8: Terminal markings and direction of rotation.

IEC60034-9 Rotating electrical machines – Part 9: Noise limits.

IEC60034-11-1 Rotating electrical machines – Part 11-1: Thermal protection.

IEC60034-12 Rotating electrical machines – Part 12: Starting performance of single-speed three-phase cage induction motors.

IEC60034-14 Rotating electrical machines – Part 14: Mechanical vibration of certain machines – Limits of vibration.

IEC60072-1 Dimensions and output series for rotating electrical machines – Part 1: Frame numbers 56 to 400 and flange numbers 55 to 1080.

## 3. Construction details

### 3.1 Frame / Endshields

The frame and endshields are manufactured with FC-200 cast iron and they were designed in such a way to improve the heat exchange and to provide enough mechanical strength to meet the most critical applications. Frame size 112M and above are fitted lifting eyebolts for easier handling on installation.

All endshields were designed with drain holes to allow drainage of condensed water out of the frame. These drain holes are fitted with rubber plugs that allow draining such condensed water and comply with the degree of protection.

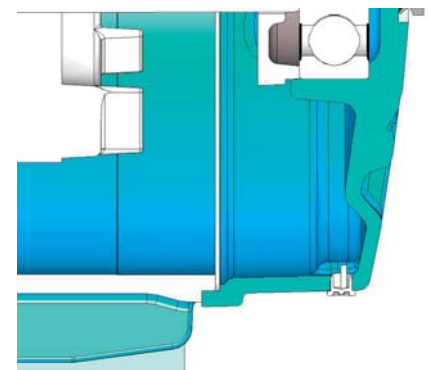

Figure 1 - Position of the drain hole and drain plug on the drive endshield

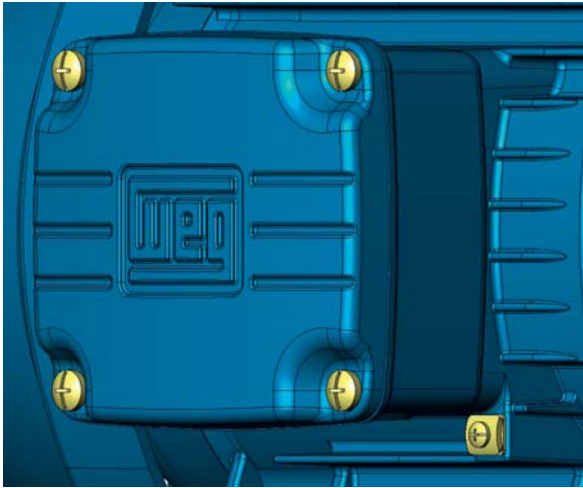

Figure 2 - Detail of the grounding lugs on the frame

### 3.2 Grounding

The W21 Cast Iron motor, frame 80-200 are designed with two grounding lugs: one is place inside the terminal box, another one is on the frame. Frame 225-355 are designed with three grounding lugs: one is inside the terminal box and the other two are on the frame.

### 3.3 Fan cover

The fan cover is made of steel plate for frame 63 up to 355.

### 3.4 Terminal box

Same as the frame and endshields, the terminal box is made of FC-200 cast iron material. It is designed with plenty internal space for easier cable connection and it allows rotation at 90 degrees steps which results in flexibility on installation. Terminal box holes comply with information given on the table below. The remaining external dimensions of the terminal box are shown on the mechanical tables.

Frame size	Holes dimensions for terminal box
63	2 x M20 x 1.5
71	
80	
90	2 x M25 x 1.5
100	
112	2 x M32 x 1.5
132	
160	2 x M40 x 1.5
180	
200	
225	2 x M50 x 1.5
250	
280	2 x M63 x 1.5
315	
355	

Different number and dimensions of holes are available on request.

In order to guarantee the degree of protection, the cables entry must comply with the same degree of protection indicated on the motor nameplate. If the procedure is not followed accordingly, warranty will be void. If further information is required, contact WEG Service Department.

Table 1 - Type of thread and holes dimensions for terminal box

#### 3.4.1 Connection leads

The connection leads are marked in accordance with IEC 60034-8 and are supplied with specific connection terminals. W21 motors wound for 415 V are fitted with polyester made BMC (Bulk Moulding Compound) terminal blocks, which are reinforced with fiber glass, as shown on the figure below.

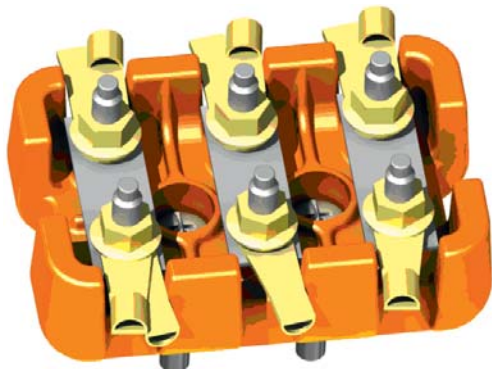

Figure 3 - Six-pin terminal block



### 3.4.2 Connection of accessories

Whenever they are supplied with accessories, the W21 motors are fitted with additional terminal box. This terminal box is supplied with connectors to allow assembly of the accessories terminals and it is designed with a 1xM20x1.5 threaded hole for field installation. The dimensions for the additional terminal boxes can be found the mechanical section of the catalog.



Figure 4 - Additional terminal box attached to terminal box

### 3.5 Nameplate

Main and additional nameplates are made of AISI 304 stainless steel and all information is laser engraved on them. Important and useful information is included in such nameplates like serial number, output power, voltage, frequency, rated current, degree of protection, power factor, thermal class, bearing type, type of grease and lubrication intervals.

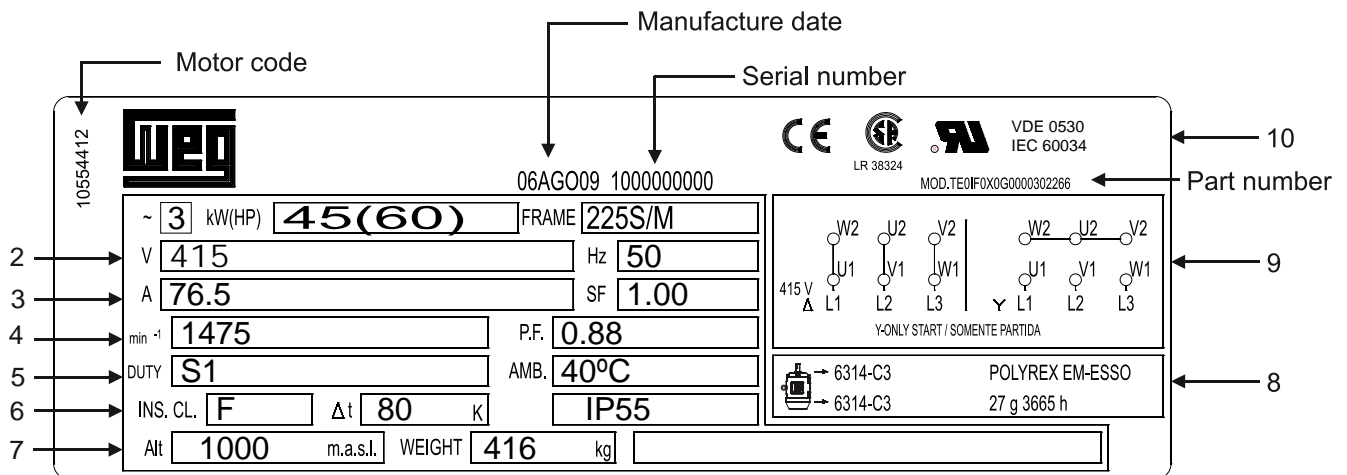

Figure 5 - Typical W21 motor nameplate

**Line 1:**

PH - Three phase: 3  
kW (HP) - Motor rated power: 45 (60)  
Frame - Frame size : 225S/M

**Line 2:**

V - Rated operating voltage: 415  
Hz - Frequency : 50

**Line 3:**

A - Rated operating current: 76.5  
SF - Service factor: 1.00

**Line 4 :**

min<sup>-1</sup> - Motor rated speed: 1475 RPM  
P.F - Power factor: 0.88

**Line 5:**

DUTY - Duty Cycle: S1  
AMB - Ambient temperature: 40°C

**Line 6 :**

INS CL - Insulation class : F  
ΔT - Temperature rise:80K  
IP55 - Degree of Protection

**Line 7:**

ALT - Altitude: 1000 m.a.s.l  
WEIGHT - Motor weight: 141

**Line 8:**

6314-C3 - Drive end bearing specification  
POLYREX EM-ESSO - Type of grease for bearings  
6314-C3 - Non-drive end bearing specification  
27 g 3665 h - Amount of grease and relubrication intervals in hours

**Line 9 :**

Δ - Connection diagram for rated voltage of 415  
Y - Connection diagram for motor starting

**Line 10 :**

Standards/ Certifications

## 4. Cooling system / Noise level / Vibration level

### 4.1 Cooling system / Noise level

The W21 standard motor line is totally enclosed fan cooled (IC411), as per IEC 60034-6. Non-ventilated versions (TENV), air over (TEAO) and forced ventilation TEFV (IC416) are available on request. More information about IC 416 can be found in the section about Variable Frequency Drive Operation.

Fans are made of polypropylene from frame IEC 63 to 315 and made of aluminium in frames 355M/L. Designed for low noise level, the W21 motors comply with IEC60034-9 Standard and the corresponding sound pressure levels. Tables below shown sound pressure levels in dB(A) which are obtained upon tests for 50 Hz.

Frame size	2 poles	4 poles	6 poles	8 poles
63	52	44	43	-
71	56	43	43	41
80	59	44	43	42
90	64	49	45	43
100	67	53	44	50
112	64	56	48	46
132	68	60	52	48
160	70	67	56	51
180	70	64	56	51
200	74	69	58	53
225	82	70	61	56
250	82	70	61	56
280	83	76	66	59
315	84	77	69	62
355	81	79	73	70

Table 2 - Sound pressure levels for 50 Hz motors

The noise level figures shown on the table above are taken at no load. Under load the IEC 60034-9 Standard foresees an increase of the sound pressure levels as shown on table 3.

Shaft height H (mm)	2 poles	4 poles	6 poles	8 poles
90 ≤ H ≤ 160	2	5	7	8
180 ≤ H ≤ 200	2	4	6	7
225 ≤ H ≤ 280	2	3	6	7
H = 315	2	3	5	6
355 ≤ H	2	2	4	5

Table 3 - Maximum expected increase of sound pressure level for loaded motors

### 4.2 Vibration level

W21 motors are dynamically balanced with half key and the standard version meets the vibration levels of Grade A (without special vibration requirements) described in IEC 60034-14 Standard. As an option, motors can be supplied in conformance with vibration of Grade B. The RMS speed and vibration levels in mm/s of Grades A and B are shown in table 4.

Vibration	Shaft Height	63 ≤ H ≤ 132	132 < H ≤ 280	H > 280
	Assembly	Vibration speed RMS (mm/s)		
Grade A	Free suspension	1.6	2.2	2.8
Grade B	Free suspension	0.7	1.1	1.8

Table 4 - Speed and vibration levels

## 5. Shaft / Bearings / Thrusts

### 5.1 Shaft

The shaft of W21 standard motors is made of AISI 1040/45 steel in frames IEC 63 to 315S/M and in AISI 4140 steel in frames 315B and 355M/L. When supplied with roller bearings as an option, shaft material must be AISI 4140.

Since they are fitted with AISI 4140 steel shaft in frames 315B and 355M/L, W21 motors can be supplied with roller bearings, so they will be suitable for heavy duty applications such as pulley and belt applications. Further information about maximum allowable radial and axial loads on shaft end is given in tables 6, 7 and 8.

Important: To modify bearings from ball into roller, drive end and non-drive end bearing caps (internal and external) need to be replaced since non-drive end bearing remains locked. If further information is required, contact WEG Service Department.

Shafts are supplied with A type key in frame sizes 63 to 200 and type B in frames 225 to 355, and with dimensions shown in section 14 - Mechanical data. All these shafts are supplied with threaded center hole with dimensions that comply with table 5.

Frame size	Number of Poles	Dimension
63	All	M4
71	All	M5
80	All	M6
90	All	M8
100	All	M10
112	All	M10
132	All	M12
160	All	M16
180	All	M16
200	All	M20
225S/M	All	M20
250S/M	All	M20
280S/M	All	M20
315S/M	All	M20
315B	2 poles	M20
	Others	M24
355M/L	2 poles	M20
	Others	M24

Table 5 - Center hole dimensions for drive end shaft

As an option, W21 motors can be supplied with stainless steel shaft AISI 316 and AISI 420 for highly corrosive environments.

**Note: 2 poles motors will have, as an option, only the shaft end with AISI 316 stainless steel.**

### 5.2 Bearings

W21 motors are supplied with 62 series ball bearings on drive end for frame 63 to 100, and 63 series from frame 112M and above. Bearing life time is L10h with 20,000 hours in conformance with maximum radial and axial loads as described in tables 5 and 6. For direct coupling arrangements (free of radial and axial thrusts), bearing life time will be L10h with 40,000 hours.

**Note: Life time L10 means that at least 90% of the bearings submitted to maximum indicated loads will reach the numbers of predicted hours. The maximum allowable radial and axial loads for standard configuration are given in tables 6 and 7 ahead. Maximum radial load values consider axial load as void. At the same time, maximum axial load values consider radial load as void. Contact WEG to get information about bearing life time for applications with combined axial and radial loads.**

The bearing life time depends on the type and size of the bearing, on radial and axial mechanical loads that the motor is submitted to, on operating conditions (ambient, temperature), and on speed and quality of the grease. Therefore, the bearing life time is directly related to correct application, maintenance and lubrication. When amount of grease and lubrication intervals are followed accordingly, bearings are expected to reach their pre-defined life time. W21 motors are supplied with ZZ bearings (sealed for life) in frames 63 to 132 and open from frame size 160 and above. Amount of grease and lubrication intervals are given on the nameplate and are shown in tables 9 and 10 ahead. Excess of grease, which is an amount of grease exceeding what is indicated on the nameplate, can result in bearing over temperature.

### 5.2.1 Bearing locking

For the standard line, the drive end bearing is locked axially with the external bearing cap in frame sizes 160 up to 200, and with internal and external bearing cap in frame sizes 225 up to 355. The non-drive end bearing is fitted with a spring washer in frame sizes 63 up to 200, and pre-load spring in frame sizes 225 up to 355 to take any axial play.

When supplied with roller bearings (optional feature that is available from frame 132), the non-drive end bearing is locked and any axial play is compensated by axial play of the drive end roller bearing. The minimum allowable radial loads for roller bearings are shown in table 8 ahead.

Important:

1 - Special applications

Motor operations at different conditions compared to the normal ones, such as ambient temperature, altitude, axial and radial loads above those given by the tables included in this document require specific and different lubrication intervals from those given herewith.

2 - Roller bearings

Roller bearings require minimum radial load so as to ensure correct operation. They are not recommended for direct coupling arrangement neither for 2 pole motors.

3 - Frequency drive operation motors

Bearing life time may be reduced when motor is driven by frequency drive and speed above the normal one. The speed itself is one of the items taken into consideration when defining bearing life time.

4 - Motors with modified mounting configuration

Motors supplied with horizontal mounting but for vertical operation, lubrication interval must be reduced by half.

5 - Figures for radial thrusts

The figures given in the tables below for radial thrusts take into consideration the point where the load is applied which is on the middle of the shaft end length  $L/2$  and at the very end of the shaft end  $L$ .

### Radial thrust (L10 with 20,000 hours)

---

Table 6 - Maximum radial thrusts for ball bearings

\*1 kN = 101.97 kgf = 224.8 lbf

**Axial thrust (L10h with 20,000 hours)**

50 Hz - Fa in (kN*) - 20,000 hours							
Frame	Poles	Horizontal		Vertical with shaft upwards		Vertical with shaft downwards	
		Pushing	Pulling	Pushing	Pulling	Pushing	Pulling
63	2	0.19	0.19	0.18	0.20	0.19	0.19
	4	0.27	0.27	0.26	0.29	0.28	0.26
	6	0.34	0.35	0.33	0.37	0.35	0.34
	8	0.34	0.35	0.33	0.37	0.35	0.34
71	2	0.20	0.28	0.19	0.30	0.20	0.27
	4	0.29	0.40	0.27	0.42	0.29	0.38
	6	0.35	0.49	0.35	0.52	0.37	0.48
	8	0.46	0.60	0.44	0.63	0.46	0.59
80	2	0.26	0.42	0.25	0.43	0.27	0.40
	4	0.35	0.56	0.32	0.60	0.36	0.53
	6	0.45	0.70	0.42	0.74	0.46	0.67
	8	0.55	0.83	0.53	0.88	0.56	0.80
90	2	0.37	0.43	0.34	0.47	0.38	0.40
	4	0.51	0.59	0.48	0.65	0.53	0.55
	6	0.63	0.71	0.58	0.79	0.64	0.67
	8	0.76	0.86	0.72	0.93	0.78	0.82
100	2	0.37	0.59	0.32	0.67	0.38	0.55
	4	0.50	0.81	0.44	0.90	0.52	0.75
	6	0.65	1.02	0.58	1.14	0.68	0.95
	8	0.78	1.19	0.71	1.32	0.81	1.12
112	2	0.54	1.14	0.48	1.23	0.56	1.08
	4	0.73	1.55	0.66	1.67	0.76	1.47
	6	0.96	1.94	0.89	2.05	0.99	1.86
	8	1.07	2.15	0.97	2.35	1.11	2.05
132	2	0.72	1.32	0.61	1.51	0.76	1.21
	4	0.99	1.81	0.84	2.05	1.03	1.66
	6	1.22	2.20	1.05	2.45	1.27	2.05
	8	1.37	2.45	1.16	2.80	1.44	2.25
160	2	2.40	1.69	2.20	2.05	2.75	1.48
	4	2.95	2.25	2.65	2.65	3.40	1.95
	6	3.40	2.70	3.10	3.25	3.95	2.40
	8	3.85	3.15	3.55	3.70	4.40	2.85
180	2	3.20	2.30	2.90	2.75	3.65	2.00
	4	3.90	3.00	3.55	3.65	4.55	2.65
	6	4.65	3.75	4.20	4.45	5.30	3.30
	8	5.20	4.35	4.80	5.10	6.00	3.90
200	2	3.55	2.55	3.10	3.25	4.25	2.10
	4	4.45	3.45	3.95	4.25	5.30	2.95
	6	5.20	4.20	4.65	5.10	6.10	3.65
	8	6.00	5.00	5.50	5.90	6.90	4.50
225	2	4.35	3.55	3.65	4.60	5.40	2.90
	4	5.50	4.70	4.70	6.00	6.80	3.95
	6	6.60	5.80	5.80	7.20	8.00	5.00
	8	7.50	6.70	6.60	8.20	8.90	5.90
250	2	4.30	3.50	3.55	4.65	3.55	2.75
	4	5.30	4.45	4.30	6.10	6.90	3.50
	6	6.40	5.60	5.40	7.30	8.10	4.60
	8	7.30	6.50	6.30	8.20	9.00	5.50
280	2	4.15	3.35	3.00	5.10	5.90	2.20
	4	5.80	5.00	4.35	7.40	8.20	3.55
	6	7.20	6.40	5.70	8.80	9.60	4.90
	8	8.40	7.60	7.10	9.80	10.5	6.30
315	2	3.65	2.85	1.91	5.60	6.40	1.13
	4	6.10	5.40	3.85	9.10	9.80	3.10
	6	7.40	6.60	4.75	10.9	11.7	3.95
	8	8.50	7.70	5.70	12.2	13.0	4.95
355	2	3.70	2.95	0.75	7.50	8.30	-
	4	6.60	5.80	2.10	12.5	13.2	1.37
	6	7.70	7.00	2.75	14.7	15.4	2.00
	8	7.70	7.00	2.75	14.7	15.4	2.00

Table 7 - Maximum axial thrusts for ball bearings  
 \* 1 kN = 101.97 kgf = 224.8 lbf



### Radial thrust (L10 with 20,000 hours)

50 Hz - Fr in (kN*) - 20,000 hours						
Frame	4 poles		6 poles		8 poles	
	L/2	L	L/2	L	L/2	L
160	6.01	3.69	5.91	3.62	6.05	3.71
180	10.5	5.78	10.4	5.69	10.3	5.65
200	13.4	8.40	13.3	8.34	13.5	8.43
225	17.1	8.73	16.9	8.56	17.0	8.66
250	16.8	10.3	16.7	10.2	16.6	10.1
280	23.4	14.5	23.2	14.4	22.9	14.2
315	28.6	14.3	27.4	13.7	27.9	14.0
355	40.2	25.4	40.2	25.2	39.6	24.8

Table 8 - Maximum radial thrusts for roller bearings

\* 1 kN = 101.97 kgf = 224.8 lbf

Note: The figures given for roller bearings take into consideration that the shaft is supplied with AISI 4140.

### Lubrication intervals – Ball bearings

Lubrication Intervals (50 Hz)			
Frame	Poles	Bearings	Hours
160	2	6309	18100
	4		20000
	6		20000
	8		20000
180	2	6311	13700
	4		20000
	6		20000
	8		20000
200	2	6312	11900
	4		20000
	6		20000
	8		20000
225	2	6314	4500
	4		11600
	6		16400
	8		19700
250	2	6314	4500
	4		11600
	6		16400
	8		19700
280	2	6314	4500
	4	6316	10400
	6		14900
	8		18700
315	2	6314	4500
	4	6319	9000
	6		13000
	8		17400
355	2	6316	3520
	4	6322	7200
	6		10800
	8		15100

Table 9 - Lubrication interval for ball bearings

### Lubrication intervals – Roller bearings

Lubrication Intervals (50 Hz)			
Frame	Poles	Bearings	Hours
160	4	NU309	20000
	6		20000
	8		20000
180	4	NU311	20000
	6		20000
	8		20000
200	4	NU312	20000
	6		20000
	8		20000
225	4	NU314	8900
	6		13100
	8		16900
250	4	NU314	8900
	6		13100
	8		16900
280	4	NU316	7600
	6		11600
	8		15500
315	4	NU319	6000
	6		9800
	8		13700
355	4	NU322	4400
	6		7800
	8		11500

Table 10 - Lubrication intervals for roller bearings

### 5.2.2 Bearing monitoring

Optionally, bearing temperature detectors can be installed to monitor bearing operating conditions. The most commonly accessory is the PT-100 temperature detector for continuous operating temperature monitoring. This monitoring is quite important since it affects directly the grease and bearing life time.











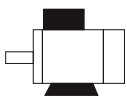

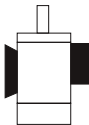
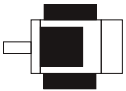
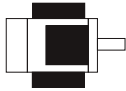
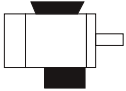
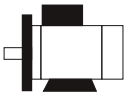
## 6. Mounting

The mounting configuration for W21 complies with IEC 60034-7 Standard. Standard mountings and their variations are shown on the figure below. After the designation (see table below) a characteristic letter is used to define the terminal box position. So the mounting IM B3 can be noticed on WEG documents as shown below (without code IM):

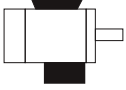
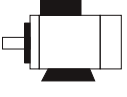
B3R – terminal box on right side of the frame viewing the motor from shaft end.

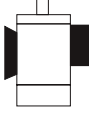
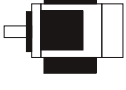
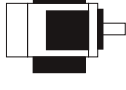
B3L – terminal box on left side of the frame viewing motor from shaft end.

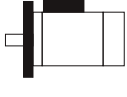
B3T – terminal box on top of the frame.

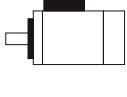
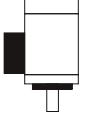
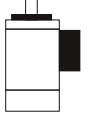
Basic types of construction	Other types of construction				
<b>IM B3</b> <b>IM 1001</b> 	<b>IM V5</b> <b>IM 1011</b> 	<b>IM V6</b> <b>IM 1031</b> 	<b>IM B6</b> <b>IM 1051</b> 	<b>IM B7</b> <b>IM 1061</b> 	<b>IM B8</b> <b>IM 1071</b> 
<b>IM B3</b> <b>IM 2001</b> 	<b>IM V15</b> <b>IM 2011</b> 	<b>IM V36</b> <b>IM 2031</b> 	<b>-</b> <b>IM 2051</b> 	<b>-</b> <b>IM 2061</b> 	<b>-</b> <b>IM 2071</b> 
<b>IM B3</b> <b>IM 2101</b> 	<b>IM V15</b> <b>IM 2111</b> 	<b>IM V36</b> <b>IM 2131</b> 	<b>-</b> <b>IM 2151</b> 	<b>-</b> <b>IM 2161</b> 	<b>-</b> <b>IM 2171</b> 
<b>IM B5</b> <b>IM 3001</b> 	<b>IM V1</b> <b>IM 3011</b> 	<b>IM V3</b> <b>IM 3031</b> 			
<b>IM B14</b> <b>IM 3501</b> 	<b>IM V18</b> <b>IM 3611</b> 	<b>IM V19</b> <b>IM 3631</b> 			

*\*) Non-defined mountings by IEC 60034-7  
 Table 11 - Mounting configurations*

Important:

1. The mountings IM B34 and IM B14 (with C flange as per DIN 42.948) are not available up to frame sizes 132.
2. For vertically shaft down mounted motors, the application of a drip cover is recommended to prevent from ingress of small objects into the fan cover/ fan.
3. For vertically shaft up mounted motors installed in environments containing liquids, the application of a rubber slinger is recommended to prevent from ingress of such liquids into the motor through the shaft.

## 7. Degree of protection / Painting

### 7.1 Degree of protection

The W21 motors are supplied with degree of protection in conformance with 60034-5. They are IP55 which means:

- a) First characteristic numeral 5: machine protected against dust. The enclosure is protected against contacts moving parts and ingress of dust not totally prevented, but dust does not enter in sufficient quantity to interfere with satisfactory operation of the machine.
- b) Second characteristic numeral 5: Machine protected against water jets. Water projected by a nozzle against the machine from any direction shall have no harmful effect

### 7.2 Painting

The W21 motors are supplied as standard with painting plan 207A (80-132) and 203A (160-355), consisting of:

- Primer: one coat with 20 to 55  $\mu\text{m}$  of alkyd primer;
- Finishing: one coat with 40 to 60  $\mu\text{m}$  of alky synthetic enamel.

This painting plan can be applied to normal ambient applications, slightly severe, protected or unprotected, for industrial applications, with low relative humidity, regular temperature variations and environments containing  $\text{SO}_2$ .

**Note: This painting plan is not recommended for direct exposure to acid steam, alkalis, solvents and salty environments.**

Optionally, other painting plans are available, which are suitable to guarantee additional protection aggressive environments, either protected or unprotected.

#### 7.2.1 Tropicalized painting

High humidity can result in premature insulation system deterioration which is the main component that ensures motor life time. Any ambient with up to 95% of relative humidity does not require additional protection, other than space heaters to avoid water condensation inside the motor. However, for any ambient with relative humidity above 95%, an epoxy painting is applied on all inside motor components which is known as tropicalized painting. If humidity is more than 95% it should be specified in the enquiry to ensure this tropicalized painting.

## 8. Ambient & Insulation

The rated output power given on the electrical tables, unless otherwise specified, refers to continuous duty operation S1, as per IEC 60034-1 and at following environments:

- With temperature varying between  $-20^{\circ}\text{C}$  to  $+40^{\circ}\text{C}$ ;
- With altitudes up to 1000 meters above sea level;
- With relative humidity up to 60% (above 60% we suggest to install space heaters to avoid accumulation of condensed water inside the motor).

For temperature and altitude different than those given above, figures of table 12 must be applied in order to find out the factor to be used to define the available useful output ( $P_{\text{max}}$ ).

$$P_{\text{max}} = P_{\text{nom}} \times \text{correction factor}$$

T (°C)	Altitude (m)								
	1000	1500	2000	2500	3000	3500	4000	4500	5000
20	1.00	1.00	1.00	1.00	1.00	1.00	0.97	0.92	0.88
25	1.00	1.00	1.00	1.00	1.00	0.98	0.94	0.90	0.86
30	1.00	1.00	1.00	1.00	1.00	0.95	0.91	0.87	0.83
35	1.00	1.00	1.00	1.00	0.95	0.93	0.89	0.85	0.81
40	1.00	1.00	1.00	0.96	0.92	0.90	0.86	0.82	0.78
45	1.00	1.00	0.95	0.93	0.90	0.88	0.84	0.80	0.75
50	1.00	0.97	0.94	0.90	0.86	0.82	0.80	0.76	0.71
55	0.95	0.92	0.90	0.88	0.85	0.81	0.78	0.74	0.69
60	0.92	0.90	0.87	0.85	0.82	0.80	0.77	0.72	0.67
65	0.88	0.85	0.83	0.81	0.78	0.76	0.73	0.70	0.65
70	0.83	0.82	0.80	0.77	0.75	0.73	0.70	0.67	0.62
75	0.79	0.76	0.74	0.72	0.70	0.68	0.66	0.62	0.58
80	0.74	0.71	0.69	0.67	0.66	0.64	0.62	0.58	0.53

Table 12 - Correction factors for altitude and ambient temperature

The W21 motors are supplied with class F insulation and Class B (80°C) temperature rise at normal operating conditions – ambient temperature of 40°C (unless otherwise specified).

The difference between the temperature of the class F insulation (105°C) and the temperature rise of the design (80°C) means that, in practice, W21 motors are suitable to supply output ratings up to 15% above the rated values, then reaching temperature rise value of the insulation class F.

All W21 motors are supplied with WISE® insulation system which consists of enamel wires meeting temperature of 200°C and impregnated with continuous solvent free resin flow. The WISE® insulation system allows motor operation with variable frequency drive (see section ahead).

## 9. Variable frequency drive application

### 9.1 Considerations about rated voltage

The stator of W21 motors is supplied with class F insulation and it is suitable for DOL starting or with variable frequency drive. Optionally, these motors can be supplied with class H insulation.

These motors are supplied with WEG exclusive insulation system - WISE® (WEG Insulation System Evolution) – which ensures superior electric insulation characteristics. They are suitable for variable frequency drive application, taking into account the limits shown in table 13.

Motor rated voltage	Peak voltage on motor terminals	dV/dt on motor terminals	Rise time	Time between
	(phase to phase)	(phase to phase)		
$V_n \leq 460\text{ V}$	$\leq 1600\text{ V}$	$\leq 5200\text{ V}/\mu\text{s}$	$\geq 0,1\ \mu\text{s}$	$\geq 6\ \mu\text{s}$
$460\text{ V} < V_n \leq 575\text{ V}$	$\leq 2000\text{ V}$	$\leq 6500\text{ V}/\mu\text{s}$		
$575\text{ V} < V_n \leq 690\text{ V}$	$\leq 2400\text{ V}$	$\leq 7800\text{ V}/\mu\text{s}$		

Table 13 - Limit conditions for variable frequency drive operation without application of filter

**Notes:**

- 1 - For the three cases above the maximum recommended switching frequency is limited at 5 kHz.
- 2 - If one of the above conditions is not followed accordingly (including the switching frequency), filter must be applied on frequency drive outlet.

### 9.2 Torque restrictions on variable frequency drive applications

Self-ventilated variable frequency drive motors have their torque limited at low frequencies due to ventilation reduction. Curves and derating tables must be applied to define the torque available.

#### Constant flux condition

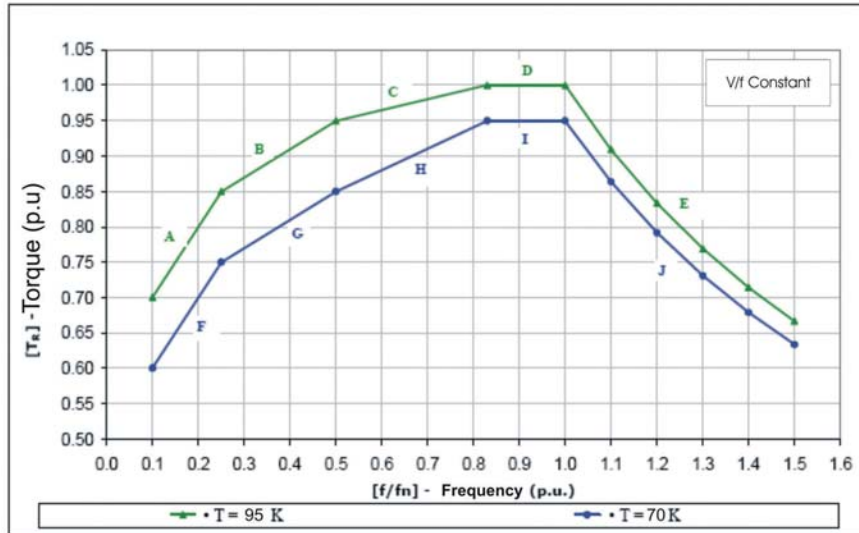

Figure 6 - Derating curve for constant flux

Derating for limit temperature rise for the insulation system thermal class*		
Interval	Limited by	Apply this equation
A	$0.10 \leq f/f_n < 0.25$	$TR = (f/f_n) + 0.60$
B	$0.25 \leq f/f_n < 0.50$	$TR = 0.40(f/f_n) + 0.75$
C	$0.50 \leq f/f_n < 0.83$	$TR = 0.15(f/f_n) + 0.87$
D	$0.83 \leq f/f_n \leq 1.0$	$TR = 1.0$
E	$f/f_n > 1.0$	$TR = 1/(f/f_n)$

Derating to keep temperature rise obtained with sinusoidal source**		
Interval	Limited by	Apply this equation
F	$0.10 \leq f/f_n < 0.25$	$TR = (f/f_n) + 0.50$
G	$0.25 \leq f/f_n < 0.50$	$TR = 0.40(f/f_n) + 0.65$
H	$0.50 \leq f/f_n < 0.83$	$TR = 0.15(f/f_n) + 0.70$
I	$0.83 \leq f/f_n \leq 1.0$	$TR = 0.95$
J	$f/f_n > 1.0$	$TR = 0.95/(f/f_n)$

Table 14 - Equation for torque definition at constant torque condition

(\*) When top curve is used (green color), motor temperature rise will be limited by the temperature class of the insulation material. For example, for class F insulation motors, the temperature rise will be limited at 105°C (for ambient temperature of 40°C). This curve can only be used for class F insulation and class B temperature rise motors in order to ensure that, when driven by frequency drive, the temperature rise remains class F (above 80°C and below 105°C).

(\*\*) When lower curve is used (blue color), the motor temperature rise of variable frequency drive will be the same driven by sinusoidal source. In other words, class F insulation motors with class B temperature rise will remain with class B temperature rise ( $\leq 80^\circ\text{C}$  for ambient temperature of 40°C) even when driven by variable frequency drive.

Note: The derating curves given in figure 6 are related to temperature on motor winding and with thermal class. These curves do not consider thermal tolerance factor of the motors. They are intended to show the torque limitations for variable frequency drive motors.

### 9.3 Restrictions about current flowing through the bearings

Motors up to frame IEC 280S/M do not require additional features for variable frequency drive application. From frame 315S/M additional measures must be taken to avoid current flowing through the bearings. The solution for this problem is to use insulated bearings or insulated hub endshields (usually non-drive endshield) and grounding brush, usually mounted on drive endshield.

WEG can supply a kit to modify motors that are not originally supplied with such protection.



### 9.4 Forced ventilation kit

For those cases that require independent cooling system, the W21 Motors can be supplied with a forced ventilation kit, as shown in figure 7.

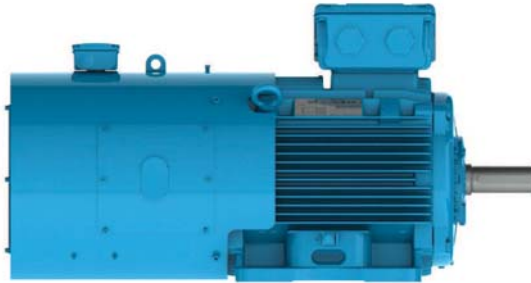

Figure 7 - Forced ventilation kit for W21 motors

When the forced ventilation kit is installed, the overall motor length is modified as shown in table 15.

Frame size	Number of poles	Total motor length (L)	
		Without forced ventilation	With forced ventilation
90S	All	304	548
90L	All	329	573
100	All	376	646
112	All	393	660
132S	All	452	715
132M	All	490	753
160M	All	598	855
160L	All	642	899
180M	All	664	908
180L	All	702	946
200M	All	729	976
200L	All	767	1014
225S/M	2	817	1146
	4-8	847	
250S/M	2	923	1222
	4-8		
280S/M	2	1036	1332
	4-8		
315S/M	2	1126	1452
	4-8	1156	

Table 15 - Motor length with and without the forced ventilation kit

## 10. Tolerances for electrical data

The following tolerance figures are allowed in accordance with IEC 60034-1:

Efficiency ( $\eta$ )	-0.15 (1- $\eta$ ) for $P_{nom} \leq 150$ kW -0.1 (1- $\eta$ ) for $P_{nom} > 150$ kW Where $\eta$ is a decimal number
Power factor	$\left( \frac{1 - \cos \Phi}{6} \right)$ Minimum 0.02 Maximum 0.07
Slip	$\pm 20\%$ for $P_{nom} \geq 1$ kW $\pm 30\%$ for $P_{nom} < 1$ kW
Starting current	+ 20% (without lower limit)
Starting torque	- 15% + 25%
Breakdown torque	- 10 %
Moment of inertia	$\pm 10$ %

# W21 - Cast Iron Motors

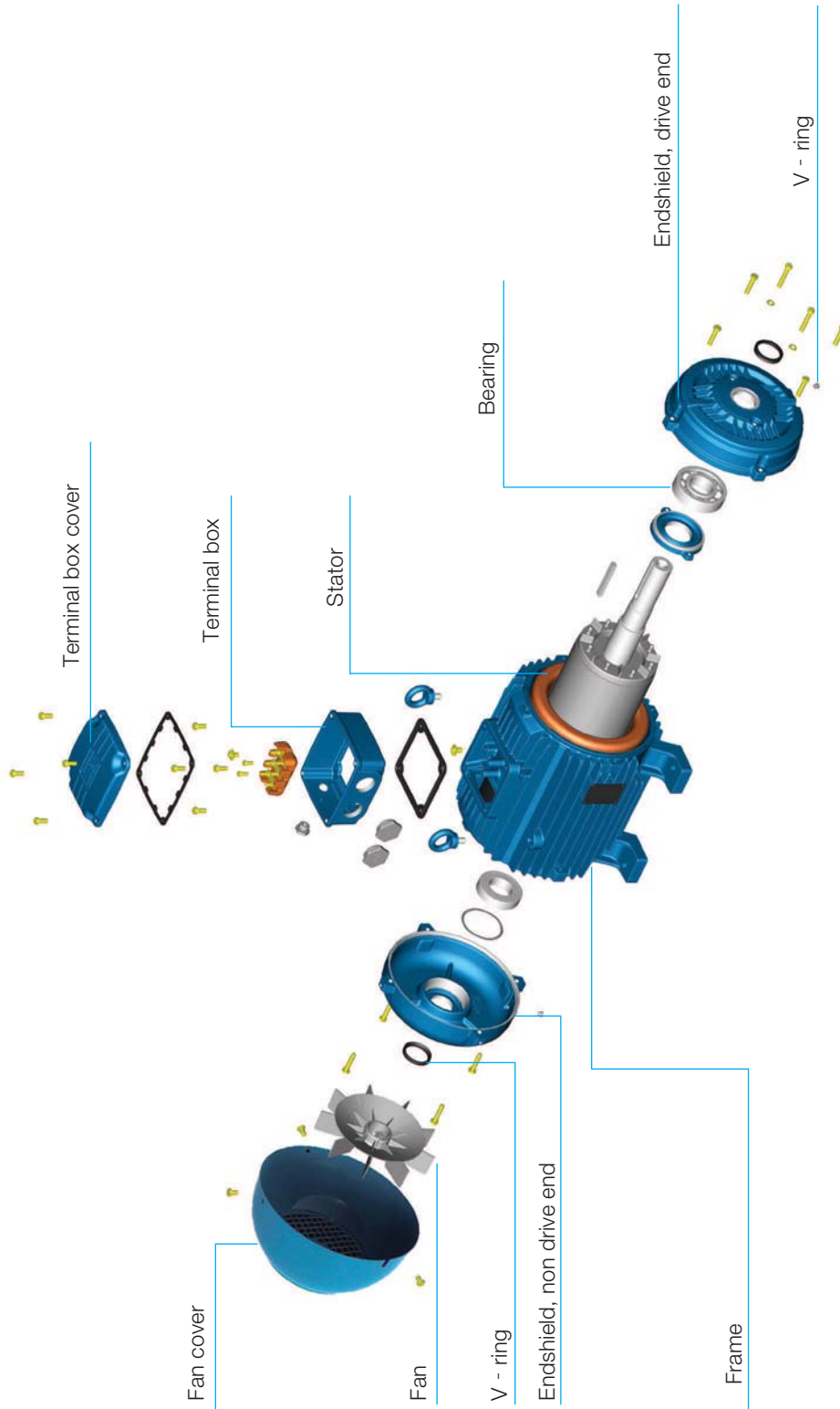

## Construction Features

Frame		80	90	100	112	132	160	180	200	
<b>Mechanical features</b>										
Frame	Material	FC-200 cast iron								
Degree of protection		IP55								
Grounding		Terminal box and the frame								
Cooling method		Totally enclosed fan cooled (IC411)								
Fan	Material	Polypropylene								
Fan Cover	Material	Steel plate								
Endshields	Material	FC-200 cast iron								
Drain hole		With automatic plastic drain plug								
Bearings	Type	Ball with ZZ clearance					Ball, DE C3, NDE Z-C3			
	Locking	Without bearing caps, with spring washer on NDE shield								
	D.E.	2P	6204	6205	6206	6307	6308	6309	6311	6312
		4-8P								
N.D.E.	2P	6203	6204	6205	6206	6207	6209	6211	6212	
	4-8P									
Bearing seal		V'Ring								
Lubrication	Type of grease	Polirex® EM 103 (Exxon Mobil)								
		With bearing lubricated for life								
Terminal box	Type	Of flat lid, supplied with BMC terminal block								
	Material	FC-200 cast iron								
Additional terminal box		Mandatory when accessories are supplied (space heater, thermal protection) - with hole M20 x 1.5								
Cables entry	Size	2 x M20 x 1.5	2 x M25 x 1.5	2 x M32 x 1.5	2 x M40 x 1.5	2 x M50x 1.5				
	Plug	With flat plastic plug for transportation and storage, cable gland as optional								
Shaft	Material		AISI 1040/45							
	Threaded hole	2P	M6	M8	M10	M12	M16	M20		
		4-8P								
Key		Supplied with type A open key								
Vibration		Grade A								
Balance		With half key								
Nameplate	Material	AISI 304 stainless steel								
Painting	Type	207A				203A				
		Prime: one with 20 to 55 µm of alkyd primer Finishing: one coat with 40to 60 µm of alkyd synthetic enamel								
	Color	RAL 5009								
<b>Electrical features</b>										
Voltage		220-240/380-415V//440-460V								
Design		N								
Winding	Material	Copper or Aluminum								
	Insulation	WISE® (WEG Insulation System Evolution), Class F insulation								
	Impregnation	Dip and bake solvent-free resin								
Service factor		1.0								
Rotor		Aluminium die cast								
Space heaters		Every time the output power is equal or above 30 Kw								

## Construction Features

Frame		225S/M	250S/M	280S/M	315S/M	315B	355M/L
<b>Mechanical features</b>							
Frame	Material	FC-200 cast iron					
Degree of protection		IP55					
Grounding		Terminal box and the frame					
Cooling method		Totally enclosed fan cooled (IC411)					
Fan	Material	Polypropylene			Aluminium		
Fan Cover	Material	Steel plate					
Endshields	Material	FC-200 cast iron					
Drain hole		With automatic plastic drain plug					
Bearings	Type	Ball with C3 clearance					
	Locking	Locked on DE with internal and external bearing caps and pre-load springs on NDE					
	D.E.	2P	6314	6314	6314	6316	
		4-8P		6316	6319	6322	
	N.D.E.	2P		6314	6314	6314	
4-8P		6316		6316	6319		
Bearing seal		V'Ring					
Lubrication	Type of grease	Polirex® EM 103 (Exxon Mobil)					
		With grease fitting					
Terminal box	Type	Of flat lid, supplied with BMC terminal block					
	Material	FC-200 cast iron					
Additional terminal box		Mandatory when accessories are supplied (space heater, thermal protection) - with hole M20 x 1.5					
Cables entry	Size	2 x M50x 1.5	2 x M63x 1.5		2 x M63x 1.5 (removable base)		
	Plug	With flat plastic plug for transportation and storage, cable gland as optional					
Shaft	Material	AISI 1040/45			AISI 4140		
	Threaded hole	2P	M20			M20	
		4-8P				M24	
Key		Supplied with B type key					
Vibration		Grade A					
Balance		With half key					
Nameplate	Material	AISI 304 stainless steel					
Painting	Type	203A					
		Prime: one with 20 to 55 µm of alkyd primer Finishing: one coat with 40 to 60 µm of alkyd synthetic enamel					
	Color	RAL 5009					
<b>Electrical features</b>							
Voltage		220-240/380-415V//440-460V					
Design		N					
Winding	Material	Copper					
	Insulation	WISE® (WEG Insulation System Evolution), Class F insulation					
	Impregnation	Continuous flow of solvent-free resin					
Service factor		1					
Rotor		Aluminium die cast					
Space heaters		Every time the output power is equal or above 30 Kw					

# W21 Cast Iron Frame IE1

Output		Frame	Full Load Torque (kgfm)	Locked Rotor Current I <sub>L</sub> /I <sub>n</sub>	Locked Rotor Torque T <sub>L</sub> /T <sub>n</sub>	Break-down Torque T <sub>b</sub> /T <sub>n</sub>	Inertia J (kgm <sup>2</sup> )	Allowable locked rotor time (s)		Weight (kg)	Sound dB(A)	400 V						Full load current I <sub>n</sub> (A)	
								Rated speed (rpm)	% of full load			Power Factor							
									Efficiency			Power Factor	50		75	100			
kW	HP							Hot	Cold										
2P-3000rpm-50HZ																			
0.75	1	80	0.260	5.0	2.4	2.4	0.0006	9	20	10.0	59.0	2770	66.0	72.0	72.5	0.59	0.73	0.82	1.82
1.1	1.5	80	0.390	5.0	2.6	2.6	0.0008	7	15	11.5	59.0	2770	73.0	75.0	75.5	0.60	0.75	0.83	2.53
1.5	2	90S	0.510	6.3	2.7	2.6	0.0017	7	15	15.0	64.0	2840	75.0	78.0	78.0	0.63	0.76	0.83	3.28
2.2	3	90L	0.760	6.8	2.8	2.9	0.0022	9	20	16.7	64.0	2810	77.0	78.0	80.0	0.63	0.77	0.85	4.58
3	4	100L	1.02	6.7	2.3	2.8	0.0052	9	20	23.5	67.0	2870	80.0	81.0	82.0	0.69	0.81	0.87	5.96
4	5.5	112M	1.36	6.8	2.4	3.0	0.0073	9	20	31.0	64.0	2875	81.0	83.0	84.0	0.71	0.82	0.87	7.81
5.5	7.5	132S	1.84	6.5	2.4	3.0	0.0159	11	24	42.0	68.0	2910	83.0	85.0	85.5	0.71	0.81	0.87	10.5
7.5	10	132S	2.52	6.4	2.3	2.6	0.0187	11	24	53.0	68.0	2900	85.0	86.5	86.5	0.72	0.82	0.87	14.2
9.2	12.5	132M	3.08	7.5	2.7	3.1	0.0243	8	18	58.0	68.0	2910	86.0	87.0	87.0	0.70	0.81	0.86	17.4
11	15	160M	3.64	7.5	2.0	3.0	0.0353	11	24	97.0	70.0	2945	86.5	87.5	88.0	0.70	0.81	0.86	21.0
15	20	160M	4.96	7.4	2.2	3.1	0.0471	9	20	109	70.0	2945	87.0	88.5	89.0	0.69	0.80	0.86	28.3
18.5	25	160L	6.14	8.0	2.5	3.2	0.0559	7	15	122	70.0	2935	88.0	89.5	89.5	0.67	0.78	0.86	34.2
22	30	180M	7.25	8.7	2.5	3.5	0.0965	7	15	172	70.0	2955	89.5	90.5	90.5	0.74	0.83	0.87	40.3
30	40	200L	9.87	7.3	2.6	2.9	0.1794	13	29	229	74.0	2960	89.0	90.0	91.0	0.70	0.80	0.85	56.0
37	50	200L	12.2	7.0	2.6	2.8	0.2063	12	26	245	74.0	2960	90.0	91.0	91.5	0.71	0.80	0.86	67.9
45	60	225S/M	14.8	7.0	2.8	3.1	0.3139	16	35	356	82.0	2960	90.0	91.0	92.0	0.76	0.85	0.88	80.2
55	75	250S/M	18.1	7.5	2.5	3.3	0.3767	15	33	410	82.0	2965	91.0	91.5	92.5	0.77	0.85	0.88	97.5
75	100	280S/M	24.5	8.0	2.4	3.2	1.08	22	48	663	83.0	2980	91.0	92.8	93.0	0.76	0.85	0.88	131
90	125	280S/M	29.4	8.0	2.4	3.2	1.18	19	42	675	83.0	2980	91.0	93.0	93.5	0.78	0.85	0.88	157
110	150	315S/M	36.0	7.7	2.4	3.0	1.41	21	46	810	84.0	2975	92.5	93.7	93.8	0.78	0.85	0.88	191
132	175	315S/M	43.2	7.5	2.4	3.0	1.65	18	40	870	84.0	2975	93.2	94.0	94.0	0.80	0.87	0.89	226
150	200	315S/M	49.1	8.4	2.6	3.0	1.88	17	37	930	84.0	2975	93.8	94.0	94.2	0.80	0.87	0.89	256
160	220	315S/M	52.4	7.5	2.6	3.1	2.12	17	37	1010	84.0	2975	93.8	94.0	94.2	0.83	0.88	0.90	270
185	250	315S/M	60.5	8.2	2.4	3.5	1.96	28	62	1010	84.0	2980	94.5	94.7	94.7	0.80	0.86	0.88	320
200	270	355M/L	65.3	7.2	1.8	2.6	4.56	70	154	1490	81.0	2985	93.0	94.6	94.9	0.89	0.91	0.92	329
220	300	355M/L	71.8	8.5	2.2	3.0	4.88	65	143	1650	81.0	2985	93.8	94.9	94.9	0.88	0.91	0.92	360
250	340	355M/L	81.6	7.8	2.2	2.5	5.39	65	143	1750	81.0	2985	93.8	94.9	94.9	0.88	0.91	0.92	409
280	380	355M/L	91.4	8.5	2.3	2.7	5.90	25	55	1850	81.0	2985	94.8	95.0	95.0	0.89	0.91	0.92	462
300	400	355M/L	97.9	7.8	2.0	2.6	5.90	40	88	1850	83.0	2985	95.1	95.4	95.4	0.85	0.90	0.90	504
315	430	355M/L	103	7.6	2.1	2.6	5.90	40	88	1850	83.0	2980	95.1	95.4	95.4	0.86	0.90	0.91	524
330	450	355M/L*	108	7.8	2.0	2.5	5.90	40	88	1850	83.0	2980	95.1	95.4	95.4	0.87	0.90	0.91	549
High-Output Design																			
0.55	0.75	80	0.190	6.5	3.0	3.2	0.0007	20	44	13.0	59.0	2805	73.0	76.5	77.0	0.72	0.81	0.86	1.20
1.1	1.5	90S	0.380	6.3	2.7	2.6	0.0012	7	15	15.0	64.0	2840	77.0	79.5	79.5	0.63	0.76	0.83	2.41
1.5	2	80	0.530	6.0	3.0	2.7	0.0009	10	22	15.5	59.0	2770	76.0	77.0	77.5	0.70	0.82	0.87	3.20
1.5	2	90L	0.510	6.3	2.7	2.6	0.0017	7	15	15.0	64.0	2840	75.0	78.0	78.0	0.63	0.76	0.83	3.28
2.2	3	100L	0.750	6.9	2.3	2.8	0.0051	9	20	23.5	67.0	2870	79.0	80.0	81.0	0.72	0.83	0.88	4.32
3	4	112M	1.01	7.6	2.6	3.4	0.0070	20	44	39.0	64.0	2905	82.0	84.0	84.0	0.75	0.83	0.88	5.74
3	4	90L*	1.03	6.2	3.2	3.1	0.0025	6	13	23.5	64.0	2830	80.0	81.0	81.5	0.55	0.68	0.78	6.77
4	5.5	100L	1.36	7.5	2.9	3.1	0.0065	7	15	33.0	67.0	2870	79.0	81.0	83.1	0.72	0.81	0.86	8.14
4	5.5	132S	1.34	6.5	2.3	2.8	0.0135	13	29	61.0	68.0	2910	81.5	84.0	85.0	0.67	0.78	0.85	7.99
5.5	7.5	112M	1.87	7.7	2.5	3.0	0.0096	10	22	40.0	64.0	2870	85.0	85.0	85.5	0.79	0.86	0.89	10.1
7.5	10	112M*	2.55	7.6	3.0	3.0	0.0094	6	13	45.0	64.0	2870	85.5	86.0	86.5	0.59	0.72	0.81	15.3
7.5	10	132M	2.52	6.4	2.3	2.6	0.0187	11	24	53.0	68.0	2900	85.0	86.5	86.5	0.72	0.82	0.87	14.2
9.2	12.5	160M	3.05	7.2	2.2	3.0	0.0353	15	33	97.0	70.0	2935	85.0	88.0	88.8	0.71	0.82	0.86	17.4
11	15	132M	3.67	8.0	2.7	3.2	0.0280	8	18	74.0	68.0	2920	87.0	88.0	88.0	0.71	0.81	0.86	20.6
15	20	160L	4.96	7.4	2.2	3.1	0.0471	9	20	109	70.0	2945	87.0	88.5	89.0	0.69	0.80	0.86	28.3
22	30	160L*	7.31	7.5	2.5	3	0.0639	6	13	132	70.0	2930	89.0	89.5	90.0	0.72	0.82	0.86	40.7
45	60	250S/M	14.8	7.0	2.8	3.1	0.3139	16	35	356	82.0	2960	90.0	91.0	92.0	0.76	0.85	0.88	80.2
55	75	225S/M	18.1	7.5	2.5	3.3	0.3767	15	33	410	82.0	2965	91.0	91.5	92.5	0.77	0.85	0.88	97.5
55	75	280S/M	18.0	7.7	2.3	3.0	1.08	22	48	663	83.0	2975	91.6	93.4	93.9	0.77	0.85	0.88	96.1
75	100	250S/M	24.6	8.3	2.6	3.0	0.5023	10	22	469	82.0	2965	92.0	92.5	92.8	0.79	0.85	0.88	131
110	150	280S/M	36.0	7.7	2.4	3.0	1.41	21	46	810	83.0	2975	92.5	93.7	93.8	0.78	0.85	0.88	191
132	175	280S/M	43.2	7.5	2.4	3.0	1.65	18	40	870	83.0	2975	93.2	94.0	94.0	0.80	0.87	0.89	226
185	250	355M/L	60.5	7.0	1.8	2.0	4.02	70	154	1430	81.0	2980	92.0	93.5	94.0	0.85	0.90	0.92	307





# W21 Cast Iron Frame IE1

Output		380 V									415 V								
		Rated speed (rpm)	% of full load						Full load current In (A)	Rated speed (rpm)	% of full load						Full load current In (A)		
			Efficiency			Power Factor					Efficiency			Power Factor					
kW	HP	50	75	100	50	75	100	50	75	100	50	75	100	50	75	100			
2P-3000rpm-50HZ																			
0.75	1	2740	69.0	73.0	72.5	0.67	0.79	0.86	1.83	2790	63.0	70.5	72.5	0.51	0.67	0.78	1.85		
1.1	1.5	2745	74.0	75.0	75.5	0.68	0.81	0.87	2.54	2790	71.0	74.5	75.5	0.54	0.70	0.80	2.53		
1.5	2	2820	76.0	78.0	78.0	0.70	0.81	0.87	3.32	2855	74.0	78.0	78.0	0.57	0.71	0.80	3.29		
2.2	3	2790	77.0	78.0	80.0	0.70	0.82	0.88	4.70	2820	77.0	78.0	80.0	0.57	0.72	0.82	4.58		
3	4	2855	80.0	81.0	81.5	0.75	0.85	0.89	6.17	2880	80.0	81.0	82.0	0.64	0.77	0.84	5.95		
4	5.5	2860	82.0	83.0	83.5	0.77	0.86	0.89	8.08	2885	80.0	82.5	84.0	0.66	0.78	0.85	7.72		
5.5	7.5	2895	83.0	85.0	85.0	0.77	0.85	0.89	10.9	2915	82.0	84.5	85.5	0.66	0.78	0.84	10.5		
7.5	10	2890	85.0	86.0	86.0	0.78	0.86	0.89	14.7	2910	84.0	86.5	86.5	0.66	0.78	0.84	14.2		
9.2	12.5	2900	86.0	87.0	87.0	0.76	0.85	0.89	17.8	2915	85.0	87.0	87.0	0.63	0.76	0.83	17.4		
11	15	2930	86.5	87.5	88.0	0.76	0.84	0.87	21.8	2950	85.0	86.5	88.0	0.67	0.78	0.84	20.7		
15	20	2935	87.0	88.5	89.0	0.74	0.83	0.87	29.4	2950	86.5	88.0	89.0	0.64	0.76	0.83	28.2		
18.5	25	2930	88.5	89.5	89.5	0.74	0.83	0.87	35.7	2940	87.0	89.5	89.5	0.63	0.75	0.82	34.7		
22	30	2945	90.0	90.5	90.5	0.78	0.85	0.88	42.0	2950	89.0	90.0	90.5	0.70	0.80	0.85	39.8		
30	40	2955	89.0	90.0	91.0	0.76	0.84	0.87	57.6	2965	89.0	90.0	91.0	0.64	0.76	0.82	55.9		
37	50	2950	90.0	91.0	91.5	0.76	0.84	0.87	70.6	2960	88.0	91.0	91.5	0.66	0.77	0.83	67.8		
45	60	2955	90.0	91.0	92.0	0.77	0.86	0.89	83.5	2965	90.0	91.5	92.0	0.74	0.84	0.87	78.2		
55	75	2960	91.0	91.5	92.5	0.79	0.86	0.89	102	2965	91.0	92.5	92.5	0.73	0.83	0.86	96.2		
75	100	2980	91.0	92.8	93.0	0.79	0.86	0.89	136	2980	90.5	92.7	93.0	0.74	0.83	0.87	128		
90	125	2975	92.0	93.0	93.5	0.80	0.87	0.89	163	2980	91.0	93.0	93.5	0.75	0.83	0.87	153		
110	150	2975	92.7	93.7	93.8	0.81	0.86	0.89	199	2980	92.4	93.7	93.8	0.76	0.84	0.87	186		
132	175	2975	93.5	94.0	94.0	0.83	0.88	0.90	235	2980	93.1	94.0	94.0	0.79	0.86	0.88	220		
150	200	2975	93.8	94.0	94.2	0.82	0.88	0.90	267	2980	93.6	94.0	94.2	0.78	0.86	0.89	247		
160	220	2970	93.8	94.0	94.2	0.84	0.89	0.90	284	2975	93.6	94.0	94.2	0.81	0.87	0.89	263		
185	250	2975	94.5	94.7	94.7	0.82	0.87	0.89	333	2980	94.5	94.7	94.7	0.78	0.84	0.87	312		
200	270	2980	93.0	94.7	94.9	0.90	0.92	0.92	347	2985	93.0	94.5	94.9	0.88	0.90	0.91	321		
220	300	2985	94.0	94.9	94.9	0.89	0.92	0.93	375	2990	93.5	94.9	94.9	0.86	0.90	0.92	347		
250	340	2980	94.0	94.9	94.9	0.90	0.92	0.93	425	2985	93.5	94.9	94.9	0.87	0.91	0.92	393		
280	380	2980	94.5	94.8	94.8	0.90	0.92	0.92	488	2985	94.8	95.1	95.1	0.88	0.90	0.92	445		
300	400	2980	95.2	95.4	95.4	0.87	0.90	0.91	525	2985	95.0	95.4	95.5	0.84	0.89	0.89	491		
315	430	2980	95.2	95.4	95.4	0.88	0.91	0.92	545	2985	95.0	95.4	95.5	0.84	0.89	0.90	510		
330	450	2980	95.2	95.4	95.4	0.88	0.91	0.92	571	2980	95.0	95.4	95.5	0.85	0.90	0.91	528		
High-Output Design																			
0.55	0.75	2785	74.0	76.0	76.0	0.75	0.83	0.88	1.25	2820	71.5	76.0	77.0	0.69	0.79	0.84	1.18		
1.1	1.5	2820	78.0	80.1	78.9	0.70	0.81	0.87	2.43	2855	75.0	78.9	79.3	0.57	0.71	0.80	2.41		
1.5	2	2750	76.0	77.0	77.5	0.75	0.85	0.89	3.35	2790	75.0	77.0	77.5	0.65	0.78	0.85	3.13		
1.5	2	2820	76.0	78.0	78.0	0.70	0.81	0.87	3.32	2855	74.0	78.0	78.0	0.57	0.71	0.80	3.29		
2.2	3	2855	79.0	80.0	81.0	0.78	0.87	0.90	4.47	2880	79.0	80.0	81.0	0.67	0.79	0.85	4.31		
3	4	2890	82.0	84.0	84.0	0.79	0.86	0.89	6.00	2910	82.0	84.0	84.0	0.71	0.82	0.87	5.60		
3	4	2800	80.0	81.0	81.5	0.61	0.74	0.81	6.90	2845	79.0	81.0	81.5	0.50	0.64	0.74	6.92		
4	5.5	2850	80.0	81.0	83.1	0.77	0.84	0.88	8.42	2890	79.0	82.0	83.1	0.68	0.78	0.84	8.03		
4	5.5	2900	82.5	84.0	84.8	0.73	0.83	0.87	8.24	2920	81.0	84.0	85.0	0.63	0.75	0.82	7.98		
5.5	7.5	2860	85.0	85.0	85.5	0.82	0.88	0.90	10.5	2880	85.0	85.5	86.0	0.76	0.84	0.88	9.80		
7.5	10	2850	85.5	86.0	86.0	0.66	0.79	0.85	15.4	2885	85.0	86.0	86.5	0.53	0.67	0.76	15.8		
7.5	10	2890	85.0	86.0	86.0	0.78	0.86	0.89	14.7	2910	84.0	86.5	86.5	0.66	0.78	0.84	14.2		
9.2	12.5	2925	85.7	87.8	88.0	0.77	0.85	0.88	18.1	2940	84.6	87.5	88.5	0.67	0.78	0.84	17.2		
11	15	2910	87.0	88.0	88.0	0.76	0.84	0.88	21.3	2930	86.5	88.0	88.0	0.66	0.77	0.83	20.6		
15	20	2935	87.0	88.5	89.0	0.74	0.83	0.87	29.4	2950	86.5	88.0	89.0	0.64	0.76	0.83	28.2		
22	30	2925	89.0	89.5	90.0	0.77	0.85	0.88	42.0	2935	88.5	89.5	90.0	0.68	0.79	0.84	40.2		
45	60	2955	90.0	91.0	92.0	0.77	0.86	0.89	83.5	2965	90.0	91.5	92.0	0.74	0.84	0.87	78.2		
55	75	2960	91.0	91.5	92.5	0.79	0.86	0.89	102	2965	91.0	92.5	92.5	0.73	0.83	0.86	96.2		
55	75	2975	91.8	93.4	93.9	0.79	0.86	0.89	100	2980	91.4	93.3	93.8	0.75	0.83	0.87	93.8		
75	100	2960	90.0	92.5	92.8	0.82	0.87	0.89	137	2970	92.0	92.5	92.8	0.75	0.83	0.87	128		
110	150	2975	92.7	93.7	93.8	0.81	0.86	0.89	199	2980	92.4	93.7	93.8	0.76	0.84	0.87	186		
132	175	2975	93.5	94.0	94.0	0.83	0.88	0.90	235	2980	93.1	94.0	94.0	0.79	0.86	0.88	220		
185	250	2975	92.0	93.5	94.0	0.86	0.91	0.92	325	2980	92.0	93.5	94.0	0.83	0.88	0.91	299		

# W21 Cast Iron Frame IE1

Output		Frame	Full Load Torque (kgfm)	Locked Rotor Current I <sub>L</sub> /I <sub>n</sub>	Locked Rotor Torque T <sub>L</sub> /T <sub>n</sub>	Break-down Torque T <sub>b</sub> /T <sub>n</sub>	Inertia J (kgm <sup>2</sup> )	Allowable locked rotor time (s)		Weight (kg)	Sound dB(A)	460 V 60Hz						Full load current I <sub>n</sub> (A)	
								Hot	Cold			% of full load			Power Factor				
												Rated speed (rpm)	50	75	100	50	75		100
kW	HP																		
2P-3000rpm-60HZ																			
0.75	1	80	0.260	5.0	2.4	2.4	0.0006	9	20	10.0	59.0	3405	65.0	70.0	72.5	0.57	0.70	0.79	1.64
1.1	1.5	80	0.390	5.0	2.6	2.6	0.0008	7	15	11.5	59.0	3410	71.3	75.0	76.3	0.60	0.72	0.81	2.23
1.5	2	90S	0.510	6.3	2.7	2.6	0.0017	7	15	15.0	64.0	3465	74.5	77.9	79.0	0.63	0.75	0.82	2.91
2.2	3	90L	0.760	6.8	2.8	2.9	0.0022	9	20	16.7	64.0	3430	75.6	78.8	80.6	0.63	0.75	0.83	4.13
3	4	100L	1.02	6.7	2.3	2.8	0.0052	9	20	23.5	67.0	3490	78.0	81.0	82.2	0.69	0.81	0.86	5.33
4	5.5	112M	1.36	6.8	2.4	3.0	0.0073	9	20	31.0	64.0	3490	79.2	82.3	83.6	0.70	0.82	0.87	6.90
5.5	7.5	132S	1.84	6.5	2.4	3.0	0.0159	11	24	42.0	68.0	3520	81.1	84.1	85.3	0.70	0.82	0.87	9.30
7.5	10	132S	2.52	6.4	2.3	2.6	0.0187	11	24	53.0	68.0	3515	84.4	86.5	87.0	0.71	0.82	0.87	12.4
9.2	12.5	132M	3.08	7.5	2.7	3.1	0.0243	8	18	58.0	68.0	3525	84.1	86.5	87.3	0.70	0.81	0.86	15.4
11	15	160M	3.64	7.5	2.0	3.0	0.0353	11	24	97.0	70.0	3545	84.4	86.7	87.7	0.70	0.81	0.85	18.5
15	20	160M	4.96	7.4	2.2	3.1	0.0471	9	20	109	70.0	3545	86.9	88.6	89.1	0.69	0.80	0.85	24.9
18.5	25	160L	6.14	8.0	2.5	3.2	0.0559	7	15	122	70.0	3545	87.4	89.4	90.0	0.68	0.79	0.84	30.7
22	30	180M	7.25	8.7	2.5	3.5	0.0965	7	15	172	70.0	3555	88.3	80.5	90.5	0.71	0.81	0.86	35.5
30	40	200L	9.87	7.3	2.6	2.9	0.1794	13	29	229	74.0	3565	88.0	90.2	91.1	0.69	0.80	0.85	48.6
37	50	200L	12.2	7.0	2.6	2.8	0.2063	12	26	245	74.0	3560	89.3	90.8	91.4	0.71	0.80	0.85	59.8
45	60	225S/M	14.8	7.0	2.8	3.1	0.3139	16	35	356	82.0	3565	89.1	91.0	91.8	0.75	0.86	0.89	69.1
55	75	250S/M	18.1	7.5	2.5	3.3	0.3767	15	33	410	82.0	3570	89.8	91.6	92.3	0.76	0.85	0.89	84.0
75	100	280S/M	24.5	8.0	2.4	3.2	1.08	22	48	663	83.0	3580	90.0	91.9	92.7	0.74	0.84	0.87	117
90	125	280S/M	29.4	8.0	2.4	3.2	1.18	19	42	675	83.0	3580	90.3	92.3	93.2	0.74	0.84	0.88	138
110	150	315S/M	36.0	7.7	2.4	3.0	1.41	21	46	810	84.0	3575	91.4	93.0	93.6	0.75	0.85	0.88	168
132	175	315S/M	43.2	7.5	2.4	3.0	1.65	18	40	870	84.0	3575	92.4	93.6	94.0	0.78	0.86	0.89	198
150	200	315S/M	49.1	8.4	2.6	3.0	1.88	17	37	930	84.0	3575	93.1	94.0	94.2	0.77	0.86	0.89	225
160	220	315S/M	52.4	7.5	2.6	3.1	2.12	17	37	1010	84.0	3580	93.0	94.0	94.2	0.80	0.88	0.90	237
185	250	315S/M	60.5	8.2	2.4	3.5	1.96	28	62	1010	84.0	3580	93.8	94.8	94.8	0.75	0.84	0.87	282
200	270	355M/L	65.3	7.2	1.8	2.6	4.56	70	154	1490	81.0	3580	92.0	93.6	94.4	0.86	0.91	0.91	292
220	300	355M/L	71.8	8.5	2.2	3.0	4.88	65	143	1650	81.0	3585	93.0	94.4	94.9	0.84	0.90	0.92	316
250	340	355M/L	81.6	7.8	2.2	2.5	5.39	65	143	1750	81.0	3580	93.2	94.3	94.8	0.85	0.91	0.92	360
280	380	355M/L	91.4	8.5	2.3	2.7	5.90	25	55	1850	81.0	3585	94.2	94.9	95.0	0.86	0.91	0.92	402
300	400	355M/L	97.9	7.8	2.0	2.6	5.90	40	88	1850	83.0	3585	94.6	95.2	95.4	0.84	0.89	0.91	434
315	430	355M/L	103	7.6	2.1	2.6	5.90	40	88	1850	83.0	3585	94.6	95.2	95.4	0.85	0.90	0.91	455
330	450	355M/L*	108	7.8	2.0	2.5	5.90	40	88	1850	83.0	3585	94.6	95.2	95.4	0.86	0.90	0.91	477
High-Output Design																			
0.55	0.75	80	0.190	6.5	3.0	3.2	0.0007	20	44	13.0	59.0	3435	71.7	75.6	76.9	0.68	0.79	0.84	1.07
1.1	1.5	90S	0.380	6.3	2.7	2.6	0.0012	7	15	15.0	64.0	3460	75.3	79.4	80.3	0.62	0.77	0.83	2.07
1.5	2	80	0.530	6.0	3.0	2.7	0.0009	10	22	15.5	59.0	3410	74.1	76.7	77.7	0.67	0.78	0.85	2.85
1.5	2	90L	0.510	6.3	2.7	2.6	0.0017	7	15	15.0	64.0	3465	74.5	77.9	79.0	0.63	0.75	0.82	2.91
2.2	3	100L	0.750	6.9	2.3	2.8	0.0051	9	20	23.5	67.0	3485	78.0	80.6	81.4	0.73	0.83	0.88	3.86
3	4	112M	1.01	7.6	2.6	3.4	0.0070	20	44	39.0	64.0	3515	80.4	83.4	84.1	0.73	0.82	0.87	5.15
3	4	90L*	1.03	6.2	3.2	3.1	0.0025	6	13	23.5	64.0	3445	78.1	80.8	81.5	0.53	0.66	0.74	6.24
4	5.5	100L	1.36	7.5	2.9	3.1	0.0065	7	15	33.0	67.0	3490	78.5	81.6	82.7	0.68	0.78	0.84	7.23
4	5.5	132S	1.34	6.5	2.3	2.8	0.0135	13	29	61.0	68.0	3520	79.9	83.6	85.1	0.67	0.79	0.85	6.94
5.5	7.5	112M	1.87	7.7	2.5	3.0	0.0096	10	22	40.0	64.0	3490	84.1	85.9	86.1	0.76	0.85	0.88	9.01
7.5	10	112M*	2.55	7.6	3.0	3.0	0.0094	6	13	45.0	64.0	3485	84.0	86.2	86.6	0.59	0.72	0.80	13.6
7.5	10	132M	2.52	6.4	2.3	2.6	0.0187	11	24	53.0	68.0	3515	84.4	86.5	87.0	0.71	0.82	0.87	12.4
9.2	12.5	160M	3.05	7.2	2.2	3.0	0.0353	15	33	97.0	70.0	3540	83.0	85.8	87.3	0.70	0.81	0.86	15.4
11	15	132M	3.67	8.0	2.7	3.2	0.0280	8	18	74.0	68.0	3525	85.5	87.7	88.7	0.70	0.80	0.85	18.3
15	20	160L	4.96	7.4	2.2	3.1	0.0471	9	20	109	70.0	3545	86.9	88.6	89.1	0.69	0.80	0.85	24.9
22	30	160L*	7.31	7.5	2.5	3.0	0.0639	6	13	132	70.0	3540	87.9	89.6	90.0	0.69	0.80	0.85	36.1
45	60	250S/M	14.8	7.0	2.8	3.1	0.3139	16	35	356	82.0	3565	89.1	91.0	91.8	0.75	0.86	0.89	69.1
55	75	225S/M	18.1	7.5	2.5	3.3	0.3767	15	33	410	82.0	3570	89.8	91.6	92.3	0.76	0.85	0.89	84.0
55	75	280S/M	18.0	7.7	2.3	3.0	1.08	22	48	663	83.0	3575	89.8	92.0	93.2	0.74	0.83	0.87	85.1
75	100	250S/M	24.6	8.3	2.6	3.0	0.5023	10	22	469	82.0	3570	91.0	92.3	92.7	0.77	0.85	0.88	115
110	150	280S/M	36.0	7.7	2.4	3.0	1.41	21	46	810	83.0	3575	91.4	93.0	93.6	0.75	0.85	0.88	168
132	175	280S/M	43.2	7.5	2.4	3.0	1.65	18	40	870	83.0	3575	92.4	93.6	94.0	0.78	0.86	0.89	198
185	250	355M/L	60.5	7.0	1.8	2.0	4.02	70	154	1430	81.0	3580	91.1	93.1	93.8	0.81	0.89	0.92	269



# W21 Cast Iron Frame IE1

Output		Frame	Full Load Torque (kgfm)	Locked Rotor Current I/In	Locked Rotor Torque Tl/Tn	Break-down Torque Tb/Tn	Inertia J (kgm²)	Allowable locked rotor time (s)		Weight (kg)	Sound dB(A)	400 V								
												Plated speed (rpm)	% of full load						Full load current In (A)	
													Efficiency			Power Factor				
kW	HP							Hot	Cold			50	75	100	50	75	100			
4P-1500rpm-50HZ																				
0.55	0.75	80	0.380	4.7	2.1	2.2	0.0019	17	37	10.0	44.0	1410	58.5	66.3	70.0	0.54	0.70	0.82	1.38	
0.75	1	80	0.520	5.0	2.3	2.2	0.0023	14	31	11.0	44.0	1395	63.5	71.0	72.1	0.55	0.70	0.81	1.86	
1.1	1.5	90S	0.770	5.6	2.3	2.4	0.0039	8	18	14.5	49.0	1400	70.0	75.0	75.5	0.55	0.69	0.79	2.66	
1.5	2	90L	1.05	5.5	2.3	2.4	0.0048	8	18	17.0	49.0	1390	76.5	78.5	79.0	0.58	0.73	0.82	3.34	
2.2	3	100L	1.52	5.6	2.4	2.6	0.0065	9	20	23.0	53.0	1410	79.0	80.0	80.0	0.60	0.74	0.82	4.84	
3	4	100L	2.06	6.0	2.8	3.0	0.0084	8	18	30.0	53.0	1420	79.0	80.0	81.5	0.57	0.72	0.81	6.47	
4	5.5	112M	2.71	7.0	2.1	2.5	0.0147	13	29	33.0	56.0	1440	82.0	83.1	83.5	0.65	0.77	0.83	8.33	
5.5	7.5	132S	3.69	6.5	2.1	2.5	0.0349	11	24	47.0	60.0	1450	83.5	84.5	85.0	0.63	0.77	0.84	11.0	
7.5	10	132M	5.02	6.7	1.9	2.8	0.0465	8	18	64.5	60.0	1455	84.0	85.5	86.0	0.63	0.77	0.84	15.0	
9.2	12.5	160M	6.14	6.0	2.2	2.4	0.0633	15	33	95.0	67.0	1460	86.0	87.0	87.0	0.69	0.79	0.84	18.2	
11	15	160M	7.34	6.0	2.3	2.6	0.0753	12	26	102	67.0	1460	86.0	87.5	88.0	0.62	0.74	0.81	22.3	
15	20	160L	10.0	6.3	2.3	2.4	0.1054	12	26	121	67.0	1460	88.0	88.5	89.0	0.68	0.79	0.83	29.3	
18.5	25	180M	12.3	7.0	2.5	2.7	0.1615	11	24	172	64.0	1470	88.5	89.5	89.5	0.67	0.77	0.84	35.5	
22	30	180L	14.6	7.2	2.7	2.9	0.1884	8	18	174	64.0	1465	89.0	90.5	90.5	0.69	0.80	0.85	41.0	
30	40	200L	19.8	7.2	2.5	2.8	0.3034	8	18	233	69.0	1475	89.5	90.0	91.0	0.68	0.78	0.83	57.3	
37	50	225S/M	24.4	6.7	2.3	2.8	0.5599	17	37	335	70.0	1475	91.0	91.0	91.5	0.71	0.81	0.86	67.4	
45	60	225S/M	29.7	7.0	2.4	3.0	0.6649	12	26	360	70.0	1475	90.5	91.5	92.0	0.68	0.77	0.83	85.1	
55	75	250S/M	36.3	6.8	2.3	2.7	0.8748	14	31	430	70.0	1475	92.0	92.0	92.5	0.77	0.85	0.89	95.3	
75	100	280S/M	49.2	6.7	2.0	2.7	1.85	22	48	647	76.0	1485	92.5	93.0	93.5	0.77	0.84	0.87	132	
90	125	280S/M	59.0	7.3	2.4	2.8	2.17	19	42	700	76.0	1485	93.0	93.6	93.6	0.77	0.85	0.87	159	
110	150	315S/M	72.2	7.3	2.4	2.8	2.57	17	37	825	77.0	1485	93.4	93.8	93.8	0.75	0.83	0.86	196	
132	175	315S/M	86.6	7.7	2.4	2.8	3.21	17	37	930	77.0	1485	93.7	94.2	94.2	0.74	0.83	0.86	234	
150	200	315S/M	98.4	7.5	2.8	2.8	3.45	17	37	962	77.0	1485	92.5	94.6	94.6	0.77	0.84	0.86	265	
160	220	315S/M	105	7.5	2.5	2.8	3.77	17	37	1010	77.0	1485	93.8	94.5	94.5	0.76	0.83	0.86	283	
185	250	315S/M*	121	7.3	2.3	2.5	3.63	15	33	1010	77.0	1485	93.0	94.8	94.8	0.75	0.82	0.86	325	
200	270	355M/L	131	6.6	2.3	2.2	6.34	44	97	1525	79.0	1490	94.6	94.7	94.8	0.78	0.85	0.87	348	
220	300	355M/L	144	7.0	2.1	2.3	6.89	39	86	1525	79.0	1490	94.0	94.7	94.8	0.80	0.86	0.88	378	
250	340	355M/L	163	6.9	2.2	2.5	8.12	36	79	1615	79.0	1490	94.0	94.7	94.8	0.80	0.86	0.88	428	
260	350	355M/L	170	6.5	2.2	2.3	8.12	30	66	1615	79.0	1490	94.0	94.7	94.8	0.80	0.86	0.88	445	
280	380	355M/L	183	7.1	2.2	2.4	9.02	39	86	1770	79.0	1490	94.0	94.7	94.8	0.81	0.87	0.88	479	
300	400	355M/L	196	6.7	2.2	2.4	9.92	47	103	1770	79.0	1490	94.0	94.7	94.8	0.81	0.87	0.89	508	
315	430	355M/L	206	6.7	2.2	2.4	9.92	42	92	1770	79.0	1490	94.0	94.7	94.8	0.79	0.86	0.88	537	
330	450	355M/L	216	6.5	2.3	2.3	10.8	32	70	1865	79.0	1490	94.2	94.8	94.9	0.81	0.87	0.89	556	
355	480	355M/L*	232	7.9	2.4	2.5	11.7	28	62	1865	79.0	1490	94.5	94.9	95.0	0.80	0.87	0.88	605	
High-Output Design																				
0.37	0.5	80	0.250	5.9	2.0	2.6	0.0020	13	29	14.0	44.0	1430	56.0	63.0	66.0	0.56	0.68	0.79	1.02	
1.5	2	100L	1.03	6.0	2.4	2.6	0.0065	9	20	23.0	53.0	1420	80.5	81.5	81.5	0.60	0.74	0.82	3.24	
2.2	3	90L	1.51	6.0	2.7	2.5	0.0066	8	18	23.0	49.0	1420	78.0	79.0	80.0	0.57	0.71	0.80	4.96	
4	5.5	100L*	2.80	6.7	2.6	2.6	0.0105	7	15	34.0	53.0	1390	81.0	82.0	83.1	0.64	0.76	0.83	8.48	
4	5.5	132S	2.66	8.3	2.2	3.1	0.0341	9	20	56.0	60.0	1465	81.5	84.0	85.5	0.58	0.72	0.80	8.40	
5.5	7.5	112M*	3.69	6.5	2.5	2.6	0.0188	8	18	45.5	56.0	1450	83.0	85.0	85.0	0.52	0.64	0.73	12.4	
7.5	10	132S	5.02	6.7	2.1	2.9	0.0000	8	18	64.5	58.0	1455	85.5	87.0	87.0	0.63	0.77	0.84	14.8	
9.2	12.5	132M	6.16	7.5	2.2	2.8	0.0582	6	13	70.0	60.0	1455	85.5	86.5	87.0	0.64	0.78	0.85	18.0	
11	15	160L	7.34	6.0	2.3	2.6	0.0753	12	26	102	67.0	1460	86.0	87.5	88.0	0.62	0.74	0.81	22.3	
15	20	160M	10.0	6.3	2.3	2.4	0.1054	12	26	121	67.0	1460	88.0	88.5	89.0	0.68	0.79	0.83	29.3	
18.5	25	160L*	12.4	6.0	2.4	2.4	0.1123	12	26	130	67.0	1455	88.0	89.0	89.5	0.64	0.76	0.82	36.2	
18.5	25	180L	12.3	7.0	2.5	2.7	0.1615	11	24	172	64.0	1470	88.5	89.5	89.5	0.67	0.77	0.84	35.5	
22	30	180M	14.6	7.2	2.7	2.9	0.1884	8	18	174	64.0	1465	89.0	90.5	90.5	0.69	0.80	0.85	41.0	
30	40	180L*	20.0	7.2	3.0	2.9	0.2075	7	15	186	64.0	1460	88.5	90.0	90.7	0.61	0.73	0.81	59.1	
30	40	200M	19.8	7.2	2.5	2.8	0.3034	8	18	233	69.0	1475	89.5	90.0	91.0	0.68	0.78	0.83	57.3	
37	50	200L	24.5	7.0	2.3	2.5	0.3735	14	31	260	69.0	1470	90.0	91.0	91.5	0.73	0.82	0.86	67.3	
37	50	250S/M	24.4	6.7	2.3	2.8	0.5599	17	37	335	70.0	1475	91.0	91.0	91.5	0.71	0.81	0.86	67.4	
55	75	225S/M	36.3	6.8	2.3	2.7	0.8748	14	31	430	70.0	1475	92.0	92.0	92.5	0.77	0.85	0.89	95.3	
55	75	280S/M	36.1	7.3	2.3	2.8	1.80	40	88	735	76.0	1485	91.0	93.0	93.2	0.72	0.81	0.85	99.7	
75	100	250S/M	49.4	7.2	2.4	2.6	1.12	12	26	510	70.0	1480	92.0	92.6	93.0	0.70	0.80	0.85	137	
90	125	315S/M	59.0	7.3	2.4	2.8	2.17	19	42	700	77.0	1485	93.0	93.6	93.6	0.77	0.85	0.87	159	
110	150	280S/M	72.2	7.3	2.4	2.8	2.57	17	37	825	76.0	1485	93.4	93.8	93.8	0.75	0.83	0.86	196	
185	250	355M/L	121	6.8	2.1	2.5	5.80	44	97	1415	79.0	1490	93.2	94.5	94.7	0.77	0.85	0.87	323	

# W21 Cast Iron Frame IE1

Output		380 V									415 V								
		Rated speed (rpm)	% of full load						Full load current In (A)	Rated speed (rpm)	% of full load						Full load current In (A)		
			Efficiency			Power Factor					Efficiency			Power Factor					
kW	HP		50	75	100	50	75	100		50	75	100	50	75	100				
4P-1500rpm-50HZ																			
0.55	0.75	1400	61.0	68.0	70.0	0.61	0.75	0.86	1.39	1415	58.5	66.0	70.0	0.51	0.67	0.79	1.38		
0.75	1	1380	64.0	71.0	72.1	0.61	0.75	0.84	1.88	1405	60.0	67.0	72.1	0.50	0.64	0.76	1.93		
1.1	1.5	1385	72.0	75.0	75.5	0.62	0.75	0.83	2.67	1405	67.0	75.0	77.0	0.49	0.64	0.75	2.65		
1.5	2	1380	78.5	79.0	79.0	0.65	0.78	0.86	3.35	1400	74.5	78.0	79.0	0.52	0.67	0.77	3.43		
2.2	3	1400	79.0	80.0	80.0	0.67	0.79	0.85	4.92	1420	78.0	80.0	80.0	0.55	0.68	0.78	4.90		
3	4	1410	80.0	81.0	81.5	0.64	0.77	0.84	6.63	1430	77.0	80.0	81.5	0.52	0.67	0.78	6.48		
4	5.5	1430	82.9	83.1	83.1	0.71	0.81	0.86	8.50	1445	80.6	82.5	83.5	0.59	0.72	0.80	8.33		
5.5	7.5	1445	84.5	85.0	85.0	0.70	0.81	0.86	11.4	1455	82.0	84.0	85.0	0.58	0.72	0.81	11.0		
7.5	10	1450	85.5	86.0	86.0	0.71	0.82	0.87	15.2	1455	82.5	85.0	86.0	0.57	0.72	0.80	15.2		
9.2	12.5	1455	86.0	87.0	87.0	0.73	0.82	0.85	18.9	1465	85.0	87.0	87.0	0.64	0.76	0.82	17.9		
11	15	1460	86.5	87.0	87.6	0.68	0.79	0.83	23.0	1465	85.0	87.0	88.0	0.57	0.70	0.78	22.3		
15	20	1455	88.0	88.5	89.0	0.72	0.82	0.85	30.1	1465	87.0	88.5	89.0	0.64	0.75	0.82	28.6		
18.5	25	1465	89.0	89.5	89.5	0.71	0.81	0.85	36.9	1470	87.5	89.5	89.5	0.62	0.74	0.81	35.5		
22	30	1460	89.5	90.2	90.2	0.73	0.82	0.86	43.1	1470	88.5	90.3	90.3	0.64	0.76	0.82	41.3		
30	40	1470	90.0	91.0	91.0	0.73	0.81	0.84	59.6	1475	88.5	90.0	91.0	0.63	0.75	0.80	57.3		
37	50	1470	90.0	91.0	91.5	0.75	0.83	0.87	70.2	1475	89.5	91.0	91.5	0.67	0.77	0.83	67.4		
45	60	1475	91.0	91.5	92.0	0.71	0.80	0.84	88.5	1480	90.0	91.5	92.0	0.63	0.74	0.80	85.1		
55	75	1470	92.0	92.0	92.5	0.79	0.86	0.90	99.6	1475	92.0	92.0	92.5	0.75	0.83	0.87	94.1		
75	100	1480	92.5	93.0	93.5	0.80	0.86	0.88	138	1485	92.0	93.0	93.5	0.75	0.83	0.86	129		
90	125	1480	93.0	93.6	93.6	0.80	0.86	0.88	165	1485	92.5	93.6	93.6	0.75	0.83	0.86	154		
110	150	1480	93.5	93.8	93.8	0.77	0.85	0.87	204	1485	93.2	93.8	93.8	0.72	0.81	0.85	191		
132	175	1485	93.7	94.2	94.2	0.77	0.84	0.87	243	1485	93.6	94.2	94.2	0.71	0.81	0.85	228		
150	200	1480	93.0	94.2	94.6	0.79	0.85	0.87	275	1485	92.5	94.6	94.6	0.75	0.83	0.85	258		
160	220	1485	93.8	94.5	94.5	0.78	0.85	0.87	295	1485	93.8	94.5	94.5	0.73	0.82	0.86	273		
185	250	1480	93.0	94.8	94.8	0.77	0.83	0.87	338	1485	93.5	94.8	94.8	0.72	0.80	0.85	317		
200	270	1485	94.6	94.7	94.8	0.80	0.86	0.88	363	1490	94.5	94.7	94.8	0.76	0.84	0.86	339		
220	300	1485	94.0	94.7	94.8	0.82	0.87	0.89	394	1490	94.0	94.7	94.8	0.78	0.85	0.87	368		
250	340	1485	94.0	94.7	94.8	0.82	0.87	0.89	446	1490	94.0	94.7	94.8	0.77	0.85	0.87	418		
260	350	1485	94.0	94.7	94.8	0.82	0.87	0.89	464	1490	94.0	94.7	94.8	0.77	0.85	0.87	434		
280	380	1485	94.0	94.7	94.8	0.83	0.88	0.89	499	1490	94.0	94.7	94.8	0.79	0.86	0.87	467		
300	400	1485	94.0	94.7	94.8	0.83	0.88	0.89	536	1490	94.0	94.7	94.8	0.79	0.86	0.88	496		
315	430	1485	94.0	94.7	94.8	0.83	0.87	0.89	560	1490	94.0	94.7	94.8	0.76	0.84	0.87	524		
330	450	1485	94.2	94.8	94.9	0.83	0.88	0.90	580	1490	94.2	94.8	94.9	0.79	0.86	0.88	542		
355	480	1490	94.5	94.9	95.0	0.82	0.88	0.89	630	1490	94.5	94.9	95.0	0.78	0.86	0.88	583		
High-Output Design																			
0.37	0.5	1420	56.0	64.0	67.0	0.61	0.73	0.82	1.02	1440	55.0	62.0	66.0	0.65	0.66	0.76	1.03		
1.5	2	1410	80.5	81.0	80.5	0.67	0.79	0.85	3.33	1430	79.0	81.0	81.5	0.55	0.68	0.78	3.28		
2.2	3	1410	78.0	79.0	80.0	0.65	0.75	0.83	5.03	1445	78.0	79.0	80.0	0.53	0.66	0.76	5.03		
4	5.5	1380	81.0	82.0	83.1	0.69	0.80	0.85	8.83	1400	81.0	82.0	83.1	0.60	0.73	0.81	8.33		
4	5.5	1460	82.0	84.0	85.0	0.61	0.74	0.82	8.70	1470	81.0	84.0	85.5	0.56	0.70	0.78	8.30		
5.5	7.5	1445	84.0	85.0	85.0	0.58	0.70	0.77	12.3	1455	81.0	85.0	85.0	0.47	0.60	0.69	12.6		
7.5	10	1450	86.5	86.8	86.8	0.71	0.82	0.87	15.1	1455	83.7	86.2	86.7	0.57	0.72	0.80	15.0		
9.2	12.5	1450	86.0	86.5	87.0	0.70	0.82	0.87	18.5	1455	84.5	86.0	87.0	0.59	0.73	0.82	17.9		
11	15	1460	86.5	87.0	87.6	0.68	0.79	0.83	23.0	1465	85.0	87.0	88.0	0.57	0.70	0.78	22.3		
15	20	1455	88.0	88.5	89.0	0.72	0.82	0.85	30.1	1465	87.0	88.5	89.0	0.64	0.75	0.82	28.6		
18.5	25	1450	88.0	89.0	89.5	0.70	0.80	0.84	37.4	1460	87.0	89.0	89.5	0.60	0.73	0.80	35.7		
18.5	25	1465	89.0	89.5	89.5	0.71	0.81	0.85	36.9	1470	87.5	89.5	89.5	0.62	0.74	0.81	35.5		
22	30	1460	89.5	90.2	90.2	0.73	0.82	0.86	43.1	1470	88.5	90.3	90.3	0.64	0.76	0.82	41.3		
30	40	1460	89.0	90.0	90.7	0.66	0.77	0.83	60.7	1465	88.0	90.0	90.7	0.59	0.71	0.78	59.0		
30	40	1470	90.0	91.0	91.0	0.73	0.81	0.84	59.6	1475	88.5	90.0	91.0	0.63	0.75	0.80	57.3		
37	50	1465	90.0	91.0	91.5	0.77	0.84	0.87	70.2	1475	90.0	91.0	91.5	0.69	0.80	0.85	65.5		
37	50	1470	90.0	91.0	91.5	0.75	0.83	0.87	70.2	1475	89.5	91.0	91.5	0.67	0.77	0.83	67.4		
55	75	1470	92.0	92.0	92.5	0.79	0.86	0.90	99.6	1475	92.0	92.0	92.5	0.75	0.83	0.87	94.1		
55	75	1480	90.0	93.0	93.2	0.75	0.84	0.87	103	1485	91.0	93.0	93.2	0.70	0.80	0.84	97.1		
75	100	1475	90.0	92.6	93.0	0.73	0.81	0.83	148	1480	92.0	92.6	93.0	0.67	0.79	0.85	132		
90	125	1480	93.0	93.6	93.6	0.80	0.86	0.88	165	1485	92.5	93.6	93.6	0.75	0.83	0.86	154		
110	150	1480	93.5	93.8	93.8	0.77	0.85	0.87	204	1485	93.2	93.8	93.8	0.72	0.81	0.85	191		
185	250	1490	93.5	94.3	94.7	0.79	0.86	0.88	337	1490	93.1	94.5	94.7	0.76	0.84	0.86	315		



# W21 Cast Iron Frame IE1

Output		Frame	Full Load Torque (kgfm)	Locked Rotor Current I/In	Locked Rotor Torque Tl/Tn	Break-down Torque Tb/Tn	Inertia J (kgm²)	Allowable locked rotor time (s)		Weight (kg)	Sound dB(A)	460 V 60Hz								
												Rated speed (rpm)	% of full load			Full load current In (A)				
													Efficiency			Power Factor				
kW	HP							Hot	Cold			50	75	100	50	75	100			
4P-1500rpm-60HZ																				
0.55	0.75	80	0.380	4.7	2.1	2.2	0.0019	17	37	10.0	44.0	1720	65.0	70.0	74.0	0.52	0.65	0.75	1.24	
0.75	1	80	0.520	5.0	2.3	2.2	0.0023	14	31	11.0	44.0	1715	64.9	69.4	71.6	0.53	0.65	0.75	1.75	
1.1	1.5	90S	0.770	5.6	2.3	2.4	0.0039	8	18	14.5	49.0	1720	69.7	74.1	75.5	0.54	0.67	0.76	2.41	
1.5	2	90L	1.05	5.5	2.3	2.4	0.0048	8	18	17.0	49.0	1705	74.5	78.4	79.7	0.57	0.69	0.78	3.03	
2.2	3	100L	1.52	5.6	2.4	2.6	0.0065	9	20	23.0	53.0	1720	77.7	80.1	80.7	0.58	0.71	0.79	4.33	
3	4	100L	2.06	6.0	2.8	3.0	0.0084	8	18	30.0	53.0	1730	76.8	79.8	81.0	0.56	0.69	0.78	5.96	
4	5.5	112M	2.71	7.0	2.1	2.5	0.0147	13	29	33.0	56.0	1745	81.9	84.0	84.5	0.64	0.76	0.83	7.16	
5.5	7.5	132S	3.69	6.5	2.1	2.5	0.0349	11	24	47.0	60.0	1755	83.2	85.2	85.6	0.63	0.76	0.83	9.72	
7.5	10	132M	5.02	6.7	1.9	2.8	0.0465	8	18	64.5	60.0	1760	83.7	86.0	86.6	0.63	0.76	0.83	13.1	
9.2	12.5	160M	6.14	6.0	2.2	2.4	0.0633	15	33	95.0	67.0	1760	84.6	86.9	86.8	0.65	0.76	0.82	16.2	
11	15	160M	7.34	6.0	2.3	2.6	0.0753	12	26	102	67.0	1760	85.3	87.8	88.5	0.61	0.73	0.80	19.5	
15	20	160L	10.0	6.3	2.3	2.4	0.1054	12	26	121	67.0	1765	86.3	88.5	89.0	0.66	0.78	0.83	25.5	
18.5	25	180M	12.3	7.0	2.5	2.7	0.1615	11	24	172	64.0	1770	87.5	89.6	90.0	0.64	0.77	0.82	31.5	
22	30	180L	14.6	7.2	2.7	2.9	0.1884	8	18	174	64.0	1765	88.6	90.4	90.7	0.66	0.77	0.83	36.7	
30	40	200L	19.8	7.2	2.5	2.8	0.3034	8	18	233	69.0	1775	87.9	90.2	91.1	0.67	0.78	0.81	51.0	
37	50	225S/M	24.4	6.7	2.3	2.8	0.5599	17	37	335	70.0	1775	88.7	90.7	91.4	0.68	0.80	0.85	59.8	
45	60	225S/M	29.7	7.0	2.4	3.0	0.6649	12	26	360	70.0	1780	89.2	91.0	91.7	0.66	0.77	0.82	75.1	
55	75	250S/M	36.3	6.8	2.3	2.7	0.8748	14	31	430	70.0	1775	91.5	92.4	92.6	0.74	0.84	0.87	85.7	
75	100	280S/M	49.2	6.7	2.0	2.7	1.85	22	48	647	76.0	1785	91.3	92.8	93.4	0.74	0.84	0.87	116	
90	125	280S/M	59.0	7.3	2.4	2.8	2.17	19	42	700	76.0	1785	92.1	93.2	93.6	0.74	0.84	0.87	139	
110	150	315S/M	72.2	7.3	2.4	2.8	2.57	17	37	825	77.0	1785	92.6	93.6	93.8	0.72	0.82	0.86	171	
132	175	315S/M	86.6	7.7	2.4	2.8	3.21	17	37	930	77.0	1785	92.9	94.0	94.4	0.71	0.82	0.86	204	
150	200	315S/M	98.4	7.5	2.8	2.8	3.45	17	37	962	77.0	1780	90.7	93.1	94.5	0.73	0.83	0.86	232	
160	220	315S/M	105	7.5	2.5	2.8	3.77	17	37	1010	77.0	1785	93.1	94.3	94.5	0.72	0.82	0.86	247	
185	250	315S/M*	121	7.3	2.3	2.5	3.63	15	33	1010	77.0	1780	92.4	94.2	94.8	0.69	0.79	0.84	292	
200	270	355M/L	131	6.6	2.3	2.2	6.34	44	97	1525	79.0	1785	93.8	94.9	94.9	0.75	0.84	0.87	304	
220	300	355M/L	144	7.0	2.1	2.3	6.89	39	86	1525	79.0	1785	93.3	94.6	94.9	0.76	0.85	0.88	331	
250	340	355M/L	163	6.9	2.2	2.5	8.12	36	79	1615	79.0	1785	93.3	94.6	94.8	0.77	0.86	0.88	376	
260	350	355M/L	170	6.5	2.2	2.3	8.12	30	66	1615	79.0	1785	93.4	94.6	94.8	0.78	0.86	0.88	391	
280	380	355M/L	183	7.1	2.2	2.4	9.02	39	86	1770	79.0	1785	93.4	94.7	94.9	0.78	0.86	0.88	421	
300	400	355M/L	196	6.7	2.2	2.4	9.92	47	103	1770	79.0	1785	93.3	94.6	94.9	0.78	0.86	0.88	451	
315	430	355M/L	206	6.7	2.2	2.4	9.92	42	92	1770	79.0	1785	93.2	94.6	94.9	0.75	0.84	0.88	473	
330	450	355M/L	216	6.5	2.3	2.3	10.8	32	70	1865	79.0	1785	93.4	94.7	95.0	0.77	0.86	0.89	490	
355	480	355M/L*	232	7.9	2.4	2.5	11.7	28	62	1865	79.0	1790	94.2	94.8	95.0	0.77	0.86	0.89	527	
High-Output Design																				
0.37	0.5	80	0.250	5.9	2.0	2.6	0.0020	13	29	14.0	44.0	1735	55.6	61.6	70.0	0.55	0.66	0.75	0.885	
1.5	2	100L	1.03	6.0	2.4	2.6	0.0065	9	20	23.0	53.0	1730	77.9	81.1	82.0	0.56	0.71	0.80	2.87	
2.2	3	90L	1.51	6.0	2.7	2.5	0.0066	8	18	23.0	49.0	1730	75.7	78.9	79.9	0.55	0.68	0.76	4.55	
4	5.5	100L*	2.80	6.7	2.6	2.6	0.0105	7	15	34.0	53.0	1710	79.2	81.7	82.7	0.62	0.75	0.81	7.50	
4	5.5	132S	2.66	8.3	2.2	3.1	0.0341	9	20	56.0	60.0	1770	79.2	82.8	84.4	0.53	0.67	0.76	7.83	
5.5	7.5	112M*	3.69	6.5	2.5	2.6	0.0188	8	18	45.5	56.0	1750	82.6	85.3	85.7	0.49	0.62	0.70	11.2	
7.5	10	132S	5.02	6.7	2.1	2.9	0.0000	8	18	64.5	58.0	1760	84.5	87.0	87.7	0.63	0.76	0.83	12.9	
9.2	12.5	132M	6.16	7.5	2.2	2.8	0.0582	6	13	70.0	60.0	1760	85.4	87.1	87.2	0.63	0.75	0.83	16.0	
11	15	160L	7.34	6.0	2.3	2.6	0.0753	12	26	102	67.0	1760	85.3	87.8	88.5	0.61	0.73	0.80	19.5	
15	20	160M	10.0	6.3	2.3	2.4	0.1054	12	26	121	67.0	1765	86.3	88.5	89.0	0.66	0.78	0.83	25.5	
18.5	25	180L*	12.4	6.0	2.4	2.4	0.1123	12	26	130	67.0	1760	87.5	89.4	89.6	0.62	0.75	0.80	32.4	
18.5	25	180L	12.3	7.0	2.5	2.7	0.1615	11	24	172	64.0	1770	87.5	89.6	90.0	0.64	0.77	0.82	31.5	
22	30	180M	14.6	7.2	2.7	2.9	0.1884	8	18	174	64.0	1765	88.6	90.4	90.7	0.66	0.77	0.83	36.7	
30	40	180L*	20.0	7.2	3.0	2.9	0.2075	7	15	186	64.0	1765	87.9	90.0	90.6	0.57	0.70	0.78	53.3	
30	40	200M	19.8	7.2	2.5	2.8	0.3034	8	18	233	69.0	1775	87.9	90.2	91.1	0.67	0.78	0.81	51.0	
37	50	200L	24.5	7.0	2.3	2.5	0.3735	14	31	260	69.0	1775	89.8	91.3	91.5	0.70	0.81	0.85	59.7	
37	50	250S/M	24.4	6.7	2.3	2.8	0.5599	17	37	335	70.0	1775	88.7	90.7	91.4	0.68	0.80	0.85	59.8	
55	75	225S/M	36.3	6.8	2.3	2.7	0.8748	14	31	430	70.0	1775	91.5	92.4	92.6	0.74	0.84	0.87	85.7	
55	75	280S/M	36.1	7.3	2.3	2.8	1.80	40	88	735	76.0	1780	90.7	92.3	93.0	0.70	0.79	0.84	88.4	
75	100	250S/M	49.4	7.2	2.4	2.6	1.12	12	26	510	70.0	1775	90.7	92.4	93.2	0.67	0.79	0.85	119	
90	125	315S/M	59.0	7.3	2.4	2.8	2.17	19	42	700	77.0	1785	92.1	93.2	93.6	0.74	0.84	0.87	139	
110	150	280S/M	72.2	7.3	2.4	2.8	2.57	17	37	825	76.0	1785	92.6	93.6	93.8	0.72	0.82	0.86	171	
185	250	355M/L	121	6.8	2.1	2.5	5.80	44	97	1415	79.0	1790	92.3	94.1	94.6	0.73	0.83	0.86	285	

# W21 Cast Iron Frame IE1

Output		Frame	Full Load Torque (kgfm)	Locked Rotor Current I <sub>L</sub> /I <sub>n</sub>	Locked Rotor Torque T <sub>L</sub> /T <sub>n</sub>	Break-down Torque T <sub>b</sub> /T <sub>n</sub>	Inertia J (kgm <sup>2</sup> )	Allowable locked rotor time (s)		Weight (kg)	Sound dB(A)	400 V								
								Rated speed (rpm)	% of full load						Full load current I <sub>n</sub> (A)					
									Efficiency			Power Factor								
kW	HP							Hot	Cold			50	75	100	50	75	100			
6P-1000rpm-50HZ																				
0.37	0.5	80	0.400	3.6	1.7	1.7	0.0019	16	35	12.1	43.0	905	55.0	60.0	63.0	0.50	0.64	0.75	1.13	
0.55	0.75	80	0.580	4.5	2.3	2.3	0.0030	10	22	15.5	43.0	930	60.0	65.0	67.0	0.50	0.63	0.73	1.62	
0.75	1	90S	0.800	4.2	1.9	2.0	0.0045	16	35	19.1	45.0	910	70.0	70.0	71.0	0.55	0.69	0.79	1.89	
1.1	1.5	90L	1.16	4.8	2.7	2.7	0.0062	9	20	22.0	45.0	925	70.0	71.0	73.0	0.47	0.60	0.72	3.04	
1.5	2	100L	1.61	4.1	2.0	2.2	0.0090	17	37	25.0	44.0	910	72.0	75.5	75.5	0.51	0.65	0.73	3.93	
2.2	3	112M	2.28	5.0	2.2	2.3	0.0165	14	31	34.5	52.0	940	76.0	78.5	78.5	0.53	0.66	0.74	5.36	
3	4	132S	3.06	5.3	2.0	2.2	0.0340	20	44	55.0	53.0	955	78.0	80.5	80.5	0.58	0.70	0.77	6.82	
4	5.5	132M	4.06	5.8	2.3	2.4	0.0446	19	42	59.0	53.0	960	80.0	81.5	82.0	0.54	0.66	0.74	9.27	
5.5	7.5	132M	5.58	6.4	2.7	2.8	0.0581	15	33	73.0	53.0	960	81.0	83.5	84.0	0.49	0.62	0.71	13.0	
7.5	10	160M	7.57	5.7	2.2	2.5	0.1077	11	24	100	56.0	965	84.0	85.0	85.5	0.64	0.76	0.83	15.0	
9.2	12.5	160L	9.29	6.0	2.0	2.6	0.1293	10	22	115	56.0	965	85.0	86.0	86.0	0.63	0.75	0.82	18.6	
11	15	160L	11.1	6.0	2.2	2.6	0.1580	11	24	125	56.0	965	86.5	87.0	87.0	0.65	0.77	0.83	21.7	
15	20	180L	15.0	7.5	2.3	2.7	0.2620	7	15	163	56.0	975	88.0	89.0	89.0	0.76	0.84	0.88	27.6	
18.5	25	200L	18.5	6.0	2.1	2.5	0.3408	11	24	213	58.0	975	88.0	89.0	89.0	0.64	0.76	0.82	36.1	
22	30	200L	22.0	6.0	2.3	2.4	0.4037	14	31	235	58.0	975	88.5	90.5	90.5	0.70	0.79	0.84	41.4	
30	40	225S/M	29.7	7.2	2.6	2.7	0.9253	20	44	366	61.0	985	90.0	91.3	91.3	0.77	0.84	0.87	54.2	
37	50	250S/M	36.8	7.5	2.7	2.6	1.16	18	40	440	61.0	980	91.8	91.9	91.9	0.77	0.85	0.87	66.4	
45	60	280S/M	44.5	6.8	2.4	2.6	2.07	24	53	580	66.0	985	89.5	91.5	92.0	0.68	0.78	0.83	84.5	
55	75	280S/M	54.4	6.5	2.3	2.5	2.41	23	51	616	66.0	985	91.0	92.5	92.5	0.69	0.80	0.83	103	
75	100	315S/M	74.2	6.7	2.3	2.5	3.22	20	44	768	69.0	985	91.0	93.0	93.0	0.71	0.81	0.85	136	
90	125	315S/M	89.0	6.3	2.1	2.3	3.57	18	40	818	69.0	985	92.0	93.1	93.3	0.71	0.80	0.84	166	
110	150	315S/M	109	6.4	2.3	2.4	4.83	18	40	942	69.0	985	93.0	93.8	93.8	0.71	0.80	0.84	200	
132	175	315S/M*	131	6.3	2.1	2.2	5.29	13	29	990	69.0	985	93.0	94.0	94.0	0.72	0.81	0.85	237	
150	200	355M/L	147	6.2	2.0	2.1	9.05	81	178	0.0	73.0	995	92.8	94.9	95.3	0.68	0.76	0.81	280	
160	220	355M/L	157	6.2	1.9	2.1	9.53	72	158	1485	73.0	990	93.0	95.0	95.3	0.67	0.77	0.82	296	
185	250	355M/L	182	6.0	1.9	2.1	10.2	76	167	1530	73.0	990	93.0	94.2	94.8	0.68	0.76	0.81	348	
200	270	355M/L	197	6.3	2.1	2.3	12.4	85	187	1700	73.0	990	93.5	94.5	94.8	0.70	0.78	0.81	376	
220	300	355M/L	216	6.5	2.0	2.3	13.8	72	158	1795	73.0	990	93.4	94.8	95.3	0.67	0.77	0.80	417	
250	340	355M/L	245	6.1	2.2	2.2	14.8	64	141	1830	73.0	995	94.0	95.1	95.6	0.70	0.79	0.82	460	
260	350	355M/L	255	6.1	2.1	2.1	14.8	64	141	1830	73.0	995	94.0	95.1	95.6	0.70	0.79	0.82	479	
280	380	355M/L	275	6.0	2.1	2.2	14.8	54	119	1830	73.0	990	94.3	95.2	95.4	0.68	0.77	0.80	530	
300	400	355M/L*	295	6.4	2.1	2.1	14.8	39	86	1920	73.0	990	94.0	95.5	95.6	0.63	0.73	0.79	573	
315	430	355M/L*	310	6.0	1.9	1.9	15.5	38	84	1950	73.0	990	94.3	95.8	95.9	0.69	0.78	0.81	585	
High-Output Design																				
0.25	0.33	80	0.260	4.6	2.5	2.9	0.0022	19	42	13.5	43.0	950	52.0	60.0	64.0	0.44	0.55	0.65	0.867	
0.75	1	90L	0.800	4.2	1.9	2.0	0.0045	16	35	19.1	45.0	910	70.0	70.0	71.0	0.55	0.69	0.79	1.89	
1.5	2	112M	1.55	5.5	2.2	2.2	0.0150	15	33	36.0	52.0	945	77.5	78.0	78.0	0.54	0.66	0.74	3.75	
3	4	112M	3.04	6.3	2.6	2.6	0.0257	10	22	46.0	52.0	960	77.0	80.0	82.0	0.53	0.65	0.73	7.06	
3	4	132M	3.06	5.3	2.0	2.2	0.0340	20	44	55.0	53.0	955	78.0	80.5	80.5	0.58	0.70	0.77	6.82	
4	5.5	132S	4.06	5.8	2.3	2.4	0.0446	19	42	59.0	53.0	960	80.0	81.5	82.0	0.54	0.66	0.74	9.27	
7.5	10	160L	7.57	5.7	2.2	2.5	0.1077	11	24	100	56.0	965	84.0	85.0	85.5	0.64	0.76	0.83	15.0	
9.2	12.5	160M	9.29	6.0	2.0	2.6	0.1293	10	22	115	56.0	965	85.0	86.0	86.0	0.63	0.75	0.82	18.6	
18.5	25	200M	18.5	6.0	2.1	2.5	0.3408	11	24	213	58.0	975	88.0	89.0	89.0	0.64	0.76	0.82	36.1	
22	30	200M	22.0	6.0	2.3	2.4	0.4037	14	31	235	58.0	975	88.5	90.5	90.5	0.70	0.79	0.84	41.4	
37	50	225S/M	36.8	7.5	2.7	2.6	1.16	18	40	440	61.0	980	91.8	91.9	91.9	0.77	0.85	0.87	66.4	
45	60	250S/M	44.5	8.0	2.8	2.8	1.43	18	40	490	61.0	985	90.5	91.8	92.1	0.76	0.84	0.87	79.7	
75	100	280S/M	74.2	6.7	2.3	2.5	3.22	20	44	768	66.0	985	91.0	93.0	93.0	0.71	0.81	0.85	136	
90	125	280S/M	89.0	6.3	2.1	2.3	3.57	18	40	818	66.0	985	92.0	93.1	93.3	0.71	0.80	0.84	166	
132	175	355M/L	130	6.1	2.0	2.3	7.89	90	198	1385	73.0	990	92.5	94.7	94.7	0.65	0.75	0.80	251	



# W21 Cast Iron Frame IE1

Output		380 V									415 V								
		Rated speed (rpm)	% of full load						Full load current In (A)	Rated speed (rpm)	% of full load						Full load current In (A)		
			Efficiency			Power Factor					Efficiency			Power Factor					
kW	HP	50	75	100	50	75	100	50	75	100	50	75	100	50	75	100			
6P-1000rpm-50HZ																			
0.37	0.5	890	57.0	62.0	65.0	0.54	0.69	0.80	1.08	910	55.0	60.0	62.0	0.47	0.60	0.72	1.15		
0.55	0.75	920	62.0	65.8	68.0	0.54	0.67	0.77	1.60	935	58.0	64.0	66.0	0.47	0.59	0.68	1.70		
0.75	1	895	69.0	70.0	71.0	0.61	0.75	0.83	1.91	915	68.0	69.0	70.0	0.52	0.66	0.76	1.93		
1.1	1.5	915	71.0	72.0	73.0	0.52	0.67	0.77	2.87	930	69.0	70.0	73.0	0.42	0.55	0.67	3.15		
1.5	2	900	72.0	75.5	75.5	0.57	0.70	0.77	3.92	920	72.0	74.0	75.5	0.46	0.60	0.69	4.01		
2.2	3	930	77.0	78.5	78.5	0.58	0.70	0.76	5.52	950	74.0	78.5	78.5	0.50	0.63	0.72	5.28		
3	4	950	79.0	80.0	80.0	0.61	0.72	0.79	7.04	960	77.0	80.5	80.5	0.53	0.66	0.74	6.83		
4	5.5	960	80.0	82.0	82.0	0.58	0.73	0.78	9.50	965	78.0	81.0	82.0	0.52	0.64	0.72	9.21		
5.5	7.5	960	82.0	83.5	84.0	0.56	0.69	0.75	13.0	965	79.0	82.0	84.0	0.45	0.57	0.66	13.6		
7.5	10	960	84.0	85.0	85.0	0.69	0.80	0.85	15.6	965	84.5	85.5	85.5	0.61	0.73	0.80	15.1		
9.2	12.5	960	85.0	86.0	86.0	0.68	0.79	0.84	19.2	970	85.0	86.0	86.0	0.59	0.72	0.80	18.4		
11	15	960	86.5	87.0	87.0	0.70	0.80	0.85	22.5	970	86.0	87.0	87.0	0.61	0.74	0.81	21.4		
15	20	970	88.0	88.5	88.5	0.80	0.86	0.89	28.9	975	88.0	89.0	89.0	0.73	0.82	0.87	27.0		
18.5	25	975	88.5	89.0	89.0	0.69	0.80	0.84	37.2	980	87.0	89.0	89.0	0.60	0.73	0.80	35.7		
22	30	970	89.0	90.5	90.5	0.74	0.82	0.85	43.1	980	88.0	90.3	90.5	0.66	0.76	0.82	40.9		
30	40	980	90.5	91.2	91.2	0.80	0.86	0.88	56.5	985	89.5	91.5	91.5	0.73	0.81	0.86	52.6		
37	50	980	90.0	91.8	91.8	0.80	0.86	0.88	69.1	985	89.0	92.0	92.0	0.73	0.82	0.86	64.6		
45	60	985	90.0	91.5	92.0	0.72	0.81	0.85	86.9	990	89.0	91.5	92.0	0.64	0.76	0.82	82.4		
55	75	985	91.0	92.5	92.5	0.72	0.82	0.85	106	990	90.5	92.5	92.5	0.66	0.78	0.82	101		
75	100	985	91.0	93.0	93.0	0.74	0.82	0.86	142	990	90.5	93.0	93.0	0.69	0.80	0.84	132		
90	125	985	92.0	93.1	93.2	0.74	0.82	0.85	173	990	92.0	93.1	93.4	0.69	0.78	0.83	162		
110	150	985	93.0	93.8	93.8	0.74	0.82	0.85	208	985	93.0	93.8	93.8	0.69	0.79	0.83	195		
132	175	980	93.0	94.0	94.0	0.75	0.83	0.86	247	985	93.0	94.0	94.0	0.70	0.80	0.84	231		
150	200	990	93.3	94.9	95.2	0.72	0.79	0.83	288	995	92.3	94.9	95.3	0.64	0.73	0.79	277		
160	220	990	93.5	95.2	95.2	0.73	0.80	0.84	304	990	92.5	94.9	95.4	0.63	0.74	0.80	292		
185	250	990	93.5	94.4	94.8	0.73	0.80	0.83	357	990	92.5	94.0	94.8	0.63	0.72	0.79	344		
200	270	990	94.0	94.7	94.8	0.74	0.81	0.83	386	990	93.0	94.3	94.8	0.66	0.75	0.79	372		
220	300	990	93.8	95.0	95.3	0.72	0.80	0.82	428	995	93.0	94.6	95.3	0.62	0.74	0.79	407		
250	340	995	94.3	95.2	95.5	0.74	0.81	0.83	479	995	93.7	95.0	95.8	0.67	0.77	0.81	448		
260	350	990	94.3	95.2	95.5	0.74	0.81	0.83	498	995	93.7	95.0	95.8	0.67	0.77	0.81	466		
280	380	985	94.7	95.3	95.4	0.73	0.80	0.81	551	990	93.9	95.1	95.3	0.64	0.74	0.79	517		
300	400	990	94.7	95.7	95.7	0.68	0.77	0.81	588	995	93.3	95.3	95.5	0.58	0.70	0.77	568		
315	430	985	94.8	96.0	95.8	0.73	0.80	0.82	609	990	93.8	95.6	95.8	0.65	0.76	0.80	572		
High-Output Design																			
0.25	0.33	945	54.0	62.0	65.0	0.47	0.59	0.68	0.859	955	50.0	58.0	63.0	0.41	0.51	0.62	0.890		
0.75	1	895	69.0	70.0	71.0	0.61	0.75	0.83	1.91	915	68.0	69.0	70.0	0.52	0.66	0.76	1.93		
1.5	2	935	77.0	77.5	77.5	0.57	0.69	0.76	3.87	950	77.5	78.0	78.0	0.51	0.63	0.72	3.72		
3	4	955	78.0	80.0	82.0	0.59	0.70	0.76	7.15	965	75.0	80.0	82.0	0.48	0.60	0.69	7.20		
3	4	950	79.0	80.0	80.0	0.61	0.72	0.79	7.04	960	77.0	80.5	80.5	0.53	0.66	0.74	6.83		
4	5.5	960	80.0	82.0	82.0	0.58	0.73	0.78	9.50	965	78.0	81.0	82.0	0.52	0.64	0.72	9.21		
7.5	10	960	84.0	85.0	85.0	0.69	0.80	0.85	15.6	965	84.5	85.5	85.5	0.61	0.73	0.80	15.1		
9.2	12.5	960	85.0	86.0	86.0	0.68	0.79	0.84	19.2	970	85.0	86.0	86.0	0.59	0.72	0.80	18.4		
18.5	25	975	88.5	89.0	89.0	0.69	0.80	0.84	37.2	980	87.0	89.0	89.0	0.60	0.73	0.80	35.7		
22	30	970	89.0	90.5	90.5	0.74	0.82	0.85	43.1	980	88.0	90.3	90.5	0.66	0.76	0.82	40.9		
37	50	980	90.0	91.8	91.8	0.80	0.86	0.88	69.1	985	89.0	92.0	92.0	0.73	0.82	0.86	64.6		
45	60	985	91.0	91.8	92.0	0.79	0.86	0.88	83.0	990	90.0	91.8	92.2	0.73	0.82	0.86	77.6		
75	100	985	91.0	93.0	93.0	0.74	0.82	0.86	142	990	90.5	93.0	93.0	0.69	0.80	0.84	132		
90	125	985	92.0	93.1	93.2	0.74	0.82	0.85	173	990	92.0	93.1	93.4	0.69	0.78	0.83	162		
132	175	990	93.0	94.7	94.5	0.70	0.80	0.82	259	995	92.0	94.7	94.7	0.60	0.70	0.77	252		



# W21 Cast Iron Frame IE1

Output		Frame	Full Load Torque (kgfm)	Locked Rotor Current I <sub>L</sub> /I <sub>n</sub>	Locked Rotor Torque T <sub>L</sub> /T <sub>n</sub>	Break-down Torque T <sub>b</sub> /T <sub>n</sub>	Inertia J (kgm <sup>2</sup> )	Allowable locked rotor time (s)		Weight (kg)	Sound dB(A)	460 V 60Hz							Full load current I <sub>n</sub> (A)
								Hot	Cold			Rated speed (rpm)	% of full load			Power Factor			
													Efficiency			Power Factor			
kW	HP											50	75	100	50	75	100		
6P-1000rpm-60HZ																			
0.37	0.5	80	0.400	3.6	1.7	1.7	0.0019	16	35	12.1	43.0	1115	53.1	59.9	63.1	0.47	0.58	0.69	1.07
0.55	0.75	80	0.580	4.5	2.3	2.3	0.0030	10	22	15.5	43.0	1140	58.7	65.0	67.1	0.47	0.59	0.68	1.51
0.75	1	90S	0.800	4.2	1.9	2.0	0.0045	16	35	19.1	45.0	1120	68.4	71.1	71.3	0.53	0.66	0.75	1.76
1.1	1.5	90L	1.16	4.8	2.7	2.7	0.0062	9	20	22.0	45.0	1135	70.3	74.1	74.6	0.44	0.57	0.67	2.76
1.5	2	100L	1.61	4.1	2.0	2.2	0.0090	17	37	25.0	44.0	1125	72.2	76.4	78.0	0.49	0.61	0.69	3.50
2.2	3	112M	2.28	5.0	2.2	2.3	0.0165	14	31	34.5	52.0	1140	75.8	78.4	78.9	0.50	0.62	0.70	5.00
3	4	132S	3.06	5.3	2.0	2.2	0.0340	20	44	55.0	53.0	1160	77.1	79.8	80.6	0.52	0.65	0.73	6.40
4	5.5	132M	4.06	5.8	2.3	2.4	0.0446	19	42	59.0	53.0	1165	79.9	82.0	82.5	0.52	0.64	0.72	8.45
5.5	7.5	132M	5.58	6.4	2.7	2.8	0.0581	15	33	73.0	53.0	1165	81.2	83.5	84.1	0.48	0.61	0.70	11.7
7.5	10	160M	7.57	5.7	2.2	2.5	0.1077	11	24	100	56.0	1170	84.3	86.2	86.2	0.61	0.74	0.81	13.5
9.2	12.5	160L	9.29	6.0	2.0	2.6	0.1293	10	22	115	56.0	1170	84.3	86.5	86.7	0.61	0.74	0.81	16.4
11	15	160L	11.1	6.0	2.2	2.6	0.1580	11	24	125	56.0	1170	86.5	88.1	87.9	0.62	0.75	0.81	19.4
15	20	180L	15.0	7.5	2.3	2.7	0.2620	7	15	163	56.0	1175	87.4	89.1	89.5	0.73	0.83	0.87	24.2
18.5	25	200L	18.5	6.0	2.1	2.5	0.3408	11	24	213	58.0	1175	87.4	89.5	89.7	0.62	0.74	0.80	32.4
22	30	200L	22.0	6.0	2.3	2.4	0.4037	14	31	235	58.0	1175	87.8	89.9	90.5	0.67	0.77	0.82	37.2
30	40	225S/M	29.7	7.2	2.6	2.7	0.9253	20	44	366	61.0	1180	89.2	90.9	91.4	0.73	0.83	0.87	47.4
37	50	250S/M	36.8	7.5	2.7	2.6	1.16	18	40	440	61.0	1180	89.4	91.1	91.9	0.74	0.83	0.86	58.8
45	60	280S/M	44.5	6.8	2.4	2.6	2.07	24	53	580	66.0	1185	88.4	90.8	91.8	0.65	0.76	0.81	76.0
55	75	280S/M	54.4	6.5	2.3	2.5	2.41	23	51	616	66.0	1185	90.2	92.2	92.6	0.66	0.77	0.82	90.9
75	100	315S/M	74.2	6.7	2.3	2.5	3.22	20	44	768	69.0	1185	90.4	92.5	93.0	0.68	0.79	0.84	120
90	125	315S/M	89.0	6.3	2.1	2.3	3.57	18	40	818	69.0	1180	91.0	92.9	93.3	0.68	0.79	0.83	146
110	150	315S/M	109	6.4	2.3	2.4	4.83	18	40	942	69.0	1185	92.0	93.8	94.0	0.67	0.78	0.83	177
132	175	315S/M*	131	6.3	2.1	2.2	5.29	13	29	990	69.0	1185	92.0	93.9	94.2	0.68	0.79	0.83	212
150	200	355M/L	147	6.2	2.0	2.1	9.05	81	178	0.0	73.0	1190	91.9	94.3	95.1	0.65	0.75	0.80	247
160	220	355M/L	157	6.2	1.9	2.1	9.53	72	158	1485	73.0	1190	92.2	94.4	95.2	0.65	0.75	0.80	264
185	250	355M/L	182	6.0	1.9	2.1	10.2	76	167	1530	73.0	1190	91.7	94.0	94.7	0.65	0.76	0.79	310
200	270	355M/L	197	6.3	2.1	2.3	12.4	85	187	1700	73.0	1190	92.3	94.3	94.7	0.66	0.77	0.80	331
220	300	355M/L	216	6.5	2.0	2.3	13.8	72	158	1795	73.0	1190	92.0	94.4	95.1	0.65	0.75	0.80	363
250	340	355M/L	245	6.1	2.2	2.2	14.8	64	141	1830	73.0	1190	92.7	94.9	95.6	0.67	0.77	0.81	405
260	350	355M/L	255	6.1	2.1	2.1	14.8	64	141	1830	73.0	1190	92.8	94.9	95.6	0.67	0.77	0.81	421
280	380	355M/L	275	6.0	2.1	2.2	14.8	54	119	1830	73.0	1185	93.4	95.1	95.5	0.67	0.77	0.80	460
300	400	355M/L*	295	6.4	2.1	2.1	14.8	39	86	1920	73.0	1190	93.0	95.2	95.7	0.61	0.72	0.78	504
315	430	355M/L*	310	6.0	1.9	1.9	15.5	38	84	1950	73.0	1185	93.2	95.4	95.9	0.66	0.77	0.81	509
High-Output Design																			
0.25	0.33	80	0.260	4.6	2.5	2.9	0.0022	19	42	13.5	43.0	1155	50.0	58.2	63.0	0.41	0.50	0.60	0.830
0.75	1	90L	0.800	4.2	1.9	2.0	0.0045	16	35	19.1	45.0	1120	68.4	71.1	71.3	0.53	0.66	0.75	1.76
1.5	2	112M	1.55	5.5	2.2	2.2	0.0150	15	33	36.0	52.0	1110	76.9	79.1	79.3	0.50	0.63	0.71	3.34
3	4	112M	3.04	6.3	2.6	2.6	0.0257	10	22	46.0	52.0	1165	74.0	78.3	80.7	0.50	0.61	0.69	6.76
3	4	132M	3.06	5.3	2.0	2.2	0.0340	20	44	55.0	53.0	1160	77.1	79.8	80.6	0.52	0.65	0.73	6.40
4	5.5	132S	4.06	5.8	2.3	2.4	0.0446	19	42	59.0	53.0	1165	79.9	82.0	82.5	0.52	0.64	0.72	8.45
7.5	10	160L	7.57	5.7	2.2	2.5	0.1077	11	24	100	56.0	1170	84.3	86.2	86.2	0.61	0.74	0.81	13.5
9.2	12.5	160M	9.29	6.0	2.0	2.6	0.1293	10	22	115	56.0	1170	84.3	86.5	86.7	0.61	0.74	0.81	16.4
18.5	25	200M	18.5	6.0	2.1	2.5	0.3408	11	24	213	58.0	1175	87.4	89.5	89.7	0.62	0.74	0.80	32.4
22	30	200M	22.0	6.0	2.3	2.4	0.4037	14	31	235	58.0	1175	87.8	89.9	90.5	0.67	0.77	0.82	37.2
37	50	225S/M	36.8	7.5	2.7	2.6	1.16	18	40	440	61.0	1180	89.4	91.1	91.9	0.74	0.83	0.86	58.8
45	60	250S/M	44.5	8.0	2.8	2.8	1.43	18	40	490	61.0	1180	89.2	91.2	91.9	0.73	0.83	0.86	71.5
75	100	280S/M	74.2	6.7	2.3	2.5	3.22	20	44	768	66.0	1185	90.4	92.5	93.0	0.68	0.79	0.84	120
90	125	280S/M	89.0	6.3	2.1	2.3	3.57	18	40	818	66.0	1180	91.0	92.9	93.3	0.68	0.79	0.83	146
132	175	355M/L	130	6.1	2.0	2.3	7.89	90	198	1385	73.0	1190	91.8	93.9	94.5	0.63	0.73	0.79	222



# W21 Cast Iron Frame IE1

Output		Frame	Full Load Torque (kgfm)	Locked Rotor Current I/In	Locked Rotor Torque Tl/Tn	Break-down Torque Tb/Tn	Inertia J (kgm²)	Allowable locked rotor time (s)		Weight (kg)	Sound dB(A)	400 V								
												Rated speed (rpm)	% of full load			Full load current In (A)				
													Efficiency			Power Factor				
kW	HP							Hot	Cold			50	75	100	50	75	100			
8P-750rpm-50HZ																				
0.25	0.33	80	0.350	3.5	2.3	2.2	0.0028	24	53	14.2	42.0	700	46.1	53.6	56.6	0.42	0.52	0.61	1.05	
0.37	0.5	90S	0.530	3.0	1.9	1.8	0.0039	32	70	15.4	43.0	685	50.6	56.5	57.4	0.44	0.55	0.64	1.45	
0.55	0.75	90L	0.790	3.3	1.9	2.0	0.0056	25	55	16.5	43.0	675	58.0	60.0	60.0	0.43	0.56	0.66	2.01	
0.75	1	100L	1.04	3.5	1.8	2.4	0.0079	33	73	23.8	50.0	705	62.0	67.2	67.8	0.42	0.53	0.62	2.58	
1.1	1.5	100L	1.53	4.0	1.7	2.3	0.0118	27	59	28.5	50.0	700	69.3	72.3	71.2	0.45	0.57	0.66	3.38	
1.5	2	112M	2.09	4.2	2.2	2.2	0.0178	26	57	33.4	46.0	700	73.7	75.4	73.5	0.48	0.61	0.70	4.21	
2.2	3	132S	3.02	6.1	2.5	2.8	0.0602	22	48	55.3	48.0	710	75.8	78.0	77.1	0.55	0.68	0.77	5.35	
3	4	132M	4.12	6.1	2.2	2.6	0.0728	18	40	65.0	48.0	710	78.5	80.1	79.0	0.55	0.68	0.76	7.21	
4	5.5	160M	5.37	4.7	2.2	2.4	0.1006	18	40	97.0	51.0	725	80.0	82.0	82.0	0.50	0.63	0.72	9.78	
5.5	7.5	160M	7.39	4.8	2.2	2.3	0.1221	18	40	107	51.0	725	81.0	83.0	83.5	0.48	0.62	0.71	13.4	
7.5	10	160L	10.1	4.7	2.2	2.3	0.1508	16	35	122	51.0	725	83.0	85.0	85.5	0.50	0.64	0.73	17.3	
9.2	12.5	180M	12.4	7.0	2.2	2.9	0.2344	11	24	163	51.0	725	83.0	86.0	85.9	0.64	0.75	0.81	19.1	
11	15	180L	14.8	6.8	2.3	2.5	0.2758	11	24	175	51.0	725	87.0	88.5	88.3	0.68	0.79	0.84	21.4	
18.5	25	225S/M	24.7	6.9	2.1	2.8	0.8328	17	37	341	60.0	730	88.5	90.1	90.0	0.72	0.80	0.85	34.9	
22	30	225S/M	29.4	7.5	2.2	2.7	0.9716	19	42	365	60.0	730	89.0	91.0	91.0	0.73	0.82	0.85	41.1	
30	40	250S/M	40.0	7.9	2.3	2.9	1.16	17	37	440	60.0	730	89.5	91.2	91.6	0.70	0.79	0.84	56.3	
37	50	280S/M	48.7	6.5	1.9	2.3	2.07	29	64	570	62.0	740	90.5	92.2	92.3	0.65	0.75	0.79	73.2	
45	60	280S/M	59.2	6.5	2.0	2.4	2.53	26	57	624	62.0	740	90.5	92.1	92.3	0.65	0.75	0.80	88.0	
55	75	315S/M	72.4	6.5	1.9	2.2	3.05	27	59	745	62.0	740	91.2	93.1	93.0	0.69	0.78	0.82	104	
75	100	315S/M	98.7	6.6	1.9	2.2	4.37	20	44	876	62.0	740	92.0	93.4	93.5	0.67	0.79	0.82	141	
90	125	315S/M	118	6.8	2.1	2.4	5.29	23	51	985	62.0	740	92.5	93.8	94.2	0.65	0.76	0.81	170	
110	150	355M/L	145	6.4	1.5	2.2	12.2	41	90	1390	70.0	740	92.5	94.1	94.5	0.63	0.74	0.80	210	
132	175	355M/L	174	6.5	1.6	2.2	12.8	47	103	1445	70.0	740	93.0	94.5	94.8	0.63	0.73	0.79	254	
150	200	355M/L	197	6.5	1.6	2.2	14.3	40	88	1570	70.0	740	93.0	94.7	94.7	0.61	0.72	0.78	293	
160	220	355M/L	211	6.6	1.6	2.2	15.9	42	92	1620	70.0	740	93.3	94.7	94.7	0.64	0.75	0.80	305	
185	250	355M/L	244	6.5	1.6	2.2	16.7	30	66	1730	70.0	740	93.0	94.6	95.1	0.60	0.71	0.78	360	
200	270	355M/L	263	6.8	1.6	2.1	18.9	37	81	1830	70.0	740	93.3	94.6	95.2	0.60	0.72	0.79	384	
220	300	355M/L*	290	6.5	1.6	2.1	19.8	35	77	1930	70.0	740	93.4	94.7	95.2	0.62	0.73	0.78	428	
High-Output Design																				
2.2	3	132M	3.02	6.1	2.5	2.8	0.0602	22	48	55.3	48.0	710	75.8	78.0	77.1	0.55	0.68	0.77	5.35	
5.5	7.5	160L	7.39	4.8	2.2	2.3	0.1221	18	40	107	51.0	725	81.0	83.0	83.5	0.48	0.62	0.71	13.4	
7.5	10	160M	10.1	4.7	2.2	2.3	0.1508	16	35	122	51.0	725	83.0	85.0	85.5	0.50	0.64	0.73	17.3	
18.5	25	250S/M	24.7	6.9	2.1	2.8	0.8328	17	37	341	60.0	730	88.5	90.1	90.0	0.72	0.80	0.85	34.9	
22	30	250S/M	29.4	7.5	2.2	2.7	0.9716	19	42	365	60.0	730	89.0	91.0	91.0	0.73	0.82	0.85	41.1	
30	40	225S/M	40.0	7.9	2.3	2.9	1.16	17	37	440	60.0	730	89.5	91.2	91.6	0.70	0.79	0.84	56.3	
37	50	250S/M	49.4	8.2	2.3	2.8	1.48	13	29	455	60.0	730	89.0	91.5	91.5	0.68	0.78	0.84	69.5	
45	60	250S/M*	60.0	8.3	2.5	3.4	1.67	8	18	530	60.0	730	90.0	91.0	91.5	0.67	0.78	0.83	85.5	
55	75	280S/M	72.4	6.5	1.9	2.2	3.05	27	59	745	62.0	740	91.2	93.1	93.0	0.69	0.78	0.82	104	
75	100	280S/M	98.7	6.6	1.9	2.2	4.37	20	44	876	62.0	740	92.0	93.4	93.5	0.67	0.79	0.82	141	
110	150	315S/M*	145	7.0	1.9	2.2	5.53	14	31	970	62.0	740	92.5	94.1	94.6	0.61	0.73	0.79	212	

# W21 Cast Iron Frame IE1

Output		380 V									415 V								
		Rated speed (rpm)	% of full load						Full load current In (A)	Rated speed (rpm)	% of full load						Full load current In (A)		
			Efficiency			Power Factor					Efficiency			Power Factor					
kW	HP	50	75	100	50	75	100	50	75	100	50	75	100	50	75	100			
8P-750rpm-50HZ																			
0.25	0.33	690	49.0	55.6	57.2	0.45	0.56	0.65	1.02	700	43.1	51.7	55.6	0.40	0.50	0.58	1.08		
0.37	0.5	680	54.4	59.0	58.3	0.48	0.60	0.69	1.40	690	46.6	53.8	56.1	0.41	0.51	0.61	1.50		
0.55	0.75	665	61.7	62.0	60.0	0.47	0.60	0.70	1.99	680	54.8	59.0	59.0	0.41	0.52	0.62	2.09		
0.75	1	695	65.6	69.0	68.0	0.46	0.58	0.66	2.54	710	58.3	64.6	66.7	0.39	0.49	0.58	2.70		
1.1	1.5	690	72.1	73.6	70.8	0.50	0.62	0.70	3.37	705	66.2	70.7	70.7	0.41	0.53	0.62	3.49		
1.5	2	690	75.9	76.2	73.2	0.52	0.65	0.73	4.27	705	71.6	74.2	73.1	0.44	0.57	0.66	4.33		
2.2	3	705	77.1	78.3	76.7	0.60	0.73	0.80	5.45	715	74.7	77.5	77.1	0.52	0.65	0.74	5.36		
3	4	705	79.7	80.5	78.6	0.60	0.73	0.80	7.25	715	77.1	79.6	79.0	0.51	0.64	0.73	7.24		
4	5.5	720	81.0	83.0	82.0	0.54	0.67	0.75	9.88	725	78.5	82.0	82.5	0.46	0.60	0.69	9.78		
5.5	7.5	720	82.0	84.0	83.0	0.54	0.67	0.74	13.6	725	80.0	82.5	83.0	0.45	0.58	0.68	13.6		
7.5	10	715	84.0	85.0	85.0	0.56	0.69	0.76	17.6	725	81.0	84.0	85.5	0.47	0.60	0.70	17.4		
9.2	12.5	720	84.0	86.1	85.5	0.69	0.79	0.84	19.5	725	82.0	85.9	85.9	0.59	0.72	0.79	18.9		
11	15	720	87.5	88.3	87.8	0.71	0.81	0.85	22.4	730	86.5	88.6	88.5	0.65	0.77	0.83	20.8		
18.5	25	730	88.8	90.0	89.8	0.75	0.83	0.86	36.4	735	88.2	90.3	90.2	0.68	0.78	0.84	34.0		
22	30	730	89.4	90.9	90.5	0.76	0.84	0.86	42.9	735	88.6	91.0	91.2	0.71	0.80	0.84	40.0		
30	40	730	90.0	91.3	91.3	0.73	0.81	0.85	58.7	735	89.0	91.1	91.8	0.66	0.77	0.83	54.8		
37	50	735	91.0	92.2	92.1	0.68	0.77	0.80	76.3	740	90.0	92.2	92.4	0.63	0.73	0.77	72.3		
45	60	735	91.0	92.2	92.0	0.70	0.77	0.82	90.6	740	90.0	92.0	92.3	0.60	0.72	0.78	87.0		
55	75	735	91.6	93.2	92.8	0.72	0.80	0.83	108	740	90.7	93.0	93.0	0.65	0.76	0.80	103		
75	100	735	92.4	93.3	93.3	0.70	0.80	0.83	147	740	91.6	93.4	93.4	0.64	0.78	0.81	138		
90	125	735	92.9	93.9	94.0	0.70	0.79	0.82	177	740	92.1	93.7	94.2	0.63	0.74	0.80	166		
110	150	740	93.0	94.2	94.5	0.66	0.77	0.82	216	745	92.0	94.1	94.5	0.60	0.71	0.78	208		
132	175	740	93.5	94.6	94.8	0.66	0.75	0.81	261	745	92.5	94.4	94.8	0.60	0.71	0.77	252		
150	200	740	93.5	94.8	94.7	0.66	0.76	0.80	301	745	92.5	94.7	94.7	0.57	0.69	0.76	290		
160	220	740	93.8	94.8	94.8	0.68	0.77	0.81	317	745	92.8	94.7	94.7	0.60	0.72	0.79	298		
185	250	740	93.5	94.7	95.1	0.65	0.75	0.80	369	745	92.5	94.5	95.0	0.55	0.67	0.76	356		
200	270	740	93.8	94.8	95.1	0.65	0.75	0.81	394	745	92.8	94.4	95.2	0.56	0.69	0.77	380		
220	300	740	93.8	94.8	95.2	0.66	0.76	0.80	439	745	93.0	94.6	95.2	0.58	0.70	0.76	423		
High-Output Design																			
2.2	3	705	77.1	78.3	76.7	0.60	0.73	0.80	5.45	715	74.7	77.5	77.1	0.52	0.65	0.74	5.36		
5.5	7.5	720	82.0	84.0	83.0	0.54	0.67	0.74	13.6	725	80.0	82.5	83.0	0.45	0.58	0.68	13.6		
7.5	10	715	84.0	85.0	85.0	0.56	0.69	0.76	17.6	725	81.0	84.0	85.5	0.47	0.60	0.70	17.4		
18.5	25	730	88.8	90.0	89.8	0.75	0.83	0.86	36.4	735	88.2	90.3	90.2	0.68	0.78	0.84	34.0		
22	30	730	89.4	90.9	90.5	0.76	0.84	0.86	42.9	735	88.6	91.0	91.2	0.71	0.80	0.84	40.0		
30	40	730	90.0	91.3	91.3	0.73	0.81	0.85	58.7	735	89.0	91.1	91.8	0.66	0.77	0.83	54.8		
37	50	730	89.5	91.5	91.0	0.72	0.82	0.86	71.8	735	88.5	91.5	91.5	0.64	0.76	0.82	68.6		
45	60	730	90.5	91.0	91.2	0.69	0.80	0.85	88.2	735	89.5	91.0	91.6	0.65	0.76	0.82	83.3		
55	75	735	91.6	93.2	92.8	0.72	0.80	0.83	108	740	90.7	93.0	93.0	0.65	0.76	0.80	103		
75	100	735	92.4	93.3	93.3	0.70	0.80	0.83	147	740	91.6	93.4	93.4	0.64	0.78	0.81	138		
110	150	735	93.0	94.1	94.4	0.66	0.75	0.80	221	740	92.0	94.1	94.6	0.56	0.71	0.77	210		



# W21 Cast Iron Frame IE1

Output		Frame	Full Load Torque (kgfm)	Locked Rotor Current I <sub>L</sub> /I <sub>n</sub>	Locked Rotor Torque T <sub>L</sub> /T <sub>n</sub>	Break-down Torque T <sub>b</sub> /T <sub>n</sub>	Inertia J (kgm <sup>2</sup> )	Allowable locked rotor time (s)		Weight (kg)	Sound dB(A)	460 V 60Hz								
												Rated speed (rpm)	% of full load			Full load current I <sub>n</sub> (A)				
													Efficiency				Power Factor			
kW	HP							Hot	Cold			50	75	100	50	75	100			
8P-750rpm-60HZ																				
0.25	0.33	80	0.350	3.5	2.3	2.2	0.0028	24	53	14.2	42.0	855	47.6	55.4	59.2	0.39	0.47	0.56	0.946	
0.37	0.5	90S	0.530	3.0	1.9	1.8	0.0039	32	70	15.4	43.0	845	53.0	59.1	61.1	0.40	0.50	0.59	1.29	
0.55	0.75	90L	0.790	3.3	1.9	2.0	0.0056	25	55	16.5	43.0	830	60.8	65.1	64.5	0.40	0.51	0.61	1.76	
0.75	1	100L	1.04	3.5	1.8	2.4	0.0079	33	73	23.8	50.0	855	64.6	69.6	71.0	0.40	0.50	0.59	2.25	
1.1	1.5	100L	1.53	4.0	1.7	2.3	0.0118	27	59	28.5	50.0	860	71.9	75.0	74.8	0.43	0.55	0.63	2.93	
1.5	2	112M	2.09	4.2	2.2	2.2	0.0178	26	57	33.4	46.0	855	76.1	78.4	77.5	0.45	0.58	0.66	3.68	
2.2	3	132S	3.02	6.1	2.5	2.8	0.0602	22	48	55.3	48.0	865	76.9	79.3	79.4	0.52	0.66	0.74	4.70	
3	4	132M	4.12	6.1	2.2	2.6	0.0728	18	40	65.0	48.0	865	79.9	81.7	81.4	0.53	0.66	0.75	6.17	
4	5.5	160M	5.37	4.7	2.2	2.4	0.1006	18	40	97.0	51.0	875	79.9	83.4	84.2	0.46	0.59	0.68	8.77	
5.5	7.5	160M	7.39	4.8	2.2	2.3	0.1221	18	40	107	51.0	875	80.5	84.0	84.7	0.47	0.60	0.69	11.8	
7.5	10	160L	10.1	4.7	2.2	2.3	0.1508	16	35	122	51.0	875	82.5	85.7	86.2	0.48	0.61	0.70	15.6	
9.2	12.5	180M	12.4	7.0	2.2	2.9	0.2344	11	24	163	51.0	870	82.5	85.0	85.8	0.61	0.74	0.80	16.8	
11	15	180L	14.8	6.8	2.3	2.5	0.2758	11	24	175	51.0	875	82.5	86.0	88.1	0.65	0.76	0.82	19.1	
18.5	25	225S/M	24.7	6.9	2.1	2.8	0.8328	17	37	341	60.0	875	87.9	89.7	90.2	0.68	0.79	0.84	30.6	
22	30	225S/M	29.4	7.5	2.2	2.7	0.9716	19	42	365	60.0	880	88.5	90.4	91.1	0.70	0.80	0.84	36.1	
30	40	250S/M	40.0	7.9	2.3	2.9	1.16	17	37	440	60.0	880	88.2	90.6	91.6	0.65	0.77	0.82	50.1	
37	50	280S/M	48.7	6.5	1.9	2.3	2.07	29	64	570	62.0	885	89.6	91.9	92.4	0.62	0.73	0.78	64.4	
45	60	280S/M	59.2	6.5	2.0	2.4	2.53	26	57	624	62.0	885	89.4	91.8	92.4	0.63	0.74	0.79	77.4	
55	75	315S/M	72.4	6.5	1.9	2.2	3.05	27	59	745	62.0	885	90.4	92.6	93.2	0.64	0.76	0.81	91.4	
75	100	315S/M	98.7	6.6	1.9	2.2	4.37	20	44	876	62.0	885	91.0	93.2	93.6	0.64	0.76	0.81	124	
90	125	315S/M	118	6.8	2.1	2.4	5.29	23	51	985	62.0	885	91.3	93.5	94.1	0.65	0.76	0.81	148	
110	150	355M/L	145	6.4	1.5	2.2	12.2	41	90	1390	70.0	890	91.4	93.9	94.5	0.60	0.72	0.78	187	
132	175	355M/L	174	6.5	1.6	2.2	12.8	47	103	1445	70.0	890	91.8	94.3	94.8	0.60	0.71	0.77	227	
150	200	355M/L	197	6.5	1.6	2.2	14.3	40	88	1570	70.0	890	92.0	94.3	94.8	0.59	0.70	0.77	258	
160	220	355M/L	211	6.6	1.6	2.2	15.9	42	92	1620	70.0	890	92.3	94.4	94.8	0.62	0.73	0.78	272	
185	250	355M/L	244	6.5	1.6	2.2	16.7	30	66	1730	70.0	890	91.5	94.2	95.0	0.56	0.68	0.76	322	
200	270	355M/L	263	6.8	1.6	2.1	18.9	37	81	1830	70.0	890	92.0	94.4	95.1	0.58	0.69	0.76	347	
220	300	355M/L*	290	6.5	1.6	2.1	19.8	35	77	1930	70.0	890	92.2	94.5	95.1	0.60	0.70	0.76	382	
High-Output Design																				
2.2	3	132M	3.02	6.1	2.5	2.8	0.0602	22	48	55.3	48.0	865	76.9	79.3	79.4	0.52	0.66	0.74	4.70	
5.5	7.5	160L	7.39	4.8	2.2	2.3	0.1221	18	40	107	51.0	875	80.5	84.0	84.7	0.47	0.60	0.69	11.8	
7.5	10	160M	10.1	4.7	2.2	2.3	0.1508	16	35	122	51.0	875	82.5	85.7	86.2	0.48	0.61	0.70	15.6	
18.5	25	250S/M	24.7	6.9	2.1	2.8	0.8328	17	37	341	60.0	875	87.9	89.7	90.2	0.68	0.79	0.84	30.6	
22	30	250S/M	29.4	7.5	2.2	2.7	0.9716	19	42	365	60.0	880	88.5	90.4	91.1	0.70	0.80	0.84	36.1	
30	40	225S/M	40.0	7.9	2.3	2.9	1.16	17	37	440	60.0	880	88.2	90.6	91.6	0.65	0.77	0.82	50.1	
37	50	250S/M	49.4	8.2	2.3	2.8	1.48	13	29	455	60.0	880	88.5	90.8	91.4	0.64	0.76	0.82	62.0	
45	60	250S/M*	60.0	8.3	2.5	3.4	1.67	8	18	530	60.0	885	88.9	91.1	92.0	0.64	0.75	0.81	75.8	
55	75	280S/M	72.4	6.5	1.9	2.2	3.05	27	59	745	62.0	885	90.4	92.6	93.2	0.64	0.76	0.81	91.4	
75	100	280S/M	98.7	6.6	1.9	2.2	4.37	20	44	876	62.0	885	91.0	93.2	93.6	0.64	0.76	0.81	124	
110	150	315S/M*	145	7.0	1.9	2.2	5.53	14	31	970	62.0	885	91.3	93.8	94.5	0.60	0.71	0.77	190	

# W21 Cast Iron Frame IE2

Output		Frame	Full Load Torque (kgfm)	Locked Rotor Current I <sub>L</sub> /I <sub>n</sub>	Locked Rotor Torque T <sub>L</sub> /T <sub>n</sub>	Break-down Torque T <sub>b</sub> /T <sub>n</sub>	Inertia J (kgm <sup>2</sup> )	Allowable locked rotor time (s)		Weight (kg)	Sound dB(A)	400 V							Full load current I <sub>n</sub> (A)
								Rated speed (rpm)	% of full load			Power Factor							
									Efficiency			Power Factor							
kW	HP							Hot	Cold			50	75	100	50	75	100		
2P-3000rpm-50HZ																			
0.75	1	80	0.260	6.5	2.8	2.8	0.0007	14	31	12.5	59.0	2800	76.0	78.5	79.5	0.67	0.80	0.86	1.58
1.1	1.5	80	0.380	6.5	2.8	2.8	0.0008	10	22	14.0	59.0	2790	78.0	80.0	80.0	0.67	0.79	0.85	2.33
1.5	2	90S	0.520	7.0	2.6	2.6	0.0016	12	26	17.5	62.0	2825	81.5	82.0	82.0	0.66	0.78	0.84	3.14
2.2	3	90L	0.750	6.6	3.0	3.0	0.0022	9	20	21.0	62.0	2840	83.0	83.6	83.6	0.63	0.76	0.83	4.58
3	4	100L	1.01	8.0	2.4	2.8	0.0051	7	15	38.5	67.0	2880	84.0	85.0	85.0	0.70	0.81	0.86	5.92
4	5.5	112M	1.35	7.0	2.0	2.8	0.0066	10	22	38.0	64.0	2880	86.0	86.0	86.0	0.73	0.83	0.88	7.63
5.5	7.5	132S	1.84	6.8	2.2	3.0	0.0162	17	37	60.0	67.0	2910	86.5	88.0	88.0	0.68	0.79	0.85	10.6
7.5	10	132S	2.51	6.8	2.2	2.9	0.0198	13	29	63.0	67.0	2910	88.0	88.5	88.5	0.72	0.82	0.87	14.1
9.2	12.5	132M	3.07	7.6	2.5	3.2	0.0234	10	22	70.0	67.0	2915	88.5	89.0	89.0	0.70	0.81	0.86	17.3
11	15	160M	3.63	7.5	2.5	3.3	0.0421	10	22	85.0	70.0	2950	89.0	90.0	90.0	0.70	0.80	0.85	20.8
15	20	160M	4.98	7.5	2.4	3.3	0.0000	10	22	100	70.0	2935	90.0	90.7	90.7	0.74	0.83	0.87	27.4
18.5	25	160L	6.13	8.5	2.5	3.2	0.0000	8	18	120	70.0	2940	91.0	91.2	91.2	0.73	0.83	0.85	34.4
22	30	180M	7.29	7.8	2.5	3.3	0.0975	10	22	180	70.0	2940	91.5	91.6	91.6	0.73	0.82	0.85	40.8
30	40	200L	9.89	6.0	2.0	2.5	0.1532	18	40	190	74.0	2955	90.0	91.5	92.2	0.70	0.80	0.84	55.9
37	50	200L	12.2	7.0	2.6	2.7	0.1703	12	26	210	74.0	2955	91.9	93.1	93.1	0.74	0.83	0.86	66.7
45	60	225S/M	14.8	7.5	2.5	3.2	0.3409	12	26	390	82.0	2960	92.0	93.1	93.1	0.78	0.86	0.88	79.3
55	75	250S/M	18.0	8.9	2.6	3.4	0.3934	12	26	420	82.0	2970	93.0	93.3	93.3	0.79	0.85	0.89	95.6
75	100	280S/M	24.5	7.5	2.2	2.7	0.9278	28	62	600	83.0	2975	93.0	94.0	94.0	0.79	0.84	0.87	132
90	125	280S/M	29.5	7.5	2.2	2.8	1.10	25	55	715	83.0	2975	93.0	94.3	94.3	0.77	0.84	0.87	158
110	150	315S/M	36.0	7.0	2.3	2.6	1.20	20	44	770	83.0	2975	94.0	94.6	94.6	0.82	0.87	0.89	189
132	175	315S/M	43.2	7.8	2.2	2.7	1.41	12	26	830	83.0	2975	94.0	94.7	94.7	0.80	0.87	0.89	226
150	200	315S/M	49.1	8.0	2.7	2.7	0.0000	15	33	900	83.0	2975	94.9	95.0	95.0	0.80	0.87	0.90	253
160	220	315S/M	52.4	7.8	2.2	2.8	1.68	12	26	900	83.0	2975	94.8	95.1	95.1	0.81	0.88	0.90	270
185	250	315S/M	60.4	8.2	2.4	3.0	0.0000	10	22	1000	83.0	2985	95.0	95.2	95.2	0.80	0.86	0.88	319
200	270	315S/M	65.5	7.9	2.4	3.2	2.01	12	26	1050	83.0	2975	95.1	95.3	95.3	0.80	0.87	0.88	344
200	270	355M/L	65.3	7.2	1.8	2.7	4.29	30	66	1420	81.0	2985	95.0	95.4	95.4	0.89	0.90	0.91	333
220	300	355M/L	71.8	8.5	2.2	2.8	4.50	20	44	1500	81.0	2985	95.0	95.5	95.5	0.85	0.90	0.91	365
250	340	355M/L	81.6	7.8	2.2	2.5	4.83	30	66	1650	81.0	2985	95.4	95.6	95.6	0.86	0.89	0.90	419
280	380	355M/L	91.4	8.5	2.3	2.7	5.90	25	55	1850	81.0	2985	95.0	95.6	95.6	0.89	0.91	0.92	462
300	400	355M/L	97.9	7.8	2.0	2.6	5.90	40	88	1850	83.0	2985	95.5	95.8	95.8	0.85	0.90	0.90	502
315	430	355M/L	103	7.6	2.1	2.6	5.90	40	88	1850	83.0	2980	95.5	95.8	95.8	0.86	0.90	0.91	522
330	450	355M/L*	108	7.8	2.0	2.5	5.90	40	88	1850	83.0	2980	95.5	95.8	95.8	0.87	0.90	0.91	546
High-Output Design																			
1.5	2	90L	0.520	7.0	2.6	2.6	0.0016	12	26	17.5	62.0	2825	81.5	82.0	82.0	0.66	0.78	0.84	3.14
2.2	3	100L	0.740	7.5	2.6	3.0	0.0043	15	33	26.5	67.0	2885	82.5	83.6	83.6	0.66	0.78	0.85	4.47
5.5	7.5	112M	1.86	7.3	2.7	3.0	0.0088	11	24	42.0	64.0	2880	86.5	87.0	87.0	0.72	0.82	0.87	10.5
5.5	7.5	132M	1.84	6.8	2.2	3.0	0.0162	17	37	60.0	67.0	2910	86.5	88.0	88.0	0.68	0.79	0.85	10.6
7.5	10	132M	2.51	6.8	2.2	2.9	0.0198	13	29	63.0	67.0	2910	88.0	88.5	88.5	0.72	0.82	0.87	14.1
11	15	160L	3.63	7.5	2.5	3.3	0.0421	10	22	85.0	70.0	2950	89.0	90.0	90.0	0.70	0.80	0.85	20.8
15	20	160L	4.98	7.5	2.4	3.3	0.0000	10	22	100	70.0	2935	90.0	90.7	90.7	0.74	0.83	0.87	27.4
22	30	180L	7.29	7.8	2.5	3.3	0.0975	10	22	180	70.0	2940	91.5	91.6	91.6	0.73	0.82	0.85	40.8
75	100	250S/M	24.7	8.5	2.9	3.4	0.0000	8	18	540	82.0	2955	93.6	94.0	94.0	0.83	0.87	0.89	129
110	150	280S/M	36.0	7.0	2.3	2.6	1.20	20	44	770	83.0	2975	94.0	94.6	94.6	0.82	0.87	0.89	189



## W21 Cast Iron Frame IE2

Output		380 V								415 V							
		Rated speed (rpm)	% of full load						Full load current In (A)	Rated speed (rpm)	% of full load						Full load current In (A)
			Efficiency			Power Factor					Efficiency			Power Factor			
kW	HP	50	75	100	50	75	100	50	75	100	50	75	100	50	75	100	
2P-3000rpm-50HZ																	
0.75	1	2770	77.7	78.0	78.0	0.66	0.81	0.87	1.68	2810	75.0	78.5	79.5	0.64	0.77	0.84	1.56
1.1	1.5	2765	78.9	79.2	79.6	0.73	0.83	0.87	2.43	2805	77.1	80.2	80.2	0.62	0.75	0.82	2.33
1.5	2	2800	82.0	81.6	81.6	0.71	0.81	0.86	3.25	2840	80.8	81.9	82.5	0.61	0.75	0.82	3.08
2.2	3	2820	83.7	83.5	83.2	0.69	0.80	0.85	4.75	2855	82.2	83.4	83.9	0.59	0.72	0.80	4.56
3	4	2865	84.9	85.0	85.0	0.76	0.85	0.88	6.09	2890	83.1	84.6	85.0	0.66	0.78	0.84	5.85
4	5.5	2865	86.6	86.0	85.8	0.78	0.87	0.90	7.90	2890	85.3	85.9	86.3	0.69	0.80	0.86	7.50
5.5	7.5	2900	87.1	88.0	87.6	0.74	0.83	0.88	10.8	2915	85.6	87.6	88.0	0.63	0.76	0.83	10.5
7.5	10	2900	88.4	88.4	88.1	0.77	0.85	0.89	14.5	2915	87.3	88.3	88.7	0.67	0.79	0.85	13.8
9.2	12.5	2905	89.1	89.0	89.0	0.75	0.85	0.89	17.6	2920	87.6	88.6	89.0	0.65	0.77	0.84	17.1
11	15	2945	90.0	90.1	90.1	0.74	0.83	0.87	21.3	2955	89.0	90.2	90.2	0.65	0.76	0.83	20.4
15	20	2925	91.0	91.0	91.0	0.78	0.85	0.88	28.5	2940	90.0	91.1	91.1	0.70	0.80	0.85	26.9
18.5	25	2930	91.0	91.1	91.1	0.78	0.86	0.87	35.5	2945	91.2	91.4	91.4	0.69	0.80	0.83	33.9
22	30	2935	91.2	91.5	91.5	0.77	0.84	0.86	42.5	2945	91.5	91.6	91.6	0.70	0.80	0.84	39.8
30	40	2950	90.0	91.5	92.0	0.75	0.83	0.86	58.9	2960	90.0	91.5	92.3	0.65	0.77	0.82	55.1
37	50	2950	92.4	92.9	92.9	0.80	0.86	0.89	68.0	2960	91.3	93.1	93.1	0.69	0.79	0.84	65.8
45	60	2955	92.2	93.0	93.0	0.80	0.87	0.89	82.6	2965	91.9	93.3	93.3	0.75	0.85	0.87	77.1
55	75	2960	93.0	93.1	93.2	0.81	0.87	0.90	99.6	2970	93.0	93.3	93.3	0.76	0.83	0.88	93.2
75	100	2970	93.0	93.8	93.9	0.81	0.85	0.88	138	2975	93.0	94.0	94.0	0.77	0.83	0.86	129
90	125	2970	93.0	94.3	94.3	0.80	0.85	0.88	165	2975	93.2	94.5	94.5	0.75	0.82	0.86	154
110	150	2970	94.1	94.4	94.4	0.84	0.88	0.90	197	2975	93.9	94.6	94.6	0.80	0.86	0.88	184
132	175	2970	94.1	94.6	94.6	0.83	0.89	0.90	236	2980	93.9	94.9	94.9	0.78	0.86	0.88	220
150	200	2970	94.5	94.9	94.9	0.83	0.88	0.90	267	2975	94.7	95.0	95.0	0.78	0.86	0.89	247
160	220	2970	94.9	95.0	95.0	0.84	0.89	0.91	281	2975	94.8	95.1	95.1	0.79	0.87	0.89	263
185	250	2980	94.9	95.1	95.1	0.83	0.88	0.89	332	2985	95.0	95.2	95.2	0.78	0.85	0.87	311
200	270	2970	95.0	95.2	95.2	0.82	0.88	0.89	359	2980	95.1	95.3	95.3	0.78	0.85	0.87	336
200	270	2980	95.2	95.3	95.3	0.89	0.91	0.92	347	2985	95.1	95.4	95.4	0.87	0.89	0.90	324
220	300	2980	95.1	95.4	95.4	0.87	0.90	0.92	381	2985	95.1	95.5	95.5	0.84	0.90	0.91	352
250	340	2980	95.2	95.4	95.4	0.88	0.90	0.91	438	2985	95.5	95.6	95.6	0.85	0.88	0.89	409
280	380	2980	95.2	95.6	95.6	0.90	0.92	0.92	488	2985	94.8	95.6	95.7	0.88	0.90	0.92	445
300	400	2980	95.6	95.8	95.8	0.87	0.90	0.91	523	2985	95.4	95.8	95.9	0.84	0.89	0.89	489
315	430	2980	95.6	95.8	95.8	0.88	0.91	0.92	543	2985	95.4	95.8	95.9	0.84	0.89	0.90	508
330	450	2980	95.6	95.8	95.8	0.88	0.91	0.92	569	2980	95.4	95.8	95.9	0.85	0.90	0.91	526
High-Output Design																	
1.5	2	2800	82.0	81.6	81.6	0.71	0.81	0.86	3.25	2840	80.8	81.9	82.5	0.61	0.75	0.82	3.08
2.2	3	2870	83.3	83.8	83.2	0.71	0.82	0.87	4.62	2895	81.5	83.2	83.6	0.62	0.75	0.82	4.46
5.5	7.5	2865	87.0	86.9	87.0	0.76	0.86	0.89	10.8	2885	85.9	86.8	87.2	0.67	0.79	0.85	10.3
5.5	7.5	2900	87.1	88.0	87.6	0.74	0.83	0.88	10.8	2915	85.6	87.6	88.0	0.63	0.76	0.83	10.5
7.5	10	2900	88.4	88.4	88.1	0.77	0.85	0.89	14.5	2915	87.3	88.3	88.7	0.67	0.79	0.85	13.8
11	15	2945	90.0	90.1	90.1	0.74	0.83	0.87	21.3	2955	89.0	90.2	90.2	0.65	0.76	0.83	20.4
15	20	2925	91.0	91.0	91.0	0.78	0.85	0.88	28.5	2940	90.0	91.1	91.1	0.70	0.80	0.85	26.9
22	30	2935	91.2	91.5	91.5	0.77	0.84	0.86	42.5	2945	91.5	91.6	91.6	0.70	0.80	0.84	39.8
75	100	2960	93.8	93.9	93.9	0.86	0.88	0.90	135	2965	93.4	94.0	94.0	0.80	0.85	0.88	126
110	150	2970	94.1	94.4	94.4	0.84	0.88	0.90	197	2975	93.9	94.6	94.6	0.80	0.86	0.88	184

# W21 Cast Iron Frame IE2

Output		Frame	Full Load Torque (kgfm)	Locked Rotor Current I <sub>L</sub> /I <sub>n</sub>	Locked Rotor Torque T <sub>L</sub> /T <sub>n</sub>	Break-down Torque T <sub>b</sub> /T <sub>n</sub>	Inertia J (kgm <sup>2</sup> )	Allowable locked rotor time (s)		Weight (kg)	Sound dB(A)	460 V 60Hz							Full load current I <sub>n</sub> (A)
								Hot	Cold			Rated speed (rpm)	% of full load			50	75	100	
													Efficiency		Power Factor				
kW	HP																		
2P-3000rpm-60HZ																			
0.75	1	80	0.260	6.5	2.8	2.8	0.0007	14	31	12.5	59.0	3420	74.0	77.0	78.5	0.60	0.75	0.83	1.44
1.1	1.5	80	0.380	6.5	2.8	2.8	0.0008	10	22	14.0	59.0	3420	77.0	79.0	82.5	0.66	0.78	0.84	1.99
1.5	2	90S	0.520	7.0	2.6	2.6	0.0016	12	26	17.5	62.0	3450	80.0	82.5	84.0	0.63	0.76	0.82	2.73
2.2	3	90L	0.750	6.6	3.0	3.0	0.0022	9	20	21.0	62.0	3460	82.5	84.0	85.5	0.61	0.74	0.81	3.99
3	4	100L	1.01	8.0	2.4	2.8	0.0051	7	15	38.5	67.0	3495	82.5	85.5	85.5	0.67	0.80	0.86	5.12
4	5.5	112M	1.35	7.0	2.0	2.8	0.0066	10	22	38.0	64.0	3500	84.0	86.5	87.5	0.71	0.82	0.87	6.60
5.5	7.5	132S	1.84	6.8	2.2	3.0	0.0162	17	37	60.0	67.0	3520	85.5	87.5	88.5	0.66	0.78	0.84	9.29
7.5	10	132S	2.51	6.8	2.2	2.9	0.0198	13	29	63.0	67.0	3520	86.5	88.5	89.5	0.70	0.82	0.87	12.1
9.2	12.5	132M	3.07	7.6	2.5	3.2	0.0234	10	22	70.0	67.0	3525	87.5	89.5	90.2	0.68	0.81	0.86	14.9
11	15	160M	3.63	7.5	2.5	3.3	0.0421	10	22	85.0	70.0	3555	88.5	90.8	91.0	0.67	0.79	0.85	17.8
15	20	160M	4.98	7.5	2.4	3.3	0.0000	10	22	100	70.0	3540	90.0	91.5	92.0	0.74	0.83	0.86	23.8
18.5	25	160L	6.13	8.5	2.5	3.2	0.0000	8	18	120	70.0	3540	90.3	91.9	92.1	0.71	0.81	0.85	29.7
22	30	180M	7.29	7.8	2.5	3.3	0.0975	10	22	180	70.0	3540	90.8	92.3	92.5	0.70	0.80	0.84	35.5
30	40	200L	9.89	6.0	2.0	2.5	0.1532	18	40	190	74.0	3560	91.0	91.8	93.1	0.70	0.80	0.83	48.7
37	50	200L	12.2	7.0	2.6	2.7	0.1703	12	26	210	74.0	3560	92.3	93.5	93.9	0.73	0.83	0.86	57.5
45	60	225S/M	14.8	7.5	2.5	3.2	0.3409	12	26	390	82.0	3560	91.9	93.2	93.7	0.74	0.86	0.89	67.7
55	75	250S/M	18.0	8.9	2.6	3.4	0.3934	12	26	420	82.0	3565	92.5	93.7	94.0	0.79	0.84	0.88	83.5
75	100	280S/M	24.5	7.5	2.2	2.7	0.9278	28	62	600	83.0	3575	91.0	93.0	93.7	0.77	0.81	0.85	118
90	125	280S/M	29.5	7.5	2.2	2.8	1.10	25	55	715	83.0	3575	92.9	94.4	94.8	0.77	0.82	0.86	139
110	150	315S/M	36.0	7.0	2.3	2.6	1.20	20	44	770	83.0	3575	93.2	94.7	95.1	0.81	0.86	0.88	165
132	175	315S/M	43.2	7.8	2.2	2.7	1.41	12	26	830	83.0	3575	93.1	94.7	95.2	0.80	0.87	0.88	198
150	200	315S/M	49.1	8.0	2.7	2.7	0.0000	15	33	900	83.0	3575	94.0	95.2	95.5	0.79	0.87	0.89	222
160	220	315S/M	52.4	7.8	2.2	2.8	1.68	12	26	900	83.0	3575	94.0	95.2	95.4	0.81	0.87	0.89	237
185	250	315S/M	60.4	8.2	2.4	3.0	0.0000	10	22	1000	83.0	3585	94.0	95.3	95.6	0.79	0.86	0.87	279
200	270	315S/M	65.5	7.9	2.4	3.2	2.01	12	26	1050	83.0	3575	94.1	95.3	95.6	0.78	0.86	0.87	302
200	270	355M/L	65.3	7.2	1.8	2.7	4.29	30	66	1420	81.0	3585	93.0	95.0	95.4	0.87	0.90	0.91	289
220	300	355M/L	71.8	8.5	2.2	2.8	4.50	20	44	1500	81.0	3585	94.0	95.5	95.7	0.84	0.89	0.90	321
250	340	355M/L	81.6	7.8	2.2	2.5	4.83	30	66	1650	81.0	3585	94.2	95.3	95.7	0.85	0.89	0.90	364
280	380	355M/L	91.4	8.5	2.3	2.7	5.90	25	55	1850	81.0	3585	94.6	95.5	95.5	0.89	0.91	0.92	452
300	400	355M/L	97.9	7.8	2.0	2.6	5.90	40	88	1850	83.0	3585	95.0	95.6	95.8	0.84	0.89	0.91	432
315	430	355M/L	103	7.6	2.1	2.6	5.90	40	88	1850	83.0	3585	95.0	95.6	95.8	0.85	0.90	0.91	454
330	450	355M/L*	108	7.8	2.0	2.5	5.90	40	88	1850	83.0	3585	95.0	95.6	95.8	0.86	0.90	0.91	475
High-Output Design																			
1.5	2	90L	0.520	7.0	2.6	2.6	0.0016	12	26	17.5	62.0	3450	80.0	82.5	84.0	0.63	0.76	0.82	2.73
2.2	3	100L	0.740	7.5	2.6	3.0	0.0043	15	33	26.5	67.0	3500	80.0	84.0	85.5	0.64	0.77	0.84	3.84
5.5	7.5	112M	1.86	7.3	2.7	3.0	0.0088	11	24	42.0	64.0	3495	85.5	87.5	88.5	0.69	0.81	0.87	8.97
5.5	7.5	132M	1.84	6.8	2.2	3.0	0.0162	17	37	60.0	67.0	3520	85.5	87.5	88.5	0.66	0.78	0.84	9.29
7.5	10	132M	2.51	6.8	2.2	2.9	0.0198	13	29	63.0	67.0	3520	86.5	88.5	89.5	0.70	0.82	0.87	12.1
11	15	160L	3.63	7.5	2.5	3.3	0.0421	10	22	85.0	70.0	3555	88.5	90.8	91.0	0.67	0.79	0.85	17.8
15	20	160L	4.98	7.5	2.4	3.3	0.0000	10	22	100	70.0	3540	90.0	91.5	92.0	0.74	0.83	0.86	23.8
22	30	180L	7.29	7.8	2.5	3.3	0.0975	10	22	180	70.0	3540	90.8	92.3	92.5	0.70	0.80	0.84	35.5
75	100	250S/M	24.7	8.5	2.9	3.4	0.0000	8	18	540	82.0	3570	91.7	93.6	94.0	0.82	0.86	0.88	114
110	150	280S/M	36.0	7.0	2.3	2.6	1.20	20	44	770	83.0	3575	93.2	94.7	95.1	0.81	0.86	0.88	165





## W21 Cast Iron Frame IE2

Output		Frame	Full Load Torque (kgfm)	Locked Rotor Current I <sub>L</sub> /I <sub>n</sub>	Locked Rotor Torque T <sub>L</sub> /T <sub>n</sub>	Break-down Torque T <sub>b</sub> /T <sub>n</sub>	Inertia J (kgm <sup>2</sup> )	Allowable locked rotor time (s)		Weight (kg)	Sound dB(A)	400 V								
								Hot	Cold			Rated speed (rpm)	% of full load			Full load current I <sub>n</sub> (A)				
													Efficiency				Power Factor			
kW	HP											50	75	100	50	75	100			
4P-1500mp-50HZ																				
0.55	0.75	80	0.380	6.0	2.1	2.5	0.0022	18	40	10.5	44.0	1420	72.0	73.8	77.1	0.60	0.73	0.82	1.26	
0.75	1	80	0.520	6.0	2.6	2.9	0.0029	15	33	13.5	44.0	1410	79.0	79.6	79.8	0.63	0.76	0.83	1.63	
1.1	1.5	90S	0.740	6.5	2.1	2.6	0.0049	14	31	19.0	49.0	1440	81.0	81.8	81.8	0.62	0.75	0.81	2.40	
1.5	2	90L	1.01	6.3	2.0	2.8	0.0055	10	22	22.0	49.0	1440	81.5	83.0	83.0	0.57	0.72	0.80	3.26	
2.2	3	100L	1.49	7.0	3.1	3.2	0.0082	11	24	30.5	53.0	1435	83.0	84.5	84.5	0.60	0.73	0.81	4.64	
3	4	100L	2.04	7.8	2.9	3.3	0.0123	12	26	45.0	53.0	1430	83.0	85.5	86.0	0.64	0.76	0.83	6.07	
4	5.5	112M	2.71	6.6	2.0	2.6	0.0156	13	29	42.0	56.0	1440	86.0	86.7	86.7	0.64	0.76	0.82	8.12	
5.5	7.5	132S	3.67	7.3	1.9	3.0	0.0416	8	18	63.0	56.0	1460	87.5	88.0	88.1	0.68	0.80	0.86	10.5	
7.5	10	132M	5.02	7.2	2.0	3.0	0.0528	8	18	72.0	56.0	1455	88.7	89.0	89.0	0.71	0.81	0.86	14.1	
11	15	160M	7.31	6.3	2.5	2.6	0.0779	12	26	100	67.0	1465	90.0	90.1	90.1	0.68	0.78	0.83	21.2	
15	20	160L	9.94	6.6	3.0	3.0	0.1023	12	26	130	67.0	1470	90.0	90.9	90.9	0.63	0.75	0.80	29.8	
18.5	25	180M	12.2	8.1	3.0	3.0	0.1573	9	20	175	64.0	1475	91.0	91.4	91.4	0.65	0.76	0.82	35.6	
22	30	180L	14.6	7.9	2.8	2.9	0.2010	10	22	190	64.0	1465	91.8	92.0	92.0	0.71	0.81	0.86	40.1	
30	40	200L	19.8	7.0	2.5	2.6	0.2941	10	22	233	69.0	1475	92.2	92.6	92.6	0.67	0.78	0.83	56.3	
37	50	225S/M	24.4	7.2	2.2	2.7	0.6145	10	22	330	70.0	1475	92.6	93.0	93.0	0.76	0.84	0.87	66.0	
45	60	225S/M	29.7	7.4	2.4	3.0	0.7169	10	22	385	70.0	1475	93.2	93.4	93.4	0.76	0.83	0.87	79.9	
55	75	250S/M	36.2	7.2	2.5	3.0	0.8767	10	22	430	70.0	1480	93.5	93.7	93.7	0.74	0.83	0.87	97.4	
75	100	280S/M	49.2	7.2	2.2	2.6	1.80	15	33	600	70.0	1485	94.0	94.2	94.2	0.78	0.86	0.87	132	
90	125	280S/M	59.0	7.8	2.6	2.8	2.27	20	44	760	70.0	1485	94.0	94.5	94.5	0.79	0.85	0.88	156	
110	150	315S/M	72.2	7.6	2.6	3.1	2.82	15	33	830	72.0	1485	94.4	94.8	94.8	0.80	0.86	0.89	187	
132	175	315S/M	86.6	7.8	2.4	2.6	3.48	15	33	1050	72.0	1485	94.5	95.1	95.1	0.77	0.84	0.87	230	
150	200	315S/M	98.4	7.5	2.4	2.7	3.77	20	44	1005	72.0	1485	94.1	95.1	95.1	0.78	0.84	0.87	262	
160	220	315S/M	105	7.6	2.4	2.6	3.79	20	44	1005	72.0	1485	94.1	95.1	95.1	0.76	0.84	0.87	279	
185	250	315S/M	121	7.3	2.4	2.9	3.77	19	42	1005	77.0	1485	94.2	95.0	95.1	0.72	0.81	0.85	328	
200	270	355M/L	131	6.6	2.1	2.3	6.86	49	108	1525	79.0	1490	94.9	95.4	95.4	0.80	0.86	0.88	342	
220	300	355M/L	144	7.0	2.1	2.4	6.86	38	84	1620	79.0	1490	94.4	95.4	95.4	0.79	0.86	0.88	375	
250	340	355M/L	163	6.9	2.2	2.5	8.12	36	79	1615	79.0	1490	94.6	95.4	95.4	0.80	0.86	0.88	425	
260	350	355M/L	170	6.5	2.2	2.3	8.12	32	70	1615	79.0	1490	94.6	95.4	95.5	0.80	0.86	0.88	445	
280	380	355M/L	183	7.1	2.2	2.4	9.02	39	86	1770	79.0	1490	95.3	95.5	95.5	0.81	0.87	0.88	471	
300	400	355M/L	196	6.7	2.2	2.4	9.92	47	103	1770	79.0	1490	95.1	95.6	95.6	0.81	0.87	0.89	504	
315	430	355M/L	206	7.0	2.2	2.4	9.92	42	92	1770	79.0	1490	95.1	95.4	95.6	0.79	0.86	0.88	535	
330	450	355M/L	216	6.5	2.3	2.3	10.8	32	70	1865	79.0	1490	94.7	95.4	95.7	0.81	0.87	0.89	554	
High-Output Design																				
0.75	1	90S	0.510	5.9	2.2	2.6	0.0038	19	42	17.5	49.0	1425	78.0	80.0	80.0	0.59	0.72	0.80	1.69	
1.1	1.5	90L	0.740	6.5	2.1	2.6	0.0049	14	31	19.0	49.0	1440	81.0	81.8	81.8	0.62	0.75	0.81	2.40	
2.2	3	112M	1.48	6.3	1.9	2.6	0.0117	23	51	39.0	56.0	1445	84.5	85.0	85.0	0.63	0.75	0.81	4.61	
4	5.5	132S	2.68	7.2	1.9	3.0	0.0341	14	31	60.0	56.0	1455	87.0	87.2	87.2	0.68	0.80	0.85	7.75	
5.5	7.5	132M	3.67	7.3	1.9	3.0	0.0416	8	18	63.0	56.0	1460	87.5	88.0	88.1	0.68	0.80	0.86	10.5	
7.5	10	132S	5.02	7.2	2.0	3.0	0.0528	8	18	72.0	56.0	1455	88.7	89.0	89.0	0.71	0.81	0.86	14.1	
9.2	12.5	132M	6.16	7.7	2.2	3.2	0.0604	7	15	75.0	56.0	1455	89.2	89.5	89.5	0.69	0.80	0.85	17.3	
37	50	200L	24.5	6.0	2.1	2.5	0.3322	14	31	237	69.0	1470	92.8	93.0	93.0	0.70	0.80	0.83	69.2	
75	100	250S/M	49.4	7.5	2.7	3.2	1.26	16	35	530	70.0	1480	93.6	94.2	94.3	0.74	0.84	0.87	131	
110	150	280S/M	72.2	7.6	2.6	3.1	2.82	15	33	830	70.0	1485	94.4	94.8	94.8	0.80	0.86	0.89	187	
185	250	355M/L	121	7.2	2.2	2.6	6.34	53	117	1415	79.0	1490	94.4	95.2	95.3	0.78	0.85	0.87	320	
200	270	315S/M*	131	8.0	2.4	2.6	3.80	17	37	1005	77.0	1485	94.6	94.9	95.1	0.76	0.84	0.87	346	

# W21 Cast Iron Frame IE2

Output		380 V									415 V								
		Rated speed (rpm)	% of full load						Full load current In (A)	Rated speed (rpm)	% of full load						Full load current In (A)		
			Efficiency			Power Factor					Efficiency			Power Factor					
kW	HP	50	75	100	50	75	100	50	75	100	50	75	100	50	75	100			
4P-1500rpm-50HZ																			
0.55	0.75	1410	73.0	73.1	77.1	0.65	0.77	0.85	1.28	1425	70.7	73.8	77.1	0.56	0.70	0.80	1.24		
0.75	1	1400	80.1	79.6	79.8	0.68	0.80	0.86	1.66	1415	77.9	79.2	80.1	0.60	0.73	0.81	1.61		
1.1	1.5	1432	81.9	81.8	81.5	0.67	0.78	0.83	2.47	1444	80.1	81.5	82.1	0.58	0.72	0.79	2.36		
1.5	2	1430	82.8	83.2	82.8	0.63	0.77	0.83	3.32	1445	80.1	82.3	83.1	0.53	0.68	0.78	3.22		
2.2	3	1425	83.5	84.3	84.3	0.65	0.77	0.83	4.80	1440	82.3	84.5	84.9	0.56	0.71	0.79	4.56		
3	4	1425	84.0	85.5	86.0	0.68	0.80	0.85	6.24	1435	82.0	85.5	86.0	0.60	0.73	0.81	5.99		
4	5.5	1435	86.5	86.6	86.6	0.69	0.80	0.84	8.35	1445	85.3	86.6	87.0	0.60	0.73	0.80	8.00		
5.5	7.5	1455	88.1	87.7	87.7	0.73	0.83	0.88	10.8	1460	87.0	87.9	88.3	0.65	0.77	0.84	10.3		
7.5	10	1450	89.0	88.7	88.7	0.75	0.83	0.87	14.9	1460	88.3	89.0	89.4	0.67	0.78	0.84	13.9		
11	15	1460	90.3	90.1	89.8	0.73	0.82	0.84	22.2	1470	89.6	89.8	89.8	0.66	0.77	0.82	20.8		
15	20	1460	90.4	90.6	90.6	0.68	0.78	0.83	30.3	1470	88.8	90.2	90.6	0.58	0.71	0.78	29.5		
18.5	25	1470	92.0	92.3	91.6	0.71	0.81	0.85	36.1	1475	90.7	91.8	91.8	0.62	0.74	0.81	34.6		
22	30	1460	92.9	92.7	91.6	0.77	0.84	0.87	41.9	1470	92.5	92.9	92.3	0.70	0.80	0.85	39.0		
30	40	1470	93.0	93.1	92.4	0.72	0.81	0.85	58.0	1475	92.0	92.9	92.7	0.63	0.75	0.81	55.6		
37	50	1475	93.7	93.6	92.7	0.83	0.88	0.90	67.4	1480	93.1	93.6	93.2	0.77	0.85	0.88	62.8		
45	60	1475	93.8	93.7	93.1	0.82	0.88	0.89	82.5	1480	93.1	93.6	93.3	0.75	0.84	0.87	77.1		
55	75	1475	94.6	94.4	93.5	0.78	0.85	0.88	100	1480	94.2	94.5	94.0	0.72	0.82	0.86	94.7		
75	100	1480	94.5	94.7	94.2	0.82	0.87	0.89	136	1485	94.0	94.6	94.5	0.77	0.84	0.87	127		
90	125	1480	95.0	95.2	94.8	0.82	0.87	0.89	162	1485	94.6	95.2	95.1	0.77	0.85	0.88	150		
110	150	1485	94.8	94.7	94.7	0.82	0.88	0.89	197	1490	94.4	94.8	94.8	0.77	0.85	0.88	182		
132	175	1485	96.1	96.1	95.7	0.79	0.86	0.88	238	1485	95.9	96.2	96.0	0.74	0.83	0.87	220		
150	200	1480	94.4	94.9	94.9	0.80	0.86	0.88	271	1485	90.0	94.9	95.0	0.76	0.82	0.86	253		
160	220	1480	94.4	95.3	95.3	0.78	0.86	0.88	288	1485	94.0	95.3	95.4	0.74	0.82	0.86	270		
185	250	1485	94.6	95.0	95.1	0.75	0.83	0.86	344	1485	94.3	95.0	95.1	0.70	0.79	0.84	319		
200	270	1485	94.9	95.2	95.3	0.83	0.87	0.89	357	1490	94.6	95.4	95.6	0.78	0.85	0.87	333		
220	300	1490	94.6	95.4	95.4	0.82	0.88	0.89	390	1490	94.2	95.4	95.4	0.77	0.84	0.87	365		
250	340	1485	94.6	95.4	95.4	0.82	0.87	0.89	443	1490	94.3	95.3	95.4	0.77	0.85	0.87	415		
260	350	1485	94.6	95.4	95.4	0.82	0.87	0.89	463	1490	94.3	95.3	95.4	0.77	0.85	0.87	434		
280	380	1485	95.1	95.4	95.4	0.83	0.88	0.89	490	1490	94.9	95.3	95.4	0.79	0.86	0.87	459		
300	400	1485	95.3	96.0	96.0	0.83	0.88	0.89	531	1490	94.9	95.9	96.2	0.79	0.86	0.88	491		
315	430	1485	95.2	95.4	95.4	0.81	0.87	0.89	557	1490	95.1	95.8	95.8	0.76	0.84	0.87	521		
330	450	1485	94.9	95.4	95.5	0.83	0.88	0.90	578	1490	94.6	95.3	95.5	0.79	0.86	0.88	541		
High-Output Design																			
0.75	1	1415	79.1	79.9	79.6	0.64	0.76	0.83	1.72	1430	76.9	79.6	80.4	0.55	0.69	0.78	1.66		
1.1	1.5	1432	81.9	81.8	81.5	0.67	0.78	0.83	2.47	1444	80.1	81.5	82.1	0.58	0.72	0.79	2.36		
2.2	3	1440	85.0	84.8	84.3	0.67	0.78	0.83	4.78	1450	83.9	84.9	85.4	0.59	0.72	0.79	4.54		
4	5.5	1450	87.5	87.1	86.6	0.72	0.83	0.86	8.12	1459	86.4	87.1	87.4	0.65	0.77	0.83	7.63		
5.5	7.5	1455	88.1	87.7	87.7	0.73	0.83	0.88	10.8	1460	87.0	87.9	88.3	0.65	0.77	0.84	10.3		
7.5	10	1450	89.0	88.7	88.7	0.75	0.83	0.87	14.9	1460	88.3	89.0	89.4	0.67	0.78	0.84	13.9		
9.2	12.5	1450	89.6	89.4	89.3	0.74	0.82	0.87	17.8	1455	88.7	89.5	89.8	0.65	0.77	0.84	16.8		
37	50	1465	93.1	92.9	92.7	0.74	0.83	0.85	71.4	1472	92.5	93.0	93.2	0.67	0.78	0.81	68.2		
75	100	1475	93.6	93.8	94.2	0.77	0.85	0.88	137	1480	93.0	94.1	94.2	0.73	0.83	0.86	128		
110	150	1485	94.8	94.7	94.7	0.82	0.88	0.89	197	1490	94.4	94.8	94.8	0.77	0.85	0.88	182		
185	250	1490	94.6	95.2	95.3	0.80	0.86	0.88	334	1490	94.1	95.2	95.5	0.76	0.84	0.86	312		
200	270	1480	94.7	94.9	95.1	0.79	0.86	0.88	363	1485	94.8	94.9	95.1	0.73	0.82	0.86	337		



# W21 Cast Iron Frame IE2

Output		Frame	Full Load Torque (kgfm)	Locked Rotor Current I <sub>L</sub> /I <sub>n</sub>	Locked Rotor Torque T <sub>L</sub> /T <sub>n</sub>	Break-down Torque T <sub>b</sub> /T <sub>n</sub>	Inertia J (kgm <sup>2</sup> )	Allowable locked rotor time (s)		Weight (kg)	Sound dB(A)	460 V 60Hz							
												Rated speed (rpm)	% of full load			Full load current I <sub>n</sub> (A)			
													Efficiency			Power Factor			
kW	HP							Hot	Cold			50	75	100	50	75	100		
4P-1500rpm-60HZ																			
0.55	0.75	80	0.380	6.0	2.1	2.5	0.0022	18	40	10.5	44.0	1730	71.0	75.7	75.5	0.57	0.70	0.79	1.16
0.75	1	80	0.520	6.0	2.6	2.9	0.0029	15	33	13.5	44.0	1720	78.5	80.0	82.5	0.61	0.74	0.81	1.41
1.1	1.5	90S	0.740	6.5	2.1	2.6	0.0049	14	31	19.0	49.0	1745	80.0	82.5	84.0	0.59	0.73	0.80	2.05
1.5	2	90L	1.01	6.3	2.0	2.8	0.0055	10	22	22.0	49.0	1745	81.5	84.0	84.0	0.55	0.69	0.78	2.87
2.2	3	100L	1.49	7.0	3.1	3.2	0.0082	11	24	30.5	53.0	1745	83.0	85.5	87.5	0.58	0.71	0.80	3.94
3	4	100L	2.04	7.8	2.9	3.3	0.0123	12	26	45.0	53.0	1730	84.0	86.5	87.5	0.61	0.74	0.80	5.38
4	5.5	112M	2.71	6.6	2.0	2.6	0.0156	13	29	42.0	56.0	1745	85.5	87.5	87.5	0.61	0.74	0.81	7.08
5.5	7.5	132S	3.67	7.3	1.9	3.0	0.0416	8	18	63.0	56.0	1765	86.8	88.0	89.5	0.65	0.78	0.85	9.07
7.5	10	132M	5.02	7.2	2.0	3.0	0.0528	8	18	72.0	56.0	1760	88.5	90.2	90.2	0.67	0.79	0.85	12.3
11	15	160M	7.31	6.3	2.5	2.6	0.0779	12	26	100	67.0	1770	88.5	90.6	91.0	0.63	0.74	0.81	18.7
15	20	160L	9.94	6.6	3.0	3.0	0.1023	12	26	130	67.0	1770	89.1	91.0	91.3	0.63	0.74	0.80	25.8
18.5	25	180M	12.2	8.1	3.0	3.0	0.1573	9	20	175	64.0	1780	89.6	92.0	92.5	0.62	0.75	0.81	31.0
22	30	180L	14.6	7.9	2.8	2.9	0.2010	10	22	190	64.0	1770	90.8	92.6	92.8	0.67	0.79	0.84	35.4
30	40	200L	19.8	7.0	2.5	2.6	0.2941	10	22	233	69.0	1775	91.1	93.1	93.4	0.63	0.75	0.81	49.8
37	50	225S/M	24.4	7.2	2.2	2.7	0.6145	10	22	330	70.0	1775	92.0	93.4	93.7	0.74	0.84	0.87	57.0
45	60	225S/M	29.7	7.4	2.4	3.0	0.7169	10	22	385	70.0	1780	92.3	93.8	94.0	0.71	0.82	0.87	69.1
55	75	250S/M	36.2	7.2	2.5	3.0	0.8767	10	22	430	70.0	1780	92.9	94.4	94.4	0.70	0.82	0.86	85.0
75	100	280S/M	49.2	7.2	2.2	2.6	1.80	15	33	600	70.0	1780	92.5	94.2	94.7	0.75	0.84	0.87	114
90	125	280S/M	59.0	7.8	2.6	2.8	2.27	20	44	760	70.0	1780	92.9	94.4	95.8	0.74	0.83	0.87	136
110	150	315S/M	72.2	7.6	2.6	3.1	2.82	15	33	830	72.0	1785	93.3	94.7	96.2	0.76	0.85	0.88	163
132	175	315S/M	86.6	7.8	2.4	2.6	3.48	15	33	1050	72.0	1780	93.6	94.9	95.2	0.75	0.83	0.87	200
150	200	315S/M	98.4	7.5	2.4	2.7	3.77	20	44	1005	72.0	1780	93.4	95.0	95.4	0.74	0.83	0.86	229
160	220	315S/M	105	7.6	2.4	2.6	3.79	20	44	1005	72.0	1780	93.3	95.0	95.4	0.72	0.82	0.86	245
185	250	315S/M	121	7.3	2.4	2.9	3.77	19	42	1005	77.0	1780	93.5	95.2	95.6	0.69	0.79	0.84	289
200	270	355M/L	131	6.6	2.1	2.3	6.86	49	108	1525	79.0	1785	94.2	95.6	95.9	0.76	0.85	0.88	297
220	300	355M/L	144	7.0	2.1	2.4	6.86	38	84	1620	79.0	1785	94.0	95.5	95.8	0.75	0.84	0.87	331
250	340	355M/L	163	6.9	2.2	2.5	8.12	36	79	1615	79.0	1785	94.1	95.5	95.8	0.77	0.86	0.88	372
260	350	355M/L	170	6.5	2.2	2.3	8.12	32	70	1615	79.0	1785	94.2	95.5	95.8	0.77	0.86	0.88	387
280	380	355M/L	183	7.1	2.2	2.4	9.02	39	86	1770	79.0	1785	94.4	95.7	95.9	0.78	0.86	0.88	416
300	400	355M/L	196	6.7	2.2	2.4	9.92	47	103	1770	79.0	1785	94.4	95.6	95.9	0.78	0.86	0.88	446
315	430	355M/L	206	7.0	2.2	2.4	9.92	42	92	1770	79.0	1785	94.6	95.8	96.0	0.75	0.84	0.88	468
330	450	355M/L	216	6.5	2.3	2.3	10.8	32	70	1865	79.0	1785	93.6	95.2	95.8	0.77	0.86	0.89	486
High-Output Design																			
0.75	1	90S	0.510	5.9	2.2	2.6	0.0038	19	42	17.5	49.0	1735	77.0	81.5	82.5	0.56	0.69	0.77	1.48
1.1	1.5	90L	0.740	6.5	2.1	2.6	0.0049	14	31	19.0	49.0	1745	80.0	82.5	84.0	0.59	0.73	0.80	2.05
2.2	3	112M	1.48	6.3	1.9	2.6	0.0117	23	51	39.0	56.0	1750	84.0	85.5	87.5	0.59	0.72	0.79	3.99
4	5.5	132S	2.68	7.2	1.9	3.0	0.0341	14	31	60.0	56.0	1760	86.5	87.5	88.5	0.64	0.77	0.84	6.75
5.5	7.5	132M	3.67	7.3	1.9	3.0	0.0416	8	18	63.0	56.0	1765	86.8	88.0	89.5	0.65	0.78	0.85	9.07
7.5	10	132S	5.02	7.2	2.0	3.0	0.0528	8	18	72.0	56.0	1760	88.5	90.2	90.2	0.67	0.79	0.85	12.3
9.2	12.5	132M	6.16	7.7	2.2	3.2	0.0604	7	15	75.0	56.0	1760	88.5	90.2	91.0	0.66	0.79	0.84	14.9
37	50	200L	24.5	6.0	2.1	2.5	0.3322	14	31	237	69.0	1775	92.4	93.0	93.6	0.67	0.79	0.83	59.8
75	100	250S/M	49.4	7.5	2.7	3.2	1.26	16	35	530	70.0	1780	92.6	94.2	94.5	0.71	0.82	0.86	116
110	150	280S/M	72.2	7.6	2.6	3.1	2.82	15	33	830	70.0	1785	93.3	94.7	96.2	0.76	0.85	0.88	163
185	250	355M/L	121	7.2	2.2	2.6	6.34	53	117	1415	79.0	1790	93.7	95.2	95.6	0.72	0.82	0.86	282
200	270	315S/M*	131	8.0	2.4	2.6	3.80	17	37	1005	77.0	1780	93.8	95.3	95.5	0.73	0.82	0.86	306

# W21 Cast Iron Frame IE2

Output		Frame	Full Load Torque (kgfm)	Locked Rotor Current I <sub>L</sub> /I <sub>n</sub>	Locked Rotor Torque T <sub>L</sub> /T <sub>n</sub>	Break-down Torque T <sub>b</sub> /T <sub>n</sub>	Inertia J (kgm <sup>2</sup> )	Allowable locked rotor time (s)		Weight (kg)	Sound dB(A)	400 V								
								Rated speed (rpm)	% of full load						Full load current I <sub>n</sub> (A)					
									Efficiency			Power Factor								
kW	HP							Hot	Cold				50	75	100	50	75	100		
6P-1000rpm-50HZ																				
0.37	0.5	80	0.400	3.9	1.8	2.0	0.0022	27	59	10.5	43.0	910	63.0	67.0	67.6	0.47	0.62	0.72	1.10	
0.55	0.75	80	0.580	4.5	2.3	2.5	0.0030	21	46	14.0	43.0	930	65.0	71.0	73.1	0.50	0.62	0.72	1.51	
0.75	1	90S	0.790	4.5	2.0	2.1	0.0055	23	51	19.0	45.0	925	74.5	76.0	76.0	0.51	0.64	0.73	1.95	
1.1	1.5	90L	1.16	4.7	2.3	2.2	0.0066	17	37	23.0	45.0	925	76.0	78.1	78.1	0.50	0.63	0.73	2.78	
1.5	2	100L	1.55	5.0	2.0	2.4	0.0110	23	51	28.5	44.0	940	79.5	80.0	80.0	0.51	0.64	0.73	3.71	
2.2	3	112M	2.26	6.2	2.4	2.6	0.0224	16	35	45.0	52.0	950	80.5	82.7	82.7	0.52	0.64	0.72	5.26	
3	4	132S	3.04	5.7	2.0	2.4	0.0359	31	68	61.0	52.0	960	82.5	83.6	83.6	0.50	0.63	0.71	7.30	
4	5.5	132M	4.06	6.0	2.1	2.5	0.0453	21	46	68.0	52.0	960	84.0	84.8	84.8	0.51	0.64	0.72	9.46	
5.5	7.5	132M	5.58	6.4	2.2	2.7	0.0604	19	42	72.0	52.0	960	85.5	86.1	86.1	0.51	0.64	0.72	12.8	
7.5	10	160M	7.57	6.6	2.5	2.9	0.1055	10	22	95.0	56.0	965	86.5	88.0	88.0	0.61	0.74	0.81	15.2	
9.2	12.5	160L	9.24	6.2	2.5	2.7	0.0000	10	22	115	56.0	970	88.0	88.3	88.3	0.60	0.73	0.80	18.8	
11	15	160L	11.1	7.0	2.4	2.7	0.1407	10	22	130	56.0	965	88.5	89.0	89.0	0.58	0.72	0.79	22.6	
15	20	180L	15.1	8.0	2.7	3.0	0.3381	5	11	170	56.0	970	89.5	90.0	90.0	0.72	0.81	0.87	27.7	
18.5	25	200L	18.5	6.3	2.3	2.5	0.3335	10	22	180	58.0	975	90.8	91.0	91.0	0.67	0.72	0.78	37.6	
22	30	200L	22.0	6.2	2.3	2.6	0.3868	10	22	210	58.0	975	91.0	91.2	91.2	0.65	0.75	0.82	42.5	
30	40	225S/M	29.7	7.0	2.3	2.6	0.8328	10	22	330	61.0	985	92.0	92.2	92.2	0.70	0.79	0.84	55.9	
37	50	225S/M	36.6	7.0	2.5	2.6	1.02	10	22	400	61.0	985	92.0	92.6	92.6	0.72	0.81	0.84	68.7	
37	50	250S/M	36.6	7.0	2.5	2.6	1.02	10	22	400	61.0	985	92.0	92.6	92.6	0.72	0.81	0.84	68.7	
45	60	280S/M	44.5	6.8	2.2	2.7	2.02	10	22	550	66.0	985	93.0	93.2	93.2	0.67	0.77	0.82	85.0	
55	75	280S/M	54.4	6.7	2.1	2.6	2.26	10	22	610	66.0	985	93.0	93.5	93.5	0.67	0.78	0.82	104	
75	100	315S/M	74.2	6.7	2.1	2.4	3.05	10	22	700	69.0	985	93.8	94.0	94.0	0.72	0.81	0.84	137	
90	125	315S/M	89.0	6.5	2.2	2.4	3.59	12	26	830	69.0	985	94.0	94.2	94.2	0.71	0.80	0.83	166	
110	150	315S/M	109	6.5	2.2	2.4	4.93	12	26	1000	69.0	985	94.1	94.6	94.6	0.69	0.79	0.84	200	
132	175	315S/M	131	6.6	2.2	2.5	5.63	12	26	1050	69.0	985	94.0	94.5	94.6	0.70	0.79	0.84	239	
150	200	355M/L	148	6.0	1.9	2.2	9.05	81	178	1460	73.0	990	93.5	95.0	95.3	0.65	0.75	0.80	282	
160	220	355M/L	157	6.0	1.9	2.1	9.53	76	167	1460	73.0	990	93.8	95.2	95.3	0.65	0.77	0.81	297	
185	250	355M/L	182	6.0	1.9	2.1	10.2	76	167	1530	73.0	990	94.2	95.2	95.3	0.65	0.75	0.80	349	
200	270	355M/L	197	6.1	2.2	2.3	0.0000	28	62	1650	73.0	990	94.5	95.4	95.4	0.66	0.76	0.81	374	
220	300	355M/L	215	6.5	2.0	2.3	0.0000	25	55	1800	73.0	995	94.5	95.4	95.4	0.64	0.75	0.80	416	
250	340	355M/L	246	6.1	1.9	2.1	14.8	64	141	1890	73.0	990	94.6	95.2	95.4	0.69	0.78	0.81	463	
260	350	355M/L	256	6.0	1.8	2.0	14.8	64	141	1830	73.0	990	94.6	95.2	95.4	0.69	0.78	0.81	482	
280	380	355M/L*	275	6.0	2.1	2.2	14.8	54	119	1890	73.0	990	94.2	95.3	95.4	0.68	0.77	0.80	530	
300	400	355M/L*	295	6.4	2.1	2.1	14.8	39	86	1920	73.0	990	93.8	95.0	95.5	0.63	0.73	0.79	574	
315	430	355M/L*	310	6.0	1.9	1.9	15.5	38	84	1950	73.0	990	94.2	95.4	95.5	0.69	0.78	0.81	588	
High-Output Design																				
3	4	132M	3.04	5.7	2.0	2.4	0.0359	31	68	61.0	52.0	960	82.5	83.6	83.6	0.50	0.63	0.71	7.30	
5.5	7.5	160M	5.49	6.3	2.5	2.8	0.1436	18	40	106	56.0	975	87.0	87.0	87.5	0.59	0.72	0.79	11.4	
132	175	355M/L	130	6.1	1.9	2.2	9.05	90	198	1400	73.0	990	93.4	94.8	95.1	0.67	0.77	0.81	246	



## W21 Cast Iron Frame IE2

Output		380 V									415 V								
		Rated speed (rpm)	% of full load						Full load current In (A)	Rated speed (rpm)	% of full load						Full load current In (A)		
			Efficiency			Power Factor					Efficiency			Power Factor					
kW	HP	50	75	100	50	75	100	50	75	100	50	75	100	50	75	100			
6P-1000rpm-50HZ																			
0.37	0.5	895	65.2	67.7	67.6	0.52	0.66	0.76	1.09	915	60.5	65.9	67.6	0.44	0.58	0.69	1.10		
0.55	0.75	920	67.5	71.8	73.1	0.55	0.66	0.76	1.50	935	62.5	69.6	73.1	0.47	0.61	0.72	1.45		
0.75	1	915	75.8	75.9	75.9	0.55	0.68	0.76	1.98	930	73.2	75.6	76.4	0.48	0.61	0.71	1.92		
1.1	1.5	915	77.9	78.5	78.5	0.55	0.67	0.77	2.76	930	74.3	77.3	78.1	0.46	0.59	0.70	2.80		
1.5	2	930	80.7	80.1	79.8	0.55	0.69	0.76	3.76	945	78.3	79.7	80.3	0.48	0.61	0.70	3.71		
2.2	3	945	81.5	82.5	82.5	0.55	0.67	0.74	5.42	955	79.5	83.0	83.0	0.48	0.61	0.70	5.21		
3	4	955	83.4	83.8	83.3	0.54	0.67	0.74	7.39	960	81.4	83.1	83.6	0.46	0.59	0.68	7.34		
4	5.5	955	84.9	85.0	84.6	0.55	0.68	0.74	9.74	960	83.0	84.4	84.9	0.47	0.61	0.69	9.50		
5.5	7.5	955	86.4	86.3	86.0	0.56	0.68	0.75	13.0	965	84.6	85.7	86.2	0.47	0.61	0.69	12.9		
7.5	10	960	88.1	88.2	87.2	0.68	0.79	0.84	15.6	970	86.0	87.6	87.3	0.58	0.71	0.79	15.1		
9.2	12.5	965	88.6	88.9	88.0	0.67	0.78	0.84	18.9	970	86.4	88.0	87.9	0.57	0.70	0.78	18.7		
11	15	965	88.9	88.8	88.7	0.68	0.79	0.84	22.4	970	86.8	88.1	87.8	0.59	0.72	0.79	22.1		
15	20	970	91.3	90.9	89.7	0.78	0.86	0.90	28.2	975	90.6	91.1	90.4	0.71	0.82	0.87	26.5		
18.5	25	975	91.2	91.4	90.5	0.68	0.79	0.83	37.4	980	89.8	90.9	90.7	0.59	0.72	0.79	35.9		
22	30	975	91.9	91.6	90.9	0.73	0.82	0.85	43.3	980	90.9	91.5	90.9	0.65	0.76	0.82	41.1		
30	40	980	92.5	92.4	91.7	0.76	0.84	0.86	57.8	985	91.5	92.2	91.8	0.67	0.78	0.83	54.8		
37	50	982	93.1	92.9	92.2	0.76	0.84	0.87	70.1	986	92.1	92.7	92.4	0.68	0.79	0.83	67.1		
37	50	982	93.1	92.9	92.2	0.76	0.84	0.87	70.1	986	92.1	92.7	92.4	0.68	0.79	0.83	67.1		
45	60	985	93.5	93.6	93.0	0.70	0.80	0.84	87.5	990	92.8	93.5	93.3	0.63	0.75	0.80	83.9		
55	75	985	93.4	93.6	93.1	0.71	0.80	0.84	107	990	92.4	93.2	93.1	0.62	0.74	0.80	103		
75	100	985	94.5	94.2	93.7	0.77	0.84	0.86	142	990	94.0	94.2	93.8	0.70	0.80	0.84	132		
90	125	985	94.8	94.8	94.3	0.72	0.81	0.84	173	990	94.1	94.7	94.5	0.64	0.76	0.81	164		
110	150	985	95.2	95.1	94.5	0.73	0.82	0.85	208	990	94.9	95.2	94.9	0.67	0.78	0.83	194		
132	175	985	94.0	94.5	94.6	0.73	0.82	0.85	249	985	94.0	94.5	94.6	0.68	0.77	0.83	233		
150	200	990	93.7	95.0	95.3	0.70	0.79	0.82	290	990	93.3	95.0	95.2	0.60	0.72	0.78	279		
160	220	990	94.1	95.2	95.2	0.70	0.80	0.82	309	990	93.5	95.2	95.3	0.60	0.74	0.80	290		
185	250	990	94.4	95.1	95.3	0.70	0.79	0.82	358	990	94.0	95.4	95.6	0.60	0.71	0.78	344		
200	270	990	95.0	95.6	95.6	0.68	0.77	0.81	391	995	94.5	95.4	95.6	0.61	0.72	0.78	372		
220	300	995	94.9	95.4	95.4	0.65	0.75	0.80	435	995	94.3	95.3	95.4	0.57	0.69	0.76	420		
250	340	990	94.8	95.0	95.4	0.73	0.80	0.82	482	990	94.2	95.2	95.4	0.66	0.76	0.80	452		
260	350	990	95.0	95.2	95.4	0.73	0.81	0.83	496	995	94.2	95.2	95.4	0.67	0.76	0.80	470		
280	380	985	94.6	95.4	95.4	0.73	0.80	0.81	551	990	94.0	95.2	95.4	0.64	0.74	0.79	517		
300	400	990	94.2	95.1	95.5	0.68	0.77	0.81	589	995	93.0	95.0	95.5	0.58	0.70	0.77	568		
315	430	985	94.6	95.4	95.5	0.73	0.80	0.82	611	990	93.9	95.4	95.5	0.65	0.76	0.80	574		
High-Output Design																			
3	4	955	83.4	83.8	83.3	0.54	0.67	0.74	7.39	960	81.4	83.1	83.6	0.46	0.59	0.68	7.34		
5.5	7.5	970	87.0	87.0	87.5	0.63	0.76	0.81	11.7	980	86.0	87.0	87.5	0.57	0.70	0.77	11.2		
132	175	990	93.8	94.8	95.0	0.72	0.79	0.82	256	990	93.4	94.8	95.1	0.64	0.75	0.80	240		

# W21 Cast Iron Frame IE2

Output		Frame	Full Load Torque (kgfm)	Locked Rotor Current I <sub>L</sub> /I <sub>n</sub>	Locked Rotor Torque T <sub>L</sub> /T <sub>n</sub>	Break-down Torque T <sub>b</sub> /T <sub>n</sub>	Inertia J (kgm <sup>2</sup> )	Allowable locked rotor time (s)		Weight (kg)	Sound dB(A)	460 V 60Hz								
								Hot	Cold			Rated speed (rpm)	% of full load			Full load current I <sub>n</sub> (A)				
													Efficiency				Power Factor			
kW	HP												50	75	100	50	75	100		
6P-1000rpm-60HZ																				
0.37	0.5	80	0.400	3.9	1.8	2.0	0.0022	27	59	10.5	43.0	1120	64.0	66.0	68.0	0.48	0.60	0.70	0.976	
0.55	0.75	80	0.580	4.5	2.3	2.5	0.0030	21	46	14.0	43.0	1140	66.0	72.0	74.0	0.47	0.56	0.67	1.39	
0.75	1	90S	0.790	4.5	2.0	2.1	0.0055	23	51	19.0	45.0	1135	74.0	78.5	80.0	0.48	0.60	0.69	1.71	
1.1	1.5	90L	1.16	4.7	2.3	2.2	0.0066	17	37	23.0	45.0	1135	77.0	80.0	80.0	0.47	0.60	0.69	2.46	
1.5	2	100L	1.55	5.0	2.0	2.4	0.0110	23	51	28.5	44.0	1145	80.0	81.5	84.0	0.49	0.61	0.70	3.30	
2.2	3	112M	2.26	6.2	2.4	2.6	0.0224	16	35	45.0	52.0	1145	81.5	84.0	87.5	0.50	0.63	0.71	4.44	
3	4	132S	3.04	5.7	2.0	2.4	0.0359	31	68	61.0	52.0	1165	82.5	84.0	87.5	0.47	0.60	0.68	6.33	
4	5.5	132M	4.06	6.0	2.1	2.5	0.0453	21	46	68.0	52.0	1165	84.0	86.5	87.5	0.48	0.61	0.69	8.32	
5.5	7.5	132M	5.58	6.4	2.2	2.7	0.0604	19	42	72.0	52.0	1165	85.5	87.5	89.5	0.49	0.62	0.69	11.2	
7.5	10	160M	7.57	6.6	2.5	2.9	0.1055	10	22	95.0	56.0	1170	85.4	88.1	89.5	0.58	0.71	0.78	13.5	
9.2	12.5	160L	9.24	6.2	2.5	2.7	0.0000	10	22	115	56.0	1170	87.3	89.2	89.2	0.57	0.69	0.77	16.8	
11	15	160L	11.1	7.0	2.4	2.7	0.1407	10	22	130	56.0	1175	87.1	89.6	90.2	0.55	0.68	0.76	20.1	
15	20	180L	15.1	8.0	2.7	3.0	0.3381	5	11	170	56.0	1170	88.5	90.0	90.2	0.68	0.80	0.85	24.6	
18.5	25	200L	18.5	6.3	2.3	2.5	0.3335	10	22	180	58.0	1175	90.2	91.4	91.7	0.64	0.76	0.82	30.9	
22	30	200L	22.0	6.2	2.3	2.6	0.3868	10	22	210	58.0	1175	90.2	91.7	92.0	0.61	0.74	0.80	37.5	
30	40	225S/M	29.7	7.0	2.3	2.6	0.8328	10	22	330	61.0	1180	90.2	92.0	93.0	0.69	0.80	0.84	48.2	
37	50	225S/M	36.6	7.0	2.5	2.6	1.02	10	22	400	61.0	1175	90.4	92.5	93.1	0.69	0.79	0.83	60.1	
37	50	250S/M	36.6	7.0	2.5	2.6	1.02	10	22	400	61.0	1175	90.4	92.5	93.1	0.69	0.79	0.83	60.1	
45	60	280S/M	44.5	6.8	2.2	2.7	2.02	10	22	550	66.0	1185	90.2	92.7	93.6	0.63	0.75	0.80	75.4	
55	75	280S/M	54.4	6.7	2.1	2.6	2.26	10	22	610	66.0	1185	90.9	93.1	93.7	0.65	0.76	0.81	91.0	
75	100	315S/M	74.2	6.7	2.1	2.4	3.05	10	22	700	69.0	1185	92.3	94.0	94.2	0.69	0.79	0.83	120	
90	125	315S/M	89.0	6.5	2.2	2.4	3.59	12	26	830	69.0	1185	92.4	94.2	94.5	0.67	0.78	0.82	146	
110	150	315S/M	109	6.5	2.2	2.4	4.93	12	26	1000	69.0	1185	93.0	94.7	95.0	0.66	0.77	0.82	177	
132	175	315S/M	131	6.6	2.2	2.5	5.63	12	26	1050	69.0	1185	92.9	94.6	94.8	0.67	0.78	0.83	211	
150	200	355M/L	148	6.0	1.9	2.2	9.05	81	178	1460	73.0	1190	92.6	94.8	95.4	0.64	0.74	0.79	250	
160	220	355M/L	157	6.0	1.9	2.1	9.53	76	167	1460	73.0	1190	92.6	94.7	95.4	0.62	0.73	0.79	266	
185	250	355M/L	182	6.0	1.9	2.1	10.2	76	167	1530	73.0	1190	92.6	94.9	95.5	0.61	0.72	0.78	312	
200	270	355M/L	197	6.1	2.2	2.3	0.0000	28	62	1650	73.0	1190	93.0	95.0	95.4	0.63	0.73	0.79	333	
220	300	355M/L	215	6.5	2.0	2.3	0.0000	25	55	1800	73.0	1190	91.8	94.4	95.3	0.64	0.76	0.80	362	
250	340	355M/L	246	6.1	1.9	2.1	14.8	64	141	1890	73.0	1190	93.4	95.2	95.7	0.67	0.76	0.80	410	
260	350	355M/L	256	6.0	1.8	2.0	14.8	64	141	1830	73.0	1190	93.5	95.2	95.7	0.66	0.75	0.80	426	
280	380	355M/L*	275	6.0	2.1	2.2	14.8	54	119	1890	73.0	1185	93.3	95.1	95.6	0.68	0.77	0.80	460	
300	400	355M/L*	295	6.4	2.1	2.1	14.8	39	86	1920	73.0	1190	92.8	94.8	95.5	0.62	0.72	0.78	505	
315	430	355M/L*	310	6.0	1.9	1.9	15.5	38	84	1950	73.0	1185	93.2	95.2	95.7	0.66	0.77	0.80	516	
High-Output Design																				
3	4	132M	3.04	5.7	2.0	2.4	0.0359	31	68	61.0	52.0	1165	82.5	84.0	87.5	0.47	0.60	0.68	6.33	
5.5	7.5	160M	5.49	6.3	2.5	2.8	0.1436	18	40	106	56.0	1170	85.6	87.3	89.5	0.55	0.69	0.77	10.2	
132	175	355M/L	130	6.1	1.9	2.2	9.05	90	198	1400	73.0	1190	92.8	94.7	95.2	0.66	0.75	0.80	218	



## W21 Cast Iron Frame IE2

Output		Frame	Full Load Torque (kgfm)	Locked Rotor Current I/In	Locked Rotor Torque Tl/Tn	Break-down Torque Tb/Tn	Inertia J (kgm²)	Allowable locked rotor time (s)		Weight (kg)	Sound dB(A)	400 V									
												Rated speed (rpm)	% of full load						Full load current In (A)		
													Efficiency			Power Factor					
kW	HP							Hot	Cold				50	75	100	50	75	100			
8P-750rpm-50HZ																					
0.18	0.25	80	0.260	3.1	1.9	2.1	0.0024	48	106	11.5	42.0	670	47.0	53.0	55.0	0.44	0.55	0.65	0.727		
0.25	0.33	80	0.360	3.2	1.9	2.1	0.0029	42	92	13.5	42.0	670	49.0	55.0	57.0	0.43	0.55	0.66	0.959		
0.37	0.5	90S	0.520	3.5	2.1	2.1	0.0044	37	81	18.0	43.0	690	56.0	62.0	62.0	0.41	0.52	0.62	1.39		
0.55	0.75	90L	0.780	3.5	1.9	2.0	0.0060	31	68	22.0	43.0	685	61.0	64.0	64.0	0.44	0.56	0.66	1.88		
0.75	1	100L	1.03	4.6	2.0	2.4	0.0110	42	92	28.5	50.0	710	71.0	74.0	74.0	0.40	0.52	0.62	2.36		
1.1	1.5	100L	1.52	4.6	2.1	2.3	0.0127	29	64	30.5	50.0	705	71.0	75.0	75.0	0.40	0.53	0.62	3.41		
1.5	2	112M	2.09	4.7	2.4	2.3	0.0202	29	64	39.0	46.0	700	77.0	79.0	79.0	0.44	0.57	0.67	4.09		
2.2	3	132S	3.06	5.5	2.2	2.4	0.0592	25	55	62.0	48.0	700	81.0	81.5	81.0	0.52	0.65	0.72	5.44		
3	4	132M	4.17	5.5	2.3	2.4	0.0740	19	42	66.0	48.0	700	82.0	82.5	82.0	0.54	0.66	0.73	7.23		
4	5.5	160M	5.37	5.2	2.2	2.8	0.0000	12	26	90.0	51.0	725	82.0	84.5	84.5	0.44	0.57	0.66	10.4		
5.5	7.5	160M	7.34	5.6	2.5	2.8	0.0000	12	26	115	51.0	730	82.0	85.0	85.0	0.42	0.55	0.65	14.4		
7.5	10	160L	10.1	5.2	2.0	2.4	0.0000	15	33	140	51.0	725	84.0	86.5	86.5	0.52	0.64	0.71	17.6		
9.2	12.5	180M	12.4	7.0	2.2	2.5	0.0000	10	22	155	51.0	725	87.0	87.2	87.2	0.67	0.77	0.83	18.3		
11	15	180L	14.8	7.0	2.2	2.4	0.2620	9	20	183	51.0	725	88.0	89.0	89.0	0.68	0.78	0.83	21.5		
15	20	200L	20.0	5.0	2.0	2.2	0.0000	18	40	250	53.0	730	89.0	89.5	89.5	0.53	0.65	0.71	34.1		
18.5	25	225S/M	24.7	7.2	2.1	2.6	0.8472	18	40	340	60.0	730	90.5	91.5	91.9	0.69	0.79	0.83	35.0		
22	30	225S/M	29.4	7.5	2.2	3.0	0.9884	18	40	365	60.0	730	90.8	92.2	92.5	0.67	0.77	0.82	41.9		
30	40	250S/M	40.0	7.5	2.1	2.8	1.22	17	37	440	60.0	730	91.7	92.5	93.0	0.69	0.79	0.83	56.1		
37	50	280S/M	48.7	6.5	1.9	2.2	0.0000	25	55	540	62.0	740	93.0	93.2	93.2	0.63	0.75	0.78	73.5		
45	60	280S/M	59.2	6.5	2.0	2.4	0.0000	20	44	640	62.0	740	93.0	93.5	93.5	0.62	0.73	0.79	87.9		
55	75	315S/M	72.4	6.5	1.8	2.2	0.0000	28	62	680	62.0	740	93.5	94.0	94.0	0.63	0.74	0.79	107		
75	100	315S/M	98.7	6.6	1.9	2.2	4.37	20	44	876	62.0	740	93.9	94.3	94.5	0.66	0.78	0.81	141		
90	125	315S/M	118	6.8	1.9	2.4	5.29	23	51	970	62.0	740	93.9	94.3	94.5	0.67	0.77	0.81	169		
110	150	355M/L	145	6.4	1.5	2.2	12.6	41	90	1430	70.0	740	93.5	94.7	94.7	0.62	0.73	0.79	211		
132	175	355M/L	174	6.5	1.6	2.2	13.2	47	103	1445	70.0	740	94.0	95.0	95.1	0.63	0.73	0.79	253		
132	180	355M/L	174	6.5	1.6	2.2	13.2	47	103	1445	70.0	740	94.0	95.0	95.1	0.63	0.73	0.79	253		
150	200	355M/L	197	7.0	1.6	2.2	15.9	40	88	1600	70.0	740	94.3	95.0	95.2	0.61	0.72	0.78	290		
160	220	355M/L	211	6.6	1.6	2.2	16.3	42	92	1590	70.0	740	94.3	95.1	95.2	0.62	0.74	0.79	305		
185	250	355M/L	242	6.5	1.6	2.2	17.3	30	66	1730	70.0	745	93.5	95.2	95.3	0.58	0.70	0.78	358		
200	270	355M/L	263	6.8	1.6	2.1	19.5	37	81	1830	70.0	740	94.2	95.1	95.4	0.58	0.71	0.78	388		
220	300	355M/L	290	6.8	1.6	2.2	20.4	35	77	1930	70.0	740	94.5	95.2	95.5	0.61	0.73	0.77	432		



# W21 Cast Iron Frame IE2

Output		380 V									415 V								
		Rated speed (rpm)	% of full load						Full load current In (A)	Rated speed (rpm)	% of full load						Full load current In (A)		
			Efficiency			Power Factor					Efficiency			Power Factor					
kW	HP	50	75	100	50	75	100	50	75	100	50	75	100	50	75	100			
8P-750rpm-50HZ																			
0.18	0.25	660	49.3	54.4	54.9	0.47	0.59	0.69	0.722	675	45.0	51.8	54.5	0.42	0.53	0.62	0.741		
0.25	0.33	660	51.1	56.2	56.8	0.47	0.59	0.70	0.955	675	47.0	53.8	56.8	0.42	0.53	0.63	0.972		
0.37	0.5	680	59.5	63.8	62.4	0.44	0.56	0.67	1.34	695	53.1	59.9	60.9	0.39	0.49	0.59	1.43		
0.55	0.75	675	63.3	65.1	63.5	0.47	0.61	0.70	1.88	690	58.5	62.8	63.9	0.41	0.53	0.63	1.90		
0.75	1	705	73.0	75.0	73.9	0.44	0.57	0.65	2.37	715	69.2	73.0	73.7	0.38	0.49	0.59	2.40		
1.1	1.5	700	73.6	76.2	74.9	0.45	0.57	0.66	3.38	705	68.8	73.6	74.5	0.37	0.49	0.59	3.48		
1.5	2	695	78.8	79.6	78.5	0.49	0.61	0.70	4.15	705	75.3	78.2	78.9	0.41	0.53	0.63	4.20		
2.2	3	695	81.8	81.5	79.9	0.57	0.69	0.75	5.58	705	80.1	81.4	81.4	0.49	0.62	0.70	5.37		
3	4	690	82.7	82.4	80.8	0.58	0.70	0.75	7.52	705	81.1	82.4	82.5	0.50	0.63	0.71	7.13		
4	5.5	725	82.6	84.8	84.7	0.50	0.63	0.72	9.97	730	78.4	82.4	83.7	0.41	0.54	0.64	10.4		
5.5	7.5	725	83.7	85.6	85.5	0.50	0.63	0.72	13.6	730	79.2	83.1	84.3	0.41	0.54	0.63	14.4		
7.5	10	720	86.7	87.3	86.1	0.59	0.71	0.78	17.0	725	83.5	85.8	86.0	0.49	0.62	0.71	17.1		
9.2	12.5	725	88.7	88.3	86.6	0.69	0.79	0.84	19.2	730	87.5	88.3	87.5	0.61	0.73	0.80	18.3		
11	15	725	88.2	89.0	88.8	0.73	0.81	0.85	22.1	730	87.8	89.0	89.0	0.65	0.75	0.81	21.2		
15	20	730	89.9	90.4	89.6	0.59	0.71	0.77	33.0	735	88.0	89.6	89.6	0.50	0.63	0.71	32.8		
18.5	25	725	90.8	91.5	91.5	0.73	0.81	0.84	36.6	730	90.2	91.5	91.9	0.65	0.77	0.82	34.2		
22	30	730	91.1	92.2	92.2	0.71	0.80	0.83	43.7	735	90.5	92.1	92.5	0.63	0.74	0.81	40.8		
30	40	725	92.0	92.5	92.6	0.73	0.81	0.84	58.6	730	91.3	92.5	93.0	0.65	0.77	0.82	54.7		
37	50	740	93.7	93.5	92.5	0.67	0.76	0.79	76.9	740	93.0	93.5	93.0	0.60	0.71	0.77	71.9		
45	60	740	94.0	93.8	92.9	0.67	0.76	0.79	93.2	740	93.2	93.7	93.3	0.60	0.71	0.77	87.1		
55	75	735	94.2	93.9	92.8	0.68	0.77	0.80	113	740	93.5	93.8	93.3	0.61	0.72	0.77	107		
75	100	735	94.1	94.3	94.4	0.69	0.80	0.82	147	740	93.7	94.3	94.5	0.63	0.76	0.80	137		
90	125	735	94.2	94.4	94.6	0.71	0.79	0.83	173	740	93.6	94.2	94.7	0.63	0.75	0.80	165		
110	150	740	94.0	94.7	94.6	0.65	0.76	0.81	217	745	93.0	94.7	94.7	0.59	0.77	0.77	209		
132	175	740	94.5	95.0	95.1	0.66	0.75	0.81	260	745	93.5	95.0	95.1	0.60	0.71	0.77	250		
132	180	740	94.5	95.0	95.1	0.66	0.75	0.81	260	745	93.5	95.0	95.1	0.60	0.71	0.77	250		
150	200	740	94.8	95.0	95.1	0.63	0.74	0.79	302	745	93.8	95.0	95.2	0.57	0.69	0.76	287		
160	220	740	94.8	95.1	95.2	0.66	0.76	0.80	318	745	93.8	95.2	95.2	0.58	0.71	0.78	298		
185	250	740	94.0	95.2	95.3	0.63	0.74	0.80	368	745	93.0	95.2	95.3	0.53	0.66	0.76	355		
200	270	740	94.4	95.1	95.4	0.63	0.74	0.80	398	745	94.0	95.0	95.4	0.54	0.68	0.76	383		
220	300	740	94.8	95.2	95.4	0.64	0.75	0.79	444	745	94.2	95.2	95.5	0.59	0.71	0.76	422		



## W21 Cast Iron Frame IE2

Output		Frame	Full Load Torque (kgfm)	Locked Rotor Current I <sub>L</sub> /I <sub>n</sub>	Locked Rotor Torque T <sub>L</sub> /T <sub>n</sub>	Break-down Torque T <sub>b</sub> /T <sub>n</sub>	Inertia J (kgm <sup>2</sup> )	Allowable locked rotor time (s)		Weight (kg)	Sound dB(A)	460 V 60Hz						Full load current I <sub>n</sub> (A)		
								Hot	Cold			Rated speed (rpm)	% of full load			Efficiency	Power Factor			
													50	75	100		50		75	100
0.18	0.25	80	0.260	3.1	1.9	2.1	0.0024	48	106	11.5	42.0	830	48.0	52.5	57.5	0.39	0.48	0.57	0.689	
0.25	0.33	80	0.360	3.2	1.9	2.1	0.0029	42	92	13.5	42.0	830	50.5	55.0	59.5	0.40	0.49	0.58	0.909	
0.37	0.5	90S	0.520	3.5	2.1	2.1	0.0044	37	81	18.0	43.0	850	57.5	64.0	66.0	0.37	0.47	0.56	1.26	
0.55	0.75	90L	0.780	3.5	1.9	2.0	0.0060	31	68	22.0	43.0	845	62.0	66.0	68.0	0.40	0.51	0.61	1.66	
0.75	1	100L	1.03	4.6	2.0	2.4	0.0110	42	92	28.5	50.0	865	72.0	75.5	75.5	0.38	0.49	0.58	2.15	
1.1	1.5	100L	1.52	4.6	2.1	2.3	0.0127	29	64	30.5	50.0	860	72.0	75.5	77.0	0.38	0.49	0.58	3.09	
1.5	2	112M	2.09	4.7	2.4	2.3	0.0202	29	64	39.0	46.0	855	77.0	80.0	82.5	0.42	0.54	0.62	3.68	
2.2	3	132S	3.06	5.5	2.2	2.4	0.0592	25	55	62.0	48.0	855	80.0	82.5	84.0	0.49	0.62	0.70	4.70	
3	4	132M	4.17	5.5	2.3	2.4	0.0740	19	42	66.0	48.0	855	82.5	84.0	84.0	0.51	0.63	0.71	6.31	
4	5.5	160M	5.37	5.2	2.2	2.8	0.0000	12	26	90.0	51.0	875	80.7	85.1	86.5	0.41	0.53	0.62	9.36	
5.5	7.5	160M	7.34	5.6	2.5	2.8	0.0000	12	26	115	51.0	875	81.8	85.9	87.0	0.41	0.52	0.62	12.8	
7.5	10	160L	10.1	5.2	2.0	2.4	0.0000	15	33	140	51.0	875	84.1	87.5	88.5	0.49	0.61	0.68	15.6	
9.2	12.5	180M	12.4	7.0	2.2	2.5	0.0000	10	22	155	51.0	875	86.5	88.3	88.5	0.64	0.76	0.81	16.1	
11	15	180L	14.8	7.0	2.2	2.4	0.2620	9	20	183	51.0	875	87.0	88.9	89.1	0.65	0.77	0.82	18.9	
15	20	200L	20.0	5.0	2.0	2.2	0.0000	18	40	250	53.0	880	87.9	90.8	91.4	0.50	0.61	0.69	29.9	
18.5	25	225S/M	24.7	7.2	2.1	2.6	0.8472	18	40	340	60.0	875	89.3	91.5	91.8	0.64	0.77	0.82	30.8	
22	30	225S/M	29.4	7.5	2.2	3.0	0.9884	18	40	365	60.0	875	89.8	92.0	92.5	0.64	0.75	0.80	37.3	
30	40	250S/M	40.0	7.5	2.1	2.8	1.22	17	37	440	60.0	880	90.4	92.3	92.8	0.65	0.75	0.81	50.1	
37	50	280S/M	48.7	6.5	1.9	2.2	0.0000	25	55	540	62.0	885	91.3	93.5	93.9	0.60	0.72	0.78	63.4	
45	60	280S/M	59.2	6.5	2.0	2.4	0.0000	20	44	640	62.0	885	91.3	93.7	94.1	0.63	0.74	0.78	77.0	
55	75	315S/M	72.4	6.5	1.8	2.2	0.0000	28	62	680	62.0	890	92.4	94.4	94.7	0.61	0.72	0.78	93.5	
75	100	315S/M	98.7	6.6	1.9	2.2	4.37	20	44	876	62.0	885	92.6	94.8	95.0	0.63	0.75	0.80	124	
90	125	315S/M	118	6.8	1.9	2.4	5.29	23	51	970	62.0	885	92.5	94.7	95.1	0.64	0.75	0.80	148	
110	150	355M/L	145	6.4	1.5	2.2	12.6	41	90	1430	70.0	890	92.5	94.9	95.3	0.62	0.74	0.79	183	
132	175	355M/L	174	6.5	1.6	2.2	13.2	47	103	1445	70.0	890	92.9	95.2	95.6	0.60	0.71	0.77	225	
132	180	355M/L	174	6.5	1.6	2.2	13.2	47	103	1445	70.0	890	92.9	95.2	95.6	0.60	0.71	0.77	225	
150	200	355M/L	197	7.0	1.6	2.2	15.9	40	88	1600	70.0	890	93.0	95.3	95.7	0.59	0.71	0.77	255	
160	220	355M/L	211	6.6	1.6	2.2	16.3	42	92	1590	70.0	890	93.3	95.4	95.8	0.60	0.71	0.77	272	
185	250	355M/L	242	6.5	1.6	2.2	17.3	30	66	1730	70.0	895	92.1	94.9	95.6	0.55	0.67	0.75	324	
200	270	355M/L	263	6.8	1.6	2.1	19.5	37	81	1830	70.0	890	92.8	95.1	95.5	0.56	0.68	0.75	350	
220	300	355M/L	290	6.8	1.6	2.2	20.4	35	77	1930	70.0	890	92.9	95.3	95.7	0.57	0.69	0.75	385	

# W21 Cast Iron Frame IE3

Output		Frame	Full Load Torque (kgfm)	Locked Rotor Current I <sub>L</sub> /I <sub>n</sub>	Locked Rotor Torque T <sub>L</sub> /T <sub>n</sub>	Break-down Torque T <sub>b</sub> /T <sub>n</sub>	Inertia J (kgm <sup>2</sup> )	Allowable locked rotor time (s)		Weight (kg)	Sound dB(A)	400 V							Full load current I <sub>n</sub> (A)
								Rated speed (rpm)	% of full load			Power Factor							
									Efficiency			Power Factor							
kW	HP							Hot	Cold			50	75	100	50	75	100		
2P-3000rpm-50HZ																			
0.75	1	80	0.260	7.5	3.5	3.5	0.0008	25	55	13.5	59.0	2825	80.0	82.0	82.0	0.63	0.76	0.82	1.61
1.1	1.5	80	0.380	7.4	3.6	3.6	0.0009	23	51	15.0	59.0	2830	81.0	83.0	83.0	0.63	0.76	0.82	2.33
1.5	2	90L	0.510	7.6	3.3	3.3	0.0020	15	33	18.5	62.0	2875	83.0	84.0	84.5	0.64	0.76	0.83	3.09
2.2	3	90L	0.750	7.5	3.4	3.5	0.0026	12	26	23.5	62.0	2870	83.5	85.5	86.0	0.65	0.77	0.83	4.45
3	4	100L	1.00	8.5	3.4	3.4	0.0064	15	33	32.0	67.0	2910	85.0	86.5	87.2	0.69	0.81	0.86	5.77
4	5.5	112M	1.34	7.7	2.9	3.5	0.0080	22	48	41.0	64.0	2900	87.0	88.0	88.3	0.69	0.80	0.86	7.60
5.5	7.5	132S	1.83	8.3	2.6	3.2	0.0216	23	51	65.0	67.0	2930	89.0	89.5	89.5	0.72	0.82	0.87	10.2
7.5	10	132S	2.49	8.5	3.0	3.4	0.0252	17	37	69.0	67.0	2935	87.5	90.0	90.2	0.69	0.80	0.86	14.0
9.2	12.5	132M	3.06	8.5	2.9	3.3	0.0306	16	35	78.0	67.0	2930	89.5	90.5	91.0	0.75	0.84	0.88	16.6
11	15	160M	3.63	8.6	2.3	3.0	0.0506	12	26	110	70.0	2950	90.0	91.5	91.5	0.65	0.78	0.83	20.9
15	20	160M	4.96	8.3	2.4	2.9	0.0565	11	24	115	70.0	2945	91.0	92.0	92.2	0.71	0.81	0.84	28.0
18.5	25	160L	6.12	9.0	2.3	2.7	0.0650	11	24	136	70.0	2945	91.5	92.6	92.6	0.67	0.79	0.85	33.9
22	30	180M	7.25	8.6	2.8	2.7	0.1192	9	20	180	70.0	2955	92.0	93.0	93.0	0.75	0.83	0.87	39.2
30	40	200L	9.89	7.6	2.7	2.4	0.2063	35	77	245	74.0	2955	91.5	93.0	93.5	0.75	0.83	0.86	53.9
37	50	200L	12.2	8.4	2.6	2.6	0.2242	16	35	260	74.0	2960	92.5	93.5	93.8	0.76	0.84	0.87	65.4
45	60	225S/M	14.8	8.5	2.4	2.9	0.4961	20	44	410	82.0	2965	93.8	94.0	94.3	0.82	0.88	0.90	76.5
55	75	250S/M	18.1	8.5	2.3	3.0	0.5303	18	40	470	82.0	2960	93.8	94.5	94.5	0.85	0.89	0.91	92.3
75	100	280S/M	24.5	7.0	1.6	2.6	1.20	36	79	700	83.0	2975	94.2	95.0	95.0	0.83	0.88	0.89	128
90	125	280S/M	29.5	8.0	2.2	2.8	1.31	42	92	780	83.0	2975	93.8	95.0	95.2	0.82	0.88	0.90	152
110	150	315S/M	36.0	8.0	1.8	2.6	1.40	25	55	830	83.0	2975	94.5	95.4	95.4	0.76	0.84	0.88	189
132	175	315S/M	43.2	7.8	1.9	2.6	1.62	30	66	900	81.0	2975	94.7	95.6	95.6	0.79	0.87	0.89	224
160	220	315S/M	52.4	8.2	1.9	2.6	1.97	30	66	990	81.0	2975	95.0	95.8	95.8	0.79	0.86	0.89	271
200	270	355M/L	65.3	7.7	2.2	2.7	4.85	50	110	1490	81.0	2985	94.0	95.0	95.8	0.88	0.90	0.91	331
High-Output Design																			
0.75	1	90S	0.250	8.2	3.3	3.4	0.0015	24	53	17.0	62.0	2900	79.0	82.5	83.0	0.63	0.75	0.82	1.59
1.1	1.5	90S	0.370	7.8	3.3	3.3	0.0018	19	42	17.5	62.0	2880	82.0	84.2	84.5	0.63	0.75	0.82	2.29
1.5	2	90S	0.510	7.6	3.3	3.3	0.0020	15	33	18.5	62.0	2875	83.0	84.0	84.5	0.64	0.76	0.83	3.09
4	5.5	132S	1.33	7.5	2.3	3.1	0.0180	24	53	61.0	67.0	2930	86.9	88.7	89.0	0.73	0.82	0.87	7.46
5.5	7.5	132M	1.83	8.3	2.6	3.2	0.0216	23	51	65.0	67.0	2930	89.0	89.5	89.5	0.72	0.82	0.87	10.2
7.5	10	132M	2.49	8.5	3.0	3.4	0.0252	17	37	69.0	67.0	2935	87.5	90.0	90.2	0.69	0.80	0.86	14.0
11	15	132M	3.66	8.2	2.7	3.0	0.0306	11	24	78.0	67.0	2925	90.6	91.1	91.2	0.75	0.85	0.89	19.6
15	20	160L	4.96	8.3	2.4	2.9	0.0565	11	24	115	70.0	2945	91.0	92.0	92.2	0.71	0.81	0.84	28.0
22	30	180L	7.25	8.6	2.8	2.7	0.1192	9	20	180	70.0	2955	92.0	93.0	93.0	0.75	0.83	0.87	39.2
200	270	315S/M	65.4	7.6	2.2	2.9	2.03	49	108	1045	81.0	2980	95.0	95.8	95.9	0.81	0.86	0.88	342



# W21 Cast Iron Frame IE3

Output		380 V								415 V							
		Rated speed (rpm)	% of full load						Full load current In (A)	Rated speed (rpm)	% of full load						Full load current In (A)
			Efficiency			Power Factor					Efficiency			Power Factor			
kW	HP	50	75	100	50	75	100	50	75	100	50	75	100	50	75	100	
2P-3000rpm-50HZ																	
0.75	1	2805	80.9	82.2	81.6	0.68	0.80	0.85	1.64	2835	79.1	81.7	82.1	0.59	0.72	0.79	1.61
1.1	1.5	2810	81.0	83.0	83.0	0.69	0.80	0.85	2.37	2840	81.0	83.0	83.0	0.58	0.72	0.79	2.33
1.5	2	2860	83.0	84.0	84.5	0.69	0.80	0.85	3.17	2885	83.0	84.0	84.5	0.59	0.72	0.80	3.09
2.2	3	2855	84.0	85.0	86.0	0.70	0.81	0.86	4.52	2880	83.0	85.0	86.0	0.61	0.74	0.81	4.39
3	4	2900	84.5	86.0	87.2	0.75	0.84	0.88	5.94	2915	84.5	86.5	87.2	0.66	0.78	0.84	5.70
4	5.5	2890	87.0	88.0	88.3	0.73	0.83	0.88	7.82	2905	87.0	88.0	88.3	0.65	0.77	0.84	7.50
5.5	7.5	2920	89.0	89.5	89.5	0.76	0.85	0.89	10.5	2935	88.5	89.5	89.5	0.68	0.79	0.85	10.1
7.5	10	2925	87.5	90.0	90.2	0.74	0.84	0.88	14.4	2940	87.5	90.0	90.2	0.65	0.77	0.83	13.9
9.2	12.5	2920	89.5	90.5	91.0	0.79	0.87	0.90	17.1	2935	89.5	90.5	91.0	0.71	0.82	0.87	16.2
11	15	2945	90.0	91.5	91.5	0.72	0.82	0.85	21.5	2955	90.0	91.5	91.5	0.61	0.74	0.81	20.6
15	20	2940	91.0	92.0	92.2	0.74	0.82	0.85	29.1	2950	91.0	92.0	92.2	0.68	0.80	0.83	27.3
18.5	25	2940	91.5	92.6	92.6	0.70	0.81	0.86	35.3	2950	91.5	92.6	92.6	0.63	0.77	0.84	33.1
22	30	2950	92.0	93.0	93.0	0.78	0.85	0.88	40.8	2955	92.0	93.0	93.0	0.72	0.81	0.86	38.3
30	40	2950	91.5	93.0	93.5	0.76	0.84	0.87	56.0	2960	91.5	93.0	93.5	0.74	0.82	0.85	52.5
37	50	2955	92.5	93.5	93.8	0.81	0.86	0.88	68.1	2960	92.3	93.2	93.8	0.73	0.82	0.86	63.8
45	60	2960	93.8	94.0	94.3	0.84	0.89	0.91	79.7	2970	93.8	94.0	94.3	0.80	0.87	0.89	74.6
55	75	2955	93.8	94.5	94.5	0.86	0.90	0.92	96.1	2960	93.8	94.5	94.5	0.83	0.88	0.90	90.0
75	100	2970	94.0	95.0	95.0	0.84	0.89	0.90	133	2975	94.2	95.0	95.0	0.80	0.86	0.88	125
90	125	2975	93.8	95.0	95.2	0.84	0.89	0.90	160	2980	93.8	95.0	95.2	0.80	0.87	0.89	148
110	150	2970	94.5	95.4	95.4	0.78	0.85	0.89	197	2975	94.3	95.4	95.4	0.72	0.82	0.87	184
132	175	2970	94.7	95.6	95.6	0.81	0.88	0.89	236	2975	94.7	95.6	95.6	0.75	0.86	0.88	218
160	220	2970	95.0	95.8	95.8	0.81	0.87	0.90	282	2975	94.8	95.8	95.8	0.77	0.85	0.88	264
200	270	2980	94.0	95.0	95.8	0.89	0.91	0.91	349	2985	94.0	95.2	95.8	0.87	0.89	0.91	319
High-Output Design																	
0.75	1	2885	79.5	82.5	82.5	0.68	0.78	0.84	1.64	2910	78.4	82.3	83.1	0.60	0.72	0.79	1.59
1.1	1.5	2865	82.6	84.2	84.0	0.68	0.79	0.84	2.37	2890	81.4	84.0	84.7	0.59	0.72	0.80	2.26
1.5	2	2860	83.0	84.0	84.5	0.69	0.80	0.85	3.17	2885	83.0	84.0	84.5	0.59	0.72	0.80	3.09
4	5.5	2920	87.1	88.6	88.7	0.76	0.85	0.89	7.70	2935	86.6	88.6	89.2	0.69	0.80	0.86	7.25
5.5	7.5	2920	89.0	89.5	89.5	0.76	0.85	0.89	10.5	2935	88.5	89.5	89.5	0.68	0.79	0.85	10.1
7.5	10	2925	87.5	90.0	90.2	0.74	0.84	0.88	14.4	2940	87.5	90.0	90.2	0.65	0.77	0.83	13.9
11	15	2915	90.9	91.0	91.2	0.80	0.87	0.90	20.4	2930	90.2	91.1	91.4	0.72	0.82	0.87	19.2
15	20	2940	91.0	92.0	92.2	0.74	0.82	0.85	29.1	2950	91.0	92.0	92.2	0.68	0.80	0.83	27.3
22	30	2950	92.0	93.0	93.0	0.78	0.85	0.88	40.8	2955	92.0	93.0	93.0	0.72	0.81	0.86	38.3
200	270	2975	95.0	95.8	95.9	0.82	0.87	0.89	356	2980	95.0	95.8	95.9	0.78	0.84	0.87	333

# W21 Cast Iron Frame IE3

Output		Frame	Full Load Torque (kgfm)	Locked Rotor Current I <sub>L</sub> /I <sub>n</sub>	Locked Rotor Torque T <sub>L</sub> /T <sub>n</sub>	Break-down Torque T <sub>b</sub> /T <sub>n</sub>	Inertia J (kgm <sup>2</sup> )	Allowable locked rotor time (s)		Weight (kg)	Sound dB(A)	460 V 60Hz								
								Hot	Cold			Rated speed (rpm)	% of full load			Full load current I <sub>n</sub> (A)				
													Efficiency				Power Factor			
kW	HP											50	75	100	50	75	100			
2P-3000rpm-60HZ																				
0.75	1	80	0.260	7.5	3.5	3.5	0.0008	25	55	13.5	59.0	3450	75.5	80.0	81.5	0.62	0.74	0.81	1.43	
1.1	1.5	80	0.380	7.4	3.6	3.6	0.0009	23	51	15.0	59.0	3450	78.5	81.5	84.0	0.62	0.74	0.81	2.03	
1.5	2	90L	0.510	7.6	3.3	3.3	0.0020	15	33	18.5	62.0	3485	80.0	82.5	85.5	0.64	0.75	0.82	2.69	
2.2	3	90L	0.750	7.5	3.4	3.5	0.0026	12	26	23.5	62.0	3480	84.0	85.5	86.5	0.64	0.76	0.83	3.85	
3	4	100L	1.00	8.5	3.4	3.4	0.0064	15	33	32.0	67.0	3510	82.5	86.5	88.5	0.68	0.79	0.85	5.01	
4	5.5	112M	1.34	7.7	2.9	3.5	0.0080	22	48	41.0	64.0	3505	85.5	87.5	88.5	0.67	0.79	0.85	6.67	
5.5	7.5	132S	1.83	8.3	2.6	3.2	0.0216	23	51	65.0	67.0	3530	85.5	87.5	89.5	0.70	0.81	0.86	8.97	
7.5	10	132S	2.49	8.5	3.0	3.4	0.0252	17	37	69.0	67.0	3535	86.5	89.5	90.2	0.68	0.79	0.85	12.3	
9.2	12.5	132M	3.06	8.5	2.9	3.3	0.0306	16	35	78.0	67.0	3530	88.5	90.2	91.0	0.73	0.83	0.87	14.6	
11	15	160M	3.63	8.6	2.3	3.0	0.0506	12	26	110	70.0	3545	91.5	92.0	92.0	0.61	0.74	0.81	18.5	
15	20	160M	4.96	8.3	2.4	2.9	0.0565	11	24	115	70.0	3540	91.1	92.2	92.8	0.65	0.77	0.82	24.7	
18.5	25	160L	6.12	9.0	2.3	2.7	0.0650	11	24	136	70.0	3540	91.7	93.0	93.0	0.63	0.74	0.83	30.1	
22	30	180M	7.25	8.6	2.8	2.7	0.1192	9	20	180	70.0	3550	92.0	93.0	93.0	0.75	0.82	0.86	34.5	
30	40	200L	9.89	7.6	2.7	2.4	0.2063	35	77	245	74.0	3565	91.6	93.0	93.7	0.70	0.80	0.84	47.8	
37	50	200L	12.2	8.4	2.6	2.6	0.2242	16	35	260	74.0	3550	92.4	93.5	94.0	0.73	0.83	0.86	57.4	
45	60	225S/M	14.8	8.5	2.4	2.9	0.4961	20	44	410	82.0	3570	93.9	94.0	94.5	0.78	0.86	0.89	67.2	
55	75	250S/M	18.1	8.5	2.3	3.0	0.5303	18	40	470	82.0	3550	93.0	93.3	93.6	0.79	0.88	0.90	81.9	
75	100	280S/M	24.5	7.0	1.6	2.6	1.20	36	79	700	83.0	3575	93.0	94.5	95.0	0.78	0.86	0.89	111	
90	125	280S/M	29.5	8.0	2.2	2.8	1.31	42	92	780	83.0	3580	93.0	94.5	95.0	0.78	0.87	0.89	134	
110	150	315S/M	36.0	8.0	1.8	2.6	1.40	25	55	830	83.0	3570	94.4	95.6	95.6	0.70	0.81	0.86	168	
132	175	315S/M	43.2	7.8	1.9	2.6	1.62	30	66	900	81.0	3570	94.7	95.8	95.8	0.75	0.84	0.88	197	
160	220	315S/M	52.4	8.2	1.9	2.6	1.97	30	66	990	81.0	3570	95.1	95.9	95.9	0.73	0.83	0.88	238	
200	270	355M/L	65.3	7.7	2.2	2.7	4.85	50	110	1490	81.0	3585	93.0	94.0	95.8	0.86	0.91	0.91	288	
High-Output Design																				
0.75	1	90S	0.250	8.2	3.3	3.4	0.0015	24	53	17.0	62.0	3500	74.0	78.5	81.5	0.64	0.75	0.81	1.43	
1.1	1.5	90S	0.370	7.8	3.3	3.3	0.0018	19	42	17.5	62.0	3490	77.0	81.5	84.0	0.63	0.75	0.81	2.03	
1.5	2	90S	0.510	7.6	3.3	3.3	0.0020	15	33	18.5	62.0	3485	80.0	82.5	85.5	0.64	0.75	0.82	2.69	
4	5.5	132S	1.33	7.5	2.3	3.1	0.0180	24	53	61.0	67.0	3520	82.5	86.5	88.5	0.71	0.81	0.86	6.60	
5.5	7.5	132M	1.83	8.3	2.6	3.2	0.0216	23	51	65.0	67.0	3530	85.5	87.5	89.5	0.70	0.81	0.86	8.97	
7.5	10	132M	2.49	8.5	3.0	3.4	0.0252	17	37	69.0	67.0	3535	86.5	89.5	90.2	0.68	0.79	0.85	12.3	
11	15	132M	3.66	8.2	2.7	3.0	0.0306	11	24	78.0	67.0	3525	88.5	90.2	91.0	0.74	0.84	0.88	17.2	
15	20	160L	4.96	8.3	2.4	2.9	0.0565	11	24	115	70.0	3540	91.1	92.2	92.8	0.65	0.77	0.82	24.7	
22	30	180L	7.25	8.6	2.8	2.7	0.1192	9	20	180	70.0	3550	92.0	93.0	93.0	0.75	0.82	0.86	34.5	
200	270	315S/M	65.4	7.6	2.2	2.9	2.03	49	108	1045	81.0	3575	94.6	95.7	96.0	0.78	0.85	0.88	297	



## W21 Cast Iron Frame IE3

Output		Frame	Full Load Torque (kgfm)	Locked Rotor Current I <sub>L</sub> /I <sub>n</sub>	Locked Rotor Torque T <sub>L</sub> /T <sub>n</sub>	Break-down Torque T <sub>b</sub> /T <sub>n</sub>	Inertia J (kgm <sup>2</sup> )	Allowable locked rotor time (s)		Weight (kg)	Sound dB(A)	400 V								
								Hot	Cold			Rated speed (rpm)	% of full load			Full load current I <sub>n</sub> (A)				
													Efficiency				Power Factor			
kW	HP											50	75	100	50	75	100			
4P-1500rpm-50HZ																				
0.75	1	80	0.510	6.7	3.0	3.3	0.0032	18	40	14.5	44.0	1420	80.0	82.0	82.5	0.63	0.76	0.82	1.60	
1.1	1.5	90S	0.740	7.6	2.5	3.3	0.0055	15	33	19.5	49.0	1455	83.0	84.5	84.8	0.59	0.72	0.80	2.34	
1.5	2	90L	1.01	7.4	2.6	3.4	0.0066	13	29	23.0	49.0	1450	84.0	86.0	86.0	0.58	0.72	0.80	3.15	
2.2	3	100L	1.49	7.4	3.2	3.5	0.0090	18	40	31.5	53.0	1435	86.5	87.0	87.0	0.60	0.73	0.80	4.56	
3	4	100L	2.03	7.8	3.5	3.7	0.0120	15	33	40.0	53.0	1440	87.0	88.0	88.0	0.60	0.73	0.80	6.15	
4	5.5	112M	2.69	7.0	2.3	3.1	0.0182	15	33	44.0	56.0	1450	86.0	88.0	88.8	0.60	0.72	0.79	8.03	
5.5	7.5	132M	3.66	8.5	2.4	3.4	0.0528	15	33	69.0	56.0	1465	87.5	89.0	89.8	0.67	0.79	0.85	10.4	
5.5	7.5	132S	3.66	8.5	2.4	3.4	0.0528	15	33	69.0	56.0	1465	87.5	89.0	89.8	0.67	0.79	0.85	10.4	
7.5	10	132M	4.99	8.5	2.5	3.4	0.0642	13	29	78.0	56.0	1465	87.5	90.0	90.6	0.67	0.78	0.84	14.2	
11	15	160M	7.29	7.5	2.8	3.0	0.1071	12	26	135	62.0	1470	89.5	91.0	91.5	0.62	0.73	0.80	21.7	
15	20	160L	9.97	6.3	2.0	2.4	0.1263	11	24	130	62.0	1465	89.7	91.2	92.1	0.65	0.76	0.82	28.7	
18.5	25	180M	12.3	8.3	2.7	2.8	0.2088	12	26	175	64.0	1470	91.0	92.2	92.6	0.70	0.81	0.85	33.9	
22	30	180L	14.5	8.6	2.8	2.9	0.2393	11	24	225	64.0	1475	92.0	93.0	93.1	0.68	0.78	0.84	40.6	
30	40	200L	19.7	7.3	2.7	2.9	0.3861	19	42	280	67.0	1480	93.0	93.5	93.7	0.65	0.76	0.82	56.4	
37	50	225S/M	24.4	7.2	2.2	2.7	0.6999	14	31	380	70.0	1475	92.5	94.0	94.0	0.77	0.85	0.88	63.9	
45	60	225S/M	29.6	7.5	2.5	2.8	0.8398	17	37	400	70.0	1480	93.0	94.0	94.2	0.76	0.84	0.87	79.3	
55	75	250S/M	36.2	8.0	2.8	3.0	1.15	9	20	470	70.0	1480	93.0	94.2	94.6	0.70	0.80	0.85	98.7	
75	100	280S/M	49.2	7.4	2.2	2.4	2.11	21	46	660	70.0	1485	93.7	94.7	95.2	0.77	0.85	0.87	131	
90	125	280S/M	59.0	8.1	2.4	2.6	2.72	22	48	800	70.0	1485	94.0	95.0	95.3	0.78	0.85	0.88	155	
110	150	315S/M	72.2	8.0	2.4	2.6	3.33	29	64	860	77.0	1485	94.1	95.2	95.6	0.75	0.84	0.87	191	
132	175	315S/M	86.6	8.3	2.5	2.6	3.63	34	75	1000	77.0	1485	95.0	95.7	95.7	0.76	0.85	0.87	229	
160	220	315S/M	105	8.2	2.4	2.7	3.80	18	40	1000	77.0	1485	95.2	95.7	95.9	0.75	0.84	0.87	277	
200	270	355M/L	131	6.6	2.1	2.3	7.58	40	88	1525	79.0	1490	95.0	95.7	96.0	0.79	0.85	0.87	346	
250	340	355M/L	163	7.3	2.3	2.4	8.39	16	35	1380	79.0	1490	95.4	96.0	96.2	0.73	0.82	0.85	441	
300	400	355M/L	196	8.3	2.2	2.2	10.3	17	37	1750	79.0	1490	95.3	96.0	96.3	0.78	0.85	0.89	505	
315	430	355M/L	206	8.1	2.1	2.7	10.8	33	73	1770	79.0	1490	95.4	96.0	96.3	0.78	0.85	0.88	537	
High-Output Design																				
0.75	1	90S	0.500	7.8	2.4	3.3	0.0049	21	46	18.5	49.0	1455	82.5	84.0	84.5	0.60	0.73	0.80	1.60	
1.5	2	100L	1.01	7.7	3.1	3.4	0.0082	25	55	30.0	53.0	1440	86.0	87.0	87.0	0.61	0.73	0.80	3.11	
2.2	3	112M	1.48	6.8	2.0	3.0	0.0143	31	68	41.0	56.0	1450	87.5	88.2	88.2	0.62	0.74	0.81	4.44	
3	4	112M	2.01	7.1	2.3	3.1	0.0169	25	55	43.0	56.0	1455	88.5	89.1	89.1	0.62	0.74	0.81	6.00	
110	150	280S/M	72.2	8.0	2.4	2.6	3.33	29	64	860	77.0	1485	94.1	95.2	95.6	0.75	0.84	0.87	191	
200	270	315S/M*	131	7.8	2.4	2.6	3.80	14	31	1005	77.0	1485	95.0	95.7	96.0	0.76	0.84	0.87	346	

# W21 Cast Iron Frame IE3

Output		380 V									415 V								
		Rated speed (rpm)	% of full load						Full load current In (A)	Rated speed (rpm)	% of full load						Full load current In (A)		
			Efficiency			Power Factor					Efficiency			Power Factor					
kW	HP	50	75	100	50	75	100	50	75	100	50	75	100	50	75	100			
4P-1500rpm-50HZ																			
0.75	1	1410	80.8	82.0	82.5	0.68	0.79	0.84	1.64	1425	79.1	81.8	82.8	0.60	0.73	0.80	1.58		
1.1	1.5	1450	84.0	84.7	84.3	0.64	0.76	0.83	2.39	1460	82.0	84.1	84.8	0.55	0.69	0.77	2.34		
1.5	2	1445	85.0	86.2	85.6	0.63	0.76	0.83	3.21	1455	83.1	85.7	86.1	0.54	0.68	0.77	3.15		
2.2	3	1430	87.2	87.1	86.7	0.65	0.77	0.83	4.64	1440	85.7	86.8	87.2	0.57	0.70	0.78	4.50		
3	4	1430	87.7	88.0	87.7	0.65	0.77	0.83	6.26	1445	86.3	87.7	88.1	0.56	0.70	0.78	6.07		
4	5.5	1445	86.0	88.0	88.8	0.65	0.76	0.81	8.25	1455	86.0	88.0	88.8	0.57	0.70	0.77	7.93		
5.5	7.5	1460	88.5	89.0	89.8	0.71	0.82	0.87	10.7	1470	86.5	89.0	89.8	0.64	0.76	0.83	10.3		
5.5	7.5	1460	88.5	89.0	89.8	0.71	0.82	0.87	10.7	1470	86.5	89.0	89.8	0.64	0.76	0.83	10.3		
7.5	10	1460	88.5	90.0	90.6	0.71	0.81	0.86	14.6	1470	86.5	90.0	90.6	0.63	0.75	0.83	13.9		
11	15	1465	89.5	91.0	91.5	0.64	0.75	0.82	22.3	1475	89.5	91.0	91.5	0.60	0.70	0.78	21.4		
15	20	1460	89.7	91.2	92.1	0.70	0.79	0.84	29.5	1470	89.7	91.2	92.1	0.60	0.73	0.80	28.3		
18.5	25	1465	91.0	92.2	92.6	0.73	0.84	0.87	34.9	1475	91.0	92.2	92.6	0.65	0.78	0.84	33.1		
22	30	1470	92.0	93.0	93.1	0.70	0.80	0.85	42.2	1475	91.5	93.0	93.1	0.66	0.76	0.83	39.6		
30	40	1475	93.0	93.5	93.7	0.69	0.79	0.84	57.9	1480	93.0	93.5	93.7	0.60	0.73	0.80	55.7		
37	50	1475	92.5	94.0	94.0	0.78	0.86	0.89	66.6	1480	92.4	94.0	94.0	0.76	0.84	0.87	62.4		
45	60	1475	93.0	94.0	94.2	0.76	0.85	0.88	82.5	1480	93.0	94.0	94.2	0.72	0.83	0.86	77.3		
55	75	1480	93.0	94.2	94.6	0.74	0.82	0.86	103	1485	93.0	94.2	94.6	0.71	0.80	0.84	96.3		
75	100	1480	93.7	94.7	95.2	0.79	0.86	0.88	136	1485	93.7	94.7	95.2	0.75	0.84	0.86	127		
90	125	1485	94.0	95.0	95.3	0.80	0.86	0.89	161	1485	94.0	95.0	95.3	0.75	0.84	0.87	151		
110	150	1480	94.1	95.3	95.6	0.76	0.85	0.88	199	1485	94.1	95.2	95.6	0.73	0.83	0.86	186		
132	175	1480	95.0	95.7	95.7	0.78	0.86	0.88	238	1485	95.0	95.7	95.7	0.73	0.84	0.86	223		
160	220	1480	95.2	95.7	95.9	0.77	0.85	0.88	288	1485	95.0	95.7	95.9	0.70	0.83	0.85	273		
200	270	1485	95.0	95.7	96.0	0.81	0.86	0.88	360	1490	94.7	95.7	96.0	0.77	0.84	0.86	337		
250	340	1490	95.4	96.0	96.2	0.76	0.84	0.86	459	1490	95.2	96.0	96.2	0.70	0.80	0.84	430		
300	400	1490	95.3	96.0	96.3	0.80	0.86	0.90	526	1490	95.2	96.0	96.3	0.75	0.84	0.88	492		
315	430	1490	95.4	96.0	96.3	0.81	0.86	0.88	565	1490	95.4	96.0	96.3	0.75	0.83	0.87	523		
High-Output Design																			
0.75	1	1450	83.2	84.1	84.0	0.64	0.76	0.83	1.63	1460	81.8	83.8	84.6	0.56	0.70	0.78	1.58		
1.5	2	1430	86.5	86.9	86.4	0.65	0.77	0.83	3.18	1445	85.6	87.0	87.3	0.58	0.71	0.78	3.06		
2.2	3	1445	87.9	88.1	87.6	0.66	0.77	0.83	4.60	1455	87.2	88.2	88.5	0.59	0.72	0.79	4.38		
3	4	1450	88.6	89.0	89.0	0.66	0.77	0.83	6.17	1460	88.1	89.1	89.1	0.59	0.71	0.79	5.93		
110	150	1480	94.1	95.3	95.6	0.76	0.85	0.88	199	1485	94.1	95.2	95.6	0.73	0.83	0.86	186		
200	270	1480	95.0	95.7	96.0	0.79	0.86	0.88	360	1485	94.7	95.7	96.0	0.73	0.82	0.86	337		



## W21 Cast Iron Frame IE3

Output		Frame	Full Load Torque (kgfm)	Locked Rotor Current I/In	Locked Rotor Torque Tl/Tn	Break-down Torque Tb/Tn	Inertia J (kgm²)	Allowable locked rotor time (s)		Weight (kg)	Sound dB(A)	460 V 60Hz								
												Rated speed (rpm)	% of full load			Full load current In (A)				
													Efficiency			Power Factor				
kW	HP							Hot	Cold			50	75	100	50	75	100			
4P-1500rpm-60HZ																				
0.75	1	80	0.510	6.7	3.0	3.3	0.0032	18	40	14.5	44.0	1720	78.5	80.0	84.0	0.62	0.75	0.80	1.40	
1.1	1.5	90S	0.740	7.6	2.5	3.3	0.0055	15	33	19.5	49.0	1760	80.0	84.0	86.5	0.57	0.70	0.78	2.05	
1.5	2	90L	1.01	7.4	2.6	3.4	0.0066	13	29	23.0	49.0	1755	82.5	85.5	86.5	0.56	0.69	0.78	2.79	
2.2	3	100L	1.49	7.4	3.2	3.5	0.0090	18	40	31.5	53.0	1745	84.0	86.5	88.5	0.58	0.71	0.78	4.00	
3	4	100L	2.03	7.8	3.5	3.7	0.0120	15	33	40.0	53.0	1740	84.0	86.5	89.5	0.59	0.71	0.79	5.33	
4	5.5	112M	2.69	7.0	2.3	3.1	0.0182	15	33	44.0	56.0	1755	87.5	89.5	89.5	0.58	0.70	0.77	7.10	
5.5	7.5	132M	3.66	8.5	2.4	3.4	0.0528	15	33	69.0	56.0	1765	88.5	91.0	91.7	0.65	0.77	0.83	9.07	
5.5	7.5	132S	3.66	8.5	2.4	3.4	0.0528	15	33	69.0	56.0	1765	88.5	91.0	91.7	0.65	0.77	0.83	9.07	
7.5	10	132M	4.99	8.5	2.5	3.4	0.0642	13	29	78.0	56.0	1770	91.0	91.5	92.0	0.65	0.76	0.83	12.3	
11	15	160M	7.29	7.5	2.8	3.0	0.1071	12	26	135	62.0	1770	89.6	92.2	92.7	0.56	0.70	0.77	19.3	
15	20	160L	9.97	6.3	2.0	2.4	0.1263	11	24	130	62.0	1760	88.1	91.1	93.0	0.61	0.75	0.80	25.3	
18.5	25	180M	12.3	8.3	2.7	2.8	0.2088	12	26	175	64.0	1750	90.7	93.1	93.6	0.65	0.78	0.84	29.5	
22	30	180L	14.5	8.6	2.8	2.9	0.2393	11	24	225	64.0	1755	91.6	93.8	93.8	0.63	0.76	0.82	35.9	
30	40	200L	19.7	7.3	2.7	2.9	0.3861	19	42	280	67.0	1760	92.5	94.0	94.2	0.59	0.71	0.78	51.2	
37	50	225S/M	24.4	7.2	2.2	2.7	0.6999	14	31	380	70.0	1780	92.6	94.4	94.5	0.73	0.83	0.85	57.8	
45	60	225S/M	29.6	7.5	2.5	2.8	0.8398	17	37	400	70.0	1780	92.7	94.4	95.0	0.70	0.82	0.86	69.1	
55	75	250S/M	36.2	8.0	2.8	3.0	1.15	9	20	470	70.0	1780	92.9	94.7	95.4	0.68	0.79	0.84	86.1	
75	100	280S/M	49.2	7.4	2.2	2.4	2.11	21	46	660	70.0	1780	93.6	95.3	95.7	0.73	0.83	0.87	113	
90	125	280S/M	59.0	8.1	2.4	2.6	2.72	22	48	800	70.0	1780	93.8	95.5	95.9	0.72	0.83	0.87	135	
110	150	315S/M	72.2	8.0	2.4	2.6	3.33	29	64	860	77.0	1775	93.3	95.3	95.9	0.70	0.81	0.86	167	
132	175	315S/M	86.6	8.3	2.5	2.6	3.63	34	75	1000	77.0	1775	94.5	96.1	96.4	0.71	0.82	0.86	200	
160	220	315S/M	105	8.2	2.4	2.7	3.80	18	40	1000	77.0	1780	94.7	96.2	96.2	0.70	0.80	0.85	246	
200	270	355M/L	131	6.6	2.1	2.3	7.58	40	88	1525	79.0	1790	93.8	95.3	96.2	0.76	0.85	0.87	300	
250	340	355M/L	163	7.3	2.3	2.4	8.39	16	35	1380	79.0	1790	94.2	96.0	96.2	0.72	0.81	0.85	384	
300	400	355M/L	196	8.3	2.2	2.2	10.3	17	37	1750	79.0	1785	94.8	96.4	96.6	0.72	0.83	0.88	443	
315	430	355M/L	206	8.1	2.1	2.7	10.8	33	73	1770	79.0	1790	95.0	96.4	96.6	0.76	0.84	0.87	470	
High-Output Design																				
0.75	1	90S	0.500	7.8	2.4	3.3	0.0049	21	46	18.5	49.0	1760	80.0	82.5	85.5	0.57	0.70	0.78	1.41	
1.5	2	100L	1.01	7.7	3.1	3.4	0.0082	25	55	30.0	53.0	1750	84.0	85.5	86.5	0.58	0.71	0.78	2.79	
2.2	3	112M	1.48	6.8	2.0	3.0	0.0143	31	68	41.0	56.0	1760	85.5	87.5	89.5	0.59	0.72	0.79	3.91	
3	4	112M	2.01	7.1	2.3	3.1	0.0169	25	55	43.0	56.0	1760	86.5	88.5	89.5	0.59	0.72	0.79	5.33	
110	150	280S/M	72.2	8.0	2.4	2.6	3.33	29	64	860	77.0	1775	93.3	95.3	95.9	0.70	0.81	0.86	167	
200	270	315S/M*	131	7.8	2.4	2.6	3.80	14	31	1005	77.0	1780	94.4	95.8	96.2	0.73	0.82	0.86	303	



# W21 Cast Iron Frame IE3

Output		Frame	Full Load Torque (kgfm)	Locked Rotor Current I <sub>L</sub> /I <sub>n</sub>	Locked Rotor Torque T <sub>L</sub> /T <sub>n</sub>	Break-down Torque T <sub>b</sub> /T <sub>n</sub>	Inertia J (kgm <sup>2</sup> )	Allowable locked rotor time (s)		Weight (kg)	Sound dB(A)	400 V							Full load current I <sub>n</sub> (A)
								Hot	Cold			Rated speed (rpm)	% of full load			Power Factor			
													Efficiency			Power Factor			
kW	HP											50	75	100	50	75	100		
6P-1000rpm-50HZ																			
0.75	1	90S	0.780	5.2	2.5	2.8	0.0066	31	68	22.0	45.0	940	77.0	78.0	79.0	0.49	0.62	0.71	1.93
1.1	1.5	100L	1.13	4.9	2.0	2.4	0.0110	32	70	28.5	44.0	945	80.5	81.0	81.0	0.51	0.65	0.73	2.69
1.5	2	100L	1.54	5.5	2.3	2.8	0.0143	31	68	32.0	44.0	950	79.0	81.0	82.5	0.49	0.62	0.71	3.70
2.2	3	112M	2.26	6.0	2.5	2.6	0.0257	26	57	42.0	48.0	950	81.0	83.5	84.3	0.53	0.64	0.72	5.23
3	4	132M	3.01	6.0	1.9	2.5	0.0566	28	62	61.0	53.0	970	84.0	85.0	85.6	0.52	0.65	0.73	6.93
3	4	132S	3.01	6.0	1.9	2.5	0.0566	28	62	61.0	53.0	970	84.0	85.0	85.6	0.52	0.65	0.73	6.93
4	5.5	132M	4.06	6.5	2.2	2.5	0.0566	30	66	66.0	52.0	960	85.0	86.0	86.8	0.53	0.66	0.74	8.99
5.5	7.5	132M/L	5.55	7.0	2.5	2.8	0.0755	26	57	80.0	52.0	965	86.0	87.0	88.0	0.50	0.64	0.72	12.5
7.5	10	160M	7.53	6.6	2.5	2.9	0.1614	19	42	106	56.0	970	86.0	88.5	89.1	0.61	0.74	0.81	15.0
11	15	160L	11.1	7.0	2.8	3.0	0.1891	13	29	136	56.0	970	89.0	90.0	90.3	0.60	0.73	0.80	22.0
15	20	180L	15.0	7.7	2.6	3.2	0.3310	10	22	193	56.0	975	90.5	91.0	91.2	0.65	0.78	0.84	28.3
18.5	25	200L	18.5	6.3	2.3	2.5	0.3861	17	37	219	58.0	975	90.5	91.8	92.0	0.65	0.76	0.82	35.4
22	30	200L	22.0	6.2	2.3	2.6	0.4388	15	33	228	58.0	975	90.4	92.0	92.2	0.65	0.75	0.82	42.0
30	40	225S/M	29.7	7.0	2.6	2.6	0.9716	21	46	366	61.0	985	91.0	92.2	93.0	0.73	0.81	0.85	54.8
37	50	250S/M	36.8	7.0	2.5	2.6	1.29	20	44	450	61.0	980	91.0	93.2	93.5	0.72	0.81	0.84	68.0
45	60	280S/M	44.3	6.8	2.1	2.8	2.36	27	59	610	66.0	990	93.2	93.7	93.7	0.67	0.77	0.82	84.5
55	75	280S/M	54.1	7.0	2.5	3.2	2.81	21	46	655	66.0	990	93.5	94.0	94.2	0.64	0.75	0.81	104
75	100	315S/M	73.8	7.7	2.9	3.5	3.59	15	33	725	69.0	990	93.7	94.3	94.6	0.62	0.73	0.81	141
90	125	315S/M	88.6	7.8	2.8	3.3	5.05	16	35	810	69.0	990	94.3	94.8	95.0	0.66	0.77	0.82	167
110	150	355M/L	108	6.7	2.2	3.0	9.28	40	88	1460	69.0	995	93.7	95.0	95.2	0.59	0.71	0.78	214
132	175	355M/L	129	6.2	2.0	2.7	10.4	40	88	1600	73.0	995	94.2	95.2	95.5	0.63	0.74	0.80	249
150	200	355M/L	147	6.6	2.2	2.8	11.1	60	132	1650	73.0	995	94.4	95.3	95.7	0.61	0.73	0.79	286
160	220	355M/L	157	6.2	2.0	2.6	11.1	60	132	1650	73.0	995	94.4	95.3	95.7	0.63	0.74	0.80	302
185	250	355M/L	181	6.0	1.9	2.5	11.6	60	132	1700	73.0	995	94.7	95.6	95.8	0.65	0.76	0.81	344
220	300	355M/L	215	5.7	1.9	2.3	13.5	60	132	1795	73.0	995	95.0	95.6	95.8	0.68	0.77	0.82	404
250	340	355M/L	246	6.1	2.1	2.6	14.4	60	132	1890	73.0	990	95.0	95.7	95.8	0.64	0.74	0.80	471
High-Output Design																			
1.1	1.5	112M	1.12	5.9	2.3	2.8	0.0220	634	1395	39.0	48.0	955	84.0	85.0	85.0	0.52	0.64	0.72	2.59
1.5	2	112M	1.52	6.0	2.1	2.8	0.0202	28	62	42.0	52.0	960	84.5	85.5	85.5	0.51	0.63	0.71	3.57
2.2	3	132S	2.21	5.7	1.8	2.7	0.0491	30	66	63.0	53.0	970	86.0	87.5	87.5	0.52	0.64	0.72	5.04
75	100	280S/M	73.8	7.7	2.9	3.5	3.59	15	33	725	69.0	990	93.7	94.3	94.6	0.62	0.73	0.81	141



## W21 Cast Iron Frame IE3

Output		380 V									415 V								
		Rated speed (rpm)	% of full load						Full load current In (A)	Rated speed (rpm)	% of full load						Full load current In (A)		
			Efficiency			Power Factor					Efficiency			Power Factor					
kW	HP	50	75	100	50	75	100	50	75	100	50	75	100	50	75	100			
6P-1000rpm-50HZ																			
0.75	1	930	77.0	78.0	79.0	0.53	0.66	0.74	1.95	945	77.0	78.0	79.0	0.46	0.59	0.69	1.91		
1.1	1.5	940	81.2	80.9	81.0	0.55	0.68	0.75	2.75	950	79.9	80.9	81.5	0.48	0.62	0.70	2.68		
1.5	2	945	79.0	80.5	82.5	0.53	0.66	0.74	3.73	955	79.0	80.0	82.5	0.46	0.59	0.68	3.72		
2.2	3	945	80.5	83.5	84.3	0.57	0.68	0.75	5.29	955	80.0	83.5	84.3	0.50	0.62	0.70	5.19		
3	4	965	84.0	85.0	85.6	0.56	0.69	0.76	7.01	975	83.0	85.0	85.6	0.49	0.62	0.71	6.87		
3	4	965	84.0	85.0	85.6	0.56	0.69	0.76	7.01	975	83.0	85.0	85.6	0.49	0.62	0.71	6.87		
4	5.5	955	85.0	86.0	86.8	0.57	0.70	0.76	9.21	965	85.0	86.0	86.8	0.50	0.63	0.71	9.03		
5.5	7.5	960	85.5	87.0	88.0	0.55	0.68	0.75	12.7	965	86.0	87.0	88.0	0.47	0.61	0.69	12.6		
7.5	10	965	86.5	88.5	89.1	0.65	0.77	0.82	15.6	975	85.5	88.5	89.1	0.58	0.71	0.79	14.8		
11	15	970	89.0	90.0	90.3	0.65	0.77	0.83	22.3	975	89.0	90.0	90.3	0.57	0.70	0.78	21.7		
15	20	970	90.0	91.0	91.2	0.68	0.80	0.85	29.4	975	90.5	91.0	91.2	0.69	0.80	0.85	26.9		
18.5	25	970	90.5	91.8	92.0	0.69	0.79	0.84	36.4	980	90.0	91.8	92.0	0.64	0.75	0.80	35.0		
22	30	970	91.0	92.0	92.2	0.70	0.78	0.84	43.2	980	89.5	91.5	92.2	0.60	0.72	0.80	41.5		
30	40	980	91.0	92.2	93.0	0.76	0.84	0.86	57.0	985	90.5	92.2	93.0	0.70	0.79	0.84	53.4		
37	50	980	91.0	93.2	93.4	0.75	0.83	0.86	70.0	985	91.0	93.2	93.5	0.69	0.79	0.82	67.1		
45	60	985	93.2	93.7	93.7	0.70	0.79	0.83	87.9	990	93.0	93.7	93.7	0.64	0.75	0.80	83.5		
55	75	985	93.5	94.0	94.2	0.67	0.77	0.82	108	990	93.0	94.0	94.2	0.61	0.72	0.79	103		
75	100	990	93.7	94.3	94.6	0.66	0.77	0.82	147	990	93.3	94.3	94.6	0.58	0.70	0.78	141		
90	125	990	94.3	94.8	95.0	0.70	0.79	0.84	171	990	94.3	94.8	95.0	0.63	0.75	0.81	163		
110	150	995	94.0	95.0	95.2	0.63	0.74	0.80	219	995	93.4	94.5	95.2	0.56	0.68	0.76	212		
132	175	990	94.5	95.2	95.5	0.66	0.76	0.81	259	995	94.0	95.2	95.5	0.60	0.72	0.78	247		
150	200	995	94.5	95.3	95.7	0.65	0.76	0.81	294	995	94.1	95.2	95.7	0.58	0.71	0.77	283		
160	220	995	94.5	95.3	95.7	0.67	0.77	0.82	310	995	94.1	95.2	95.7	0.60	0.72	0.79	294		
185	250	995	95.1	95.6	95.8	0.70	0.78	0.82	358	995	94.4	95.4	95.8	0.60	0.74	0.79	340		
220	300	995	95.1	95.6	95.8	0.71	0.79	0.83	420	995	94.9	95.6	95.8	0.65	0.75	0.81	394		
250	340	990	95.0	95.7	95.8	0.68	0.77	0.82	484	990	94.6	95.7	95.8	0.60	0.72	0.78	465		
High-Output Design																			
1.1	1.5	950	85.0	85.4	85.0	0.55	0.70	0.77	2.55	955	83.2	84.5	84.9	0.48	0.62	0.70	2.58		
1.5	2	955	85.1	85.4	84.9	0.54	0.66	0.74	3.63	960	84.0	85.4	85.8	0.48	0.60	0.69	3.52		
2.2	3	965	86.5	87.5	87.1	0.55	0.67	0.74	5.19	973	85.6	87.4	87.7	0.48	0.61	0.70	4.99		
75	100	990	93.7	94.3	94.6	0.66	0.77	0.82	147	990	93.3	94.3	94.6	0.58	0.70	0.78	141		

# W21 Cast Iron Frame IE3

Output		Frame	Full Load Torque (kgfm)	Locked Rotor Current I <sub>L</sub> /I <sub>n</sub>	Locked Rotor Torque T <sub>L</sub> /T <sub>n</sub>	Break-down Torque T <sub>b</sub> /T <sub>n</sub>	Inertia J (kgm <sup>2</sup> )	Allowable locked rotor time (s)		Weight (kg)	Sound dB(A)	460 V 60Hz							Full load current I <sub>n</sub> (A)
								Hot	Cold			Rated speed (rpm)	% of full load			Power Factor			
													Efficiency			Power Factor			
kW	HP											50	75	100	50	75	100		
6P-1000rpm-60HZ																			
0.75	1	90S	0.780	5.2	2.5	2.8	0.0066	31	68	22.0	45.0	1145	77.0	80.0	82.5	0.47	0.60	0.69	1.65
1.1	1.5	100L	1.13	4.9	2.0	2.4	0.0110	32	70	28.5	44.0	1150	82.5	83.0	84.0	0.50	0.63	0.70	2.35
1.5	2	100L	1.54	5.5	2.3	2.8	0.0143	31	68	32.0	44.0	1155	82.5	85.5	86.5	0.48	0.61	0.69	3.15
2.2	3	112M	2.26	6.0	2.5	2.6	0.0257	26	57	42.0	48.0	1155	82.5	85.5	87.5	0.50	0.62	0.71	4.44
3	4	132M	3.01	6.0	1.9	2.5	0.0566	28	62	61.0	53.0	1170	85.5	88.5	89.5	0.49	0.62	0.70	6.01
3	4	132S	3.01	6.0	1.9	2.5	0.0566	28	62	61.0	53.0	1170	85.5	88.5	89.5	0.49	0.62	0.70	6.01
4	5.5	132M	4.06	6.5	2.2	2.5	0.0566	30	66	66.0	52.0	1165	85.5	88.5	89.5	0.50	0.63	0.71	7.90
5.5	7.5	132M/L	5.55	7.0	2.5	2.8	0.0755	26	57	80.0	52.0	1170	85.5	88.5	91.0	0.48	0.61	0.70	10.8
7.5	10	160M	7.53	6.6	2.5	2.9	0.1614	19	42	106	56.0	1170	86.3	89.1	91.0	0.58	0.71	0.78	13.3
11	15	160L	11.1	7.0	2.8	3.0	0.1891	13	29	136	56.0	1175	89.2	91.4	91.7	0.58	0.71	0.78	19.3
15	20	180L	15.0	7.7	2.6	3.2	0.3310	10	22	193	56.0	1180	91.0	91.7	91.7	0.68	0.79	0.83	24.7
18.5	25	200L	18.5	6.3	2.3	2.5	0.3861	17	37	219	58.0	1175	90.3	91.7	93.0	0.64	0.76	0.82	30.4
22	30	200L	22.0	6.2	2.3	2.6	0.4388	15	33	228	58.0	1175	90.1	92.4	93.0	0.62	0.74	0.80	37.1
30	40	225S/M	29.7	7.0	2.6	2.6	0.9716	21	46	366	61.0	1185	90.5	92.6	94.1	0.69	0.80	0.84	47.6
37	50	250S/M	36.8	7.0	2.5	2.6	1.29	20	44	450	61.0	1175	91.2	93.4	94.1	0.69	0.79	0.83	59.5
45	60	280S/M	44.3	6.8	2.1	2.8	2.36	27	59	610	66.0	1185	92.7	94.0	94.5	0.63	0.75	0.81	73.8
55	75	280S/M	54.1	7.0	2.5	3.2	2.81	21	46	655	66.0	1190	93.0	94.5	94.8	0.61	0.73	0.79	92.2
75	100	315S/M	73.8	7.7	2.9	3.5	3.59	15	33	725	69.0	1190	93.2	95.3	95.3	0.59	0.72	0.79	125
90	125	315S/M	88.6	7.8	2.8	3.3	5.05	16	35	810	69.0	1190	94.5	95.0	95.3	0.63	0.75	0.81	146
110	150	355M/L	108	6.7	2.2	3.0	9.28	40	88	1460	69.0	1195	92.2	94.9	95.8	0.56	0.68	0.76	190
132	175	355M/L	129	6.2	2.0	2.7	10.4	40	88	1600	73.0	1195	94.0	95.3	95.8	0.61	0.72	0.78	222
150	200	355M/L	147	6.6	2.2	2.8	11.1	60	132	1650	73.0	425	94.0	95.3	96.3	0.64	0.69	0.75	261
160	220	355M/L	157	6.2	2.0	2.6	11.1	60	132	1650	73.0	1195	94.2	95.7	96.3	0.62	0.73	0.79	264
185	250	355M/L	181	6.0	1.9	2.5	11.6	60	132	1700	73.0	1190	94.5	95.7	96.2	0.62	0.74	0.80	302
220	300	355M/L	215	5.7	1.9	2.3	13.5	60	132	1795	73.0	1190	95.0	96.0	96.3	0.65	0.76	0.81	354
250	340	355M/L	246	6.1	2.1	2.6	14.4	60	132	1890	73.0	1190	95.0	95.9	96.3	0.61	0.73	0.79	412
High-Output Design																			
1.1	1.5	112M	1.12	5.9	2.3	2.8	0.0220	634	1395	39.0	48.0	1165	82.5	85.5	87.5	0.49	0.61	0.69	2.29
1.5	2	112M	1.52	6.0	2.1	2.8	0.0202	28	62	42.0	52.0	1165	82.5	86.5	88.5	0.49	0.61	0.69	3.08
2.2	3	132S	2.21	5.7	1.8	2.7	0.0491	30	66	63.0	53.0	1175	84.0	87.5	89.5	0.49	0.62	0.70	4.41
75	100	280S/M	73.8	7.7	2.9	3.5	3.59	15	33	725	69.0	1190	93.2	95.3	95.3	0.59	0.72	0.79	125



## W21 Cast Iron Frame IE3

Output		Frame	Full Load Torque (kgfm)	Locked Rotor Current I <sub>L</sub> /I <sub>n</sub>	Locked Rotor Torque T <sub>L</sub> /T <sub>n</sub>	Break-down Torque T <sub>b</sub> /T <sub>n</sub>	Inertia J (kgm <sup>2</sup> )	Allowable locked rotor time (s)		Weight (kg)	Sound dB(A)	400 V								
								Hot	Cold			Rated speed (rpm)	% of full load			Full load current I <sub>n</sub> (A)				
													Efficiency				Power Factor			
kW	HP											50	75	100	50	75	100			
8P-750rpm-50HZ																				
0.75	1	100L	1.03	4.6	1.9	2.3	0.0127	30	66	30.5	50.0	710	72.5	75.5	75.5	0.41	0.53	0.62	2.31	
1.1	1.5	100L	1.52	4.6	2.1	2.4	0.0143	30	66	33.0	50.0	705	73.0	76.0	76.0	0.41	0.53	0.62	3.37	
1.5	2	112M	2.07	5.0	2.5	2.8	0.0238	28	62	43.0	46.0	705	79.0	80.5	80.5	0.45	0.59	0.68	3.96	
2.2	3	132S	3.02	6.2	2.3	2.5	0.0690	27	59	69.0	48.0	710	82.0	82.6	82.6	0.51	0.65	0.72	5.34	
3	4	132M	4.12	6.4	2.4	2.6	0.0838	21	46	75.0	48.0	710	82.5	83.5	83.5	0.51	0.64	0.72	7.20	
4	5.5	160M	5.34	5.2	2.5	2.8	0.1221	27	59	110	51.0	730	83.0	86.2	86.6	0.40	0.52	0.62	10.8	
5.5	7.5	160M	7.34	5.6	2.3	2.6	0.1652	22	48	130	51.0	730	85.0	87.7	87.7	0.42	0.55	0.65	13.9	
7.5	10	160L	10.1	5.2	2.0	2.4	0.1652	19	42	145	51.0	725	87.5	88.9	88.9	0.54	0.66	0.73	16.7	
11	15	180L	14.8	7.5	2.4	2.6	0.3034	12	26	183	51.0	725	90.0	90.3	90.3	0.62	0.73	0.80	22.0	
15	20	200L	19.9	5.0	2.0	2.2	0.5023	28	62	300	53.0	735	89.5	90.5	90.9	0.53	0.65	0.71	33.5	
18.5	25	225S/M	24.5	7.5	2.1	2.8	0.8472	18	40	340	60.0	735	90.5	92.0	92.0	0.65	0.76	0.82	35.4	
22	30	225S/M	29.2	8.5	2.1	3.0	1.20	164	361	365	60.0	735	91.5	92.5	92.6	0.65	0.76	0.82	41.8	
30	40	250S/M	39.8	8.7	2.5	3.2	1.22	17	37	440	60.0	735	91.5	93.2	93.2	0.62	0.74	0.81	57.4	
37	50	280S/M	48.7	6.5	1.9	2.2	2.64	32	70	590	62.0	740	92.6	93.7	93.9	0.63	0.74	0.80	71.1	
45	60	280S/M	59.2	6.5	2.0	2.4	3.10	32	70	650	62.0	740	93.0	94.2	94.2	0.62	0.73	0.79	87.3	
55	75	280S/M	72.4	7.0	2.0	2.6	3.45	32	70	730	62.0	740	93.8	94.6	94.6	0.57	0.69	0.76	110	
55	75	315S/M	72.4	7.0	2.0	2.6	3.45	32	70	730	62.0	740	93.8	94.6	94.6	0.57	0.69	0.76	110	
75	100	315S/M	98.7	7.0	1.9	2.6	4.37	20	44	876	62.0	740	94.5	95.2	95.2	0.60	0.72	0.77	148	

## W21 Cast Iron Frame IE3

Output		380 V								415 V							
		Rated speed (rpm)	% of full load						Full load current In (A)	Rated speed (rpm)	% of full load						Full load current In (A)
			Efficiency			Power Factor					Efficiency			Power Factor			
kW	HP	50	75	100	50	75	100	50	75	100	50	75	100	50	75	100	
8P-750rpm-50HZ																	
0.75	1	705	73.9	76.1	75.1	0.44	0.57	0.66	2.30	715	71.1	74.8	75.5	0.38	0.50	0.59	2.34
1.1	1.5	700	74.9	76.8	75.8	0.45	0.58	0.66	3.34	710	71.1	74.9	75.7	0.38	0.50	0.59	3.43
1.5	2	700	79.9	80.6	79.8	0.49	0.63	0.71	4.02	710	77.9	80.2	80.8	0.42	0.56	0.65	3.97
2.2	3	705	82.9	82.6	81.9	0.57	0.68	0.76	5.37	715	81.2	82.3	82.9	0.48	0.62	0.70	5.27
3	4	705	83.4	83.7	82.9	0.56	0.68	0.75	7.33	715	81.5	83.2	83.7	0.48	0.61	0.70	7.12
4	5.5	730	84.0	86.2	86.6	0.44	0.57	0.66	10.6	735	82.0	86.2	86.6	0.37	0.49	0.58	11.1
5.5	7.5	725	86.0	87.7	87.7	0.46	0.60	0.69	13.8	730	84.0	87.7	87.7	0.40	0.52	0.62	14.1
7.5	10	720	88.0	88.9	88.7	0.58	0.70	0.76	16.9	725	87.5	88.9	88.9	0.50	0.62	0.71	16.5
11	15	725	90.0	90.3	90.0	0.66	0.76	0.81	22.9	730	90.0	90.3	90.3	0.58	0.71	0.78	21.7
15	20	735	89.5	90.0	90.6	0.56	0.67	0.73	34.5	735	89.0	90.0	90.9	0.50	0.63	0.69	33.3
18.5	25	730	91.0	91.8	91.8	0.69	0.79	0.84	36.5	735	90.0	92.0	92.0	0.61	0.73	0.80	35.0
22	30	730	91.7	92.4	92.4	0.68	0.78	0.84	43.1	735	91.3	92.5	92.6	0.62	0.73	0.80	41.3
30	40	730	92.0	93.0	93.0	0.66	0.77	0.83	59.0	735	91.0	93.2	93.2	0.58	0.71	0.79	56.7
37	50	735	92.9	93.5	93.8	0.68	0.76	0.81	74.0	740	92.1	93.7	93.8	0.60	0.72	0.79	69.5
45	60	735	93.3	94.0	94.1	0.66	0.77	0.81	89.7	740	92.7	94.2	94.2	0.58	0.70	0.77	86.3
55	75	740	94.0	94.6	94.6	0.62	0.72	0.78	113	740	93.2	94.3	94.6	0.54	0.66	0.74	109
55	75	740	94.0	94.6	94.6	0.62	0.72	0.78	113	740	93.2	94.3	94.6	0.54	0.66	0.74	109
75	100	740	94.5	95.2	95.0	0.64	0.75	0.79	152	740	94.0	95.0	95.2	0.56	0.69	0.75	146



## W21 Cast Iron Frame IE3

Output		Frame	Full Load Torque (kgfm)	Locked Rotor Current I/In	Locked Rotor Torque Tl/Tn	Break-down Torque Tb/Tn	Inertia J (kgm <sup>2</sup> )	Allowable locked rotor time (s)		Weight (kg)	Sound dB(A)	460 V 60Hz							
												Rated speed (rpm)	% of full load			Full load current In (A)			
													Efficiency				Power Factor		
kW	HP							Hot	Cold			50	75	100	50	75	100		
8P-750rpm-60HZ																			
0.75	1	100L	1.03	4.6	1.9	2.3	0.0127	30	66	30.5	50.0	860	70.0	74.0	75.5	0.38	0.50	0.59	2.11
1.1	1.5	100L	1.52	4.6	2.1	2.4	0.0143	30	66	33.0	50.0	860	74.0	75.5	78.5	0.38	0.50	0.59	2.98
1.5	2	112M	2.07	5.0	2.5	2.8	0.0238	28	62	43.0	46.0	855	77.0	80.0	82.5	0.44	0.57	0.64	3.57
2.2	3	132S	3.02	6.2	2.3	2.5	0.0690	27	59	69.0	48.0	860	78.5	82.5	84.0	0.49	0.62	0.70	4.70
3	4	132M	4.12	6.4	2.4	2.6	0.0838	21	46	75.0	48.0	860	80.0	82.5	85.5	0.49	0.62	0.70	6.29
4	5.5	160M	5.34	5.2	2.5	2.8	0.1221	27	59	110	51.0	880	80.8	85.2	86.5	0.38	0.49	0.58	10.0
5.5	7.5	160M	7.34	5.6	2.3	2.6	0.1652	22	48	130	51.0	880	83.9	87.6	88.2	0.40	0.52	0.62	12.6
7.5	10	160L	10.1	5.2	2.0	2.4	0.1652	19	42	145	51.0	875	87.3	89.5	89.5	0.51	0.63	0.70	15.0
11	15	180L	14.8	7.5	2.4	2.6	0.3034	12	26	183	51.0	875	88.8	90.7	90.7	0.58	0.70	0.77	19.8
15	20	200L	19.9	5.0	2.0	2.2	0.5023	28	62	300	53.0	890	87.9	90.8	91.4	0.50	0.61	0.69	29.9
18.5	25	225S/M	24.5	7.5	2.1	2.8	0.8472	18	40	340	60.0	885	89.5	91.6	92.1	0.61	0.73	0.80	31.5
22	30	225S/M	29.2	8.5	2.1	3.0	1.20	164	361	365	60.0	885	90.6	92.5	92.7	0.61	0.73	0.80	37.2
30	40	250S/M	39.8	8.7	2.5	3.2	1.22	17	37	440	60.0	885	90.7	92.9	93.4	0.60	0.72	0.80	50.4
37	50	280S/M	48.7	6.5	1.9	2.2	2.64	32	70	590	62.0	885	91.3	93.5	93.9	0.60	0.72	0.78	63.4
45	60	280S/M	59.2	6.5	2.0	2.4	3.10	32	70	650	62.0	885	91.9	94.1	94.4	0.60	0.72	0.77	77.7
55	75	280S/M	72.4	7.0	2.0	2.6	3.45	32	70	730	62.0	890	93.8	94.3	94.6	0.57	0.64	0.71	103
55	75	315S/M	72.4	7.0	2.0	2.6	3.45	32	70	730	62.0	890	93.8	94.3	94.6	0.57	0.64	0.71	103
75	100	315S/M	98.7	7.0	1.9	2.6	4.37	20	44	876	62.0	890	93.0	95.2	95.4	0.57	0.68	0.75	132

# W21 Cast Iron Frame IE4

Output		Frame	Full Load Torque (kgfm)	Locked Rotor Current I/In	Locked Rotor Torque Tl/Tn	Break-down Torque Tb/Tn	Inertia J (kgm <sup>2</sup> )	Allowable locked rotor time (s)		Weight (kg)	Sound dB(A)	380V								
												Rated speed (rpm)	% of full load						Full load current In (A)	
													Efficiency			Power Factor				
kW	HP							Hot	Cold				50	75	100	50	75	100		
2P-3000rpm-50HZ																				
5.5	7.5	132S	1.82	7.9	2.6	3.4	0.0252	27	59	69.0	67	2940	89.4	90.8	91.5	0.75	0.84	0.87	10.50	
7.5	10	132M	2.48	7.8	2.5	3.5	0.0285	16	35	73.0	67	2940	90.2	91.4	92.1	0.69	0.8	0.86	14.50	
9.2	12.5	L132M/L	3.05	8.7	2.7	3.4	0.0356	16	35	79.0	67	2940	91.3	92.2	92.5	0.72	0.83	0.87	17.47	
11	15	160M	3.63	7.0	2.6	3.9	0.0588	14	31	120	67	2960	90.9	92.4	93.0	0.68	0.79	0.85	21.30	
15	20	160L	4.94	7.5	2.5	3.4	0.0698	11	24	126	67	2955	91.7	92.9	93.4	0.68	0.79	0.86	28.90	
18.5	25	L160L	6.11	8.5	3.1	3.7	0.0841	10	22	144	67	2955	92.4	93.3	93.8	0.7	0.81	0.87	34.53	
22	30	180L	7.23	8.5	2.9	3.6	0.1183	8	18	176	67	2965	92.7	93.8	94.4	0.7	0.81	0.86	42.00	
30	40	200L	9.84	7.8	3.0	3.5	0.2119	16	35	265	69	2970	93.4	94.4	94.5	0.7	0.81	0.85	56.74	
37	50	200L	12.1	7.5	3.0	3.2	0.2373	14	31	275	69	2970	93.2	94.1	94.8	0.74	0.83	0.86	68.95	
45	60	225S/M	14.8	8.5	3.0	3.9	0.3641	17	37	425	74	2975	94.4	95.1	95.1	0.78	0.86	0.89	84.21	
55	75	250S/M	18.0	7.8	2.9	3.4	0.6068	28	62	520	74	2970	95.2	95.4	95.4	0.8	0.87	0.90	97.26	
75	100	280S/M	24.5	7.9	2.6	3.3	1.47	50	110	800	76	2980	93.4	94.8	95.6	0.8	0.87	0.90	131.58	
90	125	280S/M	29.4	7.8	2.5	3.3	1.64	45	99	890	76	2980	94.2	95.3	95.8	0.8	0.87	0.90	157.89	
110	150	315S/M	36.0	8.0	2.3	3.4	2.32	42	92	992	76	2985	94.6	95.7	96.0	0.76	0.84	0.89	194.74	
132	175	315S/M	43.1	7.5	2.3	3.0	2.77	36	79	1095	76	2980	95.3	96.0	96.0	0.82	0.88	0.91	228.42	
150	200	315S/M	49.0	8.0	2.4	3.5	3.20	42	92	1197	76	2985	95.4	96.1	96.1	0.78	0.86	0.90	262.11	
160	220	315S/M	52.3	8.0	2.4	3.3	3.20	42	92	1197	76	2985	95.7	96.2	96.2	0.8	0.87	0.90	278.95	
280	380	355M/L	91.4	7.5	2.1	3.0	5.36	32	70	1664	80	2985	96.0	96.5	96.5	0.86	0.91	0.91	482.11	
300	400	355M/L	97.9	7.0	2	3.0	5.68	32	70	1751	80	2985	96.0	96.5	96.5	0.88	0.92	0.92	510.53	
315	430	355M/L	103	7.5	2.4	3.0	6.01	23	51	1838	80	2985	96.0	96.5	96.5	0.89	0.92	0.92	535.79	
4P-1500rpm-50HZ																				
5.5	7.5	L132S	3.64	8.8	2.9	3.5	0.0640	16	35	78.0	56	1475	91.4	92.1	92.1	0.61	0.74	0.82	11.05	
7.5	10	L132M/L	4.97	9.3	3.2	4.0	0.0791	14	31	84.0	56	1475	91.6	92.6	92.6	0.6	0.73	0.81	15.16	
9.2	12.5	160M	6.05	7.2	2.8	3.2	0.1398	16	35	115	61	1475	90.1	91.6	93.1	0.6	0.72	0.80	19.30	
11	15	L160L	7.26	7.0	2.7	3.1	0.1537	14	31	152	61	1475	91.7	93.1	93.6	0.61	0.73	0.82	22.11	
15	20	180M	9.91	8.0	3	3.2	0.1813	28	62	170	61	1480	92.4	93.4	94.0	0.64	0.76	0.82	30.00	
18.5	25	180L	12.2	7.8	2.9	3.2	0.2291	16	35	185	61	1475	92.9	93.7	94.3	0.66	0.77	0.84	35.70	
22	30	200L	14.5	7.6	3.3	3.8	0.2594	14	31	284	61	1480	93.6	94.5	94.7	0.64	0.76	0.82	43.16	
30	40	200L	19.7	7.6	3.0	3.2	0.3979	18	40	284	63	1480	93.6	94.4	95.0	0.6	0.73	0.81	60.30	
37	50	225S/M	24.3	8.5	2.9	3.3	0.7346	21	46	430	63	1485	94.8	95.3	95.3	0.68	0.79	0.84	70.32	
45	60	225S/M	29.5	8.5	2.9	3.3	0.7346	15	33	440	63	1485	94.8	95.4	95.6	0.64	0.76	0.82	87.37	
55	75	250S/M	36.1	8.2	3	3.4	1.21	17	37	531	64	1485	95	95.5	95.8	0.67	0.78	0.83	105.26	
75	100	280S/M	49.0	7.9	2.9	2.9	2.78	40	88	830	69	1490	95.6	96.0	96.0	0.7	0.8	0.84	138.95	
90	125	280S/M	59.0	7.9	3	2.9	3.40	40	88	895	69	1490	96	96.2	96.2	0.73	0.82	0.86	165.26	
110	150	315S/M	71.9	7.4	2.7	3.3	4.42	54	119	1150	71	1490	96.3	96.4	96.4	0.75	0.83	0.86	201.05	
132	175	315S/M	86.3	8.0	2.8	3.5	5.29	50	110	1332	71	1490	96.1	96.4	96.5	0.71	0.81	0.86	241.05	
220	300	355M/L	144	7.0	2.6	2.8	8.95	36	79	1670	74	1490	95.9	96.5	96.7	0.75	0.83	0.85	406.32	
250	340	355M/L	163	7.0	2.7	2.8	10.0	33	73	1730	74	1495	96.1	96.6	96.7	0.75	0.83	0.88	458.90	
260	350	355M/L	170	7.0	2.7	2.8	10.0	33	73	1730	74	1490	96.2	96.7	96.8	0.76	0.84	0.85	478.95	
280	380	355M/L	183	7.5	2.7	2.7	10.5	28	62	1772	74	1490	96.2	96.7	96.8	0.72	0.82	0.85	515.79	
300	400	355M/L	196	7.5	2.7	2.6	11.1	24	53	1825	74	1490	96.3	96.8	96.8	0.73	0.82	0.86	546.32	
315	430	355M/L	206	7.5	2.9	2.6	11.6	27	59	1878	74	1490	96.4	96.8	96.8	0.73	0.82	0.86	573.68	
6P-1000rpm-50HZ																				
3	4	132S	3.01	6.3	2.0	2.8	0.0568	48	106	61.0	52	975	87.9	89.3	88.7	0.53	0.65	0.73	7.04	
4	5.5	132M	4.02	6.6	2.2	3.0	0.0643	35	77	68.0	52	975	88.3	89.7	89.7	0.52	0.65	0.73	9.31	
5.5	7.5	L132M/L	5.49	7.3	2.5	3.2	0.0833	27	59	84.0	52	975	88.7	89.5	89.5	0.5	0.63	0.71	13.05	
7.5	10	160L	7.45	6.8	2.6	3.2	0.1931	21	46	130	56	975	89.9	90.6	90.6	0.6	0.73	0.80	15.58	
9.2	12.5	160L	9.14	6.8	2.5	3.1	0.2370	23	51	148	56	975	89.9	90.7	90.8	0.57	0.70	0.78	18.84	
11	15	180M	10.9	9.0	2.9	3.3	0.2370	14	31	210	56	980	91.0	91.5	91.5	0.72	0.82	0.85	21.00	
15	20	L180L	14.9	7.0	2.5	3.3	0.3765	13	29	210	56	980	92.0	92.5	92.5	0.73	0.83	0.87	28.30	
18.5	25	200L	18.4	6.6	2.4	3.0	0.4896	23	51	235	60	985	92.5	93.1	93.1	0.62	0.75	0.81	37.16	
22	30	200L	21.8	7.0	2.6	3.0	0.5246	18	40	250	60	985	92.6	93.4	93.9	0.59	0.72	0.79	45.16	
30	40	225S/M	29.7	7.5	2.4	3.1	1.02	23	51	430	63	990	93.5	94.2	94.3	0.68	0.79	0.84	57.58	
37	50	250S/M	36.6	7.5	2.6	3.0	1.65	30	66	520	64	990	94	94.5	94.6	0.69	0.8	0.85	70.00	
45	60	280S/M	44.3	7.0	2.3	2.8	3.25	35	77	723	65	990	94	94.7	94.9	0.66	0.77	0.82	87.58	
55	75	280S/M	54.1	7.2	2.6	3.1	3.92	36	79	740	65	990	94.2	95.1	95.2	0.63	0.75	0.81	108.42	
75	100	315S/M	73.8	7.5	2.3	3.2	7.25	60	132	1106	67	990	94.6	95.4	95.4	0.61	0.73	0.81	150.00	
90	125	315S/M	88.5	7.4	2.2	3.1	7.96	48	106	1180	67	990	94.9	95.6	95.6	0.63	0.75	0.82	177.00	
110	150	315S/M	108	7.3	2.5	3.0	7.23	44	97	1106	67	990	95.1	95.6	95.6	0.64	0.76	0.82	215.00	
185	250	355M/L	181	6.6	2.1	2.4	13.2	50	110	1854	73	995	95.4	96.1	96.1	0.63	0.74	0.80	360.00	
200	270	355M/L	196	6.6	2.2	2.3	14.1	48	106	1912	73	995	95.5	96.1	96.1	0.63	0.74	0.80	388.42	
220	300	355M/L	216	6.5	2.1	2.3	15.0	48	106	1970	73	995	95.6	96.1	96.1	0.63	0.74	0.80	427.37	

# Mechanical data

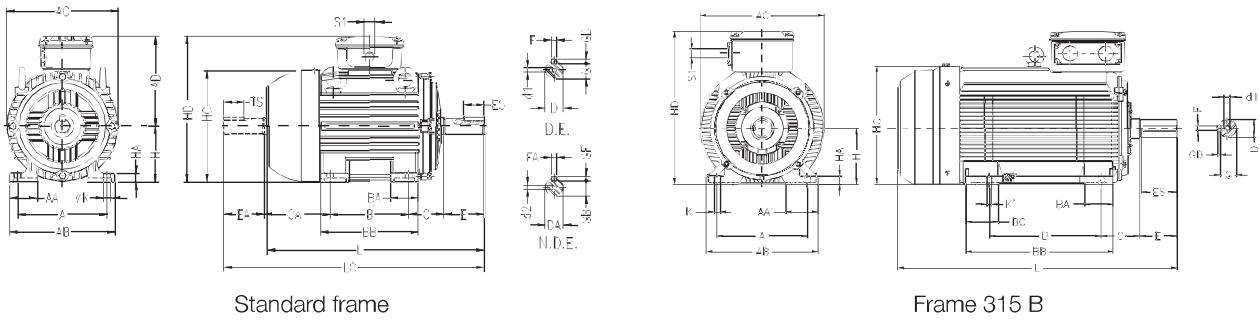

Standard frame

Frame 315 B

IEC Frame	A	AA	AB	AC	AD	B	BA	BB	C	CA	Shaft dimensions															H	HA	HC	HD	K	L	LC	S1	d1	d2	Bearings	
											D	E	ES	F	G	GD	DA	EA	TS	FA	GB	GF	2x	DM6	DM4											6204-ZZ	6203-ZZ
80	125	35	149	159	136	100	40	125.5	50	93	19j6	40	28	6	15.5	6	14j6	30	18	11	80	13	157	216	276	313	M20x1.5	DM6	DM4	6204-ZZ	6203-ZZ						
90S	140	38	164	179	155	125	42	131	56	104	24j6	50	36	8	20	7	16j6	40	28	5	90	15	177	245	304	350	2x	DM8	DM6	6205-ZZ	6204-ZZ						
90L								156																	329	375	M25x										
100L**	160	49	188	199	165	140	50	173	63	118	28j6	60	45	8	24	8	22j6	50	36	6	100	16	198	265	376	431	1.5	DM10	DM8	6206-ZZ	6205-ZZ						
112M	190	48	220	222	184	140	50	177	70	128	28j6	60	45	8	24	8	24j6	50	36	7	112	18.5	235	296	393	448	2x			6307-ZZ	6206-ZZ						
132S	216	51	248	270	212	178	55	187	89	150	38k6	80	63	10	33	8	28j6	60	45	8	132	20	274	344	452	519	M32	DM12	DM10	6308-ZZ	6207-ZZ						
132M								225																	490	557	x1.5										
160M	254	64	308	312	255	210	65	254	108	174	42k6	110	80	12	37	8	42k6	110	80	12	160	22	317	415	598	712	2x	DM16		6309-C3	6209-ZC3						
160L								298																	642	756	M40										
180M	279	80	350	358	275	241	75	294	121	200	48k6	110	80	14	42.5	9	48k6	110	80	14	180	28	360	455	664	782	x1.5			6311-C3	6211-ZC3						
180L								332																	702	820											
200M	318	82	385	396	300	267	85	330	133	222	55m6	110	80	16	49	10	55m6	110	80	16	200	30	402	500	729	842	2x			6312-C3	6212-ZC3						
200L								370																	767	880	M50										
225S/M	356	80	436	476	373	286	105	391	149	280	55m6*	140	125	100	18	53	60m6	140	125	10	225	34	466	598	817	935	x1.5										
225S/M								311		255	60m6	140	125	100	18	53	60m6	140	125	10	225	34	466	598	817	935	x1.5										
250S/M	406	100	506	560	420	311	138	449	168	312	60m6*	140	125	100	18	53	60m6	140	125	10	250	42	491	623	923	1071		M20		6314-C3							
250S/M								349		274	65m6	140	125	100	18	53	60m6	140	125	10	250	42	491	623	923	1071		M20		6314-C3							
280S/M	457	110	557	600	450	368	142	510	190	350	65m6*	140	125	100	18	53	60m6	140	125	10	280	57	578	748	1036	1188				6316-C3							
280S/M								419		299	75m6	140	125	100	18	53	60m6	140	125	10	280	57	578	748	1036	1188				6316-C3							
315S/M	508	120	628	698	545	406	152	558	216	376	65m6*	140	125	100	18	53	60m6	140	125	10	315	61	613	812	1126	1278	2x			6314-C3							
315S/M								457		325	80m6	140	125	100	18	53	60m6	140	125	10	315	61	613	812	1126	1278	2x			6314-C3							
315S/M								497		325	80m6	140	125	100	18	53	60m6	140	125	10	315	61	613	812	1126	1278	2x			6314-C3							
315S/M								497		325	80m6	140	125	100	18	53	60m6	140	125	10	315	61	613	812	1126	1278	2x			6314-C3							
315S/M								497		325	80m6	140	125	100	18	53	60m6	140	125	10	315	61	613	812	1126	1278	2x			6314-C3							
315S/M								497		325	80m6	140	125	100	18	53	60m6	140	125	10	315	61	613	812	1126	1278	2x			6314-C3							
315S/M								497		325	80m6	140	125	100	18	53	60m6	140	125	10	315	61	613	812	1126	1278	2x			6314-C3							
315S/M								497		325	80m6	140	125	100	18	53	60m6	140	125	10	315	61	613	812	1126	1278	2x			6314-C3							
315S/M								497		325	80m6	140	125	100	18	53	60m6	140	125	10	315	61	613	812	1126	1278	2x			6314-C3							
315S/M								497		325	80m6	140	125	100	18	53	60m6	140	125	10	315	61	613	812	1126	1278	2x			6314-C3							
315S/M								497		325	80m6	140	125	100	18	53	60m6	140	125	10	315	61	613	812	1126	1278	2x			6314-C3							
315S/M								497		325	80m6	140	125	100	18	53	60m6	140	125	10	315	61	613	812	1126	1278	2x			6314-C3							
315S/M								497		325	80m6	140	125	100	18	53	60m6	140	125	10	315	61	613	812	1126	1278	2x			6314-C3							
315S/M								497		325	80m6	140	125	100	18	53	60m6	140	125	10	315	61	613	812	1126	1278	2x			6314-C3							
315S/M								497		325	80m6	140	125	100	18	53	60m6	140	125	10	315	61	613	812	1126	1278	2x			6314-C3							
315S/M								497		325	80m6	140	125	100	18	53	60m6	140	125	10	315	61	613	812	1126	1278	2x			6314-C3							
315S/M								497		325	80m6	140	125	100	18	53	60m6	140	125	10	315	61	613	812	1126	1278	2x			6314-C3							
315S/M								497		325	80m6	140	125	100	18	53	60m6	140	125	10	315	61	613	812	1126	1278	2x			6314-C3							
315S/M								497		325	80m6	140	125	100	18	53	60m6	140	125	10	315	61	613	812	1126	1278	2x			6314-C3							
315S/M								497		325	80m6	140	125	100	18	53	60m6	140	125	10	315	61	613	812	1126	1278	2x			6314-C3							
315S/M								497		325	80m6	140	125	100	18	53	60m6	140	125	10	315	61	613	812	1126	1278	2x			6314-C3							
315S/M								497		325	80m6	140	125	100	18	53	60m6	140	125	10	315	61	613	812	1126	1278	2x			6314-C3							
315S/M								497		325	80m6	140	125	100	18	53	60m6	140	125	10	315	61	613	812	1126	1278	2x			6314-C3							
315S/M								497		325	80m6	140	125	100	18	53	60m6	140	125	10	315	61	613	812	1126	1278	2x			6314-C3							
315S/M								497		325	80m6	140	125	100	18	53	60m6	140	125	10	315	61	613	812	1126	1278	2x			6314-C3							
315S/M								497		325	80m6	140	125	100	18	53	60m6	140	125	10	315	61	613	812	1126	1278	2x			6314-C3							
315S/M																																					



## Mechanical data

Frame	"FF" / "FF" Flange								N° of holes	
	Flange	C	LA	M	N	P	T	S		$\alpha$
80	FF-165	50	10	165	130	200	3.5	12	45°	4
90S/L		56								
100L	FF-215	63	11	215	180	250	4	15		
112M		70								
132S/M	FF-265	89	12	265	230	300	5	19		
160M/L	FF-300	108	18	300	250	350				
180M/L		121								
200M/L	FF-350	133	22	350	300	400	6	24		
225S/M	FF-400	149		400	350	450				
250S/M	FF-500	168	18	500	450	550	5	19		
280S/M		190								
315S/M	FF-600	216	22	600	550	660	6	24		
315B	FF-600	254		740	680	800				
355M/L	FF-740		254							

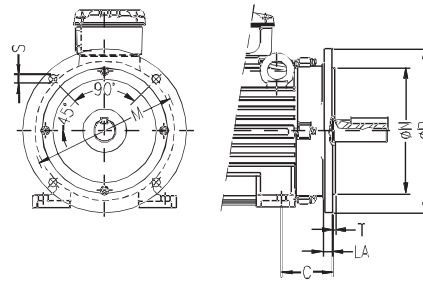

Standard frame

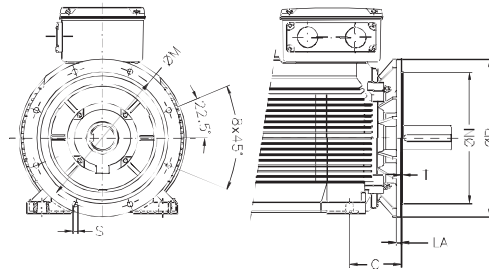

315B Frame

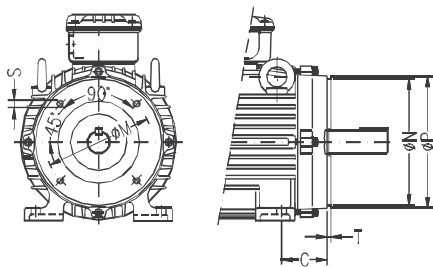

Standard frame

Frame	C-DIN / "C-DIN" Flange							N° of holes
	Flange	C	M	N	P	S	T	
80	C-120	50	100	80	120	M6	3	4
90S/L	C-140	56	115	95	140	M8		
100L	C-160	63	130	110	160		3.5	
112M		70						
132S/M	C-200	89	165	130	200	M10		

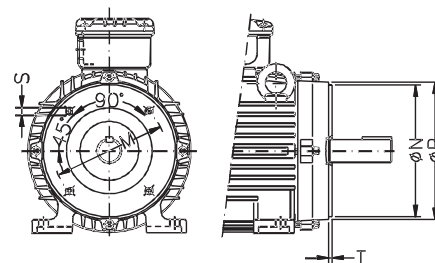

Standard frame

"C"/ "C" Flange								
Frame	Flange	M	N	P	S	T	$\alpha$	N° of holes
80	FC-95	95.2	76.2	143	UNC 1/4"x20	4	45°	4
90S	FC-149	149.2	114.3	165	UNC 3/8"x16			
90L								
100L								
112M	FC-184	184.2	215.9	225	UNC 1/2"x13	6.3		
132S								
132M								
132M/L								
160M								
160L								
180M	FC-228	228.6	266.7	280	UNC 5/8"x11	22°30'	8	
180L								
200L								
200M								
225S/M	FC-279	279.4	317.5	395	UNC 5/8"x11	6.3	22°30'	8
250S/M	FC-355	355.6	406.4	455				
280S/M								
315S/M	FC-368	368.3	419.1	455				
355M/L								
315B								

# WEG Worldwide Operations

## ARGENTINA

San Francisco - Cordoba  
Phone: +54 3564 421484  
[info-ar@weg.net](mailto:info-ar@weg.net)

Cordoba - Cordoba  
Phone: +54 351 4641366  
[weg-morbe@weg.com.ar](mailto:weg-morbe@weg.com.ar)

Buenos Aires  
Phone: +54 11 42998000  
[ventas@pulverlux.com.ar](mailto:ventas@pulverlux.com.ar)

## AUSTRALIA

Scoresby - Victoria  
Phone: +61 3 97654600  
[info-au@weg.net](mailto:info-au@weg.net)

## AUSTRIA

Markt Piesting - Wiener  
Neustadt-Land  
Phone: +43 2633 4040  
[watt@wattdrive.com](mailto:watt@wattdrive.com)

## BELGIUM

Nivelles - Belgium  
Phone: +32 67 888420  
[info-be@weg.net](mailto:info-be@weg.net)

## BRAZIL

Jaraguá do Sul - Santa Catarina  
Phone: +55 47 32764000  
[info-br@weg.net](mailto:info-br@weg.net)

## CHILE

La Reina - Santiago  
Phone: +56 2 27848900  
[info-cl@weg.net](mailto:info-cl@weg.net)

## CHINA

Nantong - Jiangsu  
Phone: +86 513 85989333  
[info-cn@weg.net](mailto:info-cn@weg.net)

Changzhou - Jiangsu  
Phone: +86 519 88067692  
[info-cn@weg.net](mailto:info-cn@weg.net)

## COLOMBIA

San Cayetano - Bogota  
Phone: +57 1 4160166  
[info-co@weg.net](mailto:info-co@weg.net)

## ECUADOR

El Batan - Quito  
Phone: +593 2 5144339  
[ceccato@weg.net](mailto:ceccato@weg.net)

## FRANCE

Saint-Quentin-Fallavier - Isère  
Phone: +33 4 74991135  
[info-fr@weg.net](mailto:info-fr@weg.net)

## GERMANY

Türnich - Kerpen  
Phone: +49 2237 92910  
[info-de@weg.net](mailto:info-de@weg.net)

Balingen - Baden-Württemberg  
Phone: +49 7433 90410  
[info@weg-antriebe.de](mailto:info@weg-antriebe.de)

Homburg (Efze) - Hesse  
Phone: +49 5681 99520  
[info@akh-antriebstechnik.de](mailto:info@akh-antriebstechnik.de)

## GHANA

Accra  
Phone: +233 30 2766490  
[info@zestghana.com.gh](mailto:info@zestghana.com.gh)

## INDIA

Bangalore - Karnataka  
Phone: +91 80 41282007  
[info-in@weg.net](mailto:info-in@weg.net)

Hosur - Tamil Nadu  
Phone: +91 4344 301577  
[info-in@weg.net](mailto:info-in@weg.net)

## ITALY

Cinisello Balsamo - Milano  
Phone: +39 2 61293535  
[info-it@weg.net](mailto:info-it@weg.net)

## JAPAN

Yokohama - Kanagawa  
Phone: +81 45 5503030  
[info-jp@weg.net](mailto:info-jp@weg.net)

## MALAYSIA

Shah Alam - Selangor  
Phone: +60 3 78591626  
[info@wattdrive.com.my](mailto:info@wattdrive.com.my)

## MEXICO

Huehuetoca - Mexico  
Phone: +52 55 53214275  
[info-mx@weg.net](mailto:info-mx@weg.net)

Tizayuca - Hidalgo  
Phone: +52 77 97963790

## NETHERLANDS

Oldenzaal - Overijssel  
Phone: +31 541 571080  
[info-nl@weg.net](mailto:info-nl@weg.net)

## PERU

La Victoria - Lima  
Phone: +51 1 2097600  
[info-pe@weg.net](mailto:info-pe@weg.net)

## PORTUGAL

Maia - Porto  
Phone: +351 22 9477700  
[info-pt@weg.net](mailto:info-pt@weg.net)

## RUSSIA and CIS

Saint Petersburg  
Phone: +7 812 363 2172  
[sales-wes@weg.net](mailto:sales-wes@weg.net)

## SOUTH AFRICA

Johannesburg  
Phone: +27 11 7236000  
[info@zest.co.za](mailto:info@zest.co.za)

## SPAIN

Coslada - Madrid  
Phone: +34 91 6553008  
[wegiberia@wegiberia.es](mailto:wegiberia@wegiberia.es)

## SINGAPORE

Singapore  
Phone: +65 68589081  
[info-sg@weg.net](mailto:info-sg@weg.net)

Singapore  
Phone: +65 68622220  
[watteuro@watteuro.com.sg](mailto:watteuro@watteuro.com.sg)

## SCANDINAVIA

Mölnlycke - Sweden  
Phone: +46 31 888000  
[info-se@weg.net](mailto:info-se@weg.net)

## UK

Redditch - Worcestershire  
Phone: +44 1527 513800  
[info-uk@weg.net](mailto:info-uk@weg.net)

## UNITED ARAB EMIRATES

Jebel Ali - Dubai  
Phone: +971 4 8130800  
[info-ae@weg.net](mailto:info-ae@weg.net)

## USA

Duluth - Georgia  
Phone: +1 678 2492000  
[info-us@weg.net](mailto:info-us@weg.net)

Minneapolis - Minnesota  
Phone: +1 612 3788000

## VENEZUELA

Valencia - Carabobo  
Phone: +58 241 8210582  
[info-ve@weg.net](mailto:info-ve@weg.net)

For those countries where there is not a WEG own operation, find our local distributor at [www.weg.net](http://www.weg.net).



WEG (Nantong) Electric Motor Mfg. Co., Ltd.  
#128, Xinkai South Rd., NETDA, Jiangsu, China.  
Tel:(86) 0513-85989333  
Fax:(86) 0513-85922162  
[info-cn@weg.net](mailto:info-cn@weg.net)  
[www.weg.net](http://www.weg.net)

