

Synchronous Motors

S Line – Horizontal
Brushless

Installation, Operation and Maintenance Manual

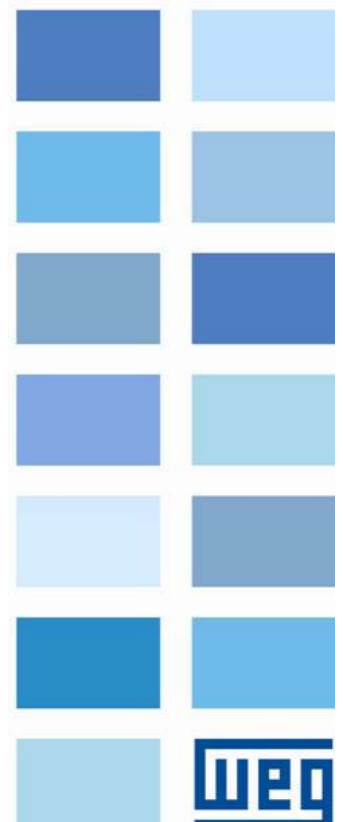



Installation, Operation and Maintenance Manual

Document Number: 11866576

Models: SEA, SED, SET, SEV, SEF, SER, SEI, SEW, SEL, SFA, SFD,
SFT, SFV, SFF, SFR, SFI, SFW and SFL

Language: English

Revision: 04

May 2016

Dear Customer,

Thank you for purchasing a WEG motor. Our products are developed with the highest standards of quality and efficiency which ensures outstanding performance.

As the electric motor plays a role of great importance to the comfort and well-being of the humanity, it must be identified and treated as an electrical machine, whose features require certain precautions, such as for storage, installation and maintenance.

All efforts have been made to ensure that the information contained in this manual is faithful to the configurations and operation of the motor.

Therefore, we recommend that you read this manual carefully before proceeding with the installation, operation or maintenance of the motor in order to ensure safe and reliable operation of your equipment and facility. If you need any further information, please contact WEG.

Always keep this manual close to the motor, so it can be consulted whenever necessary.



ATTENTION

1. It is imperative to follow the procedures contained in this manual for the warranty to be valid;
2. The motor installation, operation and maintenance procedures must be performed only by qualified personnel.



NOTES

1. The total or partial reproduction of information supplied in this manual is authorized, provided that reference is made to its source.
2. If this manual is lost, an electronic PDF file is available at www.weg.net or another printed copy may be requested.

WEG EQUIPAMENTOS ELÉTRICOS S.A.

INDEX

1	INTRODUCTION	11
1.1	SAFETY WARNINGS IN THE MANUAL	11
2	GENERAL INSTRUCTIONS	12
2.1	QUALIFIED PERSONNEL	12
2.2	SAFETY INSTRUCTIONS	12
2.3	STANDARDS.....	12
2.4	ENVIRONMENTAL CONDITIONS.....	12
2.5	OPERATING CONDITIONS	13
2.6	VOLTAGE AND FREQUENCY	13
3	RECEIVING, HANDLING AND STORAGE	14
3.1	RECEIVING	14
3.2	HANDLING.....	14
3.3	STORAGE	15
3.3.1	Outdoor storage	15
3.3.2	Extended storage	15
3.3.2.1	Storage location	15
3.3.2.1.1	Indoor storage	15
3.3.2.1.2	Outdoor storage	16
3.3.2.2	Separate parts	16
3.3.2.3	Space heater.....	16
3.3.2.4	Insulation resistance	16
3.3.2.5	Exposed machined surfaces.....	16
3.3.2.6	Bearings.....	16
3.3.2.6.1	Grease-lubricated rolling bearing.....	16
3.3.2.6.2	Oil-lubricated rolling bearing.....	16
3.3.2.6.3	Sleeve bearing	16
3.3.2.7	Terminal box	17
3.3.2.8	Radiator.....	17
3.3.2.9	Inspections and records during storage.....	17
3.3.2.10	Maintenance plan during storage.....	18
3.3.3	Preparation for commissioning	19
3.3.3.1	Cleaning.....	19
3.3.3.2	Bearing inspection.....	19
3.3.3.3	Bearing lubrication.....	19
3.3.3.4	Insulation resistance verification.....	19
3.3.3.5	Others.....	19
4	INSTALLATION.....	20
4.1	INSTALLATION SITE	20
4.2	SHAFT LOCK	20
4.3	ROTATION DIRECTION.....	20
4.4	INSULATION RESISTANCE.....	20
4.4.1	Safety instructions	20
4.4.2	General considerations	20
4.4.3	Measurement on the stator windings.....	20
4.4.4	Measurement on the rotor and exciter windings	21
4.4.5	Additional Information	21
4.4.6	Polarization index.....	21
4.4.7	Conversion of the measured values.....	21
4.4.8	Insulation assessment.....	22
4.5	PROTECTIONS	22
4.5.1	Thermal protections	22
4.5.1.1	Temperature sensors	22
4.5.1.2	Temperature limits for the windings	23
4.5.1.3	Alarm and trip temperatures	23
4.5.1.4	Temperature and ohmic resistance of the PT100 thermoresistance	24
4.5.2	Space heater	24
4.5.3	Water leak sensor	24
4.6	COOLING.....	24
4.6.1	Air-water heat exchanger cooling	24

4.6.1.1	Radiators for application with sea water	24
4.6.2	Independent ventilation cooling	25
4.7	ELECTRICAL ASPECTS	25
4.7.1	Electrical connections.....	25
4.7.1.1	Main electrical connections.....	25
4.7.1.2	Grounding	25
4.7.1.3	Field power supply and control	25
4.7.2	Connection diagram.....	26
4.8	MECHANICAL ASPECTS	26
4.8.1	Foundations	26
4.8.2	Foundation loads	26
4.8.3	Base types.....	26
4.8.3.1	Concrete base.....	26
4.8.3.2	Metal base.....	26
4.8.4	Natural frequency of the base.....	26
4.8.5	Mounting	26
4.8.6	Anchor plate set.....	27
4.8.7	Leveling	27
4.8.7.1	Support.....	27
4.8.8	Alignment.....	27
4.8.9	Inspection of pedestal bearings	28
4.8.10	Couplings.....	29
4.8.10.1	Direct coupling	29
4.8.10.2	Gear coupling.....	29
4.8.10.3	Coupling of motors equipped with sleeve bearings	30
4.9	BRAKE	30
4.10	HYDRAULIC UNIT	30
5	STARTING	31
5.1	DIRECT ON-LINE STARTING	31
5.1.1	Direct start with discharge resistor.....	31
5.1.2	Direct start without discharge resistor.....	31
5.1.3	Direct online start frequency	31
5.1.4	Locked rotor current (Ip/In).....	31
5.2	STARTING WITH REDUCED CURRENT	32
5.2.1	Starting with reactor	32
5.2.2	Starting with autotransformer	32
5.2.3	Starting with frequency inverter	32
5.2.4	Starting with soft-starter	32
5.3	EXCITATION CIRCUITS	33
5.3.1	Excitation circuit with voltage control (Random)	33
5.3.3	Excitation circuit with frequency control	34
5.3.4	Excitation circuit for AC exciter	35
6	COMMISSIONING	36
6.1	PRELIMINARY INSPECTION	36
6.2	FIRST START	36
6.2.1	Initial starting procedure	36
6.3	OPERATION	37
6.3.1	Operation procedures	37
6.3.2	Resynchronization.....	37
6.3.3	Data recording	37
6.3.4	Temperatures.....	37
6.3.5	Bearings	37
6.3.5.1	High-pressure oil injection system.....	38
6.3.6	Radiators	38
6.3.7	Vibration	38
6.3.8	Vibration causes.....	38
6.4	SHUTDOWN.....	38
7	MAINTENANCE.....	39
7.1	GENERAL.....	39
7.2	GENERAL CLEANING	39
7.3	WINDING INSPECTIONS.....	39
7.4	WINDING CLEANING	39
7.4.1	Inspections	39

7.4.2	Re-impregnation	40
7.4.3	Insulation resistance.....	40
7.5	COOLING SYSTEM MAINTENANCE	40
7.6	RADIATOR MAINTENANCE	40
7.7	VIBRATION	40
7.8	SHAFT GROUNDING DEVICE	40
7.9	EXCITER MAINTENANCE.....	40
7.9.1	Exciter	40
7.9.2	Insulation resistance.....	40
7.9.3	Diode test.....	40
7.9.3.1	Diode Replacement.....	41
7.9.4	Thyristor test.....	41
7.9.4.1	Thyristor replacement.....	41
7.10	BEARING MAINTENANCE	42
7.10.1	Grease-lubricated rolling bearings	42
7.10.1.1	Lubrication instructions.....	42
7.10.1.2	Procedures for rolling bearing relubrication	42
7.10.1.3	Rolling bearing relubrication with drawer device for grease removal	42
7.10.1.4	Type and amount of grease.....	43
7.10.1.5	Grease compatibility.....	43
7.10.1.6	Bearing disassembly	43
7.10.1.7	Bearing assembly	44
7.10.2	Oil-lubricated rolling bearing.....	44
7.10.2.1	Lubrication instructions.....	44
7.10.2.2	Oil type.....	44
7.10.2.3	Oil change.....	44
7.10.2.4	Bearing operation	45
7.10.2.5	Bearing disassembly	45
7.10.2.6	Bearing assembly.....	45
7.10.3	Sleeve bearings.	46
7.10.3.1	Bearing data.....	46
7.10.3.2	Bearing installation and operation	46
7.10.3.3	Cooling by water circulation.....	46
7.10.3.4	Oil change.....	46
7.10.3.5	Sealings.....	46
7.10.3.6	Sleeve bearing operation	47
7.10.3.7	Sleeve bearing maintenance.....	47
7.10.4	Protection setting.....	47
7.10.5	Disassembly/assembly of the bearing temperature sensors.....	47
8	MOTOR DISASSEMBLY AND ASSEMBLY	48
8.1	DISASSEMBLY	48
8.2	ASSEMBLY	48
8.3	TIGHTENING TORQUE	48
8.4	AIR GAP MEASUREMENT	49
8.5	SPARE PARTS.....	49
9	MAINTENANCE PLAN.....	50
10	ABNORMALITIES, CAUSES AND SOLUTIONS.....	51
11	DECLARATION OF CONFORMITY	53
12	ENVIRONMENTAL INFORMATION.....	54
12.1	PACKAGE	54
12.2	PRODUCT.....	54
12.3	HAZARDOUS WASTE	54
13	WARRANTY TERM	55

1 INTRODUCTION

This manual contains information regarding low and high voltage synchronous motors. Motors are supplied with specific documents (drawings, connection diagram, characteristic curves, etc.). Those documents, together with this manual, must be thoroughly evaluated before proceeding with the installation, operation or maintenance of the motor.

All the procedures and standards contained in this manual must be observed in order to ensure proper operation of the motor and the safety of the personnel involved. Following these procedures is also important to ensure the validity of the motor warranty. Thus, we recommend carefully reading this manual before performing the installation, operation or maintenance of the motor. If you need any further information, consult WEG.

1.1 SAFETY WARNINGS IN THE MANUAL

In this manual, the following safety warnings are used:



DANGER

Failure to observe the procedures recommend in this warning may result in death, serious injuries and extensive equipment damage.



ATTENTION

Failure to observe the procedures recommend in this warning may result in equipment damage.



NOTE

This provides important information for correct understanding and proper operation of the product.

2 GENERAL INSTRUCTIONS

All personnel involved with the assembly, operation or maintenance of electrical installations must be informed and updated on the standards and safety instructions that guide the job and are advised to strictly comply with them. Before beginning any job, the person in charge must make sure that all points have been duly observed and warn the respective personnel about the danger inherent to the task to be performed.

Improper application, inadequate handling or maintenance of the motor, may cause serious injuries and/or material damages. Therefore, it is highly recommended that such jobs be always performed by qualified personnel.

2.1 QUALIFIED PERSONNEL

The term qualified personnel means those who, because of their training, experience, education level and knowledge of the applicable standards, specifications, accident prevention, safety standards and operating conditions, have been authorized by the persons in charge to execute the necessary tasks, and who are able to recognize and avoid any possible danger. Such qualified personnel must also know and be able to provide first aid procedures if necessary. The entire start-up, maintenance and repair tasks must only be performed by qualified personnel.

Qualified personnel must also observe:

- All the technical data regarding the allowed applications (operating conditions, connections and installation environment), provided in the purchase order documents, operating instructions, manuals and other documentation;
- The specific regulations and conditions for the local installation;
- The use of suitable tools and equipment for handling and transportation;
- That the protective devices of the individual components are removed shortly before installation. Individual parts must be stored in vibration-free environments, avoiding falls and ensuring their protection against aggressive agents and/or that they do not jeopardize people.

2.2 SAFETY INSTRUCTIONS



DANGER

During normal operation of this equipment, a hazard associated with energized or rotating components with high voltage or elevated temperatures exists. Thus, the operation with open terminal boxes, unprotected couplings, improper handling, or failure to comply with the operating standards, may cause severe personal injuries and material damages.



ATTENTION

When devices and equipment are used outside the industrial environment, the user must ensure the safety of the equipment by adopting proper protection and safety measures during installation (for example, keeping people away, avoiding contact of children, etc.).

Those responsible for the safety of the installation must ensure that:

- Only qualified personnel install and operate the equipment;
- They have this manual and all other documents supplied with the motor at hand, as well as that they perform the tasks in strict compliance with the service instructions, relevant standards and specific product documentation.



ATTENTION

Failure to comply with installation and safety standards may void the product warranty. Firefighting equipment and first aid notices must be available in visible and easily accessible locations at the work site.

2.3 STANDARDS

Motors are specified, designed, manufactured and tested according to the standards described in Table 2.1. The applicable standards are specified in the commercial contract, which may indicate other national or international standards, depending on the application or installation location.

Table 2.1: Applicable standards

	STANDARDS
Specification	IEC60034-1 / NBR5117 IEC60034-3
Dimensions	IEC60072 / NBR5432
Tests	IEC60034-4 / NBR5052
Degrees of protection	IEC60034-5 / NBR IEC 60034-5
Cooling	IEC60034-6 / NBR IEC 60034-6
Mounting	IEC60034-7 / NBR IEC 60034-7
Noise	IEC60034-9 / NBR IEC 60034-9
Mechanical vibration	IEC60034-14 / NBR IEC 60034-14
Mechanical tolerances	ISO286 / NBR6158
Balancing	ISO1940 / NBR8008

2.4 ENVIRONMENTAL CONDITIONS

The motor was designed according to the specific environment characteristics (temperature and altitude) of your application, and are described on the nameplate and in the datasheet of the motor.



ATTENTION

For the use of water-cooled motors in ambient temperatures below +5 °C, antifreeze additives must be added to the water.

2.5 OPERATING CONDITIONS

In order for the product warranty to be valid, the motor must operate according to the rated data indicated on its nameplate, observing the applicable standards and the information provided in this manual.

2.6 VOLTAGE AND FREQUENCY

The motor must be able to perform its main function continuously in Zone A, but it does not have to fully meet its performance characteristics at rated voltage and frequency (refer to the point with rated characteristics in Figure 2.1), and it may present some deviations. The temperature rises may be above those at rated voltage and frequency.

The motor must be able to perform its main function in Zone B, but it may present greater deviations of its performance at rated voltage and frequency than in Zone A. The temperature rises may be higher than those observed at rated voltage and frequency and, most likely, will be higher than those in Zone A.

Prolonged operation in the periphery of Zone B is not recommended.

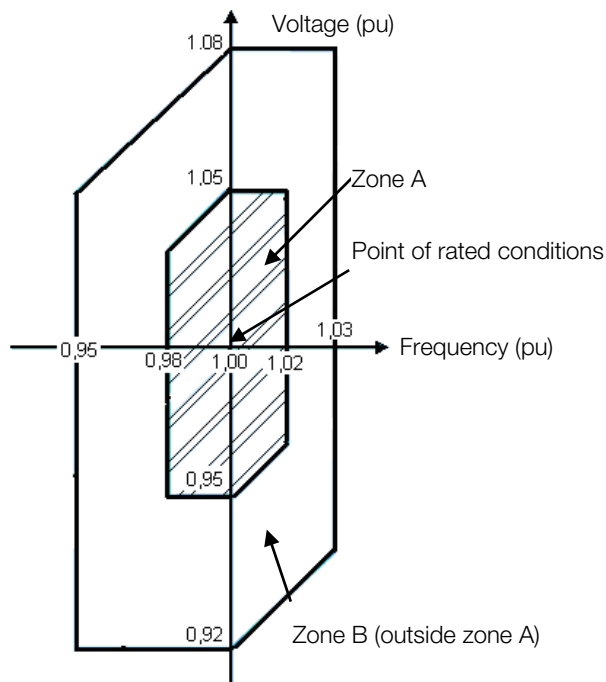



Figure 2.1: Voltage and frequency variation limits (IEC60034-1)

3 RECEIVING, HANDLING AND STORAGE

3.1 RECEIVING

All motors were tested and are in perfect operating conditions. The machined surfaces are protected against corrosion. The package must be inspected upon receipt for occasional damages during transportation.

 **ATTENTION**
Any damage must be photographed, documented and reported immediately to the carrier, the insurer and WEG. The non-communication of this damage will void the warranty.

 **ATTENTION**
Parts supplied in additional packages must be checked upon receipt.

- When lifting the package (or container), the proper hoisting points, the weight indicated on the package or on the nameplate, and the operating capacity of the hoisting equipment must be observed.
- Motors packed in wooden crates must always be lifted by their own hoisting eye or by a proper forklift; they must never be lifted by the package;
- The package can never be overturned. Place it on the floor carefully (without impact) in order to avoid damage to the bearings;
- Do not remove the grease for protection against corrosion from the shaft end and, or the closing plugs present in the terminal box holes. These protections must remain in place until the moment of the final assembly.
- A complete visual inspection of the motor must be carried out after removing the package;
- The shaft locking system must be removed just before the installation and stored to be used in future transportation of the motor.

3.2 HANDLING

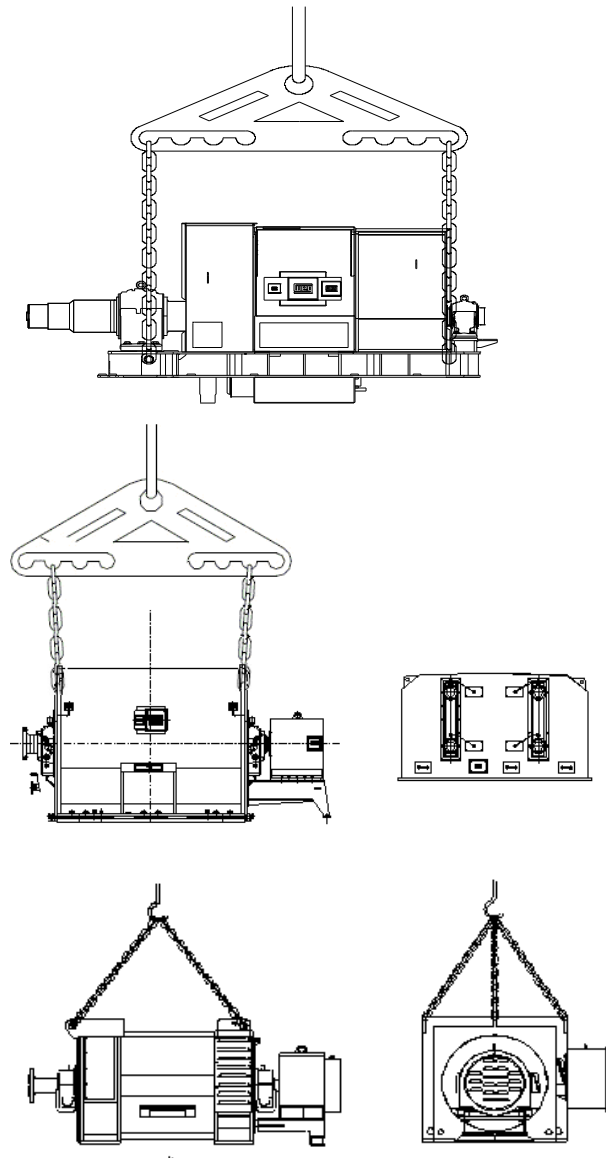

Figure 3.1: Motor handling



NOTES

- Observe the indicated weight. Do not lift the motor causing jolts or put it down abruptly on the floor, because this can cause damage to the bearings;
- In order to lift the motor, use only the lifting lugs provided for that purpose only. If necessary, use a crossbeam to protect parts of the motor;
- The lifting lugs on the heat exchanger, end shields, bearings, radiator, terminal box, etc. are designed to handle these components only separately;
- Never use the shaft to lift the motor;
- In order to move the motor, the shaft must be locked with the shaft locking device supplied with the motor.



ATTENTION

- Steel wire ropes, clevises and the lifting equipment must be able to stand the motor weight.
- For handling and assembling motors supplied disassembled, refer to the handling and assembly manual supplied with the motor.



ATTENTION

For the motor warranty to be valid, it is necessary to make sure that all the preventive measures described in this manual, as well as constructive aspects, maintenance, packing, storage and periodical inspections be followed and recorded.

3.3 STORAGE

If the motor is not installed immediately after reception, it must remain inside the package and stored in a location protected against moisture, vapors, sudden changes in temperature, rodents and insects.

The motor must be stored in vibration-free locations in order to avoid bearing damage.



ATTENTION

Space heaters must remain powered during storage in order to avoid water condensation inside the motor.

Any damage to the paint or corrosion protection of the machined parts must be repaired.

The extended storage instructions are valid for motors that remain stored for long periods (two months or more) before start-up or motors already installed and that are in a prolonged stoppage, considering the same period.

3.3.2.1 Storage location

In order to ensure the best storage conditions for the motor during long periods, the chosen location must strictly meet the criteria described in sections 3.3.2.1.1 and 3.3.2.1.2.

3.3.2.1.1 Indoor storage

- The storage site must be closed and covered;
- The site must be protected against moisture, vapors, aggressive agents, rodents and insects;
- Corrosive gases, such as chlorine, sulfur dioxide or acids, must not be present;
- The site must be free of vibration;
- The site must have a ventilation system with air filter;
- Ambient temperature between 5 °C and 60 °C, without sudden temperature variations;
- Relative humidity < 50%;
- The site must be protected against dirt and dust accumulation;
- It must have a fire detection system;
- The location must have a power supply for the space heaters.

If any of these requirements is not met in the storage site, WEG recommends that additional protections be incorporated to the motor package during the storage period, as follows:

- A closed wooden crate or the like with an electrical installation that allows the energization of the space heaters;
- If there is risk of infestation and fungus formation, the package must be protected in the storage location by spraying it or painting it with appropriate chemicals;
- The package must be prepared carefully by an experienced person.

3.3.1 Outdoor storage

The motor must be stored in a dry location, free of flooding and vibrations.

Repair all damages occasionally caused to the packing during transportation before storing the motor, which is necessary to ensure proper storage conditions.

Place the motor on platforms or foundations which ensure protection against humidity from the ground and prevent it from sinking into the soil. Free air circulation underneath the motor must be assured.

The cover used to protect the motor against the bad weather must not be in contact with its surfaces. In order to ensure free air circulation between the motor and such covers, place wooden blocks as spacers.

3.3.2 Extended storage

When the motor is stored for a long period (two months or more) before the start-up, it is exposed to external agents, such as temperature variations, moisture, aggressive agents, etc.

Empty spaces inside the motor, such as those in bearings, terminal box, and windings, are exposed to humidity, which may condense and, depending on the type and degree of air contamination, aggressive substances may also penetrate these empty spaces. Consequently, after long periods of storage, the winding insulation resistance may drop below the acceptable values, internal components, such as bearings, may oxidize, and the lubricant power of the lubricant agent in the bearings may be adversely affected.

All of these influences increase the risk of damages before the motor start-up.

3.3.2.1.2 Outdoor storage

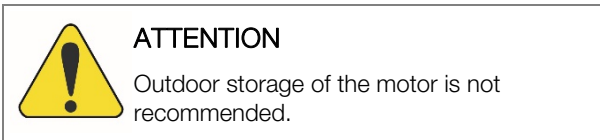

In case outdoor storage is unavoidable, the motor must be packed in a specific package for such condition, as follows:

- For outdoor storage (exposed to the weather), besides the package recommended for indoor storage, the package must be covered with protection against dust, moisture and other foreign materials, using resistant canvas or plastic.
- The package must be placed on platforms or foundations that ensure protection against dirt and moisture and keep it from sinking into the soil;
- After the package is covered, a shelter must be erected to protect it against direct rain, snow and excessive sun heat.

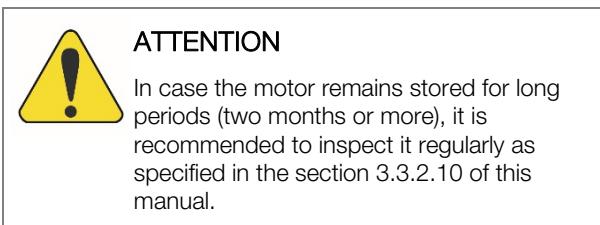

3.3.2.2 Separate parts

- If parts are supplied separately (terminal boxes, end shields, etc.), these parts must be packed as specified in sections 3.3.2.1.1 and 3.3.2.1.2 of this manual.
- The relative humidity inside the package must not exceed 50%.
- Rolling bearings must not be subject to shocks, falls or storage with vibration or humidity, which can cause marks on the internal races or on the balls, reducing their useful life.

3.3.2.3 Space heater

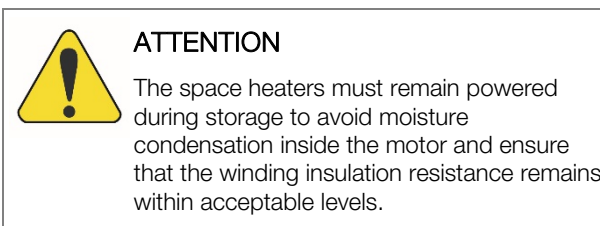

3.3.2.4 Insulation resistance

During the storage period, the insulation resistance of the motor windings must be measured and recorded every three months and before the motor installation. Any insulation resistance reduction must be investigated.

3.3.2.5 Exposed machined surfaces

All exposed machined surfaces (e.g., shaft end and flanges) are protected at the factory with a temporary protective agent (rust inhibitor).

This protection coating must be reapplied every six months or when removed and/or damaged.

Recommended Product: Anticorit BW protective agent
Manufacturer: Fuchs

3.3.2.6 Bearings

3.3.2.6.1 Grease-lubricated rolling bearing

- The rolling bearings are lubricated at the factory to perform the tests of the motor;

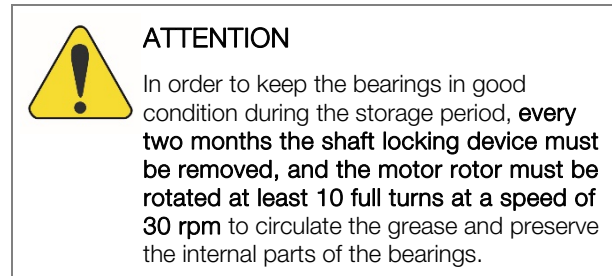

- Before putting the motor into operation, the rolling bearings must be lubricated;
- If the motor remains stored for a period exceeding two years, the rolling bearings must be disassembled, washed, inspected and relubricated.

3.3.2.6.2 Oil-lubricated rolling bearing

- Depending on the motor mounting position and on the lubrication type, the motor can be transported with or without oil in the bearings;
- The motor must be stored in its original operating position and with oil in the bearings, when specified;
- The oil level must be respected, remaining in the middle of the sight glass.

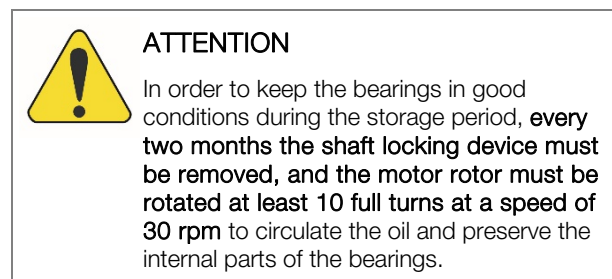

- After six months of storage and before putting the motor into operation, the rolling bearings must be relubricated.
- If the motor remains stored for a period exceeding two years, the rolling bearings must be disassembled, washed, inspected and relubricated.

3.3.2.6.3 Sleeve bearing

Depending on the machine mounting position and on the lubrication type, the machine can be transported with or without oil in the bearings.

The machine must be stored in its original operating position and with oil in the bearings, when specified. The oil level must be respected, remaining in the middle of the sight glass.



ATTENTION

In order to keep the bearings in good conditions during the storage period, **every two months the shaft locking device must be removed, and the motor rotor must be rotated at least 10 full turns at a speed of 30 rpm** to circulate the oil and preserve the internal parts of the bearings.



NOTES

For bearings that have a high-pressure oil injection system (jacking), this system must be activated before rotating the machine rotor.

For bearings without oil tank (dry crankcase), the oil circulation system must be activated before rotating the machine shaft.

The shaft must always be rotated in the rotation direction of the machine.

If it is not possible to rotate the machine shaft, as recommended, after six months of storage, the following procedure must be used for protecting both the bearing internally and the contact surfaces against corrosion:

- Close all the threaded holes with plugs;
- Seal the gaps between the shaft and the bearing seal on the shaft by applying water-proof adhesive tape;
- Check if all the flanges (e.g., oil inlet and outlet) are closed. If not, they must be closed with blind covers;
- Remove the upper sight glass of the bearing and apply the corrosion inhibitor spray (TECTYL 511 or equivalent) inside the bearing;
- Close the bearing with the upper sight glass.



NOTES

If the bearing has no upper sight glass, the top cover of the bearing must be disassembled to apply the corrosion inhibitor spray.

Each six months of storage, repeat the procedure described above.

If the storage period **exceeds two years**.

- Disassemble the bearing;
- Preserve and store the parts.

3.3.2.7 Terminal box

When the insulation resistance of the motor windings is measured, the main terminal box and the other terminal boxes must also be inspected, observing the following aspects:

- The inside must be dry, clean and free of dust accumulation;
- The contact elements cannot present corrosion;
- The seals must be in proper condition;
- The cable inlets must be correctly sealed.



ATTENTION

If any of these items are not in proper condition, proceeds the adequate maintenance and, if necessary, replace damaged parts.

3.3.2.8 Radiator

When the radiator remains out of operation for a long period, it must be drained and dried. The drying may be done with pre-heated compressed air. During the winter, in case there is risk of freezing, all the water must be drained from the radiator, even if the motor remains out of operation just for a short period in order to prevent deformation of the pipes or damages to the seals.



NOTE

During short operation stoppages, instead of draining the water, it is preferable to keep its circulation at low speeds through the heat exchanger, thus ensuring that harmful products, such as ammonia compounds and hydrogen sulfide, are taken out of the radiator and not deposited inside.

3.3.2.9 Inspections and records during storage

The stored motor must be inspected periodically and inspection records must be filed.

The following points must be inspected:

1. Physical damages;
2. Cleanliness;
3. Signs of water condensation;
4. Protective coating conditions;
5. Paint conditions;
6. Signs of aggressive agents;
7. Satisfactory operation of space heaters. It is recommended that a signaling or alarm system be installed in the location in order to detect power interruption on the space heaters;
8. Record the ambient temperature and relative humidity around the motor, the winding temperature (using RTDs), the insulation resistance and the polarization index;
9. Storage site, so that it complies with the criteria described in section 3.3.2.1.

3.3.2.10 Maintenance plan during storage

During the storage period, the motor maintenance must be performed and recorded according to the plan described in Table 3.1.

Table 3.1: Storage plan

	Monthly	2 months	6 months	2 years	Before start-up	Notes
Storage Location						
Inspect the cleanliness conditions		x			x	
Inspect the humidity and temperature conditions		x				
Check for signs of insect infestation		x				
Package						
Inspect for damages			x			
Check the internal relative humidity		x				
Change the dehumidifier in the package (if any)			x			Whenever necessary
Space heater						
Check the operating conditions	x					
Whole motor						
Perform external cleaning			x		x	
Check the painting conditions			x			
Check the rust inhibitor on the exposed machined parts			x			
Reapply the rust inhibitor			x			
Windings						
Measure the insulation resistance		x			x	
Measure the polarization index		x			x	
Terminal box and grounding terminals						
Clean the interior of the boxes				x	x	
Inspect the seals and gaskets				x	x	
Grease or oil-lubricated rolling bearing						
Rotate the shaft		x				
Relubricate the bearing			x		x	
Disassemble and clean the bearing						If the storage period exceeds 2 years
Sleeve bearings						
Rotate the shaft		x				
Apply anti-corrosion spray			x			
Clean the bearings and relubricate them					x	
Disassemble and store the parts						If the storage period exceeds 2 years

3.3.3 Preparation for commissioning

3.3.3.1 Cleaning

- The internal and external parts of the motor must be free of oil, water, dust, and dirt.
- Remove the rust inhibitor from the exposed surfaces with a cloth dampened in a petroleum-based solvent;
- Make sure that the bearings and cavities used for lubrication are free of dirt and the cavity plugs are correctly sealed and tightened. Oxidation and marks on the bearing seats and on the shaft must be carefully removed.

3.3.3.2 Bearing inspection



ATTENTION

If the motor storage period exceeds six months, the sleeve bearings must be disassembled, inspected and cleaned, before starting the motor operation.

The sleeve bearings without oil tank (dry crankcase), regardless of the motor storage period, should necessarily be disassembled, inspected and cleaned before starting the motor operation.

Reassemble the sleeve bearings and carry out lubrication.

Contact WEG to perform this procedure.

3.3.3.3 Bearing lubrication

Use the lubricant specified for bearing lubrication. Information on the bearings and lubricants are indicated on the bearing nameplate, and the lubrication must be done as described in section 7.10 of this manual, always considering the type of bearing.

3.3.3.4 Insulation resistance verification

Before putting the motor into operation, the insulation resistance must be measured according to section 3.3.2.4 of this manual.

3.3.3.5 Others

Follow the other procedures described in section 6 of this manual before putting the motor into operation.

4 INSTALLATION

4.1 INSTALLATION SITE

Motors must be installed in easily accessible places, allowing periodic inspections, on-site maintenance and, if necessary, removal for external services.

The following environmental conditions must be ensured:

- Clean and well-ventilated location;
- The installation of other equipment or walls must not hinder or block the motor ventilation;
- The area around and above the motor must be sufficient for maintenance or handling;
- The environment must be in accordance with the motor protection degree.

4.2 SHAFT LOCK

The motor leaves the factory with a lock on the shaft to prevent damages to the bearings during transportation. This lock must be removed prior to motor installation.



ATTENTION

The shaft locking device must be installed whenever the motor is removed from its base (uncoupled) in order to prevent damages to the bearings during transportation. The shaft end is protected at the factory with a temporary protective agent (rust inhibitor). During the motor installation, it is necessary to remove this product from the grounding brush (if any) contact track on the shaft.

4.3 ROTATION DIRECTION

The rotation direction is indicated on a plate affixed to the drive end of the motor and in the motor specific documentation.



ATTENTION

Motors supplied with a single rotation direction must not operate in the opposite direction. In order to operate the motor in the opposite direction, consult WEG.

4.4 INSULATION RESISTANCE

4.4.1 Safety instructions



DANGER

In order to measure the insulation resistance, the motor must be turned off and stopped. The winding being tested must be connected to the frame and grounded until all residual electrostatic charges are removed. Capacitors (if any) must also be grounded before disconnecting and separating the terminals to measure the insulation resistance. Failure to comply with these procedures may result in personal injury.

4.4.2 General considerations

When the motor is not immediately put into operation, it must be protected against moisture, high temperatures, and dirt, avoiding impacts to the insulation resistance. The winding insulation resistance must be measured before putting the motor into operation. If the environment is too humid, the insulation resistance must be measured periodically during storage. It is difficult to establish fixed rules for the actual value of the winding insulation resistance, as it varies according to the environmental conditions (temperature, humidity), motor cleanliness conditions (dust, oil, grease, dirt), and quality and condition of the insulating material used. The evaluation of the periodical follow-up records is useful to conclude whether the motor is able to operate.

4.4.3 Measurement on the stator windings

The insulation resistance must be measured with a **megohmmeter**. The testing voltage for the windings must be in accordance with Table 4.1, and according to IEEE43 standard.

Table 4.1: Voltage for the winding Insulation resistance test

Winding rated voltage (V)	Insulation resistance test - continuous voltage (V)
< 1000	500
1000 - 2500	500 - 1000
2501 - 5000	1000 - 2500
5001 - 12000	2500 - 5000
> 12000	5000 - 10000

Before measuring the stator winding insulation resistance:

- Disconnect all connections to the stator terminals;
- Disconnect and insulate all CTs and PTs (if any);
- Ground the motor frame;
- Measure the winding temperature;
- Ground all temperature sensors;
- Check the humidity;
- Disconnect the neutral grounding;
- Ensure that the motor bars are not grounded.

The insulation resistance measurement of the stator windings must be done in the main terminal box. The instrument (megohmmeter) must be connected between the motor frame and the winding. The frame must be grounded and the three phases of the stator winding must

remain connected to the neutral point, as shown in Figure 4.1.

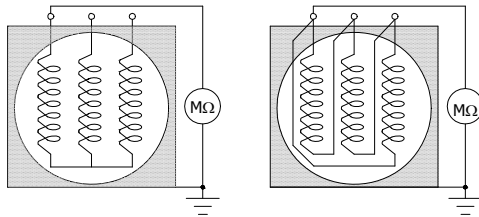

Figure 4.1: Megohmmeter connection

Whenever possible, each phase must be isolated and tested separately. The separate test allows a comparison between the phases. When a phase is tested, the other two phases must be grounded to the same ground of the frame, as shown in Figure 4.2.

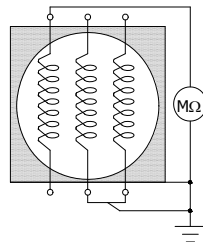

Figure 4.2: Connection of the megohmmeter to separate phases

If the total winding measurement presents a value below the recommended, the neutral connections must be opened and the insulation resistance of each phase must be measured separately.



ATTENTION

Much higher values may be frequently obtained in motors being operated for a long period of time. Comparison with values obtained in previous tests on the same motor - under similar load, temperature and humidity conditions - may be an excellent parameter to evaluate the winding insulation conditions, instead of using the value obtained in a single test as the basis. Significant or sudden reductions are considered suspicious.

4.4.4 Measurement on the rotor and exciter windings

Measurement on the rotor winding:

- Disconnect the rotor cables from the diode set and from the discharge resistor (if any);
- Connect the instrument to measure the insulation resistance (megohmmeter) between the rotor winding and the motor shaft. The measuring current must not pass through the bearings.

Measurement of the main exciter stator winding:

- Disconnect the power supply cables from the exciter;
- Connect the instrument to measure the insulation resistance (megohmmeter) between the exciter stator winding and the motor frame.

Measurement on the main exciter rotor winding:

- Disconnect the cables of the exciter rotor from the diode set;
- Connect the instrument to measure the insulation resistance (megohmmeter) between the exciter rotor

winding and the motor shaft. The measuring current must not pass through the bearings.

Measurement of the auxiliary exciter stator winding (PMG), if any:

- Disconnect the cables that connect the auxiliary exciter to the voltage regulator;
- Connect the instrument to measure the insulation resistance (megohmmeter) between the auxiliary exciter stator winding and the motor frame.

4.4.5 Additional Information



ATTENTION

After measuring the insulation resistance, ground the tested winding in order to discharge it.

The test voltage to measure the insulation resistance of the rotor and space heater must be 500 Vdc and for the other accessories 100 Vdc.

It is not recommended to measure the insulation resistance of thermal protectors.

4.4.6 Polarization index

The polarization index is defined by the ratio between the insulation resistance measured in 10 minutes and the insulation resistance measured in 1 minute. This measurement procedure is always carried out at relatively constant temperatures. The polarization index allows the evaluation of the motor insulation conditions.



DANGER

In order to avoid accidents, the winding must be grounded immediately after measuring the insulation resistance.

4.4.7 Conversion of the measured values

The insulation resistance must be measured at 40 °C. If the measurement is performed at a different temperature, it is necessary to correct the reading to 40 °C by using a curve of the insulation resistance variation as a function of the temperature, obtained on the motor itself. If this curve is not available, the approximate correction provided by the curve in Figure 4.3, according to NBR 5383 / IEEE43, may be used.

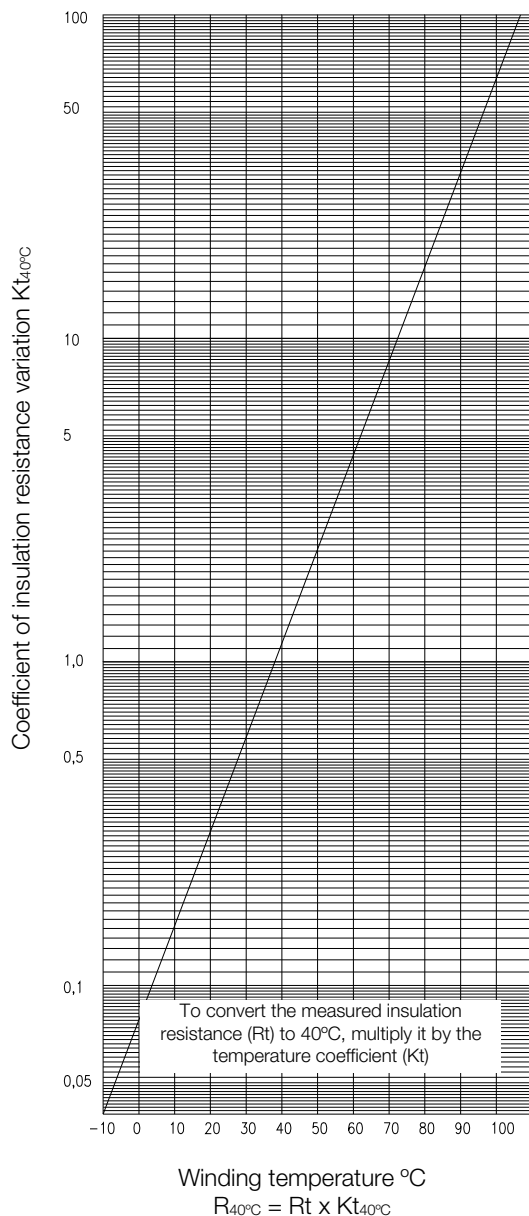

Figure 4.3: Insulation resistance variation coefficient according to the temperature

4.4.8 Insulation assessment

Table 4.2 and Table 4.3 present guiding limits of insulation resistance and polarization index for the assessment of the motor insulation conditions.

Table 4.2: Insulation resistance referential limits on electrical machines

Insulation resistance value	Insulation assessment
2 MΩ or lower	Unacceptable
< 50 MΩ	Dangerous
50...100 MΩ	Fair
100...500 MΩ	Good
500...1000 MΩ	Very Good
> 1000 MΩ	Excellent

Table 4.3: Polarization index (ratio between 10 minutes and 1 minute)

Polarization index	Insulation assessment
1 or lower	Unacceptable
< 1.5	Dangerous
1.5 to 2.0	Fair
2.0 to 3.0	Good
3.0 to 4.0	Very Good
> 4.0	Excellent



ATTENTION

If the measured insulation resistance, referred to 40 °C, is below 100 MΩ or the polarization index is below 2, before putting the motor into operation, consult WEG.

4.5 PROTECTIONS

Motors used in continuous duty must be protected against overloads by means of a motor integral device, generally a thermal relay with rated or adjustable current equal to or below the value obtained by multiplying the rated current of the motor at full load by:

- 1.25 for motors with service factor equal to or above 1.15;
- 1.15 for motors with service factor equal to 1.0.

Motors also have temperature sensors to be used as protection devices against excessive temperature rise (in case of overloads, lack of motor ventilation).

4.5.1 Thermal protections

The temperature sensors are installed on the main stator, bearings and other parts that require temperature monitoring and thermal protection. The terminals of the temperature sensors are available in the accessory box. These sensors must be connected to an external temperature monitoring and protection system.

4.5.1.1 Temperature sensors

Thermostats – Are bimetallic thermal detectors with normally closed silver contacts. They open at a certain temperature. The thermostats are connected in series or independently according to the connection diagram.

Thermistors (PTC or NTC) - Are thermal detectors composed of semiconductors that vary their resistance sharply when they reach a certain temperature. Thermistors are connected in series or independently according to the connection diagram.



NOTE

Thermostats and thermistors must be connected to a control unit in order to interrupt the motor operation or activate a signaling device.

RTDs (Pt100) - Are calibrated resistance elements. Their operation is based on the principle that the electrical resistance of a metallic conductor varies linearly with the temperature. The detector terminals must be connected to a control panel which includes a temperature meter.

 **NOTE**
Resistance temperature detectors (RTD) allow the monitoring via the absolute temperature informed through their instantaneous resistance value. With this information the relay, which can be programmed for alarm and trip according to pre-defined values, is able to perform the temperature reading.

4.5.1.2 Temperature limits for the windings

The temperature of the hottest spot of the winding must be kept below the limit of the insulation thermal class. The total temperature is obtained by the sum of the ambient temperature and the temperature rise (T), plus the difference between the average temperature of the winding and the hottest spot of the winding.

The ambient temperature must not exceed 40 °C, in accordance with NBR IEC60034-1 standard. Above this temperature, the working conditions are considered special and the motor specific documentation must be consulted.

Table 4.4 shows the numerical values and the composition of the acceptable temperature of the hottest spot on the winding.

Table 4.4: Insulation class

Insulation class (°C)	F	h
Ambient temperature	40	40
T = temperature rise (temperature measurement method by resistance variation)	105	125
Difference between the hottest point and the average temperature	10	15
Total: temperature of the hottest point	155	180

 **ATTENTION**
If the motor operates with temperatures in the windings above the limit values of the insulation thermal class, the lifespan of the insulation and, consequently, of the motor, will be significantly reduced, or it may even result in the motor burnout.

4.5.1.3 Alarm and trip temperatures

The motor alarm and trip temperatures must be set at the lowest possible value. These temperatures can be determined based on the factory tests or through the motor operating temperature. The alarm temperature can be set 10° C above the motor operating temperature at full load, always considering the highest ambient temperature on site. The adjusted trip temperatures must not exceed the maximum acceptable temperatures for the stator winding insulation class and for the bearings (considering the lubrication type and system), according to Table 4.5.

Table 4.5: Maximum temperature settings

	Maximum temperature settings for protections (°C)	
	Alarm	Tripping
Winding class F	130	155
Winding class H	155	180
Bearings	110	120

 **ATTENTION**
The alarm and trip values may be determined as a result of experience, but they must not exceed the values indicated in Table 4.5.

 **ATTENTION**
The motor protection devices are listed in the WEG drawing - Connection diagram. Not using these devices is the sole responsibility of the user and, in case of damage to the motor, it will void the warranty.

4.5.1.4 Temperature and ohmic resistance of the PT100 thermoresistance

Table 4.6 shows the temperature as a function of the ohmic resistance measured across PT100 RTDs.

$$\text{Formula: } \frac{\Omega - 100}{0.386} = ^\circ\text{C}$$

Table 4.6: Temperature X Resistance (Pt100)

°C	0	1	2	3	4	5	6	7	8	9
0	100.00	100.39	100.78	101.17	101.56	101.95	102.34	102.73	103.12	103.51
10	103.90	104.29	104.68	105.07	105.46	105.95	106.24	106.63	107.02	107.40
20	107.79	108.18	108.57	108.96	109.35	109.73	110.12	110.51	110.90	111.28
30	111.67	112.06	112.45	112.83	113.22	113.61	113.99	114.38	114.77	115.15
40	115.54	115.93	116.31	116.70	117.08	117.47	117.85	118.24	118.62	119.01
50	119.40	119.78	120.16	120.55	120.93	121.32	121.70	122.09	122.47	122.86
60	123.24	123.62	124.01	124.39	124.77	125.16	125.54	125.92	126.31	126.69
70	127.07	127.45	127.84	128.22	128.60	128.98	129.37	129.75	130.13	130.51
80	130.89	131.27	131.66	132.04	132.42	132.80	133.18	133.56	133.94	134.32
90	134.70	135.08	135.46	135.84	136.22	136.60	136.98	137.36	137.74	138.12
100	138.50	138.88	139.26	139.64	140.02	140.39	140.77	141.15	141.53	141.91
110	142.29	142.66	143.04	143.42	143.80	144.17	144.55	144.93	145.31	145.68
120	146.06	146.44	146.81	147.19	147.57	147.94	148.32	148.70	149.07	149.45
130	149.82	150.20	150.57	150.95	151.33	151.70	152.08	152.45	152.83	153.20
140	153.58	153.95	154.32	154.70	155.07	155.45	155.82	156.19	156.57	156.94
150	157.31	157.69	158.06	158.43	158.81	159.18	159.55	159.93	160.30	160.67

4.5.2 Space heater

When the motor is equipped with a space heater to prevent internal water condensation during long periods out of operation, it must be assured that the space heater is energized shortly after turning the motor off, and that it is de-energized before the motor is put into operation. The values of the space heater supply voltage and power are informed in the connection diagram and in the specific plate affixed to the motor.

4.5.3 Water leak sensor

Motors with air-water heat exchanger are supplied with a water leak sensor intended to detect water leaks from the radiator into the motor. This sensor must be connected to the control panel, according to the motor connection diagram. The signal of this sensor must be used to activate the alarm.

When this protection actuates, the heat exchanger must be inspected and, if any water leak is detected, the motor must be shut down and the problem corrected.

4.6 COOLING

The motor cooling system may vary according to its application.

Only the proper installation of the motor and of the cooling system can ensure its continuous operation without overheating.



ATTENTION

The protection devices of the cooling system must be monitored periodically; The air and/or water inlets and outlets must not be obstructed, because this could cause overheating and even lead to the motor burnout. For further details, refer to the motor dimensional drawing.

4.6.1 Air-water heat exchanger cooling

In motors with air-water heat exchangers, the internal air, in a closed circuit, is cooled by the radiator, which is a surface heat transmitter designed to dissipate heat. Clean water with the following characteristics must be used as coolant:

- pH: 6 to 9;
- Chlorides: maximum 25.0 mg/l;
- Sulphates: maximum 3.0 mg/l;
- Manganese: maximum 0.5 mg/l;
- Suspended solids: maximum 30.0 mg/l;
- Ammonia: without ammonia dashes.



ATTENTION

Data of the radiators that compose the air-water heat exchanger are informed on their nameplate and on the motor dimensional drawing.

This data must be observed for the proper operation of the motor cooling system, thus, preventing overheating.

4.6.1.1 Radiators for application with sea water



ATTENTION

In the case of radiators for applications with sea water, the materials in contact with the water (pipes and plates) must be corrosion resistant. Furthermore, the radiators may be fitted with sacrificial anodes (e.g., zinc or magnesium), as shown in Figure 4.4, which corrode during the heat exchanger operation, protecting the radiator heads. In order to maintain the integrity of the radiator heads, these anodes must be replaced periodically, according to their corrosion level.

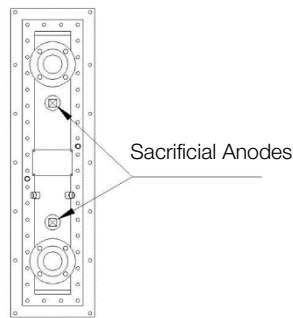



Figure 4.4: Radiator with sacrificial anodes

 **NOTE**
The type, quantity and position of the sacrificial anodes may vary according to the application.

4.6.2 Independent ventilation cooling

The **independent fans** are driven by three-phase asynchronous motors, with integral terminal boxes. The characteristic data (frequency, voltage, etc.) are on the nameplate of these motors, and the rotation direction is indicated by a plate affixed to the fan housing or close to it.

 **NOTE**
It is necessary to check the rotation direction of the independent ventilation motors before starting the motor.
If the rotation direction is opposite to the specified, invert the connection of two of their power supply phases.

The **air filters** (if any) which prevent the ingress of dirt into the motor must be regularly inspected, according to the section “Maintenance Plan” of this manual. The filters must be in perfect condition to ensure the proper operation of the cooling system and the permanent protection of the motor sensitive internal parts.

4.7 ELECTRICAL ASPECTS

4.7.1 Electrical connections

 **ATTENTION**
Analyze the electrical connection diagram supplied with the motor carefully before beginning the connection of the power, grounding and accessory cables. For the electrical connection of the auxiliary equipment, refer to their specific manuals.

4.7.1.1 Main electrical connections

The location of the power, neutral and rotor terminal boxes are identified in the specific dimensional drawing of each motor.

The stator and rotor terminal identifications and their corresponding connections are indicated in the specific motor connection diagram.

Make sure the cross section and insulation of the connection cables are suitable for the motor current and voltage.

The motor must rotate in the rotation direction specified on the nameplate and/or on the plate affixed to the drive end of the motor.

 **NOTE**
The rotation direction is, by convention, determined looking to the shaft end at the motor drive end.
Motors with a single rotation direction must only rotate in the indicated direction, since fans and other devices are unidirectional. In order to operate the motor in the rotation direction opposite to the specified, consult WEG.

 **ATTENTION**
Before making the connections between the motor and the power line, it is necessary to perform a careful measurement of the winding insulation resistance.

In order to connect the motor main power cables, unscrew the stator terminal box cover, cut the sealing rings (standard motors without cable gland) according to the diameter of the cables to be used and insert the cables in the sealing rings. Cut the power cables to the necessary length, strip the ends and mount the cable lugs that will be used.

4.7.1.2 Grounding

The motor frame and the main terminal box must be grounded before connecting the motor to the power line. Connect the metal sheath of the cables (if any) to the common grounding conductor. Cut the grounding conductor to the proper length and connect it to the terminal in the terminal box and/or frame. Fasten all connections firmly.

 **ATTENTION**
Do not use washers made of steel or other materials with low electrical conductivity to fasten the cable lugs.

4.7.1.3 Field power supply and control

The power supply and the control of the field must be connected and adjusted according to the connection diagram of the motor and the specific manual of the excitation panel.

4.7.2 Connection diagram

- The connection diagram of the stator, rotor and accessories is supplied together with the motor documentation.
- Figure 4.5 shows the single line connection diagram of a synchronous motor without brushes.

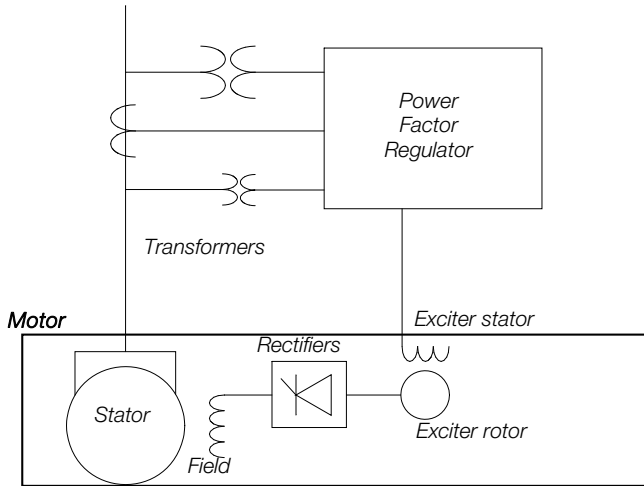

Figure 4.5: General connection diagram (brushless synchronous motor)

4.8 MECHANICAL ASPECTS

4.8.1 Foundations

- The foundation or structure where the motor will be installed must be sufficiently rigid, flat, free of external vibration and capable to withstand the mechanical loads to which it will be submitted;
- If the foundation dimensioning is not carefully executed, this may cause serious vibration on the foundation set, motor and turbine;
- The foundation structural design must be done based on the dimensional drawing, on the information about the foundation mechanical loads, and on the motor anchoring method.



ATTENTION

Place shims of different thicknesses between the motor supporting surfaces and the foundation in order to allow a precise alignment.



NOTE

The user is responsible for dimensioning and building the foundation where the motor will be installed.

4.8.2 Foundation loads

The foundation loads are informed in the motor documentation.

4.8.3 Base types

4.8.3.1 Concrete base

Concrete bases are the most widely used for the installation of electric motors.

The type and size of the foundation, bolts and anchoring plates depend on the motor size and type.

4.8.3.2 Metal base

The motor must rest evenly on the metal base in order to prevent deformations of the frame. Occasional height errors of the surface that supports the motor can be corrected with compensation plates (shims).

Do not remove the motor from the common base to make the alignment. The base must be leveled on the foundation itself by using leveling instruments.

When a metal base is used to align the height of the motor shaft end to the coupled machine shaft end, it must be leveled on the concrete base.

After the base has been leveled, the anchor bolts tightened and the couplings checked, the metal base and the anchor bolts can be cemented.

4.8.4 Natural frequency of the base

In order to ensure a safe operation, the motor must be precisely aligned with the coupled equipment and both must be properly balanced.

As a requirement, the motor installation base must be flat and meet the requirements of DIN 4024-1 standard.

In order to verify if the criteria of the standard are being met, the following potential vibration excitation frequencies generated by the motor and coupled machine must be evaluated:

- The motor rotation frequency;
- The double of the rotation frequency;
- The double of the motor electric frequency. According to DIN 4024-1 standard, the natural frequencies of the base or foundation must be away from these potential excitation frequencies, as specified next:
- The first natural frequency of the base or foundation (first order natural frequency of the base) must be out of the range from 0.8 to 1.25 times any of the potential excitation frequencies above;
- The other natural frequencies of the base or foundation must be out of the range from 0.9 to 1.1 times any of the potential excitation frequencies above;

4.8.5 Mounting



ATTENTION

Mount the motor in a safe way and align it properly. The inadequate mounting can generate excessive vibration, causing early wear of the bearings and even break the shaft.

4.8.6 Anchor plate set

The anchor plate set, when used, is composed of the anchor plate, leveling bolts, leveling shims, alignment bolts and anchor bolts.



NOTES

When WEG supplies the anchor plate for fastening and aligning the motor, the dimensional and installation details of the anchor plate are supplied in the specific dimensional drawing of the motor.

The user is responsible for mounting, leveling and grouting the anchor plates (except when specific agreement establishes otherwise).

The anchor bolts must be fastened according to Table 4.7.

Table 4.7: Tightening torque of the anchor bolts

Type Ø	Tightening torque (*) Nm
M30	550
M36	960
M42	1460
M48	2200

* using lubricant paste for the bolts (Molykote P37)

After positioning the motor, perform the final leveling by using the vertical leveling bolts and the leveling shims.



ATTENTION

Protect all the threaded holes to prevent grout from penetrating the threads during the grouting of the anchor plate and anchor bolts.

4.8.7 Leveling

The motor must rest on a surface with flatness of up to 0.08 mm/m.

Verify whether the motor is perfectly leveled both in the vertical and horizontal planes. Make the proper adjustments by placing shims under the motor. The motor leveling must be checked with proper equipment.

Leveling shims

During the motor mounting, leveling shims must be inserted between the motor and the anchor plate, so that the alignment procedure begins with this amount of shims, as follows:

- 3 mm of stainless steel shims (2 mm + 1 mm) or
- 5,40 mm galvanized steel shims (2,7 mm + 2,7 mm)

The other shims shown in Table 4.8 will be kept aside to be used in different combinations in order to obtain the necessary thicknesses to provide the required leveling. The maximum thickness of the leveling shims must not exceed 4.5 mm.

Table 4.8 shows the quantity of stainless steel shims or galvanized steel shims for each motor support region on the anchor plate.

Table 4.8: Leveling shims

Stainless steel shims		Galvanized steel shims	
Quantity (un.)	Thickness (mm)	Quantity (un.)	Thickness (mm)
2	0,1	2	0,43
2	0,2	2	0,50
2	0,5	1	0,65
2	1	1	0,80
1	2	1	1,95
-	-	2	2,70

4.8.7.1 Support



NOTE

At least 75% of the support surfaces area of the motor feet must be supported on the base.

4.8.8 Alignment

The motor must be properly aligned with the coupled machine.



ATTENTION

Incorrect alignment may result in bearing damages, generate excessive vibration and even break the shaft.

The alignment must be done according to the coupling manufacturer recommendations. The motor and coupled machine shafts must be aligned in the axial and radial directions, as shown in Figure 4.6 and Figure 4.7.

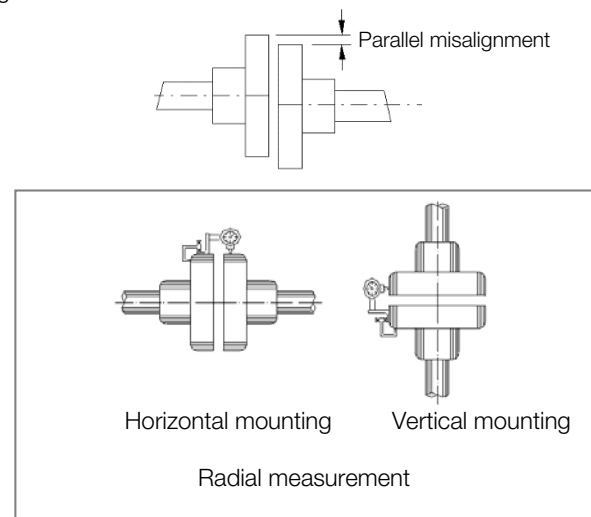

Figure 4.6 shows the parallel misalignment of the two shaft ends and the practical way to measure it by using suitable dial gauges.

The measurement is performed in four points 90° away from each other with the two half-couplings rotating together to eliminate effects of support surface irregularities on the dial gauge tip. Choosing the upper vertical point as 0°, half the difference between the dial gauge measurements at the 0° and 180° points represents the vertical coaxial error. In case of deviation, it must be corrected by adding or removing leveling shims.

Half of the difference between the dial gauge measurements at the 90° and 270° points represents the horizontal coaxial error.

These measurements indicate when it is necessary to lift or lower the motor, or move it to the right or to the left on the drive end in order to eliminate the coaxial error.

Half of the maximum difference among the dial gauge measurements in a complete rotation represents the maximum eccentricity found.

The misalignment in a complete shaft rotation, with rigid or semiflexible coupling, cannot exceed 0.03 mm.

When flexible couplings are used, greater values than those indicated above are acceptable, provided that they do not exceed the value allowed by the coupling manufacturer.

It is recommended to keep a safety margin for these values.

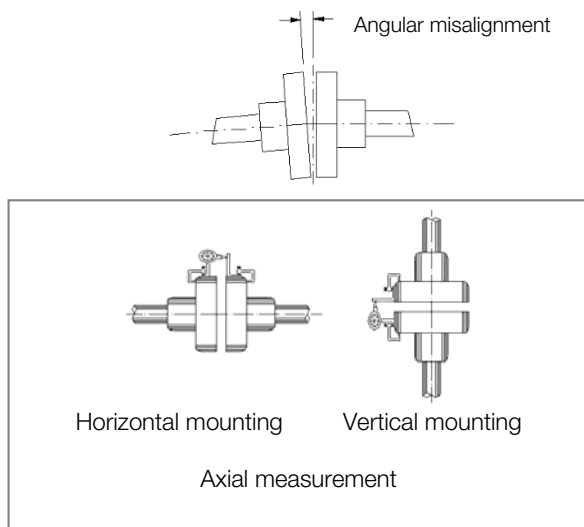

Figure 4.7: Angular alignment

Figure 4.7 shows the angular misalignment and a practical form to measure it.

The measurement is done in four points 90° away from each other, with the two half-couplings rotating together to eliminate effects of support surface irregularities on the dial gauge tip. Choosing the upper vertical point as 0°, half of the difference between the dial gauge measurements at the 0° and 180° points represents the vertical misalignment. In case of deviation, it must be corrected by adding or removing alignment shims.

Half the difference between the dial gauge measurements at the 90° and 270° points represents the horizontal misalignment, which must be corrected by displacing the motor in the lateral/angular direction.

Half of the maximum difference among the dial gauge measurements in a complete rotation represents the maximum angular misalignment found.

The misalignment in a complete shaft rotation, with rigid or semiflexible coupling, must not exceed 0.03 mm. When flexible couplings are used, greater values than those indicated above are acceptable, provided that they do not exceed the value allowed by the coupling manufacturer.

It is recommended to keep a safety margin for these values.

In the alignment/leveling, the influence of temperature on the motor and coupled machine must be taken into account. Different expansions of the parts may change the alignment/leveling conditions during operation.



ATTENTION

After aligning the set and having assured a perfect alignment (**both hot and cold**), the motor must be doweled to the anchor plate or to the base, according to the information in the motor dimensional drawing.

4.8.9 Inspection of pedestal bearings



ATTENTION

Pedestal bearings must be inspected and, if necessary, realigned according to the instructions below:

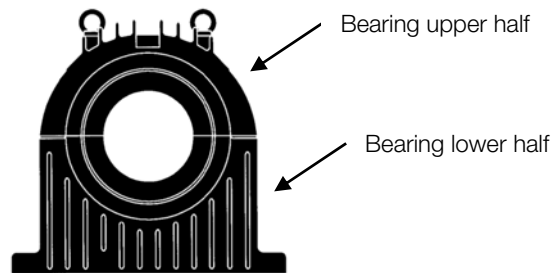

Figure 4.8: Pedestal bearing

Drive end bearing alignment

1. Loosen the fixing bolts of the two halves of the drive end bearing housing;
2. Lift the upper half of the bearing housing;
3. Loosen the fixing bolts of the two halves of the bearing shell and lift the upper half;
4. Lubricate the shaft sliding surface and the sliding surface of the upper half of the bearing shell, if necessary, with the same kind of oil of the bearing using a piece of soft and absorbent paper or a clean cloth that does not release lint;
5. Check if the face of the split part of the lower half of the bearing shell is aligned with the face of the split part of the lower half of the bearing housing by using a rigid and perfect parallel bar.
6. Using a feeler gauge, check the clearances between the lower half of the bearing shell and the shaft in four points (right, left, front and back sides of the bearing shell);
7. In case the measured clearances are different, or the faces of the split parts of the bearing shell are misaligned with the faces of the split part of the bearing housing, the bearing shell must be aligned with the shaft, as follows:
8. Loosen the fixing bolts of the two halves of the non-drive end bearing housing before lifting the shaft;
9. Lift the drive end of the motor shaft just enough for the rotor weight not to rest on the bearing shell so that it can be adjusted in the spherical seat of the lower half of the bearing housing;



NOTE

Between the shaft and the lifting device, use a material softer than the shaft material, in order to prevent damages (copper or bronze, for instance).

10. Align the bearing shell making the measurements according to items 5 and 6;
11. Lower the shaft until it touches the lower bearing shell;
12. Mount the upper half of the bearing shell and tighten the fixing bolts of this half to the lower half of the bearing shell, with the torque specified in Table 4.9;
13. Apply a layer of CURIL T sealing on the machined faces of the lower half of the lower bearing housing;
14. Using a hoist, mount the upper half of the bearing housing on the lower half;
15. Tighten the bolts applying the torque specified in Table 4.10;
16. After the proper tightening of the bolts, apply **colored sealing liquid** between the bolts and bearing housing to indicate that they have received the correct torque.

Non-drive end bearing alignment

Use the same alignment procedure as used to align the drive end bearing.



ATTENTION

The two pedestal bearings must be perfectly aligned.

Table 4.9: Bearing shell torque

Pedestal bearing size	Torque (Nm)
14	20
18 – 22	69
28 – 35	170
45	330

Table 4.10: Bearing house torque

Pedestal bearing size	Torque (Nm)
14	170
18	330
22	580
28	1160
35	1150
45	2010

4.8.10 Couplings

Only proper couplings, which convey only torque without generating transversal forces, must be used.

For both flexible and rigid couplings, the shaft centers of the coupled machines must be in a single line.

Flexible couplings mitigate the effects of residual misalignments and prevent transmission of vibration between the coupled machines, which does not occur when rigid couplings are used.

The coupling must be mounted or removed with the aid of proper devices and never by means of rudimentary tools, such as hammers, sledgehammers, etc.



ATTENTION

Dowel pins, nuts, washers and leveling shims may be supplied with the motor when requested in the purchase order.



NOTES

The user is responsible for the motor installation (except when specified by commercial agreement). WEG is not liable for damages to the motor, associated equipment and installation occurred because of:

- Transmission of excessive vibration;
- Poor installations;
- Faulty alignment;
- Improper storage conditions;
- Noncompliance with the instructions before start-up;
- Incorrect electrical connections.

4.8.10.1 Direct coupling

Because of issues about cost, space economy, problems with belt sliding and more safety against accidents, direct coupling must be used whenever possible. Also, direct coupling is preferable in case of transmission with reduction gearing.



ATTENTION

Align the shaft ends carefully, and, whenever possible, use flexible coupling, leaving a minimum clearance (E) of 3 mm between the couplings, as shown in Figure 4.9.

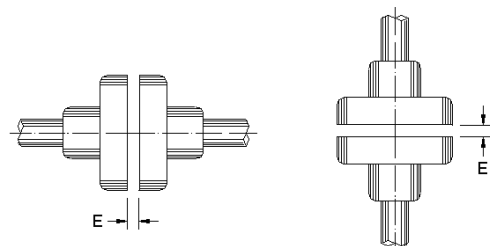

Figure 4.9: Axial clearance of the coupling (E)

4.8.10.2 Gear coupling

Gear couplings badly aligned generate vibration in the transmission itself and in the motor. Therefore, caution must be taken so that the shafts be perfectly aligned, rigorously parallel in case of spur gear transmissions and in a correct angle in case of transmissions by bevel or helical gears.

The gear teeth meshing can be controlled with the insertion of a paper strip, on which the trace of all teeth shows up after a gear turn.

4.8.10.3 Coupling of motors equipped with sleeve bearings

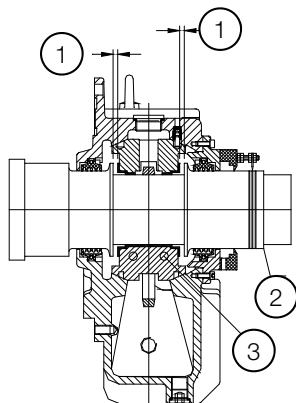

Figure 4.10: Sleeve bearing

Figure 4.10 legend:

- 1. Axial clearance
- 2. Shaft
- 3. Bearing shell



ATTENTION

Motors equipped with sleeve bearings must operate with direct coupling to the driving machine or by means of a gear box. This kind of bearing does not allow belt drive.

Motors equipped with sleeve bearings have three marks on the shaft end, so that the central mark (painted red) is the indication of the magnetic center, and the two outer marks indicate the allowed limits for axial rotor movement.

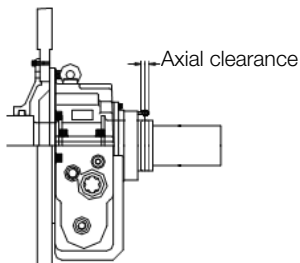

Figure 4.11: Magnetic center mark

For the motor coupling, the following factors must be taken into account:

- Bearing axial clearance;
- Axial displacement of the driving machine (if any);
- Maximum axial clearance allowed by the coupling.



ATTENTION

- Move the shaft completely forwards and then perform the correct measurement of the axial clearance;
- Align the shaft ends carefully and, whenever possible, use flexible coupling, leaving a minimum axial clearance of 3 to 4 mm between the couplings.



NOTE

If it is not possible to move the shaft, then the shaft position, the shaft forward displacement (according to the marks on the shaft), and the axial clearance recommended for the coupling must be considered.

- Before putting it into operation, it is necessary to check whether the motor shaft allows free axial movement within the aforementioned clearance conditions;
- In operation, the arrow must be positioned on the central mark (red), which indicates that the rotor is in its magnetic center;
- During the start, or even in operation, the motor may move freely between the two outer limit marks.



ATTENTION

The sleeve bearings used on this motor were not designed to withstand constant axial loads; therefore, under no circumstances can the motor continuously operate under axial load on the bearings. The motor can only operate continuously under axial and/or radial loads on the bearing if the criteria informed in the machine documentation are observed.

4.9 BRAKE

For further information on the installation, operation and maintenance of the brake (if any), refer to the motor dimensional drawing and the specific manual of this equipment.

4.10 HYDRAULIC UNIT

For further information on the installation, operation and maintenance of the hydraulic unit (if any), refer to the motor dimensional drawing and the specific manual of this equipment.

5 STARTING

The type of starting used for synchronous motors is specified during the project and depends on the following factors:

- Short-circuit capacity of the power supply;
- Acceptable voltage drop (maximum current with minimum starting voltage);
- Resistive torque and load inertia;
- Starting time;
- Starting duty.

The number of successive starts depends on the used starting procedure.

5.1 DIRECT ON-LINE STARTING

It is the simplest and most economically feasible method; however, it must only be used when the starting current does not affect the power grid.

Bear in mind that the starting current of motors may reach 6 to 7 times the rated current value. Therefore, it must be ensured that this current (I_p) will not affect the supply of other consumers because of the high voltage drop in the power grid.

This requirement is met in one of the three situations:

- a) When the power grid is "**strong**" enough and the motor current is negligible in relation to the grid capacity.
- b) The motor is always started without load, which reduces the starting time and, in turn, the duration of the starting current and the momentary voltage drop, which is acceptable for the other consumers of the grid;
- c) When DOL starting is duly authorized by the local electric utility company.

When the motor starting current is high, the following detrimental consequences may occur:

- a) The high voltage drop in the power supply system may cause interference in equipment installed in this system;
- b) The protection system (cables, contactors) must be oversized, increasing the installation costs.



NOTE

In some cases, there is an imposition of the electric utility companies that limits the voltage drop of the grid.

5.1.1 Direct start with discharge resistor

- In order to start the motor, the exciter field must be energized by the DC supply of the excitation panel. When the circuit breaker of the motor main circuit is activated, the main field winding supply is blocked by the triggering circuit located in the brushless exciter, which also connects the starting resistor in series with the motor main field winding.
- Through the cage (generally called damper), enough torque is developed to accelerate the rotor up to close to the synchronous speed;
- When the rotor has reached enough speed for the synchronization, then the triggering circuit disconnects the starting resistor and applies direct current to the motor field winding, which will start rotating at the speed of the rotating field of the main stator (synchronous speed).
- Any unbalance or vibration must be investigated.

5.1.2 Direct start without discharge resistor

- In order to start the motor, the exciter field must not be energized by the DC supply of the excitation panel.
- The circuit breaker of the motor main circuit is activated, and through the cage (generally called damper) enough torque is developed to accelerate the rotor up to close to the synchronous speed.
- When the rotor has reached enough speed for the synchronization, then the exciter field must be energized to synchronize the motor, which will start rotating at the speed of the rotating field of the main stator (synchronous speed).
- Any unbalance or vibration must be investigated.

5.1.3 Direct online start frequency

Since brushless synchronous motors have a high starting current, the time spent to accelerate loads with high inertia results in a quick rise of the motor temperature. If the intervals between successive starts are too short, the temperature of the windings will rise quickly, reducing their useful life or even burning them. The standards establish a minimum starting duty to which the motors must be able to comply:

- a) Two successive starts, being the first one with the motor cold, i.e., with its windings at ambient temperature, and the second one right afterwards, but after the motor has decelerated to a full stop;
- b) One start with the motor hot, i.e., with the windings at continuous duty temperature.

The first condition simulates the case in which the first motor start is aborted, for instance, by the trip of the motor protection, when a second motor start is permitted right afterwards.

The second condition simulates the case of an accidental motor shutdown under normal operation, for instance, by power outage, when the motor restart is allowed right after the power is reestablished.



NOTE

Special starting conditions must be checked in the specific motor documentation before starting the procedure.

5.1.4 Locked rotor current (I_p/I_n)

The motor nameplate indicates the value of I_p/I_n , which is the relation between the starting current and the rated current of the motor.

5.2 STARTING WITH REDUCED CURRENT

If direct online start is not possible, the following starting systems can be used in order to reduce the starting current:

- With reactor
- With autotransformer
- With frequency inverter
- With soft-starter.



ATTENTION

The selection of the starting method depends on a previous evaluation of the motor performance to validate the procedure.

5.2.1 Starting with reactor

In the starting with reactor, an impedance in the form of a reactor is connected in series to the main terminals of the motor, reducing the voltage at the motor terminals, resulting in a reduction of the starting current. For being a function of the current that passes through the reactor, the impedance gradually reduces the motor acceleration, and when the motor reaches 95% of the rated speed, the reactor is short-circuited, the motor is synchronized and starts operating at full voltage.



ATTENTION

It is necessary assure an acceleration torque that is sufficient to start the motor, because with this starting method there is a substantial reduction in the starting torque.

5.2.2 Starting with autotransformer

The effect of starting with autotransformer is similar to that of starting with reactor. The use of a transformer to limit the voltage reduces the starting current and the torque. The starting torque is reduced proportionally to the line current.

The start of the motor with autotransformer consists of a voltage transformer with taps that allow the operation with reduced voltage until reaching the full voltage. The taps may be modified during starting until reaching the synchronization torque and speed.

5.2.3 Starting with frequency inverter

For the starting and operation of the motor with frequency inverter, refer to the equipment manual.

5.2.4 Starting with soft-starter

The starting procedure with soft-starter is similar to direct start, except for the time to accelerate the load up to the synchronization speed, which is longer.

During the starting process, the soft-starter progressively increases the motor voltage from zero, allowing the motor to accelerate the load up to the rated speed without causing current or torque peaks.

The soft-starter can also be used to control the motor stopping.

5.3 EXCITATION CIRCUITS

The type of excitation circuit used in the asynchronous starting of the brushless motor depends on the application, and it is described in its specific documentation.

5.3.1 Excitation circuit with voltage control (Random)

The circuit shown in Figure 5.1 works as follows:

- During normal motor operation, the exciter rotor and the D1-D6 diodes generate rectified DC voltage to supply field current to the motor according to the exciter field current supplied by an external controlled source.
- During normal operation, the SCR1 and SCR2 thyristors are not conducting;
- During the motor starting, the rotating field generated by the motor stator induces a very high alternate voltage in the motor field winding which is proportional to the ratio between the number of turns of the stator and the slip;
- In order to prevent damages to the insulation system and to the other rotor components, the exciter rectifier offers a low impedance path for the current that reduces the induced voltage to acceptable levels preventing the current from circulating through the exciter armature winding;

- When the field induced current is in the positive direction, the diode bridge will deviate the induced field current with a small voltage drop;
- When the induced field current is in the negative direction, the alternate voltage of the field winding is positive by means of the SCR1, SCR2 thyristors and in the triggering circuits;
- The circuit is arranged so that the triggering circuits identify the full voltage. As the alternate voltage increases, the triggering circuits make the SCRs conduct;
- The voltage level of the triggering circuits is specified to be sufficiently above the normal operation field voltage;
- When the motor gets close to the synchronous speed, the induced field voltage and the frequency of this voltage get close to zero;
- The exciter field voltage, which until this moment remained not applied by the external voltage supply and control, can now be applied, increasing the exciter DC voltage to the operation levels;
- If the SCR1 and SCR2 thyristors are conducting when the exciter has a significant voltage, the connection between the crossing of SCR1 and SCR2 and the exciter AC phase will allow the cut-off of the thyristors when the motor induced field current is no longer negative.

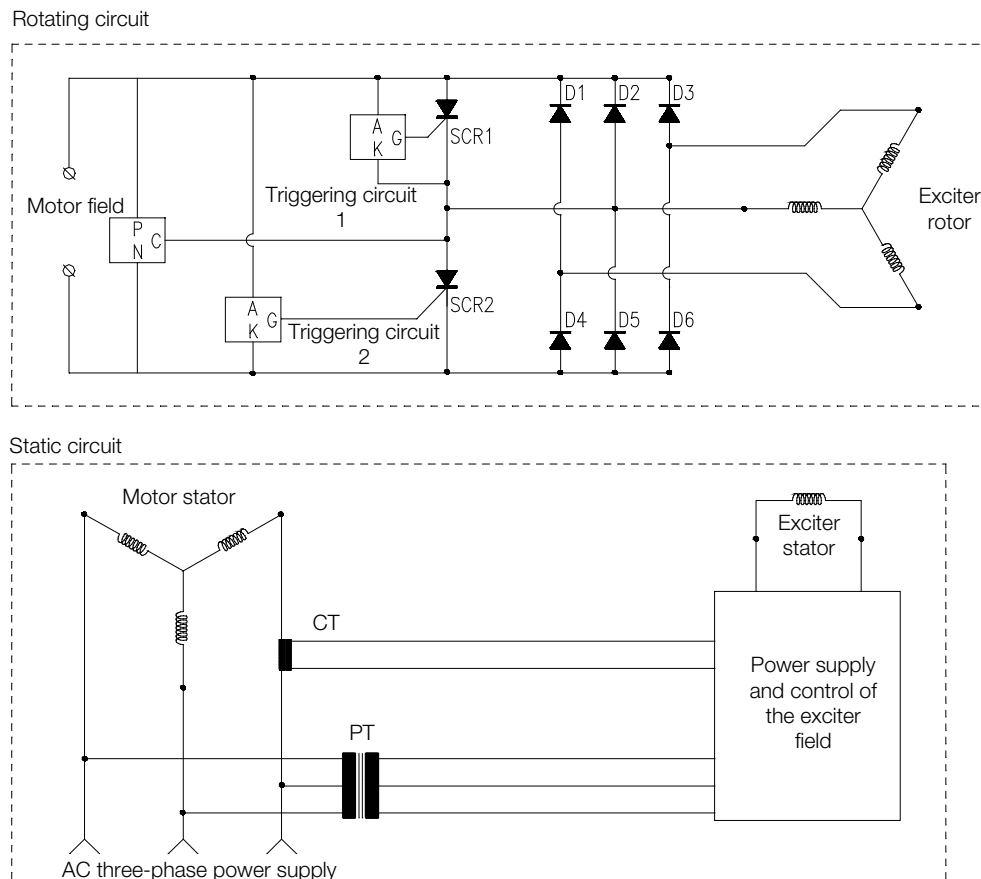

Figure 5.1: Triggering circuit with voltage control

5.3.3 Excitation circuit with frequency control

The circuit shown in Figure 5.2 works as follows:

- During normal operation, the exciter rotor and the D1-D6 diodes generate rectified DC voltage to supply field current to the motor according to the exciter field current supplied by an external controlled source;
- During the motor starting, the rotating field generated by the motor stator induces a very high alternate voltage on the motor field winding which is proportional to the relation between the number of turns of the stator and the slip;
- The exciter field must be energized during the motor start as soon as the motor circuit breaker is closed. That allows the exciter output voltage to increase with the increase of the motor speed. The SCR2 thyristor is not conducting;
- When the induced field current is in the positive direction, the current circulates through the starting resistor and the D7 diode;
- When the induced field current is in the negative direction, the SCR1 thyristor is initially off. The voltage increases quickly until the controller activates the SCR1, and, at this moment, the current of negative direction circulates through the SCR1 and the starting resistor;
- Close to the synchronous speed, the SCR2 thyristor is continuously activated, so that the field voltage is applied even if the motor is with a light load and the acceleration up to the rated speed occurs before the control can react during a positive semi-cycle.
- The SCR3 thyristor provides a switching off circuit for the SCR1 thyristor in case a transient interference activates the starting resistor during normal operation. The motor control notices a continuous voltage in the starting resistor and activates the SCR3 thyristor. SCR3 provides an alternate temporary path for the current, deviating it from the SCR1 thyristor, allowing SCR1 to be turned off. When the phase of the exciter connected to SCR3 thyristor is no longer supplying current to the starting resistor, the SCR3 thyristor returns to its normal blockade state.

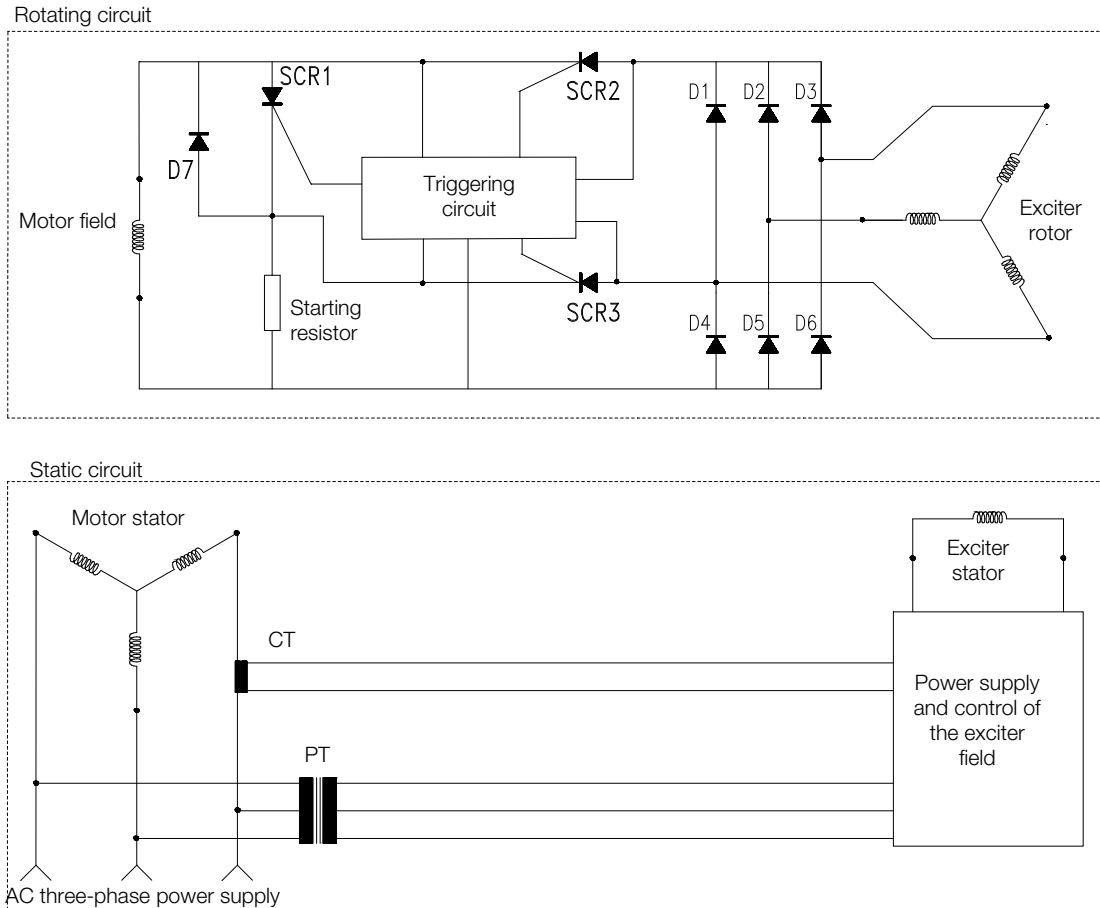

Figure 5.2: Triggering circuit with frequency control

5.3.4 Excitation circuit for AC exciter

The circuit shown in Figure 5.3 used in brushless synchronous motors with AC exciter for **frequency inverter drive system** works as follows:

- During normal operation, the exciter rotor and the D1-D6 diodes, which are fixed to the motor shaft, generate a rectified DC voltage to supply field current to the motor according to the exciter field current supplied separately by an exciter drive in alternate current.
- During the motor operation, the rotating field of the exciter stator induces an alternate voltage on the exciter rotor, even when the motor is completely stopped. The

field excitation is controlled by the exciter drive by means of voltage amplitude;

- The AC exciter phase sequence makes the slip increase from 1 to normally 3 at maximum speed. That is why the rotating field applied to the exciter stator must rotate in the opposite direction of the motor rotation direction;
- If the rotating field has the same direction of motor rotation and they have the same speed, then the induced voltage and current in the exciter rotor will be zero;
- This kind of rectifier configuration is not used for direct start. Start this motor only by using a frequency inverter.

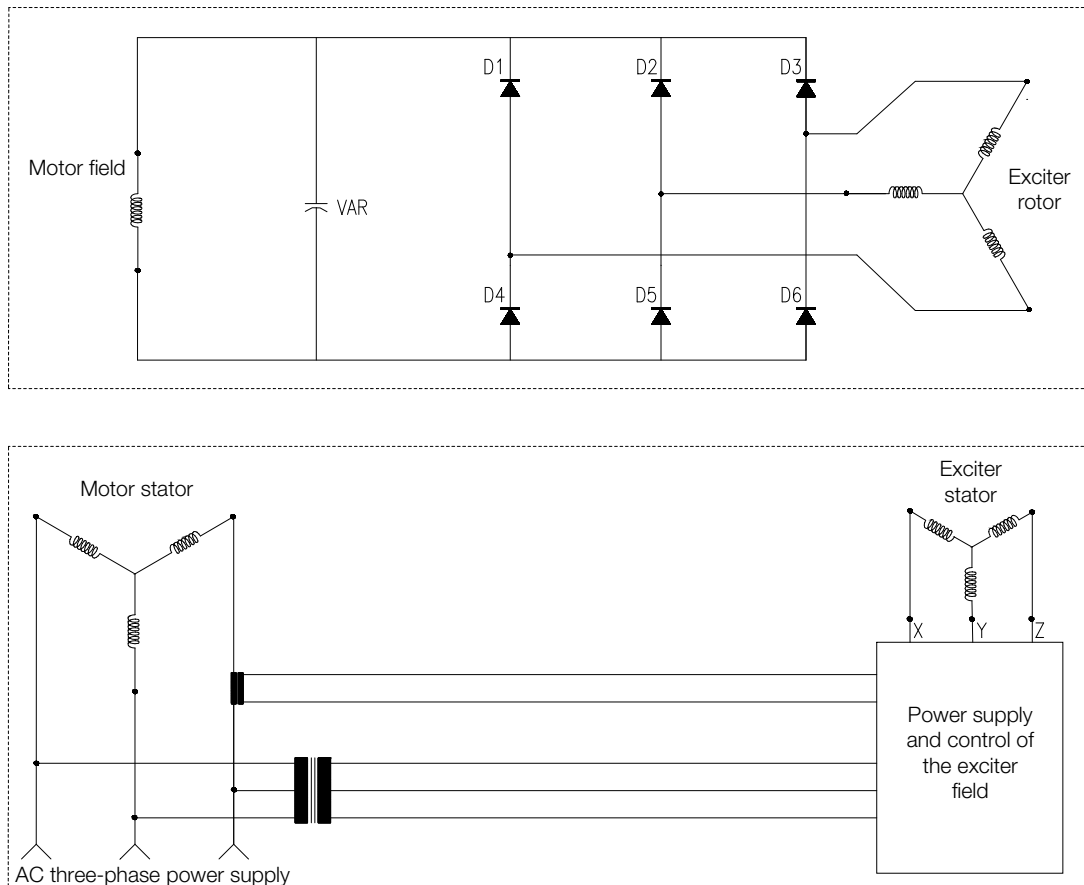

Figure 5.3: Triggering circuit for AC exciter.

6 COMMISSIONING

When the motor is started for the first time or after a prolonged standstill, several aspects must be considered besides the regular operation procedures.



ATTENTION

- Avoid any contact with electric circuits;
- Even low-voltage circuits may be life threatening;
- In any electromagnetic circuit, overvoltages may occur under certain operating conditions;
- Do not open an electromagnetic circuit suddenly, because the presence of an inductive discharge voltage may break the insulation or injure the operator;
- In order to open those circuits, disconnect switches or circuit breakers must be used.

6.1 PRELIMINARY INSPECTION

Before the first operation of the motor or after long periods out of operation, the following items must be inspected:

1. Check if the motor is correctly aligned;
2. Check if the motor feet were fixed with the torque recommended in this manual. The motor must be doweled to the base;
3. Check if the motor is clean and if the packages, measuring instruments and alignment devices were removed from the motor operating area;
4. Check if the motor is properly grounded;
5. Measure the insulation resistance of the windings, making sure they are within the specified value;
6. Check if coupling connecting components are in perfect operating conditions, duly tightened and greased, when necessary;
7. Check if the bearings are not damaged, if they are properly fixed and aligned;
8. Check if the bearings are properly lubricated. The lubricant must be of the type specified on the nameplate. Check the oil level of oil-lubricated bearings. Bearings with forced lubrication must have the oil pressure and flow as specified in their nameplate;
9. Check if the field control and the excitation system are properly connected according to the instruction in the specific installation manual;
10. Check if the protection relay is parameterized and operating according to the selectivity study;
11. Check if the power grid cables are properly connected to the motor main terminals and ensure that they are properly tightened and no short-circuit possibility exists;
12. Inspect the cooling system. In water-cooled motors, inspect the operation of the radiator water supply system. In motors with forced ventilation, check the rotation direction of the fans;
13. Motor air inlets and outlets must be unobstructed;
14. The moving parts of the motor must be protected to prevent accidents;
15. The terminal box covers must be properly fastened;
16. Test the high-pressure oil injection system (if any), ensuring its proper operation;
17. Check if the brake is properly fixed and adjusted (if any). Check the operation of the brake control panel;
18. Test the hydraulic unit operation (if any), ensuring its proper operation;
19. When rotating the motor rotor, check if it does not present strange noises.

6.2 FIRST START

6.2.1 Initial starting procedure

After all preliminary inspections have been carried out, proceed according to the directions presented next in order to perform the first start of the uncoupled motor:

1. Turn off the space heater;
2. Set the protections in the motor protection/excitation panel;
3. In oil-lubricated bearings, check the oil level;
4. In bearings with forced-lubrication, start the oil circulation system and check the level, flow and pressure of the oil, making sure that they comply with the data on the nameplate.
5. If the system has an oil flow detection device, it must be waited until the return signal from the oil circulation system of both bearings is received, which makes sure that the oil has reached the bearings;
6. Turn on the industrial water cooling system checking the required flow and pressure (motors with air-water heat exchanger);
7. Turn on the fans (motors with forced ventilation);
8. Switch on the high-pressure oil injection system (if any), keeping it on as informed in the motor technical documentation until the bearings can get the lubrication by self-pumping;
9. Release the brakes (if any);
10. Check the motor rotation direction;



ATTENTION

In order to invert the rotation direction of motors with single direction, it is necessary to consult WEG.

11. Start the motor according to section 7 of this manual;
12. Keep the motor rotating at rated speed and write down the bearing temperatures at 1-minute intervals until they become constant. Any sudden or continuous increase in the bearing temperature indicates lubrication or friction surface abnormality;
13. Monitor the temperature, oil level of the bearings and the vibration levels. If there is a significant variation of any value, interrupt the motor start process, identify possible causes and make the necessary correction;
14. When the bearing temperatures stabilize, it is possible to start the motor with load and operate it normally.



ATTENTION

The noncompliance with the procedures described in section 6.2 may impair the motor performance, cause damages and even lead to its burnout, voiding the warranty.

6.3 OPERATION

6.3.1 Operation procedures

After a first successful starting test with no load, couple the motor to the driven load and then perform the starting and operation as follows:

1. Turn off the space heater;
2. Set the protections in the control panel;
3. Switch on the hydraulic unit (if any);
4. Switch on the oil circulation system of the bearings (if any); Check the level, flow and pressure of the oil, making sure that they comply with the data on the nameplate;
5. The pressure or flow return signal of the oil circulation system in the bearings must be confirmed, making sure that the oil has reached the bearings;
6. Start the industrial water cooling system, checking the required flow and pressure (motors with air-water heat exchanger);
7. Turn on the fans (motors with forced ventilation);
8. Switch on the high-pressure oil injection system (if any), keeping it on as informed in the motor technical documentation, until the bearings can get the lubrication by self-pumping;
9. Run the motor coupled to the load until its temperature stabilizes and check for unusual noises, abnormal vibrations or excessive heating. If significant vibration variations occur in the set after the temperature stabilizes, it is necessary to check the alignment and the leveling;
10. Measure and compare the consumed electric current to the value indicated on the nameplate. In continuous duty, without load oscillation, the value of the current measured must not exceed the value indicated on the motor nameplate multiplied by the service factor;



ATTENTION

All the control and measurement instruments must be monitored permanently so that occasional changes will be detected immediately and their causes solved before proceeding with the operation.

6.3.2 Resynchronization

If the motor loses synchronism, the excitation circuit will present a field current above the normal value of the motor, supplied by the excitation panel before this operating condition.

To put the motor back to synchronism, it is necessary to disconnect the field power supply for a period of two to three seconds after the synchronism loss.

If the motor control system is adjusted for resynchronization after the loss of synchronism, the following criteria must be observed:

1. Disconnect the field supply for at least two seconds in order to allow the motor induced field current to activate the discharge circuit and/or the insertion of the discharge resistor and, thus, reduce the transient torques during resynchronization.
2. The resynchronization time must not exceed the motor normal start sequence time.
3. Normally, the removal of the excitation is necessary for a successful resynchronization;
4. The motor control panel must distinguish start failure from loss of synchronism, so that an attempt of resynchronization will not occur immediately after a start failure.
5. The quantity and the duration of resynchronization attempts must be limited according to each motor project.

6.3.3 Data recording

The following data must be collected and recorded periodically during the motor operation:

- Temperature of the bearings;
- Oil level of the bearings;
- Stator winding temperature;
- Air inlet and outlet temperatures;
- Vibration level;
- Field and stator voltage and current.

At the beginning of operation, the values must be checked every fifteen minutes. After some hours of operation, check these values every hour. After some time, these intervals may be progressively increased, but those values must be recorded daily for a period of five to six weeks.

6.3.4 Temperatures

- The temperature of the bearings, stator winding and ventilation air (if any) must be monitored while the motor is operating.
- The temperature of the bearings and stator winding stabilize in a period between four to eight hours of operation;
- The stator winding temperature depends on the motor load condition. Therefore, its operation data (voltages, currents, frequency) must be monitored during the motor operation.

6.3.5 Bearings

The system start, as well as the first hours of operation, must be monitored carefully.

Before putting the motor operation, verify:

- If the high-pressure oil injection system (if any) is ON;
 - If the external lubrication system (if any) is ON;
 - If the used lubricant complies with all specifications;
 - The lubricant characteristics;
 - The oil level (oil-lubricated bearings);
 - If the bearing alarm and trip temperatures are set;
- During the first starting, it is important to pay attention to abnormal vibrations or noises. If the bearing is not running silently and smoothly, the motor must be shut down immediately.

In case of overheating, the motor must be shut down immediately, bearings and temperature sensors must be inspected and the causes corrected;

The motor must operate for several hours until bearing temperatures stabilize within the specified limits; After the bearing temperatures stabilize, check if there are no leaks through the plugs, gaskets or shaft end.

6.3.5.1 High-pressure oil injection system

In bearings which have the option of shaft lifting when starting or stopping by means of oil pressure, the activation of this system is done by means of an external oil pump, and the following procedure must be observed:



ATTENTION

The high-pressure oil injection system must be switched on before putting the motor into operation and during the shutdown procedure, as informed in the motor technical documentation.

6.3.6 Radiators

During the operation of motors with air-water heat exchanger, it is necessary:

- Control the temperature at the radiator inlet and outlet and, if necessary, correct the water flow;
- Adjust the water pressure just to overcome the resistance in the pipes and in the radiator;
- In order to control the motor operation, it is recommended to install thermometers at the radiator air and water inlet and outlet, recording these temperatures at certain intervals;
- When installing the thermometers, recording or signaling instruments (siren, lights) can also be installed in certain places.

Verification of the radiator performance

- For operation control purposes, it is recommended that water and air temperatures at the radiator inlets and outlets be measured and recorded periodically;
- The radiator performance is expressed by the temperatures difference between cold water and cold air during normal operation. This difference must be checked periodically. If an increase in this difference is observed after a long period of normal operation, verify the need for radiator cleaning.
- The accumulation of air inside the radiator can lead to a performance reduction or to its damage. In this case, a deaeration of the radiator and the pipes may solve the problem;
- The water pressure differential can be considered an indicator of the need for cleaning the radiator.
- It is also recommended to measure and record the difference between the water pressure before and after the radiator. Periodically, the newly measured values must be compared to the original value, and an increase of the pressure differential indicates the need for cleaning the radiator.

6.3.7 Vibration

Permissible vibration levels must be obtained directly from the standard regarding the motor.

Table 6.1: Standards to evaluate the vibration in coupled motors

Application	Measurement in non-rotating parts	Measurement in rotating parts
Motor (reciprocating and rotary screw compressor)	ISO 10816-1	ISO 7919-1
Motor (centrifugal compressor)	ISO 10816-3	ISO 7919-3
Motor (pump)	ISO 10816-5	ISO 7919-5

6.3.8 Vibration causes

Common causes of vibration are:

- Misalignment between the motor and driving equipment;
- Improper fastening of the motor to the base, with "loose shims" under one or more of the motor feet, and loose fastening bolts;
- Improper or insufficiently rigid base;
- External vibrations from other equipment.



ATTENTION

Operating the motor with vibration levels above the values provided in the standard may impair its useful life and/or performance.

6.4 SHUTDOWN

In order to stop the motor, proceed as follows:

- Switch off the excitation;
- Open the main stator circuit breaker;
- Switch off the voltage regulator;
- Turn on the high-pressure oil injection system (if any) when the motor reaches the speed specified in the technical documentation;
- Apply the brakes (if any) as informed in the motor technical documentation;

After the motor stops completely:

- Switch off the high-pressure oil injection system (if any);
- Switch off the oil circulation system of the bearings (if any);
- Switch off the hydraulic unit (if any);
- Shut down the industrial water system (if any);
- Switch off the forced ventilation system (if any);
- Switch on the space heaters. They must be kept ON until the next motor operation.



DANGER

Even after switching off the motor, while the rotor is rotating, there is danger to life by touching any of the motor active parts.



ATTENTION

Motor terminal boxes equipped with capacitors must not be opened before their full discharge.
Capacitor discharge time: five minutes after shutting down the motor.

7 MAINTENANCE

7.1 GENERAL

A proper maintenance program includes the following recommendations:

- Keep clean the motor and associated equipment;
- Measure the winding insulation resistance periodically;
- Measure the temperature of windings, bearings and cooling system periodically ;
- Check the wear, operation of the lubrication system and useful life of the bearings;
- Measure the motor vibration levels;
- Inspect the cooling system;
- Inspect associated equipment;
- Check all the motor accessories, protections and connections, ensuring that they are operating properly.



ATTENTION

Noncompliance with the recommendations of section 7.1 may cause undesired stoppages of the equipment.

The frequency of such inspections depends on local application conditions.

Every time that it becomes necessary to transport the motor, the shaft must be properly locked to prevent damages to the bearings. Use the device supplied with the motor to lock the shaft.

If the motor requires reconditioning or replacement of any damaged part, consult WEG.

7.2 GENERAL CLEANING

- Keep the frame clean, without external accumulation of oil or dust, in order to facilitate the heat exchange with the environment;
- The inside of the motor must also be kept clean, and free from dust, debris and oils;
- For cleaning, use brushes or clean cotton cloths. If the dust is not abrasive, the cleaning must be done with an industrial vacuum cleaner, "aspiring" the dirt from the fan cover and the dust accumulated on the fan blades and on the frame;
- The grounding brush compartment (if any) must be kept clean, without dust accumulation;
- Debris impregnated with oil or moisture can be removed with a cloth soaked in appropriate solvents;
- Clean the terminal boxes when necessary. Terminals and connectors must be kept clean, free of rust and in perfect operating conditions. Avoid the presence of grease or verdigris in the connection parts.

7.3 WINDING INSPECTIONS

Yearly, the windings must be submitted to a complete visual inspection, recording and repairing all and every damage or defect observed.

The winding insulation resistance measurements must be done at regular intervals, especially during humid weather and after prolonged motor stoppages.

Low values or sudden variations in the insulation resistance must be investigated.

The windings must be submitted to complete visual inspections at frequent intervals, recording and repairing all and every damage or defect observed.

The winding insulation resistance may be increased up to a proper value in points where it is low (due to excessive dust and moisture) by means of dust removal and by drying the winding moisture.

7.4 WINDING CLEANING

In order to obtain a more satisfactory operation and a longer useful life of the insulated windings, it is recommended to keep them free of dirt, oil, metal dust, contaminants, etc.

Therefore, it is necessary to inspect and clean the windings periodically, according to the recommendations of the "Maintenance Plan" of this manual. If reimpregnation is necessary, consult WEG.

The windings may be cleaned with an industrial vacuum cleaner with a non-metallic crevice tool or just a dry cloth. For extreme dirt conditions, it may be necessary to use a proper liquid solvent for cleaning. This cleaning must be quick to prevent prolonged exposure of the windings to the solvent effects.

After being cleaned with solvents, the windings must be completely dried.

Measure the insulation resistance and the polarization index in order to assess the winding insulation conditions. Winding drying time after cleaning varies depending on the weather conditions such as temperature, humidity, etc.



DANGER

Most solvents currently used are highly toxic and/or flammable.

Solvents must not be used in the straight parts of the coils of high-voltage motors, because they may affect the protection against corona effect.

7.4.1 Inspections

The following inspections must be carried out after the windings are carefully cleaned:

- Check the insulations of the windings and connections.
- Check if spacers, bindings, slot wedges, bandages and supports are properly fixed;
- Check for breaks, faulty welds, short-circuit between turns and against the frame in the coils and connections. In case any fault is detected, consult WEG.
- Ensure that all cables are properly connected and that terminal fixation components are duly tightened. Retighten, if necessary.

7.4.2 Re-impregnation

If any layer of resin on the windings is damaged during cleaning or inspection, such parts must be corrected with adequate material (in this case, consult WEG).

7.4.3 Insulation resistance

The insulation resistance must be measured after the completion of all of the maintenance procedures.



ATTENTION

Before putting the motor back into operation, it is essential to measure the winding insulation resistance and ensure that the measured values meet the specifications.

7.5 COOLING SYSTEM MAINTENANCE

- The pipes of the air-air heat exchanger (if any) must be kept clean and unobstructed to ensure a perfect heat exchange. In order to remove the dirt accumulated in the pipes, a rod with a round brush on the tip may be used.
- In case of air-water heat exchangers, periodic cleaning in the radiator pipes is necessary to remove all and any incrustation.



NOTE

If the motor has filters in the air inlets and/or outlets, they must be cleaned with compressed air. If the dust is difficult to remove, wash the filters with cold water and neutral detergent and dry them in the horizontal position; In case the filters are impregnated with dust containing grease, it is necessary to wash them with gasoline, kerosene or another petroleum solvent or hot water with P3 additive; All the filters must be dried after the cleaning. Do not twist them; Replace the filter if necessary.

7.6 RADIATOR MAINTENANCE

The degree of dirt in the radiator can be detected by the increase of the temperature at the air outlet. When the temperature of the cold air, under the same operating conditions, exceeds the specified value, it can be assumed that the pipes are dirty.

If corrosion is found in the radiator, it is necessary to provide adequate protection (i.e., zinc anodes, cover with plastic, epoxy or other similar products) in order to prevent further damage to the parts already affected.

The external surface of all the radiator parts must be always kept in good conditions.

Instructions for removal and maintenance of the radiator

In order to remove the radiator for maintenance, use the following procedure:

1. Close all the water inlet and outlet valves after stopping the ventilation;
2. Drain the water through the radiator drain plugs;

3. Remove the heads, keeping the bolts, nuts, washers and seals (gaskets) in a safe place;
4. Brush the inside of the pipes carefully with nylon brushes in order to remove residues. If damages to the radiator tubes are found during the cleaning, they must be repaired;
5. Reassemble the heads, replacing the gaskets, if necessary.

7.7 VIBRATION

Any evidence of increase in the unbalance or vibration of the motor must be investigated immediately.

7.8 SHAFT GROUNDING DEVICE

The shaft grounding brush (if any) avoids the circulation of electric current through the bearings, which is detrimental to their operation. The brush is put in contact with the shaft and connected by a cable to the motor frame, which must be grounded. Make sure that the brush holder fastening and its connection to the frame have been made correctly.

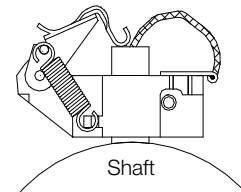

Figure 7.1: Shaft grounding brush

Drying oil is used to protect the motor shaft against rust during transportation. In order to ensure the proper operation of the grounding brush, this oil, as well as any residue between the shaft and the brush, must be removed before starting the motor. The brush must be constantly monitored during operation, and it must be replaced by another one of the same quality (granulation) at the end of its useful life.

7.9 EXCITER MAINTENANCE

7.9.1 Exciter

For the good performance of its components, the motor exciter compartment must be kept clean. Perform periodic cleaning in the windings following the procedures described in section 7.2 of this manual.

7.9.2 Insulation resistance

Check the insulation resistance of the main and auxiliary exciter windings periodically in order to determine their insulation conditions, following the procedures described in section 4.4.4 of this manual.

7.9.3 Diode test

Diodes are components that have great durability and do not require frequent tests. If the motor presents any defect indicating diode failure through the voltage regulator or an increase in the field current for the same load condition, then the diodes must be tested according to the following procedure:

 **NOTE**
When testing the diodes, observe the polarity of the test terminals regarding the diode polarity.

- Loosen the flexible cables of the 6 diodes;
 - With an ohmmeter, measure the resistance of each diode in both directions.
- The diode is considered good when it presents low resistance (up to $\pm 100\Omega$) in its direct direction and high resistance (approximately $1\text{ M}\Omega$) in the reverse direction. Defective diodes will have a resistance of $0\ \Omega$ or greater than $1\text{ M}\Omega$ in both directions. In most cases, the test method which uses an ohmmeter is sufficient to identify faults in the diodes. However, in some extreme cases it may be necessary to apply the blocking rated voltage and/or current circulation in order to detect fault in the diodes. Because of all the effort required to perform these tests, in case of doubt, it is recommended replace the diodes.

7.9.3.1 Diode Replacement

- To replace any of the diodes, proceed according to the following directions:
- Replace the damaged diodes by new diodes identical to the original ones, observing the position of each anode diode and each cathode diode;
 - The diodes are already supplied with insulated braided cable and connection terminal;
 - Clean the heatsink disk completely around the diode-mounting hole.
 - Check if the diode thread is clean and free of burs;
 - Apply thermal compound on the contacts;
 - Install the diode in its correct position using a torque wrench, observing the torques recommended in Table 7.1.

Table 7.1: Diode tightening torque

Thread of the diode base (mm)	Torque wrench head (mm)	Tightening torque (Nm)
M12	24	10
M16	32	30
M24	41	60

 **ATTENTION**
It is of fundamental importance that the torque be respected in order to prevent damages to the diodes during the assembly.

7. After fastening the diodes, connect their ropes.

 **NOTE**
The polarity of the diode is indicated by an arrow on its housing. When replacing the diodes, make sure they are installed in each part of the heatsink disk with the correct polarity.

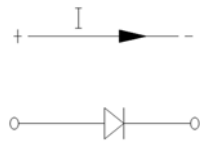

The current conduction must occur only in the anode-cathode direction, i.e. in the condition of direct polarization.

7.9.4 Thyristor test

Disconnect the thyristors to be tested from the circuit by disconnecting the rope, the gate terminals and the cathode. The thyristor in good conditions presents high resistance in both directions. When defective, normally the reading is close to zero in both directions. The thyristor gate circuit must present low resistance (25 – 100 ohms) in both directions.

 **ATTENTION**
Applying more than 10 V to the thyristor gate may damage the triggering circuit and result in damages to the motor.

In most cases, the test with the ohmmeter is sufficient to identify failures in the thyristors. The comparison of readings from more than one reliable instrument is convenient.

7.9.4.1 Thyristor replacement

- With braided cable:**
In order to replace any of the thyristors, proceed according to the following directions:
- Replace the damaged thyristors by new thyristors identical to the original ones, respecting the position of each anode thyristor and cathode thyristor;
 - The thyristors are already supplied with insulated cooper rope and connection terminal;
 - Clean the heatsink disk completely around the thyristor mounting hole.
 - Check if the thyristor thread is clean and free of burs;
 - Apply thermal compound on the contacts;
 - Install the thyristor in its correct position using a torque wrench, observing the torques recommended in Table 7.2
 - After fastening the thyristors, connect their ropes.

- Disk thyristor:**
In order to replace any of the thyristors, proceed according to the following directions:
- Replace the damaged thyristors by new thyristors identical to the original ones, respecting the position of each thyristor and the correct anode and cathode positions;
 - Clean the heatsink completely on the contact areas;
 - Apply thermal compound on the contacts;
 - The thyristor must be mounted on the support and the wires of the gate terminal must be welded and insulated with heat shrink tubing;
 - Apply a tightening torque of 10Nm.

Table 7.2: Thyristor tightening torque

Thread of the thyristor base (mm)	Torque wrench head (mm)	Tightening torque (Nm)
M12	24	10
M16	32	30
M24	41	60



ATTENTION

It is of fundamental importance that the tightening torque be respected in order to prevent damages to the thyristors during the assembly.



NOTE

The polarity of the thyristor is indicated by an arrow on its housing. When replacing the thyristors, make sure they are installed in each part of the heatsink disk with the correct polarity.

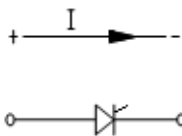

The current conduction must occur only in the anode-cathode direction, i.e. in the condition of direct polarization.

7.10 BEARING MAINTENANCE

7.10.1 Grease-lubricated rolling bearings

7.10.1.1 Lubrication instructions

The lubrication system was designed in such a way that during the lubrication of the rolling bearings, all the old grease is removed from the rolling bearing races and expelled through a drain which enables the exit of the grease, but prevents the ingress of dust or other harmful contaminants.

This drain also prevents damage to the rolling bearings by the known problem of excessive lubrication.

It is recommended to make the lubrication with the motor in operation in order to ensure the renewal of the grease in the rolling bearing housing.

If that is not possible due to the presence of rotating parts near the grease nipple (pulleys, etc.) which may put the operator at risk, follow the procedures below:

- With the motor stopped, inject approximately half of the total intended amount of grease and operate the motor for approximately one minute at rated speed;
- Stop the motor and inject the rest of the grease.



ATTENTION

The injection of all the grease with the motor stopped may lead to the penetration of part of the lubricant into the motor through the internal seal of the rolling bearing cap. It is important to clean the grease nipples prior to lubrication in order to prevent foreign materials from being dragged into the rolling bearing. For lubrication, use only manual grease gun.



NOTE

The rolling bearing data, amount and type of grease and lubrication intervals are informed on a bearing nameplate affixed to the motor. Check this information before performing the lubrication.

- The lubrication intervals informed on the nameplate consider a 70 °C working temperature of the rolling bearing;
- Based on the operating temperature ranges listed in Table 7.3, apply the following correction factors for the rolling bearing lubrication intervals:

Table 7.3: Reduction factor for lubrication intervals

Bearing operating temperature	Reduction factor
Below 60 °C	1.59
Between 70 and 80 °C	0.63
Between 80 and 90 °C	0.40
Between 90 and 100 °C	0.25
Between 100 and 110 °C	0.16

7.10.1.2 Procedures for rolling bearing relubrication

1. Remove the drain cover;
2. Clean with a cotton cloth around the hole of the grease nipple;
3. With the rotor operating, inject the grease with a manual grease gun until grease starts coming out from the drain or until the proper amount of grease has been injected.
4. Keep the motor running long enough so that the grease excess passes through the drain;
5. Inspect the bearing temperature to make sure there was no significant change;
6. Put the drain plug back in place.

7.10.1.3 Rolling bearing relubrication with drawer device for grease removal

In order to relubricate the bearings, the old grease is removed by means of the device with a drawer installed on each bearing.

Lubrication procedure:

1. Before starting the lubrication of the bearing, clean the grease nipple with a cotton cloth;
2. Remove the rod with drawer to remove the old grease, clean the drawer and put it back in place;
3. With the motor running, inject the amount of grease specified on the rolling bearing nameplate by means of a manual grease gun;
4. The excess of grease comes out through the bearing lower drain and is deposited in the drawer;
5. Keep the motor running long enough for the grease excess to drain;
6. Remove the excess of grease, by pulling the drawer rod and cleaning the drawer. This procedure must be repeated as many times as necessary until the drawer no longer retains grease;
7. Inspect the bearing temperature to ensure that there was no significant change.

7.10.1.4 Type and amount of grease

The relubrication of the bearings must always be done with the original grease, specified on the bearing nameplate and in the documentation of the motor.



ATTENTION
WEG does not recommend the use of greases different from the original one.

It is important to perform a correct lubrication, i.e. to apply the correct grease and in the proper quantity, because either poor or excessive lubrication will damage the rolling bearings.

Excessive amount of grease cause temperature increase, due to the great resistance it offers to the movement of the bearing rotating parts. Consequently, due to the heating, the grease can completely lose its lubricating characteristics.

7.10.1.5 Grease compatibility

You can say that greases are compatible when the properties of the mixture lie within the property ranges of the greases individually.

In general, greases with the same type of soap are compatible; however, depending on the proportion of the mixture, there might be incompatibility. Therefore, it is not recommended to mix different types of grease without consulting the grease supplier or WEG.

Some thickeners and basic oils cannot be mixed, because they do not form a homogeneous mixture. In this case, one cannot rule the possibility of hardening or softening of the grease, or reduction of the dropping point of the resulting mixture.



ATTENTION
Greases with different types of base must never be mixed.
For example: Lithium-based greases must never be mixed with sodium or calcium-based greases.

7.10.1.6 Bearing disassembly

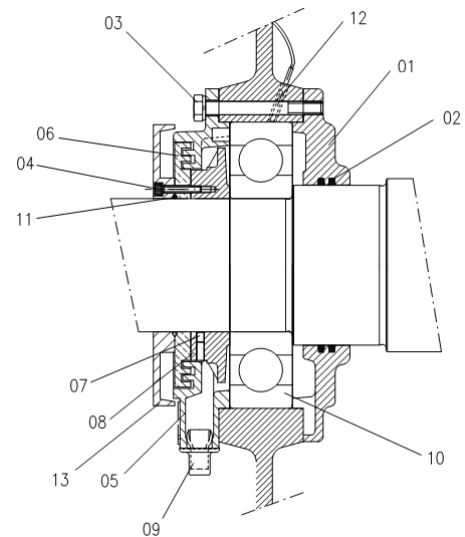

Figure 7.2: Parts of the grease-lubricated rolling bearing

Figure 7.2 legend:

1. Inner bearing cap
2. White felt
3. Bearing cap fastening screw
4. Disc fastening screw
5. Outer bearing cap
6. Labyrinth taconite seal
7. Grease flinger fastening screw
8. Grease flinger
9. Grease collecting drawer
10. Rolling bearing
11. Grease nipple
12. Thermal protector
13. External closing disc

Before disassembling:

- Remove the extension tubes from the grease inlet and outlet;
- Thoroughly clean the external part of the bearing;
- Remove the grounding brush (if any);
- Remove the temperature sensors from the bearing

Disassembly

In order to disassemble the bearing, proceed according to the directions below:

1. Remove the screws (4) that fix the closing disc (13);
2. Remove the Labyrinth taconite seal (6);
3. Remove the screws (3) from the bearing caps (1 and 5);
4. Remove the outer bearing cap (5);
5. Remove the screw (7) that fixes the grease flinger (8);
6. Remove the grease flinger (8);
7. Remove the D-end shield;
8. Remove the rolling bearing (10);
9. Remove the inner bearing cap (1), if necessary.



ATTENTION
▪ During the bearing disassembly, it is necessary to be careful not to damage the balls, rollers or shaft surface;
▪ Keep the disassembled parts in a safe and clean place.

7.10.1.7 Bearing assembly

- Clean the bearings completely and inspect the disassembled parts and the inside of the bearing caps;
- Make sure the rolling bearing, shaft and bearing cap surfaces are perfectly smooth;
- Fill up to ¾ of the inner and outer bearing cap deposits with the recommended grease (Figure 7.3) and lubricate the rolling bearing with enough grease before assembling it;
- Before assembling the rolling bearing on the shaft, heat it up to a temperature between 50 °C and 100 °C;
- For the complete assembly of the bearing, follow the disassembly instructions in the reverse order.

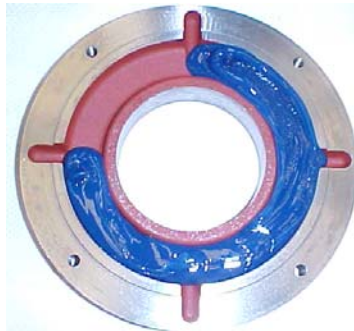

Figure 7.3: Outer bearing cap



ATTENTION

When the bearing is opened, inject the new grease through the grease nipple to expel the old grease found in the grease inlet tube, and apply the new grease in the rolling bearing, to the inner and outer rings, filling ¾ of the empty spaces, as shown in Figure 7.3. In case of double bearings (ball bearing + roller bearing), also fill ¾ of the empty spaces between the intermediate rings;
Never clean the rolling bearing with cotton-based cloths, because they leave some lint, working as solid particles.



NOTE

WEG is not liable for the change of grease or for any damages arising from this change.

7.10.2 Oil-lubricated rolling bearing

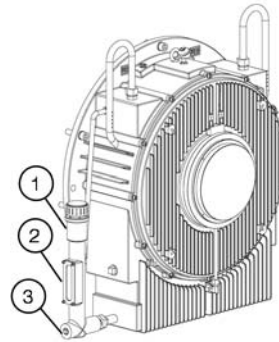

Figure 7.4: Oil-lubricated rolling bearing

Figure 7.4 legend:

1. Oil inlet
2. Oil sight glass
3. Oil outlet

7.10.2.1 Lubrication instructions

Oil drainage: When it is necessary to change the bearing oil, remove the oil outlet plug (3) and drain the oil completely.

To fill the bearing with oil:

- Close the oil outlet with the plug (3);
- Remove the oil inlet plug (1);
- Fill it with the specified oil up to the level indicated in the oil sight glass.



NOTES

1. All threaded holes that are not used must be closed with plugs and no fitting may present leaks;
2. The oil level is reached when the lubricant can be seen approximately in the middle of the sight glass;
3. The use of excessive amount of oil will not damage the bearing; but it can cause leaks through the shaft seals;
4. Never use hydraulic oil or mix it with the bearing lubricant oil.

7.10.2.2 Oil type

The type and quantity of the **lubricant oil** to be used are specified on the nameplate affixed to the motor.

7.10.2.3 Oil change

The bearing oil change must be done according to the intervals, which depend on the bearing operating temperatures, shown in Table 7.4:

Table 7.4: Oil change intervals

Bearing operating temperature	Bearing oil change intervals
Below 75 °C	20,000 hours
Between 75 and 80 °C	16,000 hours
Between 80 and 85 °C	12,000 hours
Between 85 and 90 °C	8,000 hours
Between 90 and 95 °C	6,000 hours
Between 95 and 100 °C	4,000 hours

The lifespan of the bearings depends on their operating conditions, on the motor operating conditions and on the maintenance procedures.

Proceed according to the following directions:

- The oil selected for the application must have the proper viscosity for the bearing operating temperature. The type of oil recommended by WEG already considers these criteria;
- Insufficient quantity of oil may damage the bearing;
- The minimum recommended oil level is reached when the lubricant can be seen in the lower part of the oil sight glass with the motor stopped.



ATTENTION

The oil level must be inspected daily and must remain in the middle of the oil sight glass.

7.10.2.4 Bearing operation

The system start, as well as the first hours of operation, must be monitored carefully.

Before starting, check:

- If the oil used complies with the specification on the nameplate;
 - The lubricant characteristics;
 - The oil level;
 - The alarm and trip temperatures set for the bearing.
- During the first start, it is necessary to stay alert for unusual vibrations or noises. If the bearing does not operate in a silently and smooth way, the motor must be shut down immediately.

The motor must operate for some hours until the bearing temperatures stabilize. In case of overheating of the bearings, the motor must be shut down for inspection of the bearings and temperature sensors.

Check if there is no oil leak through the plugs, gaskets or shaft end.

7.10.2.5 Bearing disassembly

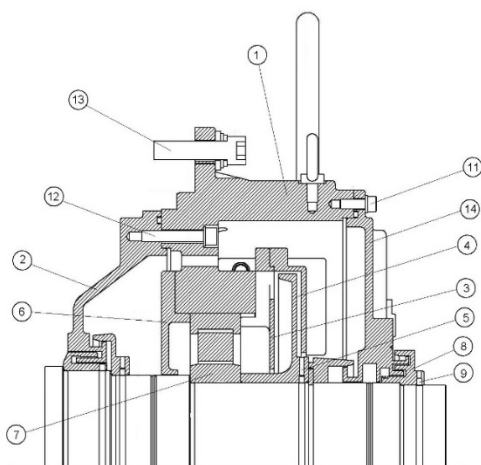

Figure 7.5: Parts of the oil-lubricated rolling bearing

Figure 7.5 Legend:

1. Outer oil tank
2. Inner oil tank
3. Outer bearing cap
4. Oil flinger
5. Screw
6. Inner bearing cap
7. Rolling bearing
8. Labyrinth taconite seal
9. Screw
10. Breather
11. Outer tank fastening screw

12. Inner tank fastening screw
13. End shield fastening screw
14. Bearing protection cover

Before disassembling:

- Clean the whole bearing externally;
- Remove the oil completely from the bearing;
- Remove the temperature sensor from the bearing;
- Remove the grounding brush (if any);
- Provide a support for the shaft in order to hold the rotor during the disassembly.

Disassembly:

In order to disassemble the bearing, proceed according to the following guidelines:

1. Remove the screw (9) that fastens the labyrinth taconite seal (8);
2. Remove the labyrinth taconite seal (8);
3. Remove the screws (11) that fasten the bearing protection cover (14);
4. Remove the protection cover (14);
5. Remove the screws (5) that fasten the oil flinger (4) and remove it;
6. Remove the bolts that fix the external bearing cap (3) and remove it;
7. Remove the screws (12 and 13);
8. Remove the outer oil tank (1);
9. Remove the rolling bearing (7);
10. If complete disassembly of the bearing is necessary, remove the inner bearing cap (6) and the inner oil tank (2).



ATTENTION

- During the bearing disassembly, it is necessary to be careful not to damage the balls, rollers or shaft surface;
- Keep the disassembled parts in a safe and clean place.

7.10.2.6 Bearing assembly

- Clean the rolling bearing and the oil tanks thoroughly, and inspect all the parts before the bearing assembly.
- Make sure the rolling bearing contact surfaces are smooth and free of signs of scratches or corrosion;
- Before inserting the rolling bearing onto the shaft, heat it up to a temperature between 50 to 100 °C;
- For the complete assembly of the bearing, follow the disassembly instructions in the reverse order.



ATTENTION

During the bearing assembly, apply sealant (e.g. Curil T) in order to seal the surfaces of the oil tank.

7.10.3 Sleeve bearings

7.10.3.1 Bearing data

The characteristic data, such as oil flow, quantity and type, are indicated on the bearing nameplate and must be strictly observed; otherwise, overheating and damages to the bearings may occur.

The hydraulic installation (for bearings with forced lubrication) and oil the supply for the motor bearings are responsibilities of the user.

7.10.3.2 Bearing installation and operation

For information on the bill of materials, assembly and disassembly instructions, and maintenance details, refer to the specific installation and operation manual of the bearings.

7.10.3.3 Cooling by water circulation

The sleeve bearings with cooling by water circulation have a serpentine inside the oil tank through which the water circulates.

In order to assure an efficient bearing cooling, the circulating water must have at the bearing inlet a temperature below or equal to the ambient, so that the cooling takes place.

The water pressure must be 0.1 bar and the flow equal to 0.7 l/s. The pH must be neutral.



NOTE

Under no circumstances can water leak into the oil tank, because this will contaminate the lubricant.

7.10.3.4 Oil change

Self-lubricated bearings:

The bearing oil change must be done according to the intervals, which depend on the bearing operating temperatures, shown in Table 7.5:

Table 7.5: Oil change intervals

Bearing operating temperature	Bearing oil change intervals
Below 75 °C	20,000 hours
Between 75 and 80 °C	16,000 hours
Between 80 and 85 °C	12,000 hours
Between 85 and 90 °C	8,000 hours
Between 90 and 95 °C	6,000 hours
Between 95 and 100 °C	4,000 hours

Bearings with (external) oil circulation:

The oil of the bearings must be changed every 20,000 hours of operation or whenever the lubricant presents modifications in its characteristics. The oil viscosity and pH must be checked regularly.



NOTE

The oil level must be inspected daily, and it must remain in the middle of the oil sight glass.

The bearings must be lubricated with the specified oil, observing the flow rate informed on their nameplate; All threaded holes that are not used must be closed with plugs and no fitting may present leaks.

The oil level is reached when the lubricant can be seen approximately in the middle of the sight glass. The use of a larger amount of oil will not damage the bearing; but it can cause leaks through the shaft seals.



ATTENTION

The care with the lubrication will determine the useful life of the bearings and the safety in the motor operation. Therefore, the following recommendations must be observed:

- The selected **lubricant oil** must be the one with proper viscosity for the operating temperature of the bearings. That must be observed at every oil change or periodical maintenances;
- Never use or mix hydraulic oil with the lubricant oil of the bearings;
- Lack of lubricant, due to incomplete filling or non-monitoring of the level, can damage the bearing shells;
- The minimum oil level is reached when the lubricant can be seen in the lower part of the sight glass with the motor stopped.

7.10.3.5 Sealings

Make visual inspection of the sealings, making sure that the dragging marks of the seals on the shaft do not compromise its integrity and checking for cracks and broken parts. Cracked or broken parts must be replaced. In case of bearing maintenance, in order to assemble the seal, it is necessary to carefully clean the seal contact surfaces and its enclosure, and cover the sealing with a non-hardening component (e.g.: Curil T). The two halves of the labyrinth taconite seal must be joined by a garter spring.

The drain holes located in the lower half of the seal must be cleaned and unobstructed.

Improper installation can damage the sealing and cause oil leakage.



ATTENTION

For further information on the disassembly and assembly of sleeve bearing seals, refer to the specific manual of this equipment.

7.10.3.6 Sleeve bearing operation

The system start, as well as the first hours of operation, must be monitored carefully.

Before starting, check:

- If the oil inlet and outlet tubes (if any) are clean. Clean the tubes by pickling, if necessary;
- If the used oil complies with the specification on the nameplate;
- The lubricant characteristics;
- The oil level;
- The alarm and trip temperatures set for the bearing.

During the first start, it is necessary to stay alert for unusual vibrations or noises. If the bearing is not running silently and smoothly, the motor must be shut down immediately.

The motor must operate for several hours until the bearing temperatures stabilize. In case of overheating of the bearings, the motor must be shut down for inspection of the bearings and temperature sensors.

Check if there is no oil leak through the plugs, gaskets or shaft end.

7.10.3.7 Sleeve bearing maintenance

The sleeve bearing maintenance includes:

- Periodic checking of the oil level and its lubricating conditions;
- Checking the bearing noise and vibration levels;
- Monitoring of the operating temperatures and retightening of the fastening and assembly screws;
- In order to facilitate the heat exchange with the environment, the frame must be kept clean, without external oil or dust accumulation;
- The NDE bearing is electrically insulated. The spherical seat surfaces of the bearing shell on the frame are covered with insulating material. Never remove this cover;
- The anti-rotation pin is also insulated, and the seals are made of non-conducting material;

Temperature control devices that are in contact with the bearing shell must also be properly insulated.

7.10.4 Protection setting



ATTENTION

The following temperatures must be set on the bearing protection system:

ALARM: 110 °C

TRIP: 120 °C

The alarm temperature must be set for 10 °C above the operating temperature, not exceeding the limit of 110 °C.

7.10.5 Disassembly/assembly of the bearing temperature sensors

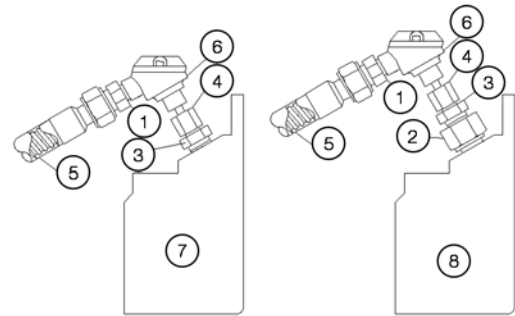

Figure 7.6: Pt100 on the bearings

Figure 7.6 legend:

1. Reduction nipple
2. Insulating adapter
3. Locknut
4. Bulb
5. Flexible metal tube
6. Pt-100 temperature sensor
7. Non-insulated bearing
8. Insulated bearing

Disassembly instructions:

If it is necessary to remove the Pt100 for bearing maintenance, proceed according to the following instructions:

- Remove the Pt100 carefully, locking the locknut (3) and unscrewing just the Pt100 from the bulb (4);
- Parts (2) and (3) must not be disassembled.

Assembly instructions:



ATTENTION

Before assembling the Pt100 on the bearing, check if it does not contain marks of knock or any other damage that may compromise its operation.

- Insert the Pt100 into the bearing;
- Restrain the locknut (3) with a wrench;
- Screw the bulb (4), adjusting it so that the tip of the Pt100 touches the contact surface of the bearing.



NOTES

- The assembly of the Pt100 on non-insulated bearings must be done directly on the bearing, without the insulating adapter (2);
- The tightening torque to assemble the Pt100 and the adapters must not exceed 10 Nm.

8 MOTOR DISASSEMBLY AND ASSEMBLY



ATTENTION

All the repair, disassembly and assembly services must be performed only by properly qualified and trained professionals; otherwise, equipment damage and personal injury may occur. If any further explanations are necessary, consult WEG.

The disassembly and assembly sequence depend on the motor model.

Always use proper tools and devices. Any damaged part (cracks, dents on machined parts, faulty threads) must be replaced, avoiding restorations.

8.1 DISASSEMBLY

The following precautions must be taken when disassembling the electric motor:

1. Always use proper tools and devices to disassemble the motor;
2. Before disassembling the motor, disconnect the cooling water and lubrication pipes (if any);
3. Disconnect the motor electrical connections and those of the accessories;
4. Remove the heat exchanger and the noise suppressor (if any);
5. Remove the bearing temperature sensors and the grounding brush;
6. In order to prevent damages to the rotor and coil heads, support the shaft on both drive and non-drive ends;
7. In order to disassemble the bearings, follow the procedures described in this manual;
8. The removal of the rotor from the motor must be done with a suitable device and with extreme care so that the rotor does not drag on the stator laminated core or coil heads, thus preventing damages.

8.2 ASSEMBLY

To assemble the motor, follow the disassembly procedure in the reverse order.



NOTE

When the motor is supplied disassembled, an assembly manual is provided with it, describing the procedures for assembly on site.

Always use proper tools and devices to assemble the motor;

Any damaged part (cracks, dents on machined parts, faulty threads) must be replaced, always avoiding restorations.

8.3 TIGHTENING TORQUE

Table 8.1 and Table 8.2 shows the tightening torques of the screws recommended for assembling the motor.

Table 8.1: Screw tightening torque for metal/metal parts

Material / Resistance class		Carbon Steel / 8.8 or above		Stainless steel / A2 – 70 or above	
% Yield Strength		60%		70%	
Lubricant		Dry	Molycote 1000	Dry	Molycote 1000
Diam	Pitch (mm)	Screws tightening torque (Nm)			
M3	0,5	1,2	0,8	1	0,69
M4	0,7	2,7	1,8	2,4	1,6
M5	0,8	5,4	3,6	4,8	3,2
M6	1	9,3	6,3	8,2	5,5
M8	1,25	22,4	15	20	13
M10	1,5	44	30	39	26
M12	1,75	77	52	67	45
M14	2	123	82	107	72
M16	2	188	126	165	110
M18	2,5	263	176	230	154
M20	2,5	368	246	322	215
M22	2,5	500	332	437	290
M24	3	637	425	557	372
M27	3	926	615	810	538
M30	3,5	1260	838	1102	734
M33	3,5	1704	1130	1490	990
M36	4	2195	1459	1920	1277
M42	4,5	3507	2328	3070	2037
M48	5	5258	3488	4600	3052

Table 8.2: Screw tightening torque for metal/isolated parts

Material / Resistance class		Carbon Steel / 8.8 or above		Stainless steel / A2 – 70 or above	
% Yield Strength		33%		33%	
Lubricant		Dry	Molycote 1000	Dry	Molycote 1000
Diam	Pitch (mm)	Screws tightening torque (Nm)			
M3	0,5	0,6	0,5	0,48	0,32
M4	0,7	1,5	1	1,1	0,76
M5	0,8	3	2	2,2	1,5
M6	1	5,2	3,4	3,8	2,6
M8	1,25	12,3	8,3	9,2	6,2
M10	1,5	24	16	18,2	12,2
M12	1,75	42	28	32	21
M14	2	68	45	51	34
M16	2	104	69	78	52
M18	2,5	145	98	108	72
M20	2,5	202	135	152	101
M22	2,5	274	183	206	137
M24	3	350	233	263	175
M27	3	510	338	382	254
M30	3,5	693	461	520	346
M33	3,5	937	622	703	466
M36	4	1207	802	905	602
M42	4,5	1929	1280	1447	960
M48	5	2892	1918	2170	1440

**NOTE**

The resistance class is normally indicated on the head of hex bolts.

**ATTENTION**

The assembly of the flywheel, if any, must be done according to the motor assembly manual. If further information is necessary, consult WEG.

8.4 AIR GAP MEASUREMENT

After the motor assembly, it is necessary to measure the air gap in order to check the concentricity between rotor and stator.

Measure the air gap in all rotor poles in four equidistant points of the stator (e.g. 45°, 135°, 210° and 330°).

It is also necessary to measure the exciter and auxiliary exciter air gap. Removing the exciter inspection cover, make the measurement as it is done in the motor.

The difference between the air gap measured in two points diametrically opposed must be less than 10% of the average air gap.

8.5 SPARE PARTS

WEG recommends keeping in stock the following spare parts:

- DE and NDE rolling bearings;
- Bearing shell for DE bearing and NDE bearings (sleeve bearings);
- Labyrinth taconite seal for DE bearing and NDE bearings (sleeve bearings);
- Temperature sensor for DE and NDE bearings;
- Space heater;
- Filter felts (if any);
- Rectifier set;
- Varistor set;
- Lubricant for the bearings;
- Brake pads (if any);
- Shaft grounding brush (if any);

The spare parts must be stored in clean, dry, well ventilated environments and, if possible, at constant temperature.

9 MAINTENANCE PLAN

The maintenance plan described in Table 9.1 is only referential, and the intervals between each maintenance intervention may vary according to the motor location and operating conditions.

For associated equipment, such as the water supply unit or control and protection system, it is necessary to refer to their specific manuals.

Table 9.1: Maintenance plan

EQUIPMENT	Weekly	Monthly	3 months	6 months	Annual	3 years	Notes
STATOR							
Visual inspection of the stator.					x		
Cleanliness control.					x		
Inspection of the slot wedges.						x	
Check of the fastening of the stator terminals.					x		
Measurement of the winding insulation resistance.					x		
ROTOR							
Cleanliness control.					x		
Visual inspection.					x		
Inspection of the shaft (wear, incrustations).						x	
EXCITER							
Cleanliness control.				x			
Diode, thyristor and varistor tests.					x		
Winding inspection.					x		
Inspection of connections and operation of triggering circuit.					x		
BEARINGS							
Control of noise, vibration, oil flow, leaks and temperature.	x						
Lubricant quality control.					x		
Inspection of the bearing shell and shaft journal (sleeve bearing).						x	
Lubricant change.							According to interval indicated on the bearing nameplate.
AIR-WATER HEAT EXCHANGER							
Inspection of the radiators.					x		
Cleaning of the radiators					x		
Replacement of the gaskets of the radiator heads.					x		
AIR-AIR HEAT EXCHANGER							
Cleaning of the ventilation ducts.					x		
Inspection of the ventilation.					x		
AIR FILTER(S)							
Inspection, cleaning and replacement, if necessary.							Every 2 months.
TERMINAL BOXES AND GROUNDING TERMINALS							
Internal cleaning of the terminal boxes.					x		
Retightening of the screws.					x		
PROTECTION AND CONTROL EQUIPMENT							
Operation test.					x		
Recording of the values.	x						
Disassembly and operation test.						x	
COUPLING							
Inspection of the alignment.					x		Check after the first week of operation.
Inspection of the coupling fastening.					x		
WHOLE MOTOR							
Inspection of noise and vibration.	x						
Drainage of condensed water.			x				
Retightening of the screws.					x		
Cleaning of the terminal boxes.					x		
Retightening of electrical and grounding connections.					x		
BRAKE							
Verification of pad wearing.							According to the equipment manual.
Operating control.							

10 ABNORMALITIES, CAUSES AND SOLUTIONS



NOTE

The instructions of Table 10.1 present only a basic list of abnormalities, causes and corrective actions. In case of questions, consult WEG.

Table 10.1: Basic list of abnormalities, causes and corrective actions

ABNORMALITY	POSSIBLE CAUSES	CORRECTION
Neither coupled nor uncoupled does the motor start	▪ At least two power cables are interrupted, without voltage	▪ Check the control panel, the power cables, and the terminals
	▪ Rotor is locked	▪ Unlock the rotor
	▪ Damaged bearing	▪ Repair or replace the bearing
	▪ Excessive load at start	▪ Check the load characteristics at start
	▪ Stator circuit is open	▪ Measure and compare the stator phase resistances
	▪ Short-circuited diode or open thyristor	▪ Replace the rectifier
Motor starts with no load, but fails when load is applied It starts very slowly and does not reach the rated speed	▪ Power supply voltage is too low	▪ Measure the power supply voltage, and set it to the correct value
	▪ Very high voltage drop in the power cables	▪ Check the cross section of the power cables
	▪ Rotor bars (damper winding) are damaged or interrupted	▪ Check and repair the rotor bars (cage)
	▪ A power cable was interrupted after the start	▪ Check the connection of the power cables
Very high no load current	▪ Failure in excitation (power factor too low – out of synchronism)	▪ Check the power factor and correct the failure in the excitation
Hot spots in the stator winding	▪ Short-circuit between turns	▪ Rewind the stator
	▪ Interruption of the parallel wires or phases of the stator winding	
	▪ Defective electrical connections	▪ Redo the connections
Stator winding becomes very hot under load	▪ Fans operating in the wrong direction	▪ Correct the rotation direction of the fans
	▪ Inadequate cooling due to dirt in the heat exchanger pipes (if any)	▪ Clean the pipes of the heat exchanger
	▪ Overload	▪ Measure the stator voltage, reduce the load, check the motor application
	▪ Excessive number of starts or very high load inertia	▪ Reduce the number of starts
	▪ Supply voltage is too high, increasing the iron loss	▪ Do not exceed 110% of the rated voltage, except otherwise specified on the nameplate
	▪ Supply voltage is too low, therefore the current is too high	▪ Check the supply voltage and the voltage drop on the motor
	▪ Interruption in a power cable or in a winding phase	▪ Measure the current in all the phases and, if necessary, correct it
	▪ Rotor drags against the stator	▪ Check the air-gap, operating conditions, vibration, bearing conditions
	▪ The operating condition does not correspond to the data on the nameplate	▪ Keep the operating condition according to the motor nameplate or reduce the load
	▪ Unbalance in the power supply (blown fuse, wrong command)	▪ Check if there is voltage unbalance or operation with two phases and correct it
	▪ Obstructed ventilation (air inlet or outlet)	▪ Remove obstructions from the air inlet and outlet

ABNORMALITY	POSSIBLE CAUSES	CORRECTION
Hot spots in the rotor	▪ Interruptions or failure in the insulation of the rotor winding	▪ Repair the rotor winding
	▪ Motor overexcited	▪ Check and correct the exciting current
Heating in the damper winding (rotor)	▪ High negative sequence current	▪ Correct voltage unbalance; ▪ Check the line harmonics (correct)
Abnormal noise during operation with load	▪ Mechanical causes: The noise normally decreases when the speed reduces; see also: "noisy operation when uncoupled"	▪ Check mechanical causes (balancing, alignment, coupling, bearings...)
	▪ Electrical causes: The noise disappears when the motor is shut down. Consult the manufacturer	▪ Perform electrical and magnetic analysis
When coupled, there is noise; when uncoupled, the noise disappears	▪ Defect in the coupling parts or in the driven machine	▪ Check the power transmission, the coupling and the alignment
	▪ Defect in the gear coupling	▪ Align the driving set, check the gear box position
	▪ Defect in the coupling	▪ Align the motor and the driven machine
	▪ Problems in the foundation	▪ Repair the foundation
	▪ Faulty balancing of the components or of the driven machine	▪ Perform new balancing
	▪ Power supply voltage is too high	▪ Check the supply voltage and the current with no load
	▪ Wrong rotation direction of the motor	▪ Invert the connection of two phases
Noisy operation when uncoupled	▪ Unbalance. Noise remains during deceleration after disconnecting the voltage.	▪ Perform new balancing
	▪ Interruption in one phase of the stator winding	▪ Measure the current at all connecting cables
	▪ Fastening screws are loose	▪ Retighten and lock the screws
	▪ The rotor balancing conditions become worse after the assembly of the coupling	▪ Balance the coupling
	▪ Resonance in the foundation	▪ Adjust the foundation
	▪ Motor frame is deformed	▪ Check flatness of the base
	▪ Bent shaft	▪ Correct or replace the shaft
		▪ Check the rotor balancing and eccentricity
▪ Air-gap is not even	▪ Check shaft warping or rolling bearing wear	

11 DECLARATION OF CONFORMITY

EU Declaration of Conformity

<p>Manufacturers: WEG Equipamentos Elétricos S.A. Av. Prefeito Waldemar Grubba, 3000 89256-900 - Jaraguá do Sul – SC – Brazil www.weg.net</p> <p>WEG Industrie (India) PVT. LTD. Plot nº E-20 (North), SIPCOT Industrial Complex Phase II – Expansion II. Mornapalli Village, Hosur 635 109 Tamil Nadu - India www.weg.net/in</p> <p>WEG MEXICO, S.A. DE C.V Carretera Jorobas - Tula Km 3.5, Manzana 5, Lote 1, Fraccionamiento Parque Industrial Huehuetoca, Municipio de Huehuetoca, C.P. 54680, CD. de Mexico y Área Metropolitana – Mexico www.weg.net/mx</p>	<p>WEG (Jiangsu) Electric Equipment CO., LTD. No. 15 Group, North City Street, Dengyuan Community Rugao City, Jiangsu Province – China www.weg.net/cn</p> <p>WEG (Nantong) Electric Motor Manufacturing CO., LTD. No. 128# - Xinkai South Road, Nantong Economic & Technical Development Zone, Nantong, Jiangsu Province – China www.weg.net/cn</p> <p>WEGeuro – Industria Eléctrica S.A. Rua Eng Frederico Ulrich, Apartado 6074 4476-908 – Maia – Porto – Portugal www.weg.net/pt Contact person: Luís Filipe Oliveira Silva Castro Araújo Authorised Representative in the European Union (Single Contact Point)</p>
---	--

The manufacturer declares under sole responsibility that:

WEG synchronous and asynchronous motors, generators and their components used for following lines:

M..., W60, WGM, G... and S...

.....

when installed, maintained and used in applications for which they were designed, and in compliance with the relevant installation standards and manufacturer's instructions, comply with the provisions of the following relevant European Union harmonisation legislation, wherever applicable:

Low Voltage Directive 2006/95/EC* (valid until April 19th, 2016)
Low Voltage Directive 2014/35/EU* (valid from April 20th, 2016)
Machinery Directive 2006/42/EC**

EMC Directive 2014/30/EU (electric motors are considered inherently benign in terms of electromagnetic compatibility)

The fulfilment of the safety objectives of the relevant European Union harmonisation legislation has been demonstrated by compliance with the following standards, wherever applicable:

**EN 60034-1:2010 + AC:2010/ EN 60034-5:2001 + A1:2007/ EN 60034-6:1993/
 EN 60034-7:1993 + A1:2001/ EN 60034-8:2007 + A1: 2014/ EN 60034-9:2005 + A1:2007/ EN 60034-11:2004/
 EN 60034-12:2002 + A1:2007/ EN 60034-14:2004 + A1:2007/
 EN 60204-1:2006 + A1:2009 + AC:2010 and EN 60204-11:2000 + AC:2010**

CE marking in: 1998

* Electric motors designed for use with a voltage rating higher than 1000V are not considered under the scope.
 ** Low voltage electric motors are not considered under the scope and electric motors designed for use with a voltage rating higher than 1000V are considered partly completed machinery and are supplied with a

Declaration of Incorporation:

The products above cannot be put into service until the machinery into which they have been incorporated has been declared in conformity with the Machinery Directive.

A Technical Documentation for the products above is compiled in accordance with part B of annex VII of Machinery Directive 2006/42/EC.

We undertake to transmit, in response to a reasoned request by the national authorities, relevant information on the partly completed machinery identified above through WEG authorised representative established in the European Union. The method of transmission shall be electronic or physical method and shall be without prejudice to the intellectual property rights of the manufacturer.

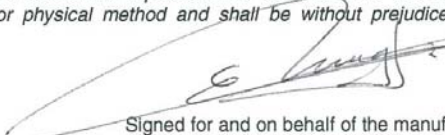
 Signed for and on behalf of the manufacturer:
Eduardo de Nobrega
 Managing Director

Jaraguá do Sul, May 28th, 2016
DEC2816-Rev01 - English 1/1

12 ENVIRONMENTAL INFORMATION

12.1 PACKAGE

Electric motors are supplied in cardboard, polymer, wood or metallic material packages. These materials are recyclable or reusable and must be properly disposed according to the current regulations of each country. All the wood used in the packaging of WEG motors comes from reforestation and receives anti-fungal treatment.

12.2 PRODUCT

Electric motors, under the constructive aspect, are manufactured mainly with ferrous metals (steel, cast iron), nonferrous metals (copper, aluminum) and plastic. The electric motor, in general, is a product that has a long useful life; however, when it must be disposed, WEG recommends that the materials of the packaging and of the product be properly separated and sent for recycling. The non-recyclable materials must be properly disposed according to the environmental regulations, i.e., in industrial landfill, co-processed in cement kilns or incinerated. The service providers for recycling, disposal in industrial landfills, co-processing or incineration of waste must be properly licensed by the environmental agency of each state to carry out these activities.

12.3 HAZARDOUS WASTE

Grease and oil waste used to lubricate the bearings should be disposed, according to the instructions of the relevant environmental agencies, because its improper disposal can cause impacts to the environment.

13 WARRANTY TERM

These products, when operated under the conditions stipulated by WEG in the operating manual for such product, are warranted against defects in workmanship and materials for twelve (12) months from start-up date or eighteen (18) months from manufacturer shipment date, whichever occurs first.

However, this warranty does not apply to any product which has been subject to misuse, misapplication, neglect (including without limitation, inadequate maintenance, accident, improper installation, modification, adjustment, repair or any other cases originated from inadequate applications).

The company will neither be responsible for any expenses incurred in installation, removal from service, consequential expenses such as financial losses nor transportation costs as well as tickets and accommodation expenses of a technician when this is requested by the customer.

The repair and/or replacement of parts or components, when effected by WEG within the Warranty period do not give Warranty extension, unless otherwise expressed in writing by WEG.

This constitutes WEG's only warranty in connection with this sale and is in lieu of all other warranties, expressed or implied, written or oral.

There are no implied warranties of merchantability or fitness for a particular purpose that apply to this sale.

No employee, agent, dealer, repair shop or other person is authorized to give any warranties on behalf of WEG nor to assume for WEG any other liability in connection with any of its products.

In case this happens without WEG's authorization, Warranty is automatically cancelled.

LIABILITY

Except as specified in the foregoing paragraph entitled "Warranty Terms for Engineering Products", the company shall have no obligation or liability whatsoever to the purchaser, including, without limitation, any claims for consequential damages or labor costs, by reason of any breach of the express warranty described therein.

The purchaser further hereby agrees to indemnify and hold the company harmless from any causes of action (other than cost of replacing or repairing the defective product as specified in the foregoing paragraph entitled "Warranty Terms for Engineering Products"), arising directly or indirectly from the acts, omissions or negligence of the purchaser in connection with or arising out of the testing, use, operation, replacement or repair of any product described in this quotation and sold or furnished by the company to the purchaser.



WEG Equipamentos Elétricos S.A.
International Division
Av. Prefeito Waldemar Grubba, 3000
89256-900 - Jaraguá do Sul - SC - Brazil
Phone: 55 (47) 3276-4002
Fax: 55 (47) 3276-4060
www.weg.net

ARGENTINA

WEG EQUIPAMIENTOS ELECTRICOS S.A.
Sgo. Pampiglione 4849
Parque Industrial San Francisco
2400 - San Francisco
Phone: +54 (3564) 421484
www.weg.net/ar

AUSTRALIA

WEG AUSTRALIA PTY. LTD.
14 Lakeview Drive, Scoresby 3179,
Victoria
Phone: +03 9765 4600
www.weg.net/au

AUSTRIA

WATT DRIVE ANTRIEBSTECHNIK GMBH*
Wöllersdorfer Straße 68
2753, Markt Piesting
Phone: + 43 2633 4040
www.wattdrive.com

LENZE ANTRIEBSTECHNIK GES.M.B.H.*

IpF - Landesstrasse 1
A-4481 Asten
Phone: +43 (0) 7224 / 210-0
www.lenze.at

BELGIUM

WEG BENELUX S.A.*
Rue de l'Industrie 30 D,
1400 Nivelles
Phone: +32 67 888420
www.weg.net/be

BRAZIL

WEG EQUIPAMENTOS ELÉTRICOS S.A.
Av. Pref. Waldemar Grubba, 3000,
CEP 89256-900 Jaraquá do Sul – SC
Phone: +55 47 3276-4000
www.weg.net/br

CHILE

WEG CHILE S.A.
Los Canteros 8600,
La Reina - Santiago
Phone: +56 2 2784 8900
www.weg.net/cl

CHINA

WEG (NANTONG) ELECTRIC MOTOR
MANUFACTURING CO. LTD.
No. 128# - Xinkai South Road, Nantong
Economic & Technical Development Zone,
Nantong, Jiangsu Province
Phone: +86 513 8598 9333
www.weg.net/cn

COLOMBIA

WEG COLOMBIA LTDA
Calle 46A N82 – 54
Porteria II - Bodega 6 y 7
San Cayetano II - Bogotá
Phone: +57 1 416 0166
www.weg.net/co

DENMARK

WEG SCANDINAVIA DENMARK*
Sales Office of WEG Scandinavia AB
Verkstadgatan 9 - 434 22 Kumgsbacka,
Sweden
Phone: +46 300 73400
www.weg.net/se

FRANCE

WEG FRANCE SAS*
ZI de Chenes - Le Loup13 / 38297 Saint
Quentin Fallavier,
Rue du Mo-reillon - BP 738/
Rhône Alpes, 38 > Isère
Phone: + 33 47499 1135
www.weg.net/fr

**GREECE**

MANGRINOX*
14, Grevenon ST.
GR 11855 - Athens, Greece
Phone: + 30 210 3423201-3
www.weg.net/gr

GERMANY

WEG GERMANY GmbH*
Industriegebiet Türnich 3 Geigerstraße 7
50169 Kerpen-Türnich
Phone: + 49 2237 92910
www.weg.net/de

GHANA

ZEST ELECTRIC MOTORS (PTY) LTD.
15, Third Close Street Airport Residential Area,
Accra
Phone: +233 3027 66490
www.zestghana.com.gh

HUNGARY

AGISYS AGITATORS & TRANSMISSIONS
LTD.*
Tó str. 2. Torokbalint, H-2045 Phone: + 36
(23) 501 150
www.agisys.hu

INDIA

WEG ELECTRIC (INDIA) PVT. LTD.
#38, Ground Floor, 1st Main Road,
Lower Palace, Orchards,
Bangalore, 560 003
Phone: +91 804128 2007
www.weg.net/in

ITALY

WEG ITALIA S.R.L.*
Via Viganò de Vizzi, 93/95
20092 Cinisello Balsamo, Milano Phone: + 39
2 6129 3535
www.weg.net/it

FERRARI S.R.L.*

Via Cremona 25 26015
Soresina (CR), Cremona
Phone: + 39 (374) 340-404
www.ferrarisrl.it

STIAVELLI IRIRO S.P.A.*

Via Pantano - Blocco 16 - Capalle 50010 ,
Campi Bisenzio (FI)
Phone: + 39 (55) 898.448
www.stiavelli.com

JAPAN

WEG ELECTRIC MOTORS JAPAN CO., LTD.
Yokohama Sky Building 20F, 2-19-12
Takashima, Nishi-ku, Yokohama City,
Kanagawa, Japan 220-0011
Phone: + 81 45 5503030
www.weg.net/jp

MEXICO

WEG MEXICO, S.A. DE C.V.
Carretera Jorobas-Tula
Km. 3.5, Manzana 5, Lote 1 Fraccionamiento
Parque Industrial
Huehuetoca
Estado de México - C.P. 54680
Phone: +52 55 53214275
www.weg.net/mx

NETHERLANDS

WEG NETHERLANDS*
Sales Office of WEG Benelux S.A. Hanzepoort
23C, 7575 DB Oldenzaal
Phone: +31 541 571090
www.weg.net/nl

PORTUGAL

WEG EURO - INDÚSTRIA ELÉCTRICA, S.A.*
Rua Eng. Frederico Ulrich,
Sector V, 4470-605 Maia,
Apartado 6074, 4471-908 Maia, Porto
Phone: +351 229 477 705
www.weg.net/pt

RUSSIA

WEG ELECTRIC CIS LTD.*
Russia, 194292, St. Petersburg, Pro-spekt
Kulturny 44, Office 419
Phone: +7 812 3632172
www.weg.net/ru

SOUTH AFRICA

ZEST ELECTRIC MOTORS (PTY) LTD.
47 Galaxy Avenue, Linbro Business
Park Gauteng Private Bag X10011
Sandton, 2146, Johannesburg
Phone: +27 11 7236000
www.zest.co.za

SPAIN

WEG IBERIA INDUSTRIAL S.L.*
C/ Tierra de Barros, 5-7
28823 Coslada, Madrid
Phone: +34 91 6553008
www.weg.net/es

SINGAPORE

WEG SINGAPORE PTE LTD
159, Kampong Ampat, #06-02A KA PLACE.
368328
Phone: +65 68581081
www.weg.net/sg

SWEDEN

WEG SCANDINAVIA AB.*
Box 27, 435 21 Mölnlycke
Visit: Designvägen 5, 435 33
Mölnlycke, Göteborg
Phone: +46 31 888000
www.weg.net/se

SWITZERLAND

BIBUS AG*
Allmendstrasse 26, 8320 – Fehraltorf
Phone: + 41 44 877 58 11
www.bibus-holding.ch

UNITED ARAB EMIRATES

The Galleries, Block No. 3, 8th Floor,
Office No. 801 - Downtown Jebel Ali
262508, Dubai
Phone: +971 (4) 8130800
www.weg.net/ae

UNITED KINGDOM

WEG ELECTRIC MOTORS (U.K.) LTD.*
Broad Ground Road - Lakeside Redditch,
Worcestershire B98 8YP
Phone: + 44 1527 513800
www.weg.net/uk

ERIKS*

Amber Way, B62 8WG Halesowen
West Midlands
Phone: + 44 (0)121 508 6000

BRAMMER GROUP*

PLC43-45 Broad St, Teddington
TW11 8QZ
Phone: + 44 20 8614 1040

USA

WEG ELECTRIC CORP.
6655 Sugarloaf Parkway, Duluth, GA 30097
Phone: +1 678 2492000
www.weg.net/us

VENEZUELA

WEG INDUSTRIAS VENEZUELA C.A.
Centro corporativo La Viña Plaza,
Cruce de la Avenida Carabobo con la calle
Uzlar de la Urbanización La Viña / Jurisdicción
de la Parroquia San José - Valencia
Oficinas 06-16 y 6-17, de la planta tipo 2, Nivel
5, Carabobo
Phone: (58) 241 8210582
www.weg.net/ve

* European Union Importers