

# Low and high voltage three phase induction motors

M line - Slip ring rotor - Vertical

## Installation, Operation and Maintenance Manual

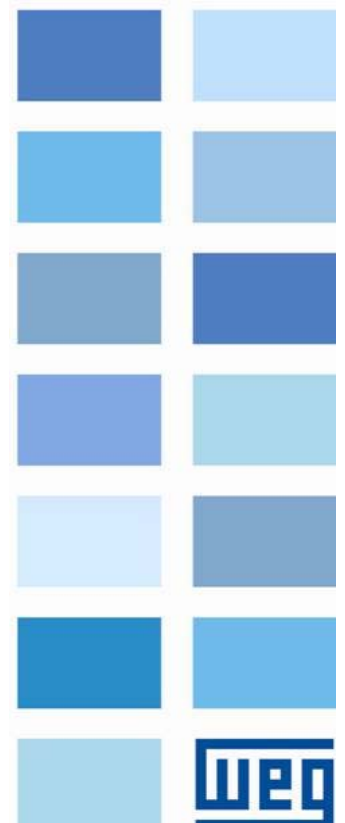

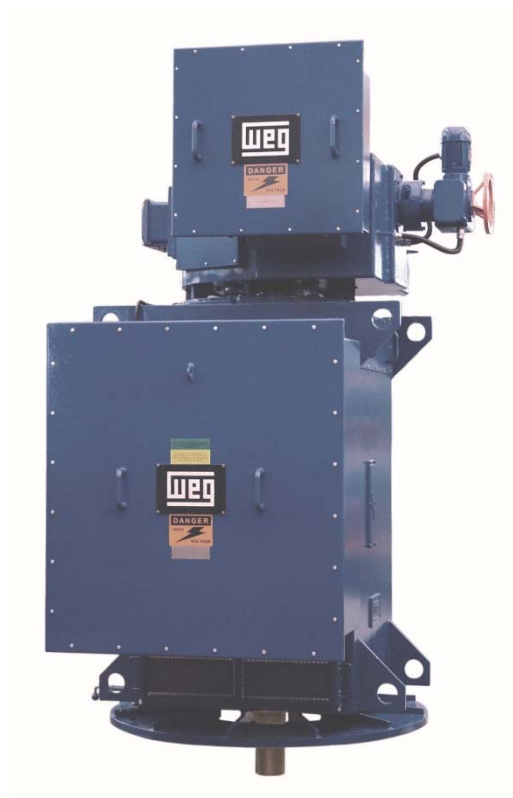



# **Installation, Operation and Maintenance Manual**

Document Number: 11734748

Models: MAA, MAP, MAD, MAT, MAV, MAF, MAR, MAI, MAW and MAL

Language: English

Revision: 8

March 2017



Dear Customer,

Thank you for purchasing a WEG motor. Our products are developed with the highest standards of quality and efficiency which ensures outstanding performance.

Since electric motors play a major role in the comfort and well-being of mankind, it must be identified and treated as a driving machine with characteristics that involve specific care, such as proper storage, installation and maintenance

All efforts have been made to ensure that the information contained in this manual is faithful to the configurations and applications of the motor.

Therefore, we recommend that you read this manual carefully before proceeding with the installation, operation or maintenance of the motor in order to ensure safe and reliable operation of your equipment and facility. If you need any further information, please contact WEG.

Always keep this manual close to the motor, so that it can be consulted whenever necessary.



#### ATTENTION

1. It is imperative to follow the procedures contained in this manual for the warranty to be valid;
2. The motor installation, operation and maintenance procedures must be performed only by qualified personnel.



#### NOTES

1. The total or partial reproduction of information supplied in this manual is authorized, provided that reference is made to its source. If this manual is lost, an electronic PDF file is available at [www.weg.net](http://www.weg.net) or another printed copy may be requested.

**WEG EQUIPAMENTOS ELÉTRICOS S.A.**



## TABLE OF CONTENTS

<b>1</b>	<b>INTRODUCTION .....</b>	<b>11</b>
1.1	SAFETY WARNINGS IN THE MANUAL .....	11
<b>2</b>	<b>GENERAL INSTRUCTIONS .....</b>	<b>12</b>
2.1	QUALIFIED PERSONNEL .....	12
2.2	SAFETY INSTRUCTIONS .....	12
2.3	STANDARDS.....	12
2.4	ENVIRONMENTAL CONDITIONS.....	13
2.5	OPERATING CONDITIONS .....	13
2.6	VOLTAGE AND FREQUENCY .....	13
<b>3</b>	<b>RECEIVING, HANDLING AND STORAGE .....</b>	<b>14</b>
3.1	RECEIVING .....	14
3.2	HANDLING.....	14
3.2.1	Motor positioning .....	15
3.3	STORAGE .....	15
3.3.1	Outdoor storage .....	15
3.3.2	Extended storage .....	15
3.3.2.1	Storage location .....	16
3.3.2.1.1	Indoor storage .....	16
3.3.2.1.2	Outdoor storage .....	16
3.3.2.2	Separate parts .....	16
3.3.3	Preservation during the storage.....	16
3.3.3.1	Space heater.....	16
3.3.3.2	Insulation resistance .....	16
3.3.3.3	Exposed machined surfaces.....	16
3.3.3.4	Sealing .....	16
3.3.3.5	Bearings.....	17
3.3.3.5.1	Grease-lubricated rolling bearing.....	17
3.3.3.5.2	Oil-lubricated rolling bearing.....	17
3.3.3.5.3	Sleeve bearing .....	17
3.3.3.6	Brushes .....	17
3.3.3.7	Terminal box .....	18
3.3.3.8	Air-water heat exchanger .....	18
3.3.3.9	Cleanliness and conservation of the motor during storage .....	18
3.3.3.10	Inspections and records during storage.....	18
3.3.3.11	Predictive/preventive maintenance.....	18
3.3.3.12	Maintenance plan during storage.....	19
3.3.4	Preparation for commissioning .....	20
3.3.4.1	Cleaning.....	20
3.3.4.2	Bearing inspection.....	20
3.3.4.3	Bearing lubrication.....	20
3.3.4.4	Brushes, brush holders and slip rings .....	20
3.3.4.5	Insulation resistance verification .....	20
3.3.4.6	Air-water heat exchanger .....	20
3.3.4.7	Others.....	20
<b>4</b>	<b>INSTALLATION.....</b>	<b>21</b>
4.1	INSTALLATION SITE .....	21
4.2	SHAFT LOCK.....	21
4.2.1	Radial lock.....	21
4.2.2	Procedure for replacing the radial locking device.....	21
4.3	ROTATION DIRECTION.....	21
4.4	INSULATION RESISTANCE.....	22
4.4.1	Safety Instructions .....	22
4.4.2	General considerations .....	22
4.4.3	Measurement on the stator windings.....	22
4.4.4	Measurement on the rotor winding.....	22
4.4.5	Additional Information .....	23
4.4.6	Polarization Index.....	23
4.4.7	Conversion of the measured values.....	23
4.4.8	Insulation assessment.....	23
4.5	PROTECTIONS .....	24

4.5.1	Thermal protections .....	24
4.5.1.1	Temperature sensors.....	24
4.5.1.2	Temperature limits for the windings.....	24
4.5.1.3	Alarm and trip temperatures .....	25
4.5.1.4	Temperature and ohmic resistance of the PT100 thermoresistance .....	26
4.5.1.5	Space heater.....	26
4.5.2	Water leak sensor .....	26
4.6	COOLING .....	27
4.6.1	Air-water heat exchange cooling .....	27
4.6.1.1	Radiators for application with seawater.....	27
4.6.2	Independent ventilation cooling .....	27
4.7	ELECTRICAL ASPECTS .....	28
4.7.1	Electrical connections.....	28
4.7.1.1	Main electrical connections.....	28
4.7.1.2	Grounding .....	28
4.7.2	Connection diagrams.....	29
4.7.2.1	Connection diagrams according to IEC60034-8.....	29
4.7.2.1.1	Stator connection diagrams .....	29
4.7.2.1.2	Rotor connection diagrams .....	29
4.7.2.2	Connection diagrams according to NEMA MG1 .....	30
4.7.2.2.1	Stator connection diagrams .....	30
4.7.2.2.2	Rotor connection diagrams .....	30
4.7.2.3	Rotation direction .....	30
4.7.2.4	Accessory connection diagrams .....	30
4.7.2.5	Motorized brush holder connection diagram .....	31
4.7.2.5.1	Condition for starting with lowered brushes and non-short-circuited slip rings .....	31
4.7.2.5.2	Condition for operation with lifted brushes and short-circuited slip rings .....	32
4.7.2.5.3	Motorized brush holder operation logic.....	33
4.7.2.5.4	Manual operation .....	33
4.8	MECHANICAL ASPECTS .....	33
4.8.1	Foundations.....	33
4.8.2	Foundation loads .....	33
4.8.3	Motor mounting .....	33
4.8.3.1	Motor with solid shaft and flange .....	34
4.8.3.2	Motor with hollow shaft and flange.....	34
4.8.4	Anchor plate set.....	34
4.8.5	Natural frequency of the base.....	34
4.8.6	Leveling.....	35
4.8.7	Alignment.....	35
4.8.8	Hollow shaft motor alignment .....	36
4.8.9	Doweling.....	36
4.8.10	Couplings.....	36
4.8.10.1	Direct coupling .....	36
4.8.10.2	Gear coupling.....	37
4.8.10.3	Belt drive.....	37
4.8.10.4	Coupling for hollow shaft motors .....	37
4.9	HYDRAULIC UNIT .....	37
<b>5</b>	<b>STARTING .....</b>	<b>38</b>
5.1	STARTING WITH RHEOSTAT.....	38
5.2	STARTING OF MOTORS WITH MOTORIZED BRUSH HOLDER.....	38
5.2.1	Conditions for motor starting.....	38
5.2.2	After starting .....	38
5.2.3	Manual operation .....	39
<b>6</b>	<b>COMMISSIONING .....</b>	<b>40</b>
6.1	PRELIMINARY INSPECTION .....	40
6.2	FIRST STARTING .....	40
6.2.1	Starting procedure .....	40
6.3	OPERATION .....	41
6.3.1	General.....	41
6.3.2	Load Condition .....	41
6.3.3	Temperatures.....	41
6.3.4	Bearings.....	41
6.3.4.1	High-pressure oil injection system.....	41
6.3.5	Radiators .....	41
6.3.6	Vibration.....	42



6.3.7	Shaft vibration limits .....	42
6.3.8	Shutdown .....	42
<b>7</b>	<b>MAINTENANCE .....</b>	<b>43</b>
7.1	GENERAL .....	43
7.1.1	Brushes and slip rings .....	43
7.2	GENERAL CLEANING .....	43
7.3	BRUSH COMPARTMENT CLEANING .....	43
7.4	WINDING INSPECTIONS .....	43
7.5	WINDING CLEANING .....	43
7.5.1	Inspections .....	44
7.5.2	Reimpregnation .....	44
7.5.3	Insulation Resistance .....	44
7.6	COOLING SYSTEM MAINTENANCE .....	44
7.7	RADIATOR MAINTENANCE .....	44
7.8	VIBRATION .....	44
7.9	ANTI-REVERSION RATCHET MAINTENANCE .....	45
7.10	SLIP RINGS .....	45
7.11	BRUSH HOLDER AND BRUSHES .....	45
7.11.1	Adjustment of the brushes to the load conditions .....	45
7.12	SHAFT GROUNDING DEVICE .....	45
7.13	BEARING MAINTENANCE .....	46
7.13.1	Grease-lubricated rolling bearings .....	46
7.13.1.1	Instructions for lubrication .....	46
7.13.1.2	Procedures for rolling bearing relubrication .....	46
7.13.1.3	Rolling bearing relubrication with drawer device for grease removal .....	46
7.13.1.4	Type and amount of grease .....	46
7.13.1.5	Alternative greases .....	47
7.13.1.6	Procedure for changing the grease .....	49
7.13.1.7	Low temperature greases .....	49
7.13.1.8	Grease compatibility .....	49
7.13.1.9	Disassembly – vertical bearings .....	49
7.13.1.9.1	Before disassembling .....	49
7.13.1.9.2	Lower bearing disassembly .....	49
7.13.1.9.3	Upper bearing disassembly .....	50
7.13.1.10	Bearing assembly .....	50
7.13.2	Oil-lubricated rolling bearing .....	50
7.13.2.1	Lubrication instructions .....	50
7.13.2.2	Oil type .....	51
7.13.2.3	Oil change .....	51
7.13.2.4	Bearing operation .....	51
7.13.2.5	Bearing disassembly .....	51
7.13.2.6	Bearing assembly .....	52
7.13.3	Rolling bearing replacement .....	52
7.13.4	Sleeve bearings .....	52
7.13.4.1	Bearing data .....	52
7.13.4.2	Bearing installation and operation .....	52
7.13.4.3	Cooling by water circulation .....	52
7.13.4.4	Oil change .....	53
7.13.4.5	Sealing .....	53
7.13.4.6	Sleeve bearing operation .....	53
7.13.4.7	Sleeve bearing maintenance .....	53
7.13.4.8	Bearing disassembly and assembly .....	54
7.13.4.8.1	Thrust bearing (upper) .....	54
7.13.4.8.2	Guide bearing (lower) .....	54
7.13.5	Bearing protection .....	54
7.13.5.1	Protection settings .....	54
7.13.5.2	Disassembly/assembly of the bearing temperature sensors .....	55
7.14	MAINTENANCE OF THE BRUSH LIFTING SYSTEM .....	56
7.14.1	Parts list .....	57
7.14.2	Preventive maintenance procedures .....	57
7.14.3	Adjustment of the electromechanical actuator .....	57
7.14.3.1	Mechanical adjustment .....	58
7.14.3.2	Electrical adjustment .....	58
<b>8</b>	<b>MOTOR DISASSEMBLY AND ASSEMBLY .....</b>	<b>59</b>
8.1	PARTS LIST .....	59

8.2	DISASSEMBLY .....	59
8.3	ASSEMBLY .....	59
8.4	AIR-GAP MEASUREMENT .....	59
8.5	TIGHTENING TORQUE.....	59
8.6	SPARE PARTS .....	61
<b>9</b>	<b>MAINTENANCE PLAN .....</b>	<b>62</b>
<b>10</b>	<b>ABNORMALITIES, CAUSES AND SOLUTIONS.....</b>	<b>63</b>
<b>11</b>	<b>DECLARATION OF CONFORMITY.....</b>	<b>65</b>
<b>12</b>	<b>ENVIRONMENTAL INFORMATION .....</b>	<b>66</b>
12.1	PACKAGE .....	66
12.2	PRODUCT .....	66
12.3	HAZARDOUS WASTE .....	66
<b>13</b>	<b>WARRANTY TERM .....</b>	<b>67</b>

# 1 INTRODUCTION

This manual contains information regarding low and high-voltage, three-phase induction motors. Motors with special features can be supplied with specific documents (drawings, connection diagram, characteristic curves etc.). Those documents, together with this manual, must be thoroughly evaluated before proceeding with the installation, operation or maintenance of the motor.

In order to use a frequency inverter, it is mandatory to follow the instructions contained in the specific technical documentation of the motor and in the manual of the frequency inverter.

If any additional explanation about motors with major special features is necessary, consult WEG. All procedures and standards contained in this manual must be observed in order to ensure proper operation of the motor and the safety of the personnel involved in its operation. Following these procedures is also important to ensure the validity of the motor warranty. Thus, we recommend the careful reading of this manual before the installation and operation of the motor. If any further information is still necessary, consult WEG.

## 1.1 SAFETY WARNINGS IN THE MANUAL

In this manual, the following safety warnings are used:



### DANGER

Failure to observe the procedures recommend in this warning may result in death, serious injuries and extensive equipment damage.



### ATTENTION

Failure to observe the procedures recommend in this warning may result in equipment damage.



### NOTE

This provides important information for correct understanding and proper operation of the product.

## 2 GENERAL INSTRUCTIONS

All the personnel involved with the assembly, operation or maintenance of electrical installations must be permanently informed and updated on the standards and safety instructions that guide the job and are advised to strictly comply with them. Before beginning any job, the person in charge must make sure that all points have been duly observed and warn the respective personnel about the danger inherent to the task to be performed. Improper application, inadequate handling or maintenance of the motor may cause serious injuries and/or material damages. Therefore, it is highly recommended that these services be always performed by qualified personnel.

### 2.1 QUALIFIED PERSONNEL

The term qualified personnel means those who, because of their training, experience, education level, and knowledge of the applicable standards, specifications, accident prevention, safety standards and operating conditions, have been authorized by the persons in charge to execute the necessary tasks, and who are able to recognize and avoid any possible danger. Such qualified personnel must also know and be able to provide first aid procedures if necessary. The entire start-up, maintenance and repair tasks must only be performed by qualified personnel.

- All the technical data regarding the allowed applications (operating conditions, connections and installation environment), included in the catalog, in the purchase order documents, in the operating instructions, in manuals and all other documentation;
- The specific regulations and conditions for the local installation;
- The use of suitable tools and equipment for handling and transportation;
- That the protective devices of the individual components are removed shortly before installation. Individual parts must be stored in vibration-free environments, avoiding falls and ensuring their protection against aggressive agents and/or that they do not jeopardize people.

### 2.2 SAFETY INSTRUCTIONS



**DANGER**

During normal operation of this equipment, a hazard associated with energized or rotating components with high voltage or elevated temperatures exists. Thus, the operation with open terminal boxes, unprotected couplings, improper handling, or failure to comply with the operating standards, may cause severe personal injuries and material damages.



**ATTENTION**

When devices and equipment are used outside the industrial environment, the user must ensure the safety of the equipment by adopting proper protection and safety measures during installation (for example, keep people away, avoid contact of children, etc.).

Those responsible for the safety of the installation must ensure that:

- Only qualified personnel install and operate the equipment;
- They have this manual and all other documents supplied with the motor at hand, as well as that they perform the tasks in strict compliance with the service instructions, relevant standards and specific product documentation;



**ATTENTION**

Failure to comply with installation and safety standards may void the product warranty. Firefighting equipment and first aid notices must be available in visible and easily accessible locations at the work site.

### 2.3 STANDARDS

The motors are specified, designed, manufactured and tested according to the standards described in Table 2.1. The applicable standards are specified in the commercial contract, which may indicate other national or international standards, depending on the application or installation location.

Table 2.1: Applicable standards

	IEC / NBR	NEMA
<b>Specification</b>	IEC60034-1 NBR 17094	MG1-1,10,20
<b>Dimensions</b>	IEC60072 NBR 15623	MG1-4,11
<b>Tests</b>	IEC60034-2 NBR 5383	MG1-12
<b>Levels of protection</b>	IEC60034-5 NBR IEC 60034-5	MG1-5
<b>Cooling</b>	IEC60034-6 NBR IEC 60034-6	MG1-6
<b>Mounting</b>	IEC60034-7 NBR IEC 60034-7	MG1-4
<b>Noise</b>	IEC60034-9 NBR IEC 60034-9	MG1-9
<b>Mechanical Vibration</b>	IEC60034-14 NBR IEC 60034-14	MG1-7
<b>Mechanical Tolerances</b>	ISO286 / NBR6158	MG1-4
<b>Balancing</b>	ISO1940	MG1-7

Qualified personnel must also observe:

## 2.4 ENVIRONMENTAL CONDITIONS

The motor was designed according to the specific environmental conditions (temperature and altitude) of your application, and are described on the nameplate and in the datasheet of the motor.



### ATTENTION

For the use of water-cooled motors in ambient temperatures below +5°C, antifreeze additives must be added to the water.

## 2.5 OPERATING CONDITIONS

In order for the product warranty to be valid, the motor must be operated according to nominal data indicated on its nameplate, observing all applicable standards and information contained in this manual.

## 2.6 VOLTAGE AND FREQUENCY

It is very important to ensure a proper power supply for the motor. The conductors and the entire protection system must ensure the quality of the power supply at the motor terminals within the limits, in accordance with the IEC60034-1 standard:

- Voltage: may vary within a range of  $\pm 10\%$  of the rated value;
- Frequency: may vary within a range of  $-5\%$  to  $+3\%$  of the rated value.

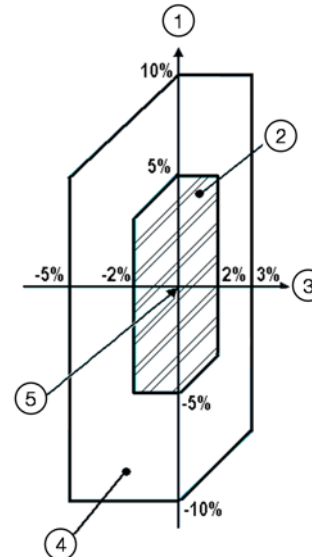

Figure 2.1: Voltage and frequency variation limits

### Figure 2.1 legend:

1. Voltage
2. Zone A
3. Frequency
4. Zone B (outside zone A)
5. Voltage with rated characteristics

The motor must be able to perform its main function continuously in Zone A, but it may not fully meet its performance characteristics at rated voltage and frequency (refer to the point with rated characteristics in Figure 2.1), when it may present some deviations. The temperature rises may be above those at rated voltage and frequency.

The motor must be able to perform its main function in Zone B, but regarding the performance characteristics at rated voltage and frequency, it may present deviations greater than those of Zone A. The temperature rises may be higher than those observed at rated voltage and frequency, and they will most likely be higher than those in Zone A.

Prolonged operation in the periphery of Zone B is not recommended.

### 3 RECEIVING, HANDLING AND STORAGE

#### 3.1 RECEIVING

All motors were tested and are in perfect operating conditions. The machined surfaces are protected against corrosion. The package must be inspected upon receipt for occasional damages during transportation.

 **ATTENTION**  
Any damage must be photographed, documented and reported immediately to the carrier, the insurer and WEG. The non-communication of this damage will void the warranty.

 **ATTENTION**  
Parts supplied in additional packages must be checked upon receipt.

- When lifting the package (or container), the proper hoisting points, the weight indicated on the package or on the nameplate and the operating capacity and conditions of the hoisting equipment must be observed;
- Motors packed in wooden crates must always be lifted by their own lifting lugs or by a proper forklift; they must never be lifted by the package;
- The package can never be overturned. Place it on the floor carefully (without impact) in order to avoid damage to the bearing;
- Do not remove the grease for protection against corrosion from the shaft end, or the closing plugs present in the terminal box holes. These protections must remain in place until the moment of the final assembly.
- A complete visual inspection of the motor must be carried out after removing the package;
- The shaft locking system must be removed just before the installation and stored to be used in future transportation of the motor.

#### 3.2 HANDLING

- Vertical motors must be handled as shown in Figure 3.1;
- Use the motor top lifting lugs for vertical movements, so that the lifting chains or cables are also in the vertical position, avoiding too much stress on the lifting lugs.

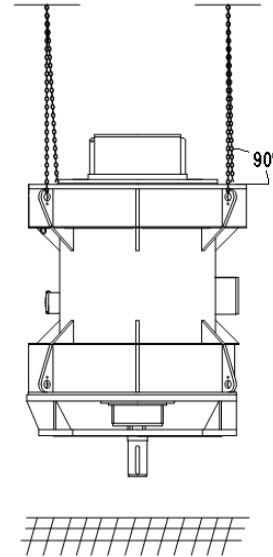

Figure 3.1: Motor handling



#### NOTES

- Observe the indicated weight. Do not lift the motor causing jolts or put it down abruptly on the floor, because this can cause damage to the bearings;
- In order to lift the motor, use only the lifting lugs provided for that purpose. If necessary, use a crossbeam to protect parts of the motor.
- The lifting lugs on the heat exchanger, end shields, bearings, radiator, terminal box, etc. are designed to handle these components only separately;
- Never use the shaft to lift the motor;
- The frame lifting lugs are intended to lift only the motor. Never use them to lift the motor-driven machine set.



#### ATTENTION

- In order to move or transport the motor, the shaft must be locked with the locking device supplied with the motor.
- Lifting equipment and devices must be able to withstand the motor weight.

### 3.2.1 Motor positioning

Vertical motors are supplied with lifting lugs at the drive end DE and non-drive end NDE. Some motors are transported in the horizontal position and need to be moved to the original position. Figure 3.2 shows how to move motors from the horizontal position to the vertical position and vice versa.

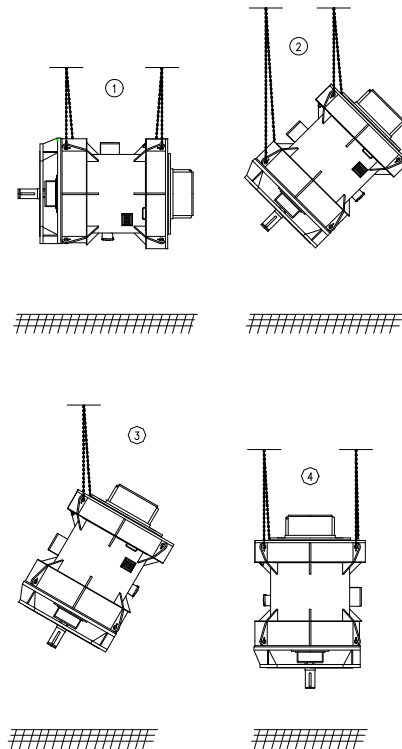



Figure 3.2: Motor positioning

In order to position vertical motors, proceed according to the following recommendations:

1. Lift the motor using the side lifting lugs and two hoists;
2. Lower the motor drive end (DE) and lift the non-drive end (NDE) at the same time until balance is reached;
3. Loosen the DE cables and turn the motor 180° in order to enable the connection of these cables to the other lifting lugs of the NDE;
4. Connect the loose cables to the NDE lifting lugs and lift them until the motor reaches the vertical position.



**ATTENTION**  
Failure to comply with these recommendations may cause damage to the equipment, personal injuries or both.

### 3.3 STORAGE

If the Motor is not installed immediately after reception, it must remain inside the package and stored in a location protected against moisture, vapors, sudden changes in temperature, rodents and insects. The motor must be stored in vibration-free locations in order to avoid bearing damage.



**ATTENTION**  
Space heaters must remain powered during storage in order to avoid moisture condensation inside the motor.  
  
Any damage to the paint or corrosion protection of the machined parts must be repaired.

#### 3.3.1 Outdoor storage

The motor must be stored in a dry location, free of flooding and vibrations. Repair any damages on the package before storing the motor, which is needed to ensure proper storage conditions. Place the motor on platforms or foundations that ensure protection against humidity from the ground and prevent it from sinking into the soil. Free air circulation underneath the motor must be assured. The cover used to protect the motor against the bad weather must not be in contact with its surfaces. In order to ensure free air circulation between the motor and such covers, place wooden blocks as spacers.

#### 3.3.2 Extended storage

When the motor is stored for a long period of time (two months or more) before start-up, it is exposed to external agents, such as temperature variations, moisture, aggressive agents, etc. The empty spaces inside the motor – such as rolling bearings, terminal boxes, and windings – are exposed to humidity, which can cause condensation, and, depending on the degree of air contamination, aggressive substances may also penetrate these empty spaces. Consequently, after long periods of storage, the winding insulation resistance may drop below the acceptable values, internal components, such as rolling bearings, may oxidize, and the lubricant power of the lubricant agent in the bearings may be adversely affected. All of these influences increase the risk of damages before starting the motor.



**ATTENTION**  
To assure that the motor warranty be valid, it is necessary to make sure that all preventive measures described in this manual, such as constructive aspects, maintenance, packaging, storage, and periodical inspections, are followed and recorded.

The extended storage instructions are valid for motors that remain stored for long periods (two months or more) before start-up or motors already installed that are in a prolonged stoppage, considering the same period.



**ATTENTION**  
For extended periods of stoppage or storage, the water inside the frame must be drained (WGM motors with water-jacket cooling).

### 3.3.2.1 Storage location

In order to ensure the best storage conditions for the motor during long periods, the chosen location must strictly meet the criteria described in sections 3.3.2.1.1 and 3.3.2.1.2.

#### 3.3.2.1.1 Indoor storage

In order to ensure better storage conditions for the motor, the storage site must comply strictly with the criteria described below:

- The storage site must be closed, covered, dry, free of air contaminants (moisture, vapor, dust, particles and aggressive fumes) and free of flooding;
- The site should be protected against sudden temperature variations, humidity, rodents and insects;
- Vibration-free location, to avoid damaging to the motor bearings;
- The floor must be of leveled concrete with resistant structure to support the motor weight;
- Must have system to fire detection and extinguishing;
- Be provided with electricity for supplying the space heaters with power failure detection system;
- Exclusive site to store electrical machines (do not mix with other equipment and/or products that could prejudice the correct motor storage);
- Site with facilities of cargo handling services, suitable to allow the motor handling and removal;
- There must be no gas present, such as chlorine, sulfur dioxide or acids;
- The site must have ventilation system with air filter;
- Ambient temperature between 5°C and 50°C, and should not present sudden temperature variation;
- Relative air humidity <50%;
- Must have prevention against dirt and dust deposition;
- The motor should be stored on a suitable metal base that prevents the absorption of moisture from the floor.

If any of these requirements is not met in the storage site, WEG suggests that additional protections be added to the motor package during the storage period, as follows:

- A closed wooden crate or the like with an electrical installation that allows the energization of the space heaters;
- If there is a risk of infestation and fungus formation, the package must be protected in the storage place by spraying it or painting it with appropriate chemicals;
- The package preparation must be prepared carefully by an experienced person.

#### 3.3.2.1.2 Outdoor storage



**ATTENTION**  
Outdoor storage of the motor is not recommended.

In case outdoor storage is unavoidable, the motor must be packed in specific packaging for such conditions, as follows:

- For outdoor storage (exposed to the weather), besides the packaging recommended for indoor storage, the package must be covered with protection against dust, moisture and other odd materials, using resistant canvas or plastic.
- The package must be placed on platforms or foundations that ensure protection against dirt and moisture and prevent it from sinking into the soil;

- After the package is covered, a shelter must be erected to protect it against direct rain, snow and excessive sun heat.



**ATTENTION**  
In case the motor remains stored for long periods (two months or more), it is recommended to inspect it regularly as specified in the section 3.3.3.12 of this manual.

### 3.3.2.2 Separate parts

- If parts are supplied separately (terminal boxes, heat exchanger, end shields, etc.), these parts must be mounted on motor to store it;
- Spare parts must be stored in an adequate place, as specified in sections 3.3.2.1.1 and 3.3.2.1.2 of this manual.
- The relative humidity inside the package must not exceed 50%.
- Rolling bearings must not be subject to shocks, falls or storage with vibration or humidity, which can cause marks on the internal tracks or on the balls, reducing their useful life.

### 3.3.3 Preservation during the storage

#### 3.3.3.1 Space heater

Space heaters must remain powered during storage to avoid moisture condensation inside the motor and ensure that the winding insulation resistance remains within acceptable levels.

The space heaters drive circuit must be unique and the voltage and current of this circuit must be measured and recorded monthly.

It is recommended that a signal be installed near the motor to indicate that the space heaters are energized.

#### 3.3.3.2 Insulation resistance

During the storage period, the insulation resistance of the motor windings must be measured and recorded every two months, and before the motor installation or eventually if there is any change in the preservation process (Eg, prolonged lack of electricity).

The measurement procedures and the criteria for acceptance of the results shall be according to IEEE-43 Standard.

Any insulation resistance reduction must be investigated.

#### 3.3.3.3 Exposed machined surfaces

All exposed machined surfaces (e.g., shaft end and flanges) are protected at the factory with a temporary protective agent (rust inhibitor).

This protection coating must be reapplied at least every six months or when removed and/or damaged.

**Recommended Product:** Protective agent Anticorit BW

**Supplier:** Fuchs

#### 3.3.3.4 Sealing

The rubber seals, gaskets, plugs and cable glands of the motor shall be inspected annually and replaced, if necessary.



### 3.3.3.5 Bearings

#### 3.3.3.5.1 Grease-lubricated rolling bearing

- The rolling bearings are lubricated at the factory for the motor tests.



**ATTENTION**

In order to keep the bearings in good condition during the storage period, **the shaft locking device must be removed every two months, and the motor rotor must be rotated at least 10 complete turns at 30 rpm** to circulate the grease and preserve the internal parts of the bearings.

- Before putting the motor into operation, the rolling bearings must be lubricated;
- If the motor remains stored for a period exceeding two years, the rolling bearings must be disassembled, washed, inspected and relubricated.

#### 3.3.3.5.2 Oil-lubricated rolling bearing

- Depending on the motor mounting position and on the lubrication type, the motor can be transported with or without oil in the bearings;
- The motor storage must be done in its original operating position and with oil in the bearings, when specified;
- The oil level must be respected, remaining in the middle of the sight glass.



**ATTENTION**

In order to keep the bearings in good condition during the storage period, **the shaft-locking device must be removed every two months, and the motor rotor must be rotated at least 10 complete turns at 30 rpm** to circulate the oil and preserve the internal parts of the bearings.

- Before putting the motor into operation, the rolling bearings must be relubricated.
- If the motor remains stored for a period exceeding 2 years, the rolling bearings must be disassembled, washed, inspected and relubricated.

#### 3.3.3.5.3 Sleeve bearing

Depending on the machine mounting position and the lubrication type, the machine can be transported with or without oil in the bearings.

The machine storage must be done in its original operating position and with oil in the bearings, when so specified.

The oil level must be respected, remaining in the middle of the sight glass.

In order to keep the bearings in good conditions during the storage period, the following preservation procedures must be performed:

- Close all the threaded holes with plugs;
- Check if all the flanges (e.g., oil inlet and outlet) are closed. If not, they must be closed with blind covers;

- The oil level must be respected, remaining in the middle of the oil sight glass;
- Every two months, the shaft-locking device must be removed, and the motor rotor must be rotated at least 10 complete turns at 30 rpm to circulate the oil and preserve the internal parts of the bearings.



**ATTENTION**

If the motor has a radial locking device, used for transport, it must be replaced according to item 4.2.2, so that the motor shaft tuning can be performed.



**NOTES**

For bearings that have a high-pressure oil injection system (jacking), this system must be activated before rotating the machine rotor.

For bearings without oil tank (dry crankcase), the oil circulation system must be activated before rotating the machine shaft.

The shaft rotation must always be done in the machine rotation direction.

After six months of storage, the following procedure must be used for protecting both the bearing internally and the contact surfaces against corrosion:

- Close all the threaded holes with plugs;
- Seal the gaps between the shaft and the bearing seal on the shaft by applying water-proof adhesive tape;
- Check if all the flanges (e.g., oil inlet and outlet) are closed. If not, they must be closed with blind covers;
- Remove the upper sight glass from the bearing and apply the corrosion inhibitor spray (TECTYL 511 or equivalent) inside the bearing;
- Close the bearing with the upper sight glass.



**NOTES**

If the bearing has no upper sight glass, the top cover of the bearing must be disassembled to apply the corrosion inhibitor spray.

Each six months of storage, repeat the procedure described above.

If the storage period exceeds two years, the bearing oil must be replaced.

#### 3.3.3.6 Brushes

When the motor is stored for more than two months, the brushes must be lifted and removed from their holder in order to prevent oxidation caused by the contact with the slip rings.



**ATTENTION**

Before putting the motor into operation, the brushes must be put back into their holders and their settlement must be checked.

### 3.3.3.7 Terminal box

When the insulation resistance of the motor windings is measured, the main terminal box and the other terminal boxes must also be inspected, observing the following aspects:

- The inside must be dry, clean and free of any dust accumulation;
- The contact elements cannot present corrosion;
- The seals must be in proper condition;
- The cable inlets must be correctly sealed.



**ATTENTION**

If any of these items are not in proper condition, proceed with adequate maintenance and, if necessary, replace damaged parts.

### 3.3.3.8 Air-water heat exchanger

To ensure better conditions for the radiator storage for long-term storage, the following criteria must be strictly met:

- Remove the flanged connections from the radiator to gain access to it;
- Drain the water inside the radiator tubes and heads completely;
- Blow hot air in one of the nozzles from 15 to 20 minutes in order to eliminate humidity inside of radiator. For this procedure, the radiator tubes shall be horizontally placed, and the inlet and outlet water flanges placed in such a way that the water are eliminated;
- After dried, the nozzles shall be covered with blind flanges with new sealing gaskets in order to assure a perfect sealing;
- Install a pressure gauge on one of the blind flanges and a globe valve on the other;
- Pressurize the cooler with inert gas (Nitrogen or other) at a pressure of 1.2 bar abs;
- This pressure shall be checked monthly during the radiator term storage, which shall not be exposed to temperatures exceeding 50°C;
- Considering that the storage procedure is followed, the radiator seals must be replaced every 3 years, as recommended by the radiator supplier.



**ATTENTION**

The pressurized radiator must be handled with care. Use a warning plate informing that the equipment is pressurized and should not be exposed to temperatures exceeding 50°C.



**NOTE**

During short operation stoppages, instead of draining the water, it is preferable to keep its circulation at low speeds through the heat exchanger, thus ensuring that harmful products, such as ammonia compounds and hydrogen sulfide, are taken out of the radiator and not deposited inside.

### 3.3.3.9 Cleanliness and conservation of the motor during storage

- The motor should be free of oil, water, dust and dirt.
- The motor outside must be cleaned with compressed air under reduced pressure;
- Remove the removable rust signs with a clean cloth soaked in petroleum solvent.
- Check that the bearings and lubrication hollows are free of dust and dirt and if the bearing plugs are properly tightened.

Risks, marks or rust on the shaft-end should be carefully removed.

### 3.3.3.10 Inspections and records during storage

The stored motor must be inspected periodically and inspection records must be filed.

The following items must be inspected:

1. Check the motor for physical damages and repair it, if necessary;
2. Inspection of the cleanliness conditions;
3. Check for signs of water condensation inside the motor;
4. Check of the protective coating conditions of the exposed machined parts;
5. Check the paint conditions, and repair if necessary;
6. Check for aggressive agents signs;
7. Check the operation of the space heaters.
8. Measure and record the temperature, insulation resistance and polarization index of the stator winding;
9. Make sure that the storage location complies with the criteria described in section 3.3.2.1.

### 3.3.3.11 Predictive/preventive maintenance

WEG recommends that, every 3 years of storage, the stored motor be sent to a WEG Authorized Repair Shop or to WEG own factory, in order to perform a complete predictive maintenance.

The complete predictive maintenance procedure comprises disassembling the complete motor for inspection and, after assembly, performing a routine test in the laboratory.

### 3.3.3.12 Maintenance plan during storage

During the storage period, the motor maintenance must be performed and recorded according to the plan described in Table 3.1.

Table 3.1: Storage plan

	Monthly	2 months	6 months	2 years	Before start-up	Notes
<b>STORAGE LOCATION</b>						
Inspect the cleanliness conditions		X			X	
Inspect the humidity and temperature conditions		X				
Inspect for insect infestation signs		X				
<b>PACKAGE</b>						
Inspect for damages			X			
Check the internal relative humidity		X				
Replace the desiccant in the package (if any)			X			Whenever necessary.
<b>SPACE HEATER</b>						
Check the operating conditions	X					
Measure the circuit voltage and frequency	X					
Check the function of the signal system (if any)			X			
<b>WHOLE MOTOR</b>						
Perform external cleaning			X		X	
Check the painting conditions			X			
Check the rust inhibitor on the exposed machined parts			X			
Reapply the rust inhibitor			X			
Inspect the rubber seals and gaskets			X			
Complete predictive maintenance						According to section 3.3.3.11
<b>WINDINGS</b>						
Measure the winding temperature		X			X	
Measure the insulation resistance		X			X	
Measure the polarization index		X			X	
<b>TERMINAL BOX AND GROUNDING TERMINALS</b>						
Clean the interior of the terminal boxes				X	X	
Inspect the seals and gaskets				X	X	
<b>GREASE OR OIL-LUBRICATED ROLLING BEARING</b>						
Rotate the shaft		X				
Relubricate the bearing					X	
Disassemble and clean the bearing						If the storage period exceeds 2 years.
<b>SLEEVE BEARINGS</b>						
Rotate the shaft		X				10 complete turns at 30 rpm
Apply corrosion inhibitor spray			X			
Clean the bearings					X	
Change the oil						If the storage period exceeds 2 years.
<b>BRUSHES</b>						
Lift the brushes						During storage.
Lower the brushes and check the contact with the slip rings					X	

### 3.3.4 Preparation for commissioning

#### 3.3.4.1 Cleaning

- The internal and external parts of the motor must be free of oil, water, dust and dirt.
- Remove the rust inhibitor from the exposed surfaces with a cloth damped in a petroleum-based solvent;
- Make sure that the bearings and cavities used for lubrication are free of dirt and that the cavity plugs are correctly sealed and tightened. Oxidation and marks on the bearing seats and on the shaft must be carefully removed.

#### 3.3.4.2 Bearing inspection



**ATTENTION**

If the motor storage period exceeds six months, the sleeve bearings must be disassembled, inspected and cleaned, before starting the motor operation.

The sleeve bearings without oil tank (dry crankcase), regardless of the motor storage period, should necessarily be disassembled, inspected and cleaned before starting the motor operation.

Reassemble the sleeve bearings and carry out lubrication.

Contact WEG to perform this procedure.

#### 3.3.4.3 Bearing lubrication

Use the lubricant specified for bearing lubrication. Information on the bearings and lubricants are indicated on the bearing nameplates, and the lubrication must be done as described in section 7.13 of this manual, always considering the type of bearing.

#### 3.3.4.4 Brushes, brush holders and slip rings

- Check the conservation conditions of the brush holder and the slip rings;
- Check the connection of the brushes and that they are not stuck into the brush holder. They must be in their original position and establish perfect contact with the slip rings.

#### 3.3.4.5 Insulation resistance verification

Before putting the motor into operation, the insulation resistance must be measured according to section 3.3.3.2 of this manual.

#### 3.3.4.6 Air-water heat exchanger

- When starting the motor, ensure that the water circulates freely through the radiator;
- The radiator bolts should be tightened with torques of 40 to 50Nm;
- Make sure that there is no water leakage. Check the radiator gaskets, and replace if necessary;
- Check the heat exchanger sealing rubbers, and replace them if necessary.

#### 3.3.4.7 Others

Follow the other procedures described in section 6 of this manual before putting the motor into operation.

## 4 INSTALLATION

### 4.1 INSTALLATION SITE

Electric motors must be installed in easily accessible places, allowing periodic inspections, on-site maintenance and, if necessary, removal for external services.

The following environmental conditions must be ensured:

- Clean and well-ventilated location;
- The installation of other equipment or walls must not block or hinder the motor ventilation;
- The area around and above the motor must be sufficient for maintenance or handling;
- The environment must be in accordance with the motor protection degree.

### 4.2 SHAFT LOCK

The motor leaves the factory with a lock on the shaft to prevent damages to the bearings during transportation. This lock must be removed prior to motor installation.



**ATTENTION**

The shaft-locking device must be installed whenever the motor is removed from its base (uncoupled) in order to prevent damages to the bearings during transportation. The shaft end is protected at the factory with a temporary protective agent (rust inhibitor). During the motor installation, it is necessary to remove this product from the grounding brush (if any) contact track on the shaft.

#### 4.2.1 Radial lock

Depending on the bearing type, a locking device may be installed in the upper bearing for radial shaft locking during transportation. This device is identified on the motor with an adhesive label, as shown in Figure 4.1.



**ATTENTION**

BEFORE STARTING THE MACHINE, REPLACE THE RADIAL LOCKING DEVICE BY THE BEARING SEAL WHICH IS SUPPLIED LOOSE.

CHECK THE INSTRUCTIONS IN THE MACHINE INSTALLATION AND MAINTENANCE MANUAL.

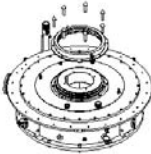

Figure 4.1: Adhesive label

It is imperative that before starting the motor this device is removed and replaced with the original bearing seal which is supplied loose.

#### 4.2.2 Procedure for replacing the radial locking device

1. Remove the fastening screws from the locking device on bearing cap;
2. Remove the screws that attach the two parts of the split device;
3. Remove the locking device as show in Figure 4.2 ;

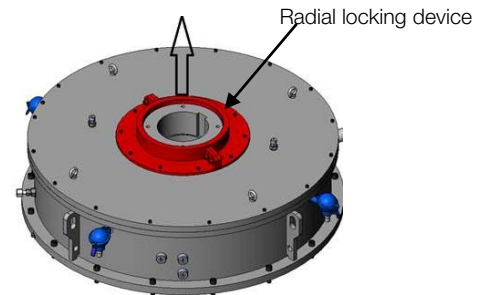

Figure 4.2: Radial locking device

4. Identify the external bearing seal, supplied loose;
5. Fit the seal on bearing, following the disassembling reverse procedure of the locking device.

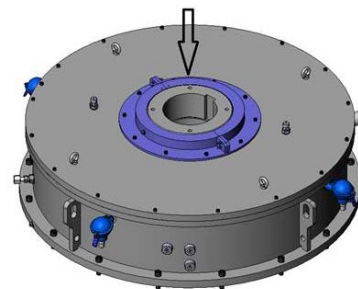



Figure 4.3: Bearing seal



**NOTE**

Store the radial locking device for use in future transport of the motor.

### 4.3 ROTATION DIRECTION

The motor rotation direction is indicated by a plate affixed to the frame on the drive end and in the motor specific documentation.



**ATTENTION**

Motors supplied with a single rotation direction must not operate in the opposite direction. In order to operate the motor in the direction opposite to the specified, consult WEG.

## 4.4 INSULATION RESISTANCE

### 4.4.1 Safety Instructions



**DANGER**

In order to measure the insulation resistance, the motor must be turned off and stopped. The winding being tested must be connected to the frame and grounded until all residual electrostatic charges are removed. Capacitors (if any) must also be grounded before disconnecting and separating the terminals to measure the insulation resistance. Failure to comply with these procedures may result in personal injury.

### 4.4.2 General considerations

When the motor is not immediately put into operation, it must be protected against moisture, high temperatures, and dirt, thus avoiding impacts on the insulation resistance.

The winding insulation resistance must be measured before putting the motor into operation.

If the environment is too humid, the insulation resistance must be measured periodically during storage. It is difficult to establish fixed rules for the actual value of winding insulation resistance, as it varies according to the environmental conditions (temperature, humidity), machine cleanliness conditions (dust, oil, grease, dirt) and quality and condition of the insulating material used.

The evaluation of the periodical follow-up records is useful to conclude whether the motor is able to operate.

### 4.4.3 Measurement on the stator windings

The insulation resistance must be measured with a **megohmmeter**. The testing voltage for the motor windings must be in accordance with Table 4.1 and IEEE43 standard.

Table 4.1: Voltage for the winding Insulation resistance test

Winding rated voltage (V)	Insulation resistance test - continuous voltage (V)
< 1000	500
1000 - 2500	500 - 1000
2501 - 5000	1000 - 2500
5001 - 12000	2500 - 5000
> 12000	5000 - 10000

Before measuring the stator winding insulation resistance:

- Disconnect all connections to the stator terminals;
- Disconnect and insulate all CTs and PTs (if any);
- Ground the motor frame;
- Measure the winding temperature;
- Ground all temperature sensors;
- Check the humidity.

The insulation resistance measurement of the stator windings must be done in the main terminal box.

The megohmmeter must be connected between the motor frame and the winding.

The frame must be grounded and the three phases of the stator winding must remain connected to the neutral point, according to Figure 4.4.

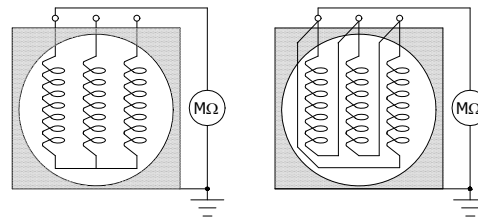

Figure 4.4: Megohmmeter connection

Whenever possible, each phase must be isolated and tested separately. The separate test allows the comparison between the phases. When a phase is tested, the other two phases must be grounded to the same ground of the frame, according to Figure 4.5.

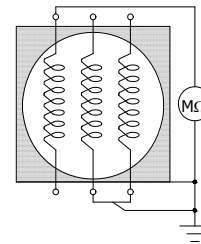



Figure 4.5: Connection of the megohmmeter to separate phases

If the total winding measurement presents a value below the recommended, the neutral connections must be opened and the insulation resistance of each phase must be measured separately.



**ATTENTION**

Much higher values may be frequently obtained from motors in operation for long periods of time. Comparison with values obtained in previous tests on the same motor - under similar load, temperature and humidity conditions - may be an excellent parameter to evaluate the winding insulation conditions, instead of using the value obtained in a single test as the basis. Significant or sudden reductions are considered suspicious.

### 4.4.4 Measurement on the rotor winding

In order to measure the rotor insulation resistance of wound-rotor motors, proceed in the following manner:

- Lift the brushes from the slip rings or remove them from the brush holders;
- The measurement of the rotor winding insulation resistance must be done in the brush compartment;
- The megohmmeter must be connected between the motor shaft and the slip rings;
- The measuring current must not flow through the bearings;
- Measure and record the winding temperature.

#### 4.4.5 Additional Information



**ATTENTION**

After measuring the insulation resistance, ground the tested winding in order to discharge it.

The testing voltage to measure the insulation resistance of the space heater must be 500 Vdc and for the other accessories, 100 Vdc. It is not recommended to measure the insulation resistance of thermal protectors.

#### 4.4.6 Polarization Index

The polarization index is defined by the ratio between the insulation resistance measured in 10 minutes and the insulation resistance measured in 1 minute. This measurement procedure is always carried out at relatively constant temperatures.

The polarization index allows the assessment of the motor insulation conditions.



**DANGER**

In order to avoid accidents, the winding must be grounded immediately after measuring the insulation resistance.

#### 4.4.7 Conversion of the measured values

The insulation resistance must be measured at 40°C. If the measurement is performed at a different temperature, it is necessary to correct the reading to 40°C by using a curve of the insulation resistance variation as a function of the temperature, obtained at the motor itself. If this curve is not available, the approximate correction provided by the curve in Figure 4.6, according to NBR 5383 / IEEE43 standard, may be used.

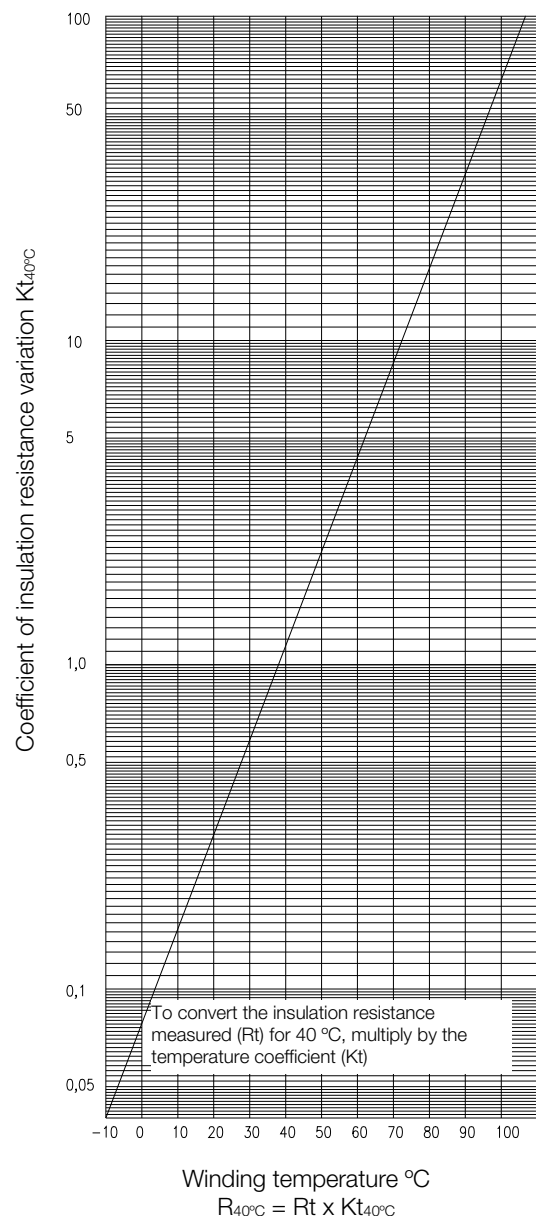

Figure 4.6: Insulation resistance variation coefficient according to the temperature

#### 4.4.8 Insulation assessment

Table 4.2 and Table 4.3 present guiding limits of insulation resistance and polarization index for the assessment of the motor insulation conditions.

Table 4.2: Insulation resistance guiding limits on electrical machines

Insulation resistance value	Insulation assessment
2 MΩ or lower	Unacceptable
< 50 MΩ	Dangerous
50...100 MΩ	Fair
100...500 MΩ	Good
500...1000 MΩ	Very Good
> 1000 MΩ	Excellent

Table 4.3: Polarization index (ratio between 10 minutes and 1 minute)

Polarization Index	Insulation assessment
1 or lower	Unacceptable
< 1.5	Dangerous
1.5 to 2.0	Fair
2.0 to 3.0	Good
3.0 to 4.0	Very Good
> 4.0	Excellent

**ATTENTION**

If the measured insulation resistance, referred to 40 °C, is below 100 MΩ or the polarization index is below 2, than before putting the motor into operation, consult WEG.

## 4.5 PROTECTIONS

Motors used in continuous duty must be protected against overloads by means of a motor integral device, or an independent protection device, which is generally a thermal relay with rated or adjustable current equal to or below the value obtained by multiplying the full load motor supply current by:

- 1.25 for motors with service factor equal to or above 1.15;
- 1.15 for motors with service factor equal to 1.0.

Motors also have protection devices against overheating (in cases of overloads, locked rotor, low voltage, lack of motor ventilation).

### 4.5.1 Thermal protections

The temperature sensors are installed on the main stator, bearings and other parts that require temperature monitoring and thermal protection. These sensors must be connected to an external temperature monitoring and protection system.

#### 4.5.1.1 Temperature sensors

**Thermostats** – Are bimetallic thermal detectors with normally closed silver contacts. They open at a certain temperature. The thermostats are connected in series or independently according to the connection diagram.

**Thermistors (PTC or NTC)** – Are thermal detectors composed of semiconductors that vary their resistance sharply when they reach a certain temperature. Thermistors are connected in series or independently according to the connection diagram.

**NOTE**

Thermostats and thermistors must be connected to a control unit in order to interrupt the power supply to the motor or activate a signaling device.

**RTDs (Pt100)** - Are calibrated resistance elements. Their operation is based on the principle that the electrical resistance of a metallic conductor varies linearly with the temperature. The detector terminals must be connected to a control panel which includes a temperature meter.



**NOTE**

Resistance temperature detectors (RTD) allow the monitoring via the absolute temperature informed through their instantaneous resistance value. With this information the relay, which may be programmed for alarm and trip according to pre-defined values, is able to perform the temperature reading.

### 4.5.1.2 Temperature limits for the windings

The temperature of the hottest spot of the winding must be kept below the limit of the insulation thermal class. The total temperature is obtained by the sum of the ambient temperature and the temperature rise (T), plus the difference between the average temperature of the winding and the hottest spot of the winding.

The ambient temperature must not exceed 40 °C, in accordance with NBR IEC60034-1 standard. Above this temperature, the working conditions are considered special and the motor specific documentation must be consulted.

Table 4.4 shows the numerical values and the composition of the acceptable temperature at the hottest spot on the winding.

Table 4.4: Insulation class

Insulation class		F	H
Ambient temperature	°C	40	40
T = temperature rise (temperature measurement method by resistance variation)	°C	105	125
Difference between the hottest spot and the average temperature	°C	10	15
Total: temperature of the hottest point	°C	155	180



**ATTENTION**

If the motor operates with winding temperatures above the limits of the insulation thermal class, the lifespan of the insulation, and hence that of the motor, will be significantly reduced, or it may even result in the motor burnout.



### 4.5.1.3 Alarm and trip temperatures

The motor alarm and trip temperatures must be set at the lowest possible value. These temperatures can be determined based on the factory tests or through the motor operating temperature. The alarm temperature can be set 10 °C above the machine operating temperature at full load, always considering the highest ambient temperature on site. The adjusted trip temperatures must not exceed the maximum admissible temperatures for the stator winding insulation class and for the bearings (considering the lubrication type and system), according to Table 4.5.

Table 4.5: Maximum temperature settings

	Maximum temperature settings for protections (°C)	
	Alarm	Tripping
Winding class F	130	155
Winding class H	155	180
Bearings	110	120



#### ATTENTION

The alarm and trip values may be determined as a result of experience, but they must not exceed the values indicated in Table 4.5.



#### ATTENTION

The motor protection devices are listed in the WEG drawing – Connection diagram. Not using these devices is the sole responsibility of the user and, in case of damage to the motor, it will void the warranty.

#### 4.5.1.4 Temperature and ohmic resistance of the PT100 thermoresistance

Table 4.6 shows the temperature as a function of the ohmic resistance measured across PT100 RTDs.

Formula:  $\frac{\Omega - 100}{0.386} = \text{°C}$

Table 4.6: Temperature X Resistance (Pt100)

°C	0	1	2	3	4	5	6	7	8	9
0	100.00	100.39	100.78	101.17	101.56	101.95	102.34	102.73	103.12	103.51
10	103.90	104.29	104.68	105.07	105.46	105.95	106.24	106.63	107.02	107.40
20	107.79	108.18	108.57	108.96	109.35	109.73	110.12	110.51	110.90	111.28
30	111.67	112.06	112.45	112.83	113.22	113.61	113.99	114.38	114.77	115.15
40	115.54	115.93	116.31	116.70	117.08	117.47	117.85	118.24	118.62	119.01
50	119.40	119.78	120.16	120.55	120.93	121.32	121.70	122.09	122.47	122.86
60	123.24	123.62	124.01	124.39	124.77	125.16	125.54	125.92	126.31	126.69
70	127.07	127.45	127.84	128.22	128.60	128.98	129.37	129.75	130.13	130.51
80	130.89	131.27	131.66	132.04	132.42	132.80	133.18	133.56	133.94	134.32
90	134.70	135.08	135.46	135.84	136.22	136.60	136.98	137.36	137.74	138.12
100	138.50	138.88	139.26	139.64	140.02	140.39	140.77	141.15	141.53	141.91
110	142.29	142.66	143.04	143.42	143.80	144.17	144.55	144.93	145.31	145.68
120	146.06	146.44	146.81	147.19	147.57	147.94	148.32	148.70	149.07	149.45
130	149.82	150.20	150.57	150.95	151.33	151.70	152.08	152.45	152.83	153.20
140	153.58	153.95	154.32	154.70	155.07	155.45	155.82	156.19	156.57	156.94
150	157.31	157.69	158.06	158.43	158.81	159.18	159.55	159.93	160.30	160.67

#### 4.5.1.5 Space heater

When the motor is equipped with a space heater to prevent internal water condensation during long periods out of operation, it must be assured that the space heater is energized shortly after turning the motor off, and that it is de-energized before the motor is put into operation.

The values of the space heater supply voltage and power are informed in the connection diagram and in the specific plate affixed to the motor.

#### 4.5.2 Water leak sensor

Motors with air-water heat exchangers are supplied with a water leak sensor intended to detect accidental water leaks from the radiator into the motor. This sensor must be connected to the control panel, according to the motor connection diagram. The signal of this sensor must be used to activate the alarm.

When this protection actuates, the heat exchanger must be inspected and, if any water leak is detected, the motor must be shut down and the problem corrected.

## 4.6 COOLING

The motor cooling system type may vary according to its application. Only the correct installation of the motor and of the cooling system can ensure its continuous operation without overheating.



### ATTENTION

The protection devices of the cooling system must be monitored periodically. The air and/or water inlets and outlets must not be obstructed, because this could cause overheating and even lead to the motor burnout. For further details, refer to the motor dimensional drawing.

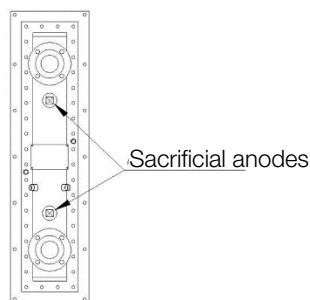

Figure 4.7: Radiator with sacrificial anodes



### NOTE

The type, quantity and position of the sacrificial anodes may vary according to the application.

### 4.6.1 Air-water heat exchange cooling

In motors with air-water heat exchanger, the internal air, in a closed circuit, is cooled by the radiator, which is a surface heat transmitter designed to dissipate heat. Clean water with the following characteristics must be used as coolant:

- pH: 6 to 9;
- Chlorides: maximum 25.0 mg/l;
- Sulphates: maximum 3.0 mg/l;
- Manganese: maximum 0.5 mg/l;
- Suspended solids: maximum 30.0 mg/l;
- Ammonia: without ammonia dashes.



### ATTENTION

Data of the radiators that compose the air-water heat exchanger are informed on their nameplate and on the motor dimensional drawing. This data must be observed for the proper operation of the motor cooling system, thus preventing overheating.

### 4.6.2 Independent ventilation cooling

The **independent fans** are driven by three-phase asynchronous motors with integral terminal boxes. The characteristic data (frequency, voltage, etc.) are on the nameplate of these motors, and the rotation direction is indicated by a plate affixed to the fan housing or close to it.



### NOTE

It is necessary to check the rotation direction of the independent ventilation motors before putting them into operation. If the rotation direction is opposite to the specified, invert the connection of two of their power supply phases.

#### 4.6.1.1 Radiators for application with seawater



### ATTENTION

In the case of radiators for applications with seawater, the materials in contact with the water (pipes and plates) must be corrosion resistant. Furthermore, the radiators may be fitted with sacrificial anodes (e.g., zinc or magnesium), as shown in Figure 4.7, which are corroded during the heat exchanger operation, protecting the radiator heads. In order to maintain the integrity of the radiator heads, these anodes must be replaced periodically according to their corrosion level.

The **air filters** (if any), which prevent the ingress of dirt into the motor, must be regularly inspected according to the section "Maintenance Plan" of this manual. The filters must be in perfect condition to ensure the correct operation of the cooling system and the continuous protection of the motor sensitive internal parts.

## 4.7 ELECTRICAL ASPECTS

### 4.7.1 Electrical connections



#### ATTENTION

Analyze the electrical connection diagram supplied with the motor carefully before beginning the connection of the main cables and those of the accessories. For the electrical connection of auxiliary equipment, refer to their specific manuals.

#### 4.7.1.1 Main electrical connections

The locations of power, neutral and rotor terminal boxes are identified in the specific dimensional drawing of the motor.

The stator and rotor terminal identifications and their corresponding connections are indicated in the specific motor connection diagram.

Make sure the cross section and insulation of the connection cables are suitable for the motor current and voltage.

The motor must rotate in the rotation direction specified on the nameplate and on the sign plate affixed to the motor.



#### NOTE

The rotation direction is, by convention, determined looking to the shaft end at the motor drive end.

Motors with a single rotation direction must only rotate in the indicated direction, since fans and other devices are unidirectional. In order to operate the motor in the rotation direction opposite to the specified, consult WEG.



#### ATTENTION

Before making the connections between the motor and the power supply, it is necessary to perform a careful measurement of the winding insulation resistance.

In order to connect the motor main power supply cables, unscrew the cover of the stator terminal box, cut the sealing rings (standard motors without cable gland) according to the diameter of the cables to be used and insert the cables in the sealing rings. Cut the power supply cables to the necessary length, strip the ends and mount the cable lugs that will be used.

### 4.7.1.2 Grounding

The motor frame and the main terminal box must be grounded before connecting the motor to the supply system.

Connect the metallic sheath of the cables (if any) to the common grounding conductor. Cut the grounding conductor to the proper length and connect it to the terminal in the terminal box and/or on the frame.

Fasten all connections firmly.



#### ATTENTION

Do not use washers made of steel or other materials with low electrical conductivity to fasten the cable lugs.

## 4.7.2 Connection diagrams

### 4.7.2.1 Connection diagrams according to IEC60034-8

The following connection diagrams show the terminal identification in the terminal box and the possible connections for the motors.

#### 4.7.2.1.1 Stator connection diagrams

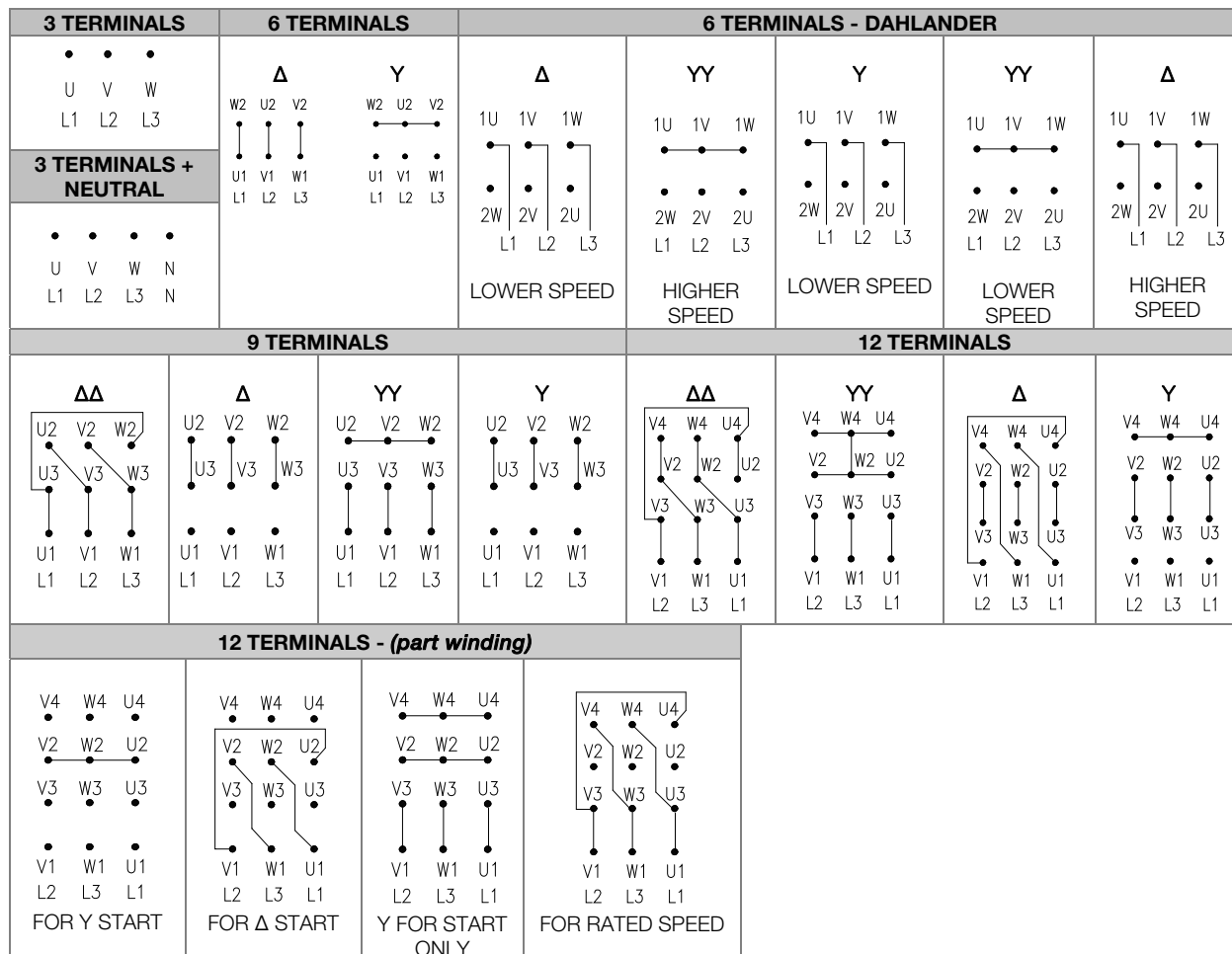

#### NOTE

When two or more motor connecting cables are used in parallel in order to divide the electric current, the identification of these cables is made with an additional suffix separated by a hyphen, according to Figure 4.8.

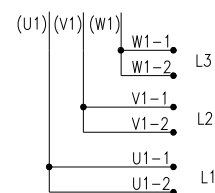
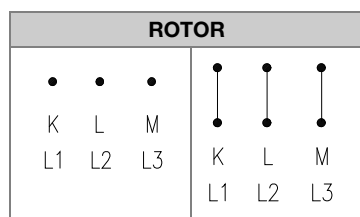

Figure 4.8: Parallel connections

#### 4.7.2.1.2 Rotor connection diagrams



### 4.7.2.2 Connection diagrams according to NEMA MG1

#### 4.7.2.2.1 Stator connection diagrams

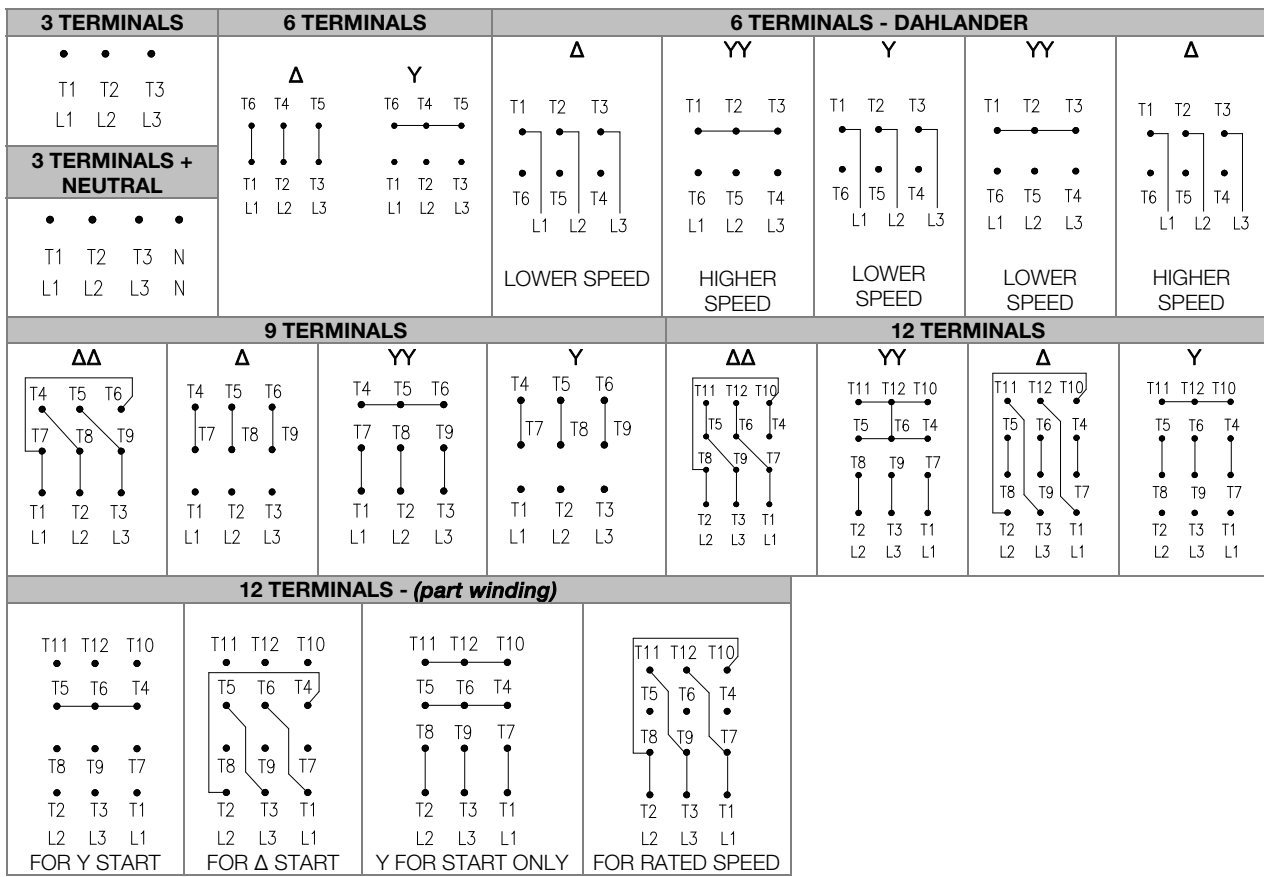

#### NOTE

When two or more motor connecting cables are used in parallel in order to divide the electric current, the identification of these cables is made with an additional suffix separated by a hyphen, according to Figure 4.9.

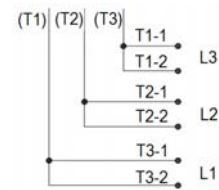
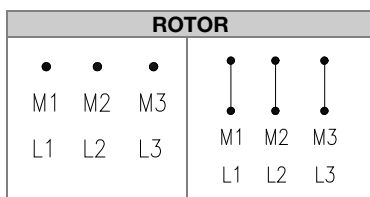

Figure 4.9: Parallel connections

#### 4.7.2.2.2 Rotor connection diagrams



#### 4.7.2.3 Rotation direction

- The rotation direction is indicated on the nameplate and must be observed looking to the shaft end at the motor drive end. The rotation direction must be checked before coupling the motor to the driven machine;
- Motors with terminal identification and connections as described in this manual have clockwise rotation direction, according to IEC60034-8 standard;
- In order to invert the rotation direction, it is necessary to swap any two phases;
- Motors with a single rotation direction, as indicated on the nameplate and on sign plate affixed to the frame, have unidirectional fan and must be operated only in the specified rotation direction. In order to invert the rotation direction of unidirectional motors, consult WEG.

#### 4.7.2.4 Accessory connection diagrams

For the correct installation of the accessories, refer to the drawing in the specific connection diagram of the motor.

### 4.7.2.5 Motorized brush holder connection diagram

The following connection diagrams show the terminals in the terminal box and the connections of the motorized brush lifting system for wound-rotor motors equipped with this device.

#### 4.7.2.5.1 Condition for starting with lowered brushes and non-short-circuited slip rings

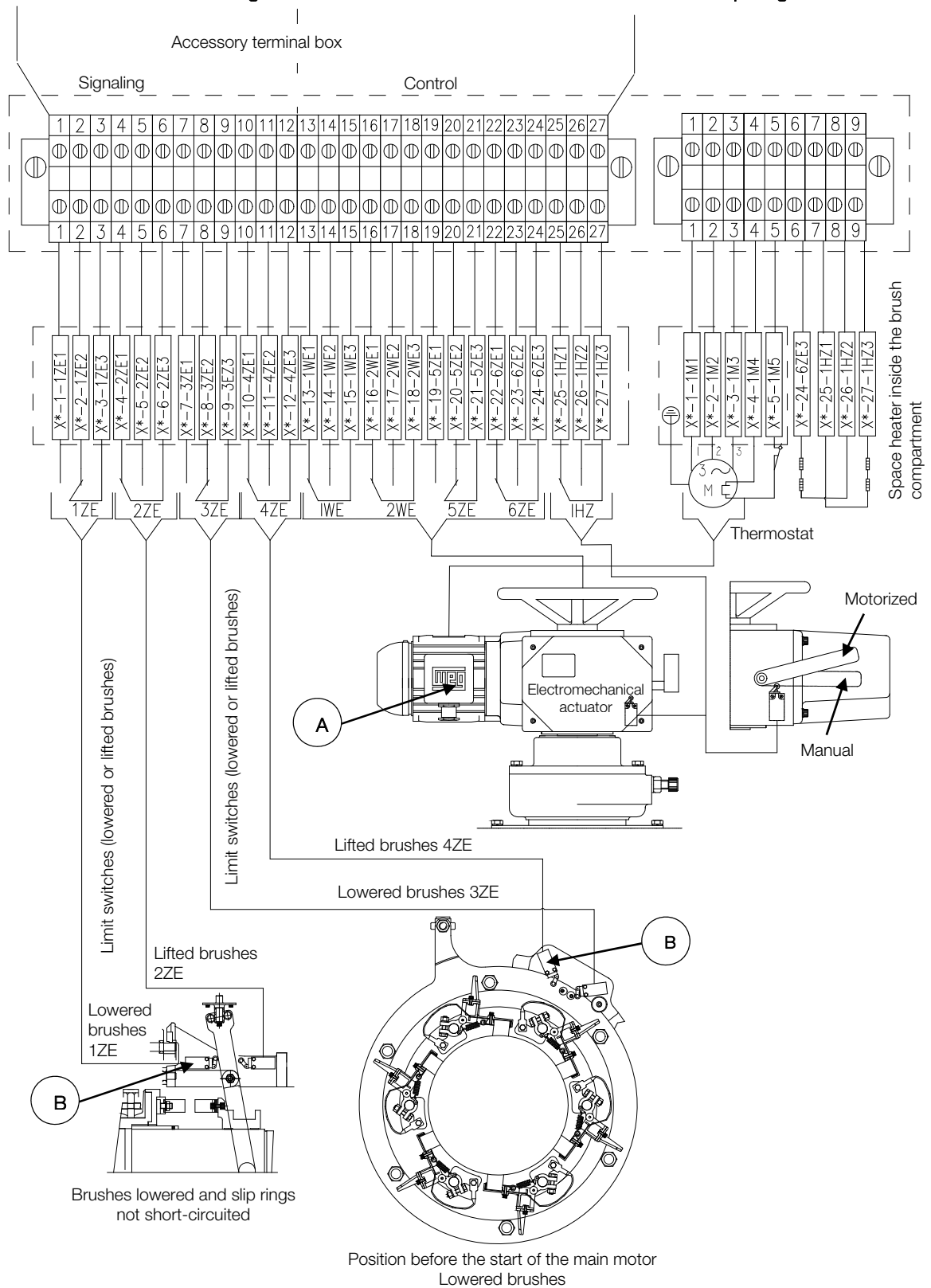

**Component description:**

- A. Three-phase motor – IEC frame 71 – 6 poles, 0.25 kW – F.C. B3E - IPW55 - flange C105 - DIN 42948. Voltage and frequency according to the customer’s request.
- B. Limit switch with double insulation.

4.7.2.5.2 Condition for operation with lifted brushes and short-circuited slip rings

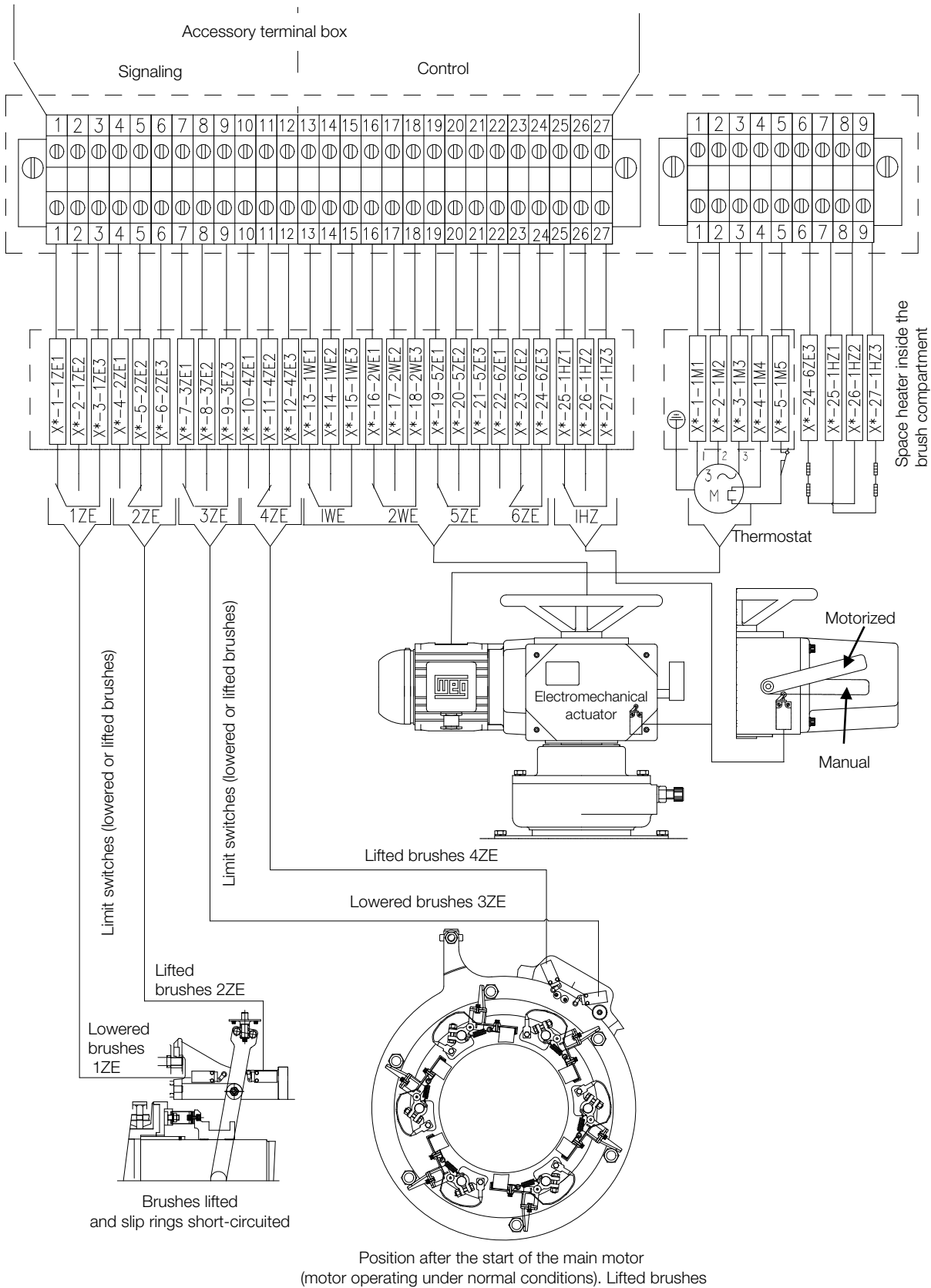



### 4.7.2.5.3 Motorized brush holder operation logic

#### MOTORIZED OPERATION:

##### 1. Condition for starting with lowered brushes and non-short-circuited slip rings

In order to ensure the brushes are lowered, and the slip rings are not short-circuited, the switches:

- **1ZE** - contacts 3 and 2;
  - **3ZE** - contacts 8 and 9;
  - **5ZE** - contacts 20 and 21
- must be closed.

When the electromechanical actuator is activated, the limit switch **5ZE**, located in the electromechanical actuator itself, positions the brushes correctly at the starting position (lowered brushes), whereas the **1ZE** and **3ZE** signaling switches, installed inside the brush compartment, confirm this condition.

With this logic, the motor is able to start.

##### 2. Condition for operation with the brushes lifted and short-circuited slip rings

In order to ensure that the brushes are lifted and the slip rings are short-circuited, the switches:

- **2ZE** - contacts 6 and 5;
  - **4ZE** - contacts 12 and 11;
  - **6ZE** - contacts 24 and 23
- must be closed.

When the electromechanical actuator is activated for lifting the brushes, the limit switch **6ZE**, located in the electromechanical actuator itself, correctly positions the brushes at the lifted position, whereas the **2ZE** and **4ZE** signaling switches, installed inside the brush compartment, confirm this condition.

With this logic, the motor is able to operate in continuous duty.

#### SYMBOLOLOGY:

**1WE** = Torque switch for shutdown in case of overload while lowering the brushes (or phase inversion).

If there is fault in **5ZE**.

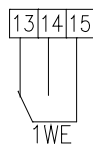

**2WE** = Torque switch for shutdown in case of overload while lifting the brushes (or phase inversion).

If there is fault in **6ZE**.

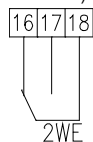

**5ZE** = Limit switch of the electromechanical actuator to indicate when the brushes are fully lowered.

**6ZE** = Limit switch of the electromechanical actuator to indicate when brushes are fully lifted.

**1HZ** = Selector switch indicating manual or motorized position.

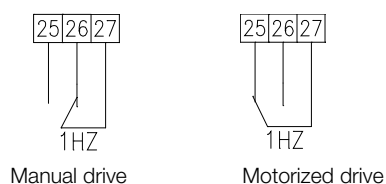

### LIMIT SWITCHES FOR SIGNALING

**2ZE** and **4ZE** = Limit switch to indicate when the brushes are fully lifted.

**1ZE** and **3ZE** = Limit switch to indicate when brushes are fully lowered.



#### ATTENTION

**2ZE**, **4ZE**, **1ZE** and **3ZE** are signaling switches indicating if the brushes are lowered or lifted, and, therefore, must not be used to command (turn on/off) the electromechanical actuator.

### 4.7.2.5.4 Manual operation

When it is not possible to operate the motorized brush lifting system, the user can operate it manually. Refer to the section **5.2.3** for details on the manual operation.

## 4.8 MECHANICAL ASPECTS

### 4.8.1 Foundations

- The foundation or structure where the motor will be installed must be sufficiently rigid, flat, free of external vibration and capable to withstand the mechanical loads to which it will be submitted;
- If the dimensioning of the foundation is not carefully executed, this may cause vibration in the foundation, on the motor and the driven machine;
- The foundation structural design must be done based on the dimensional drawing, on the information about foundation mechanical loads, and on the motor anchoring method.



#### ATTENTION

Place shims of different thicknesses between the motor supporting surfaces and the foundation in order to allow a precise alignment.



#### NOTE

The user is responsible for dimensioning and building the foundation where the motor will be installed.

### 4.8.2 Foundation loads

The foundation loads are informed in the motor documentation.

### 4.8.3 Motor mounting

Mount the motor securely, and align it correctly with the driven machine, according to the mounting types described next:

1. **Motor mounted directly on the driven machine:** the two units must be firmly coupled, and the driven machine must be installed on a proper base;
2. **Motor mounted on a metal base:** The base must be rigid enough and free of vibration.



**ATTENTION**  
Improper mounting can generate excessive vibration, causing early wear of the bearings and even breaking the shaft.

#### 4.8.3.1 Motor with solid shaft and flange

In order to mount the motor on the driven machine, proceed as follows:

1. Lift the motor by the upper lifting lugs, and rotate it to position the grease fittings, pipes and terminal boxes properly;
2. Clean the flanges to be coupled;
3. Remove the motor shaft locking device;
4. Move the motor towards the driven machine, fitting the motor flange on the machine flange;
5. Insert the bolts for fixing the flanges and tighten them with adequate torque;
6. Couple the motor shaft to the driven machine;
7. Rotate the shaft of the set to ensure that it rotates freely;
8. Align the equipment according to the procedure described in this manual;
9. Tighten all the fastening bolts of the flanges, avoiding their bending or loosening;
10. Rotate the shaft of the set again.

#### 4.8.3.2 Motor with hollow shaft and flange

First the motor must be fastened to its base and the driven machine shaft inserted through the motor hollow shaft.

In some cases, it may be necessary that the motors be lifted and lowered onto the driven machine shaft. Those procedures must be done with the necessary precautions in order to avoid damaging the motor shaft or the driven machine shaft.

**Proceed as follows:**

1. Remove the protection cover of the upper coupling, and lift the motor with the hoist to install it on the base;
2. Lower the motor slowly and carefully, fitting it on the base;
3. Position the motor in order to allow access to the terminal boxes and for the lubrication of the bearings. Install the fastening bolts and tighten them;
4. Insert the pump shaft into the motor hollow shaft;
5. Align the motor shaft with the driven machine shaft, according to the procedure described in this manual;
6. Fasten the pump shaft to the coupling and adjust the fastening nut of the pump shaft;
7. Rotate the shaft manually to make sure it rotates freely and that the shafts are perfectly aligned, always observing the rotation direction of the anti-reversion ratchet (if any);
8. After aligning, tighten all the flange bolts evenly;
9. Rotate the shaft again manually to make sure it rotates freely.
10. Reinstall the cover of the upper coupling.

#### 4.8.4 Anchor plate set

The anchor plate set, when used, is composed of the anchor plate, leveling bolts, leveling shims, alignment bolts and anchor bolts.



**NOTES**  
When WEG supplies the anchor plate for fastening and aligning the motor, the dimensional and installation details of the anchor plate are supplied in the specific dimensional drawing of the motor.  
  
The user is responsible for mounting, leveling and grouting the anchor plates (except when otherwise specified by commercial agreement).

The anchor bolts must be fastened according to Table 4.7.

Table 4.7: Tightening torque of the anchor bolts

Type Ø	Dry tightening torque [Nm]	Tightening torque with Molycote [Nm]
M30	710	470
M36	1230	820
M42	1970	1300
M48	2960	1950

After positioning the motor, perform the final leveling using the vertical leveling bolts and the leveling shims.



**ATTENTION**  
Protect all the threaded holes to prevent grout from penetrating the threads during the grouting of the anchor plate and anchor bolts.

#### 4.8.5 Natural frequency of the base

In order to ensure a safe operation, the motor must be precisely aligned with the coupled equipment and both must be properly balanced.

As a requirement, the motor installation base must be flat and meet the requirements of DIN 4024-1 standard.

In order to verify if the criteria of the standard are being met, the following potential vibration excitation frequencies generated by the motor and coupled machine must be checked:

- The motor rotation frequency;
- The double of the rotation frequency;
- The double of the motor electric frequency.

According to DIN 4024-1 standard, the natural frequencies of the base or foundation must be away from these potential excitation frequencies, as specified next:

- The first natural frequency of the base or foundation (first order natural frequency of the base) must be out of the range from 0.8 to 1.25 times any of the potential excitation frequencies above;
- The other natural frequencies of the base or foundation must be out of the range from 0.9 to 1.1 times any of the potential excitation frequencies above.

#### 4.8.6 Leveling

The motor must rest on a surface with flatness of up to 0.08 mm/m. Verify whether the motor is perfectly leveled, both in the vertical and horizontal planes. Make the proper adjustments by placing shims under the motor. The motor leveling must be checked with proper equipment.



**NOTE**  
At least 75% of the motor foot support surfaces must rest on the motor base.

#### 4.8.7 Alignment

The motor must be correctly aligned with the driven machine.



**ATTENTION**  
Incorrect alignment can damage the bearings, generate excessive vibration and even break the shaft.

The alignment must be done according to the coupling manufacturer recommendations. The motor and driven machine shafts must be aligned in the axial and radial directions, as shown in Figure 4.10 and Figure 4.11.

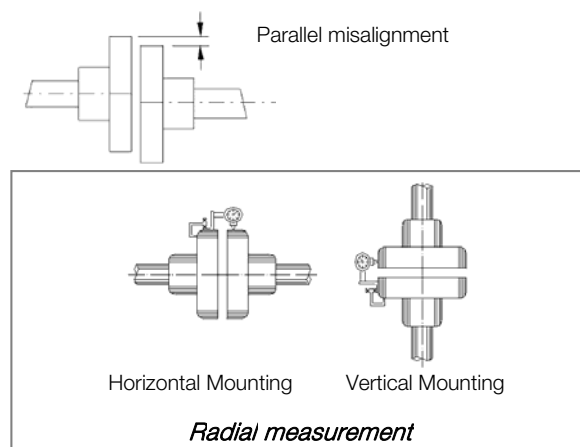

Figure 4.10: Parallel alignment

Figure 4.10 shows the parallel misalignment of the two shaft ends and the practical way to measure it by using suitable dial gauges. The measurement is performed in four points 90° away from each other with the two half-couplings rotating together in order to eliminate effects of support surface irregularities on the dial gauge tip. Choosing the upper vertical point as 0°, half of the difference between the dial gauge measurements at the 0° and 180° points represents the vertical coaxial error. In case of deviation, it must be corrected by adding or removing leveling shims. Half of the difference between the dial gauge measurements at the 90° and 270° points represents the horizontal coaxial error. These measurements indicate when it is necessary to lift or lower the motor, or move it to the right or to the left on the drive end in order to eliminate the coaxial error.

Half of the maximum difference among the dial gauge measurements in a complete rotation represents the maximum eccentricity found. The misalignment in a complete shaft rotation, with rigid or semiflexible coupling, cannot exceed 0.03 mm. When flexible couplings are used, greater values than those indicated above are acceptable, provided that they do not exceed the value allowed by the coupling manufacturer. It is recommended to keep a safety margin for these values.

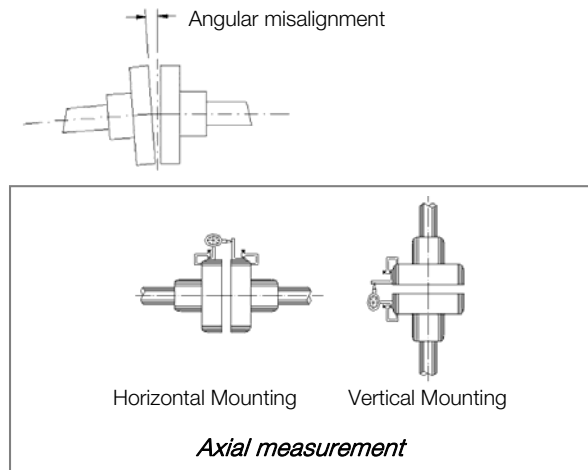

Figure 4.11: Angular alignment

Figure 4.11 shows the angular misalignment and a practical form to measure it. The measurement is done in four points 90° away from each other, with the two half-couplings rotating together in order to eliminate effects of support surface irregularities on the dial gauge tip. Choosing the upper vertical point as 0°, half of the difference between the dial gauge measurements at the 0° and 180° points represents the vertical misalignment. In case of deviation, it must be corrected by adding or removing alignment shims. Half the difference between the dial gauge measurements at the 90° and 270° points represents the horizontal misalignment, which must be properly corrected by displacing the motor in the lateral/angular direction. Half of the maximum difference among the dial gauge measurements in a complete rotation represents the maximum angular misalignment found. The misalignment in a complete shaft rotation, with rigid or semiflexible coupling, cannot exceed 0.03 mm. When flexible couplings are used, greater values than those indicated above are acceptable, provided that they do not exceed the value allowed by the coupling manufacturer. It is recommended to keep a safety margin for these values. **In the alignment/leveling, the influence of the temperature on the motor and the driven machine must be taken into account. Different expansions of the parts may change the alignment/leveling conditions during operation.**

### 4.8.8 Hollow shaft motor alignment

Motors with hollow shaft require an exact alignment of the motor shaft with the driven machine shaft. The pump shaft works as a pendulum supported by the upper coupling and the motor bearing.

1. Fix the dial gauge by its magnetic base to the pump shaft and align it with the base surface (motor shaft), setting the dial gauge to zero (Figure 4.12);
2. Remove the upper cover and rotate both motor and pump shafts;
3. Read the dial gauge at 90 degrees from the starting point;
4. An acceptable alignment occurs when the dial gauge reading does not exceed 0.05 mm;
5. Use shims between the motor flange surface and the base to correct the alignment, if necessary.

Small misalignments can be corrected by inserting shims between the faces of the motor and driven machine flanges. These shims can also compensate flanges that are not flat.

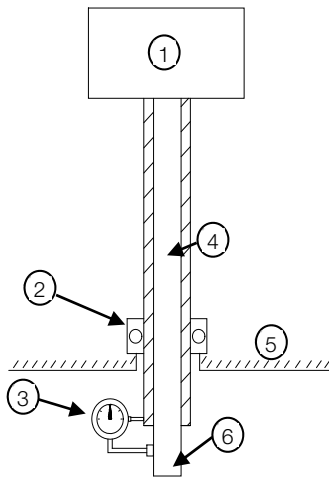

Figure 4.12: Alignment of motors with hollow shaft

**Figure 4.12 legend:**

1. Upper bearing
2. Lower guide bearing
3. Dial gauge
4. Motor hollow shaft
5. Flange
6. Pump shaft

### 4.8.9 Doweling

After aligning the set and having assured a perfect alignment (**both, hot and cold**), the motor must be doweled to the anchor plate or to the base, as shown in Figure 4.13.

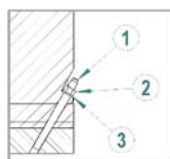

Figure 4.13: Dowel pin set

**Figure 4.13 legend:**

1. Dowel pin (optional supply)
2. Nut (optional supply)
3. Washer (optional supply)



**NOTE**

For the doweling, the motor has a pre-hole with  $\varnothing 9$  mm, which must be first expanded to  $\varnothing 11.5$  mm, and then reamed to  $\varnothing 12$  mm with a taper of 1:50.

### 4.8.10 Couplings

Only proper couplings, which convey only torque without generating transversal forces, must be used.

For both flexible and rigid couplings, the shaft centers of the coupled machines must be in a single line.

Flexible couplings mitigate the effects of residual misalignments and prevent transmission of vibration between the coupled machines, which does not occur when rigid couplings are used.

The coupling must be mounted or removed with the aid of proper devices and never by means of rudimentary tools, such as hammers, sledgehammers, etc.



**ATTENTION**

Dowel pins, nuts, washers and leveling shims may be supplied with the motor, when requested in the purchase order.



**NOTES**

The user is responsible for the motor installation (unless otherwise specified by commercial agreement).

WEG is not liable for damages to the motor, associated equipment and installation occurred because of:

- Transmission of excessive vibration;
- Poor installations;
- Faulty alignment;
- Improper storage conditions;
- Noncompliance with the instructions before start-up;
- Incorrect electrical connections.

#### 4.8.10.1 Direct coupling

Because of issues about cost, space economy, problems with belt sliding and more safety against accidents, direct coupling must be used whenever possible. Also, direct coupling is preferable in case of transmission with reduction gearing.



**ATTENTION**

Align the shaft ends carefully, and, whenever possible, use flexible coupling, leaving a minimum clearance (E) of 3 mm between the couplings, as shown in Figure 4.14.

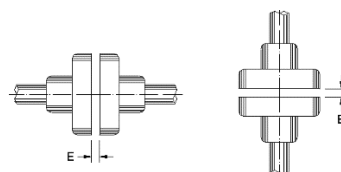

Figure 4.14: Axial clearance of the coupling (E)

#### 4.8.10.2 Gear coupling

Gear couplings badly aligned generate vibration in the transmission itself and in the motor. Therefore, caution must be taken so that the shafts be perfectly aligned, rigorously parallel in case of spur gear transmissions and in a correct angle in case of transmissions by bevel or helical gears.

The gear teeth meshing can be controlled with the insertion of a paper strip, on which the trace of all teeth shows up after a gear turn.

#### 4.8.10.3 Belt drive

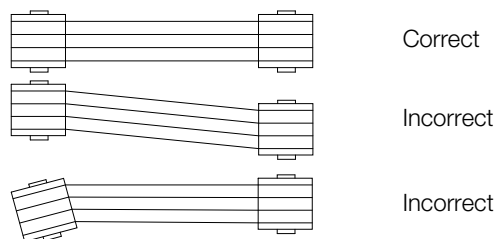



Figure 4.15: Belt drive

When a reduction or increase in speed is required, the belt transmission is the most indicated. In order to avoid unnecessary stress on the bearings, the shafts and the pulleys must be perfectly aligned. Belts that operate obliquely transmit alternating jolts to the rotor and will be able to damage the bearings. Belt slippage can be prevented by applying a resin like material, such as pitch for instance. The belt tension must be just enough to prevent slippage during operation.



**NOTE**  
Belts too tensioned increase the load on the shaft end, causing vibration and fatigue, or even the break of the shaft.

Avoid using too small pulleys, since they cause flexion of the motor shaft because of the belt traction force that, which increases as the diameter of the pulley decreases.



**ATTENTION**  
Consult WEG for the correct sizing of the pulley.



**NOTE**  
Always use properly balanced pulleys. Avoid extra key lengths, because they increase the unbalancing mass and increase the motor vibration.

#### 4.8.10.4 Coupling for hollow shaft motors

Vertical hollow shaft motors are generally designed to drive deep water pumps or turbine pumps. The type of coupling is specified by the manufacturer of the pump according to the application. Remove the motor top cover to access the coupling.

### 4.9 HYDRAULIC UNIT

For further information on installation, operation and maintenance of the hydraulic unit (if any), refer to the motor dimensional drawing and the specific manual of this equipment.

## 5 STARTING

### 5.1 STARTING WITH RHEOSTAT

The starting of wound-rotor motor must be performed with an external rheostat connected to the rotor circuit through the set of brushes and slip rings.

The function of the starting rheostat is to reduce the starting current and increase the motor starting torque. As the motor speed increases, the rheostat must gradually decrease its resistance until reaching the lowest possible value, and then it must be short-circuited when the motor begins to operate at its rated duty. It is also possible to set the rheostat to obtain the starting torque equal or close to the value of the motor maximum torque. An exception is made when special rheostats are used to vary the motor speed. In this case, the rheostats are designed to remain permanently connected to the motor and vary their resistance within predetermined values.

### 5.2 STARTING OF MOTORS WITH MOTORIZED BRUSH HOLDER

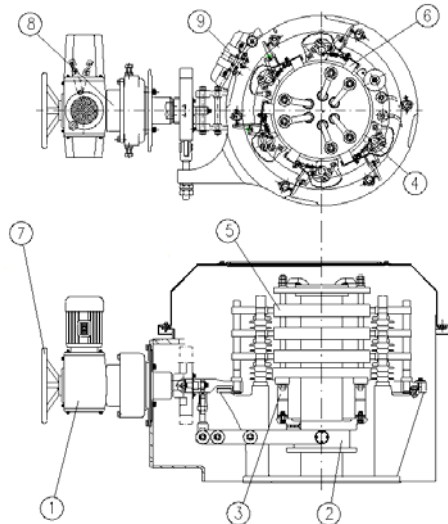

Figure 5.1: Device for lifting the brushes

#### 5.2.1 Conditions for motor starting

In addition to the regular motor starting procedures, the brush lifting system must obey the following activation sequence:

1. The external rheostat must be set to the maximum resistance value;
2. The rheostat short-circuiting circuit breaker must be opened;
3. The rotor short-circuit contacts must be opened, confirmed by the closing of the limit switch **1ZE**;
4. The brushes must be lowered, confirmed by the closing of the limit switch **3ZE** (9);
5. The electromechanical actuator (1) must be in the motor starting position, confirmed by the limit switch **5ZE**;
6. Neither of the torque limit switches, **1WE** or **2WE**, must be actuated;
7. The correct system positioning before starting the motor can be performed by the motorized command by the activation of the electromechanical actuator (1).

#### 5.2.2 After starting

When the motor reaches its rated speed, the slip rings must be short-circuited and the brushes lifted through the drive of the electromechanical actuator (1), which must observe the following sequence:

1. The external starting rheostat must be at its minimum resistance value;
2. Close the short-circuit breaker of the rheostat;
3. Close the rotor short-circuit contacts and lift the motor brushes using the electromechanical actuator;
4. The short-circuit of the slip rings is done by means of the sliding bushing (2) that supports the short-circuit contacts (3). Then, the brush lifting mechanism is activated (4);
5. When the brushes are totally lifted, the electromechanical actuator is turned off by means of the limit switch **6ZE**;
6. Confirm the procedure conclusion through the switches **2ZE**, **4ZE** and **6ZE** according to the operating logic of the motorized brush holder described in section 4.7.2.5.3 of this manual;
7. Neither of the torque limit switches, **1WE** or **2WE**, must be actuated;
8. The motor must continue its operation on duty with the brushes lifted and slip rings short-circuited.



#### ATTENTION

Even if the rheostat is at its minimum resistance value, it must be short-circuited before short-circuiting the slip rings of the motor in order to prevent sparking during the closing of the contacts, which can damage them. After the motor starting, the brushes must not remain in contact with the slip rings, because that can cause excessive wear of the brushes and slip rings, as well as damage the brush lifting system.



#### ATTENTION

If one of the torque switches **2WE** or **1WE** actuates during motor starting procedure, the system must not be used again before investigating the cause and fixing the problem; The control panel of the motorized brush lifting system must have signaling devices that indicate the operation of the system logic. The command and signaling system of the brushes-lifting device, the external rheostat and the short-circuit breaker of the rheostat are not integral parts of the motor.

### 5.2.3 Manual operation

The operation type change (motorized/manual) is done through the lever (8). The 1HZ switch indicates the lever (8) position to perform either motorized or manual operation.

If the motorized system cannot be activated, the brush set can be operated manually by using the handwheel (7).

In order to operate the system manually by means of the handwheel (7), the lever (8) must be moved downwards, as shown in Figure 5.2.



**ATTENTION**

If it is not possible to move the lever (8) downwards, rotate the handwheel (7) manually up to 90° in any direction in order to release the lever (8) movement.

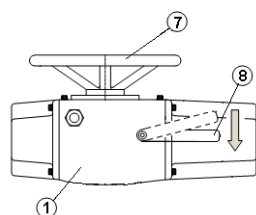

Figure 5.2: Manual operation

**Figure 5.2 legend:**

1 – Electromechanical actuator

7 – Handwheel

8 – Lever

With the lever (8) in "Manual" position, rotate the handwheel (7) to lift the brushes and short-circuit the slip rings or lower the brushes and open the short-circuit of the slip rings, as shown in Figure 5.3.

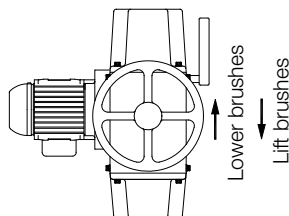

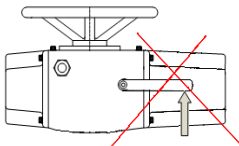

Figure 5.3: Handwheel for manual operation



**ATTENTION**



The lever (8) must not be forced upwards, because that can damage the equipment.

In order to return to the motorized system, the electromechanical actuator motor must be activated.

If there are any questions regarding the operation of the electromechanical actuator, consult WEG Authorized Service.

## 6 COMMISSIONING

When the motor is started for the first time or after a prolonged standstill, several aspects must be considered besides the regular operation procedures.



### ATTENTION

- Avoid any contact with electric circuits;
- Even low-voltage circuits may be life threatening;
- In any electromagnetic circuit, overvoltages may occur under certain operating conditions;
- Do not open an electromagnetic circuit suddenly, because the presence of an inductive discharge voltage may break the insulation or injure the operator;
- In order to open those circuits, disconnect switches or circuit breakers must be used.

### 6.1 PRELIMINARY INSPECTION

Before the first motor start or after long periods out of operation, the following items must be inspected:

1. Check if all the motor fastening bolts are tightened;
2. Measure the winding insulation resistances, making sure they are within the specified values;
3. Check if the motor is clean and if the packages, measuring instruments and alignment devices were removed from the motor operating area;
4. Check if coupling connecting components are in perfect operating conditions, duly tightened and greased, where necessary;
5. Check if the motor is correctly aligned;
6. Check if the bearings are properly lubricated. The lubricant must be of the type specified on the nameplate;
7. Check the oil level of oil-lubricated bearings. Bearings with forced lubrication must have the oil pressure and flow as specified on their nameplate;
8. Inspect the cable connections of accessories (thermal protectors, grounding, space heaters, etc.);
9. Check if all electrical connections comply with the motor connection diagram;
10. Check if the motor is properly grounded;
11. The cables connected to the stator and rotor main terminals must be properly tightened in order to prevent their short-circuit or loosening;
12. Inspect the cooling system. In water-cooled motors, inspect the operation of the radiator water supply system. In motors with independent ventilation, check the rotation direction of the fans;
13. Motor air inlets and outlets (if any) must be unobstructed;
14. The moving parts of the motor must be protected to prevent accidents;
15. The terminal box covers must be correctly fastened;
16. Check if the power supply voltage and frequency comply with the data on the motor nameplate;
17. Check the conditions of the brush holders and slip rings;
18. Check if the brushes are well settled, if they are aligned with the slip rings and if they slide easily inside the brush holders;
19. Inspect the operation of the brush lifting system (if any);
20. Inspect the starting rheostat and its connection to the motor.
21. Inspect the operation of the anti-reversion devices (if any).
22. Check if the radial locking device on the upper bearing (if any) has been replaced, as per item 4.2.2;

### 6.2 FIRST STARTING

#### 6.2.1 Starting procedure

After all preliminary inspections have been carried out, proceed according to the directions presented next in order to perform the first start of the uncoupled motor:

1. Turn off the space heater;
2. Set the protections in the control panel;
3. In oil-lubricated bearings, check the oil level;
4. In bearings with forced-lubrication, start the oil circulation system and check the level, flow and pressure of the oil, making sure that they comply with the data on the nameplate.
5. If the system has oil flow detection equipment, it must be waited until the flow return signal from the oil circulation system of both bearings is received, which makes sure that the oil has reached the bearings;
6. Start the industrial water cooling system checking the required flow and pressure (motors with air-water heat exchanger);
7. Turn on the fans (motors with forced ventilation);
8. Switch on the high-pressure oil injection system (if any), keeping it on as informed in the motor technical documentation until the bearings get the lubrication by self-pumping;
9. Rotate the motor shaft slowly in order to check that no part is being dragged or any abnormal noises are occurring;
10. After the previous steps have been adequately completed, it is possible to proceed with the motor starting sequence;
11. Start the motor with no load, making sure it rotates smoothly without strange noises;
12. Check the rotation direction with the motor uncoupled;
13. In order to invert the rotation direction, just invert the connections of any two phases;



### ATTENTION

In order to invert the rotation direction of motors with single direction, it is necessary to consult WEG.

14. Keep the motor rotating at rated speed and write down the bearing temperatures at 1-minute intervals until they become constant. Any sudden increase in bearing temperature indicates lubrication or friction surface abnormality;
15. Monitor the temperature, the oil level of the bearings, and the vibration levels. If there is a significant variation of any value, interrupt the motor starting, identify possible causes and make the necessary corrections;



16. When the bearing temperatures stabilize, it is possible to proceed to the other motor operation steps.



**ATTENTION**

The noncompliance with the procedures described in section 6.2 may impair the motor performance, cause damages and even lead to its burnout, voiding the warranty.

## 6.3 OPERATION

The operating procedures vary considerably depending on the motor application and the type of control equipment used.

Only the general procedures are described in this manual. For the control system operating procedures, refer to the specific manual of this equipment.

### 6.3.1 General

After a first successful starting test, couple the motor to the driven load, and then the starting procedure can be reinitiated, as follows:

- Start the motor coupled to the load until its temperature stabilizes and check for unusual noises, abnormal vibrations or excessive heating. If significant vibration variations occur regarding the initial operation condition until the condition after reaching thermal stability, then it is necessary to check the alignment and the leveling.
- Measure the current consumption and compare it to the value given on the nameplate.
- In continuous duty, without load variation, the measured current must not exceed the value indicated on the nameplate multiplied by the service factor;
- All the instruments and devices for measurement and control must be permanently monitored to detect occasional alterations, determine their causes and make the proper corrections.

### 6.3.2 Load Condition



**ATTENTION**

Check the real load condition to which the motor will be submitted under operating conditions and, if necessary, resize the set of brushes. In case of questions, consult WEG.

### 6.3.3 Temperatures

- The temperatures of the bearings, stator winding and cooling system must be monitored while the motor is operating.
- These temperatures must stabilize within 4 to 8 hours of operation.
- The stator winding temperature depends on the machine load; therefore, the driven load must also be monitored during the motor.

### 6.3.4 Bearings

The system start, as well as the first hours of operation, must be monitored carefully.

**Before putting the motor into operation, verify:**

- If the high-pressure oil injection system (if any) is ON;
- If the external lubrication system (if any) is ON;
- If the used lubricant complies with the specifications;
- The lubricant characteristics;
- The oil level (oil-lubricated bearings);

- If the bearing alarm and trip temperatures are set;
- During the first start, it is important to pay attention to unusual vibrations or noises;
- If the bearing is not working silently and smoothly, the motor must be shut down immediately;
- In case of overheating, the motor must be shut down immediately for the inspection of bearings and temperature sensors, and the correction of possible causes;
- The motor must operate for several hours until bearing temperatures stabilize within the specified limits;
- After the bearing temperatures stabilize, check if there are no leaks through the plugs, gaskets or shaft end.

#### 6.3.4.1 High-pressure oil injection system

In bearings which have the option for shaft lifting when starting or stopping by means of oil pressure, the activation of this system is done by means of an external oil pump, and the following procedure must be observed:



**ATTENTION**

The high-pressure oil injection system must be switched on before putting the motor into operation and during the shutdown procedure, as informed in the motor technical documentation.

### 6.3.5 Radiators

During the operation of motors with air-water heat exchanger, it is necessary:

- Controlling the temperature at the radiator inlet and outlet and, if necessary, correcting the water flow;
- Adjusting the water pressure just to overcome the resistance in the pipes and in the radiator;
- In order to control the motor operation, it is recommended to install thermometers at the radiator air and water inlets and outlets and record these temperatures at certain time intervals;
- When installing the thermometers, recording or signaling instruments (siren, lights) can also be installed in certain places.

#### Verification of the radiator performance

- For operation control purposes, it is recommended that water and air temperatures at the radiator inlets and outlets be measured and recorded periodically;
- The radiator performance is expressed by the temperature difference between cold water and cold air during normal operation. This difference must be checked periodically. If an increase in this difference is observed after a long period of normal operation, verify the need for radiator cleaning.
- The accumulation of air inside the radiator can lead to a performance reduction or to its damage. In this case, a deaeration of the radiator and the pipes may solve the problem;
- The water pressure differential can be considered an indicator of the need for cleaning the radiator.
- It is also recommended to measure and record the difference between the water pressure before and after the radiator. Periodically, the values measured must be compared to the original value, and an increase of the pressure differential indicates the need for cleaning the radiator.

### 6.3.6 Vibration

The motors are balanced at the factory in compliance with the vibration limits established by IEC60034-14, NEMA MG1 – Part 7 and NBR 11390 standards (except when the purchase contract specifies different values).

The vibration measurements are carried out on the NDE and DE bearings, in the vertical, horizontal and axial directions. When the customer sends the half coupling to WEG, the motor is balanced with the half coupling mounted on the shaft. Otherwise, according to the standards above, the motor is balanced with half-key (i.e., the key slot is filled with a bar of the same width, thickness and height of the key slot during the balancing operation). The maximum vibration levels attended by WEG for motors in operation are informed in Table 6.1. These values are generic and for guidance, and the specific application conditions must always be taken into account:

Table 6.1: Vibration (RMS)

Rated speed (rpm)	Vibration Levels (mm/s RMS)			
	Frame	< 355	355 to 560	> 630
600 ≤ n ≤ 1800	Alarm	4.5	4.5	5.5
	Tripping	7.0	7.0	8.0
1800 < n ≤ 3600	Alarm	3.5	4.5	5.5
	Tripping	5.5	6.5	7.5

The main vibration causes are:

- Misalignment between the motor and the driven equipment;
- Improper fastening of the motor to the base, with **“loose shims”** under one or more motor feet, and loose fastening bolts;
- Improper or insufficiently rigid base;
- External vibrations proceeding from other equipment.

**ATTENTION**

Operating the motor with vibration levels above the values contained in Table 6.1 may impair its useful life and/or performance.

### 6.3.7 Shaft vibration limits

In motors equipped with or prepared for the installation of proximity sensors (normally used on sleeve bearings), the surfaces of the shaft are prepared with special finishing in the areas adjacent to the bearings, in order to assure the correct measurement of the shaft vibration.

The shaft vibration measured in these motors must comply with the IEC 60034-14 or NEMA MG 1 standard. The alarm and trip values of Table 6.2 represent the acceptable shaft vibration values for coupled electrical machines according to the ISO7919-3 standard. These values are generic and for guidance, and the specific application conditions must always be taken into account, especially the diametrical clearance between the shaft and the bearing.

Table 6.2: Shaft vibration

Rated Speed (rpm)	Shaft Vibration (µm peak-to-peak)			
	Frame	280 and 315	355 to 450	> 450
1800	Alarm	110	130	150
	Tripping	140	160	190
3600	Alarm	85	100	120
	Tripping	100	120	150



#### ATTENTION

Operating the motor with shaft vibration values within the alarm or tripping range may cause damages to the bearing shell.

The main causes for increase in shaft vibration are:

- Coupling unbalance issues or other problems that may also generate machine vibration;
- Shaft shape problems in the measurement region, minimized during manufacturing;
- Residual magnetism or voltage on the shaft surface where the measurement is done;
- Scratches, dents or variations on the shaft finishing in the measurement region.

### 6.3.8 Shutdown

In order to shut down the motor, proceed as follows:

- Reduce the load of the driven equipment, if possible;
  - Open the main circuit breaker;
  - Switch on the high-pressure oil injection system (if any);
- After the motor stops completely:
- Switch off the high-pressure oil injection system (if any);
  - Switch off the oil circulation system of the bearings (if any);
  - Switch off the hydraulic unit (if any);
  - Shut down the industrial water system (if any);
  - Switch off the forced ventilation system (if any);
  - Switch on the space heaters. They must be kept ON until the next motor operation.



#### DANGER

Even after switching the motor off, while the rotor is rotating, there is danger to life by touching any of the motor active parts.



#### ATTENTION

The terminal boxes of motors equipped with capacitors must not be opened before their full discharge.  
Discharge time of the capacitors: five minutes after shutting down the motor.

## 7 MAINTENANCE

### 7.1 GENERAL

A proper maintenance program for electric motors includes the following recommendations:

- Keep the motor and the associated equipment clean;
- Measure the winding insulation resistance periodically;
- Measure the temperature of windings, bearings and cooling system periodically;
- Check the wear, operation of the lubrication system and useful life of the bearings;
- Measure the motor vibration levels;
- Inspect the cooling system;
- Inspect associated equipment;
- Inspect all the motor accessories, protections and connections, ensuring that they are operating properly;



#### ATTENTION

Noncompliance with the recommendations of section 7.1 may cause undesired stoppages of the equipment. The frequency of such inspections depends on the local application conditions. Every time that it becomes necessary to transport the motor, the shaft must be properly locked to prevent damages to the bearings. Use the device supplied with the motor to lock the shaft. If the motor requires reconditioning or replacement of any damaged part, consult WEG.

#### 7.1.1 Brushes and slip rings

- Check the wear of the brushes and slip rings;
- Check the brush lifting system (if any).

### 7.2 GENERAL CLEANING

- Keep the frame clean, without external accumulation of oil or dust, in order to facilitate the heat exchange with the environment;
- The inside of the motor must also be kept clean, free of dust, debris and oils;
- For cleaning, use brushes or clean cotton cloths. If the dust is not abrasive, the cleaning must be done with an industrial vacuum cleaner, "aspiring" the dirt from the fan cover and the dust accumulated on the fan blades and on the frame;
- Debris impregnated with oil or moisture can be removed with a cloth soaked in appropriate solvents;
- Clean the terminal boxes when necessary. Terminals and connectors must be kept clean, free of rust and in perfect operating conditions. Avoid the presence of grease or verdigris in the connection parts.

### 7.3 BRUSH COMPARTMENT CLEANING

- The brush compartment must be kept clean, without dust accumulation from the wear of the electric brushes;
- The brush compartment must be cleaned with a vacuum cleaner, removing the dust of the brushes from the motor;
- The slip ring set must be cleaned with a dry clean cloth which does not release lint;
- Clean the spaces between the slip rings with a vacuum cleaner hose with a plastic crevice tool;
- Do not use solvents to clean the slip rings, because the vapors of such products impair the operation of the brushes and the slip rings;
- Air filters (if any) must be removed and cleaned every two months.

### 7.4 WINDING INSPECTIONS

Yearly, the windings must be submitted to a complete visual inspection, recording and repairing all and every damage or defect observed.

The winding insulation resistance measurements must be done at regular intervals, especially during humid weather and after prolonged motor stoppages.

Low values or sudden variations in the insulation resistance must be investigated.

The windings must be submitted to complete visual inspections at frequent intervals, recording and repairing all and every damage or defect observed.

The winding insulation resistance can be increased up to an adequate value in the points where it is low (as a result of excessive dust and moisture) by means of the dust removal and by drying the winding moisture.

### 7.5 WINDING CLEANING

In order to obtain a more satisfactory operation and a longer useful life of the insulated windings, it is recommended to keep them free of dirt, oil, metal dust, contaminants, etc.

Therefore, it is necessary to inspect and clean the windings periodically, according to the recommendations of the "Maintenance Plan" of this manual. If reimpregnation is necessary, consult WEG.

The windings may be cleaned with an industrial vacuum cleaner with a non-metallic crevice tool or just a dry cloth. For extreme dirt conditions, it may be necessary to use a proper liquid solvent for cleaning. This cleaning must be quick to prevent prolonged exposure of the windings to the solvent effects.

After being cleaned with solvents, the windings must be completely dried.

Measure the insulation resistance and the polarization index in order to assess the winding insulation conditions. Winding drying time after cleaning varies depending on the weather conditions such as temperature, humidity, etc.



**DANGER**

Most solvents currently used are highly toxic and/or flammable. Solvents must not be used in the straight parts of the coils of high-voltage motors, because they may affect the protection against corona effect.

### 7.5.1 Inspections

The following inspections must be carried out after the windings are carefully cleaned:

- Check the insulations of the winding and connections;
- Check if spacers, bindings, slot wedges, bandages and supports are properly fixed;
- Check for breaks, faulty welds, short-circuit between turns and against the frame in the coils and connections. In case any fault is detected, consult WEG.
- Ensure that all cables are properly connected and that terminal fixation components are duly tightened. Retighten, if necessary.

### 7.5.2 Reimpregnation

If any layer of resin on the windings is damaged during cleaning or inspection, such parts must be corrected with adequate material (in this case, consult WEG).

### 7.5.3 Insulation Resistance

The insulation resistance must be measured after the completion of all of the maintenance procedures.



**ATTENTION**

Before putting the motor back into operation, it is essential to measure the winding insulation resistance and ensure that the measured values meet the specifications.

## 7.6 COOLING SYSTEM MAINTENANCE

- The pipes of the air-air heat exchanger (if any) must be kept clean and unobstructed to ensure a perfect heat exchange. In order to remove the dirt accumulated in the pipes, a rod with a round brush at the end may be used.
- In case of air-water heat exchangers, periodic cleaning in the radiator pipes is necessary to remove all and any incrustation.



**NOTE**

If the motor has filters in the air inlets and/or outlets, they must be cleaned with compressed air. If the dust is difficult to remove, wash the filters with cold water and neutral detergent and dry them in the horizontal position; In case the filters are impregnated with dust containing grease, it is necessary to wash them with gasoline, kerosene or another petroleum solvent or hot water with P3 additive; All the filters must be dried after the cleaning. Do not twist them; Replace the filter if necessary.

## 7.7 RADIATOR MAINTENANCE

The degree of dirt in the radiator can be detected by the increase of the temperature at the air outlet. When the temperature of the cold air, under the same operating conditions, exceeds the specified value, it can be assumed that the pipes are dirty.

If corrosion is found in the radiator, it is necessary to provide adequate protection against corrosion (i.e., zinc anodes, cover with plastic, epoxy or other similar products), in order to prevent further damage to the parts already affected.

The external surface of all the radiator parts must always be kept in good conditions.

### Instructions for removal and maintenance of the radiator

In order to remove the radiator for maintenance, use the following procedure:

1. Close all the water inlet and outlet valves after stopping the ventilation;
2. Drain the water through the radiator drain plugs;
3. Remove the heads, keeping the bolts, nuts, washers and seals (gaskets) in a safe place;
4. Brush the inside of the pipes carefully with nylon brushes in order to remove residues. If damages to the radiator tubes are found during the cleaning, they must be repaired;
5. Reassemble the heads, replacing the gaskets, if necessary.

### Sacrificial anodes

Sacrificial anodes are used in radiators that operate with seawater. The regular inspection must be carried out, according to the maintenance plan. If excessive corrosion is found in the sacrificial anode, the frequency of inspection must be increased in order to determine the corrosion period and establish a plan for proper replacement intervals.

## 7.8 VIBRATION

Any evidence of increase in the unbalance or vibration of the motor must be investigated immediately.

## 7.9 ANTI-REVERSION RATCHET MAINTENANCE

The ratchet anti-reversion condition (if any) must be inspected according to the maintenance plan described in Table 9.1.

Remove the motor top cover and check the wear of the pins and gear teeth of the ratchet. If excessive wear is detected, these parts must be replaced.

## 7.10 SLIP RINGS

The slip rings must be kept clean and smooth. They must be cleaned monthly, removing all the dust accumulated between the rings (see section 7.3).

In case the slip rings are disassembled, their centering must be ensured in the assembly, in order to prevent ovalization or radial run-outs. It must also be assured the proper positioning of the brush on the ring (100% contact). In case those procedures are not observed, the slip rings and brushes will present wearing issues.

## 7.11 BRUSH HOLDER AND BRUSHES

The **brush holders** must stay in the radial direction regarding the slip rings and distant a maximum of 4 mm from the contact surfaces, preventing rupture or damage to the brushes, as shown in Figure 7.1.

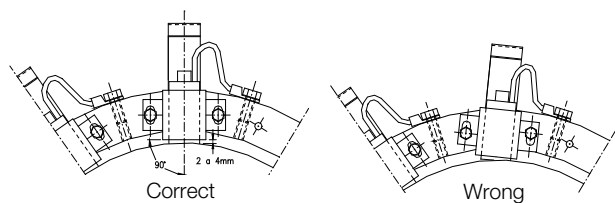

Figure 7.1: Brush holder assembly

### Brushes



#### ATTENTION

The brushes must be inspected weekly in order to ensure their free slide in the brush holder. Worn brushes must be replaced.

Wound-rotor motors are supplied with the quantity and type of brushes specified for their rated power. The brushes must be replaced by brushes equal to the original ones. Never mix different kinds of brushes. Any change in the type or quantity of brushes can only be made with the authorization of WEG. The brushes must be inspected weekly during operation. Those with excessive wear must be replaced. In motors that always operate in the same rotation direction, the brushes must be seated in this direction only, and not in alternate movements. During the shaft return movement, the brushes must be lifted (Figure 7.2).

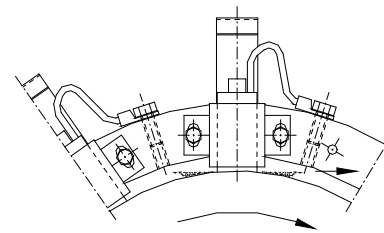

Figure 7.2: Brush seating

The brushes must be seated with even pressure on the contact surface of the ring in order to ensure an even distribution of the current and a low wear of the brushes. It is important that all the assembled brushes have the same contact pressure, with a tolerance of +/- 10%. Greater deviations lead to an uneven current distribution, resulting in an uneven wear of the brushes. The control of the brush pressure is done with a dynamometer. Springs presenting low pressure must be replaced.

### 7.11.1 Adjustment of the brushes to the load conditions

The motor leaves the factory with the brushes adjusted for the rated operating condition. The final adjustment to the real load conditions must be performed on site in the first months of operation.



#### ATTENTION

If the motor operates with a load different from the rated conditions or with intermittent load, the set of brushes (brush type and quantity) must be adapted to the real working conditions, under the risk of impairing the operation or completely damaging the motor. The brush adaptation must be made by consulting WEG.

## 7.12 SHAFT GROUNDING DEVICE

The shaft grounding brush (if any) avoids the circulation of electric current through the bearings, which is detrimental to their operation. The brush is put in contact with the shaft and connected by a cable to the motor frame, which must be grounded. Make sure that the brush holder fastening and its connection to the frame have been made correctly.

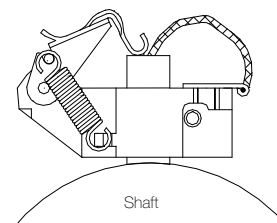

Figure 7.3: Shaft grounding brush

Drying oil is used to protect the motor shaft against rust during transportation. In order to ensure the proper operation of the grounding brush, this oil, as well as any residue between the shaft and the brush, must be removed before starting the motor. The brush must be constantly monitored during operation, and it must be replaced by another one of the same quality (granulation) at the end of its useful life.

## 7.13 BEARING MAINTENANCE

### 7.13.1 Grease-lubricated rolling bearings

#### 7.13.1.1 Instructions for lubrication

The lubrication system was designed in such a way that during the lubrication of the rolling bearings, all the old grease is removed from the rolling bearing races and expelled through a drain which enables the exit of the grease, but prevents the ingress of dust or other harmful contaminants.

This drain also prevents damage to the rolling bearings by the known problem of excessive lubrication.

It is recommended to make the lubrication with the motor in operation in order to ensure the renewal of the grease in the rolling bearing housing.

If that is not possible due to the presence of rotating parts near the grease nipple (pulleys, etc.) which may put the operator at risk, follow the procedures below:

- With the motor stopped, inject approximately half of the total intended amount of grease and operate the motor for approximately one minute at full speed;
- Stop the motor and inject the rest of the grease.



**ATTENTION**

The injection of all the grease with the motor stopped may lead to the penetration of part of the lubricant into the motor through the internal seal of the rolling bearing cap;

It is important to clean the grease nipples prior to lubrication in order to prevent foreign materials from being dragged into the rolling bearing. For lubrication, use only manual grease gun.



**NOTE**

The rolling bearing data, amount and type of grease, and lubrication intervals are informed on a bearing nameplate affixed to the motor. Check this information before performing the lubrication.

- The lubrication intervals informed on the nameplate consider a 70 °C working temperature of the rolling bearing;
- Based on the operating temperature ranges listed in Table 7.1, apply the following correction factors for the rolling bearing lubrication intervals:

Table 7.1: Reduction factor for lubrication intervals

Bearing operating temperature	Reduction factor
Below 60 °C	1.59
Between 70 and 80 °C	0.63
Between 80 and 90 °C	0.40
Between 90 and 100 °C	0.25
Between 100 and 110 °C	0.16

#### 7.13.1.2 Procedures for rolling bearing relubrication

1. Remove the drain plug;
2. Clean with a cotton cloth around the hole of the grease nipple;
3. With the rotor operating, inject the grease with a manual grease gun until grease starts coming out from the drain or until the proper amount of grease, informed in Table 7.3, has been injected.
4. Keep the motor running long enough so that the grease excess passes through the drain;
5. Inspect the bearing temperature to make sure there was no significant change;
6. Put the drain plug back in place.

#### 7.13.1.3 Rolling bearing relubrication with drawer device for grease removal

In order to relubricate the bearings, the old grease is removed by means of the device with a drawer installed on each bearing.

##### Lubrication procedure:

1. Before starting the lubrication of the bearing, clean the grease nipple with a cotton cloth;
2. Remove the rod with drawer to remove the old grease, clean the drawer and put it back in place;
3. With the motor running, inject the amount of grease specified on the rolling bearing nameplate by means of a manual grease gun;
4. The excess of grease comes out through the bearing lower drain and is deposited in the drawer;
5. Leave the motor running long enough for the grease excess to drain;
6. Remove the excess of grease, by pulling the drawer rod and cleaning the drawer. This procedure must be repeated as many times as necessary until the drawer no longer retains grease;
7. Inspect the bearing temperature to ensure that there was no significant change.

#### 7.13.1.4 Type and amount of grease

The relubrication of the bearings must always be done with the **original grease**, specified on the bearing nameplate and in the documentation of the motor.



**ATTENTION**

WEG does not recommend the use of greases different from the motor original grease.

It is important to perform a correct lubrication, i.e., to apply the correct grease and in the proper quantity, because either poor or excessive lubrication will damage the rolling bearings.

Excessive amount of grease cause temperature increase, due to the great resistance it offers to the movement of the bearing rotating parts. Consequently, due to the heating, the grease can completely lose its lubricating characteristics.

### 7.13.1.5 Alternative greases

If it is not possible to use the original grease, the alternative greases listed in Table 7.2 can be used, under the following conditions:

1. The motor speed must not exceed the limit speed of the grease, according to the type of rolling bearing, as informed in Table 7.3;
2. The lubrication interval must be corrected by multiplying the interval informed on the bearing nameplate by the multiplication factor informed in Table 7.2;
3. Use the correct procedure to change the grease, according to section 7.13.1.6 of this manual.

*Table 7.2: Options and characteristics of the alternative greases for regular applications*

<b>Manufacturer</b>	<b>Grease</b>	<b>Constant operating temperature (°C)</b>	<b>Multiplication factor</b>
Exxon Mobil	<b>UNIREX N3</b> (Lithium Complex Soap)	(-30 to +150)	0.90
Shell	<b>ALVANIA RL3</b> (Lithium Soap)	(-30 to +120)	0.85
Petrobras	<b>LUBRAX INDUSTRIAL GMA-2</b> (Lithium Soap)	(0 to +130)	0.85
Shell	<b>STAMINA RL2</b> (Diurea Soap)	(-20 to +180)	0.94
SKF	<b>LGHP 2</b> (Polyurea Soap)	(-40 to +150)	0.94

Table 7.3 shows the most common rolling bearings used in vertical motors, the quantity of grease and the speed limit for using alternative greases.

Table 7.3: Application of alternative greases

Rolling bearing	Grease quantity (g)	Limit speed of the grease [rpm] Vertical motors				
		Shell STAMINA RL2	SKF LGHP 2	Esso UNIREX N3	Shell ALVANIA RL3	Petrobras LUBRAX Industrial GMA-2
6215	15	3600	3600	3600	3000	3000
6217	20	1800	1800	1800	1800	1800
6220	30	1800	1800	1800	1800	1800
6222	40	1800	1800	1800	1800	1800
6224	45	1800	1800	1800	1800	1800
6228	55	1800	1800	1800	1800	1500
6232	70	1800	1800	1800	1500	1200
6236	85	1800	1800	1500	1500	1200
6240	105	1800	1800	1200	1200	1000
6048	100	1500	1500	1200	1200	1000
6052	130	1500	1500	1200	1000	900
6064	290	1200	1200	1000	900	750
7216	20	3600	3600	3600	3000	1800
7218	25	1800	1800	1800	1800	1800
7222	40	1800	1800	1800	1800	1800
7224	45	1800	1800	1800	1800	1800
7228	55	1800	1800	1800	1800	1500
7322	60	1800	1800	1800	1800	1500
7324	70	1800	1800	1800	1800	1500
7326	80	1800	1800	1800	1500	1200
7328	95	1800	1800	1800	1500	1200
7330	105	1800	1800	1500	1500	1200
7332	115	1800	1800	1500	1200	1200
7332 DT	230	1800	1800	1500	1200	1200
7334 DT	260	1800	1800	1500	1200	1000
7338 DT	310	1500	1500	1200	1200	1000



### 7.13.1.6 Procedure for changing the grease

In order to replace the **POLYREX EM103** grease by one of the alternative greases, the bearings must be opened to remove the old grease and then filled with the new grease.

If it is not possible to open the bearings, the old grease must be purged by applying new grease until it begins to appear in the exit drawer with the motor running.

In order to replace the **STABURAGS N12MF** grease by one of the alternative greases, you must first open the bearings, completely remove the old grease, and then fill it with new grease.



**ATTENTION**

Since there is no grease compatible with **STABURAGS N12MF**, other grease must not be injected in the attempt to purge it. This procedure will not expel completely the old grease and they will mix, which may cause damage to the bearings.



**ATTENTION**

When the bearing is opened, inject the new grease through the grease nipple to expel the old grease found in the grease inlet tube, and apply the new grease in the rolling bearing, to the inner and outer bearing caps, filling 3/4 of the empty spaces. In case of double bearings (ball bearing + roller bearing), also fill 3/4 of the empty spaces between the intermediate rings.

Never clean the rolling bearing with cotton-based cloths, because they may release some lint, working as solid particles.



**NOTE**

WEG is not liable for the grease change or for any damages arising from this change.

### 7.13.1.7 Low temperature greases

Table 7.4: Grease for application at low temperatures

Manufacturer	Grease	Constant operating temperature (°C)	Application
Exxon Mobil	<b>MOBILITH SHC 100</b> (Lithium Soap and Synthetic Oil)	(-50 to +150)	Low temperature

### 7.13.1.8 Grease compatibility

You can say that greases are compatible when the properties of the mixture are within the property ranges of the greases individually.

In general, greases with the same type of soap are compatible; however, depending on the proportion of the mixture, there might be incompatibility. Therefore, it is not recommended to mix different types of grease without consulting the grease supplier or WEG.

Some thickeners and basic oils cannot be mixed, because they do not form a homogeneous mixture. In

this case, one cannot rule the possibility of hardening or softening of the grease, or reduction of the dropping point of the resulting mixture.



**ATTENTION**

Greases with different types of base must never be mixed.

For example: Lithium-based greases must never be mixed with sodium or calcium-based greases.

### 7.13.1.9 Disassembly – vertical bearings

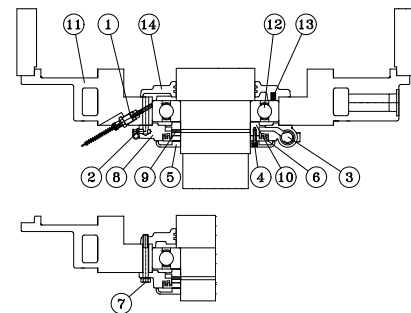

Figure 7.4: Lower bearing

**Figure 7.4 legend:**

1. Temperature sensor
2. Grease nipple
3. Grease collecting drawer
4. Screw
5. Protection disc
6. Labyrinth taconite seal
7. Screw
8. Outer bearing cap
9. Screw
10. Grease flinger
11. Lower end shield
12. Rolling bearing
13. Spring
14. Inner bearing cap

#### 7.13.1.9.1 Before disassembling

- Remove the extension tubes from the grease inlet and outlet;
- Thoroughly clean the external part of the bearing;
- Remove the grounding brush (if any);
- Remove the temperature sensors.

#### 7.13.1.9.2 Lower bearing disassembly

In order to disassemble the bearing, proceed according to the following guidelines:

1. Place the motor in the horizontal position;
2. Remove the screws (4), protection disc (5) and the labyrinth taconite seal (6);
3. Remove the screws (7) from the outer and inner bearing caps (8 and 14);
4. Remove the outer bearing cap (8);
5. Remove the screw (9) that fixes the grease flinger (10);
6. Remove the grease flinger (10);
7. Remove the lower end shield (11);
8. Remove the rolling bearing (12);
9. Remove the inner bearing cap (14), if necessary.

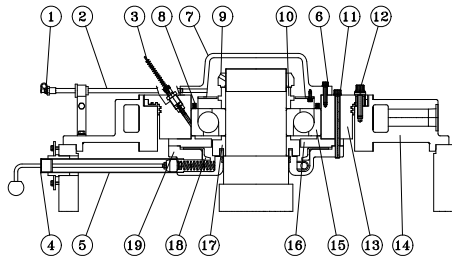

Figure 7.5: Upper bearing

**Figure 7.5 legend:**

1. Grease nipple
2. Grease inlet tube
3. Temperature sensor
4. Grease collecting drawer
5. Grease outlet tube
6. Screw
7. Outer bearing cap
8. Spring
9. KMT nut
10. Spacer ring
11. Screw
12. Screw
13. Bearing hub
14. Upper end shield
15. Rolling bearing
16. Intermediate ring
17. Grease flinger
18. Guiding ring
19. Inner bearing cap

**7.13.1.9.3 Upper bearing disassembly**

In order to disassemble the bearing, proceed according to the following guidelines:

1. Support the motor shaft with a hydraulic jack;
2. Remove the screws (6) from the outer bearing cap of the rolling bearing (7);
3. Remove the outer bearing cap (7);
4. Remove the KMT nut (9);
5. Remove the screws (11 and 12) and remove the bearing hub;
6. Remove the upper end shield (14);
7. Move the intermediate ring and the inner bearing cap away from the bearing in order to obtain space to place the device to remove the rolling bearing;
8. Remove the rolling bearing (15);
9. Remove the grease flinger (17), the intermediate ring and the inner bearing cap, if necessary.

**ATTENTION**

- During the bearing disassembly, it is necessary to be careful not to damage the balls, rollers or shaft surface;
- Keep the disassembled parts in a safe and clean place.

**7.13.1.10 Bearing assembly**

- Clean the bearings completely and inspect the disassembled parts and the inside of the bearing caps;
- Make sure the rolling bearing, shaft and bearing cap surfaces are perfectly smooth;
- Fill up to ¾ of the inner and outer bearing cap deposits with the recommended grease (Figure 7.6) and lubricate the rolling bearing with enough grease before assembling it;
- Before assembling the rolling bearing on the shaft, heat it up to a temperature between 50 °C and 100 °C;

- For the complete assembly of the bearing, follow the disassembly instructions in the reverse order.

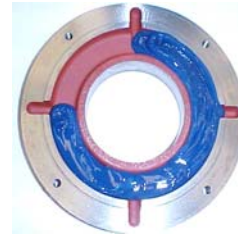

Figure 7.6: Outer bearing cap

**7.13.2 Oil-lubricated rolling bearing**

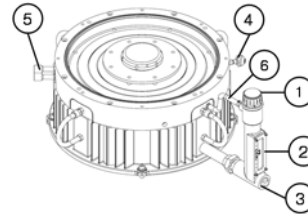

Figure 7.7: Oil-lubricated rolling bearing

**Figure 7.7 legend:**

1. Oil inlet
2. Oil sight glass
3. Oil outlet
4. Temperature sensor
5. Cooling water inlet and outlet (optional use)
6. Breather hose

**ATTENTION**

The breather hose (6) must not present any curvature that can accumulate oil inside.

**7.13.2.1 Lubrication instructions**

**Oil drainage:** When it is necessary to change the bearing oil, remove the oil outlet plug (3) and drain the oil completely.

**To fill the bearing with oil:**

- Close the oil outlet with the plug (3);
- Remove the plug from the oil inlet or from the filter (1);
- Fill it with the specified oil up to the level indicated in the oil sight glass.

**NOTES**

1. All threaded holes that are not used must be closed with plugs and no fitting may present leaks;
2. The oil level is reached when the lubricant can be seen approximately in the middle of the sight glass;
3. The use of a larger amount of oil will not damage the bearing; but it can cause leaks through the shaft seals;
4. Never use hydraulic oil or mix it with the bearing lubricant oil.

### 7.13.2.2 Oil type

The type and quantity of **lubricant oil** to be used are specified on the nameplate affixed to the motor.

### 7.13.2.3 Oil change

The bearing oil change must be done according to the intervals, which depend on the bearing operating temperature, shown in Table 7.5:

Table 7.5: Oil change intervals

Bearing operating temperature	Bearing oil change intervals
Below 75 °C	20,000 hours
Between 75 and 80 °C	16,000 hours
Between 80 and 85 °C	12,000 hours
Between 85 and 90 °C	8,000 hours
Between 90 and 95 °C	6,000 hours
Between 95 and 100 °C	4,000 hours

The lifespan of the bearings depends on their operating conditions, on the motor operating conditions and on the maintenance procedures.

Proceed according to the following directions:

- The oil selected for the application must have the proper viscosity for the bearing operating temperature. The type of oil recommended by WEG already considers these criteria;
- Insufficient quantity of oil may damage the bearing;
- The minimum recommended oil level is reached when the lubricant can be seen in the lower part of the oil sight glass with the motor stopped.



**ATTENTION**

The oil level must be inspected daily and must remain in the middle of the oil sight glass.

### 7.13.2.4 Bearing operation

**The system start, as well as the first hours of operation, must be monitored carefully.**

Before starting, check:

- If the used oil complies with the specification on the nameplate;
- The lubricant characteristics;
- The oil level;
- The alarm and trip temperatures set for the bearing.

During the first start, it is necessary to stay alert for unusual vibrations or noises. If the bearing does not operate in a silent and smooth way, the motor must be shut down immediately.

The motor must operate for some hours until the bearing temperatures stabilize. In case of overheating of the bearings, the motor must be shut down for inspection of the bearings and temperature sensors.

Check if there is no oil leak through the plugs, gaskets or shaft end.

### 7.13.2.5 Bearing disassembly

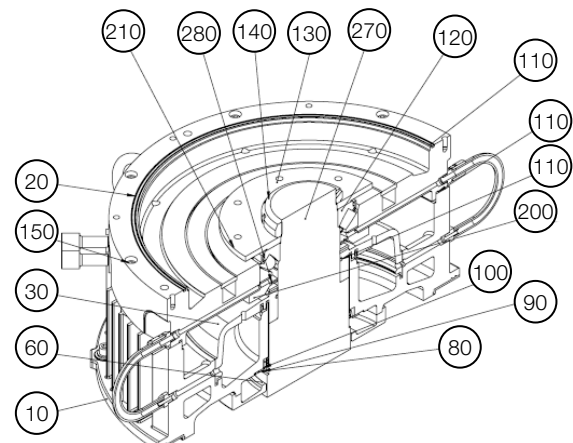

Figure 7.8: Upper bearing

**Figure 7.8 legend:**

- 10. Oil tank
- 20. Bearing hub
- 30. Oil flinger
- 60. Oil drip pan
- 80. Seal fastening ring
- 90. Socket screw
- 100. Teflon seal
- 110. Gasket
- 120. Rolling bearing
- 130. Upper intermediate ring
- 140. Fastening nut
- 150. Socket screw
- 200. Lower intermediate ring
- 210. Socket screw
- 270. Shaft
- 280. Socket screw

**Before disassembling the upper bearing:**

- Support the rotor on the shaft end with a hydraulic jack;
- Drain the oil completely from the bearing;
- Clean the external part of the bearing thoroughly;
- Remove the temperature sensors.

**Upper bearing disassembly**

In order to disassemble the bearing, proceed carefully as the following guidelines, keeping all the parts in a safe place.

- Remove the upper bearing cover;
- Remove the KMT nut (140);
- Remove the intermediate ring (130);
- Remove the screws (150) and remove the bearing hub;
- Remove the rolling bearing (120);
- Reinstall the upper intermediate ring (130), fasten it directly to the lower intermediate ring (200) and, using a rolling bearing puller, extract the set formed by the upper ring (130), lower ring (200) and rolling bearing (120).

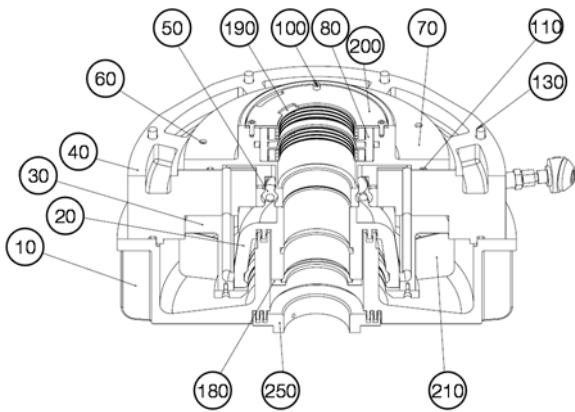

Figure 7.9: Lower bearing

**Figure 7.9 legend:**

- 10. Oil tank
- 20. Oil flinger
- 30. Oil guide
- 40. Bearing hub
- 50. Rolling bearing
- 60. Socket screw
- 70. Oil injector nozzle
- 80. Seal fastening ring
- 100. Socket screw
- 110. Gasket
- 130. Socket screw
- 180. Segmented ring
- 190. Teflon seal
- 200. Seal fastening ring
- 210. Oil guide
- 250. Labyrinth taconite seal

**Before disassembling the lower bearing:**

- Drain the oil completely from the bearing;
- Put the motor in the horizontal position;
- Clean the external part of the bearing thoroughly;
- Remove the grounding brush (if any);
- Remove the temperature sensors.

**Lower bearing disassembly**

In order to disassemble the bearing, proceed carefully as the following guidelines, keeping all the parts in a safe place.

- Remove the screws (8) that fasten the labyrinth taconite seal (250);
- Remove the labyrinth taconite seal (250);
- Remove the oil tank (10);
- Remove the segmented ring (180);
- Remove the oil flinger (20);
- Remove the rolling bearing hub (40);
- Remove the rolling bearing (50);

**ATTENTION**

- During the bearing disassembly, it is necessary to be careful not to damage the balls, rollers or shaft surface;
- Keep the disassembled parts in a safe and clean place.

**7.13.2.6 Bearing assembly**

- Clean the rolling bearing and the oil tanks thoroughly, and inspect all the parts before the bearing assembly.
- Make sure the rolling bearing contact surfaces are smooth and free of signs of scratches or corrosion;
- Before mounting the rolling bearing on the shaft, heat it up to a temperature between 50 to 100 °C;

- For the complete assembly of the bearing, follow the disassembly instructions in the reverse order.

**ATTENTION**

During the bearing assembly, apply sealant (e.g. **Curil T**) in order to seal the surfaces of the oil tank.

**7.13.3 Rolling bearing replacement**

The disassembly of rolling bearings must be done with an appropriate tool (rolling bearing puller). The arms of the puller must be placed on the lateral surface of the inner ring to be disassembled or on an adjacent part.

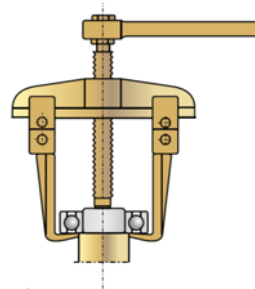

Figure 7.10: Tool for rolling bearing extraction

**7.13.4 Sleeve bearings**

**7.13.4.1 Bearing data**

The characteristic data, such as oil flow, quantity and type, are indicated on the bearing nameplate and must be strictly observed; otherwise, overheating and damages to the bearings may occur. The hydraulic installation (for bearings with forced lubrication) and the oil supply for the motor bearings are responsibilities of the user.

**7.13.4.2 Bearing installation and operation**

For information on the bill of materials, assembly and disassembly instructions, and maintenance details, refer to the specific installation and operation manual of the bearings.

**7.13.4.3 Cooling by water circulation**

The sleeve bearings with cooling by water circulation have a serpentine inside the oil tank through which the water circulates.

In order to assure an efficient bearing cooling, the circulating water must have at the bearing inlet a temperature lower or equal to the ambient, so that the cooling takes place. The water pressure must be 0.1 bar and the flow equal to 0.7 l/s. The pH must be neutral.

**NOTE**

Under no circumstances can water leak into the oil tank, because this will contaminate the lubricant.

### 7.13.4.4 Oil change

#### Self-lubricated bearings

The bearing oil change must be done according to the intervals, which depend on the bearing operating temperatures, shown in Table 7.6:

Table 7.6: Oil change intervals

Bearing operating temperature	Bearing oil change intervals
Below 75 °C	20,000 hours
Between 75 and 80 °C	16,000 hours
Between 80 and 85 °C	12,000 hours
Between 85 and 90 °C	8,000 hours
Between 90 and 95 °C	6,000 hours
Between 95 and 100 °C	4,000 hours

#### Bearings with external oil circulation

The oil of the bearings must be changed every 20,000 hours of operation or whenever the lubricant presents modifications in its characteristics. The oil viscosity and pH must be checked periodically.



#### NOTE

The oil level must be inspected daily, and it must remain in the middle of the oil sight glass.

The bearings must be lubricated with the specified oil, respecting the flow rate informed on their nameplate; All threaded holes that are not used must be closed with plugs and no fitting may present leaks. The oil level is reached when the lubricant can be seen approximately in the middle of the sight glass. The use of a larger amount of oil will not damage the bearing, but it can cause leaks through the shaft seals.



#### ATTENTION

The care with the lubrication will determine the useful life of the bearings and the safety in the motor operation. Therefore, the following recommendations must be observed:

- The selected lubricant oil must be the one with proper viscosity for the operating temperature of the bearings; That must be observed at every oil change or during periodical maintenances;
- Never use or mix hydraulic oil with the lubricant oil of the bearings;
- Lack of lubricant, due to incomplete filling or non-monitoring of the level, can damage the bearing shells;
- The minimum oil level is reached when the lubricant can be seen in the lower part of the sight glass with the motor stopped.

### 7.13.4.5 Sealing

Make visual inspections of the sealing, making sure that the dragging marks of the seal on the shaft do not compromise its integrity, checking for cracks and broken parts. Cracked or broken parts must be replaced. In case of bearing maintenance, in order to assemble the seal, it is necessary to carefully clean the seal contact surfaces and its enclosure, and cover the sealing with a non-hardening component (i.e. **Curil T**). The two halves of the labyrinth taconite seal must be joined by a garter spring. The drain holes located in the lower half of the seal must be cleaned and unobstructed. Improper installation can damage the sealing and cause oil leakage.



#### ATTENTION

For further information about the dismounting and mounting of sleeve bearing seals, refer to the specific manual of this equipment.

### 7.13.4.6 Sleeve bearing operation

**The system start, as well as the first hours of operation, must be monitored carefully.**

Before starting, check:

- If the oil inlet and outlet tubes (if any) are, clean. Clean the tubes by pickling, if necessary;
- If the used oil complies with the specification on the nameplate;
- The lubricant characteristics;
- The oil level;
- The alarm and trip temperatures set for the bearing.

During the first start, it is necessary to stay alert for unusual vibrations or noises. If the bearing does not operate in a silent and smooth way, the motor must be shut down immediately.

The motor must operate for several hours until the bearing temperatures stabilize. In case of overheating of the bearings, the motor must be shut down for inspection of the bearings and temperature sensors.

Check if there is no oil leak through the plugs, gaskets or shaft end.

### 7.13.4.7 Sleeve bearing maintenance

The sleeve bearing maintenance includes:

- Periodic checking of the oil level and its lubricating conditions;
- Checking the bearing noise and vibration levels;
- Monitoring of the operating temperatures and retightening of the fastening and mounting screws;
- In order to facilitate the heat exchange with the environment, the frame must be kept clean, without external dust or oil accumulation;
- The NDE bearing is electrically insulated. The spherical seat surfaces of the bearing shell on the frame are covered with insulating material. Never remove this cover;
- The anti-rotation pin is also insulated, and the seals are made of non-conducting material;
- Temperature control devices that are in contact with the bearing shell must also be properly insulated.

### 7.13.4.8 Bearing disassembly and assembly



**NOTE**

If the supplied bearings are manufactured by WEG, refer to the specific bearing manual supplied with the motor, containing the assembly, disassembly and maintenance information.

#### 7.13.4.8.1 Thrust bearing (upper)

The upper thrust bearing function is to withstand the weight of the motor and the axial thrust for which it was designed. Its main elements are the stationary axial pads and the rotating pivots (see Figure 7.11).

The pivots receive the load through the thrust pads.

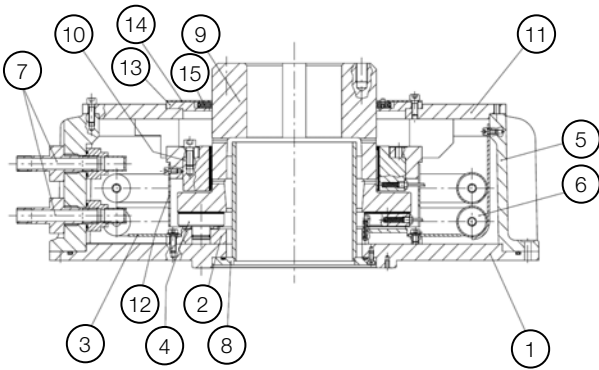

Figure 7.11: Upper thrust bearing

**Figure 7.11 legend:**

1. Lower flange
2. Base ring of the pads
3. Axial segment
4. Axial pad
5. Bearing housing
6. Serpentine (optional)
7. Fittings for cooling water
8. Stand pipe
9. Runner
10. Bearing shell
11. Bearing cover
12. Vertical guide plate
13. Seal box
14. Seal fastening ring
15. Floating seal

**Before disassembling:**

- Support the rotor at the shaft end with a hydraulic jack;
- Drain the oil thoroughly from the bearing;
- Clean the external part of the bearing thoroughly;
- Remove the temperature sensors.

**Disassembly**

- Support the rotor at the shaft end with a hydraulic jack;
- Remove the screws that fix the bearing upper cover and remove it;
- Disassemble the bearing following the manufacturer manual instruction.

**Assembly**

In order to assemble the bearing, follow the disassembly procedures in the reverse order.

#### 7.13.4.8.2 Guide bearing (lower)

The lower guide bearing function is to provide the radial location of the motor shaft without load or axial displacement limitation.

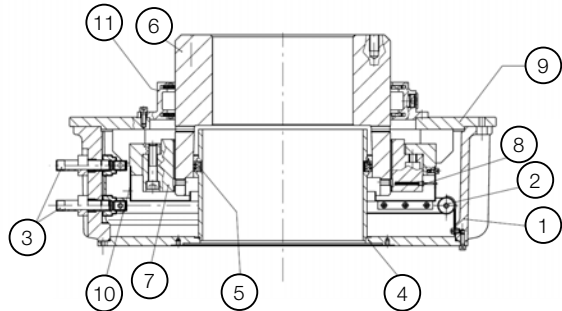

Figure 7.12: Lower guide bearing

**Figure 7.12 legend:**

1. Bearing housing
2. Serpentine
3. Fittings for cooling water
4. Stand pipe
5. Stand pipe seal
6. Runner
7. Bearing shell
8. Thermoresistance (optional)
9. Cover
10. Radial segment
11. Double seal

**Before disassembling:**

- Drain the oil thoroughly from the bearing;
- Thoroughly clean the external part of the bearing;
- Remove the temperature sensors;
- Remove the grounding brush (if any);
- Uncouple the motor and place it in the horizontal position.

**Disassembly**

- Remove the screws that fix the bearing lower cover and remove it;
- Disassemble the bearing following the manufacturer manual instruction.

**Assembly**

In order to assemble the bearing, follow the disassembly procedures in the reverse order.

### 7.13.5 Bearing protection

#### 7.13.5.1 Protection settings



**ATTENTION**

The following temperatures must be set on the bearing protection system:

**Alarm 110 °C – Trip 120 °C**

The alarm temperature must be set 10 °C above the operating temperature, not exceeding the limit of 110 °C.

### 7.13.5.2 Disassembly/assembly of the bearing temperature sensors

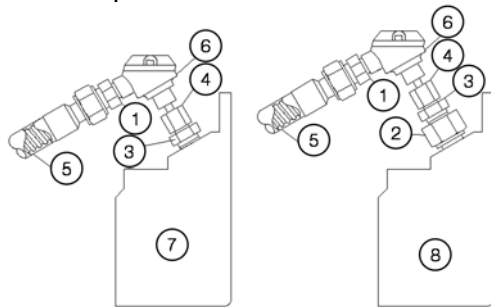

Figure 7.13: Pt100 on the bearings

#### Figure 7.13 legend:

- 1.Reduction nipple
- 2.Insulating adapter
- 3.Locknut
- 4.Bulb
- 5.Flexible metal tube
- 6.Pt-100 temperature sensor
- 7.Non-insulated bearing
- 8.Insulated bearing

#### Disassembly instructions:

If it is necessary to remove the Pt100 for bearing maintenance, proceed according to the following instructions:

- Remove the Pt100 carefully, locking the locknut (3), and unscrewing just the Pt100 from the bulb (4);
- Parts (2) and (3) must not be disassembled.

#### Assembly instructions:



#### ATTENTION

Before assembling the Pt100 on the bearing, check if it does not contain marks of knock or any other damage that may compromise its operation.

- Insert the Pt100 into the bearing;
- Restrain the locknut (3) with a wrench;
- Screw it in the bulb (4), adjusting it so that the tip of the Pt100 touches the outer surface of the bearing.



#### NOTES

- The assembly of the Pt100 on non-insulated bearings must be done directly on the bearing, without the insulating adapter (2);
- The tightening torque to assemble the Pt100 and the adapters must not exceed 10Nm.

## 7.14 MAINTENANCE OF THE BRUSH LIFTING SYSTEM

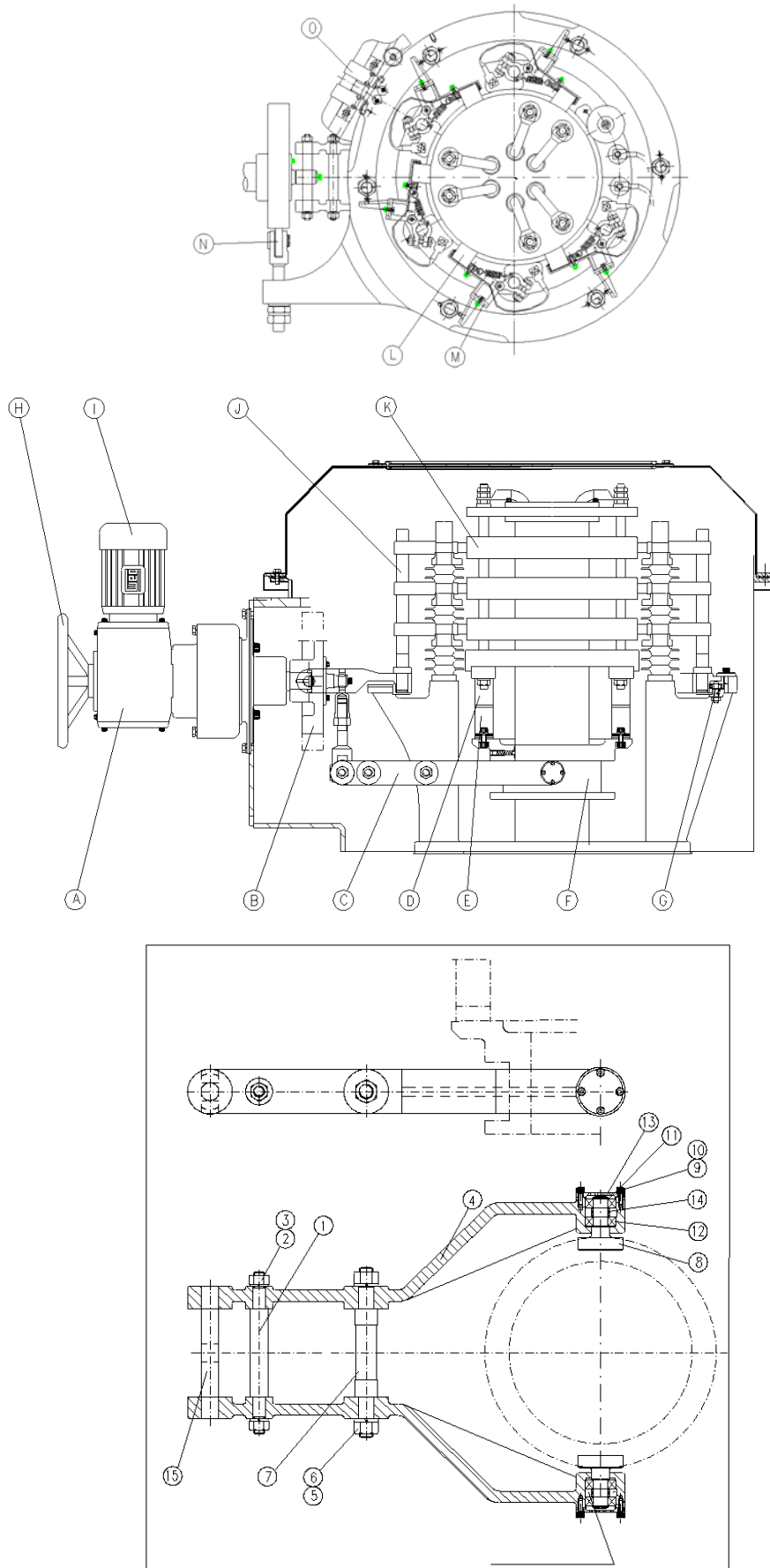

Figure 7.14: Brush lifting system



### 7.14.1 Parts list

- A) Electromechanical actuator
  - B) Lifting disc
  - C) Motion arm
  - D) Female contact
  - E) Male contact
  - F) Short-circuit bushing
  - G) Rolling bearing 6200 2RS1 (3 parts)
  - H) Handwheel
  - I) Electromechanical actuator driving motor
  - J) Lifting pin
  - K) Slip rings
  - L) Brushes
  - M) Brush holder
  - N) Rolling bearing 6305 2RS1
  - O) Signaling limit switches
1. Upper pin of the arm
  2. M12 nut
  3. B12 lock washer
  4. Bushing motion arm
  5. B16 lock washer
  6. M16 nut
  7. Swiveling bracket pin
  8. Roller
  9. B5 lock washer
  10. M5 x15 socket screw
  11. Retaining ring
  12. Rolling bearing 6003 Z (4 parts)
  13. Bearing cover of the roller
  14. Spacer bushing
  15. Swiveling bracket pin

### 7.14.2 Preventive maintenance procedures

#### Daily:

- Inspect for noise and vibration.

#### Monthly:

- Inspect the operation of the brush lifting system;
- Test the motorized operation for lifting and lowering the brushes;
- Test the manual operation for lifting and lowering the brushes;
- Make sure that the needle rollers (8) do not remain in contact with the short-circuit bushing (F) after the start;
- Inspect for noise and vibration;
- Check the condition of brushes, brush holder and slip rings.

#### Biannually:

- Clean the set, vacuuming the dirt from inside the compartment;
- Inspect the male and female short-circuit contacts (D and E) for possible wear, sparking marks, dirt or hot spots;
- Clean the contacts with a fine sandpaper and proper solvent;
- Inspect the slip rings (K);
- Inspect the brushes and the brush holder (L and M);
- Measure the insulation resistance of the slip rings and the brush holder;
- Retighten the connections (electrical and mechanical)
- Lubricate the mechanical parts (avoid grease excess).

#### Annually:

- Retighten the connections (electrical and mechanical)
- Check the conditions of the rolling bearings (12) of the roller that moves the short-circuit bushing and, if necessary, replace them;
- Check the condition of the rolling bearings (G) of the support disc for the lifting pins; if necessary, replace them;
- Check the condition of the rolling bearing (N) that is in contact with the lifting disc;
- Inspect and adjust the electromechanical actuator (clean, retighten, check the rolling bearings and mechanical parts).



#### ATTENTION

The rollers (8) must not remain in contact with the short-circuit bushing (F) after the starting operation has been completed.



#### NOTE

- After 6 months of operation, all parts with mechanical contacts must be lubricated;
- The brushes will last longer if the motor is not started frequently; however, they must be inspected periodically;
- Check the contact surface of the brushes with the slip rings, the mounting of the brushes in the brush holder, as well as the pressure of the brush holder springs.

### 7.14.3 Adjustment of the electromechanical actuator

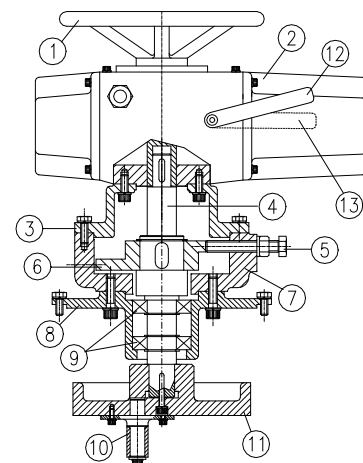

Figure 7.15: Parts of the electromechanical actuator

#### Figure 7.15 legend:

1. Handwheel
2. Electromechanical actuator
3. Locking device cover
4. Drive shaft
5. Set screw
6. Stop disc
7. Locking device frame
8. Driving set flange
9. Rolling bearing
10. Bushing
11. Lifting disc
12. Motor
13. Manual

### 7.14.3.1 Mechanical adjustment

The electromechanical actuator of the brush lifting system already comes adjusted from the factory. If it is necessary to make any new adjustment, proceed as follows:

1. Activate the **manual system** of the actuator using the selection lever;
2. Rotate the **set using the handwheel** up to the short-circuit position (brushes lifted) until the bushing moving rollers are centralized between the contact surfaces of the bushing, but not touching it;

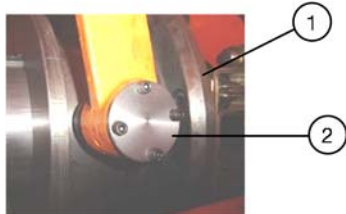

Figure 7.16: Positioning of the bushing and rollers

**Figure 7.16 legend:**

1. Bushing
2. Roller

3. Rotate the set screw until it touches the stop disc and lock it;
4. Rotate the lifting disc in the opposite direction up to the non-short-circuit position (brushes lowered);
5. Rotate the set screw of the opposite side until it touches the stop disc and lock it;

### 7.14.3.2 Electrical adjustment

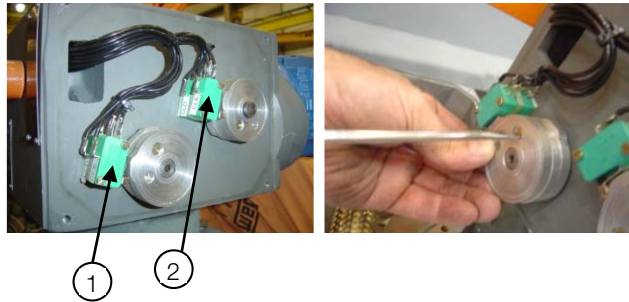

Figure 7.17: Limit switches of the electromechanical actuator

**Figure 7.17 legend:**

1. 6ZE and 5ZE limit switches
2. 2WE and 1WE limit switches

**Required equipment:**

- Screwdriver;
  - Multimeter.
1. Adjust the **6ZE and 5ZE drive limit switches** located on the electromechanical actuator to actuate a little before the stop disc touches the set screws, thus shutting down the actuator motor;
  2. Adjust the **2WE and 1WE torque limit switches** located on the electromechanical actuator to actuate a little after the actuation point of the positioning switches ( $\pm 2\text{mm}$ ) to shut down the actuator motor only when these fail.



**ATTENTION**

The **2ZE, 4ZE, 1ZE and 3ZE** signaling limit switches located inside the brush compartment must be used only for signaling and not for activating the electromechanical actuator.

## 8 MOTOR DISASSEMBLY AND ASSEMBLY



### ATTENTION

All the repair, disassembly and assembly services must be performed only by properly qualified and trained professionals; otherwise, equipment damage and personal injury may occur. If any further explanations are necessary, consult WEG.

The disassembly and assembly sequences depend on the motor model.

Always use proper tools and devices. Any damaged part (cracks, dents on machined parts, faulty threads) must be replaced, avoiding restorations.

### 8.1 PARTS LIST

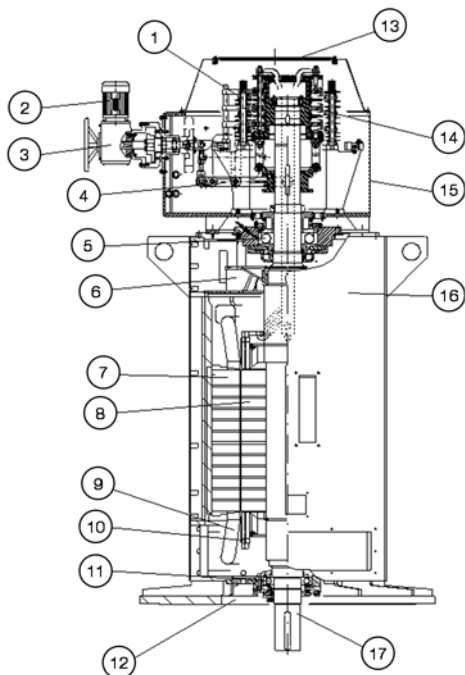

Figure 8.1: Typical vertical motor with solid shaft and motorized brush holder

#### Figure 8.1 legend:

1. Brush holder / brushes
2. Motor of the electromechanical actuator
3. Electromechanical actuator
4. Mechanical system
5. Upper bearing
6. Internal fan
7. Stator
8. Rotor
9. Stator winding
10. Rotor winding
11. Lower bearing
12. Flanged end shield
13. Inspection cover
14. Slip rings
15. Brushes compartment
16. Frame
17. Shaft

### 8.2 DISASSEMBLY

When disassembling the electric motor, the following care must be taken:

1. Before disassembling the motor, disconnect the water cooling and lubrication pipes (if any);
2. Disconnect the motor electrical connections and those of the accessories;
3. Remove the heat exchanger and the noise suppressor (if any);

4. Remove the bearing temperature sensors and the grounding brush;
5. In order to prevent damages to the rotor, provide a support for the shaft on both drive and non-drive ends;
6. In order to disassemble the bearings, follow the procedures described in this manual, according to the bearing type;
7. Use a proper device to remove the rotor from the motor, taking extreme care not to drag the rotor against the stator laminated core or coil heads, thus preventing damages.

### 8.3 ASSEMBLY

In order to assemble the motor, follow the disassembly procedures in the reverse order.

### 8.4 AIR-GAP MEASUREMENT

After disassembling and assembling the motor, it is necessary to measure the air gap in order to check the concentricity between rotor and stator.

The difference between the air-gap measured in two points diametrically opposed must be less than 10% of the average air gap.

### 8.5 TIGHTENING TORQUE

Table 8.1 and Table 8.2 shows the tightening torques of the screws recommended for assembling the motor.

Table 8.1: Screw tightening torque for metal/metal parts

Material / Resistance class		Carbon Steel / 8.8 or above		Stainless steel / A2 – 70 or above	
% Yield Strength		60%		70%	
Lubricant		Dry	Molycote 1000	Dry	Molycote 1000
Diam	Pitch (mm)	Screws tightening torque (Nm)			
M3	0,5	1,2	0,8	1	0,69
M4	0,7	2,7	1,8	2,4	1,6
M5	0,8	5,4	3,6	4,8	3,2
M6	1	9,3	6,3	8,2	5,5
M8	1,25	22,4	15	20	13
M10	1,5	44	30	39	26
M12	1,75	77	52	67	45
M14	2	123	82	107	72
M16	2	188	126	165	110
M18	2,5	263	176	230	154
M20	2,5	368	246	322	215
M22	2,5	500	332	437	290
M24	3	637	425	557	372
M27	3	926	615	810	538
M30	3,5	1260	838	1102	734
M33	3,5	1704	1130	1490	990
M36	4	2195	1459	1920	1277
M42	4,5	3507	2328	3070	2037
M48	5	5258	3488	4600	3052

Table 8.2: Screw tightening torque for metal/isolated parts

Material / Resistance class		Carbon Steel / 8.8 or above		Stainless steel / A2 – 70 or above	
% Yield Strength		33%		33%	
Lubricant		Dry	Molycote 1000	Dry	Molycote 1000
Diam	Pitch (mm)	Screws tightening torque (Nm)			
M3	0,5	0,6	0,5	0,48	0,32
M4	0,7	1,5	1	1,1	0,76
M5	0,8	3	2	2,2	1,5
M6	1	5,2	3,4	3,8	2,6
M8	1,25	12,3	8,3	9,2	6,2
M10	1,5	24	16	18,2	12,2
M12	1,75	42	28	32	21
M14	2	68	45	51	34
M16	2	104	69	78	52
M18	2,5	145	98	108	72
M20	2,5	202	135	152	101
M22	2,5	274	183	206	137
M24	3	350	233	263	175
M27	3	510	338	382	254
M30	3,5	693	461	520	346
M33	3,5	937	622	703	466
M36	4	1207	802	905	602
M42	4,5	1929	1280	1447	960
M48	5	2892	1918	2170	1440



**NOTE**

The resistance class is normally indicated on the head of the hex bolts.

## 8.6 SPARE PARTS

When ordering spare parts, inform the motor type and serial number, according to the motor nameplate. WEG recommends keeping in stock the following spare parts:

Table 8.3: Spare parts list

Spare parts	Motor model				
	● Recommended		▲ Highly Recommended		
	MAA, MAP, MAD, MAT	MAF	MAW	MAL, MAI	MAR
Temperature sensor for front and rear bearing	▲	▲	▲	▲	▲
Space heater	▲	▲	▲	▲	▲
Filter felt (if any)	▲	▲		▲	
Grounding Brush	▲	▲	▲	▲	▲
Set of brushes	▲	▲	▲	▲	▲
Brush holder set	▲	▲	▲	▲	▲
Set of springs for brush holder (if applicable)	▲	▲	▲	▲	▲
Front and rear bearing for the fan motor (if applicable)				▲	
Lubricant for bearings	▲	▲	▲	▲	▲
Set of collector rings	●	●	●	●	●
Vibration sensor for front and rear bearing (if applicable)	●	●	●	●	●
Vibration signal converter for front and rear bearing (if applicable)	●	●	●	●	●
Air temperature sensor (if applicable)	●	●	●	●	●
Water temperature sensor (if applicable)			●		
Set of water leakage sensor (if applicable)			●		
Repeater relay for water leak sensor (if applicable)			●		
Water regulating valve (if applicable)			●		
Motor for fan motor				●	
Rolling bearing (One piece for each bearing)	Bearing	▲	▲	▲	▲
	Teflon seal	▲	▲	▲	▲
	Internal bearing cap	●	●	●	●
	External bearing cap	●	●	●	●
	Grease valve	●	●	●	●
	Ring with labyrinth	●	●	●	●
	Cylindrical pressure spring	●	●	●	●
Protective ring against water ingress	●	●	●	●	
Sleeve bearing (One piece for each bearing)	Set of bearing shell	▲	▲	▲	▲
	Floating labyrinth seal	▲	▲	▲	▲
	Mechanical seal	▲	▲	▲	▲
	Loose oil ring	●	●	●	●
	Oil regulating valve (if applicable)	●	●	●	●
Motorized brush holder	Set of bearings	▲	▲	▲	▲
	Set of male and female contacts	▲	▲	▲	▲
	Set of limit switches	●	●	●	●
	Electromechanical actuator with motor	●	●	●	●

The spare parts must be stored in a clean, dry and well-ventilated environment and, if possible, at constant temperature.

## 9 MAINTENANCE PLAN

The maintenance plan described in Table 9.1 is only referential, and the intervals between each maintenance intervention may vary according to the motor location and operating conditions.

For the associated equipment, such as the water supply unit or control and protection system, it is necessary to refer to their specific manuals.

Table 9.1: Maintenance plan

MOTOR PART	Weekly	Monthly	3 months	6 months	Annual	3 years	
<b>STATOR</b>							
Visual inspection of the stator.					x		
Cleanliness control.					x		
Inspection of the slot wedges.						x	
Verification of the fastening of the stator terminals.					x		
Measurement of the winding insulation resistance.					x		
<b>ROTOR</b>							
Visual inspection.					x		
Cleaning control.					x		
Inspection of the shaft (wear, incrustations).						x	
<b>BEARINGS</b>							
Control of noise, vibration, oil flow, leaks and temperature.	x						
Lubricant quality control.					x		
Inspection of the bearing shell and shaft journal (sleeve bearing).						x	
Lubricant change.							According to the period indicated on the bearing nameplate.
<b>AIR-WATER HEAT EXCHANGER</b>							
Inspection of the radiators					x		
Cleaning of the radiators.					x		
Inspection of the radiator sacrificial anodes (if any).		x					Increase the inspection frequency in case of excessive corrosion.
Replacement of the gaskets of the radiator heads.					x		
<b>AIR-AIR HEAT EXCHANGER</b>							
Cleaning of the ventilation ducts.					x		
Inspection of the ventilation.					x		
<b>BRUSHES, BRUSH HOLDERS AND SLIP RINGS</b>							
Inspection and cleaning of the brush compartment.	x						
Verification of the contact area of the slip rings.			x				
Verification of the brush wear and their replacement, if necessary.		x					
Inspection of the brush lifting system (if any).							According to section 7.14.2.
<b>AIR FILTER(S)</b>							
Inspection, cleaning and replacement, if necessary.							Every 2 months.
<b>PROTECTION AND CONTROL EQUIPMENT</b>							
Recording of the values.	x						
Operation test.					x		
Disassembly and operation test.						x	
<b>COUPLING</b>							
Inspection of the alignment inspection.					x		Check after the first week of operation.
Inspection of the fastening.					x		
Inspection of the anti-reversion ratchet (if any).					x		
<b>WHOLE MOTOR</b>							
Inspection of noise and vibration.	x						
Drainage of condensed water.			x				
Retightening of the screws.					x		
Cleaning of the terminal boxes.					x		
Retightening of electrical and grounding connections.					x		

## 10 ABNORMALITIES, CAUSES AND SOLUTIONS



### NOTE

The instructions of Table 10.1 present only a basic list of abnormalities, causes and corrective actions. In case of questions, consult WEG.

Table 10.1: Basic list of abnormalities, causes and corrective actions

ABNORMALITY	POSSIBLE CAUSES	CORRECTION
<b>Neither coupled nor uncoupled does the motor start</b>	▪ At least two power cables are interrupted, without voltage	▪ Check the control panel, power cables, terminals, brush seating
	▪ Rotor is locked	▪ Unlock the rotor
	▪ Problems in the brushes	▪ Brushes may be worn, dirty or seated incorrectly
	▪ Damaged bearing	▪ Replace the bearing
<b>Motor starts with no load, but fails when load is applied. It starts very slowly and does not reach the rated speed</b>	▪ Load torque is too high during the start	▪ Do not apply load to the driven machine during the start
	▪ Power supply voltage is too low	▪ Measure the power supply voltage, and set it to the correct value
	▪ Very high voltage drop in the power cables	▪ Check the sizing of the installation (transformer, cable cross section, relays, circuit breakers, etc.)
	▪ Rotor with faulted or interrupted bars	▪ Check and repair the rotor winding; test the short-circuit device (rings)
	▪ A power cable was interrupted after the start	▪ Check the power cables
<b>The stator current oscillates under load with double the slip frequency; the motor presents a humming noise during starting</b>	▪ Rotor winding is interrupted	▪ Check and repair the rotor winding and the short-circuit device
	▪ Problems in the brushes	▪ Brushes may be worn, dirty or seated incorrectly
<b>Very high no load current</b>	▪ Power supply voltage is too high	▪ Measure the power supply voltage and set it to the correct value
<b>Hot spots in the stator winding</b>	▪ Short-circuit between turns	▪ Rewind
	▪ Interruption of the parallel wires or phases of the stator winding	
	▪ Faulty connection	▪ Redo the connection
<b>Hot spots in the rotor</b>	▪ Interruptions in the rotor winding	▪ Repair the rotor winding or replace it
<b>Abnormal noise during operation with load</b>	▪ Mechanical causes	▪ The noise normally decreases when the speed reduces. See also: <b>"noisy operation when uncoupled"</b>
	▪ Electrical causes	▪ The noise disappears when the motor is switched off. Consult WEG
<b>When coupled, there is noise; when uncoupled, the noise disappears</b>	▪ Defect in the coupling parts or in the driven machine	▪ Check the power transmission, the coupling and the alignment
	▪ Defect in the gear coupling	▪ Align the drive set
	▪ Unaligned/unleveled base	▪ Align/level the motor and the driven machine
	▪ Faulty balance of the components or of the driven machine	▪ Perform new balancing
	▪ Defective coupling	▪ Repair or replace the coupling
	▪ Wrong rotation direction of the motor	▪ Invert the connection of two phases

ABNORMALITY	POSSIBLE CAUSES	CORRECTION
<b>Stator winding becomes very hot under load</b>	<ul style="list-style-type: none"> <li>▪ Fans with inverted rotation direction</li> <li>▪ Insufficient cooling due to dirty air channels</li> </ul>	<ul style="list-style-type: none"> <li>▪ Correct the rotation direction of the fans</li> <li>▪ Open and clean the air passage channels</li> </ul>
	<ul style="list-style-type: none"> <li>▪ Overload</li> </ul>	<ul style="list-style-type: none"> <li>▪ Measure the stator current</li> <li>▪ Reduce the load</li> <li>▪ Analyze the motor application</li> </ul>
	<ul style="list-style-type: none"> <li>▪ High number of starts or moment of inertia too high</li> </ul>	<ul style="list-style-type: none"> <li>▪ Reduce the number of starts</li> </ul>
	<ul style="list-style-type: none"> <li>▪ Voltage too high, therefore, iron losses increase</li> </ul>	<ul style="list-style-type: none"> <li>▪ Do not exceed 110% of the rated voltage, except when otherwise specified on the nameplate</li> </ul>
	<ul style="list-style-type: none"> <li>▪ Voltage too low, therefore, the current is very high</li> </ul>	<ul style="list-style-type: none"> <li>▪ Check the supply voltage and the voltage drop on the motor</li> </ul>
	<ul style="list-style-type: none"> <li>▪ Interruption in a power cable or in a winding phase</li> </ul>	<ul style="list-style-type: none"> <li>▪ Measure the current in all the phases and, if necessary, correct it</li> </ul>
	<ul style="list-style-type: none"> <li>▪ Rotor drags against the stator</li> </ul>	<ul style="list-style-type: none"> <li>▪ Check the air-gap, operating conditions (vibration etc.), bearing conditions</li> </ul>
	<ul style="list-style-type: none"> <li>▪ The operating condition does not correspond to the nameplate data</li> </ul>	<ul style="list-style-type: none"> <li>▪ Keep the operating condition according to the nameplate or reduce the load</li> </ul>
	<ul style="list-style-type: none"> <li>▪ Unbalance in the power supply (blown fuse, wrong command)</li> </ul>	<ul style="list-style-type: none"> <li>▪ Check if there is voltage unbalance or operation with two phases and correct it</li> </ul>
	<ul style="list-style-type: none"> <li>▪ Dirty windings</li> </ul>	<ul style="list-style-type: none"> <li>▪ Clean</li> </ul>
	<ul style="list-style-type: none"> <li>▪ Air ducts clogged</li> </ul>	
	<ul style="list-style-type: none"> <li>▪ Dirty air filter</li> </ul>	
	<ul style="list-style-type: none"> <li>▪ Rotation direction is not compatible with the fan used</li> </ul>	<ul style="list-style-type: none"> <li>▪ Check the fan regarding to the motor rotation direction</li> </ul>
<b>Noisy operation when uncoupled</b>	<ul style="list-style-type: none"> <li>▪ Unbalance</li> </ul>	<ul style="list-style-type: none"> <li>▪ Noise remains during deceleration after disconnecting the voltage</li> <li>▪ Perform new balancing</li> </ul>
	<ul style="list-style-type: none"> <li>▪ Interruption in one phase of the stator winding</li> </ul>	<ul style="list-style-type: none"> <li>▪ Measure the current of all connecting cables</li> </ul>
	<ul style="list-style-type: none"> <li>▪ Fastening screws are loose</li> </ul>	<ul style="list-style-type: none"> <li>▪ Retighten and lock the screws</li> </ul>
	<ul style="list-style-type: none"> <li>▪ The rotor balancing conditions become worse after the assembly of the coupling</li> </ul>	<ul style="list-style-type: none"> <li>▪ Balance the coupling</li> </ul>
	<ul style="list-style-type: none"> <li>▪ Resonance in the foundation</li> </ul>	<ul style="list-style-type: none"> <li>▪ Adjust the foundation</li> </ul>
	<ul style="list-style-type: none"> <li>▪ Motor frame is deformed</li> </ul>	<ul style="list-style-type: none"> <li>▪ Check flatness of the base</li> </ul>
	<ul style="list-style-type: none"> <li>▪ Bent shaft</li> </ul>	<ul style="list-style-type: none"> <li>▪ The shaft may be warped</li> <li>▪ Check the rotor balancing and eccentricity</li> </ul>
<b>Motor operating at low speed with external resistance OFF</b>	<ul style="list-style-type: none"> <li>▪ Air-gap is not even</li> </ul>	<ul style="list-style-type: none"> <li>▪ Check the shaft warping or rolling bearing wear</li> </ul>
	<ul style="list-style-type: none"> <li>▪ Conductors incorrectly sized between the motor and the rheostat</li> </ul>	<ul style="list-style-type: none"> <li>▪ Resize the conductors</li> </ul>
	<ul style="list-style-type: none"> <li>▪ Circuit open in the rotor winding (including connections with rheostat)</li> </ul>	<ul style="list-style-type: none"> <li>▪ Test the continuity</li> </ul>
	<ul style="list-style-type: none"> <li>▪ Dirt between brush and slip ring</li> </ul>	<ul style="list-style-type: none"> <li>▪ Clean the slip rings and the insulating set</li> </ul>
	<ul style="list-style-type: none"> <li>▪ Brush stuck in the compartment</li> </ul>	<ul style="list-style-type: none"> <li>▪ Check the mobility of the brushes in the compartments</li> </ul>
	<ul style="list-style-type: none"> <li>▪ Incorrect pressure on the brushes</li> </ul>	<ul style="list-style-type: none"> <li>▪ Check the pressure on every brush and correct it, if necessary</li> </ul>
	<ul style="list-style-type: none"> <li>▪ Slip rings with rough surfaces or oval rings</li> </ul>	<ul style="list-style-type: none"> <li>▪ Clean, sandpaper and polish or machine when necessary</li> </ul>
<b>Sparking.</b>	<ul style="list-style-type: none"> <li>▪ High current density in the brushes</li> </ul>	<ul style="list-style-type: none"> <li>▪ Adequate the brushes to the load conditions</li> </ul>
	<ul style="list-style-type: none"> <li>▪ Badly seated brushes</li> </ul>	<ul style="list-style-type: none"> <li>▪ Seat the brushes correctly</li> </ul>
	<ul style="list-style-type: none"> <li>▪ Badly seated brushes</li> <li>▪ Low pressure between the brushes and rings.</li> </ul>	<ul style="list-style-type: none"> <li>▪ Correct the brush seating and provide the normal pressure</li> </ul>
	<ul style="list-style-type: none"> <li>▪ Overload</li> </ul>	<ul style="list-style-type: none"> <li>▪ Adjust the load to the motor characteristics or dimension a new motor for the application</li> </ul>
	<ul style="list-style-type: none"> <li>▪ Slip rings in poor conditions (ovalized, rough surfaces, with grooves, etc.)</li> </ul>	<ul style="list-style-type: none"> <li>▪ Machine the slip rings</li> </ul>
	<ul style="list-style-type: none"> <li>▪ Brushes stuck in their housings</li> </ul>	<ul style="list-style-type: none"> <li>▪ Check the mobility of the brushes in the brush housings</li> </ul>
	<ul style="list-style-type: none"> <li>▪ Excessive vibration</li> </ul>	<ul style="list-style-type: none"> <li>▪ Check the cause of the vibration and correct it</li> </ul>
<ul style="list-style-type: none"> <li>▪ Low load causing damages to the slip rings</li> </ul>	<ul style="list-style-type: none"> <li>▪ Adjust the brushes to the actual load condition and machine the slip rings</li> </ul>	



# 11 DECLARATION OF CONFORMITY

## EU Declaration of Conformity

**Manufacturers:**  
**WEG Equipamentos Elétricos S.A.**  
 Av. Prefeito Waldemar Grubba, 3000  
 89256-900 - Jaraguá do Sul - SC - Brazil  
[www.weg.net](http://www.weg.net)

**WEG Industrie (India) PVT. LTD.**  
 Plot n° E-20 (North), SIPCOT Industrial Complex  
 Phase II - Expansion II.  
 Mornapalli Village, Hosur 635 109  
 Tamil Nadu - India  
[www.weg.net/in](http://www.weg.net/in)

**WEG MEXICO, S.A. DE C.V**  
 Carretera Jorobas - Tula Km 3.5, Manzana 5,  
 Lote 1, Fraccionamiento Parque Industrial Huehuetoca,  
 Municipio de Huehuetoca, C.P. 54680,  
 CD. de Mexico y Área Metropolitana - Mexico  
[www.weg.net/mx](http://www.weg.net/mx)

**WEG (Jiangsu) Electric Equipment CO., LTD.**  
 No. 15 Group, North City Street, Dengyuan Community  
 Rugao City, Jiangsu Province - China  
[www.weg.net/cn](http://www.weg.net/cn)

**WEG (Nantong) Electric Motor Manufacturing CO., LTD.**  
 No. 128# - Xinkai South Road, Nantong  
 Economic & Technical Development  
 Zone, Nantong, Jiangsu Province - China  
[www.weg.net/cn](http://www.weg.net/cn)

**WEGeuro - Industria Eléctrica S.A.**  
 Rua Eng Frederico Ulrich, Apartado 6074  
 4476-908 - Maia - Porto - Portugal  
[www.weg.net/pt](http://www.weg.net/pt)  
 Contact person: Luís Filipe Oliveira Silva Castro Araújo  
 Authorised Representative in the European Union  
**(Single Contact Point)**

The manufacturer declares under sole responsibility that:

WEG synchronous and asynchronous motors, generators and their components used for following lines:

**M..., W60, WGM, G... and S...**

when installed, maintained and used in applications for which they were designed, and in compliance with the relevant installation standards and manufacturer's instructions, comply with the provisions of the following relevant European Union harmonisation legislation, wherever applicable:

- Low Voltage Directive 2006/95/EC\* (valid until April 19<sup>th</sup>, 2016)**
- Low Voltage Directive 2014/35/EU\* (valid from April 20<sup>th</sup>, 2016)**
- Machinery Directive 2006/42/EC\*\***

**EMC Directive 2014/30/EU** (electric motors are considered inherently benign in terms of electromagnetic compatibility)

The fulfilment of the safety objectives of the relevant European Union harmonisation legislation has been demonstrated by compliance with the following standards, wherever applicable:

- EN 60034-1:2010 + AC:2010/ EN 60034-5:2001 + A1:2007/ EN 60034-6:1993/**
- EN 60034-7:1993 + A1:2001/ EN 60034-8:2007 + A1: 2014/ EN 60034-9:2005 + A1:2007/ EN 60034-11:2004/**
- EN 60034-12:2002 + A1:2007/ EN 60034-14:2004 + A1:2007/**
- EN 60204-1:2006 + A1:2009 + AC:2010 and EN 60204-11:2000 + AC:2010**

CE marking in: **1998**

\* Electric motors designed for use with a voltage rating higher than 1000V are not considered under the scope.  
 \*\* Low voltage electric motors are not considered under the scope and electric motors designed for use with a voltage rating higher than 1000V are considered partly completed machinery and are supplied with a

**Declaration of Incorporation:**

*The products above cannot be put into service until the machinery into which they have been incorporated has been declared in conformity with the Machinery Directive.*

*A Technical Documentation for the products above is compiled in accordance with part B of annex VII of Machinery Directive 2006/42/EC.*

*We undertake to transmit, in response to a reasoned request by the national authorities, relevant information on the partly completed machinery identified above through WEG authorised representative established in the European Union. The method of transmission shall be electronic or physical method and shall be without prejudice to the intellectual property rights of the manufacturer.*

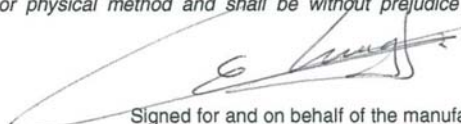
  
 Signed for and on behalf of the manufacturer:  
**Eduardo de Nobrega**  
 Managing Director

Jaraguá do Sul, May 28<sup>th</sup>, 2016

DEC2816-Rev01 - English 1/1

## **12 ENVIRONMENTAL INFORMATION**

### **12.1 PACKAGE**

Electric motors are supplied in cardboard, polymer, wood or metallic material packages. These materials are recyclable or reusable and must be properly disposed according to the current regulations of each country. All the wood used in the packaging of WEG motors comes from reforestation and receives anti-fungal treatment.

### **12.2 PRODUCT**

Electric motors, under the constructive aspect, are manufactured mainly with ferrous metals (steel, cast iron), nonferrous metals (copper, aluminum) and plastic. The electric motor, in general, is a product that has a long useful life; however, when it must be disposed, WEG recommends that the materials of the packaging and of the product be properly separated and sent for recycling. The non-recyclable materials must be properly disposed according to the environmental regulations, i.e., in industrial landfills, co-processed in cement kilns or incinerated. The service providers for recycling, disposal in industrial landfills, co-processing or incineration of waste must be properly licensed by the environmental agency of each state to carry out these activities.

### **12.3 HAZARDOUS WASTE**

Grease and oil waste used to lubricate the bearings should be disposed, according to the instructions of the relevant environmental agencies, because its improper disposal can cause impacts to the environment.

## 13 WARRANTY TERM

These products, when operated under the conditions stipulated by WEG in the operating manual for such product, are warranted against defects in workmanship and materials for twelve (12) months from start-up date or eighteen (18) months from manufacturer shipment date, whichever occurs first.

However, this warranty does not apply to any product which has been subject to misuse, misapplication, neglect (including without limitation, inadequate maintenance, accident, improper installation, modification, adjustment, repair or any other cases originated from inadequate applications).

The company will neither be responsible for any expenses incurred in installation, removal from service, consequential expenses such as financial losses nor transportation costs as well as tickets and accommodation expenses of a technician when this is requested by the customer.

The repair and/or replacement of parts or components, when effected by WEG within the Warranty period do not give Warranty extension, unless otherwise expressed in writing by WEG.

This constitutes WEG's only warranty in connection with this sale and is in lieu of all other warranties, expressed or implied, written or oral.

There are no implied warranties of merchantability or fitness for a particular purpose that apply to this sale.

No employee, agent, dealer, repair shop or other person is authorized to give any warranties on behalf of WEG nor to assume for WEG any other liability in connection with any of its products.

In case this happens without WEG's authorization, Warranty is automatically cancelled.

### LIABILITY

Except as specified in the foregoing paragraph entitled "**Warranty Terms for Engineering Products**", the company shall have no obligation or liability whatsoever to the purchaser, including, without limitation, any claims for consequential damages or labor costs, by reason of any breach of the express warranty described therein.

The purchaser further hereby agrees to indemnify and hold the company harmless from any causes of action (other than cost of replacing or repairing the defective product as specified in the foregoing paragraph entitled "**Warranty Terms for Engineering Products**"), arising directly or indirectly from the acts, omissions or negligence of the purchaser in connection with or arising out of the testing, use, operation, replacement or repair of any product described in this quotation and sold or furnished by the company to the purchaser.



WEG Group - Energy Business Unit  
Jaraguá do Sul - SC - Brazil  
Phone: 55 (47) 3276-4000  
energia@weg.net  
[www.weg.net](http://www.weg.net)

## NOTES







**ARGENTINA**

WEG EQUIPAMIENTOS ELECTRICOS S.A.  
Sgo. Pampiglione 4849  
Parque Industrial San Francisco  
2400 - San Francisco  
Phone: +54 (3564) 421484  
[www.weg.net/ar](http://www.weg.net/ar)

**AUSTRALIA**

WEG AUSTRALIA PTY. LTD.  
14 Lakeview Drive, Scoresby 3179,  
Victoria  
Phone: +03 9765 4600  
[www.weg.net/au](http://www.weg.net/au)

**AUSTRIA**

WATT DRIVE ANTRIEBSTECHNIK GMBH \*  
Wöllersdorfer Straße 68  
2753, Markt Piesting  
Phone: + 43 2633 4040  
[www.wattdrive.com](http://www.wattdrive.com)

**LENZE ANTRIEBSTECHNIK GES.M.B.H. \***

lpf - Landesstrasse 1  
A-4481 Asten  
Phone: +43 (0) 7224 / 210-0  
[www.lenze.at](http://www.lenze.at)

**BELGIUM**

WEG BENELUX S.A.\*  
Rue de l'Industrie 30 D,  
1400 Nivelles  
Phone: +32 67 888420  
[www.weg.net/be](http://www.weg.net/be)

**BRAZIL**

WEG EQUIPAMENTOS ELÉTRICOS S.A.  
Av. Pref. Waldemar Grubba, 3000,  
CEP 89256-900 Jaraguá do Sul - SC  
Phone: +55 47 3276-4000  
[www.weg.net/br](http://www.weg.net/br)

**CHILE**

WEG CHILE S.A.  
Los Canteros 8600,  
La Reina - Santiago  
Phone: +56 2 2784 8900  
[www.weg.net/cl](http://www.weg.net/cl)

**CHINA**

WEG (NANTONG) ELECTRIC MOTOR  
MANUFACTURING CO. LTD.  
No. 128# - Xinkai South Road, Nantong  
Economic & Technical Development Zone,  
Nantong, Jiangsu Province  
Phone: +86 513 8598 9333  
[www.weg.net/cn](http://www.weg.net/cn)

**COLOMBIA**

WEG COLOMBIA LTDA  
Calle 46A N82 - 54  
Portería II - Bodega 6 y 7  
San Cayetano II - Bogotá  
Phone: +57 1 416 0166  
[www.weg.net/co](http://www.weg.net/co)

**DENMARK**

WEG SCANDINAVIA DENMARK \*  
Sales Office of WEG Scandinavia AB  
Verkstadgatan 9 - 434 22 Kumgsbacka,  
Sweden  
Phone: +46 300 73400  
[www.weg.net/se](http://www.weg.net/se)

**FRANCE**

WEG FRANCE SAS \*  
ZI de Chenes - Le Loup13 / 38297 Saint  
Quentin Fallavier,  
Rue du Mo-reillon - BP 738/  
Rhône Alpes, 38 > Isère  
Phone: + 33 47499 1135  
[www.weg.net/fr](http://www.weg.net/fr)

**GREECE**

MANGRINOX\*  
14, Grevenon ST.  
GR 11855 - Athens, Greece  
Phone: + 30 210 3423201-3  
[www.weg.net/gr](http://www.weg.net/gr)

**GERMANY**

WEG GERMANY GmbH\*  
Industriegebiet Türnich 3 Geigerstraße 7  
50169 Kerpen-Türnich  
Phone: + 49 2237 92910  
[www.weg.net/de](http://www.weg.net/de)

**GHANA**

ZEST ELECTRIC MOTORS (PTY) LTD.  
15, Third Close Street Airport Residential Area,  
Accra  
Phone: +233 3027 66490  
[www.zestghana.com.gh](http://www.zestghana.com.gh)

**HUNGARY**

AGISYS AGITATORS & TRANSMISSIONS  
LTD.\*  
Tó str. 2. Torokbalint, H-2045 Phone: + 36  
(23) 501 150  
[www.agisys.hu](http://www.agisys.hu)

**INDIA**

WEG ELECTRIC (INDIA) PVT. LTD.  
#38, Ground Floor, 1st Main Road,  
Lower Palace, Orchards,  
Bangalore, 560 003  
Phone: +91 804128 2007  
[www.weg.net/in](http://www.weg.net/in)

**ITALY**

WEG ITALIA S.R.L.\*  
Via Viganò de Vizzi, 93/95  
20092 Cinisello Balsamo, Milano Phone: + 39  
2 6129 3535  
[www.weg.net/it](http://www.weg.net/it)

**FERRARI S.R.L.\***

Via Cremona 25 26015  
Soresina (CR), Cremona  
Phone: + 39 (374) 340-404  
[www.ferrarisrl.it](http://www.ferrarisrl.it)

**STIAVELLI IRIO S.P.A.\***

Via Pantano - Blocco 16 - Capalle 50010 ,  
Campi Bisenzio (FI)  
Phone: + 39 (55) 898,448  
[www.stiavelli.com](http://www.stiavelli.com)

**JAPAN**

WEG ELECTRIC MOTORS JAPAN CO., LTD.  
Yokohama Sky Building 20F, 2-19-12  
Takashima, Nishi-ku, Yokohama City,  
Kanagawa, Japan 220-0011  
Phone: + 81 45 5503030  
[www.weg.net/jp](http://www.weg.net/jp)

**MEXICO**

WEG MEXICO. S.A. DE C.V.  
Carretera Jorobas-Tula  
Km. 3.5, Manzana 5, Lote 1 Fraccionamiento  
Parque Industrial  
Huehuetoca  
Estado de México - C.P. 54680  
Phone: +52 55 53214275  
[www.weg.net/mx](http://www.weg.net/mx)

**NETHERLANDS**

WEG NETHERLANDS \*  
Sales Office of WEG Benelux S.A. Hanzepoort  
23C, 7575 DB Oldenzaal  
Phone: +31 541 571090  
[www.weg.net/nl](http://www.weg.net/nl)

**PORTUGAL**

WEG EURO - INDÚSTRIA ELÉCTRICA. S.A.\*  
Rua Eng. Frederico Ulrich,  
Sector V, 4470-605 Maia,  
Apartado 6074, 4471-908 Maia, Porto  
Phone: +351 229 477 705  
[www.weg.net/pt](http://www.weg.net/pt)

**RUSSIA**

WEG ELECTRIC CIS LTD.\*  
Russia, 194292, St. Petersburg, Pro-spekt  
Kulury 44, Office 419  
Phone: +7 812 3632172  
[www.weg.net/ru](http://www.weg.net/ru)

**SOUTH AFRICA**

ZEST ELECTRIC MOTORS (PTY) LTD.  
47 Galaxy Avenue, Linbro Business  
Park Gauteng Private Bag X10011  
Sandton, 2146, Johannesburg  
Phone: +27 11 7236000  
[www.zest.co.za](http://www.zest.co.za)

**SPAIN**

WEG IBERIA INDUSTRIAL S.L.\*  
C/ Tierra de Barros, 5-7  
28823 Coslada, Madrid  
Phone: +34 91 6553008  
[www.weg.net/es](http://www.weg.net/es)

**SINGAPORE**

WEG SINGAPORE PTE LTD  
159, Kampong Ampat, #06-02A KA PLACE.  
368328  
Phone: +65 68581081  
[www.weg.net/sg](http://www.weg.net/sg)

**SWEDEN**

WEG SCANDINAVIA AB \*  
Box 27, 435 21 Mölnlycke  
Visit: Designvägen 5, 435 33  
Mölnlycke, Göteborg  
Phone: +46 31 888000  
[www.weg.net/se](http://www.weg.net/se)

**SWITZERLAND**

BIBUS AG \*  
Allmendstrasse 26, 8320 - Fehraltorf  
Phone: + 41 44 877 58 11  
[www.bibus-holding.ch](http://www.bibus-holding.ch)

**UNITED ARAB EMIRATES**

The Galleries, Block No. 3, 8th Floor,  
Office No. 801 - Downtown Jebel Ali  
262508, Dubai  
Phone: +971 (4) 8130800  
[www.weg.net/ae](http://www.weg.net/ae)

**UNITED KINGDOM**

WEG ELECTRIC MOTORS (U.K.) LTD.\*  
Broad Ground Road - Lakeside Redditch,  
Worcestershire B98 8YP  
Phone: + 44 1527 513800  
[www.weg.net/uk](http://www.weg.net/uk)

**ERIKS \***

Amber Way, B62 8WG Halesowen  
West Midlands  
Phone: + 44 (0)121 508 6000

**BRAMMER GROUP \***

PLC43-45 Broad St, Teddington  
TW11 8QZ  
Phone: + 44 20 8614 1040

**USA**

WEG ELECTRIC CORP.  
6655 Sugarloaf Parkway, Duluth, GA 30097  
Phone: +1 678 2492000  
[www.weg.net/us](http://www.weg.net/us)

**VENEZUELA**

WEG INDUSTRIAS VENEZUELA C.A.  
Centro corporativo La Viña Plaza,  
Cruce de la Avenida Carabobo con la calle  
Uzlar de la Urbanización La Viña / Jurisdicción  
de la Parroquia San José - Valencia  
Oficinas 06-16 y 6-17, de la planta tipo 2, Nivel  
5, Carabobo  
Phone: (58) 241 8210582  
[www.weg.net/ve](http://www.weg.net/ve)

\* European Union Importers

