

YASKAWA AC Drive GA700

High Performance Type

Technical Manual

Type: CIPR-GA70Axxxxxxx
Models: 200 V class: 0.4 to 110 kW
400 V class: 0.4 to 355 kW

To properly use the product, read this manual thoroughly and retain for easy reference, inspection, and maintenance. Ensure the end user receives this manual.

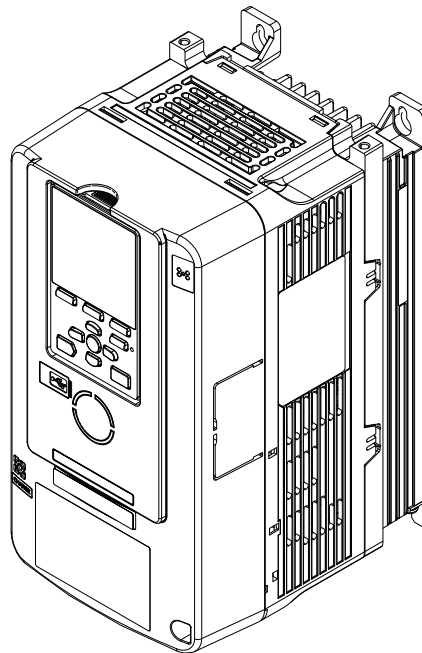

Receiving	1
Mechanical & Electrical Installation	2
Initial SetUp TrialRUN	3
Standards Compliance	4
Network Communications	5
Troubleshooting	6
Periodic Inspection & Maintenance	7
Disposal	8
Specifications	9
Parameter List	10
Parameter Details	11

This Page Intentionally Blank

Table of Contents

i.	Preface and General Precautions	13
i.1	Receiving	14
	About Terms and Abbreviations in This Document	14
	About Registered Trademarks	14
i.2	Using the Product Safely	15
	Supplemental Safety Information	15
	Safety Precautions	15
	Warning Label Content and Locations	17
i.3	Warranty Information	18
	Warranty Period	18
	Warranty Scope	18
	Warranty and Exclusion of Liability	18
1.	Receiving	19
1.1	Section Safety	20
1.2	Receiving	21
	Nameplate	21
	How to Read Model Numbers	21
2.	Mechanical & Electrical Installation	25
2.1	Safety Precautions	26
2.2	Installation Environment	29
2.3	Installation Orientation and Spacing	30
2.4	Transport	32
	Using the Hanging Brackets to Move the Drive	32
2.5	Drive Watt Loss	33
2.6	Remove or Install the Keypad	36
	Remove the Keypad	36
	Reattach the Keypad	36
2.7	Install the Keypad on the Control Panel or Other Devices	37
	Operate the Keypad Apart from the Drive	37
	Install Keypad Apart From Drive	37
2.8	Removing/Reattaching the Cover	42
	Removing/Reattaching the Cover Using Procedure A	42
2.9	Change the Drive's Enclosure Type	44
	Attach the Protective Cover (Procedure A)	44
2.10	Installation Procedure	46
2.11	Electrical Installation	50
	Standard Connection Diagram	50
2.12	Main Circuit Wiring	53
	Main Circuit Wiring	53

	Configuration of Main Circuit Terminal Block	53
	Main Circuit Terminal Functions	54
	Main Circuit Wire Gauges and Tightening Torques	55
	Main Circuit Terminal and Motor Wiring	64
	Protection of Main Circuit Terminals	67
2.13	Wiring Procedure for the Main Circuit Terminal Block	68
	Wiring the Main Circuit Terminal Block Using Procedure A	68
2.14	Control Circuit Wiring	71
	Control Circuit Connection Diagram	71
	Control Circuit Terminal Block Functions	72
	Control Circuit Terminal Configuration	75
	Wiring the Control Circuit Terminal	77
	Switches and Jumpers on the Terminal Board	78
2.15	Control I/O Connections	80
	Pulse Train Output	80
	Setting Sink Mode/Source Mode	81
	Selection of Input Signals for Terminals A1 to A3 of Multi-Function Analog Input	81
	Select Input Signal for Terminal A3 of Multi-Function Analog Input	82
	Select Output Signals for FM, AM Terminals of Multi-function Analog Monitor Output	82
	Switch ON Termination Resistor for MEMOBUS/Modbus Communications	83
2.16	External Interlock	84
2.17	Install Braking Resistor	85
	Installing a Braking Resistor: ERF Type	85
	Installing a Braking Resistor Unit : LKEB Type	85
	Installing a Braking Unit Connection: CDBR Type	86
	Connect Braking Units in Parallel	86
	Dynamic Braking Option Overload Protection	87
2.18	Protect Drive Wiring	88
	Installing a Molded-Case Circuit Breaker (MCCB) or Earth Leakage Circuit Breaker (ELCB)	88
	Installing a Ground Fault Circuit Interrupter	88
2.19	Dynamic Braking Option, Motor Protection	89
	Installing an Electromagnetic Contactor (MC) at Input Side of Drive	89
	Installing a Thermal Overload Relay on the Drive Output	89
2.20	Improving the Power Factor	91
	Connecting an AC Reactor or DC Reactor	91
2.21	Preventing the Passage of Switching Surge	92
2.22	Reducing Noise	93
	Connecting a Noise Filter to Input Side (Primary Side)	93
	Connecting a Noise Filter to (Secondary Side)	93
2.23	Protect Drive at Failure	95
	Factory Recommended Branch Circuit Protection	95
2.24	Wiring Checklist	99
2.25	Motor Application Precautions	101
	Use with Existing Standard Motors	101
	Use with PM Motors	102
	Precautions Concerning Use of Specialized Motors	102
	Notes on Power Transmission Mechanism	103
3.	Initial SetUp TrialRUN	105
3.1	Safety Precautions	106
3.2	Keypad	107
	LCD Display	109
	LED Indications of the Keypad	110

	Keypad Modes and Menus	111
3.3	LED Status Ring	113
3.4	Start-up Procedures	115
	Flowchart A (Connect Motor and Run It With Minimal Setting Changes).....	115
	Sub-Chart A1 (Induction Motor Auto-Tuning and Test Run Procedure)	116
	Sub-Chart A-2 (PM Motor Auto-Tuning and Test Run Procedure)	117
	Subchart A-3 (EZ Open Loop Vector Control Test Run Procedure)	119
3.5	Items to Check before Starting Up Drive	120
	Check before Powering Up Drive	120
	Check after Powering Up Drive	120
	Perform the Initial Settings.....	121
3.6	Keypad Operation	122
	Use the HOME Screen.....	122
	Show the Monitor	123
	Set Monitoring Favorites	124
	Show Monitoring Favorites	124
	Set Monitor to be Displayed as Bar Graph	125
	Display Monitor as Bar Graph	126
	Set Monitor to be Displayed as Analog Meter	127
	Show Monitor as Analog Meter	128
	Change Parameter Setting Values	129
	Checking Commonly Used Parameters	130
	Saving a Backup of Parameters	131
	Writing Backed-Up Parameters to the Drive.....	132
	Verify Keypad Parameters and Drive Parameters	133
	Checking Modified Parameters	134
	Restoring Default Settings for Modified Parameters	136
	Display Fault History	137
	Perform Auto-Tuning	138
	Select Language of Display for Keypad	140
	Set the Date and Time	141
	Use Setup Wizard to Set Parameters	143
	Disable the Start-Up Screen	144
	Start Data Logging	145
	Set Data to Log.....	146
	Set Backlight to Be Automatically OFF	148
	Display the Drive Information	149
3.7	Automatic Parameter Settings Optimized for Specific Applications	151
3.8	Auto-Tuning	153
	Auto-Tuning for Induction Motors	153
	Auto-Tuning for PM Motors	154
	EZ Tuning	156
	ASR and Inertia Tuning	157
	Precautions to Note before Auto-Tuning.....	158
3.9	Test Run	161
	No-Load Test Run	161
	Perform a No-Load Test Run.....	161
	Actual-Load Test Run.....	161
	Perform an Actual-Load Test Run	162
3.10	Fine Tuning during Test Runs (Adjustment of Control Functionality)	163
	V/f Control and Closed Loop V/f Control.....	163
	Open Loop Vector Control Method	164
	Closed Loop Vector Control Method	167
	Advanced Open Loop Vector Control Method	168
	Open Loop Vector Control Method for PM	169
	Advanced Open Loop Vector Control Method for PM	171
	Closed Loop Vector Control Method for PM	171

	EZ Open Loop Vector Control Method	172
3.11	Test Run Checklist	173
4.	Standards Compliance	177
4.1	Safety Precautions	178
4.2	European Standards	180
	CE Low Voltage Directive Compliance	180
	EMC Directive	195
4.3	UL Standards	203
	Area of Use	203
	Main Circuit Terminal Wiring	203
	Low Voltage Wiring for Control Circuit Terminals	217
	Drive Motor Overload and Overheat Protection	218
4.4	Safe Disable Input	224
	Specification	224
	Notes	225
	Using the Safe Disable Function	225
5.	Network Communications	229
5.1	Safety Precautions	230
5.2	Field Bus Network Support	231
5.3	MEMOBUS/Modbus Communications	232
	Configure Master/Slave	232
	Communication Specifications	232
	Communication with PLC	232
	Drive Operations by MEMOBUS/Modbus	234
	Communications Timing	234
	Message Format	235
	Examples of Messages for Commands/Responses	237
	Enter Command	238
	Self-Diagnostics	239
	Communications Data Table	240
	Error Code	261
6.	Troubleshooting	263
6.1	Safety Precautions	264
6.2	Types of Faults, Minor Faults, Alarms, and Errors	266
6.3	List of Fault, Minor Fault, Alarm, and Error Codes	267
6.4	Fault	273
6.5	Minor Faults/Alarms	296
6.6	Parameter Setting Errors	309
6.7	Auto-Tuning Errors	315
6.8	Backup Function Operating Mode Display and Errors	320
6.9	Diagnosing and Resetting Faults	322
	Fault Occurs Simultaneously with Power Loss	322
	If the Drive Still has Power After a Fault Occurs	322
	Fault Reset	322
6.10	Troubleshooting without Fault Display	323
	Cannot Change Parameter Settings	323
	Motor Does Not Rotate After Entering Run Command	323
	Motor Rotates in the Opposite Direction from the Run Command	325
	Motor Rotates in One Direction Only	325
	Motor is Too Hot	325
	Drive Does Not Allow Selection of the Desired Auto-Tuning Mode	326
	Motor Stalls during Acceleration or Accel/Decel Time is Too Long	326

Drive Frequency Reference Differs from the Controller Frequency Reference Command	327
Unstable Motor Speed When Using PM Motor	327
Excessive Motor Oscillation and Erratic Rotation	328
Deceleration Takes Longer Than Expected with Dynamic Braking Enabled	328
Load Falls When Brake is Applied	328
Noise From Drive or Motor Cables When the Drive is Powered On	329
Earth Leakage Circuit Breaker (ELCB) Trips During Run	329
Unexpected Noise from Connected Machinery Occurs When Motor Rotates	329
Oscillation or Hunting Occurs When Motor Rotates	329
PID Output Fault	330
Insufficient Starting Torque	330
Motor Rotates after the Drive Output is Shut Off	330
Output Frequency is not as High as Frequency Reference	330
Sound from Motor	331
Motor Does Not Restart after Power Loss	331
7. Periodic Inspection & Maintenance	333
7.1 Section Safety	334
7.2 Inspection	336
Recommended Daily Inspection	336
Recommended Periodic Inspection	336
7.3 Maintenance	339
7.4 Replace a Cooling Fan and Circulation Fan	342
Number of Cooling Fans and Circulation Fans Used	342
Replace a Fan (Procedure A)	342
Replace a Fan (Procedure B)	344
Replace a Fan (Procedure C)	346
7.5 Replace the Drive	349
About the Control Circuit Terminal Block	349
Replace the Drive	349
7.6 Replace the Keypad Battery	353
7.7 Storage Guidelines	355
8. Disposal	357
8.1 Section Safety	358
8.2 Disposal Instructions	359
9. Specifications	361
9.1 Safety Precautions	362
9.2 Heavy Duty and Normal Duty Ratings	363
9.3 Model Specifications (200 V Class)	364
9.4 Model Specifications (400 V Class)	367
9.5 Drive Specifications	371
9.6 Drive Derating	375
Carrier Frequency Settings and Rated Current Value	375
Altitude Derating	378
9.7 Drive Exterior and Mounting Dimensions	379
Open Chassis Type (IP20)	379
Enclosed Wall-mounted Type (UL Type 1)	381
9.8 Knock-out Hole Dimensions (UL Type 1)	385
9.9 Peripheral Devices and Options	386
10. Parameter List	391

10.1	Section Safety	392
10.2	How to Read the Parameter List	393
	Icons and Terms Used to Represent Control Modes	393
10.3	Parameter Groups	394
10.4	A: Initialization Parameters	398
	A1: Initialization	398
	A2: User Parameters	399
10.5	b: Application	400
	b1: Operation Mode Selection	400
	b2: DC Injection Braking and Short Circuit Braking	401
	b3: Speed Search	402
	b4: Timer Function	404
	b5: PID Control	405
	b6: Dwell Function	408
	b7: Droop Control	409
	b8: Energy Saving	409
	b9: Zero Servo	410
10.6	C: Tuning	411
	C1: Accel and Decel Times	411
	C2: S-Curve Characteristics	411
	C3: Slip Compensation	412
	C4: Torque Compensation	413
	C5: Automatic Speed Regulator (Automatic Speed Regulator)	414
	C6: Carrier Frequency	416
10.7	d: Reference Settings	417
	d1: Frequency reference	417
	d2: Reference Limits	419
	d3: Jump Frequency	419
	d4: Frequency Reference Hold and Up/Down 2 Function	420
	d5: Torque Control	421
	d6: Field Weak & Field Force	421
	d7: Offset Frequency	422
10.8	E: Motor Parameters	423
	E1: V/f Pattern for Motor 1	423
	E2: Motor Parameters	424
	E3: V/f Pattern for Motor 2	425
	E4: Motor 2 Parameters	426
	E5: PM Motor Settings	427
	E9: Motor Setting	427
10.9	F: Options	429
	F1: PG Speed Control Card (Encoder)	429
	F2: Analog Input Option	431
	F3: Digital Input Option	432
	F4: Analog Monitor Option	433
	F5: Digital Output Option	434
	F6: Communication Option and Ethernet Option	435
	F7: Communication Option and Ethernet Option	439
10.10	H: Terminal Functions	444
	H1: Multi-Function Digital Inputs	444
	H2: Multi-function digital output	450
	H3: Multi-Function Analog Inputs	458
	H4: Analog Outputs	461
	H5: MEMOBUS/Modbus Communication	462
	H6: Pulse Train Input/Output	463
	H7: Virtual Multi-Function I/O	464
10.11	L: Protection Function	466

L1: Motor Protection	466
L2: Momentary Power Loss Ride-Thru	467
L3: Stall Prevention	468
L4: Speed Detection	470
L5: Fault Restart	471
L6: Torque Detection	471
L7: Torque Limit	472
L8: Hardware Protection	473
L9: Drive Protection 2	476
10.12 n: Special Adjustment	477
n1: Hunting Prevention	477
n2: SpdFeedbackDetectControl(AFR)Tun	478
n3: High Slip Braking (HSB)	478
n4: Observer	479
n5: Feed Forward Control	480
n6: Online Tuning	480
n7: EZ Drive	480
n8: PM Motor Control Tuning	481
10.13 o: Keypad-Related Settings	484
o1: Keypad Display Selection	484
o2: Keypad Operation	486
o3: Copy Function	487
o4: Maintenance Mon Settings	487
o5: Log Function	488
10.14 q: DriveWorksEZ Parameters	490
q1-01 to q8-40: Reserved for DriveWorksEZ	490
10.15 r: DWEZ Connection 1-20	491
r1-01 to r1-40: DriveWorksEZ Connection Parameters 1 to 20 (Upper / Lower)	491
10.16 T: Motor Tuning	492
T0: Tuning Mode Selection	492
T1: Induction Motor Auto-Tuning	492
T2: PM Motor Auto-Tuning	493
T3: ASR and Inertia Tuning	494
T4: EZ Tuning	494
10.17 U: Monitors	496
U1: Operation Status Monitor	496
U2: Fault Trace	498
U3: Fault History	501
U4: Maintenance Monitors	502
U5: PID Monitors	506
U6: Operation Status Monitors	507
U8: DriveWorksEZ Monitors	510
10.18 A1-02 [Motor 1 Control Mode] Dependent Parameters	511
10.19 E3-01 [Motor 2 Control Mode] Dependent Parameters	517
10.20 Parameters Changed by E1-03 [V/f Pattern Selection]	518
10.21 Defaults by Drive Model and Duty Rating ND/HD	520
200 V class	520
400 V class	530
10.22 Parameters Changed by PM Motor Code Selection	543
Yaskawa SMRA Series SPM Motors	543
Yaskawa SSR1 Series IPM Motors (Derated Torque)	544
Yaskawa SST4 Series IPM Motors (Constant Torque)	556
11. Parameter Details	569
11.1 Safety Precautions	570
11.2 A: Initialization Parameters	571

	A1: Initialization	571
	A2: User Parameters	590
11.3	b: Application	592
	b1: Operation Mode Selection	592
	b2: DC Injection Braking and Short Circuit Braking	604
	b3: Speed Search	607
	b4: Timer Function	616
	b5: PID Control	618
	b6: Dwell Function	634
	b7: Droop Control	635
	b8: Energy Saving	637
	b9: Zero Servo	641
11.4	C: Tuning	643
	C1: Accel and Decel Times	643
	C2: S-Curve Characteristics	647
	C3: Slip Compensation	648
	C4: Torque Compensation	652
	C5: Automatic Speed Regulator (ASR)	654
	C6: Carrier Frequency	664
11.5	d: Reference Settings	668
	d1: Frequency Reference	668
	d2: Reference Limits	674
	d3: Jump Frequency	675
	d4: Frequency Reference Hold and Up/Down 2 Function	677
	d5: Torque Control	681
	d6: Field Weakening and Field Forcing	687
	d7: Offset Frequency	688
11.6	E: Motor Parameters	689
	E1: V/f Pattern for Motor 1	689
	E2: Motor Parameters	697
	E3: V/f Pattern for Motor 2	700
	E4: Motor 2 Parameters	702
	E5: PM Motor Settings	705
	E9: Motor Setting	708
11.7	F: Options	711
	F1: PG Speed Control Card Encoder	711
	F2: Analog Input Option	718
	F3: Digital Input Option	720
	F4: Analog Monitor Option	724
	F5: Digital Output Option	727
	F6, F7: Communication Options	730
11.8	H: Terminal Functions	752
	H1: Multi-function digital input	752
	Multi-Function Digital Input Setting Values	756
	H2: Multi-function digital output	776
	H2 MFDO Parameters	779
	MFDO Setting Value	785
	H3: Multi-Function Analog In	800
	H3: MFAI Parameters	802
	Multi-Function Analog Input Terminal Settings	807
	H4: Analog Outputs	813
	H5: Memobus/Modbus Communication	816
	H6: Pulse Train Input/Output	820
	H7: Virtual Multi-Function I/O	823
11.9	L: Protection Function	827
	L1: Motor Protection	827
	L2: Momentary Power Loss Ride-Thru	833

L3: Stall Prevention	843
L4: Speed Detection	853
L5: Auto Restart	854
L6: Detection of Overtorque/Undertorque	856
L7: Torque Limit	861
L8: Drive Protection	864
L9: Drive Protection 2	873
11.10 n: Special Adjustment	874
n1: Hunting Prevention Function	874
n2: Speed Feedback Detection Control (AFR) Tuning	876
n3: High Slip Braking (HSB) and Overexcitation Braking	877
n4: Adv Vect Tune	881
n5: Feed Forward Control	884
n6: Online Tuning	886
n7: EZ Drive	887
n8: PM Motor Control Tuning	888
11.11 o: Keypad-Related Settings	897
o1: Keypad Display Selection	897
o2: Keypad Operation	903
o3: Copy Function	906
o4: Maintenance Mon Settings	907
o5: Log Function	910
11.12 T: Auto-Tuning	916
T0: Tuning Mode Selection	916
T1: InductionMotor Auto-Tuning	916
T2: PM Motor Auto-Tuning	919
T3: ASR and Inertia Tuning	922
T4: EZ Tuning	922
Index	926
Revision History	935

Preface and General Precautions

This chapter describes important safety precautions regarding the use of this product. Failure to follow these precautions may result in serious injury or death, and may lead to damage to this product or related devices and systems. Yaskawa shall not be held responsible for any injury or equipment damage as a result of failure to observe the precautions and instructions contained in this manual.

i.1	Receiving	14
i.2	Using the Product Safely	15
i.3	Warranty Information	18

i.1 Receiving

This instruction manual contains the information necessary to use the product correctly. Thoroughly read this manual before installing, wiring, operating, or performing maintenance and inspections. Make sure to read and understand the safety information and precautions before using the product.

◆ About Terms and Abbreviations in This Document

Representations Used in This Manual	Description
Drive	Yaskawa GA700 Drive
PM motor	PM motor (generic name for IPM motors and SPM motors)
IPM Motor	SSR1 series and SST4 series motors manufactured by Yaskawa
SPM Motor	SMRA series motors manufactured by Yaskawa
V/f	V/f Control
CL-V/f	Closed Loop V/f Control
OLV	Open Loop Vector Control
CLV	Closed Loop Vector Control
AOLV	Advanced OpenLoop Vector Control
OLV/PM	PM Open Loop Vector Control
AOLV/PM	PM Advanced Open Loop Vector
CLV/PM	PM Closed Loop Vector Control
EZOLV	EZ Open Loop Vector Control
HD	Heavy load
ND	Light load

◆ About Registered Trademarks

- CANopen is a registered trademark of CAN in Automation (CIA).
- CC-Link is a registered trademark of CC-Link Partner Association.
- DeviceNet is a registered trademark of Open DeviceNet Vendor Association, Inc. (ODVA).
- EtherCAT is a registered trademark of Beckhoff Automation GmbH.
- EtherNet/IP is a registered trademark of Open DeviceNet Vendor Association, Inc. (ODVA).
- LonWorks and LonTalk are registered trademarks of Echelon Corporation.
- MECHATROLINK-I, MECHATROLINK-II, and MECHATROLINK-III are registered trademarks of MECHATROLINK Members Association (MMA).
- Modbus is a registered trademark of Schneider Electric SA.
- PROFIBUS-DP and PROFINET are registered trademarks of PROFIBUS International.
- Other company names and product names that appear in this document are trademarks or registered trademarks of the respective companies.

i.2 Using the Product Safely

◆ Supplemental Safety Information

The following labels are used in this manual to categorize and emphasize important safety precautions.

⚠ WARNING

Read and understand this manual before installing, operating or servicing this drive. The drive must be installed according to this manual and local codes.

The following conventions are used to indicate safety messages in this manual. Failure to heed these messages could result in serious or fatal injury or damage to the products or to related equipment and systems.

⚠ DANGER

Indicates a hazardous situation, which, if not avoided, will cause death or serious injury.

⚠ WARNING

Indicates a hazardous situation, which, if not avoided, could cause death or serious injury.

⚠ CAUTION

Indicates a hazardous situation, which, if not avoided, could cause minor or moderate injury.

NOTICE

Indicates a property damage message.

◆ Safety Precautions

General Precautions

- Some of the diagrams in this instruction manual are drawn with covers or safety shielding removed to explain particular details. When operating the product, be sure to return the prescribed covers and safety shielding to their original positions, and to follow the descriptions in this instruction manual.
- The diagrams in this instruction manual are representative examples, and may differ from the product as actually delivered.
- The instruction manual are subject to change as necessary due to improvement of the product, change in specifications, and improvement in the usability of the instruction manual itself.
- If this instruction manual is damaged or lost and a new one must be ordered, contact your Yaskawa representative or the nearest Yaskawa sales office shown on the rear cover of the manual, and inform them of the document number on the front cover.

⚠ DANGER

Heed the safety messages in this manual. Failure to comply will result in death or serious injury.

The operating company is responsible for any injuries or equipment damage resulting from failure to heed the warnings in this manual.

Electrical Shock Hazard

Do not perform inspections or wiring while the drive is energized. De-energize all devices before carrying out any wiring or repair operations. Voltage will remain within the capacitors inside the drive even after the power has been switched off. The Charge LED is extinguished once the DC bus voltage goes below 50 V DC. To prevent electric shock, always wait for at least the amount of time indicated on the warning labels and confirm that all indicators are OFF. Then, remove the front cover and terminal cover, measure the input power supply voltage and the DC bus voltage, and make sure that the voltages have been lowered to safe levels.

Failure to comply may result in death or serious injury.

⚠ WARNING

Crash Hazard

Conduct test operations to make sure that the drive operates safely after writing work is completed and parameters have been set.

Failure to comply may cause injury or damage to equipment.

Make sure to confirm the setting values for virtual input and output function parameters before performing drive test runs.

Virtual input and output functions may have different default settings and operation even though the input and output terminals are not wired as the drive input and output terminals are virtually wired internally. Using the drive before confirming these settings and operation may cause injury due to unexpected operation of the drive.

Sudden Movement Hazard

Clear all personnel from the drive, motor, and machine area and secure covers, couplings, shaft keys, and machine loads before energizing the drive.

Failure to comply could cause death or serious injury if the system starts unexpectedly upon application of power.

When using DriveWorksEZ to create custom programming, the drive I/O terminal functions change from factory settings and the drive will not perform as outlined in this manual. Be sure to check the I/O signals and internal sequence with the engineer who created the DriveWorksEZ program before attempting operation.

Unpredictable equipment operation may result in death or serious injury.

Electrical Shock Hazard

Do not attempt to modify or alter the drive or drive circuitry in any way not explained in this manual.

Failure to comply could cause death or serious injury and will void warranty. Yaskawa is not responsible for any modification of the product made by the user. Do not modify this product.

Only authorized persons qualified in electrical work should perform installation, wiring, maintenance, inspections, parts replacement, and repairs.

Failure to comply may cause electrical shock.

Do not remove covers or touch circuit boards while the power is on.

Failure to comply could cause death or serious injury.

Fire Hazard

Do not use the main circuit power supply (Overcurrent Category III) at improper voltages. Before applying power, make sure the drive rated voltage and the power supply voltage match.

Using the main circuit power supply at improper voltages may result in batteries bursting and igniting, which could cause fire and injury.

Install adequate branch circuit short circuit protection per applicable codes and this manual. The drive is suitable for circuits capable of delivering not more than 100,000 RMS symmetrical amperes, 240 Vac maximum (200 V class), 480 Vac maximum (400 V class).

Failure to comply could cause death or serious injury.

⚠ CAUTION

Crush Hazard

Do not carry the drive by the front cover or terminal cover. Make sure that screws are tightened properly during transport.

The cover of the drive may come off and the drive may fall if it is carried by the front cover or terminal cover or if screws are loose, which can result in injury.

NOTICE

Use a motor that provides insulation suitable for PWM drives.

Failure to comply may cause a short circuit or ground fault due to insulation deterioration.

Observe proper electrostatic discharge (ESD) procedures when handling the drive and circuit boards.

Failure to comply could cause ESD damage to the drive circuitry.

Do not perform a withstand voltage test or megger test on any part of the drive.

Failure to comply could damage the sensitive devices within the drive.

Do not connect or operate any equipment with visible damage or missing parts.

Failure to comply could further damage the equipment.

Do not energize the power or operate equipment soon after a fuse blows or the circuit breaker (ELCB) trips. Check the condition of cable wiring and peripheral devices to identify the root cause. If the root cause cannot be determined, do not turn on the power or operate equipment. Contact Yaskawa Support immediately.

If it is necessary to use disinfect or debug wood material for packaging, use a method other than steam. Example: Heat treatment (core at 56 °C or higher for over 30 minutes)

Gas steam produced from fumigated wooden packing materials can severely damage electrical components (both individual parts and entire devices). Halogen disinfectants (fluorine, chlorine, bromine, and iodine) cause capacitors to erode, and DOP gas (phthalic acid ester) causes cracks in resin materials. Additionally, make sure any treatment is performed before packaging components and not after items have been packaged.

◆ Warning Label Content and Locations

Warning labels can be found at the following locations on the product. The product must be used in accordance with this information.

400-089-791-001	
<p>⚠ WARNING</p> <p>⚠ Risk of electric shock. Read manual before installing. Wait 5 minutes for capacitor discharge after removing power and opening the manual switch between the drive and motor.</p>	<p>⚠ Hot surfaces. Top and Side surfaces may become hot. Do not touch.</p>
<p>⚠ AVERTISSEMENT</p> <p>⚠ Risque de choc électrique. Lire le manuel avant l'installation. Attendre 5 minutes après avoir coupé l'alimentation et déconnecté la protection entre le driver et le moteur, pour permettre la décharge des condensateurs.</p>	<p>⚠ Surfaces chaudes. Dessus et cotés du boîtier peuvent devenir chauds. Ne pas toucher.</p>
<p>⚠ 警告</p> <p>⚠ けが、感電のおそれがあります。 据え付け、運転の前には必ず取扱説明書を読んでもください。通電中および電源遮断後5分以内、出力側開閉器遮断後5分以内は保守・点検、配線を行わないでください。</p>	<p>⚠ 高温注意。 インバータ上部、両側面は高温になります。触らないでください。</p>

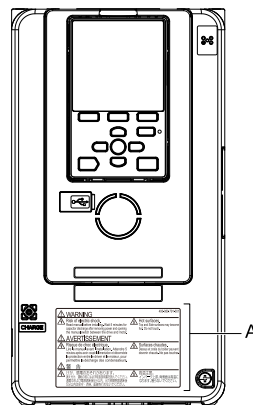

A - Warning label

Figure i.1 Warning Label Content and Locations

i.3 Warranty Information

◆ Warranty Period

The period less than one year after delivery to you or your customers, or within 18 months after shipping from Yaskawa's factory, whichever is shorter.

◆ Warranty Scope

- Failure diagnosis

The primary failure diagnosis shall be performed by your company as a rule.

By your company's request, however, we or our service sector can execute the work for your company for pay. In such a case, if the cause of the failure is in our side, the work is free.

- Repair

When a failure occurred, repairs, replacement, and trip to the site for repairing the product shall be free of charge. However, the following cases have to be paid.

- Cases of failure caused by inappropriate storing, handling, careless negligence, or system design errors performed by you or your customers.
- Cases of failure caused by a modification performed by your company without our approval.
- Cases of failure caused by using the product beyond the specification range.
- Cases of failure caused by force majeure such as natural disaster and fire.
- Cases in which the warranty period has expired.
- Cases of replacement of consumables and other parts with limited service life.
- Cases of product defects caused by packaging or fumigation processing.
- Cases of malfunction or errors caused by programs created by you using DriveWorksEZ.
- Other failures caused by reasons for which Yaskawa is not liable.

The services described above are available in Japan only. Please understand that failure diagnosis is not available outside of Japan. If overseas after-sales service is desired, consider registering for the optional overseas after-sales service contract.

- Exception of Guaranteed Duty

Lost business opportunities and damage to your property, including your customers and other compensation for work, is not covered by the warranty regardless of warranty eligibility, except when caused by product failure of Yaskawa products.

◆ Warranty and Exclusion of Liability

- This product is not designed and manufactured for use in life-support machines or systems.
- Contact a Yaskawa representative or your Yaskawa sales representative if you are considering the application of this product for special purposes, such as machines or systems used for passenger cars, medicine, airplanes and aerospace, nuclear power, electric power, or undersea relaying.

⚠ WARNING

Injury to Personnel

This product has been manufactured under strict quality-control guidelines. Install appropriate safety devices to minimize the likelihood of any accident when installing the device in a location where failure of this product could involve or cause a life-and-death situation, loss of human life, or in a facility where failure could cause a serious accident or physical injury.

Receiving

This chapter explains how to inspect the drive upon receipt, and gives an overview of the different drives available and their features.

1.1	Section Safety	20
1.2	Receiving	21

1.1 Section Safety

 **DANGER**

Heed the safety messages in this manual. Failure to comply will result in death or serious injury.

The operating company is responsible for any injuries or equipment damage resulting from failure to heed the warnings in this manual.

1.2 Receiving

Please perform the following tasks after receiving the drive:

- Inspect the drive for damage. If the drive appears damaged upon receipt, contact the shipper immediately. Damage as a result of transportation is not covered by the product warranty.
- Verify receipt of the correct model by checking the model number. The model number can be found in the "MODEL" column printed on the nameplate on the right side of the drive.
- If you have received the wrong model or the drive does not function properly, contact your supplier.

◆ Nameplate

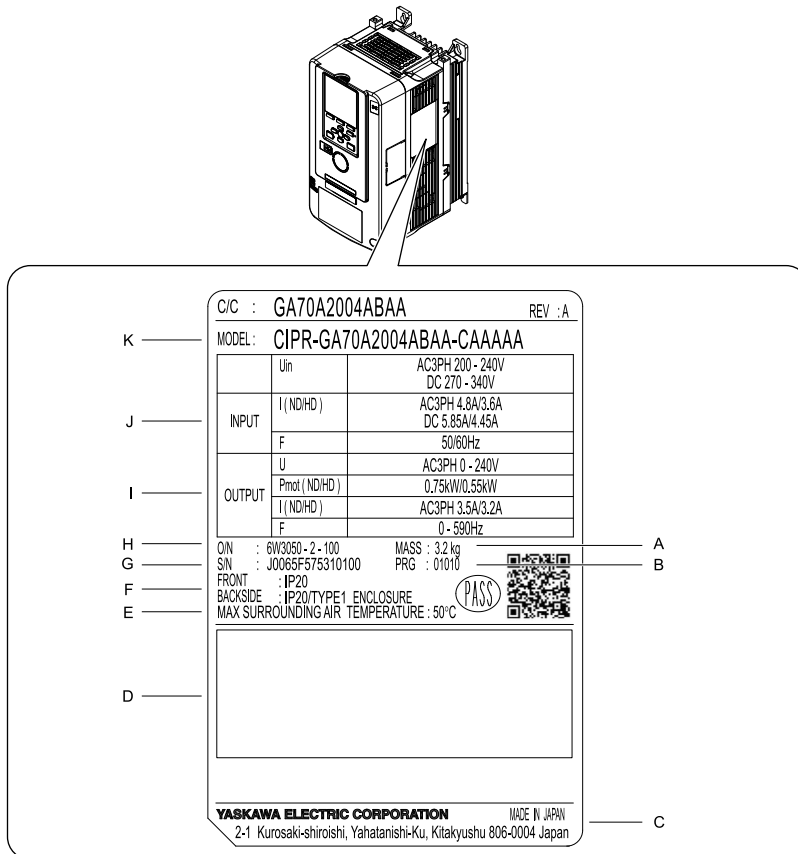

- A - Mass
- B - Drive software version
- C - The address of the head office of Yaskawa Electric Corporation
- D - Accreditation standards
- E - Surrounding air temperature
- F - Protection design
- G - Serial number
- H - Lot number
- I - Output specifications
- J - Input specifications
- K - Drive model

Figure 1.1 Nameplate Information Example

◆ How to Read Model Numbers

The following diagram and table describe how to read model numbers for drives.

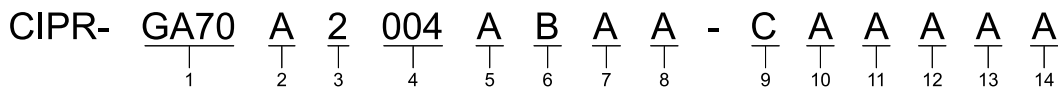

Figure 1.2 Drive model

Table 1.1 Model Number Details

No.	Description
1	Product series
2	Region code <ul style="list-style-type: none"> • A: Japan • B: China • C: Europe • D: India • K: Korea • T: Asia (Singapore and Taiwan) • U: the Americas
3	Input power supply voltage <ul style="list-style-type: none"> • 2: Three-phase AC 200 V • 4: Three-phase AC 400 V
4	Rated Output Current <p>Note: Refer to the rated output current list for more information.</p>
5	EMC noise filter <ul style="list-style-type: none"> • A: No internal EMC filter • B: Internal category C3 EMC filter • C: Internal category C2 EMC filter
6	Protection Design <ul style="list-style-type: none"> • B: IP20 • F: IP20, UL Type 1
7	Environmental specification <ul style="list-style-type: none"> • A: Standard • K: Gas-resistant • M: Humidity-resistant and dust-resistant • N: Oil-resistant • P: Humidity-resistant, dust-resistant, and vibration-resistant • R: Gas-resistant and vibration-resistant • S: Vibration-resistant • T: Oil-resistant and vibration-resistant <p>Note: Drives with these specifications do not guarantee complete protection for the environmental conditions indicated.</p>
8	Design revision order
9	Control circuit terminal board <ul style="list-style-type: none"> • A: Relay output/screw clamp terminal board type • B: Relay output/spring clamp terminal board type • C: Photocoupler output/screw clamp terminal board type
10	Option card (connector CN5-A) <ul style="list-style-type: none"> • A: No option card • D: AI-A3 (Analog Input) • E: DI-A3 (Digital Input) • F: SI-C3 (CC-Link) • G: SI-ET3 (MECHATROLINK-III) • H: SI-N3 (DeviceNet) • J: SI-P3 (PROFIBUS-DP) • K: SI-T3 (MECHATROLINK-II) • L: SI-W3 (LonWorks) • M: SI-S3 (CANopen)
11	Option card (connector CN5-B) <ul style="list-style-type: none"> • A: No option card • B: AO-A3 (Analog Monitor) • C: DO-A3 (Digital Output) • U: PG-B3 (Complementary Type PG) • V: PG-X3 (Motor PG Feedback Line Driver Interface)

No.	Description
12	Option card (connector CN5-C) <ul style="list-style-type: none"> • A: No option card • U: PG-B3 (Complementary Type PG) • V: PG-X3 (Motor PG Feedback Line Driver Interface) • W: PG-F3 (encoder interface (for Endat and HIPERFACE)) • Z: PG-RT3 (Motor Feedback Resolver TS2640N321E64 Interface)
13	Keypad <ul style="list-style-type: none"> • A: LCD keypad • B: LCD keypad (humidity-resistant and dust-resistant) • F: LED keypad • G: LED keypad (humidity-resistant and dust-resistant)
14	Special applications <ul style="list-style-type: none"> A: Standard

The following table lists the rated output current.

Note:

- This table lists the output current values when operating drives at standard specifications.
- Current must be derated in the following circumstances.
 - Increasing the carrier frequency
 - Installing drives in environments of high ambient temperature
 - Installing drives side-by-side
- The normal duty rating (ND) and heavy duty rating (HD) can be configured with parameter C6-01 [*Normal / Heavy Duty Selection*].

■ Rated Output Current (Three-Phase AC 200 V)

Table 1.2 Rated Output Current (Three-Phase AC 200 V)

No.	Heavy Duty Rating (HD) [C6-01 = 0] (Default setting)		Normal Duty Rating (ND) [C6-01 = 1]	
	Max. Applicable Motor Output kW	Rated Output Current A	Max. Applicable Motor Output kW	Rated Output Current A
004	0.4	3.2	0.75	3.5
006	0.75	5	1.1	6
008	1.1	6.9	1.5	8
010	1.5	8	2.2	9.6
012	2.2	11	3	12.2
018	3	14	3.7	17.5
021	3.7	17.5	5.5	21
030	5.5	25	7.5	30
042	7.5	33	11	42
056	11	47	15	56
070	15	60	18.5	70
082	18.5	75	22	82
110	22	88	30	110
138	30	115	37	138
169	37	145	45	169
211	45	180	55	211
257	55	215	75	257
313	75	283	90	313

No.	Heavy Duty Rating (HD) [C6-01 = 0] (Default setting)		Normal Duty Rating (ND) [C6-01 = 1]	
	Max. Applicable Motor Output kW	Rated Output Current A	Max. Applicable Motor Output kW	Rated Output Current A
360	90	346	110	360
415	110	415	-	-

■ Rated Output Current (Three-Phase AC 400 V)

Table 1.3 Rated Output Current (Three-Phase AC 400 V)

No.	Heavy Duty Rating (HD) [C6-01 = 0] (Default setting)		Normal Duty Rating (ND) [C6-01 = 1]	
	Max. Applicable Motor Output kW	Rated Output Current A	Max. Applicable Motor Output kW	Rated Output Current A
002	0.4	1.8	0.75	2.1
004	0.75	3.4	1.5	4.1
005	1.5	4.8	2.2	5.4
007	2.2	5.5	3.0	7.1
009	3.0	7.2	3.7	8.9
012	3.7	9.2	5.5	11.9
018	5.5	14.8	7.5	17.5
023	7.5	18	11	23.4
031	11	24	15	31
038	15	31	18.5	38
044	18.5	39	22	44
060	22	45	30	59.6
075	30	60	37	74.9
089	37	75	45	89.2
103	45	91	55	103
140	55	112	75	140
168	75	150	90	168
208	90	180	110	208
250	110	216	132	250
296	132	260	160	296
371	160	304	200	371
389	200	371	220	389
453	220	414	250	453
568	250	453	315	568
675	315	605	355	675

Mechanical & Electrical Installation

This chapter explains how to properly mount and install the drive, and to wire the control circuit terminals, motor, and power supply.

2.1	Safety Precautions	26
2.2	Installation Environment	29
2.3	Installation Orientation and Spacing	30
2.4	Transport	32
2.5	Drive Watt Loss	33
2.6	Remove or Install the Keypad	36
2.7	Install the Keypad on the Control Panel or Other Devices	37
2.8	Removing/Reattaching the Cover	42
2.9	Change the Drive's Enclosure Type	44
2.10	Installation Procedure	46
2.11	Electrical Installation	50
2.12	Main Circuit Wiring	53
2.13	Wiring Procedure for the Main Circuit Terminal Block	68
2.14	Control Circuit Wiring	71
2.15	Control I/O Connections	80
2.16	External Interlock	84
2.17	Install Braking Resistor	85
2.18	Protect Drive Wiring	88
2.19	Dynamic Braking Option, Motor Protection	89
2.20	Improving the Power Factor	91
2.21	Preventing the Passage of Switching Surge	92
2.22	Reducing Noise	93
2.23	Protect Drive at Failure	95
2.24	Wiring Checklist	99
2.25	Motor Application Precautions	101

2.1 Safety Precautions

DANGER

Electrical Shock Hazard

Do not perform inspections or wiring while the drive is energized. De-energize all devices before carrying out any wiring or repair operations. Voltage will remain within the capacitors inside the drive even after the power has been switched off. The Charge LED is extinguished once the DC bus voltage goes below 50 V DC. To prevent electric shock, always wait for at least the amount of time indicated on the warning labels and confirm that all indicators are OFF. Then, remove the front cover and terminal cover, measure the input power supply voltage and the DC bus voltage, and make sure that the voltages have been lowered to safe levels.

Failure to comply may result in death or serious injury.

WARNING

Electrical Shock Hazard

Do not operate equipment with covers removed. The diagrams in this section may include drives without covers or safety shields to illustrate details. Be sure to reinstall covers or shields before operating the drives and run the drives according to the instructions described in this manual.

Failure to comply could result in death or serious injury.

Ensure that the neutral point on the power supply of this product (model number 2xxxB/C, 4xxxA/B/C) is grounded for compliance with the EMC Directive before EMC filter is switched ON or if there is high resistance grounding.

Failure to comply could cause death or serious injury.

If the built-in EMC filter is turned on, the leakage current of the drive will exceed 3.5 mA. As written in the IEC/EN 61800-5-1 standard, the power supply should be wired so that it automatically turns off in the event the protective ground wire is disconnected, or else use a protective ground wire with a cross sectional area of at least 10 mm² (copper wire) or 16 mm² (aluminum wire).

Failure to meet these standards may result in injury or death.

Always use appropriate equipment for Earth Leakage Circuit Breaker (ELCB). The drive can cause a residual current with a DC component in the protective earthing conductor. Always use a type B ELCB where a residual current operated protective or monitoring device is used for protection in case of direct or indirect contact according to IEC/EN 60755.

Failure to comply could cause death or serious injury.

Do not perform work on the drive while wearing loose clothing or jewelry. Before servicing, secure loose clothing and remove all metal objects such as watches or rings.

Failure to comply could cause death or serious injury.

Do not remove covers or touch the circuit boards while the power is on.

Failure to comply could cause death or serious injury.

Only authorized persons qualified in electrical work should perform installation, wiring, maintenance, inspections, parts replacement, and repairs.

Failure to comply may cause electrical shock.

Do not attempt to modify or alter the drive or drive circuitry in any way not explained in this manual.

Failure to comply could cause death or serious injury and will void warranty. Yaskawa is not responsible for any modification of the product made by the user. Do not modify this product.

Fire Hazard

Tighten all terminal screws to the specified tightening torque.

Loose or overtightened connections could cause erroneous operation and damage to the terminal block or start a fire and cause death or serious injury.

⚠ WARNING

Do not place flammable or combustible materials on top of the drive and do not mount the drive to flammable or combustible materials. Attach the drive to metal or other noncombustible material.

Failure to comply could cause death or serious injury.

Do not use the main circuit power supply (Overcurrent Category III) at improper voltages. Before applying power, make sure the drive rated voltage and the power supply voltage match.

Using the main circuit power supply at improper voltages may result in batteries bursting and igniting, which could cause fire and injury.

When installing dynamic braking options, perform all wiring exactly as specified in the wiring diagrams provided.

Failure to do so can result in fire. Improper wiring may damage braking components.

When installing the drive into a closed cabin or cabinet, cool the drive using a cooling fan or cooler so that the intake air temperature to the drive is 50 °C or less for open chassis type drives, (IP20) and 40 °C or less for enclosed wall-mounted type (UL Type1) drives.

Failure to follow the instructions may result in the drive overheating and catching fire.

Crush Hazard

Only allow qualified personnel to operate a crane or hoist to transport the drive.

Failure to comply could cause death or serious injury from falling equipment.

Use screws to securely affix the drive front cover, terminal blocks, and other drive components prior to vertical suspension.

Failure to comply may result in serious injury or death from falling equipment.

Do not subject the drive to vibration or impact greater than 1.96 m/s² (0.2 G) while it is suspended by the cables.

Failure to comply may result in serious injury or death from falling equipment.

Do not attempt to flip the drive over or leave the drive unattended while it is suspended by the wires.

Failure to comply may result in serious injury or death from falling equipment.

Use a dedicated lifter when transporting the drive by a lifter.

Failure to comply could cause death or serious injury from falling equipment.

⚠ CAUTION**Crush Hazard**

Do not carry the drive by the front cover or terminal cover. Make sure that screws are tightened properly during transport.

The cover of the drive may come off and the drive may fall if it is carried by the front cover or terminal cover or if screws are loose, which can result in injury.

NOTICE

Prevent foreign matter such as metal shavings or wire clippings from falling into the drive during drive installation and project construction. Place a temporary cover over the top during installation and remove the temporary cover before start-up to prevent overheating from reduced ventilation.

Failure to comply could damage the drive.

Observe proper electrostatic discharge (ESD) procedures when handling the drive.

Failure to comply could result in ESD damage to the drive circuitry.

NOTICE

Reduce the motor torque in the low-speed range whenever using a standard blower cooled motor. If 100% torque is required continuously at low speed, consider using a special drive or vector-control motor. Select a motor that is compatible with the required load torque and operating speed range.

Operating the motor in the low-speed range diminishes the cooling effects, increases motor temperature, and may lead to motor damage by overheating.

The speed range for continuous operation differs according to the lubrication method and motor manufacturer. If the motor is to be operated at a speed higher than the rated speed, consult with the manufacturer.

Continuously operating an oil-lubricated motor in the low-speed range may result in burning.

When the input voltage is 440 V or higher or the wiring distance is greater than 100 meters, pay special attention to the motor insulation voltage or use a drive-rated motor with reinforced insulation.

Failure to comply could lead to motor winding failure.

Motor vibration may increase when operating a machine in variable-speed mode, if that machine previously operated at a constant speed.

Install vibration-proof rubber on the motor base or use the frequency jump function to skip a frequency resonating the machine.

The motor may require more acceleration torque with drive operation than with a commercial power supply. Set a proper V/f pattern by checking the load torque characteristics of the machine to be used with the motor.

The rated input current of submersible motors is higher than the rated input current of standard motors. Select an appropriate drive according to its rated output current. When the distance between the motor and drive is long, use a cable thick enough to connect the motor to the drive to prevent motor torque reduction.

When using an explosion-proof motor, it must be subject to an explosion-proof test in conjunction with the drive. This is also applicable when an existing explosion-proof motor is to be operated with the drive. Since the drive itself is not explosion-proof, always install it in a safe place.

Failure to comply could result in damage to the drive.

Do not the lift drive when it has its cover removed.

The drive board and terminal block may be damaged.

Do not use unshielded wire for control wiring. Use shielded, twisted-pair wires and ground the shield to the ground terminal of the drive.

Failure to comply could cause electrical interference resulting in poor system performance.

Carefully review instruction manual TOBPC72060001 before connecting a dynamic braking option to the drive.

Failure to comply could damage the drive or braking circuit.

Do not modify the drive circuitry.

Failure to comply could cause damage to the drive and will void warranty. Yaskawa is not responsible for any modification of the product made by the user.

Confirm that all connections are correct after installing the drive and connecting peripheral devices.

Failure to comply could damage the drive.

2.2 Installation Environment

The installation environment is crucial to ensure proper performance and the expected lifespan of the product. Ensure the installation environment satisfies the following specifications.

Environment	Conditions
Area of Use	Indoors
Power Supply	Overvoltage Category III
Ambient Temperature	<p>Open-chassis type (IP20): -10 °C to +50 °C (14 °F to 122 °F) Enclosed wall-mounted type (UL Type 1): -10 °C to +40 °C (14 °F to 104 °F)</p> <ul style="list-style-type: none"> Do not use the drive in an environment with sudden temperature changes or with condensation. Use a cooling fan or air conditioner to ensure that the internal air temperature does not exceed specifications when installing the drive in an enclosure. Do not allow the drive to freeze. Derate the output current and output voltage to install the drive in areas with ambient temperatures up to 60 °C (140 °F).
Humidity	<p>95% maximum relative humidity Do not allow condensation to develop on the drive.</p>
Storage Temperature	-20 °C to +70 °C (-4 °F to +158 °F)
Surrounding Area	<p>Pollution degree 2 or less Install the drive in an area free from the following:</p> <ul style="list-style-type: none"> Oil mist, corrosive gas, flammable gas, and dust Metal shavings, oil, water, or other foreign materials Radioactive materials or flammable materials, including wood Harmful gas or fluids Salt Direct sunlight <p>Keep wood or other flammable materials away from the drive.</p>
Altitude	<p>1000 m (3281 ft.) or lower</p> <p>Note: Derate the output current by 1% for every 100 m (328 ft.) to install the drive in altitudes between 1000 m to 3000 m (3281 ft. to 9843 ft.). Rated voltage derating is not required:</p> <ul style="list-style-type: none"> when installing the drive at 2000 m (6562 ft.) or lower if the drive is grounded with the neutral network when installing the drive at an altitude between 2000 m to 3000 m (6562 ft. to 9843 ft.) Contact Yaskawa or your nearest sales representative when the drive is not grounded with the neutral network.
Vibration	<ul style="list-style-type: none"> 10 Hz to 20 Hz: 1 G (9.8 m/s², 32.15 ft/s²) 20 Hz to 55 Hz: 2004 to 2211, 4002 to 4168: 0.6 G (5.9 m/s², 19.36 ft/s²) 2257 to 2415, 4208 to 4675: 0.2 G (2.0 m/s², 6.56 ft/s²)
Orientation	Install the drive upright to allow for proper cooling.

NOTICE: Do not place drive peripheral devices, transformers, or other electronics near the drive. Shield the drive from electrical interference when using such devices in proximity to the drive. Failure to comply could cause erroneous operation.

NOTICE: Prevent foreign matter such as metal shavings or wire clippings from falling into the drive during drive installation and project construction. Place a temporary cover over the top during installation and remove the temporary cover before start-up to prevent overheating from reduced ventilation. Failure to comply could damage the drive.

2.3 Installation Orientation and Spacing

Install the drive upright to allow for proper cooling.

Note:

Contact Yaskawa or your nearest sales representative for details on the drive models that can be installed horizontally and their operating conditions.

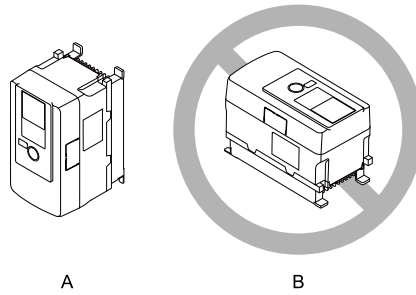

A - Upright installation

B - Horizontal installation

Figure 2.1 Installation Orientation

◆ Single Unit Installation

Install the drive with the clearances specified in [Figure 2.2](#) to guarantee sufficient space for wiring and airflow.

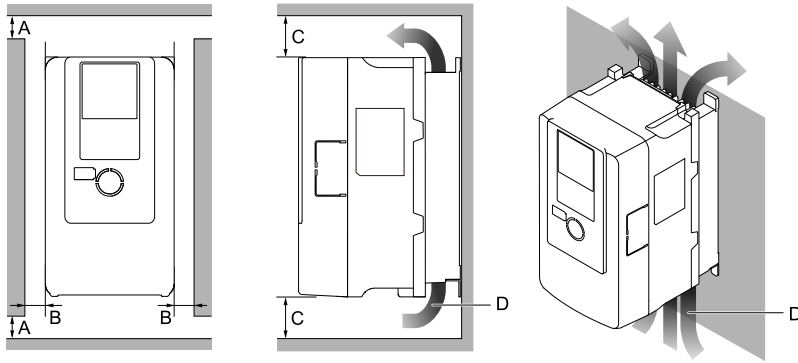

A - At least 50 mm (2 in.)

B - At least 30 mm (1.2 in.) on both sides

C - At least 120 mm (4.7 in.) above and below

D - Airflow direction

Figure 2.2 Drive Installation Space (Single Unit)

◆ Mounting Multiple Drives Side-by-Side

Drive models 2004xB to 2082xB and 4002xB to 4044xB can take advantage of side-by-side installation.

When installing other drive models, ensure that enough space for single unit installation is placed around each drive.

When performing side-by-side installation of drives, ensure that enough space is provided for the installation of the drives with the clearances specified in [Figure 2.3](#). Set L8-35 = 1 [*Installation Method Selection = Side-by-Side Mounting*].

Derate the output current to match the ambient temperature.

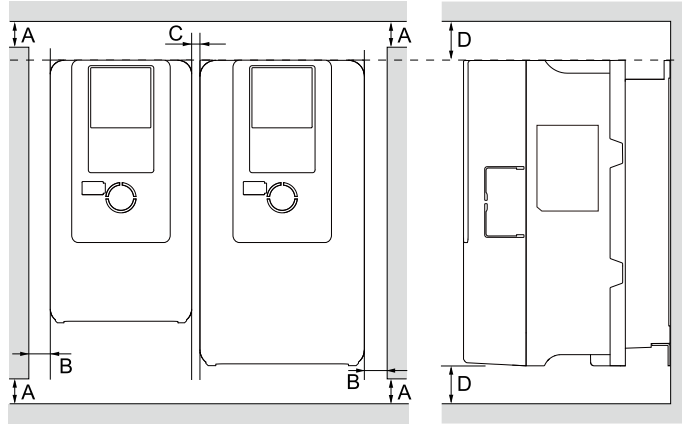

A - At least 50 mm (2 in.)
B - At least 30 mm (1.2 in.) on both sides

C - At least 2 mm (0.08 in.) between each drive

D - At least 120 mm (4.7 in.) above and below

Figure 2.3 Drive Installation Space (Side-by-Side Mounting)

Note:

- If the dimensions of the drives differ when using a side-by-side installation, then line up the tops of all the drives. This makes it easier to replace the cooling fan later.
- If mounting an enclosed wall-mounted type (UL Type 1) drive using a side-by-side installation, completely remove the top protective cover for the drive. Refer to “Attach the Top Protective Cover” to remove the top protective cover.

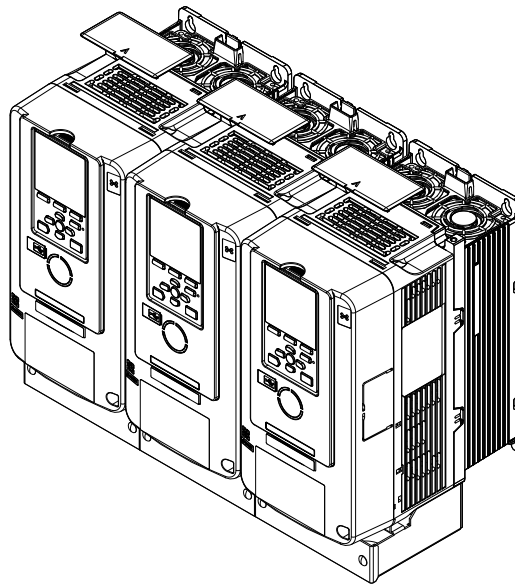

Figure 2.4 Enclosed Wall-Mounted Type (UL Type 1) Side-by-Side Mounting

2.4 Transport

Follow local laws and regulations when transporting and installing this product.

CAUTION! Crush Hazard. Do not carry the drive by the front cover or terminal cover. Make sure that screws are tightened properly during transport. The cover of the drive may come off and the drive may fall if it is carried by the front cover or terminal cover or if screws are loose, which can result in injury.

Drive Weight	Number of People Required to Transport
< 15 kg (33 lb)	1
≥ 15 kg (33 lb)	2 + using appropriate lifting equipment

Refer to the Technical Manual for details on using a suspension system, wires, or hanging metal brackets to transport the drive.

◆ Using the Hanging Brackets to Move the Drive

The hanging brackets attached to the drive are used to temporarily lift the drive during, for example, installation of the drive to a control panel or wall surface, or replacement of the drive. Do not leave the drive in a state of vertical or horizontal suspension, or transport the drive over a long distance in such a state. Before installing the drive, be sure to read the following precautions.

WARNING! Crush Hazard. Use screws to securely affix the drive front cover, terminal blocks, and other drive components prior to vertical suspension. Failure to comply may result in serious injury or death from falling equipment.

WARNING! Crush Hazard. Do not subject the drive to vibration or impact greater than 1.96 m/s² (0.2 G) while it is suspended by the cables. Failure to comply may result in serious injury or death from falling equipment.

WARNING! Crush Hazard. Do not attempt to flip the drive over or leave the drive unattended while it is suspended by the wires. Failure to comply may result in serious injury or death from falling equipment.

2.5 Drive Watt Loss

Table 2.1 Drive Watt Loss (200 V Class: Heavy Duty)

Model	Rated Output Current A	Carrier Frequency kHz	Interior Unit Loss W	Cooling Fin Loss W	Total Loss W
2004	3.2	8	23	9	32
2006	5	8	26	16	42
2008	6.9	8	30	24	54
2010	8	8	34	30	64
2012	11	8	42	45	87
2018	14	8	51	79	130
2021	17.5	8	56	103	159
2030	25	8	66	170	236
2042	33	8	73	201	274
2056	47	8	90	299	389
2070	*1				
2082					
2110					
2138					
2169					
2211					
2257					
2313					
2360					
2415					

*1 Contact Yaskawa or your nearest sales representative for details.

Table 2.2 Drive Watt Loss (200 V Class: Normal Duty)

Model	Rated Output Current A	Carrier Frequency kHz	Interior Unit Loss W	Cooling Fin Loss W	Total Loss W
2004	3.5	2	23	10	33
2006	6	2	27	17	44
2008	8	2	31	24	55
2010	9.6	2	37	32	69
2012	12.2	2	44	44	88
2018	17.5	2	52	83	135
2021	21	2	61	119	180
2030	30	2	72	205	277
2042	42	2	83	255	338
2056	56	2	96	341	437

2.5 Drive Watt Loss

Model	Rated Output Current A	Carrier Frequency kHz	Interior Unit Loss W	Cooling Fin Loss W	Total Loss W
2070					
2082					
2110					
2138					
2169					
2211					
2257					
2313					
2360					
2415					

*1 Contact Yaskawa or your nearest sales representative for details.

Table 2.3 Drive Watt Loss (400 V Class: Heavy Duty)

Model	Rated Output Current A	Carrier Frequency kHz	Interior Unit Loss W	Cooling Fin Loss W	Total Loss W
4002	1.8	8	25	14	39
4004	3.4	8	31	26	57
4005	4.8	8	36	37	73
4007	5.5	8	36	57	93
4009	7.2	8	37	64	101
4012	9.2	8	41	86	127
4018	14.8	8	59	140	199
4023	18	8	68	181	249
4031	24	8	80	260	340
4038	31	8	92	317	409
4044					
4060					
4075					
4089					
4103					
4140					
4168					
4208					
4250					
4296					
4371					
4414					
4453					
4568					
4675					

*1 Contact Yaskawa or your nearest sales representative for details.

Table 2.4 Drive Watt Loss (400 V Class: Normal Duty)

Model	Rated Output Current A	Carrier Frequency kHz	Interior Unit Loss W	Cooling Fin Loss W	Total Loss W
4002	2.1	2	24	10	34
4004	4.1	2	29	20	49
4005	5.4	2	34	27	61
4007	7.1	2	35	52	87
4009	8.9	2	37	59	96
4012	11.9	2	41	86	127
4018	17.5	2	58	139	197
4023	23.4	2	72	200	272
4031	31	2	80	274	354
4038	38	2	90	307	397
4044	*1				
4060					
4075					
4089					
4103					
4140					
4168					
4208					
4250					
4296					
4371					
4414					
4453					
4568					
4675					

*1 Contact Yaskawa or your nearest sales representative for details.

2.6 Remove or Install the Keypad

NOTICE: Be sure to remove the keypad prior to opening or reattaching the front cover. Firmly fasten the front cover back into place before reattaching the keypad. Leaving the keypad plugged into the drive when removing the front cover can result in erroneous operation caused by a poor connection.

◆ Remove the Keypad

1. While pressing on the hook located on the top of the keypad, pull the keypad forward to remove it from the drive.

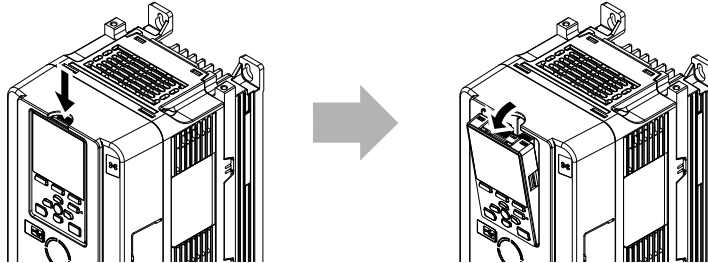
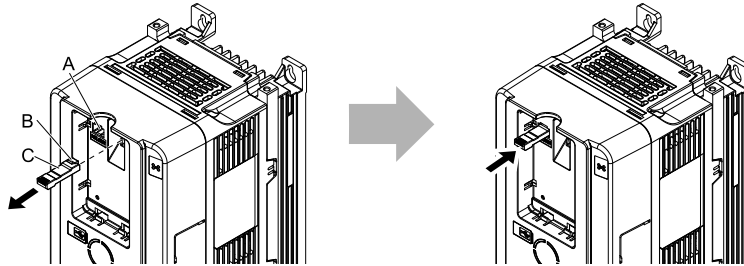

Figure 2.5 Remove the Keypad

2. Pull out the keypad connector and place it in the holder.

Note:

Insert the keypad connector in the direction of the hook.



A - Holder
B - Hook

C - Keypad connector

Figure 2.6 Place the Keypad Connector in the Holder

◆ Reattach the Keypad

Reconnect the keypad connector. Next, press gently on the top of the keypad until the hook clicks into place.

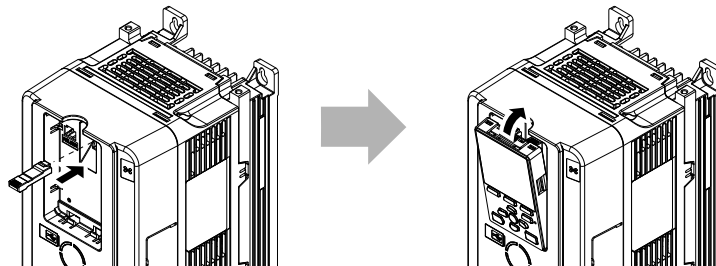

Figure 2.7 Reattach the Keypad

2.7 Install the Keypad on the Control Panel or Other Devices

◆ Operate the Keypad Apart from the Drive

The keypad mounted on the drive can be removed and connected to the drive using a remote control extension cable up to 3 m long to facilitate operation when the drive is installed in a location where it cannot be easily accessed. Even when the drive has been installed inside the control panel, it can be operated without the need for opening/closing the door to the control panel. To order optional accessories, contact Yaskawa or your nearest sales representative.

◆ Install Keypad Apart From Drive

The following method can be used to install the keypad in locations such as the door of the control panel containing the drive.

Table 2.5 Keypad Installation Method

Installation Method	Description	Required Tools and Installation Support Sets
Outside of control panel	Simplified installation is possible, and installation support sets sold separately are not required.	Phillips screwdriver #2 (M3)
Inside of control panel	Keypad does not extend beyond the front of the control panel.	<ul style="list-style-type: none"> Phillips screwdriver #2 (M3, M4) Installation support set A (for mounting with screws, model: xxx)
		<ul style="list-style-type: none"> Phillips screwdriver #2 (M3) Wrench (M4) Installation support set B (nut clamp, model: xxx)

Note:

Installation support sets are sold separately. Use installation support set B if there are weld studs inside the control panel. Contact Yaskawa or your nearest sales representative for more information of orders.

NOTICE: Prevent foreign matter such as metal shavings or wire clippings from falling into the drive during drive installation and project construction. Place a temporary cover over the top during installation and remove the temporary cover before start-up to prevent overheating from reduced ventilation. Failure to comply could damage the drive.

■ External Dimensions of Keypad

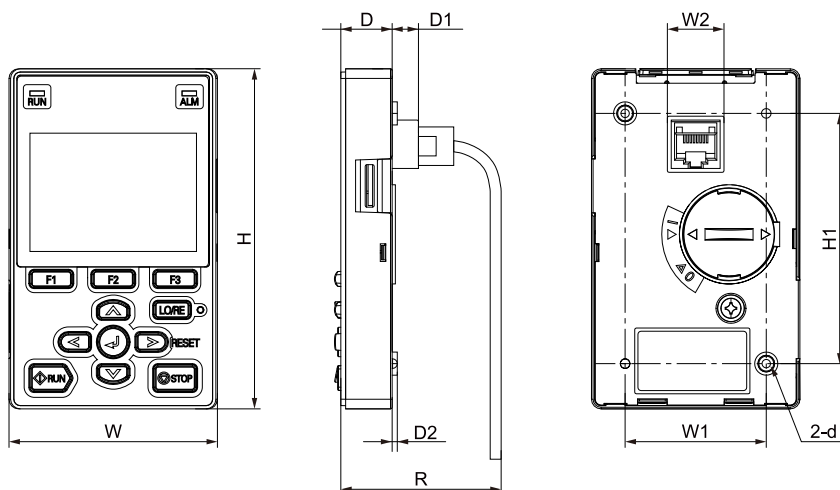

Figure 2.8 Exterior and Mounting Dimensions

Table 2.6 Exterior Dimensions (mm)

W	H	D	D1	D2	R *1	W1	W2	H1	d
65	106	16	8.2	1.6	53.8	44	15	78	M3

*1 Minimum bending radius

■ **Mount to Exterior of Control Panel**

1. Cut an opening in the control panel for the keypad.
Refer to the following figure for the panel cut-out dimensions.

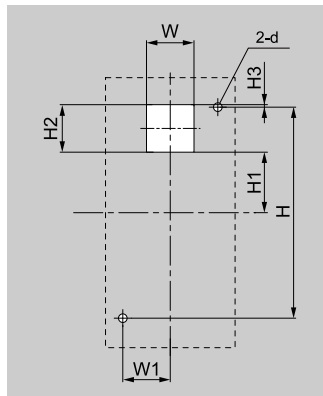

Figure 2.9 Panel Cut-Out Dimensions for Mounting to Exterior of Control Panel

Table 2.7 Panel Cut-out Dimensions mm (in.)

W	H	W1	H1	H2	H3	d
22(0.89)	78(3.07)	22(0.89)	29(1.14)	22(0.89)	1(0.04)	3.6(0.14)

2. Remove the keypad and place the keypad connector in the holder on the front cover.

Note:

Insert the keypad connector in the direction of the hooks.

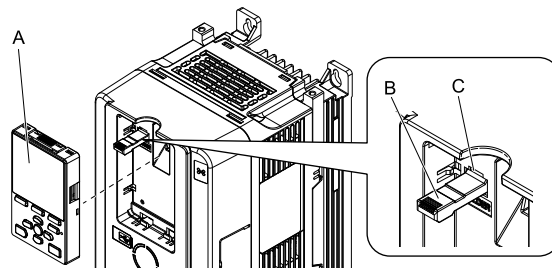

A - Keypad
B - Keypad connector

C - Holder

Figure 2.10 Remove the Keypad

3. Position the keypad to the outside of the control panel, and mount it from the inside using the screws.
Use M3 screws (6 mm depth cross recessed pan head screws) and tighten them to a tightening torque of 0.49 to 0.73 N·m (4.34 to 6.46 lb·in.).

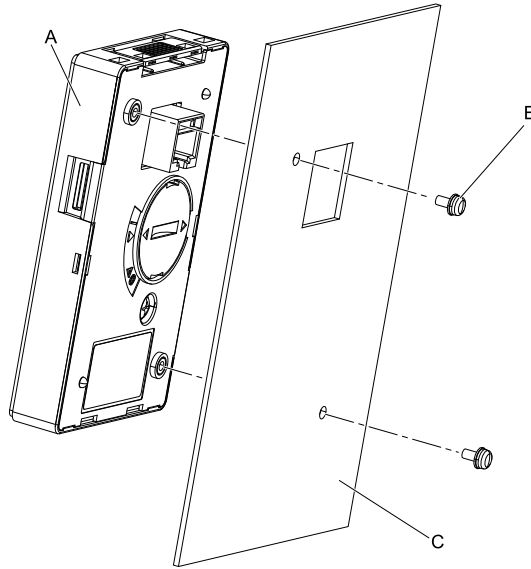

A - Keypad
B - M3 screws

C - Control panel

Figure 2.11 Mount to Exterior of Control Panel

4. Connect the keypad with the drive using the remote control extension cable.

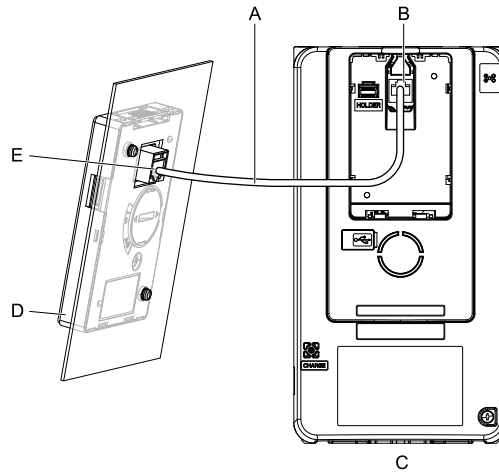

A - Remote control extension
B - Communications connector
C - Drive

D - Keypad
E - Cable connector

Figure 2.12 Connect the Drive and Keypad with the Remote Control Extension Cable

■ Install inside Control Panel

An internal flush-mount requires installation support set that must be purchased separately. Contact Yaskawa or your nearest sales representative to order mounting brackets and mounting hardware.

Note:

- The installation procedure and panel cut-out dimensions are the same for both mounting brackets A and B.
- Use a gasket between the control panel and the keypad in environments with a significant amount of dust or other airborne debris.

1. Cut an opening in the control panel for the keypad.
Refer to the following figure for panel cut-out dimensions.

2.7 Install the Keypad on the Control Panel or Other Devices

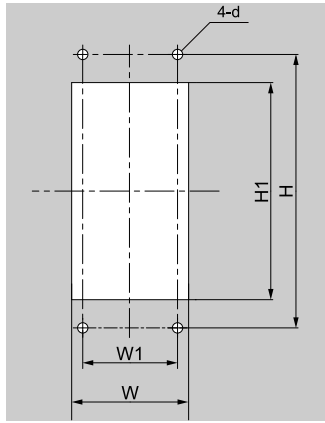

Figure 2.13 Panel Cut-Out Dimensions for Mounting to Interior of Control Panel

Table 2.8 Panel Cut-out Dimensions mm (in.)

W	H	W1	H1	d
64 + 0.5(2.52 + 0.02)	130(5.12)	45(1.77)	105 + 0.5(4.13 + 0.02)	4.8(0.12)

- Remove the keypad and place the keypad connector in the holder on the front cover.

Note:

Insert the keypad connector in the direction of the hooks.

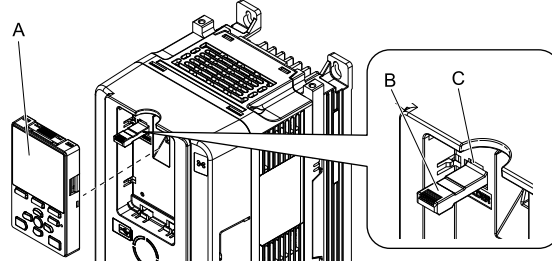

A - Keypad

B - Keypad connector

C - Holder

Figure 2.14 Remove the Keypad

- Mount the keypad to the mounting bracket.

Use the screws supplied with the mounting bracket, and tighten them to a tightening torque of 0.49 to 0.73 N·m (4.34 to 6.46 lb·in.).

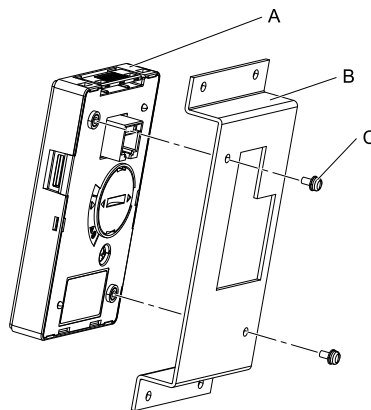

A - Keypad

B - Mounting bracket A

C - M3 screws

Figure 2.15 Mount Keypad to Mounting Bracket

- Position the mounting bracket to which the keypad has been attached in the control panel, and mount it from the outside using the screws.

Use the screws supplied with the installation support set, and tighten them to a tightening torque of 0.98 to 1.33 N·m (8.67 to 11.77 lb·in.).

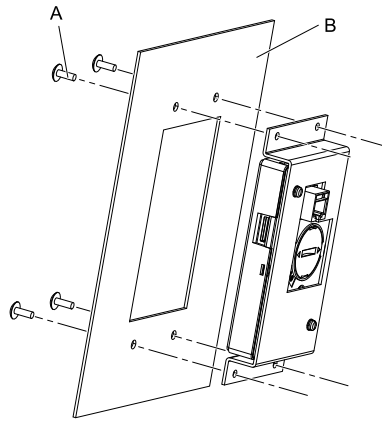

A - M4 screws

B - Control panel

Figure 2.16 Mount Mounting Bracket to the Interior of the Control Panel

5. Connect the keypad with the drive using the remote control extension cable.

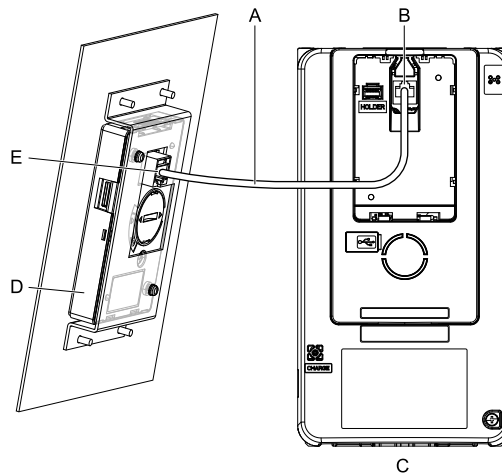

A - Remote control extension

D - Keypad

B - Communications connector

E - Cable connector

C - Drive

Figure 2.17 Connect the Drive and Keypad with the Remote Control Extension Cable

2.8 Removing/Reattaching the Cover

This section describes removing and reattaching the front cover and terminal cover to facilitate wiring and inspection.

The procedure for removing and reattaching the covers differs depending on drive model. Refer to [Table 2.9](#) for details.

Table 2.9 Procedure for Removing/Reattaching the Cover

Model	Procedure
2004 - 2056 4002 - 4038	Procedure A
2070 - 2211 4044 - 4168	Preparing
2257 - 2415 4208 - 4675	Preparing

◆ Removing/Reattaching the Cover Using Procedure A

DANGER! Electrical Shock Hazard. Do not perform inspections or wiring while the drive is energized. De-energize all devices before carrying out any wiring or repair operations. Voltage will remain within the capacitors inside the drive even after the power has been switched off. The Charge LED is extinguished once the DC bus voltage goes below 50 V DC. To prevent electric shock, always wait for at least the amount of time indicated on the warning labels and confirm that all indicators are OFF. Then, remove the front cover and terminal cover, measure the input power supply voltage and the DC bus voltage, and make sure that the voltages have been lowered to safe levels. Failure to comply may result in death or serious injury.

DANGER! Electrical Shock Hazard. Turn off the power. Wait until the CHARGE LED turns off and then remove the cover. Failure to follow the instructions may result in injury or death.

■ Remove the Front Cover

1. Remove the keypad and place the keypad connector in the holder on the front cover.

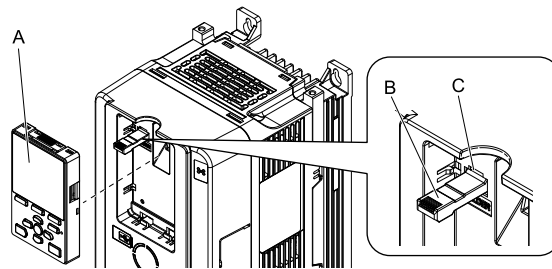

A - Keypad

B - Keypad connector

C - Holder

Figure 2.18 Remove the Keypad

Note:

Insert the keypad connector in the direction of the hooks.

2. Loosen the front cover screw.

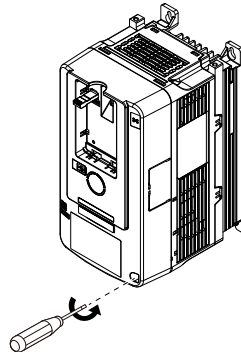

Figure 2.19 Loosen the Front Cover Screw

3. While pressing on the hook located on the side of the front cover, pull the front cover forward to remove it from the drive.

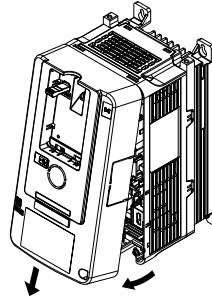

Figure 2.20 Remove the Front Cover

■ Reattach the Front Cover

Wire the drive and other peripheral devices before reattaching the front cover.

Note:

- Wire the grounding terminals, main circuit terminals, and control circuit terminals, in that order.
- Do not pinch wires or signal lines between front cover and the drive when replacing the cover.
- Tighten the screws to a tightening torque of 0.98 to 1.33 N·m (8.67 to 11.77 lb·in.).

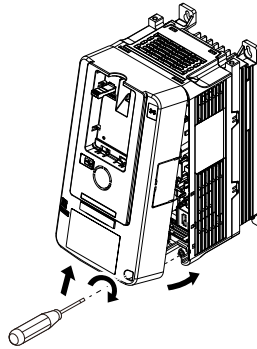

Figure 2.21 Reattach the Front Cover

2.9 Change the Drive's Enclosure Type

The enclosure type of the drive is the open chassis type (IP20). The following explains how to change the enclosure type to the enclosed wall-mounted type (UL Type 1). The procedure for installing UL Type 1 protective covers is explained.

Install the protective covers before wiring the drive.

The procedure for installing the protective covers differs depending on the drive model. Refer to [Table 2.10](#) for details.

Table 2.10 Procedure for Installing UL Type 1 Protective Covers

Model	Procedure
2004 to 2056 4002 to 4038	Procedure A
2070, 2082 4044, 4060	Tentative
2110 4075	Tentative
2138 to 2211 4089 to 4168	Tentative
2257 to 2415 4208 to 4414	Tentative

◆ Attach the Protective Cover (Procedure A)

■ Attach the Top Protective Cover

Align the hook on the rear of top protective cover with the hole at the top of the drive to attach the top protective cover.

Note:

- Attach the top protective cover so the (▲) mark on the upper surface of the top protective cover is positioned at the front side of the drive.
- Insert the two small protruding hooks on the rear side of the top protective cover into the provided mounting holes near the back of the drive, then press down on the front side of the top protective cover to fasten the cover into place.

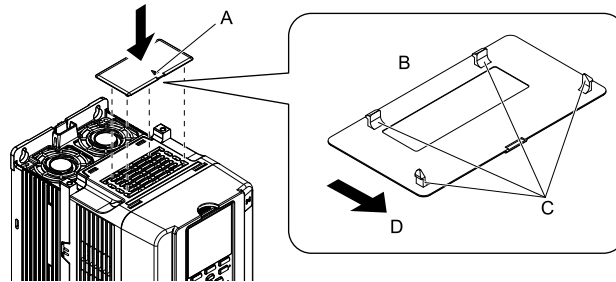

A - Mark

B - Rear side of top protective cover

C - Hooks

D - Front of drive

Figure 2.22 Attach the Top Protective Cover

Insert the tip of a straight-edge screwdriver into the small opening located on the front edge of the top protective cover. Gently apply pressure as shown in the figure below to free the cover from the drive.

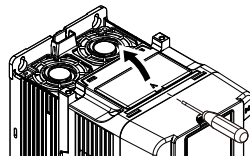
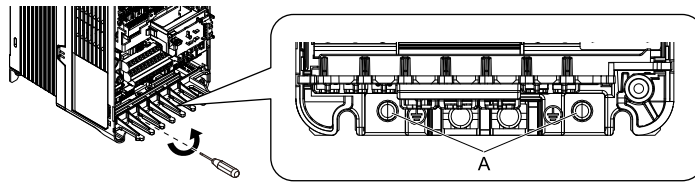

Figure 2.23 Remove the Top Protective Cover

■ Attach the Conduit Bracket

Remove the front cover.

1. Remove the screws that fasten the protective covers onto the drive.



A - Screws for fastening protective cover

Figure 2.24 Remove Screws Fastening Protective Cover

2. Press conduit bracket 1 into place while aligning it with the screw holes on the drive. Use the screws to mount it.

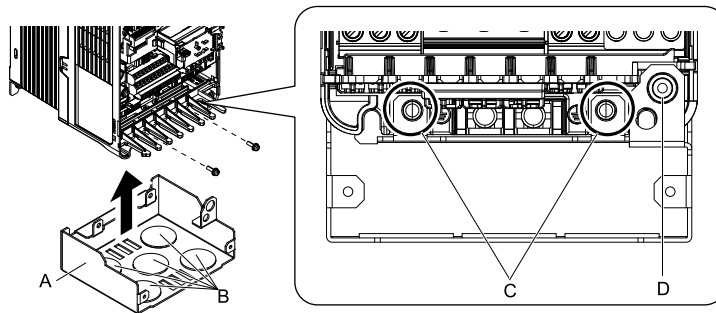

**A - Conduit bracket 1
B - Wiring holes**

C - Insert in the screw holes of the protective cover and fasten.

D - Insert in the screw holes of the front cover and fasten.

Figure 2.25 Attach Conduit Bracket 1

3. Attach bottom protective cover 2.
Tighten the screws to a tightening torque of 0.98 to 1.33 N·m (8.67 to 11.77 lb·in.).

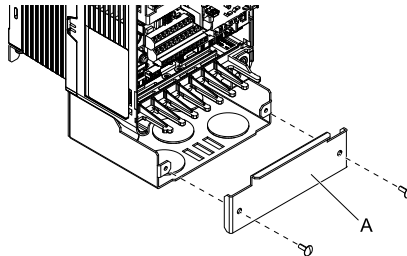

A - Conduit bracket 2

Figure 2.26 Attach Conduit Bracket 2

4. Attach the front cover.

Reverse the procedure described above to reinstall the conduit bracket.

2.10 Installation Procedure

There are two kinds of installations, standard installation and panel through mounting.

◆ Standard Installation

Refer to “Drive exterior and mounting dimensions” for details.

◆ Panel Through Mounting

Refer to [Table 2.11](#) and [Table 2.12](#) for the panel cut out dimensions when setting up an installation where the heatsink is to be installed outside of the drive. The following 2082 and 4060 drives require an attachment for panel through mounting.

Note:

- The mounting exterior dimensions and installation dimensions for a standard installation can differ from the those of a panel through mounting.
- The shaded parts of the panel cut out dimensions are the gasket dimensions. Check the above mentioned dimensions for gasket width.

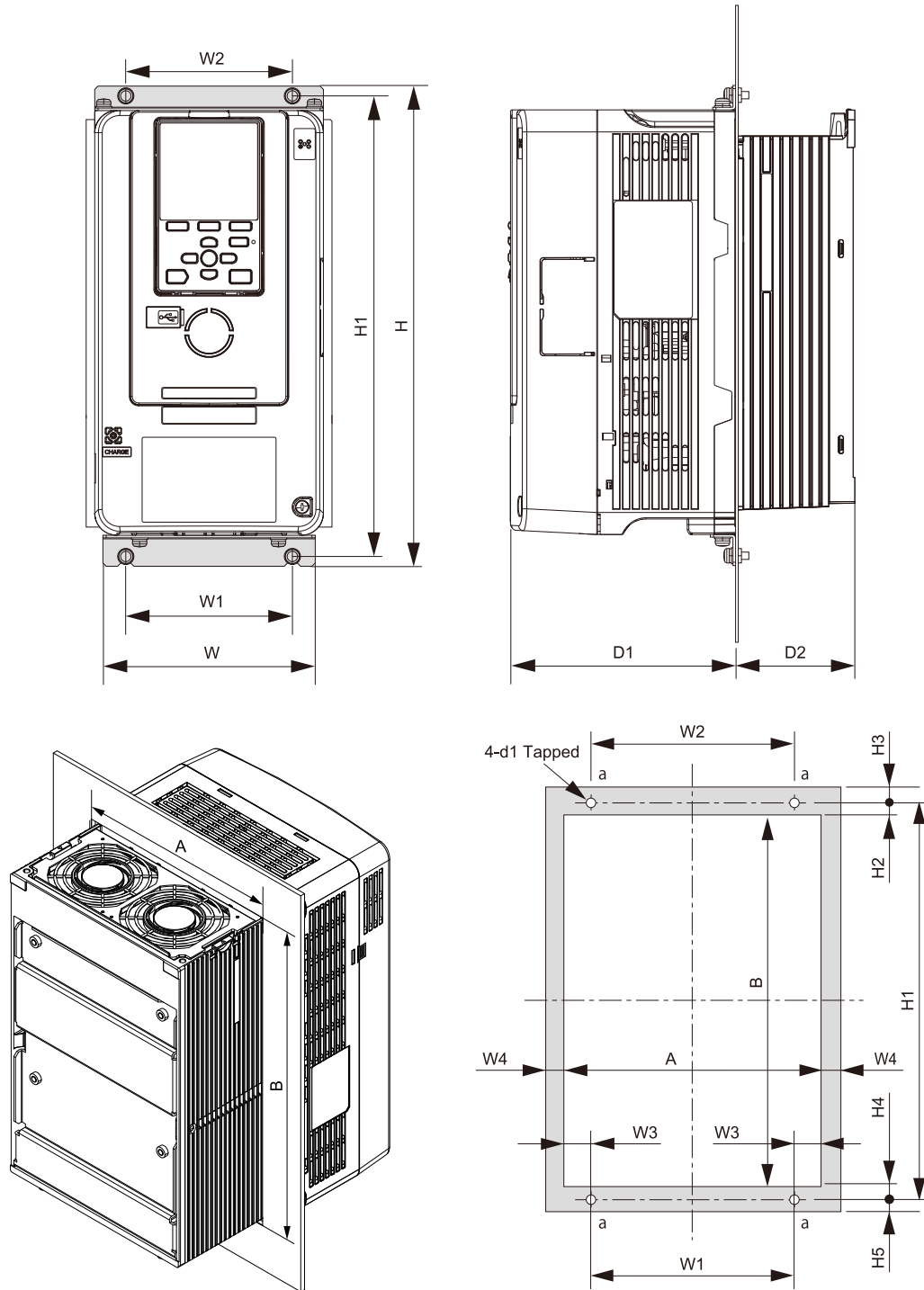

Figure 2.27 Panel Cut Out Dimensions

Table 2.11 Exterior Dimensions (200 V Class)

Model	Exterior Dimensions mm															
	W	H	D1	D2	W1	W2	W3	W4	H1	H2	H3	H4	H5	A	B	d1
2004 */j	140	294	138	38	102	102	16	3	282	23	6	26	6	134	233	M5
2006 */j	140	294	138	38	102	102	16	3	282	23	6	26	6	134	233	M5
2008 */j	140	294	138	38	102	102	16	3	282	23	6	26	6	134	233	M5
2010 */j	140	294	138	38	102	102	16	3	282	23	6	26	6	134	233	M5
2012 */j	140	294	138	38	102	102	16	3	282	23	6	26	6	134	233	M5

2.10 Installation Procedure

Model	Exterior Dimensions mm															
	W	H	D1	D2	W1	W2	W3	W4	H1	H2	H3	H4	H5	A	B	d1
2018 *1	140	294	138	73	102	102	16	3	282	23	6	26	6	134	233	M5
2021 *1	140	294	138	73	102	102	16	3	282	23	6	26	6	134	233	M5
2030 *1	140	294	138	73	102	102	16	3	282	23	6	26	6	134	233	M5
2042 *1	140	294	138	73	102	102	16	3	282	23	6	26	6	134	233	M5
2056 *1	180	329	134	68	140	140	17	3	318	23.5	5	24.5	6	174	270	M5
2070 *1	Preparing															
2082 *1																
2110																
2138																
2169																
2211																
2257																
2313																
2360																
2415																

*1 The attachment for panel through mounting is required.

Table 2.12 Exterior Dimensions (400 V Class)

Model	Exterior Dimensions mm															
	W	H	D1	D2	W1	W2	W3	W4	H1	H2	H3	H4	H5	A	B	d1
4002 *1	140	294	138	38	102	102	16	3	282	23	6	26	6	134	233	M5
4004 *1	140	294	138	38	102	102	16	3	282	23	6	26	6	134	233	M5
4005 *1	140	294	138	38	102	102	16	3	282	23	6	26	6	134	233	M5
4007 *1	140	294	138	73	102	102	16	3	282	23	6	26	6	134	233	M5
4009 *1	140	294	138	73	102	102	16	3	282	23	6	26	6	134	233	M5
4012 *1	140	294	138	73	102	102	16	3	282	23	6	26	6	134	233	M5
4018 *1	140	294	138	73	102	102	16	3	282	23	6	26	6	134	233	M5
4023 *1	140	294	138	73	102	102	16	3	282	23	6	26	6	134	233	M5
4031 *1	140	294	138	73	102	102	16	3	282	23	6	26	6	134	233	M5
4038 *1	180	329	134	68	140	140	17	3	318	23.5	5	24.5	6	174	270	M5

Model	Exterior Dimensions mm															
	W	H	D1	D2	W1	W2	W3	W4	H1	H2	H3	H4	H5	A	B	d1
4044 <small>*1</small>	Preparing															
4060 <small>*1</small>																
4075																
4089																
4103																
4140																
4168																
4208																
4250																
4296																
4371																
4414																
4453																
4568																
4675																

*1 The attachment for panel through mounting is required.

2.11 Electrical Installation

DANGER! *Electrical Shock Hazard. Do not inspect, connect, or disconnect any wiring while the drive is energized. Before servicing, disconnect all power to the equipment and wait for at least the time specified on the warning label. The internal capacitor remains charged even after the drive is de-energized. The charge indicator LED will extinguish when the DC bus voltage is below 50 Vdc. When all indicators are OFF, remove the covers and then measure for unsafe voltages to confirm the drive is safe. Failure to comply will cause death or serious injury.*

DANGER! *Electrical Shock Hazard. After wiring the drive, safely check that all electrical connects are correct and that all covers are correctly installed before turning on the power. If the drive is already energized, de-energize the power and wait at least 5 minutes until the Charge LED completely turns off. Remove the front cover and terminal cover to access wiring, circuit boards, and other parts. Terminals must only be used for their intended purpose. Improper wiring, improper ground connections, and improper repair of protective covers could result in electric shock, which could lead to equipment damage, injury, and even death.*

WARNING! *Electrical Shock Hazard. Properly ground the drive before turning on the EMC filter switch. Failure to comply could cause death or serious injury.*

WARNING! *Electrical Shock Hazard. Use the drive terminals only for their intended purpose. Refer to the drive Technical Manual for more technical information on I/O terminals. Improper wiring, improper grounding, and faulty repair of the protective cover could cause death or serious injury and damage to the drive.*

◆ Standard Connection Diagram

Wire the drive as shown in [Figure 2.28](#). If the drive is run using the keypad, the motor can be run by main circuit wiring.

WARNING! *Sudden Movement Hazard. Set the multi-function input terminal parameters before closing the wiring for the control circuit. Improper sequencing of run/stop circuitry could cause death or serious injury from moving equipment.*

WARNING! *Sudden Movement Hazard. Properly wire the start/stop and safety circuits before energizing the drive. When programmed for 3-Wire control, a momentary closure on a digital input terminal could cause the drive to start. Failure to comply could cause death or serious injury from moving equipment.*

WARNING! *Sudden Movement Hazard. When using a 3-Wire sequence, set the drive to 3-Wire sequence and set b1-17 = 0 [Run Command at Power Up = Disregard Existing RUN Command] before wiring the control terminals so the drive will not accept a Run command at power up. The motor may rotate in reverse when the drive is powered up if the drive is wired for a 3-wire sequence but set up for a 2-wire sequence (default) and b1-17 = 1 [Accept Existing RUN Command]. Failure to comply could cause death or serious injury from moving equipment.*

WARNING! *Sudden Movement Hazard. Confirm the drive I/O signals and external sequence before executing the application preset function. Executing the application preset function or setting A1-06 ≠ 0 [Application Preset ≠ General-purpose] changes the drive I/O terminal functions and could cause unexpected equipment operation. Failure to comply could cause death or serious injury.*

WARNING! *Fire Hazard. Install adequate branch circuit short circuit protection per applicable codes and this manual. The drive is suitable for circuits capable of delivering not more than 100,000 RMS symmetrical amperes, 240 Vac maximum (200 V class), 480 Vac maximum (400 V class). Failure to comply could cause death or serious injury.*

NOTICE: *Pay special attention to the motor insulation voltage or use a drive duty motor when the input voltage is 440 V or higher or the wiring distance is longer than 100 m (328 ft.) Failure to comply could cause motor insulation breakdown.*

NOTICE: *Do not connect AC control circuit ground to the drive enclosure. Improper drive grounding could cause control circuit malfunction.*

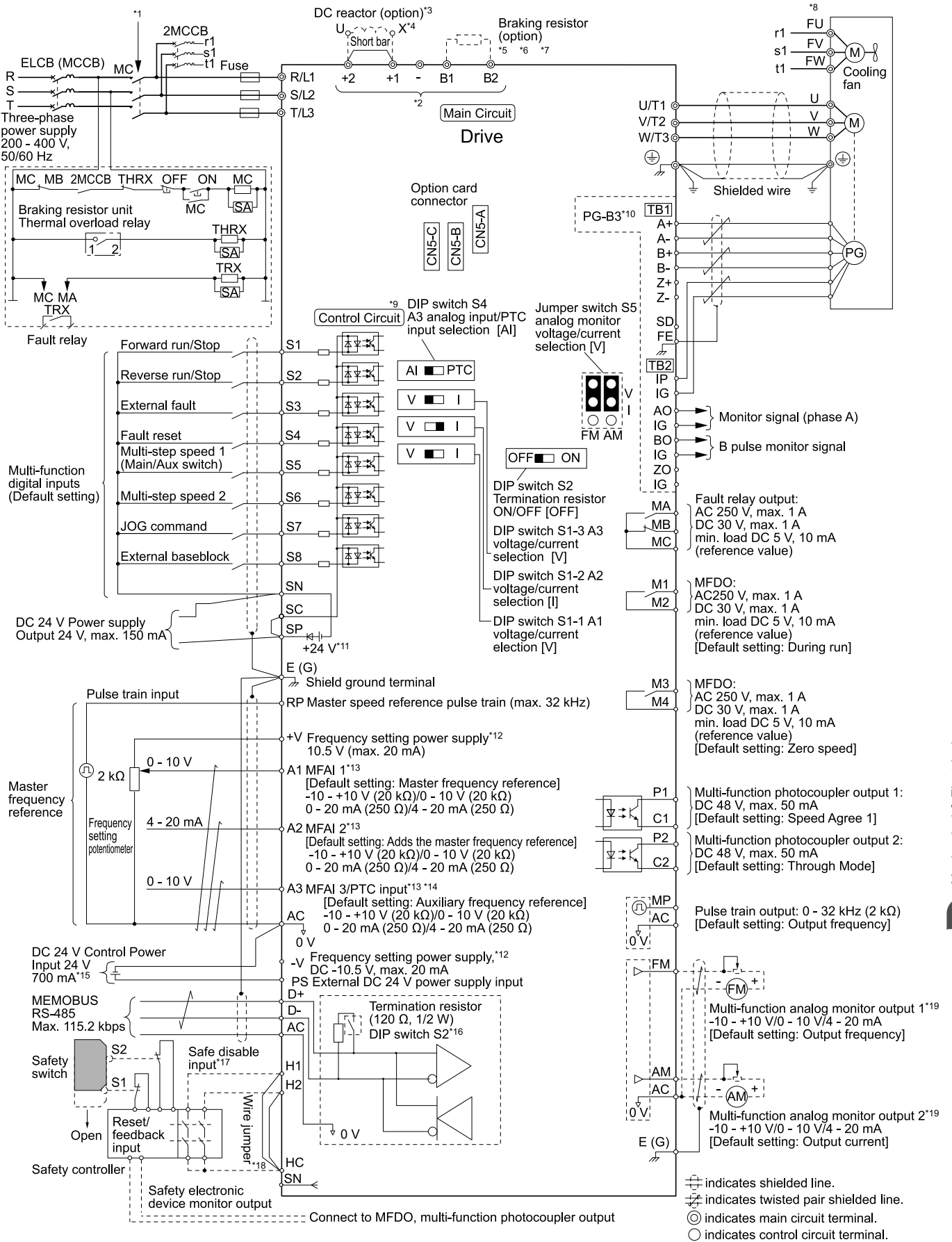

Figure 2.28 Standard Connection Diagram for the Drive

*1 We recommend that the sequence that shuts off the power source be set via the fault relay output for the drive. When using the Fault Restart function, if L5-02 = 1 [Auto Restart = Fault output active], the fault

signal is output during Restart Enabled and the power supply will turn OFF. Use the interrupt sequence with caution. The default setting for L5-02 is 0 [Fault output not active].

*2 Terminals -, +1, +2, B1 and B2 are the optional connection terminals.

NOTICE: Do not connect an AC power supply to terminals -, +1, +2, B1, and B2. Failure to follow the instructions may damage the drive and the peripheral devices.

*3 Be sure to remove the short bar between the terminals +1 and +2 when installing the optional DC reactor.

*4 Models 2110 to 2415 and 4060 to 4675 have a built-in DC reactor.

*5 Be sure to set L8-55 = 0 [InternalBrakingTransistorProtect = Disabled] when using the regenerative converter, regenerative unit or the braking unit (when not using the built-in dynamic braking transistor). rF [Braking Resistor Fault] may be triggered.

*6 Set L3-04 = 0 [Decel Stall Prevention Selection = Disabled] to disable Stall Prevention when using a regenerative converter, regenerative unit, dynamic braking unit, braking resistor, or braking resistor unit. If left unchanged, it may not stop at the set deceleration time.

*7 When using a braking resistor (ERF type), set L8-01 = 1 [Internal DB Resistor Protect Sel (ERF type)] and be sure to use a sequence that shuts the power OFF by using the fault relay output for the drive.

*8 Wiring for the cooling fan motor is not required with the self-cooling motor.

*9 Supplying power to the control circuit separately from the main circuit requires a 24 V power supply be input to terminal PS-AC.

*10 Encoder circuit wiring (wiring on the PG-B3 option card) is not required when using the drive in an application that does not use feedback from the motor.

*11 Install a jumper between terminals SC-SP-SN to select the type of the power supply of MFDI.

NOTICE: Do not short terminals SP and SN. Failure to comply will damage the drive.

- Sinking mode: Short terminals SC and SP.
- Sourcing mode: Short terminals SC and SN.
- External power supply: No jumper necessary.

*12 The maximum output current capacity of the +V and -V terminals on the control circuit terminal is 20 mA.

NOTICE: Do not install a jumper between terminals +V, -V, and AC. Failure to comply may cause erroneous operation or damage the drive.

*13 Set DIP switches S1-1 to S1-3 to select between a voltage or current input command to terminals A1 to A3. The default setting for S1-1 and S1-3 is voltage reference input ("V" side). The default setting for S1-2 is current reference input ("I" side).

*14 Set DIP switch S4 to select between an analog input or PTC input to terminal to A3. After the PTC input has been selected, set DIP switches S1-3 to the V side, and set H3-05 = 0 [0-10V (LowLim=0)].

*15 Do not connect terminals PS and AC inversely. Failure to comply will damage the drive.

*16 Enable the termination resistor in the last drive in a MEMOBUS/Modbus communications by setting DIP switch S2 to the ON position.

*17 Use sourcing mode for Safe Disable input.

*18 Disconnect the wire jumper between H1 - HC and H2 - HC when utilizing the Safe Disable input.

*19 Monitor outputs work with devices such as analog frequency meters, ammeters, voltmeters, and wattmeters. They are not intended for use as a feedback-type of signal.

2.12 Main Circuit Wiring

This section describes the functions, specifications, and procedures required to safely and properly wire the main circuit in the drive.

NOTICE: Do not solder the ends of wire connections to the drive. Soldered wiring connections can loosen over time. Improper wiring practices could result in drive malfunction due to loose terminal connections.

NOTICE: To extend the service life of the relay contacts and electrolytic capacitors inside the drive, the MC on the power source side for turning the drive on (run) and off (stop) should be operated a maximum of one time in 30 minutes. Running and stopping the motor should be done as much as possible via the run and stop operations of the drive. The drive can be run and stopped by turning it on and off via the MC on the power source side, but if this is done frequently, it may cause the drive to fail. Improper operation may shorten the service life of the relay contact and electrolytic capacitor.

◆ Main Circuit Wiring

Refer to [Figure 2.29](#) for wiring.

WARNING! Electrical Shock Hazard. Do not connect terminals R/L1, S/L2, T/L3, U/T1, V/T2, W/T3, -, +1, +2, +3, B1, or B2 to the ground terminal. Failure to comply could cause death or serious injury and damage to equipment.

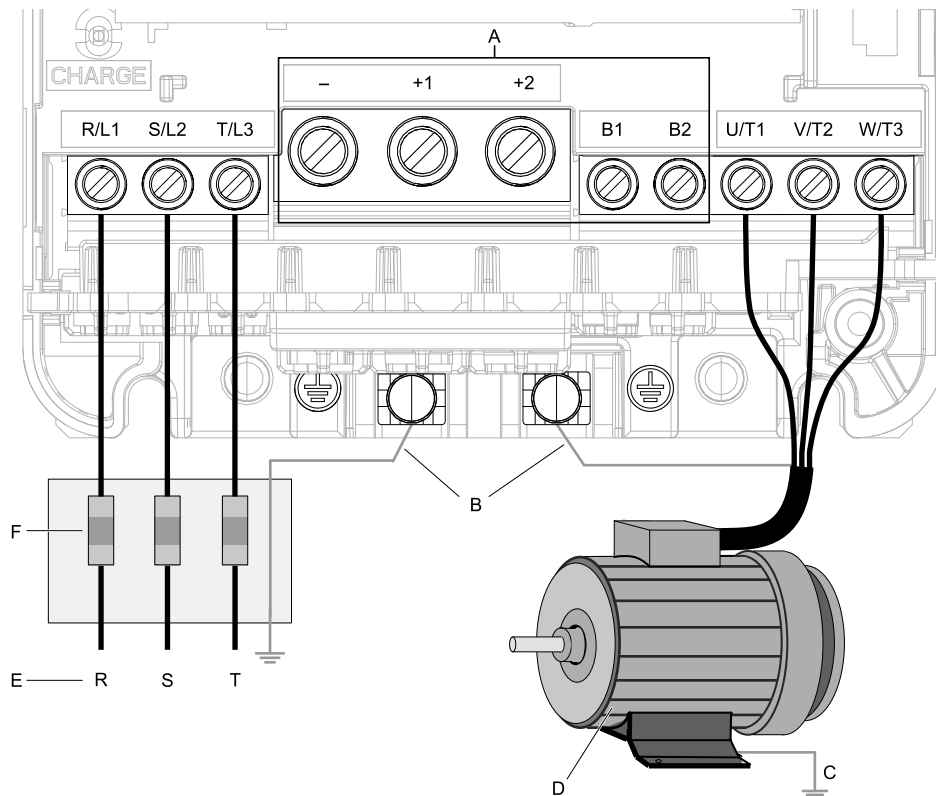

- A - DC bus voltage terminals (arrangement may differ depending on drive model) Do not ground these terminals.
- B - Drive ground terminal connection.
- C - Ground the motor case.
- D - Three-phase motor
- E - Connect R, S, and T to three-phase power.
- F - Fuses and ELCB/GFCI/RCD

Figure 2.29 Wiring the Main Circuit and Motor

◆ Configuration of Main Circuit Terminal Block

Refer to the following figure for the configuration of the main circuit terminal arrangement.

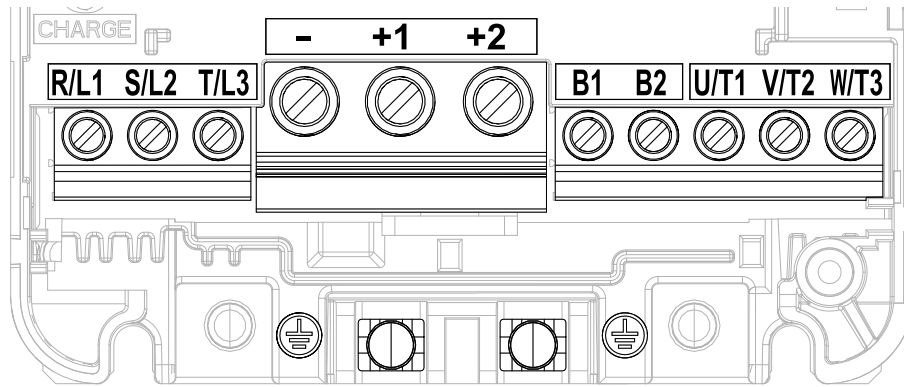

Figure 2.30 Main Circuit Terminal Block Configuration (2004 to 2042, 4002 to 4023)

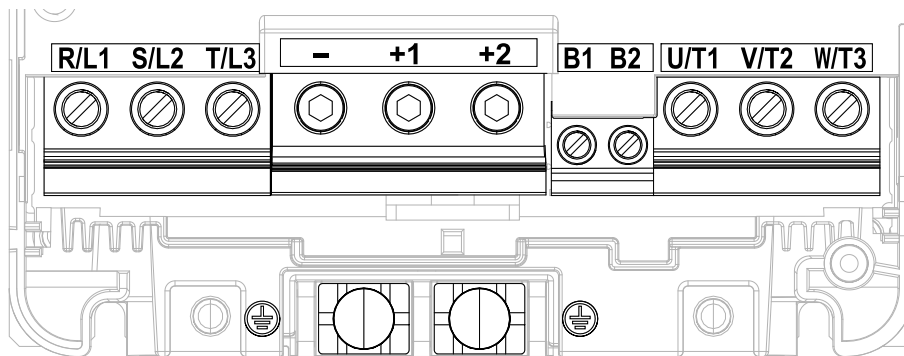

Figure 2.31 Main Circuit Terminal Block Configuration (2056, 4031, 4038)

◆ Main Circuit Terminal Functions

Refer to the following table for drive main circuit terminals and functions.

Table 2.13 Main Circuit Terminal Functions

Terminal	Name			Function
Model	2004 - 2082 4002 - 4044	2110 - 2138 4060 - 4168	2169 - 2415 4208 - 4675	
R/L1	Main circuit power supply input			Connecting a commercial power supply.
S/L2				
T/L3				
U/T1	Drive output			Connecting a motor.
V/T2				
W/T3				
B1	Braking resistor connection		-	Connecting a braking resistor or braking resistor unit.
B2				

Terminal	Name			Function
	2004 - 2082	2110 - 2138	2169 - 2415	
Model	4002 - 4044	4060 - 4168	4208 - 4675	
	+2	<ul style="list-style-type: none"> DC power supply input (+1 and -) DC reactor connection (+1 and +2) 	DC power supply input (+1 and -)	
+1				
-				
+3	-	-	<ul style="list-style-type: none"> DC power supply input (+1 and -) Braking unit connection (+3 and -) 	
⊕	<ul style="list-style-type: none"> 200 V: D class grounding (ground to 100 Ω or less) 400 V: C class grounding (ground to 10 Ω or less) 			Grounding.

Note:

Use terminals B1 and - when connecting a CDBR-type control unit to drive models 2004 to 2138 and 4002 to 4168 with built-in braking transistors.

◆ Main Circuit Wire Gauges and Tightening Torques

Select the wires to use in the main circuit wiring correctly.

Refer to Main Circuit Wire Gauges and Tightening Torques for European Standards on page 182 for the wire gauges and tightening torques to comply with the European standard.

Refer to Main Circuit Wire Gauges and Tightening Torques on page 204 for the wire gauges and tightening torques to comply with the UL standard.

■ Wire Selection Precautions

WARNING! Electrical Shock Hazard. The leakage current of inverter models 4389A to 4675A, 2xxxB/C and 4xxxB/C will exceed 3.5 mA. As written in the IEC/EN 61800-5-1:2007 standard, the power supply should be wired so that it automatically turns off in the event the protective ground wire is disconnected, or else connect a protective ground wire with a cross sectional area of at least 10 mm² (copper wire) or 16 mm² (aluminum wire). Failure to meet these standards may result in electric shock.

Consider wire voltage drops when selecting wire gauges. As a general rule, select wire gauges so voltage drops will be within 2% of the rated voltage. Increase the wire gauge in accordance with the length of the cable when there is a risk of voltage drops. Use the following formula to calculate line the amount of voltage drop:

Line voltage drop (V) = $\sqrt{3} \times \text{wire resistance } (\Omega/\text{km}) \times \text{wiring distance (m)} \times \text{motor rated current (A)} \times 10^{-3}$.

■ Precautions during Wiring

- Use terminals B1 and - to connect a braking unit to drive models 2004 to 2138 and 4002 to 4168 with built-in braking transistors. Use terminals +3 and - to connect a braking unit to drive models without built-in braking transistors.
- Refer to “Yaskawa AC Drive Option Braking Unit, Braking Resistor Unit Instruction Manual (TOBPC72060001)” for information regarding wire gauges and tightening torques when connecting a braking resistor unit or braking unit.
- Use terminals +1 to connect a regenerative converter or regenerative unit.

NOTICE: Do not connect a braking resistor to terminals +1 or -. Failure to comply could damage the drive circuitry.

■ Main Circuit Wire Gauges and Tightening Torques

WARNING! Electrical Shock Hazard. The leakage current of inverter models 4389A to 4675A, 2xxxB/C and 4xxxB/C will exceed 3.5 mA. As written in the IEC/EN 61800-5-1:2007 standard, the power supply should be wired so that it automatically turns off in the event the protective ground wire is disconnected, or else connect a protective ground wire with a cross sectional area of at least 10 mm² (copper wire) or 16 mm² (aluminum wire). Failure to meet these standards may result in electric shock.

Note:

When connecting peripheral devices or options to terminals -, +1, +2, B1, B2, refer to the specific instruction manual of each device for wire gauges. Contact Yaskawa or your nearest sales representative if the wire gauge recommended for the peripheral device or optional product is out of the range of the applicable gauge for the drive.

Table 2.14 Wire Gauges and Tightening Torques for 200 V Class Drives

Model	Terminal	Recommended Gauge mm ²	Wire Range mm ²	Wire Stripping Length *1 mm	Terminal Screw		Tightening Torque N·m (lb·in)
					Size	Shape	
2004	R/L1, S/L2, T/L3	2	2 - 14	10	M4	Slot (-)	1.5 - 1.7 (13.5 - 15)
	U/T1, V/T2, W/T3	2	2 - 14	10	M4	Slot (-)	1.5 - 1.7 (13.5 - 15)
	-, +1, +2	2	2 - 22	18	M5	Slot (-)	2.3 - 2.5 (19.8 - 22) *2
	B1, B2	2	2 - 5.5	10	M4	Slot (-)	1.5 - 1.7 (13.5 - 15)
	⊕	2	2 - 5.5	-	M4	Phillips/ slot combo	1.2 - 1.5 (10.6 - 13.3)
2006	R/L1, S/L2, T/L3	2	2 - 14	10	M4	Slot (-)	1.5 - 1.7 (13.5 - 15)
	U/T1, V/T2, W/T3	2	2 - 14	10	M4	Slot (-)	1.5 - 1.7 (13.5 - 15)
	-, +1, +2	2	2 - 22	18	M5	Slot (-)	2.3 - 2.5 (19.8 - 22) *2
	B1, B2	2	2 - 5.5	10	M4	Slot (-)	1.5 - 1.7 (13.5 - 15)
	⊕	2	2 - 5.5	-	M4	Phillips/ slot combo	1.2 - 1.5 (10.6 - 13.3)
2008	R/L1, S/L2, T/L3	2	2 - 14	10	M4	Slot (-)	1.5 - 1.7 (13.5 - 15)
	U/T1, V/T2, W/T3	2	2 - 14	10	M4	Slot (-)	1.5 - 1.7 (13.5 - 15)
	-, +1, +2	2	2 - 22	18	M5	Slot (-)	2.3 - 2.5 (19.8 - 22) *2
	B1, B2	2	2 - 5.5	10	M4	Slot (-)	1.5 - 1.7 (13.5 - 15)
	⊕	2	2 - 5.5	-	M4	Phillips/ slot combo	1.2 - 1.5 (10.6 - 13.3)
2010	R/L1, S/L2, T/L3	2	2 - 14	10	M4	Slot (-)	1.5 - 1.7 (13.5 - 15)
	U/T1, V/T2, W/T3	2	2 - 14	10	M4	Slot (-)	1.5 - 1.7 (13.5 - 15)
	-, +1, +2	2	2 - 22	18	M5	Slot (-)	2.3 - 2.5 (19.8 - 22) *2
	B1, B2	2	2 - 5.5	10	M4	Slot (-)	1.5 - 1.7 (13.5 - 15)
	⊕	2	2 - 5.5	-	M4	Phillips/ slot combo	1.2 - 1.5 (10.6 - 13.3)

Model	Terminal	Recommended Gauge mm ²	Wire Range mm ²	Wire Stripping Length *1 mm	Terminal Screw		Tightening Torque N·m (lb·in)
					Size	Shape	
2012	R/L1, S/L2, T/L3	3.5	2 - 14	10	M4	Slot (-)	1.5 - 1.7 (13.5 - 15)
	U/T1, V/T2, W/T3	2	2 - 14	10	M4	Slot (-)	1.5 - 1.7 (13.5 - 15)
	-, +1, +2	3.5	2 - 22	18	M5	Slot (-)	2.3 - 2.5 (19.8 - 22) *2
	B1, B2	2	2 - 5.5	10	M4	Slot (-)	1.5 - 1.7 (13.5 - 15)
	⊕	3.5	2 - 5.5	-	M4	Phillips/ slot combo	1.2 - 1.5 (10.6 - 13.3)
2018	R/L1, S/L2, T/L3	3.5	2 - 14	10	M4	Slot (-)	1.5 - 1.7 (13.5 - 15)
	U/T1, V/T2, W/T3	3.5	2 - 14	10	M4	Slot (-)	1.5 - 1.7 (13.5 - 15)
	-, +1, +2	5.5	2 - 22	18	M5	Slot (-)	2.3 - 2.5 (19.8 - 22) *2
	B1, B2	2	2 - 5.5	10	M4	Slot (-)	1.5 - 1.7 (13.5 - 15)
	⊕	3.5	2 - 5.5	-	M4	Phillips/ slot combo	1.2 - 1.5 (10.6 - 13.3)
2021	R/L1, S/L2, T/L3	8	2 - 14	10	M4	Slot (-)	1.5 - 1.7 (13.5 - 15)
	U/T1, V/T2, W/T3	3.5	2 - 14	10	M4	Slot (-)	1.5 - 1.7 (13.5 - 15)
	-, +1, +2	8	2 - 22	18	M5	Slot (-)	2.3 - 2.5 (19.8 - 22) *2
	B1, B2	2	2 - 5.5	10	M4	Slot (-)	1.5 - 1.7 (13.5 - 15)
	⊕	3.5	3.5 - 5.5	-	M4	Phillips/ slot combo	1.2 - 1.5 (10.6 - 13.3)
2030	R/L1, S/L2, T/L3	14	2 - 14	10	M4	Slot (-)	1.5 - 1.7 (13.5 - 15)
	U/T1, V/T2, W/T3	8	2 - 14	10	M4	Slot (-)	1.5 - 1.7 (13.5 - 15)
	-, +1, +2	14	2 - 22	18	M5	Slot (-)	2.3 - 2.5 (19.8 - 22) *2
	B1, B2	3.5	2 - 5.5	10	M4	Slot (-)	1.5 - 1.7 (13.5 - 15)
	⊕	5.5	5.5 - 8	-	M5	Phillips/ slot combo	2.0 - 2.5 (17.7 - 22.1)

2.12 Main Circuit Wiring

Model	Terminal	Recommended Gauge mm ²	Wire Range mm ²	Wire Stripping Length *1 mm	Terminal Screw		Tightening Torque N·m (lb·in)
					Size	Shape	
2042	R/L1, S/L2, T/L3	14	2 - 14	10	M4	Slot (-)	1.5 - 1.7 (13.5 - 15)
	U/T1, V/T2, W/T3	14	2 - 14	10	M4	Slot (-)	1.5 - 1.7 (13.5 - 15)
	-, +1, +2	22	2 - 22	18	M5	Slot (-)	2.3 - 2.5 (19.8 - 22) *2
	B1, B2	5.5	2 - 5.5	10	M4	Slot (-)	1.5 - 1.7 (13.5 - 15)
	⊕	5.5	5.5 - 8	-	M5	Phillips/ slot combo	2.0 - 2.5 (17.7 - 22.1)
2056	R/L1, S/L2, T/L3	22	8 - 22	18	M5	Slot (-)	2.3 - 2.5 (19.8 - 22) *2
	U/T1, V/T2, W/T3	14	5.5 - 14	18	M5	Slot (-)	2.3 - 2.5 (19.8 - 22) *2
	-, +1, +2	38	8 - 38	20	M6	Hex socket cap (WAF: 5 mm)	5 - 5.5 (45 - 49)
	B1, B2	14	2 - 14	10	M4	Slot (-)	1.5 - 1.7 (13.5 - 15)
	⊕	8	8 - 14	-	M6	Phillips/ slot combo	5.4 - 6.0 (47.8 - 53.1)
2070	R/L1, S/L2, T/L3	Tentative					
	U/T1, V/T2, W/T3						
	-, +1, +2						
	B1, B2						
	⊕						
2082	R/L1, S/L2, T/L3	Tentative					
	U/T1, V/T2, W/T3						
	-, +1, +2						
	B1, B2						
	⊕						
2110	R/L1, S/L2, T/L3	Tentative					
	U/T1, V/T2, W/T3						
	-, +1						
	B1, B2						
	⊕						
2138	R/L1, S/L2, T/L3	Tentative					
	U/T1, V/T2, W/T3						
	-, +1						
	B1, B2						
	⊕						

Model	Terminal	Recommended Gauge mm ²	Wire Range mm ²	Wire Stripping Length *1 mm	Terminal Screw		Tightening Torque N·m (lb·in)
					Size	Shape	
2169	R/L1, S/L2, T/L3						Tentative
	U/T1, V/T2, W/T3						
	-, -, +1, +1						
	+3						
	⊕						
2211	R/L1, S/L2, T/L3						Tentative
	U/T1, V/T2, W/T3						
	-, -, +1, +1						
	+3						
	⊕						
2257	R/L1, S/L2, T/L3						Tentative
	U/T1, V/T2, W/T3						
	-, +1						
	+3						
	⊕						
2313	R/L1, S/L2, T/L3						Tentative
	U/T1, V/T2, W/T3						
	-, +1						
	+3						
	⊕						
2360	R/L1, S/L2, T/L3						Tentative
	U/T1, V/T2, W/T3						
	-, +1						
	+3						
	⊕						
2415	R/L1, S/L2, T/L3						Tentative
	U/T1, V/T2, W/T3						
	-, +1						
	+3						
	⊕						

*1 Remove the insulator from the tips of wires to the length shown in "Wire Stripping Length."

*2 When using wire with a gauge over 30 mm², tighten to a tightening torque of 4.1 to 4.5 N·m (36 to 40 lb·in.).

Table 2.15 Wire Gauges and Tightening Torques for 400 V Class Drives

Model	Terminal	Recommended Gauge mm ²	Wire Range mm ²	Wire Stripping Length *1 mm	Terminal Screw		Tightening Torque N·m (lb·in)
					Size	Shape	
4002	R/L1, S/L2, T/L3	2	2 - 14	10	M4	Slot (-)	1.5 - 1.7 (13.5 - 15)
	U/T1, V/T2, W/T3	2	2 - 14	10	M4	Slot (-)	1.5 - 1.7 (13.5 - 15)
	-, +1, +2	2	2 - 22	18	M5	Slot (-)	2.3 - 2.5 (19.8 - 22) *2
	B1, B2	2	2 - 5.5	10	M4	Slot (-)	1.5 - 1.7 (13.5 - 15)
	⊕	2	2 - 5.5	-	M4	Phillips/ slot combo	1.2 - 1.5 (10.6 - 13.3)
4004	R/L1, S/L2, T/L3	2	2 - 14	10	M4	Slot (-)	1.5 - 1.7 (13.5 - 15)
	U/T1, V/T2, W/T3	2	2 - 14	10	M4	Slot (-)	1.5 - 1.7 (13.5 - 15)
	-, +1, +2	2	2 - 22	18	M5	Slot (-)	2.3 - 2.5 (19.8 - 22) *2
	B1, B2	2	2 - 5.5	10	M4	Slot (-)	1.5 - 1.7 (13.5 - 15)
	⊕	2	2 - 5.5	-	M4	Phillips/ slot combo	1.2 - 1.5 (10.6 - 13.3)
4005	R/L1, S/L2, T/L3	2	2 - 14	10	M4	Slot (-)	1.5 - 1.7 (13.5 - 15)
	U/T1, V/T2, W/T3	2	2 - 14	10	M4	Slot (-)	1.5 - 1.7 (13.5 - 15)
	-, +1, +2	2	2 - 22	18	M5	Slot (-)	2.3 - 2.5 (19.8 - 22) *2
	B1, B2	2	2 - 5.5	10	M4	Slot (-)	1.5 - 1.7 (13.5 - 15)
	⊕	3.5	2 - 5.5	-	M4	Phillips/ slot combo	1.2 - 1.5 (10.6 - 13.3)
4007	R/L1, S/L2, T/L3	2	2 - 14	10	M4	Slot (-)	1.5 - 1.7 (13.5 - 15)
	U/T1, V/T2, W/T3	2	2 - 14	10	M4	Slot (-)	1.5 - 1.7 (13.5 - 15)
	-, +1, +2	2	2 - 22	18	M5	Slot (-)	2.3 - 2.5 (19.8 - 22) *2
	B1, B2	2	2 - 5.5	10	M4	Slot (-)	1.5 - 1.7 (13.5 - 15)
	⊕	3.5	2 - 5.5	-	M4	Phillips/ slot combo	1.2 - 1.5 (10.6 - 13.3)

Model	Terminal	Recommended Gauge mm ²	Wire Range mm ²	Wire Stripping Length *1 mm	Terminal Screw		Tightening Torque N·m (lb·in)
					Size	Shape	
4009	R/L1, S/L2, T/L3	2	2 - 14	10	M4	Slot (-)	1.5 - 1.7 (13.5 - 15)
	U/T1, V/T2, W/T3	2	2 - 14	10	M4	Slot (-)	1.5 - 1.7 (13.5 - 15)
	-, +1, +2	2	2 - 22	18	M5	Slot (-)	2.3 - 2.5 (19.8 - 22) *2
	B1, B2	2	2 - 5.5	10	M4	Slot (-)	1.5 - 1.7 (13.5 - 15)
	⊕	3.5	2 - 5.5	-	M4	Phillips/ slot combo	1.2 - 1.5 (10.6 - 13.3)
4012	R/L1, S/L2, T/L3	2	2 - 14	10	M4	Slot (-)	1.5 - 1.7 (13.5 - 15)
	U/T1, V/T2, W/T3	2	2 - 14	10	M4	Slot (-)	1.5 - 1.7 (13.5 - 15)
	-, +1, +2	3.5	2 - 22	18	M5	Slot (-)	2.3 - 2.5 (19.8 - 22) *2
	B1, B2	2	2 - 5.5	10	M4	Slot (-)	1.5 - 1.7 (13.5 - 15)
	⊕	3.5	2 - 5.5	-	M4	Phillips/ slot combo	1.2 - 1.5 (10.6 - 13.3)
4018	R/L1, S/L2, T/L3	3.5	2 - 14	10	M4	Slot (-)	1.5 - 1.7 (13.5 - 15)
	U/T1, V/T2, W/T3	3.5	2 - 14	10	M4	Slot (-)	1.5 - 1.7 (13.5 - 15)
	-, +1, +2	5.5	2 - 22	18	M5	Slot (-)	2.3 - 2.5 (19.8 - 22) *2
	B1, B2	2	2 - 5.5	10	M4	Slot (-)	1.5 - 1.7 (13.5 - 15)
	⊕	3.5	2 - 5.5	-	M5	Phillips/ slot combo	2.0 - 2.5 (17.7 - 22.1)
4023	R/L1, S/L2, T/L3	8	2 - 14	10	M4	Slot (-)	1.5 - 1.7 (13.5 - 15)
	U/T1, V/T2, W/T3	5.5	2 - 14	10	M4	Slot (-)	1.5 - 1.7 (13.5 - 15)
	-, +1, +2	14	2 - 22	18	M5	Slot (-)	2.3 - 2.5 (19.8 - 22) *2
	B1, B2	2	2 - 5.5	10	M4	Slot (-)	1.5 - 1.7 (13.5 - 15)
	⊕	3.5	3.5 - 5.5	-	M5	Phillips/ slot combo	2.0 - 2.5 (17.7 - 22.1)

2.12 Main Circuit Wiring

Model	Terminal	Recommended Gauge mm ²	Wire Range mm ²	Wire Stripping Length *1 mm	Terminal Screw		Tightening Torque N·m (lb·in)
					Size	Shape	
4031	R/L1, S/L2, T/L3	14	8 - 22	18	M5	Slot (-)	2.3 - 2.5 (19.8 - 22) *2
	U/T1, V/T2, W/T3	8	5.5 - 14	18	M5	Slot (-)	2.3 - 2.5 (19.8 - 22) *2
	-, +1, +2	14	8 - 38	20	M6	Hex socket cap (WAF: 5 mm)	5 - 5.5 (45 - 49)
	B1, B2	3.5	2 - 14	10	M4	Slot (-)	1.5 - 1.7 (13.5 - 15)
	⊕	5.5	5.5 - 8	-	M6	Phillips/ slot combo	5.4 - 6.0 (47.8 - 53.1)
4038	R/L1, S/L2, T/L3	14	8 - 22	18	M5	Slot (-)	2.3 - 2.5 (19.8 - 22) *2
	U/T1, V/T2, W/T3	14	5.5 - 14	18	M5	Slot (-)	2.3 - 2.5 (19.8 - 22) *2
	-, +1, +2	22	8 - 38	20	M6	Hex socket cap (WAF: 5 mm)	5 - 5.5 (45 - 49)
	B1, B2	5.5	2 - 14	10	M4	Slot (-)	1.5 - 1.7 (13.5 - 15)
	⊕	8	5.5 - 14	-	M6	Phillips/ slot combo	5.4 - 6.0 (47.8 - 53.1)
4044	R/L1, S/L2, T/L3	Tentative					
	U/T1, V/T2, W/T3						
	-, +1, +2						
	B1, B2						
	⊕						
4060	R/L1, S/L2, T/L3	Tentative					
	U/T1, V/T2, W/T3						
	-, +1						
	B1, B2						
	⊕						
4075	R/L1, S/L2, T/L3	Tentative					
	U/T1, V/T2, W/T3						
	-, +1						
	B1, B2						
	⊕						
4089	R/L1, S/L2, T/L3	Tentative					
	U/T1, V/T2, W/T3						
	-, +1						
	B1, B2						
	⊕						

Model	Terminal	Recommended Gauge mm ²	Wire Range mm ²	Wire Stripping Length *1 mm	Terminal Screw		Tightening Torque N·m (lb·in)
					Size	Shape	
4103	R/L1, S/L2, T/L3						Tentative
	U/T1, V/T2, W/T3						
	-, +1						
	B1, B2						
	⊕						
4140	R/L1, S/L2, T/L3						Tentative
	U/T1, V/T2, W/T3						
	-, -, +1, +1						
	B1, B2						
	⊕						
4168	R/L1, S/L2, T/L3						Tentative
	U/T1, V/T2, W/T3						
	-, -, +1, +1						
	B1, B2						
	⊕						
4208	R/L1, S/L2, T/L3						Tentative
	U/T1, V/T2, W/T3						
	-, +1						
	+3						
	⊕						
4250	R/L1, S/L2, T/L3						Tentative
	U/T1, V/T2, W/T3						
	-, +1						
	+3						
	⊕						
4296	R/L1, S/L2, T/L3						Tentative
	U/T1, V/T2, W/T3						
	-, +1						
	+3						
	⊕						
4371	R/L1, S/L2, T/L3						Tentative
	U/T1, V/T2, W/T3						
	-, +1						
	+3						
	⊕						
4389	R/L1, S/L2, T/L3						Tentative
	U/T1, V/T2, W/T3						
	-, +1						
	+3						
	⊕						

2.12 Main Circuit Wiring

Model	Terminal	Recommended Gauge mm ²	Wire Range mm ²	Wire Stripping Length ^{*1} mm	Terminal Screw		Tightening Torque N·m (lb·in)
					Size	Shape	
4453	R/L1, S/L2, T/L3 R1/L11, S1/L21, T1/L31			Tentative			
	U/T1, V/T2, W/T3						
	-, +1						
	+3						
	⊕						
4568	R/L1, S/L2, T/L3 R1/L11, S1/L21, T1/L31			Tentative			
	U/T1, V/T2, W/T3						
	-, +1						
	+3						
	⊕						
4675	R/L1, S/L2, T/L3 R1/L11, S1/L21, T1/L31			Tentative			
	U/T1, V/T2, W/T3						
	-, +1						
	+3						
	⊕						

*1 Remove the insulator from the tips of wires to the length shown in “Wire Stripping Length.”

*2 When using wire with a gauge over 30 mm², tighten to a tightening torque of 4.1 to 4.5 N·m (36 to 40 lb·in.).

◆ Main Circuit Terminal and Motor Wiring

This section outlines the various steps, precautions, and checkpoints for wiring the main circuit terminals and motor terminals.

NOTICE: When connecting the motor to the drive output terminals U/T1, V/T2, and W/T3, the phase order for the drive and motor should match. Failure to comply with proper wiring practices may cause the motor to run in reverse if the phase order is backward.

NOTICE: Do not connect phase-advancing capacitors or LC/RC noise filters to the output circuits. Failure to comply could damage the drive, phase-advancing capacitors, LC/RC noise filters or RCM/RCD.

WARNING! Electrical Shock Hazard. Do not connect the AC power line to the output terminals of the drive. Failure to comply could result in death or serious injury by fire as a result of drive damage from line voltage application to output terminals.

■ Cable Length Between Drive and Motor

Voltage drop along the motor cable may cause reduced motor torque when the wiring between the drive and the motor is too long, especially at low frequency output. This can also be a problem when motors are connected in parallel with a fairly long motor cable. Drive output current will increase as the leakage current from the cable increases. An increase in leakage current may trigger an overcurrent situation and weaken the accuracy of the current detection.

Adjust the drive carrier frequency according to the following table. If the motor wiring distance exceeds 100 m because of the system configuration, implement strategies such as avoiding the use of metal conduits, or use separate cables for each phase so that stray capacitance is reduced.

Cable Length Between Drive and Motor	Up to 50 m	Up to 100 m	Greater than 100 m
Carrier Frequency	15 kHz or less	5 kHz or less	2 kHz or less

Note:

- When setting carrier frequency in a drive running multiple motors, calculate the cable length as the total distance of wiring to all motors that are connected.
- The maximum cable length is 100 m when using Open Loop Vector Control for PM [$A1-02 = 5$], and Advanced Open Loop Vector Control for PM [$A1-02 = 6$].

■ Ground Wiring

Follow the precautions to wire the ground for one drive or a series of drives.

WARNING! Electrical Shock Hazard. Check to make sure that the protective ground wire complies with technical standards and local safety regulations. The leakage current of inverter models 4389A to 4675A, 2xxxB/C and 4xxxB/C will exceed 3.5 mA. As written in the IEC/EN 61800-5-1:2007 standard, the power supply should be wired so that it automatically turns off in the event the protective ground wire is disconnected, or else connect a protective ground wire with a cross sectional area of at least 10 mm² (copper wire) or 16 mm² (aluminum wire). Failure to meet these standards may result in electric shock.

WARNING! Electrical Shock Hazard. Ensure that the neutral point on the power supply of this product (model number 2xxxB/C, 4xxxA/B/C) is grounded for compliance with the EMC Directive before EMC filter is switched ON or if there is high resistance grounding. Failure to comply could cause death or serious injury.

WARNING! Electrical Shock Hazard. Always use a ground wire that complies with technical standards on electrical equipment and minimize the length of the ground wire. Improper equipment grounding may cause dangerous electrical potentials on equipment chassis, which could result in death or serious injury.

WARNING! Electrical Shock Hazard. Be sure that the ground terminals are grounded properly. Follow federal and local electrical wiring codes for proper grounding methods (200 V class: ground to 100 Ω or less; 400 V class: ground to 10 Ω or less). Improper equipment grounding could result in death or serious injury by contacting ungrounded electrical equipment.

NOTICE: Do not share the ground wire with other devices such as welding machines or large-current electrical equipment. Improper equipment grounding could result in drive or equipment malfunction due to electrical interference.

NOTICE: When using more than one drive, ground multiple drives according to instructions. Improper equipment grounding could result in abnormal operation of drive or equipment.

Refer to the following figure when using multiple drives. Do not loop the grounding wire.

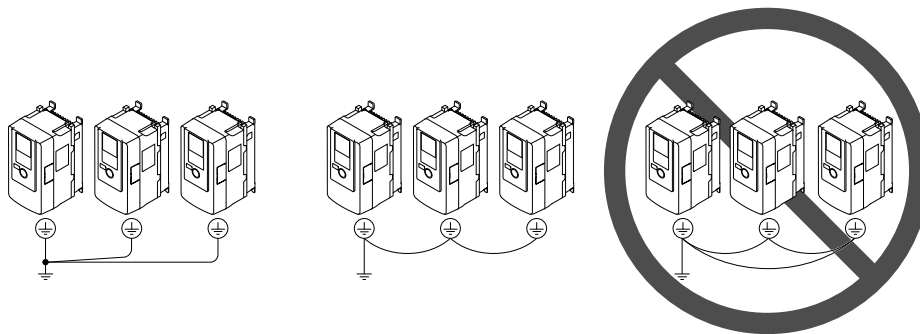

Figure 2.32 Multiple Drive Wiring

■ Wiring the Main Circuit Terminal Block

WARNING! Electrical Shock Hazard. Shut off the power supply to the drive before wiring the main circuit terminals. Failure to comply may result in death or serious injury.

Wire the main circuit terminals after the terminal board has been properly grounded.

■ Main Circuit Configuration

The main circuit of the drive is configured as follows. Connections may vary based on drive capacity. The DC power supply for the main circuit also provides power to the control circuit.

Note:

Drive models 2004A to 2415A, 4002A to 4765A do not have a built-in EMC filter circuit.

WARNING! Fire Hazard. The braking resistor connection terminals are B1 and B2. Do not connect braking resistors to any other terminals. Improper wiring connections could cause the braking resistor to overheat and cause death or serious injury by fire. Failure to comply may result in damage to the braking circuit or drive.

NOTICE: Do not use the negative DC bus terminal “-” as a ground terminal. This terminal is at high DC voltage potential. Improper wiring connections could damage the drive.

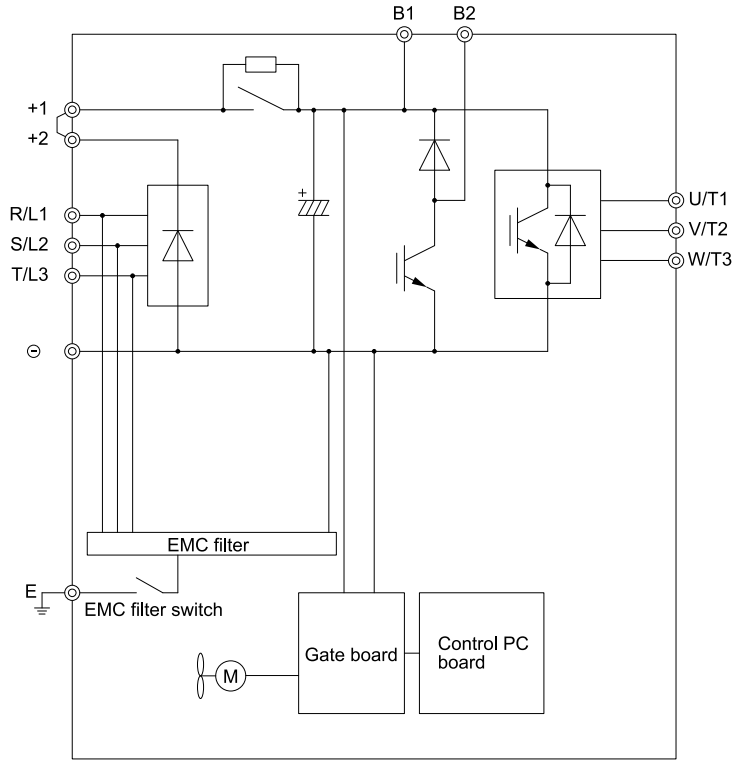

Figure 2.33 Drive Main Circuit Configuration (2004 - 2082, 4002 - 4044)

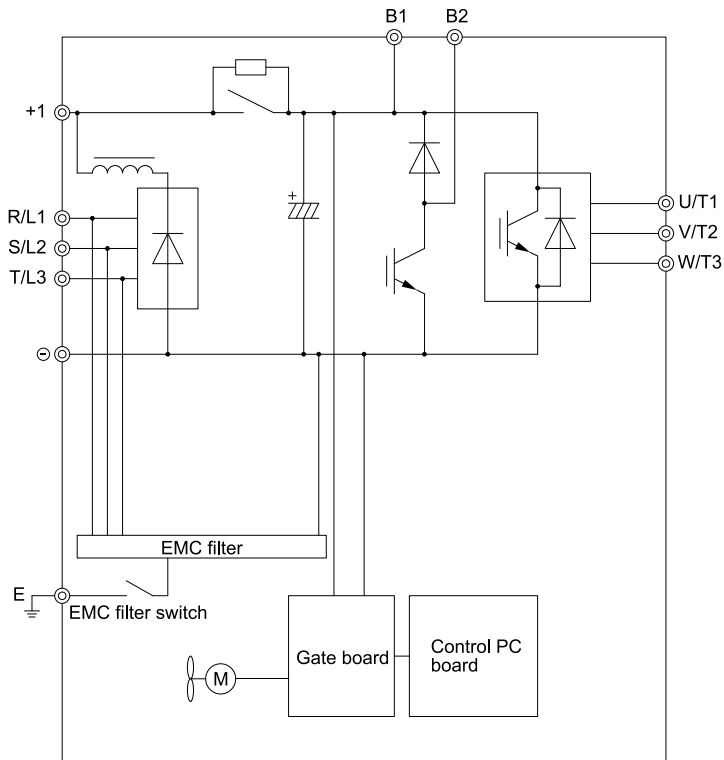

Figure 2.34 Drive Main Circuit Configuration (2110 - 2138, 4060 - 4168)

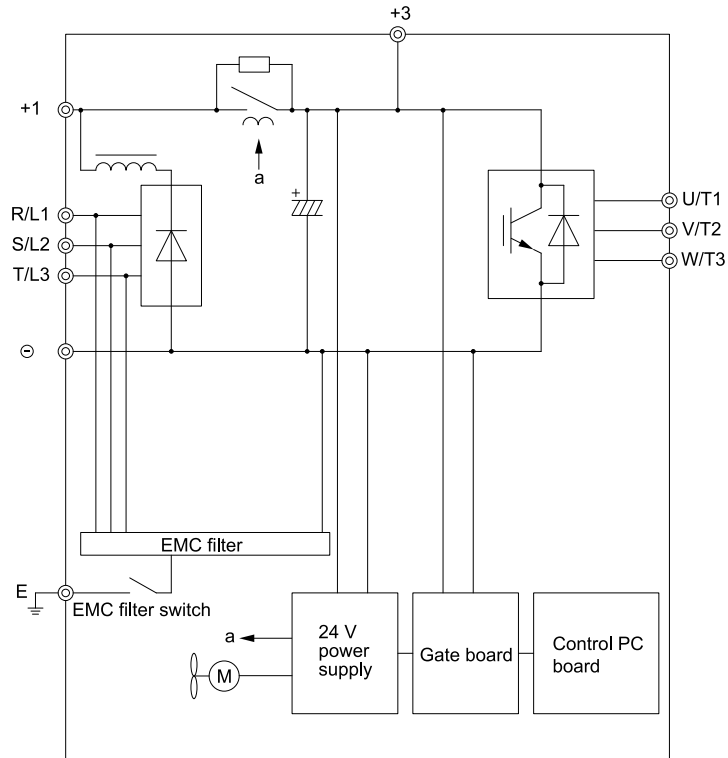

Figure 2.35 Drive Main Circuit Configuration (2169 - 2313, 4208 - 4250)

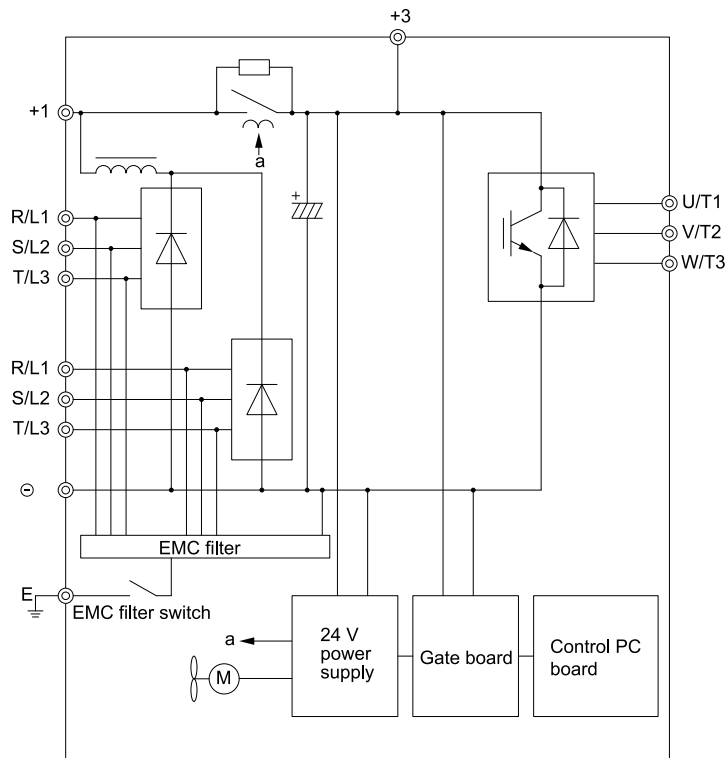

Figure 2.36 Drive Main Circuit Configuration (2360 - 2415, 4296 - 4675)

◆ Protection of Main Circuit Terminals

When wiring the main circuit terminals, take due care so as not to allow any cable ends to come near any nearby terminals or the drive itself. When wiring, use insulation caps if using crimped terminals.

2.13 Wiring Procedure for the Main Circuit Terminal Block

DANGER! Electrical Shock Hazard. Do not perform inspections or wiring while the drive is energized. De-energize all devices before carrying out any wiring or repair operations. Voltage will remain within the capacitors inside the drive even after the power has been switched off. The Charge LED is extinguished once the DC bus voltage goes below 50 V DC. To prevent electric shock, always wait for at least the amount of time indicated on the warning labels and confirm that all indicators are OFF. Then, remove the front cover and terminal cover, measure the input power supply voltage and the DC bus voltage, and make sure that the voltages have been lowered to safe levels. Failure to comply may result in death or serious injury.

The procedure for wiring the main circuit terminal block differs depending on the drive model. Refer to [Table 2.16](#) for details.

Table 2.16 Types of Wiring Procedure for the Main Circuit Terminal Block

Model	Procedure
2004 - 2056 4002 - 4038	Procedure A
2070 - 2211 4044 - 4168	Preparing
2257 - 2415 4208 - 4675	Preparing

◆ Wiring the Main Circuit Terminal Block Using Procedure A

Wire the main circuit terminal block correctly in accordance with the instructions in the manual.

Read the following instructions before wiring the terminal block.

■ Notes on Wiring the Main Circuit Terminal Block

Note:

- Use copper wire. Non-copper wire such as aluminum wire cannot be used.
- Be sure remove any foreign objects on the wire connections for the terminal block.
- Remove the insulator from the connection wires to the wire stripping lengths listed in the manual.
- Do not use a wire with bent or crushed conductor. If a deformed wire is used for connection, cut off the bent end of the wire before using it.
- When using stranded wire, do not solder the conductor portion.
- When stranded wire is used, wire it so that no wire fibers protrude out of the connection. Do not excessively twist the stranded wire.
- Insert the wire until it is completely inside the terminal block. Once the insulator from the wire is removed to the suggested wire stripping length, the insulator will fit within the plastic housing.
- The tightening torque is different for each terminal. Tighten the screws to the specified tightening torque.
- Use a torque driver, torque ratchet or torque wrench that is designed for the screws. A flat end driver or a hex tool will be needed when wiring the screw clamp terminal. Refer to the recommended conditions listed in the product manual and provide tools accordingly.
- When using an electric driver to tighten, be especially careful and tighten at low speed, 300 to 400 r/min.
- Wiring tools can be purchased from Yaskawa. Contact Yaskawa or your nearest sales representative for details.
- When replacing your existing drive with this one, the existing wires may have wire gauges that are out of range of some of the gauges applicable to the new drive. For the usable and unusable wire gauges, contact Yaskawa or your nearest sales representative.
- After connecting the wires, gently pull on the wires to check that they do not pull out.
- Cut off an appropriate section of the wiring cover to facilitate the wiring.
- Regularly tighten any loose terminal block screws to their specified tightening torques.
- To protect the wiring connections from strain forces, be sure to secure wires near wiring parts using some sort of strain relief system. Refer to the following diagram.

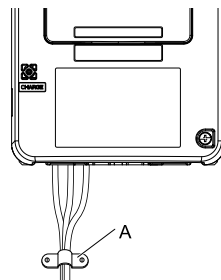

A - Strain relief

Figure 2.37 Wiring Example Using Strain Relief

Table 2.17 Recommended Wiring Tools

Screw Size	Screw Shape	Adapter	Bit Model	Torque Driver Model (Tightening Torque)	Torque Wrench Model	Manufacturer
M4	Slot (-)	Bit	SF-BIT-SL 1, 0X4,0-70	TSD-M 3NM (1.2 - 3 N·m)	-	PHOENIX CONTACT
M5	Slot (-)	Bit	SF-BIT-SL 1, 2X6,5-70	TSD-M 3NM (1.2 - 3 N·m) *1	*1	PHOENIX CONTACT
M6	Hex socket cap (WAF: 5 mm)	Socket	*2	-	*2	*2
M8	Hex socket cap (WAF: 6 mm)	Socket	*2	-	*2	*2
M10	Hex socket cap (WAF: 8 mm)	Socket	*2	-	*2	*2

*1 When wiring the drive models 2110 and 4075 or below, select tools correctly based on the wire gauges.

- ≤ 25 mm² (AWG 10): TSD-M 3NM
- ≥ 30 mm² (AWG 8): Torque wrench that includes a torque measurement range of 4.5 N·m

*2 Contact Yaskawa or your nearest sales representative for details.

■ Wiring Procedure (Procedure A)

Remove the keypad and front cover before wiring.

1. Remove the wiring cover by pulling it forward.

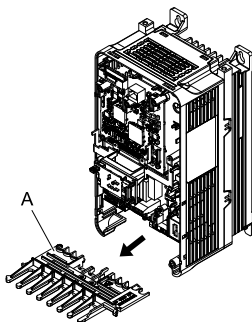

A - Wiring cover

Figure 2.38 Remove the Wiring Cover

2. Insert a wire whose ends have been prepared.

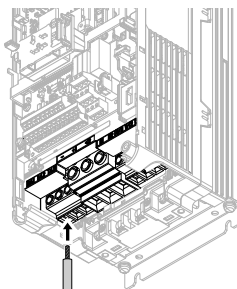

Figure 2.39 Install the Electrical Wire

Note:

When wiring to terminals +1 and +2, if a jumper connects terminals +1 and +2, first loosen the terminal block screws and remove the jumper.

3. Tighten the screws to the specified torque.

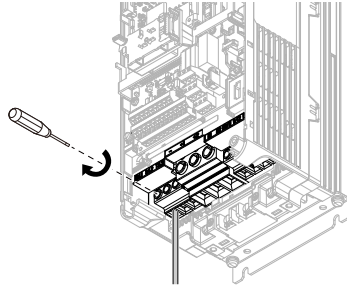
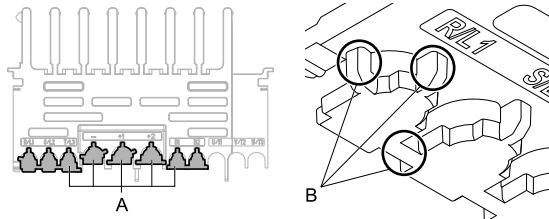

Figure 2.40 Tighten Terminal Block Screws

4. Check the signal from the wired terminal and use a nipper to clip the cutaway section of the corresponding wiring cover.

Use a nipper to clip the areas shown in the following figure.



A - Cutaway section

B - Use a nipper to clip this area.

Figure 2.41 Clip the Cutaway Section of the Wiring Cover

Note:

- The shape of the wiring cover differs depending on the drive model.
- Detach the cutaway section of the wiring cover by clipping only the areas that apply to the wired terminal. If areas that do not apply to the wired terminal are clipped, the protective enclosure will not maintain the IP20 protective level.
- When clipping the cutaway section of the wiring cover, firmly hold the cutaway section so that the section does not fly out, then cut it. The cutaway section may fly out resulting in injury.
- Process the cross section to prevent the cutaway section of the wiring cover from damaging the electric wires.
- If electrical wires other than those specified by Yaskawa are used, the protective enclosure may not maintain the IP20 protective level, even if the wiring cover is used correctly. Contact Yaskawa or your nearest sales representative for details.

5. Install the wiring cover at its original position. Pass the cables through the holes that were cut out of the cable cover.

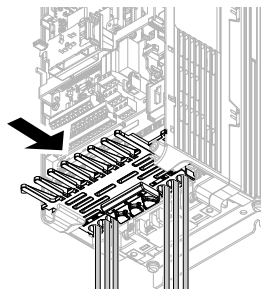

Figure 2.42 Reattach the Wiring Cover

6. Install the front cover and the keypad at their original positions.

2.14 Control Circuit Wiring

This section explains the wiring for the control circuit.

◆ Control Circuit Connection Diagram

Wire the control circuit as shown in the following figure.

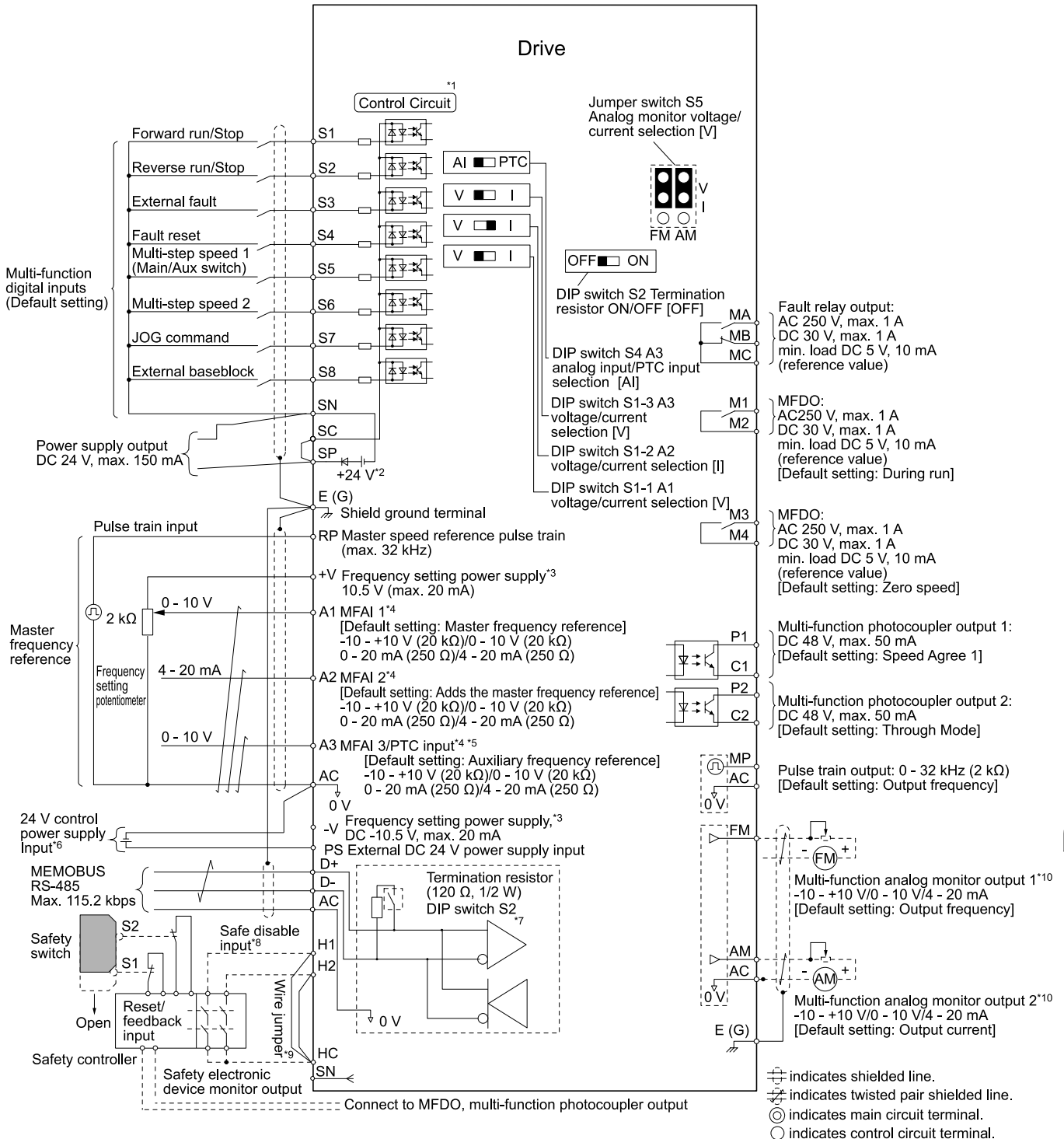

Figure 2.43 Control Circuit Connection Diagram

- *1 Supplying power to the control circuit separately from the main circuit requires a 24 V power supply be input to terminal PS-AC.
- *2 Install a wire jumper between terminals SC-SP-SN to select the type of the power supply of MFDI (sinking/sourcing mode or internal/external power supply). Do not short terminals SP and SN. Failure to comply will damage the drive.

- Sinking mode: Short terminals SC and SP.
 - Sourcing mode: Short terminals SC and SN.
 - External power supply: No jumper necessary.
- *3 The maximum output current capacity of the +V and -V terminals on the control circuit is 20 mA. Do not short terminals +V, -V, and AC. Failure to comply may cause malfunction or failure.
- *4 Set DIP switches S1-1 to S1-3 to select between a voltage or current input signal to terminals A1 to A3. The default setting for S1-1 and S1-3 is voltage reference input ("V" side). The default setting for S1-2 is current reference input ("I" side).
- *5 Do not ground the control circuit terminals AC or connect them to the drive. Failure to comply may cause malfunction or failure.
- *6 Do not connect terminals PS and AC inversely. Failure to comply will damage the drive.
- *7 Enable the termination resistor in the last drive in a MEMOBUS/Modbus communications by setting DIP switch S2 to the ON position.
- *8 Use sourcing mode when using an internal power supply for Safe Disable input.
- *9 Disconnect the wire jumper between H1 - HC and H2 - HC when utilizing the Safe Disable input.
- *10 Monitor outputs work with devices such as analog frequency meters, ammeters, voltmeters, and wattmeters. They are not intended for use as a feedback-type of signal.

◆ Control Circuit Terminal Block Functions

Hx-xx parameters set functions assigned to the multi-function input and output terminals.

WARNING! *Sudden Movement Hazard. Always check the operation and wiring of control circuits after being wired. Operating a drive with untested control circuits could cause death or serious injury.*

WARNING! *Sudden Movement Hazard. Confirm the drive I/O signals and external sequence before starting test run. Setting parameter A1-06 [Application Preset] may change the I/O terminal function automatically from the factory setting. Failure to comply may cause death or serious injury.*

NOTICE: *To extend the service life of the relay contacts and electrolytic capacitors inside the drive, the MC on the power source side for turning the drive on (run) and off (stop) should be operated a maximum of one time in 30 minutes. Running and stopping the motor should be done as much as possible via the run and stop operations of the drive. The drive can be run and stopped by turning it on and off via the MC on the power source side, but if this is done frequently, it may cause the drive to fail. Improper operation may shorten the service life of the relay contact and electrolytic capacitor.*

■ Input Terminals

Refer to the [Table 2.18](#) for a list of input terminals and functions.

Text in parenthesis indicates the default setting for each multi-function output.

Table 2.18 Multi-function Digital Input Terminals

Type	Terminal	Name (Default)	Function (Signal Level)
Multi-function digital input	S1	Multi-function input selection 1 (ON: Forward run OFF: Stop)	<ul style="list-style-type: none"> • Photocoupler • 24 V, 6 mA Note: Install a jumper between terminals SN-SC-SP to select the type of the power supply of MFDI. <ul style="list-style-type: none"> • Sinking mode: Short terminals SC-SP. • Sourcing mode: Short terminals SN-SC. • External power supply: No jumper necessary.
	S2	Multi-function input selection 2 (ON: Reverse run OFF: Stop)	
	S3	Multi-function input selection 3 (External fault (N.O.))	
	S4	Multi-function input selection 4 (Fault reset)	
	S5	Multi-function input selection 5 (Multi-step speed reference 1)	
	S6	Multi-function input selection 6 (Multi-step speed reference 2)	
	S7	Multi-function input selection 7 (Jog command)	
	S8	Multi-function input selection 8 (Baseblock command (N.O.))	
	SN	Multi-function input power supply 0 V	
	SC	Multi-function input selection common	
SP	Multi-function input power supply +24 VDC		
Safe Disable input	H1	Safe Disable input 1	Remove the jumper between terminals H1-HC and H2-HC when using the Safe Disable input. <ul style="list-style-type: none"> • 24 V, 6 mA • ON: Normal operation • OFF: Coasting motor • Internal impedance 4.7 kΩ • OFF time of at least 2 ms
	H2	Safe Disable input 2	
	HC	Safe Disable function common	Safe Disable function common Note: Do not short terminals HC and SN. Failure to comply will damage the drive.

2.14 Control Circuit Wiring

Type	Terminal	Name (Default)	Function (Signal Level)
Master frequency reference	RP	Master frequency reference pulse train input (Master frequency reference)	<ul style="list-style-type: none"> Response frequency: 0 Hz to 32 kHz Heavy duty: 30% to 70% H level voltage: 3.5 V to 13.2 V L level voltage: 0.0 V to 0.8 V Input impedance: 3 kΩ
	+V	Power supply for frequency setting	10.5 V (allowable current 20 mA max.)
	-V	Power supply for frequency setting	-10.5 V (allowable current 20 mA max.)
	A1	Multi-function analog input 1 (Master frequency reference)	Voltage input or current input Select terminal A1 using DIP switch S1-1 and H3-01 [Terminal A1 Signal Level Select].
	A2	Multi-function analog input 2 (Frequency reference bias with terminal A1)	Select terminal A2 using DIP switch S1-2 and H3-09 [Terminal A2 Signal Level Select] <ul style="list-style-type: none"> -10 V to +10 V/-100% to 100% 0 V to 10 V/100% (input impedance: 20 kΩ) 4 mA to 20 mA/100%, 0 mA to 20 mA/100% (input impedance: 250 kΩ)
	A3	Multi-function analog input 3/PTC input (Auxiliary frequency reference)	<ul style="list-style-type: none"> Voltage input or current input Select using DIP switch S1-3 and H3-05 [Terminal A3 Signal Level Select]. -10 V to +10 V/-100% to 100% 0 V to 10 V/100% (input impedance: 20 kΩ) 4 mA to 20 mA/100%, 0 mA to 20 mA/100% (input impedance: 250 kΩ) PTC input (Motor Overload Protection) Set DIP switch S4 to "PTC" and set DIP switch S1-3 to "V" to set terminal A3 for PTC input.
	AC	Frequency reference common	0 V
E (G)	Connecting shielded cable and option card ground wire	-	

■ Output Terminals

Refer to [Table 2.19](#) and [Table 2.20](#) for a list of output terminals and functions.

Text in parenthesis indicates the default setting for each multi-function output.

Table 2.19 Control Circuit Output Terminals

Type	Terminal	Name (Default)	Function (Signal Level)
Fault relay output	MA	N.O. output (Fault)	<ul style="list-style-type: none"> Relay output 30 Vdc, 10 mA to 1 A 250 Vac, 10 mA to 1 A Minimum load: 5 V, 10 mA (Reference value)
	MB	N.C. output (Fault)	
	MC	Digital output common	
Multi-function digital output	M1	Multi-function digital output (During run)	<ul style="list-style-type: none"> Relay output 30 Vdc, 10 mA to 1 A 250 Vac, 10 mA to 1 A Minimum load: 5 V, 10 mA (Reference value) <p>Note: Refrain from assigning functions that frequently switch ON/OFF to terminals M1 and M2, as doing so will shorten relay contact performance life. Switching life is estimated at 200,000 times (assumes 1 A, resistive load).</p>
	M2		
	M3	Multi-function digital output (Zero speed)	
	M4		
Multi-function photocoupler output	P1	Multi-function photocoupler output (Speed agree 1)	<ul style="list-style-type: none"> Photocoupler output 48 V, 2 mA to 50 mA <p>Note: Connect a flywheel diode as shown in Figure 2.44 when driving a reactive load such as a relay coil. Ensure the diode rating is greater than the circuit voltage.</p>
	C1		
	P2	Multi-function photocoupler output (Through Mode)	
	C2		

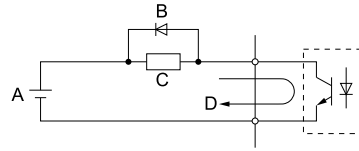

A - External power, 48 V max. **C - Coil**
B - Flywheel diode **D - 50 mA or less**

Figure 2.44 Connecting a Flywheel Diode

Table 2.20 Control Circuit Monitor Output Terminals

Type	Terminal	Name (Default)	Function (Signal Level)
Monitor output	MP	Pulse Train Output (Output frequency)	32 kHz max. Refer to "Pulse Train Output" for details.
	FM	Analog monitor output 1 (Output frequency)	Voltage or current output • 0 V to 10 V/0% to 100% • -10 V to 10 V/-100% to 100% • 4 mA to 20 mA Note: Select using jumper switch S5 and H4-07 [MFAO Term FM Signal Level Select] or H4-08 [MFAO Term AM Signal Level Select].
	AM	Analog monitor output 2 (Output current)	
	AC	Monitor common	0 V

■ **External power supply input terminals**

The following table lists the functions of the external power supply input terminals.

Table 2.21 External power supply input terminals

Type	Terminal	Name (Default)	Function
External power supply input terminals	PS	External 24 V power supply input	Supplies backup power to the drive control circuit, keypad, and option board. 21.6 VDC to 26.4 VDC, 700 mA
	AC	External 24 V power supply ground	0 V

■ **Serial Communication Terminals**

Refer to [Table 2.22](#) for a list of serial communication terminals and functions.

Table 2.22 Serial Communication Terminals

Type	Terminal	Terminal Name	Function (Signal Level)	
MEMOBUS/Modbus communications	D+	Communication input/output (+)	MEMOBUS/Modbus communications Use an RS-485 cable to connect the drive. Note: Set DIP switch S2 to ON to enable the termination resistor in the last drive in a MEMOBUS/Modbus network.	<ul style="list-style-type: none"> • RS-485 • MEMOBUS/Modbus communication protocol • Max. 115.2 kbps
	D-	Communication output (-)		
	AC	Shield ground	0 V	

◆ **Control Circuit Terminal Configuration**

Control circuit terminals should be arranged as shown in the following figure.

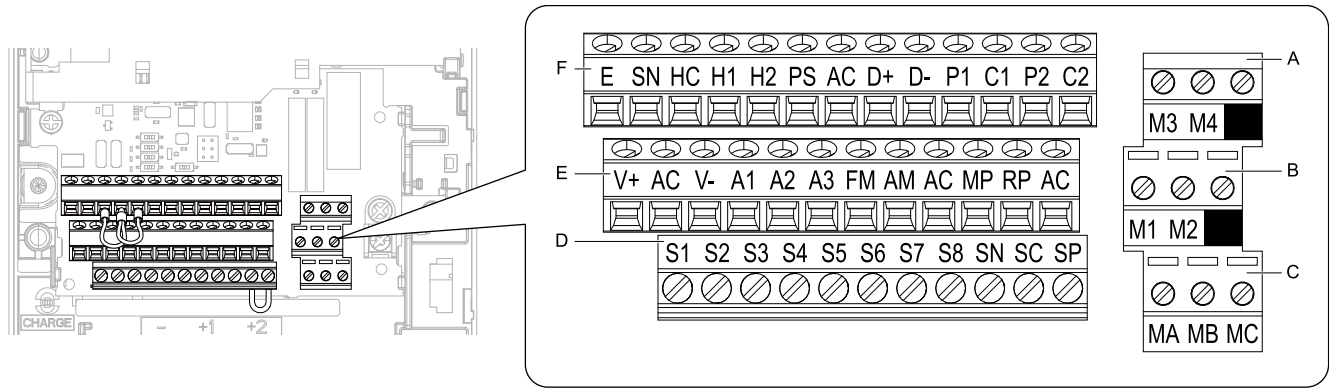

- A - Terminal block (TB2-3)
- B - Terminal block (TB2-2)
- C - Terminal block (TB2-1)
- D - Terminal block (TB1)
- E - Terminal block (TB3)
- F - Terminal block (TB4)

Figure 2.45 Control Circuit Terminal Arrangement

The tightening torque for the terminal screws is displayed on the reverse side of the front cover.

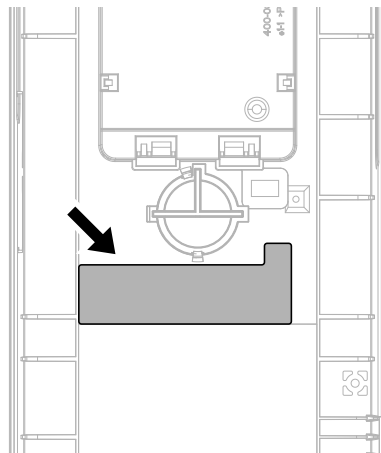

Figure 2.46 Tightening Torque Display

■ Wire Gauges and Tightening Torques

Use the tables in this section to select the appropriate wires. Use shielded wire when wiring the control circuit terminal block. For simpler and more reliable wiring, use crimp ferrules on the wire ends.

The tightening torque for the control circuit terminal is displayed on the reverse side of the front cover.

Table 2.23 Wire Gauges and Tightening Torques

Terminal	Screw Size	Tightening Torque N·m (lb·in)	Bare Wire		Crimp Ferrule	
			Recommended Gauge mm ² (AWG)	Wire Range mm ² (AWG)	Recommended Gauge mm ² (AWG)	Wire Range mm ² (AWG)
S1-S8, SC, SN, SP H1, H2, HC RP, +V, -V, A1, A2, A3, AC MP, FM, AM, AC DM+, DM- D+, D-, AC MA, MB, MC, M1-M4, P1, C1, P2, C2	M3	0.5 to 0.6 (4.4 - 5.3)	0.75 (18)	<ul style="list-style-type: none"> • Stranded wire 0.2 to 1.0 (24 - 16) • Solid wire 0.2 to 1.5 (24 - 16) 	0.5 (20)	0.25 to 0.5 (24 - 20)

Crimp Ferrule

Always attach an insulated sleeve when using crimp ferrules. Refer to the following table for the recommended external dimensions of the crimp ferrule and the model number.

Use the CRIMPFOX 6, a crimping tool manufactured by PHOENIX CONTACT.

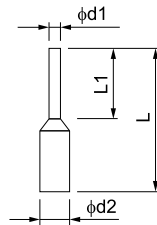

Figure 2.47 External Dimensions of Crimp Ferrule

Table 2.24 Crimp Ferrules Models and Sizes

Wire Gauge mm ² (AWG)	Model	L (mm)	L1 (mm)	d1 (mm)	d2 (mm)
0.25 (24)	AI 0.25-8YE	12.5	8	0.8	2
0.34 (22)	AI 0.34-8TQ	12.5	8	0.8	2
0.5 (20)	AI 0.5-8WH, AI 0.5-8OG	14	8	1.1	2.5

◆ Wiring the Control Circuit Terminal

WARNING! *Electrical Shock Hazard. Do not remove covers or touch circuit boards while the power is on. Failure to comply could cause death or serious injury.*

NOTICE: *Separate control circuit wiring from main circuit wiring (terminals R/L1, S/L2, T/L3, B1, B2, U/T1, V/T2, W/T3, -, +1, +2) and other high-power lines. Improper wiring practices could cause drive malfunction due to electrical interference.*

NOTICE: *Wire contact output terminals MA, MB, MC and M1-M4 with them isolated from other control circuit wiring. If wired improperly, the drive and its equipment will malfunction or the drive may trip.*

NOTICE: *Use a class 2 power supply when connecting to the control terminals. Improper application of peripheral devices could cause drive performance degradation due to improper power supply.*

NOTICE: *Insulate shields with tape or shrink tubing to prevent contact with other signal lines and equipment. Improper wiring practices could cause drive or equipment malfunction due to short circuit.*

NOTICE: *Connect the shield of shielded cable to the appropriate ground terminal. Improper equipment grounding could cause drive or equipment malfunction or nuisance trips.*

Wire the control circuit only after terminals have been properly grounded and main circuit wiring is complete. Remove the keypad and front cover.

1. Press in on the hook of the LED status ring board to release it. Then, pull forward to remove the LED status ring board.

Note:

- Take care so as not to damage the LED status ring board after it has been removed.
- The LED status ring board can be placed using the temporary placement holes. The location of the temporary placement holes varies depending on the model.

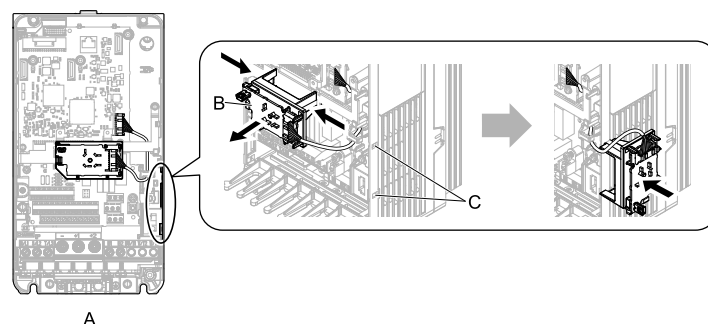

A - Drive front

B - LED status ring board

C - Temporary placement holes

Figure 2.48 Remove the LED Status Ring Board

2. Refer to the following diagram and wire the control circuit.

WARNING! *Fire Hazard. Tighten all terminal screws to the specified tightening torque. Loose or overtightened connections could cause erroneous operation and damage to the terminal block or start a fire and cause death or serious injury.*

NOTICE: *Use shielded twisted-pair cables as indicated to prevent operating faults. Improper wiring practices could cause drive or equipment malfunction due to electrical interference.*

NOTICE: Ensure that the control circuit wiring does not exceed 50 meters when using an analog signal from a remote source to supply the frequency reference. Failure to comply could cause poor system performance.

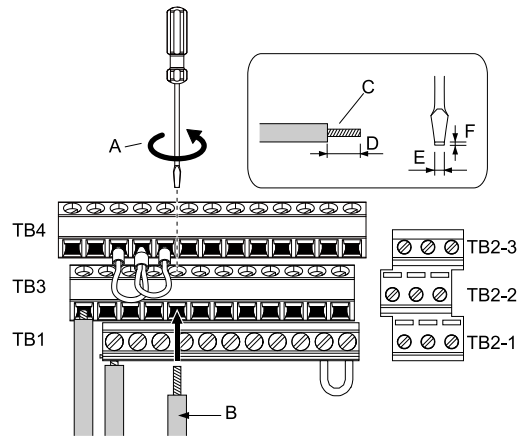

- A -** Loosen the screws and insert the wire into the opening on the terminal block.
- B -** Wire with crimp ferrule attached, or unsoldered wire with the core wires lightly twisted
- C -** Pull back the shielding and lightly twist the end with fingers, keeping the ends from fraying.
- D -** When crimp ferrules are not used, remove approximately 5.5 mm (0.21 in.) of the covering at the tip.
- E -** Blade width of 2.5 mm (0.1 in.) or less
- F -** Blade depth of 0.4 mm (0.01 in.) or less

Figure 2.49 Wiring Procedure for the Control Circuit

Note:

- Do not solder the core wire. When the core wire has been soldered, the connection may become loose over time.
- Tighten the terminal screws to the specified tightening torque.
- For preparing terminal ends of the shielded wire, refer to the following figure.
- When setting the frequency by analog reference from an external frequency setting potentiometer, use shielded twisted-pair wires preparing wire ends as shown in the following figure. Connect the shield to terminal E (G) of the drive.

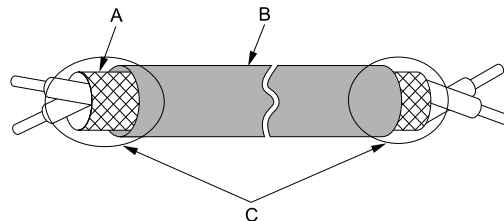

- A -** Connect the cable sheath to terminal E (G) of the drive.
- B -** Sheath
- C -** Insulate with electrical tape or shrink tubing.

Figure 2.50 Preparing the Ends of Shielded Wire

3. Pass the cable through the gap in the wiring cover.

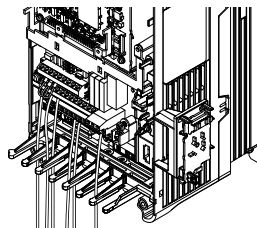

Figure 2.51 Control Circuit Wiring

4. Install the LED status ring board, front cover, and the keypad to their original positions.

◆ **Switches and Jumpers on the Terminal Board**

The terminal board is equipped with several switches used to adapt the drive I/Os to the external control signals as shown in the [Figure 2.52](#).

Set the switches to select the functions for the respective terminals.

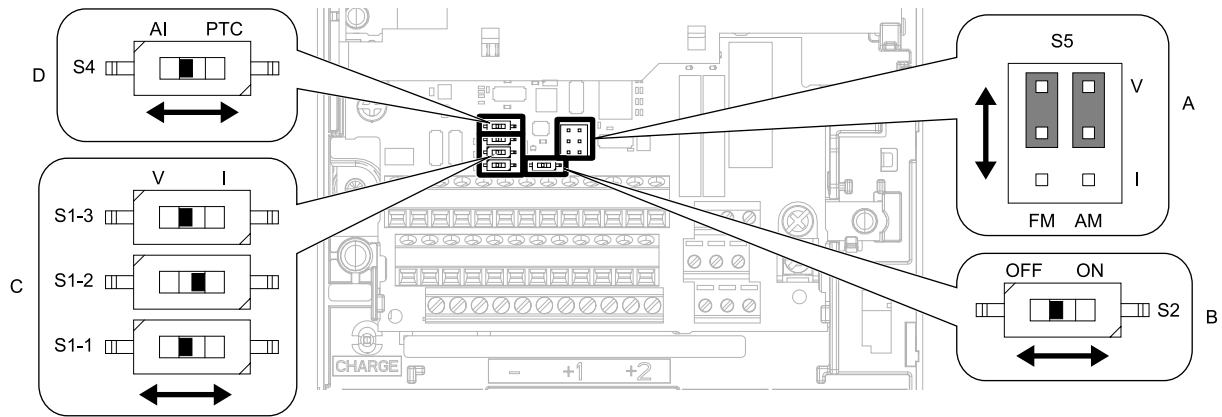

Figure 2.52 Locations of Switches

Table 2.25 I/O Terminals and Switches Functions

Position	Switch	Terminal	Function	Default
A	Jumper S5	FM, AM	Selects terminals FM and AM to either voltage or current output.	FM: V (voltage output) AM: V (voltage output)
B	DIP switch S2	-	Enables or disables the MEMOBUS/Modbus communications termination resistor.	OFF
C	DIP switch S1-1	A1	Selects the input signal type (voltage/current).	V (voltage input)
	DIP switch S1-2	A2	Selects the input signal type (voltage/current).	I (current input)
	DIP switch S1-3	A3	Selects the input signal type (voltage/current).	V (voltage input)
D	Jumper switch S4	A3	Selects MFAI or PTC input.	AI (analog input)

2.15 Control I/O Connections

This section explains the settings for the listed I/O signals for the control circuit.

- Multi-function digital output (terminals M1 to M4)
- Multi-function photocoupler output (terminals P1, C1, P2, C2)
- Pulse train output (terminal MP)
- multi-function analog input (terminals A1 to A3)
- PTC input (terminal A3)
- Multi-function analog monitor output (terminals FM, AM)
- MEMOBUS/Modbus communications (terminal D+, D-, AC)

◆ Pulse Train Output

Pulse train monitor output terminal MP can be used for sourcing mode or for sinking mode.

NOTICE: Connect peripheral devices in accordance with the specifications. Failure to comply may cause unexpected drive operation, and can damage the drive or connected circuits.

- Use for sourcing mode

The voltage level of the pulse train output signal differs depending on the load impedance.

Load impedance $R_L(k\Omega)$	Output Voltage $V_{MP}(V)$
1.5 k Ω or greater	5 V or higher
4.0 k Ω or greater	8 V or higher
10 k Ω or greater	10 V or higher

Note:

Use the following formula to calculate the load resistance (k Ω) needed to raise output voltage (V)_{MP}.

$$R_L = V_{MP} \times 2 / (12 - V_{MP}) \text{ (Unit: k}\Omega\text{)}$$

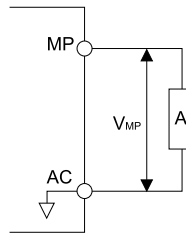

A - Load impedance

Figure 2.53 Wiring for Using Pulse Train Output in Sourcing Mode

- Use in sinking mode

The voltage level of the pulse train output signal differs depending on the voltage supplied by the external power supply. Voltage supplied from an external source should be kept in the 12 Vdc to 15 Vdc $\pm 10\%$ range. Adjust the load impedance so the current is 16 mA or lower.

External power supply (V)	Load impedance (k Ω)	Sinking current (mA)
12 Vdc to 15 Vdc $\pm 10\%$	1.0 k Ω or greater	16 mA max.

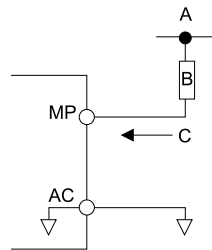

A - External power supply
B - Load impedance

C - Sinking current

Figure 2.54 Wiring for Using Pulse Train Output in Sinking Mode

◆ Setting Sink Mode/Source Mode

Set the sink mode/source mode and the internal/external power supply for the multi-function digital input terminals by short circuiting the control circuit terminals SN, SC, and SP. The default setting for the drive is internal power supply sink mode.

NOTICE: Do not short terminals SP and SN. Failure to comply will damage the drive.

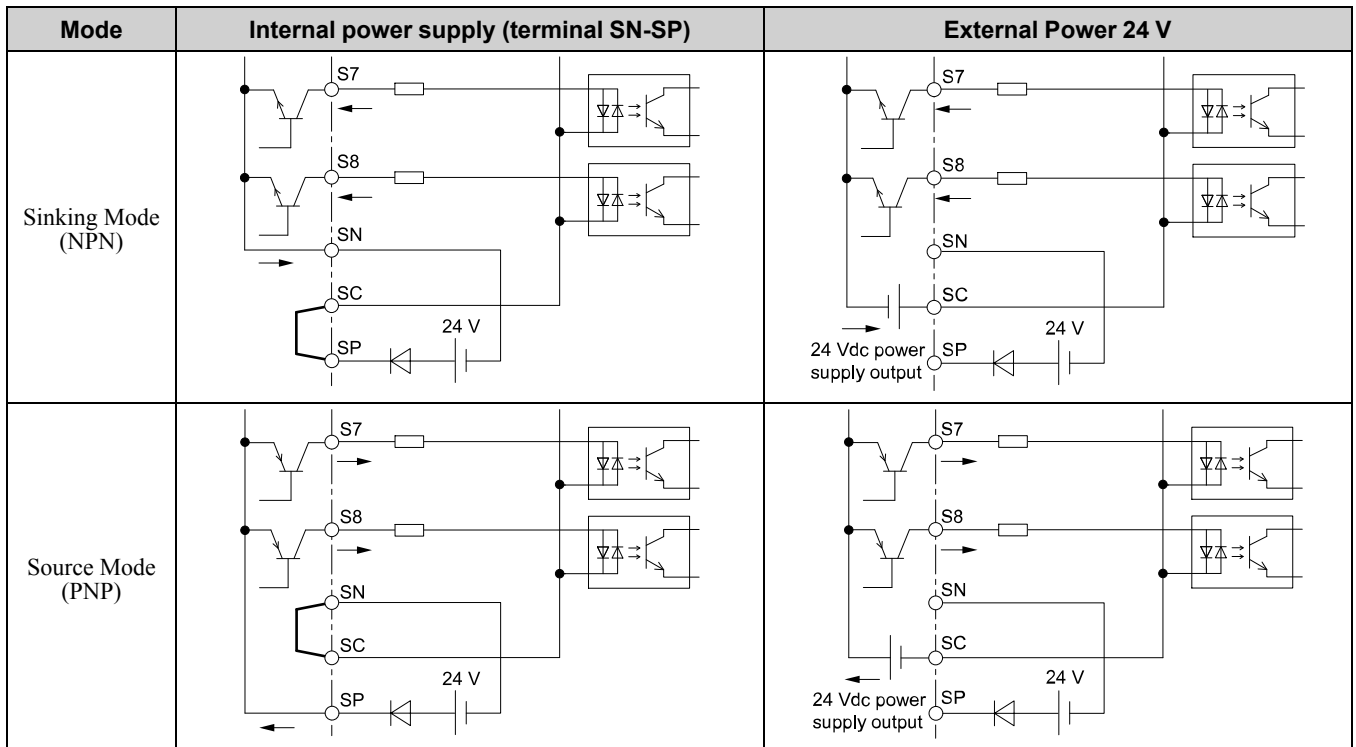

◆ Selection of Input Signals for Terminals A1 to A3 of Multi-Function Analog Input

Terminals A1 to A3 can be used to input either a voltage or a current signal. Set as shown in the following table.

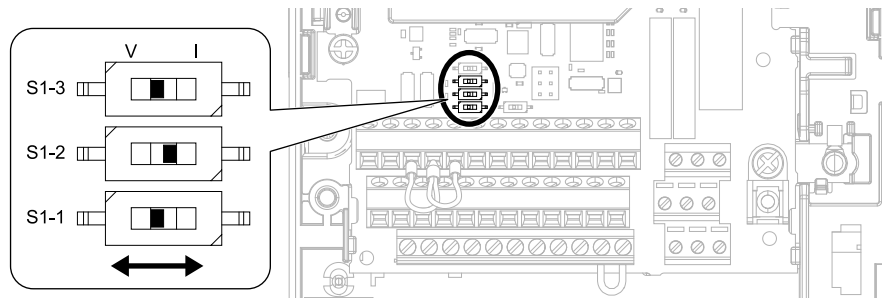

Figure 2.55 Location of DIP Switch S1

Terminal	Input Signal	DIP Switch Settings		Parameters	
		Switch	Setting	No.	Signal Level
A1	Voltage input	S1-1	V (Default setting)	H3-01	0: 0 V to 10 V/100% (input impedance: 20 kΩ) 1: -10 V to 10 V/-100% to 100%
	Current input		I		2: 4 mA to 20 mA/100% 3: 0 mA to 20 mA/100% (input impedance: 250 Ω)
A2	Voltage input	S1-2	V	H3-09	0: 0 V to 10 V/100% (input impedance: 20 kΩ) 1: -10 V to 10 V/-100% to 100%
	Current input		I (Default setting)		2: 4 mA to 20 mA/100% 3: 0 mA to 20 mA/100% (input impedance: 250 Ω)

Terminal	Input Signal	DIP Switch Settings		Parameters	
		Switch	Setting	No.	Signal Level
A3	Voltage input	S1-3	V (Default setting)	H3-05	0: 0 V to 10 V/100% (input impedance: 20 kΩ) 1: -10 V to 10 V/-100% to 100%
	Current input		I		2: 4 mA to 20 mA/100% 3: 0 mA to 20 mA/100% (input impedance: 250 Ω)

Note:

- To set both A1 and A2 to frequency reference, set H3-02, H3-10 = 0 [Terminal A1 Function Selection, Terminal A2 Function Selection = Frequency Bias]. Both analog input values will be combined to create the frequency reference.
- To set DIP switches, use tweezers or a jig that has a tip of approximately 0.8 mm.
- To use terminal A3 as an analog input (voltage/current) terminal, set DIP switch S4 to "AI." The default setting of DIP switch S4 is "AI."

◆ **Select Input Signal for Terminal A3 of Multi-Function Analog Input**

Terminal A3 can be configured either as multi-function analog input, or as PTC input for motor overload protection.

Set using DIP switch S4.

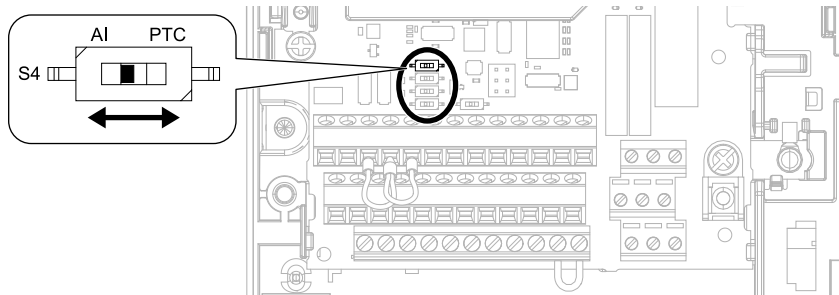

Figure 2.56 Location of DIP Switch S4

Terminal	Settings for DIP Switches	Description
A3	AI (Default setting)	Functions as multi-function analog input terminal. Select function using H3-06.
	PTC	Functions as PTC input terminal. Set H3-06 = E [Motor Temperature (PTC input)]. Set S1-3 to "V" for voltage input.

◆ **Select Output Signals for FM, AM Terminals of Multi-function Analog Monitor Output**

Terminals FM and AM can be used to output either a voltage or a current signal. Set this using jumper switch S5 and H4-07, H4-08.

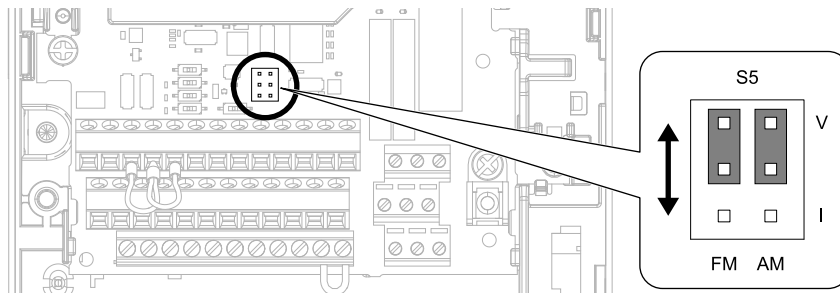
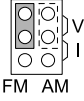
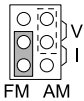
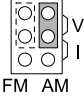
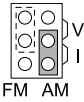

Figure 2.57 Location of Jumper Switch S5

Terminal	Types of Output Signals	Jumper S5	Parameters	
			No.	Signal Level
FM	Voltage output (Default setting)		H4-07 [MFAO Term FM Signal Level Select]	0: 0 V to 10 V 1: -10 V to 10 V
	Current output			2: 4 mA to 20 mA
AM	Voltage output (Default setting)		H4-08 [MFAO Term AM Signal Level Select]	0: 0 V to 10 V 1: -10 V to 10 V
	Current output			2: 4 mA to 20 mA

◆ **Switch ON Termination Resistor for MEMOBUS/Modbus Communications**

Set DIP switch S2 to ON to enable the termination resistor if the drive is the last slave in a MEMOBUS/Modbus communications. This drive is equipped with a built-in termination resistor for the RS-485 interface.

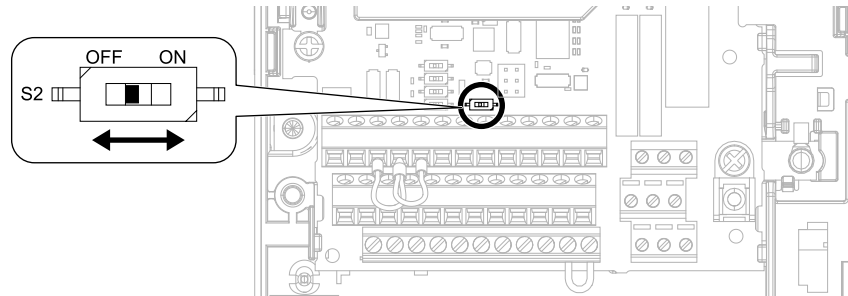

Figure 2.58 Location of DIP Switch S2

Table 2.26 MEMOBUS/Modbus Communications Termination Resistor Setting

DIP switch S2	Description
ON	The drive's built-in termination resistor is switched ON.
OFF (default setting)	The drive's built-in termination resistor is switched OFF.

2.16 External Interlock

In applications where the system will be negatively impacted if the drive goes down, always create an interlock between fault relay output (MA, MB, MC) and the *DriveReady* signal of multi-function digital output.

◆ Drive Ready

When the drive is prepared for acceptance of the Run command, or is already operating, the multi-function digital output terminal to which *Drive Ready* [H2-xx = 6] is set will enter the ON status.

In any of the following instances, *Drive Ready* is set to OFF, and Run commands will be ignored.

- when the power supply is shut off
- during a fault
- when there is problem with the control power supply
- when a parameter setting error makes the drive unable to run even if a Run command has been entered
- when a fault such as overvoltage or undervoltage is triggered as soon as the Run command is entered
- when the drive is in the Programming mode and will not accept a Run command even when entered

◆ Interlock Circuit Example

Two drives running a single application might interlock with the controller using the Drive Ready and Fault output signals as shown below.

Terminal	Output Signal	Parameter settings for Output signal
MA, MB, MC	Fault	-
M1-M2	Drive Ready	H2-01 = 06

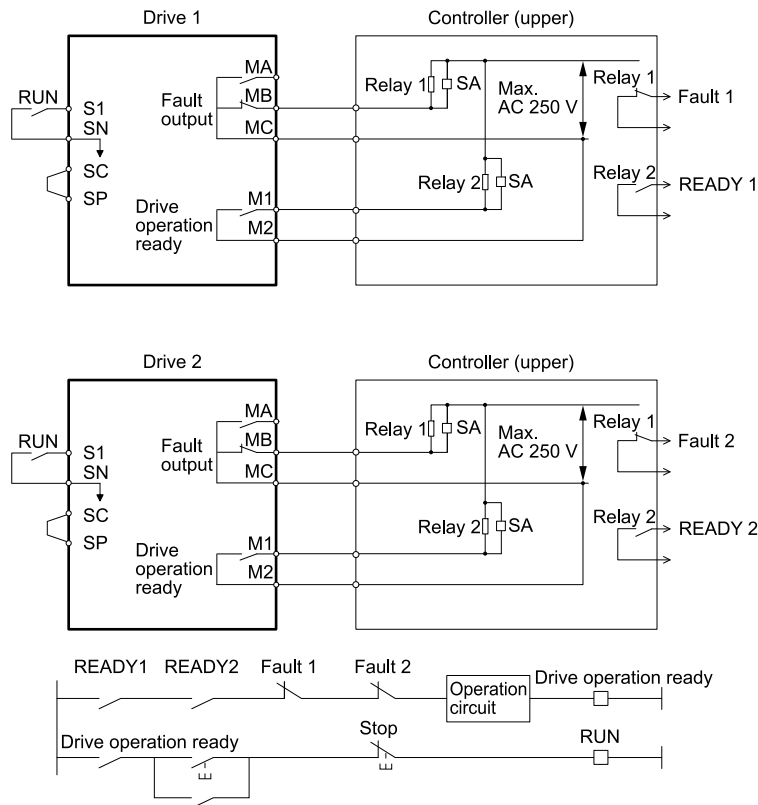

Figure 2.59 Interlock Circuit Example

2.17 Install Braking Resistor

Braking resistor/braking resistor unit (dynamic braking option) helps bring the motor to a smooth and rapid stop when working with high load inertia. When an attempt is made to decelerate a motor within an amount of time that is shorter than it would normally take to coast to stop, the motor will rotate faster than the synchronous speed that corresponds to the frequency that has been set. This will result in the motor becoming an induction generator. As a result, the inertia energy of the motor and the load will be regenerated to the drive. At this time, the DC bus capacitor of the drive is charged, and the voltage rises. Once the overvoltage level is surpassed, an *ov [DC Bus Overvoltage]* will occur. To prevent these overvoltage faults, a dynamic braking option is necessary.

NOTICE: Carefully review instruction manual TOBPC72060001 before connecting a dynamic braking option to the drive. Failure to comply could damage the drive or braking circuit.

Note:

- Properly size the braking circuit to dissipate the power required to decelerate the load in the desired time. Ensure that the braking circuit can dissipate the energy for the set deceleration time prior to running the drive.
- To install a dynamic braking option, set *L8-01 [Internal DB Resistor Protect Sel] = 0*.
- Set *L3-04 = 0 [Decel Stall Prevention Selection = Disabled]* to disable Stall Prevention when using a regenerative converter, regenerative unit, dynamic braking unit, braking resistor, or braking resistor unit. The drive may not stop within the designated deceleration time if Stall Prevention is not disabled.

WARNING! Fire Hazard. The braking resistor connection terminals are B1 and B2. Do not connect braking resistors to any other terminals. Improper wiring connections could cause the braking resistor to overheat and cause death or serious injury by fire. Failure to comply may result in damage to the braking circuit or drive.

NOTICE: Connect braking resistors to the drive as shown in the I/O wiring examples. Improperly wiring braking circuits could result in damage to the drive or equipment.

To connect a Yaskawa ERF series braking resistor to the drive, set *L8-01 = 1 [Internal DB Resistor Protect Sel = Provided]*.

If using a non-ERF type braking resistor, connect a thermal overload relay between the drive and the braking resistor, and set up a circuit that shuts off power to the drive at the trip contacts of the thermal overload relay.

◆ Installing a Braking Resistor: ERF Type

Connect the braking resistor as shown in the following figure for drive models 2004 to 2021 and 4002 to 4012. To install a braking resistor, set *L8-01 = 1 [Internal DB Resistor Protect Sel = Provided]*.

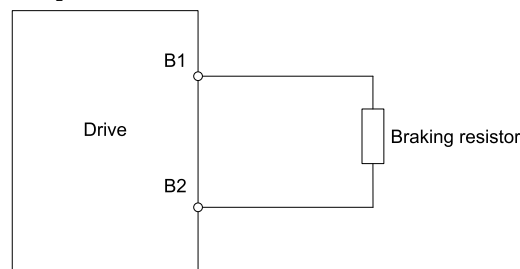

Figure 2.60 Installing a Braking Resistor: ERF Type

◆ Installing a Braking Resistor Unit : LKEB Type

Connect the braking resistor unit as shown in the following figure. To install a braking resistor unit, set *L8-01 = 0 [Internal DB Resistor Protect Sel = Not Provided]*.

Models 2004 to 2138 and 4002 to 4168 have a built-in braking transistor.

To protect the braking resistor unit from overheating, set up a sequence that shuts off the supply of power at the trip contacts of the thermal overload relay.

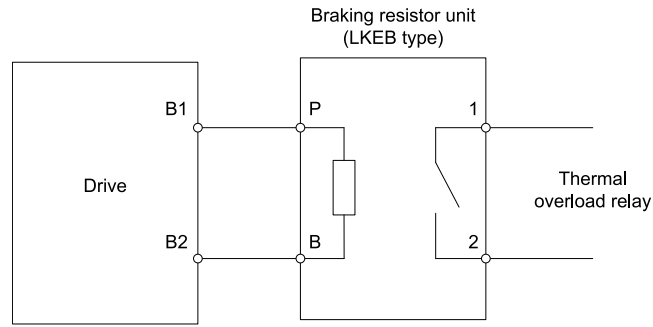

Figure 2.61 Installing a Braking Resistor Unit: LKEB type (Ex. 2004 to 2138, 4002 to 4168)

◆ Installing a Braking Unit Connection: CDBR Type

To install a CDBR type braking unit, connect the terminal +3 of the drive to the terminal + on the braking unit. Next, wire together the terminal - on the drive and braking unit. The terminal +2 is not used.

Set $L8-55 = 0$ [*InternalBrakingTransistorProtect = Disable*].

Note:

To install a CDBR type braking unit to the drive with a built-in braking transistor (models 2004 to 2138, 4002 to 4168), connect the drive terminal B1 to the terminal + on the braking unit. Next, wire the terminal - on the drive and braking unit together. Terminal B2 is not used.

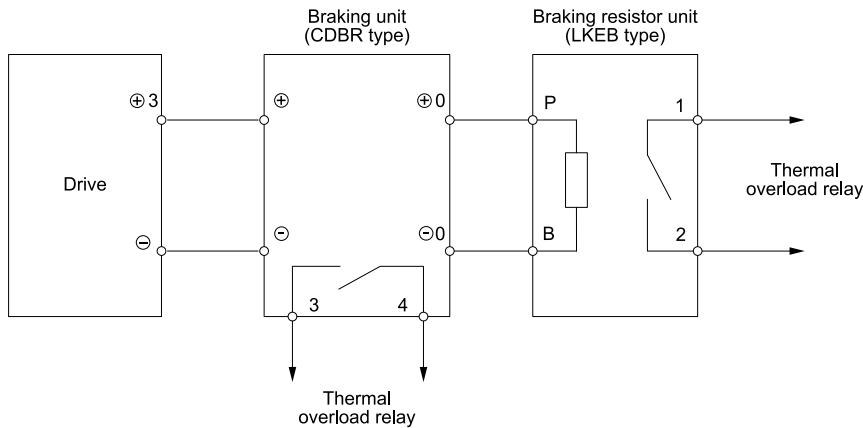

Figure 2.62 Installing a Braking Unit: CDBR Type/Braking Resistor Unit: LKEB Type(Ex. 2169 to 2415, 4211 to 4675)

◆ Connect Braking Units in Parallel

When connecting two or more braking units in parallel, refer to the following figure to determine the wiring and connector selections.

On braking units, there are connectors for selecting master or slave. Select the master side for only the first braking unit. For the second unit on, select the slave side.

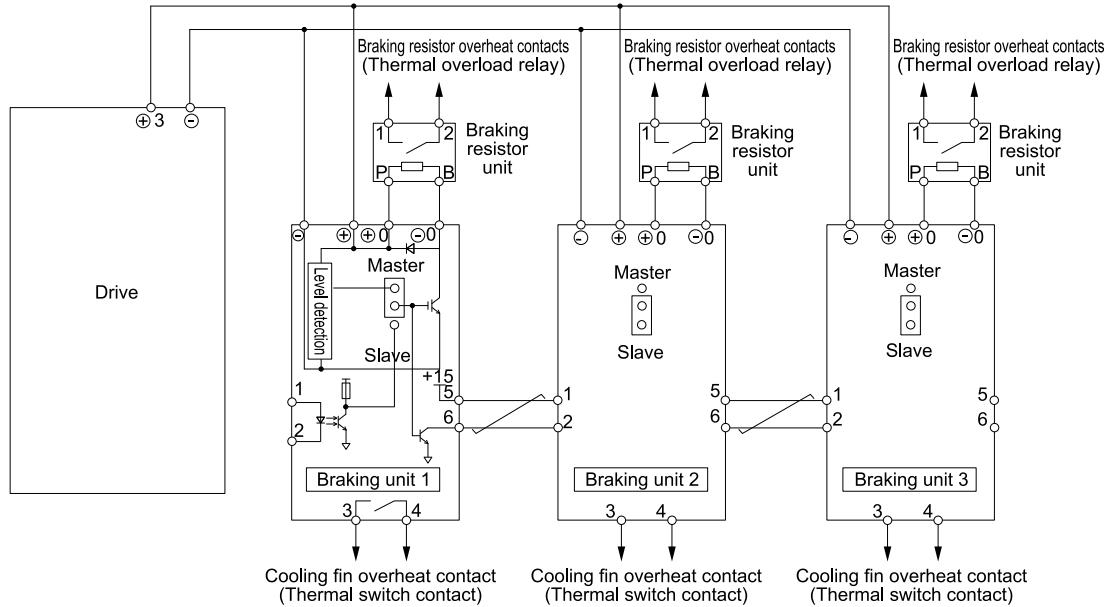

Figure 2.63 Connect Braking Units in Parallel

◆ Dynamic Braking Option Overload Protection

When using a dynamic braking option, Set up the sequence to shut off the power at the thermal relay trip contact on the braking resistor unit as shown in the following figure to protect the braking resistor unit from overheating.

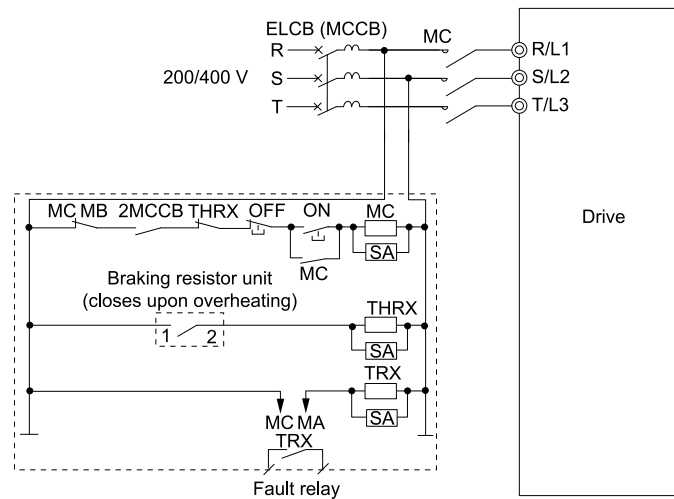

Figure 2.64 Power Supply Interrupt for Overheat Protection (Example)

WARNING! Fire Hazard. When using a braking unit, use a thermal relay on the braking resistors and configure a fault contact output for the braking resistor unit to disconnect drive main power via an input contactor. Inadequate braking circuit protection could result in death or serious injury by fire from overheating resistors.

2.18 Protect Drive Wiring

◆ Installing a Molded-Case Circuit Breaker (MCCB) or Earth Leakage Circuit Breaker (ELCB)

Install a molded-case circuit breaker (MCCB) or an earth leakage circuit breaker (ELCB) for line protection between the power supply and the main circuit power supply input terminals R/L1, S/L2, and T/L3. This protects the main circuit and devices wired to the main circuit while also providing overload protection.

The following describes the selection criteria for an MCCB or ELCB, and the precautions that should be followed when connecting the device.

- The capacity of the MCCB or ELCB should be 1.5 to 2 times the rated output current of the drive. Use an MCCB or ELCB to keep the drive from faulting out instead of using overheat protection (150% for one minute at the rated output current).
- If several drives are connected to one MCCB or ELCB that is shared with other equipment, use a sequence that shuts the power OFF when errors are output by using magnetic contactor (MC) as shown in the following figure.

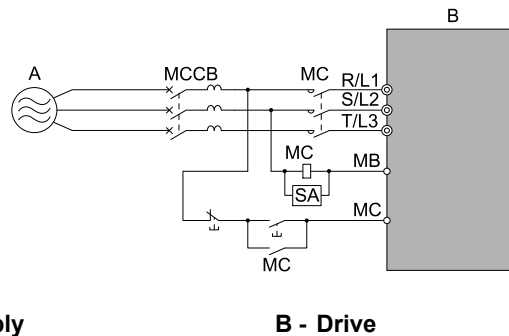

A - Power supply

B - Drive

Figure 2.65 Connecting a Molded-Case Circuit Breaker

WARNING! *Electrical Shock Hazard. Disconnect the MCCB (or ELCB) and MC before wiring terminals. Failure to comply may result in serious injury or death.*

◆ Installing a Ground Fault Circuit Interrupter

High frequency leakage current is generated because the drive's output performs high-speed switching. To prevent electric shock accidents or earth leakage fires induced by ground fault protection, install an earth leakage circuit breaker (ELCB).

The breaker used at the power input side of the drive should be designed specifically for high frequencies, and each drive should have a cumulative sensitivity amperage of at least 30 mA. Through the use of a specialized breaker, high-frequency leakage current is eliminated, and only the leakage current from frequency bands harmful to humans is detected.

A device without a countermeasure against high frequencies can malfunction due to high frequency leakage current. If a malfunction occurs using a device without a countermeasure, lower the carrier frequency of the drive, switch to a more capable breaker, or use an earth leakage circuit breaker having a cumulative sensitivity amperage of at least 200 mA for each drive.

The following factors can have an effect on leakage current:

- Drive capacity
- Carrier Frequency
- Wiring distance and types of motor cables
- EMI/RFI filter

To protect personnel and drives, select earth leakage circuit breakers that can handle both AC and DC power supplies, and which are designed specifically to be able to deal with high frequencies.

Note:

Yaskawa recommends the use of the following earth leakage circuit breakers, which were designed to be used with high frequencies.

- Mitsubishi Electric Corporation; NV series
- Schneider Electric; NS series

2.19 Dynamic Braking Option, Motor Protection

◆ Installing an Electromagnetic Contactor (MC) at Input Side of Drive

When the protective functions of the drive have been triggered, or when an emergency stop has occurred, and according to the sequence, the main circuit power supply is to be shut off, an MC can be used instead of a molded-case circuit breaker (MCCB). However, caution should be observed, since if an MC on the input side of the drive (primary side) is used to forcefully stop the drive, regenerative braking will not operate, and a coast to stop will occur.

NOTICE: Do not connect electromagnetic switches or MCs to the output motor circuits without proper sequencing. Improper sequencing of output motor circuits could result in damage to the drive.

NOTICE: To extend the service life of the relay contacts and electrolytic capacitors inside the drive, the MC on the power source side for turning the drive on (run) and off (stop) should be operated a maximum of one time in 30 minutes. Running and stopping the motor should be done as much as possible via the run and stop operations of the drive. The drive can be run and stopped by turning it on and off via the MC on the power source side, but if this is done frequently, it may cause the drive to fail. Improper operation may shorten the service life of the relay contact and electrolytic capacitor.

NOTICE: Use a magnetic contactor (MC) to ensure that power to the drive can be completely shut off when necessary. The MC should be wired so that it opens when a fault output terminal is triggered.

Note:

- When it is necessary to prevent machinery from restarting after recovery from a momentary power loss that occurred during run, an MC can be installed at the input side of the drive, and a sequence that does not automatically set the start signal to ON after recovery of power should be set up.
- When countermeasures for momentary power loss are required, such as when maintaining a circuit experiencing momentary power loss, use a delayed release MC.

■ Protection of Braking Resistor/Braking Resistor Unit

Use an MC on the input side (primary side) to protect the braking resistor/braking resistor unit.

WARNING! Fire Hazard. When using a braking unit, use a thermal relay on the braking resistors and configure a fault contact output for the braking resistor unit to disconnect drive main power via an input contactor. Inadequate braking circuit protection could result in death or serious injury by fire from overheating resistors.

◆ Installing a Thermal Overload Relay on the Drive Output

A thermal overload relays protect the motor by disconnecting power lines to the motor due to a motor overload condition.

Install a thermal overload relay between the drive and motor in the following situations:

- When operating multiple motors on a single drive.
- When using a power line bypass to operate the motor directly from the power line.

It is not necessary to install a thermal overload relay when operating a single motor from a single drive. The drive has electronic motor overload protection built into the drive software.

Note:

- When installing a thermal overload relay, set parameter $L1-01 = 0$ [Motor Overload Protection Select = Disabled].
- Set up a sequence for tripping an external fault (coast to stop) for the contacts of the thermal overload relay.

■ General Precautions When Using Thermal Overload Relays

Consider the following application precautions when using motor thermal overload relays on the output of drives to prevent nuisance trips or overheat of the motor at low speeds:

- Low speed motor operation
- When operating multiple motors on a single drive.
- Motor cable length
- Nuisance tripping due to a high drive carrier frequency

Low Speed Operation and Thermal Overload Relays

Generally, thermal overload relays are applied on general-purpose motors (standard motors). When general-purpose motors are driven by drives, the motor current is approximately 5% to 10% greater than if driven by a commercial power supply. In addition, the cooling capacity of a motor with a shaft-driven fan decreases when operating at low speeds. Motor overheating may occur even when the load current is within the motor rated value. For this reason, the electronic thermal protector inside the drive should be set so it is enabled whenever possible.

Electronic thermal overload protection function: motor is protected by simulating the cooling ability of general-purpose motors and forced-vented motors based on the relationship between speed and heat characteristics within the variable speed control range.

When Operating Multiple Motors on a Single Drive

To disable the overload protection function of the electronic thermal protector of the drive, set $LI-01 = 0$ [*Motor Overload Protection Select = Disabled*].

Note:

When operating multiple motors with a single drive, the electronic thermal protector of the drive cannot be applied.

Long Motor Cables

When a high carrier frequency and long motor cables are used, nuisance tripping of the thermal relay may occur due to increased leakage current. To avoid this, reduce the carrier frequency or increase the tripping level of the thermal overload relay.

Nuisance Tripping Due to a High Drive Carrier Frequency

Current waveforms generated by high carrier frequency PWM drives tend to increase the temperature in overload relays. It may be necessary to increase the trip level setting when encountering nuisance triggering of the relay.

WARNING! Fire Hazard. Make sure that there isn't another cause triggering overload before raising the detection level of the thermal relay. Adjust electrothermal settings only after verifying local ordinances for electrical wiring. Improper wiring may cause a fire.

2.20 Improving the Power Factor

◆ Connecting an AC Reactor or DC Reactor

Use an AC reactor or a DC reactor to suppress sudden current surges or harmonic current. By suppressing harmonic current, an improvement in the power factor at the drive's input side is also implemented.

Connect an AC reactor or a DC reactor the input side (primary side) in the following situations: An AC reactor and DC reactor can be used in combination.

- To suppress harmonic current or improve the power factor of the power supply.
- When there is switching of phase advancing capacitor.
- With a large capacity power supply transformer (over 600 kVA).

Note:

The main circuit terminal block for the drive, and the terminal blocks for the AC and DC reactors come in different shapes. The drive comes with a European style terminal block, and the AC and DC reactors come with a round terminal block. Take due care when preparing the ends of the wires.

■ Connecting a AC Reactor

Note:

When connecting an AC reactor to the output side (secondary side) of the driver, set $C6-02 = 1$ [Carrier Frequency Selection = 2.0 kHz].

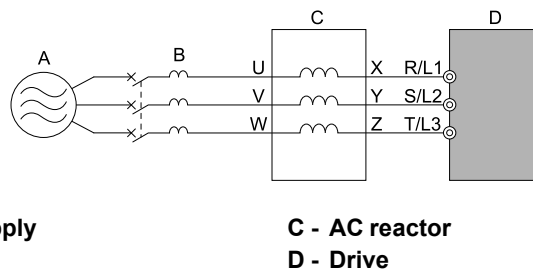

Figure 2.66 AC Reactor Connection Example

■ Connecting a DC Reactor

When installing a DC reactor, remove the jumper between terminals +1 and +2. Do not remove the jumper between terminals +1 and +2 if a DC reactor will not be connected. Refer to the following figure to wire the DC reactor.

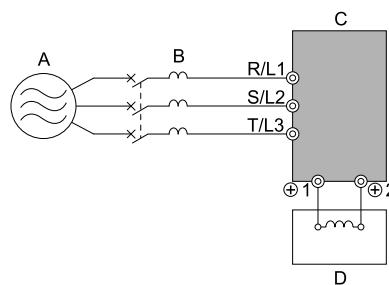

Figure 2.67 DC Reactor Connection Example

2.21 Preventing the Passage of Switching Surge

◆ Connecting a Surge Protective Device

A surge protective device suppresses surge voltage generated from switching an inductive load near the drive. Inductive loads include magnetic contactors, electromagnetic relays, magnetic valves, solenoids, and magnetic brakes. With inductive loads, always use a surge protective device or diode.

Note:

Always use a surge protective device or diode when operating with an inductive load.

2.22 Reducing Noise

Note:

The main circuit terminal block for the drive, and terminal block for the noise filter come in different shapes. The drive comes with a European style terminal block and the noise filter comes with a round terminal block. Take due care when preparing the ends of the wires.

◆ Connecting a Noise Filter to Input Side (Primary Side)

Drive outputs generate noise as a result of high-speed switching. This noise flows from inside the drive back to the power supply, possibly affecting other equipment. Installing a noise filter to the input side of the drive can reduce the amount of noise flowing back into the power supply. This also prevents noise from entering the drive from the power supply.

- Use a noise filter specifically designed for drives.
- Install the noise filter as close as possible to the drive.

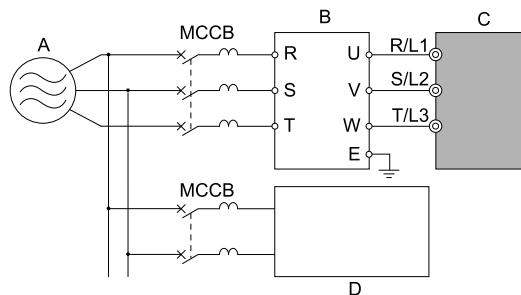

A - Power supply
B - Input side (primary side) noise filter
C - Drive
D - Other controller

Note:

The model of the input side (primary side) noise filter is LNFD-xx.

Figure 2.68 Example of Connection of Noise Filter on Input Side (Primary Side)

◆ Connecting a Noise Filter to (Secondary Side)

A noise filter on the output side of the drive reduces inductive noise and radio frequency interference. The following figure illustrates an example of output-side noise filter wiring.

NOTICE: Do not connect phase-advancing capacitors or LC/RC noise filters to the output circuits. Failure to comply could damage the drive, phase-advancing capacitors, LC/RC noise filters or RCM/RCD.

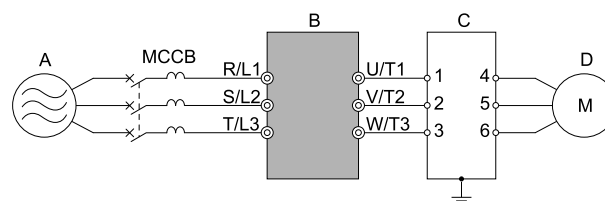

A - Power supply
B - Drive
C - Noise filter on output side (secondary side)
D - Motor

Figure 2.69 Example of Connection of Noise Filter on Output Side (Secondary Side)

Note:

Glossary

Radio frequency interference: Electromagnetic waves radiated from the drive and cables create noise throughout the radio bandwidth that can affect surrounding devices.

Inductive noise: Noise generated by electromagnetic induction can affect the signal line and may cause the controller to malfunction.

■ Preventing Inductive Noise

In addition to installation of a noise filter, explained above, another way to suppress inductive noise occurring at the output side is to run all wiring through a grounded metal conduit. Lay the cables at least 30 cm away from the signal line to prevent induced noise. Ground to metal conduits.

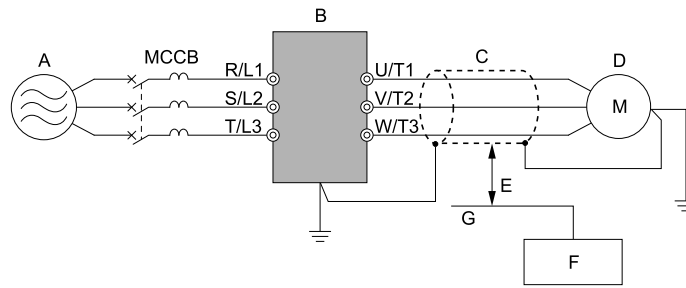

- | | |
|---------------------------------|------------------------------------|
| A - Power supply | E - Separate at least 30 cm |
| B - Drive | F - Controller |
| C - Shielded motor cable | G - Signal line |
| D - Motor | |

Figure 2.70 Preventing Inductive Noise

■ Reducing Radio Frequency Interference

The drive, input lines, and output lines generate radio frequency interference. Use noise filters on input and output sides and install the drive in a steel box to reduce radio frequency interference.

Note:

The cable running between the drive and motor should be as short as possible.

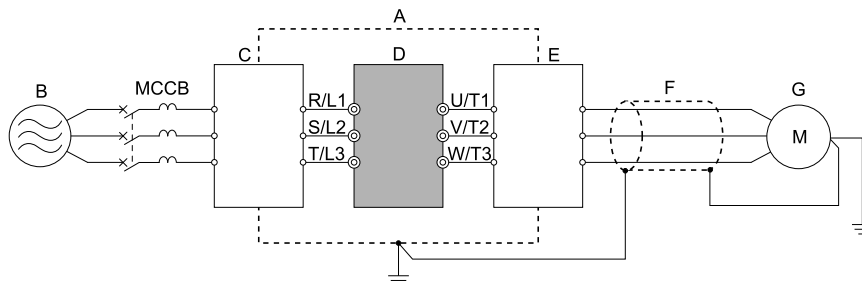

- | | |
|-------------------------|---------------------------------|
| A - Steel box | E - Noise filter |
| B - Power supply | F - Shielded motor cable |
| C - Noise filter | G - Motor |
| D - Drive | |

Figure 2.71 Reducing Radio Frequency Interference

2.23 Protect Drive at Failure

◆ Factory Recommended Branch Circuit Protection

To maintain compliance with UL61800-5-1, execute branch circuit protection when a short occurs in the internal circuit. Yaskawa recommends connecting a semiconductor protective type fuses to the input side for branch circuit protection. Refer to [Table 2.27](#) to [Table 2.30](#) for the recommended fuses.

NOTICE: Do not energize the power or operate equipment soon after a fuse blows or the circuit breaker (ELCB) trips. Check the condition of cable wiring and peripheral devices to identify the root cause. If the root cause cannot be determined, do not turn on the power or operate equipment. Contact Yaskawa Support immediately.

- 200 V class
The drive is suitable for use on a circuit capable of delivering not more than 100,000 RMS symmetrical amperes and 240 Vac during short circuit of the power supply, when protected by fuses as specified in this document.
- 400 V class
The drive is suitable for use on a circuit capable of delivering not more than 100,000 RMS symmetrical amperes and 480 Vac during short circuit of the power supply, when protected by fuses as specified in this document.

Drive's built-in short circuit protection does not provide branch circuit protection. Branch circuit protection must be provided in accordance with the NEC (National Electric Code) the CEC (Canadian Electric Code, Part I), and any additional local codes.

■ Three-Phase 200 V Class

Table 2.27 Factory Recommended Drive Branch Circuit Protection (Normal Duty)

Drive Model	Maximum Applicable Motor Output kW (HP)	Input Current Rating A	Semiconductor Fuse Model Manufacturer: EATON/ Bussmann
2004	0.75 (0.75)	4.8	FWH-45B
2006	1.1 (1.5)	6.7	FWH-45B
2008	1.1 (1.5)	6.7	FWH-45B
2010	2.2 (3)	12.7	FWH-45B
2012	3 (4)	17	FWH-100B
2018	3.7 (5)	20.7	FWH-100B
2021	5.5 (7.5)	30	FWH-100B
2030	7.5 (10)	40.3	FWH-125B
2042	11 (15)	52	FWH-150B
2056	15 (20)	78.4	FWH-200B
2070 *1	18.5 (25)	96	FWH-225A
2082 *1	22 (30)	114	FWH-225A FWH-250A *2
2110 *1	30 (40)	111	FWH-225A FWH-250A *2
2138 *1	37 (50)	136	FWH-275A FWH-300A *2
2169 *1	45 (60)	164	FWH-275A FWH-350A *2
2211 *1	55 (75)	200	FWH-325A FWH-450A *2
2257 *1	75 (100)	271	FWH-600A
2313 *1	90 (125)	324	FWH-800A
2360 *1	110 (150)	394	FWH-1000A
2415 *1	-	-	FWH-1400A

*1 Approval pending. Contact Yaskawa or your nearest sales representative.

*2 Fuses with larger rated currents are recommended for application with repetitive operations.

Table 2.28 Factory Recommended Drive Branch Circuit Protection (Heavy Duty)

Drive Model	Maximum Applicable Motor Output kW (HP)	Input Current Rating A	Semiconductor Fuse Model Manufacturer: EATON/ Bussmann
2004	0.55 (0.5)	3.6	FWH-45B
2006	0.75 (1)	4.8	FWH-45B
2008	0.75 (1)	4.8	FWH-45B
2010	1.5 (2)	8.9	FWH-45B
2012	2.2 (3)	12.7	FWH-50B
2018	3 (4)	17	FWH-80B
2021	3.7 (5)	20.7	FWH-80B
2030	5.5 (7.5)	30	FWH-125B
2042	7.5 (10)	40.3	FWH-150B
2056	11 (15)	58.2	FWH-200B
2070 ^{*1}	15 (20)	78.4	FWH-225A
2082 ^{*1}	18.5 (25)	96	FWH-225A FWH-250A ^{*2}
2110 ^{*1}	22 (30)	82	FWH-225A FWH-250A ^{*2}
2138 ^{*1}	30 (40)	111	FWH-275A FWH-300A ^{*2}
2169 ^{*1}	37 (50)	136	FWH-275A FWH-350A ^{*2}
2211 ^{*1}	45 (60)	164	FWH-325A FWH-450A ^{*2}
2257 ^{*1}	55 (75)	200	FWH-600A
2313 ^{*1}	75 (100)	271	FWH-800A
2360 ^{*1}	90 (125)	324	FWH-1000A
2415 ^{*1}	110 (150)	394	FWH-1400A

*1 Approval pending. Contact Yaskawa or your nearest sales representative.

*2 Fuses with larger rated currents are recommended for application with repetitive operations.

■ Three-Phase 400 V Class

Table 2.29 Factory Recommended Drive Branch Circuit Protection (Normal Duty)

Drive Model	Maximum Applicable Motor Output kW (HP)	Input Current Rating A	Semiconductor Fuse Model Manufacturer: EATON/ Bussmann
4002	0.75 (1)	2.5	FWH-50B
4004	1.5 (2)	4.7	FWH-50B
4005	2.2 (3)	6.7	FWH-50B
4007	3.0 (4)	8.9	FWH-60B
4009	3.7 (5)	11.7	FWH-60B
4012	5.5 (7.5)	15.8	FWH-60B
4018	7.5 (10)	21.2	FWH-80B
4023	11 (15)	30.6	FWH-90B
4031	15 (20)	41.3	FWH-150B
4038	18.5 (25)	50.5	FWH-200B
4044 ^{*1}	22 (30)	59.7	FWH-200B

Drive Model	Maximum Applicable Motor Output kW (HP)	Input Current Rating A	Semiconductor Fuse Model Manufacturer: EATON/ Bussmann
4060 *1	30 (40)	58.3	FWH-225A
4075 *1	37 (50)	71.5	FWH-250A
4089 *1	45 (60)	86.5	FWH-275A
4103 *1	55 (75)	105	FWH-275A
4140 *1	75 (100)	142	FWH-300A
4168 *1	90 (125)	170	FWH-325A FWH-400A *2
4208 *1	110 (150)	207	FWH-500A
4250 *1	150 (200)	248	FWH-600A
4296 *1	185 (250)	300	FWH-700A
4371 *1	220 (300)	373	FWH-800A
4389 *1	260 (350)	410	FWH-1000A
4453 *1	300 (400)	465	FWH-1200A
4568 *1	335 (450)	584	FWH-1200A
4675 *1	450 (600)	657	FWH-1400A FWH-1600A *2

*1 Approval pending. Contact Yaskawa or your nearest sales representative.

*2 Fuses with larger rated currents are recommended for application with repetitive operations.

Table 2.30 Factory Recommended Drive Branch Circuit Protection (Heavy Duty)

Drive Model	Maximum Applicable Motor Output kW (HP)	Input Current Rating A	Semiconductor Fuse Model Manufacturer: EATON/ Bussmann
4002	0.55 (0.75)	1.9	FWH-50B
4004	0.75 (1)	3.5	FWH-50B
4005	1.5 (2)	4.7	FWH-50B
4007	2.2 (3)	6.7	FWH-60B
4009	3 (4)	8.9	FWH-60B
4012	3.7 (5)	11.7	FWH-60B
4018	5.5 (7.5)	15.8	FWH-80B
4023	7.5 (10)	21.2	FWH-90B
4031	11 (15)	30.6	FWH-150B
4038	15 (20)	41.3	FWH-200B
4044 *1	18.5 (25)	50.5	FWH-200B
4060 *1	22 (30)	43.1	FWH-225A
4075 *1	30 (40)	58.3	FWH-250A
4089 *1	37 (50)	71.5	FWH-275A
4103 *1	45 (60)	86.5	FWH-275A
4140 *1	55 (75)	105	FWH-300A
4168 *1	75 (100)	142	FWH-325A FWH-400A *2
4208 *1	90 (125)	170	FWH-500A
4250 *1	110 (150)	207	FWH-600A
4296 *1	150 (200)	248	FWH-700A
4371 *1	185 (250)	300	FWH-800A

2.23 Protect Drive at Failure

Drive Model	Maximum Applicable Motor Output kW (HP)	Input Current Rating A	Semiconductor Fuse Model Manufacturer: EATON/ Bussmann
4389 ^{*1}	220 (300)	373	FWH-1000A
4453 ^{*1}	260 (350)	410	FWH-1200A
4568 ^{*1}	300 (400)	465	FWH-1200A
4675 ^{*1}	370 (500)	584	FWH-1400A FWH-1600A ^{*2}

*1 Approval pending. Contact Yaskawa or your nearest sales representative.

*2 Fuses with larger rated currents are recommended for application with repetitive operations.

2.24 Wiring Checklist

After wiring of the drive is complete, go through the following checklist before test run.

Table 2.31 Drive, Peripheral Devices, Option Cards

Checked	No.	Item to Check
	1	Check drive model number to ensure receipt of correct model.
	2	Make sure you have the correct braking resistors, DC reactors, noise filters, and other peripheral devices.
	3	Check the option card model number.

Table 2.32 Installation Area and Physical Setup

Checked	No.	Item to Check
	1	Ensure that the area surrounding the drive complies with specifications.

Table 2.33 Power Supply Voltage/Output Voltage

Checked	No.	Item to Check
	1	The voltage from the power supply should be within the input voltage specification range of the drive.
	2	The voltage rating for the motor should match the drive output specifications.
	3	Verify that the drive is properly sized to run the motor.

Table 2.34 Main Circuit Wiring

Checked	No.	Item to Check
	1	The power supply should be passed through a molded-case circuit breaker (MCCB) before being input. An appropriate molded-case circuit breaker (MCCB) should be connected.
	2	Properly wire the power supply to drive terminals R/L1, S/L2, and T/L3.
	3	Properly wire the drive and motor together. The motor lines and drive output terminals U/T1, V/T2, and W/T3 should match in order to produce the desired phase order. If the phase order is incorrect, the drive will rotate in the opposite direction.
	4	Use 600 V heat resistant indoor PVC wire for the power supply and motor lines. Note: Wire gauge recommendations assume use of 600 V class 2 heat resistant indoor PVC wire.
	5	Use the correct wire gauges for the main circuit. <ul style="list-style-type: none"> When the wiring distance between the drive and the motor is long, confirm that the voltage drop in the wire meets the value calculated as follows: Motor rated voltage (V) \times 0.02 \geq $\sqrt{3} \times$ wire resistance (Ω/km) \times wiring distance (m) \times motor rated current (A) \times 10⁻³ If the cable between the drive and motor exceeds 50 m, lower the carrier frequency using C6-02 [Carrier Frequency Selection].
	6	Properly ground the drive.
	7	Tighten main circuit and grounding terminal screws of the drive to their specified torques.
	8	Set up overload protection circuits when running multiple motors from a single drive. <div style="text-align: center;"> <p>The diagram shows a power supply (A) connected to a drive (B) at terminals S3 and SC. The drive (B) output terminals are connected to two motors (M1 and M2) through electromagnetic contactors (C) and thermal overload relays (oL1, oL2). The contactors and relays are labeled C, oL1, oL2, M1, and M2.</p> </div>

A - Power supply
B - Drive

C - MC1 - MCn:
electromagnetic
contactor
D - oL1 - oLn:
thermal
overload relay

2.24 Wiring Checklist

Checked	No.	Item to Check
	9	Install an electromagnetic contactor (MC) when using a braking resistor or a braking resistor unit. Properly install the resistor and ensure that overload protection shuts off the power supply using the electromagnetic contactor.
	10	Verify phase advancing capacitors, input noise filters, or earth leakage circuit breakers are NOT installed on the output side of the drive.

Table 2.35 Control Circuit Wiring

Checked	No.	Item to Check
	1	Use twisted-pair cable for all drive control circuit wiring.
	2	Ground the shields of shielded wiring to the terminal E (G).
	3	For 3-Wire sequence, set parameters for multi-function digital input terminals, and wire control circuits.
	4	Properly wire any option cards.
	5	Check for any other wiring mistakes. Only use a multimeter to check wiring.
	6	Tighten the control circuit terminal screws of the drive to their specified torques.
	7	Pick up all wire clippings.
	8	Ensure that no frayed wires on the terminal block are touching other terminals or connections.
	9	Properly separate control circuit wiring and main circuit wiring.
	10	Control circuit wiring should not exceed 50 m.
	11	Safe Disable input wiring should not exceed 30 m.

2.25 Motor Application Precautions

◆ Use with Existing Standard Motors

■ Low Speed Range

When a drive is used to operate a standard motor, power loss will increase compared to cases when the motor is operated using a commercial power supply. In the low speed range, the self-cooling capability of such a motor decreases with the speed, so the temperature of the motor will tend to rise quickly. Therefore, reduce the load torque of the motor in the low speed range. The following figure shows the allowable load characteristics for a Yaskawa standard motor. Use a motor designed specifically for operation with a drive when 100% continuous torque is needed at low speeds.

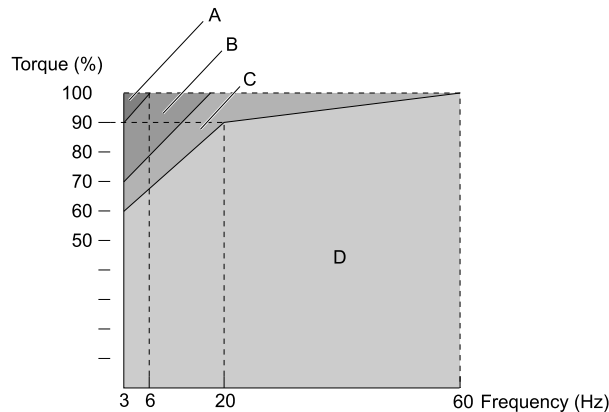

A - 25% ED (or 15 min.)

B - 40% ED (or 20 min.)

C - 60% ED (or 40 min.)

D - Continuous operation

Figure 2.72 Allowable Load Characteristics for a Yaskawa Standard Motors

■ Insulation Withstand Voltage

Consider motor voltage tolerance levels and motor insulation in applications with an input voltage of over 440 V or particularly long wiring distances. Use an insulated drive motor.

NOTICE: Use a motor that provides insulation suitable for PWM drives. Failure to comply may cause a short circuit or ground fault due to insulation deterioration.

■ High-Speed Operation

Problems may occur with the motor bearing durability and dynamic balance of the machine when operating a motor beyond its rated speed. Contact the motor or machine manufacturer.

■ Torque Characteristics

Torque characteristics differ compared to operating the motor directly from line power. The user should have a full understanding of the load torque characteristics for the application.

■ Vibration

Vibrations could occur in the following situations.

- Resonance with the natural frequency of machinery
Take particular caution when adding a variable speed drive to an application running a motor from line power at a constant speed. If resonance occurs, install shock-absorbing rubber around the base of the motor and enable the Jump frequency control.
- Unbalance of the revolving member itself
Take particular caution when the speed of the motor is increased above the rated motor speed.
- Subsynchronous resonance
Subsynchronous resonance can occur with long motor shafts and in applications such as turbines, blowers, and fans with high inertia loads.
Use Closed Loop Vector Control when these applications experience subsynchronous resonance problems.

■ Audible Noise

The audible noise of the motor varies based on the carrier frequency setting. When using a high carrier frequency, audible noise from the motor is comparable to the motor noise generated when running from line power. However, unpleasant motor noise is likely to increase when operating at speeds above the rated rotation speed.

◆ Use with PM Motors

- Contact Yaskawa or your nearest sales representative if intending to use a PM motor not manufactured by Yaskawa.
- Motor cannot be operated using a commercial power supply. If it is necessary to achieve operation using commercial power supply, use an induction motor.
- A multiple number of PM motors cannot be driven using one drive. When such operation is necessary, employ an induction motor with a variable speed control drive.
- When starting with Open Loop Vector Control for PM motor, the motor may operate in the reverse direction for up to half turn (electrical angle).
- The amount of generated starting torque differs depending on the control mode and motor type. Set up the motor with the drive after verifying the starting torque, allowable load characteristics, impact load tolerance, and speed control range. Contact Yaskawa or your nearest sales representative when planning to use a motor that does not fall within these specifications.
- In Open Loop Vector Control for PM motors, braking torque is less than 125% when running between 20% and 100% speed, even with a braking resistor unit. Braking torque drops to less than 50% when running at less than 20% speed.
- In Open Loop Vector Control for PM motors, the allowable load inertia moment is approximately 50 times higher than the motor inertia moment. Use the Closed Loop Vector Control for PM for applications with a larger inertia moment.
- When using a holding brake in Open Loop Vector Control for PM motors, release the brake prior to starting the motor. Failure to set the proper timing can cause speed loss. Note that such configurations must never be used for applications where heavy loads are handled, such as for conveyors or elevators in particular.
- To restart a coasting motor rotating over 200 Hz while in V/f Control, first use the Short Circuit Braking function to bring the motor to a stop. Short Circuit Braking requires a special braking resistor unit. Contact Yaskawa or your nearest sales representative for details.
To restart a coasting motor rotating below 200 Hz, use the Speed Search function.
If the motor cable is relatively long, stop the motor using Short Circuit Braking.

Note:

The Short Circuit Braking function uses the drive to forcefully produce a short across the wires of the motor, causing it to stop before it has time to coast to a stop.

- EZ open loop vector control can also be used to operate synchronous reluctance motors (SynRM). Contact Yaskawa or your nearest sales representative for details.
 - When replacing the encoder of a PM motor due to encoder failure, put the motor in the state where it can rotate and execute Z Pulse Offset Tuning or PM Rotational Auto-Tuning.
 - If *oC* [Overcurrent], *STPo* [Pull-Out Detection], or *LSo* [LSo Fault] occur during restart, retry Speed Search and use the Short Circuit Braking function when starting to adjust the motor.
-

◆ Precautions Concerning Use of Specialized Motors

■ Pole Change Motor

The rated current of pole change motors differs from that of standard motors. Check the maximum current of the motor before selecting a drive. Always stop the motor before switching between the number of motor poles. If the number of poles is changed while the motor is turning, the motor will coast to stop due to overvoltage from regeneration or the overcurrent protection circuitry.

■ Submersible Motors

The rated current of a submersible motor is greater than that of a standard motor, so select the drive accordingly. Use a motor cable large enough to avoid decreasing the maximum torque level from voltage drop caused by a long motor cable.

■ Explosion-Proof Motors

The motor and the drive must be tested together to be certified as explosion-proof. The same is true even for existing installations of explosion-proof motors. The drive is not designed for explosion-proof areas. Ensure that the drive is installed in a safe location.

The encoder used with pressure-resistant explosion-proof motors is intrinsically safe. When wiring between the drive and encoder, always connect through a specialized pulse coupler.

■ Geared Motors

The continuous speed range differs depending on the lubricating method and the manufacturer. In particular, in the case of oil lubrication, continuous operation in the low speed range may cause burnout. Consult with the manufacturer for the applications that require frequencies in excess of the rated frequency.

■ Single-Phase Motors

Variable speed drives are not designed to operate with single phase motors. Using capacitors to start the motor causes a high frequency current to flow to the capacitors and can damage the capacitors. A split-phase start or a repulsion start can burn out the starter coils because the internal centrifugal switch is not activated. The drive is for use with three-phase motors only.

■ Motor with Brake

When using a drive to operate a motor with brake, and the brake is connected to the output side of the drive, it may not release at start due to low voltage levels. Use a motor with brake that has an independent source of power for the brake. Connect the brake power supply to the power supply side of the drive. Note that motors with built-in brakes tend to generate a fair amount of noise when running at low speeds.

◆ Notes on Power Transmission Mechanism

Take care if continuously operating power transmission machinery at low speed, if such machinery incorporates gearboxes, transmissions, or reduction gears that use oil for lubrication. At low speeds, oil lubrication systems can lose their effectiveness. Note also that operation at a frequency exceeding the rated frequency can result in a variety of problems with the power transmission mechanism, including audible noise and reduced service life and durability due to centrifugal force. Due caution should be observed.

Initial SetUp TrialRUN

The basic steps to start up the drive and perform a test run, and the procedures for Auto-Tuning and the use of the keypad are explained in the following.

3.1	Safety Precautions	106
3.2	Keypad	107
3.3	LED Status Ring.....	113
3.4	Start-up Procedures	115
3.5	Items to Check before Starting Up Drive	120
3.6	Keypad Operation	122
3.7	Automatic Parameter Settings Optimized for Specific Applications	151
3.8	Auto-Tuning	153
3.9	Test Run	161
3.10	Fine Tuning during Test Runs (Adjustment of Control Functionality)	163
3.11	Test Run Checklist	173

3.1 Safety Precautions

DANGER

Electrical Shock Hazard

Do not perform inspections or wiring while the drive is energized. De-energize all devices before carrying out any wiring or repair operations. Voltage will remain within the capacitors inside the drive even after the power has been switched off. The Charge LED is extinguished once the DC bus voltage goes below 50 V DC. To prevent electric shock, always wait for at least the amount of time indicated on the warning labels and confirm that all indicators are OFF. Then, remove the front cover and terminal cover, measure the input power supply voltage and the DC bus voltage, and make sure that the voltages have been lowered to safe levels.

Failure to comply may result in death or serious injury.

WARNING

Electrical Shock Hazard

Do not operate equipment with covers removed. The diagrams in this section may include drives without covers or safety shields to illustrate details. Be sure to reinstall covers or shields before operating the drives and run the drives according to the instructions described in this manual.

Failure to comply could result in death or serious injury.

Do not remove covers or touch circuit boards while the power is on.

Failure to comply could cause death or serious injury.

Prepare a separate holding brake. Wire the holding brake so when a fault occurs, it is activated by an external sequence and shuts the power off or triggers an emergency switch.

Failure to comply could result in death or serious injury.

Crush Hazard

Make sure that proper safety measures have been taken in hoist-type application to prevent the load from falling.

Failure to do so may result in injury.

3.2 Keypad

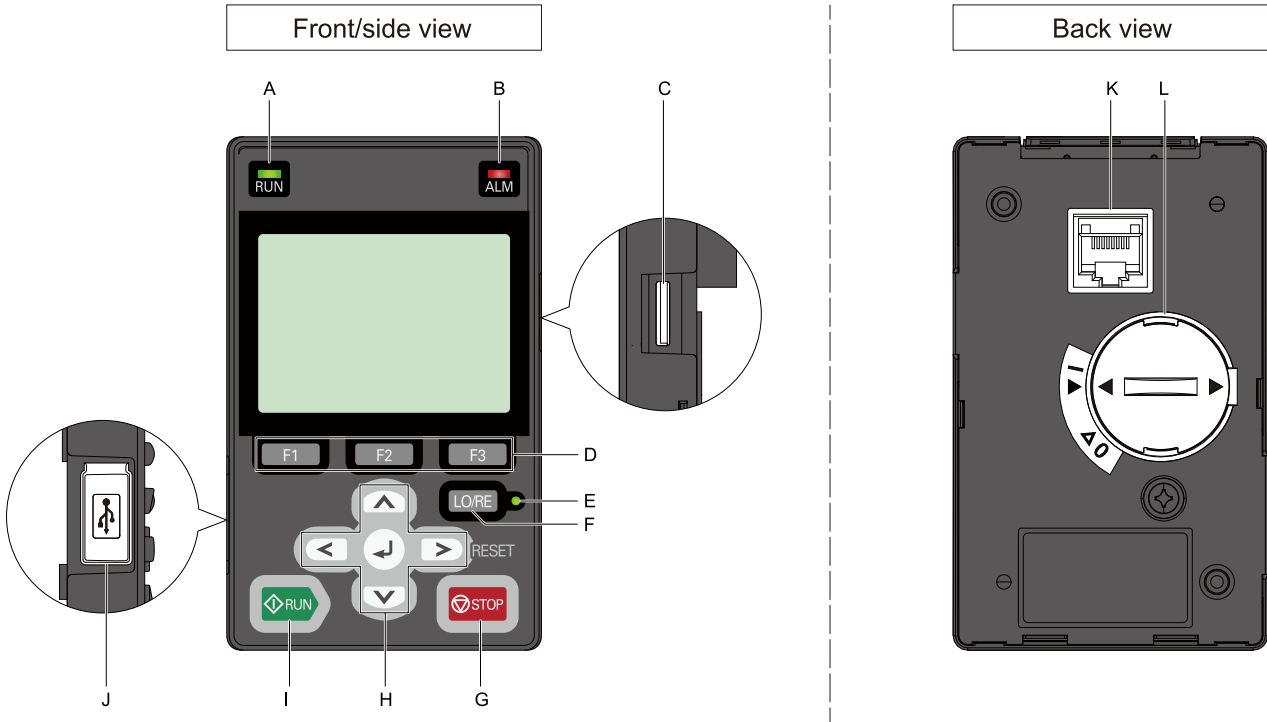













Figure 3.1 Keypad

Table 3.1 Keypad: Names and Functions

Sym bol	Names of Controls and Indicators	Function
A	RUN LED 	<p>Lit while the drive is operating the motor. The light switches off when the drive stops. Flashes when:</p> <ul style="list-style-type: none"> The drive is decelerating to stop. The drive was issued a Run command and the frequency reference is 0 Hz. <p>The light flashes quickly when:</p> <ul style="list-style-type: none"> Entering a Run command via the MFDI terminals, then switching to REMOTE while the drive is set to LOCAL. Entering a Run command via the MFDI terminals when the drive is not in Drive Mode. Entering a Fast Stop command. The safety function shuts off the drive output. Pushing on the keypad while the drive is running in REMOTE mode. Setting <i>b1-17 = 0 [Run Command at Power Up = Disregard Existing RUN Command]</i> and powering up the drive while the Run command is active.
B	ALM LED 	<p>Lit when the drive detects a fault. Flashes when the drive detects:</p> <ul style="list-style-type: none"> An alarm An oPE (parameter setting error) A fault or error during Auto-Tuning. <p>The light switches off when the drive is operating normally and there are no alarms or faults present.</p>
C	microSD card insertion slot	Insert a microSD card here to use the data log function.
D	Function Key F1, F2, F3 	The functions assigned to , , and vary depending on the currently displayed menu. The name of each function appears in the lower half of the display window.

Initial SetUp TrialRUN

3.2 Keypad

Symbol	Names of Controls and Indicators	Function
E	LO/RE LED 	Lit when the keypad is selected for Run command and frequency reference control (LOCAL). Off when a device other than the keypad is selected for Run command and frequency reference control (REMOTE). Note: • LOCAL: Operation via the keypad. Use the keypad to enter Run/Stop commands and the frequency reference command. • REMOTE: Operation via the control circuit terminal or serial transmission. Uses the frequency reference source entered in <i>b1-01 [Frequency Reference Selection 1]</i> and the Run command source selected in <i>b1-02 [Run Command Selection 1]</i> .
F	LO/RE Selection Key 	Switches drive control for the Run command and frequency reference between the keypad (LOCAL) and an external source (REMOTE). Note: • The LOCAL/REMOTE Selection Key is continuously enabled when operation has been stopped in Drive Mode. Whenever there is a risk, due to the keypad being switched from REMOTE to LOCAL, of erroneous operation having a detrimental effect on system operation, set <i>o2-01 = 0 [LO/RE Key Function Selection = Disabled]</i> and disable  • While a Run command is being input from an external source to the drive, the switch between LOCAL and REMOTE is not permitted.
G	STOP key 	Stops drive operation. Note: Employs a stop-priority circuit. Even when running based on signals from MFDI terminals (when set to REMOTE), if a danger is perceived, the motor can be brought to a fast stop by pressing  . If the ability to stop using  is unwanted, set <i>o2-02 = 0 [STOP Key Function Selection = Disabled]</i> .
H	Left Key 	Moves the cursor to the left.
	Up arrow key/Down arrow key 	<ul style="list-style-type: none"> • Scrolls up or down to display the next or previous item. • Selects parameter numbers. • Increments or decrements setting values.
	Right Key (Reset Key) 	<ul style="list-style-type: none"> • Moves the cursor to the right. • Proceeds to the next screen. • Resets the drive to clear a fault.
	ENTER Key 	<ul style="list-style-type: none"> • Enters parameter values and settings. • Determines each mode, parameter, and set values. • Selects a menu item to navigate between displays.
I	RUN key 	Starts the drive in LOCAL Mode. Starts the motor tuning procedure when in Auto-Tuning Mode. Note: Before operating the motor from the keypad, press the  on the keypad to set the drive to LOCAL mode.
J	USB terminal	Used to connect to a PC, using a commercially available mini USB cable.
K	RJ-45 connector	Used to connect to the drive.
L	Clock-use battery cover	Remove it when installing/replacing the clock battery. Note: • Refer to “Replace the Keypad’s Battery” for details on the type of battery required and the installation procedure. • The clock battery is not supplied as accessories.

WARNING! Sudden Movement Hazard. The drive may start unexpectedly if switching control sources when setting *b1-07 = 1 [LOCAL/REMOTE Run Selection = Accept existing RUN command]*. Clear all personnel from rotating machinery and electrical connections prior to switching control sources. Failure to comply may cause death or serious injury.

◆ LCD Display

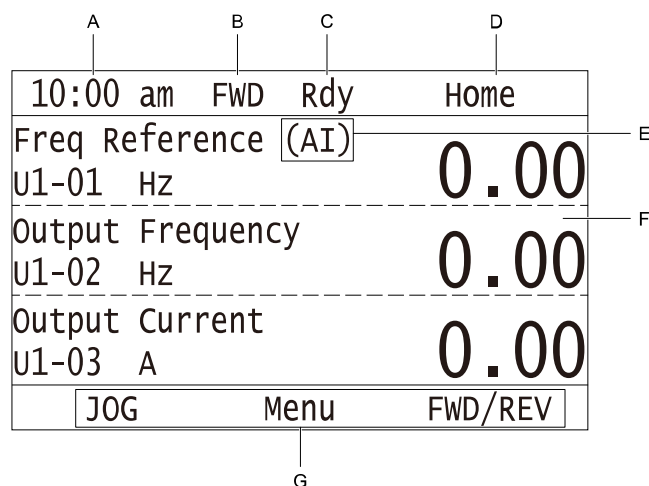









Figure 3.2 LCD Display Indications

Table 3.2 LCD Display Indications and Meaning

Symbol	Name	Description
A	Time display area	Current time is displayed. Time is set in the default settings screen.
B	Forward run/ Reverse indication	Shows direction of motor rotation. <ul style="list-style-type: none"> • FWD: Displayed when set to Forward run. • REV: Displayed when set to Reverse. Note: FWD or REV will be flashing while DriveWorksEZ is being used.
C	Ready	Rdy is displayed when the drive is ready for operation or is currently running.
D	Mode display area	The name of the currently displayed mode or screen is shown here.
E	Frequency reference source indication	The current frequency reference source is shown here. <ul style="list-style-type: none"> • KPD: keypad • AI: analog input terminal (terminals A1 to A3) • COM: MEMOBUS/Modbus communications • OPT: option card • RP: pulse train input terminal (terminal RP)
F	Data display area	Values set for parameters, current values of monitors, and details of operational results are shown here.
G	Function keys 1 to 3 (F1 to F3)	The function names shown here change depending on the screen that is selected. Execute a function by pressing one of the function keys F1 to F3 on the keypad.

◆ LED Indications of the Keypad

Table 3.3 Functions of the Keypad's Indicators

Indicator	ON	Flashing *1	Flashing Quickly *1	OFF
	The drive is operating the motor.	<ul style="list-style-type: none"> When the drive is ramping to stop. When a Run command is being input, and the frequency reference is 0 Hz. 	<ul style="list-style-type: none"> When the drive was in LOCAL mode, and a Run command was input via an MFDI terminal, it was switched to REMOTE mode. A Run command was input via an MFDI terminal when the drive was not in Drive Mode. Fast stop command is input. The output from the drive is shut off with the safety function. The  on the keypad was pressed while the drive was running in REMOTE mode. With $b1-17 = 0$ [Run Command at Power Up = Disregard existing RUN command] set, and a Run command input, the drive was energized. 	The motor is stopped.
	The drive detected a fault.	The drive detected the following alarms. <ul style="list-style-type: none"> Alarm Operation Error Tuning error Note: If a fault and alarm are detected at the same time, the drive will display (lit) the fault.	-	Normal operation (no fault or alarm).
	The Run command source is set to the keypad (LOCAL).	-	-	The Run command source is set to a non-keypad external reference (REMOTE).
Representations Used in This Manual (Ex. RUN Indicator)				

*1 For the details on the difference between the RUN LED's flashing vs flashing rapidly statuses, refer to Figure 3.3.

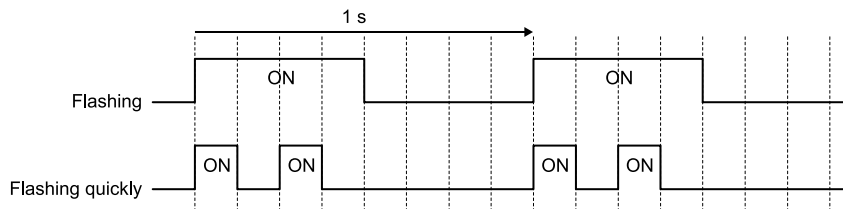

Figure 3.3 About the RUN LED's Flashing Statuses

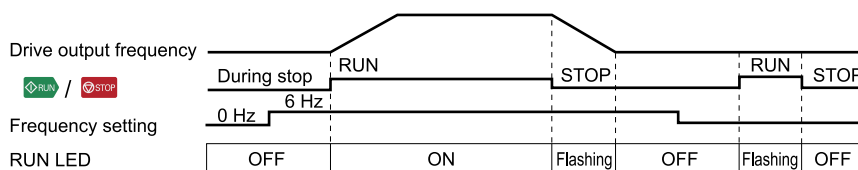
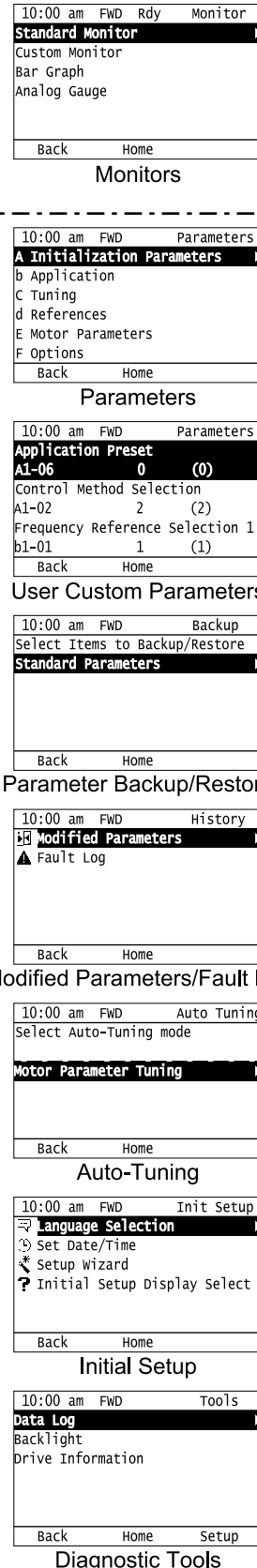
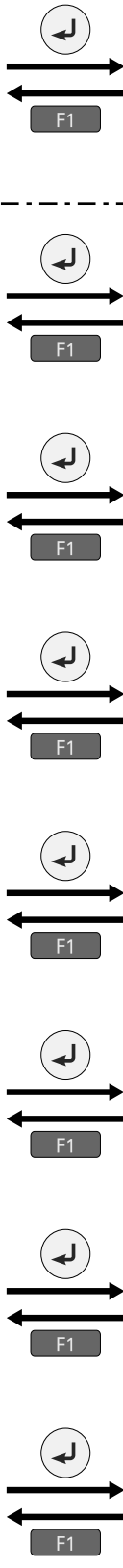
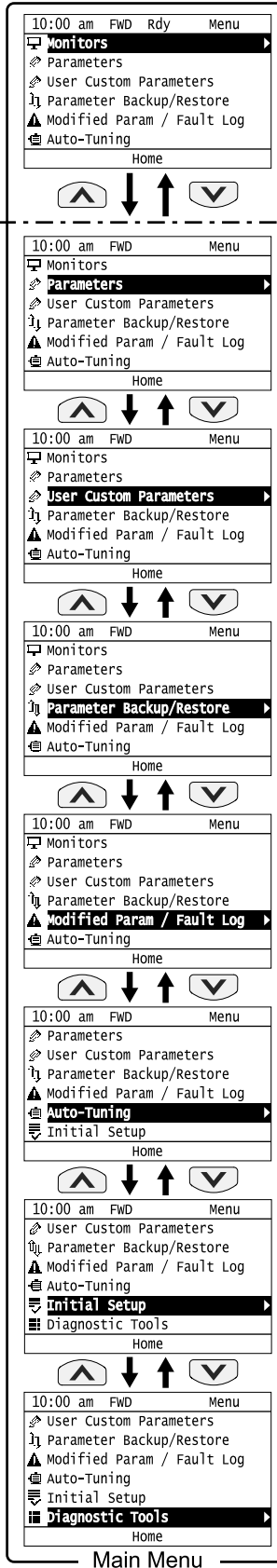
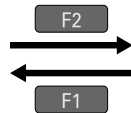

Figure 3.4 Correspondence between RUN LED and Drive Operation

◆ Keypad Modes and Menus

10:00 am	FWD	Rdy	Home
Freq Reference (KPD)			0.00
U1-01 Hz			0.00
Output Frequency			0.00
U1-02 Hz			0.00
Output Current			0.00
U1-03 A			0.00
JOG	Menu	FWD/REV	

HOME



Drive Mode

Programming Mode

Figure 3.5 Keypad Functions and Display Levels

Initial Setup TrialRUN

3.2 Keypad

Note:



- Energizing the drive with factory defaults will display the initial start-up screen. Press **F2** (Home) to display the HOME screen.
–To prevent the drive from displaying the initial start-up screen, Select [No] from the [Show Initial Setup Screen] setting.
- Press  from the Home screen to display the monitors.
- When *U1-01 [Frequency Reference]* is displayed on the Home screen in LOCAL mode, press  to change parameter *d1-01 [Reference 1]*.
- The keypad will display [Rdy] when the drive is in Drive Mode and ready to accept a Run command.
- The drive will not accept a Run command while in Programming Mode. Set *b1-08 [Run Command Select in PRG Mode]* to accept or reject a Run command from an external source while in Programming Mode.
–Set *b1-08 = 0 [Disregard RUN while Programming]* (default) to reject the Run command from an external source while in Programming Mode.
–Set *b1-08 = 1 [Accept RUN while Programming]* to accept the Run command from an external source while in Programming Mode.
–Set *b1-08 = 2 [Allow Programming Only at Stop]* to block changes from Drive Mode to Programming Mode while the drive is in operation.

Table 3.4 List of Screens and Functions

Mode	Keypad Display	Function
Drive Mode	Monitor Display Screen	Sets monitor display.
Programming Mode	Parameter Setting Screen	Changes parameter settings.
	Frequently Used Parameters Screen	Displays parameters which have been changed from the default settings.
	Parameter Backup Screen	Saves parameters to the keypad as backup.
	Changed Parameter / Fault History Screen	Displays fault history
	Auto-Tuning Screen	Executes Auto-Tuning.
	Initial Start-Up Screen	Changes selectable initial settings.
	Tool Screen	Sets data logs and backlight.

3.3 LED Status Ring

The LED Status Ring on the product cover shows the drive operating status.

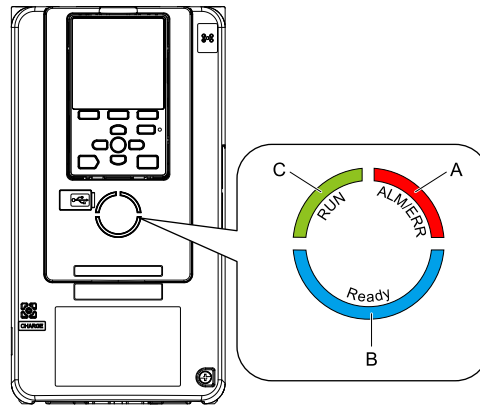

A - ALM/ERR
B - Ready

C - RUN

LED	State	Description	
A	ALM/ERR	Lit	The drive detected a fault.
		Flashing	The drive has detected: <ul style="list-style-type: none"> An alarm An oPExx (parameter setting error) A fault or error during Auto-Tuning. Note: If the drive detects a fault and an alarm at the same time, this LED will be lit to indicate the fault.
		Off	The drive is in normal operation without alarms or faults present.
B	Ready	Lit	The drive is operating or is ready for operation.
		Flashing	The drive is in <i>Sto</i> [<i>Safe Torque Off</i>] mode.
		Off	<ul style="list-style-type: none"> The drive detected a fault. The drive received an operation command and no fault is present, but the drive is inoperable.
C	RUN	Lit	The drive is operating the motor.
		Flashing <i>*1</i>	<ul style="list-style-type: none"> The drive is decelerating to stop. The drive was issued a Run command and the frequency reference is 0 Hz.
		Flashing Quickly <i>*1</i>	<ul style="list-style-type: none"> Entering a Run command via the MFDI terminals, then switching to REMOTE while the drive is set to LOCAL. Entering a Run command via the MFDI terminals when the drive is not in Drive Mode. Entering a Fast Stop command. The safety function shuts off the drive output. Pushing  on the keypad while the drive is running in REMOTE Mode. Setting $b1-17 = 0$ [<i>Run Command at Power Up = Disregard Existing RUN Command</i>] and powering up the drive while the Run command is active.
		Off	The motor is stopped.

*1 For the details on the difference between the RUN LED's flashing vs flashing rapidly statuses, refer to [Figure 3.6](#).

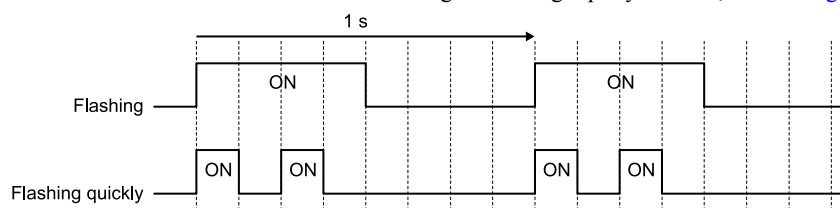

Figure 3.6 About the RUN LED's Flashing Statuses

3.3 LED Status Ring

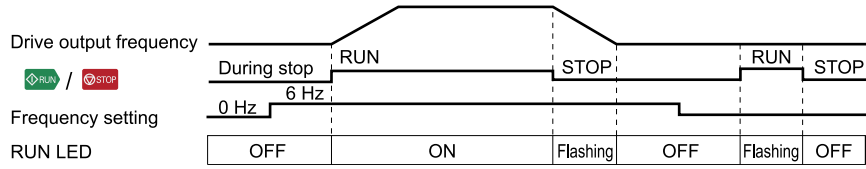

Figure 3.7 Correspondence between RUN LED and Drive Operation

3.4 Start-up Procedures

The basic steps required to start up the drive are explained in the following. Use the flowcharts to determine the most appropriate start-up method for a given application. Note that only the most basic settings are introduced here.

Note:

Refer to the section of *A1-06* to set up the drive using one of the Application Presets.

◆ Flowchart A (Connect Motor and Run It With Minimal Setting Changes)

Flowchart A describes a basic start-up sequence to connect a motor and get it running with a minimal amount of setting changes. Settings can slightly vary depending on the application. Use the drive default parameter settings in simple applications that do not require high precision.

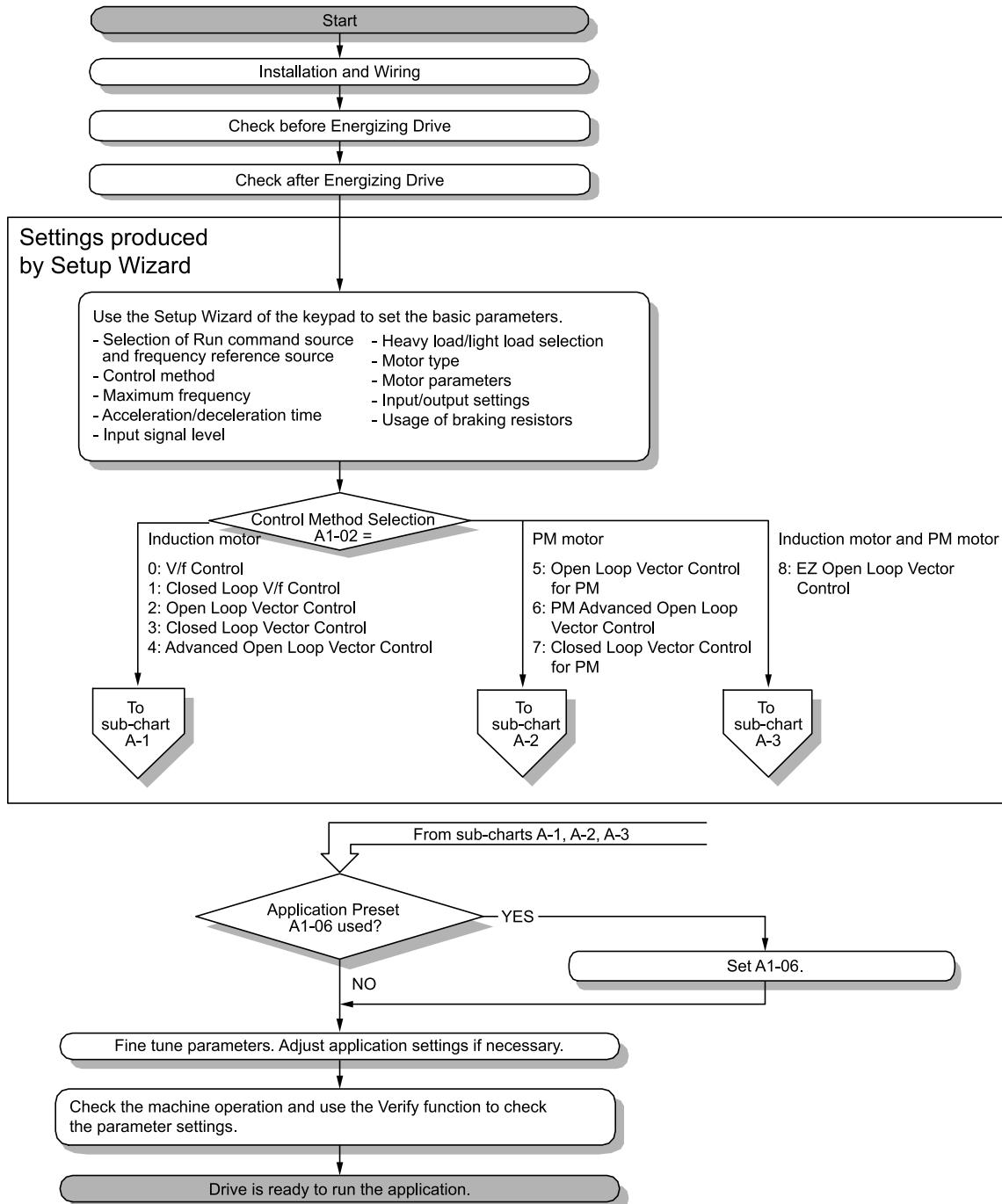

Figure 3.8 Basic Steps before Startup

◆ Sub-Chart A1 (Induction Motor Auto-Tuning and Test Run Procedure)

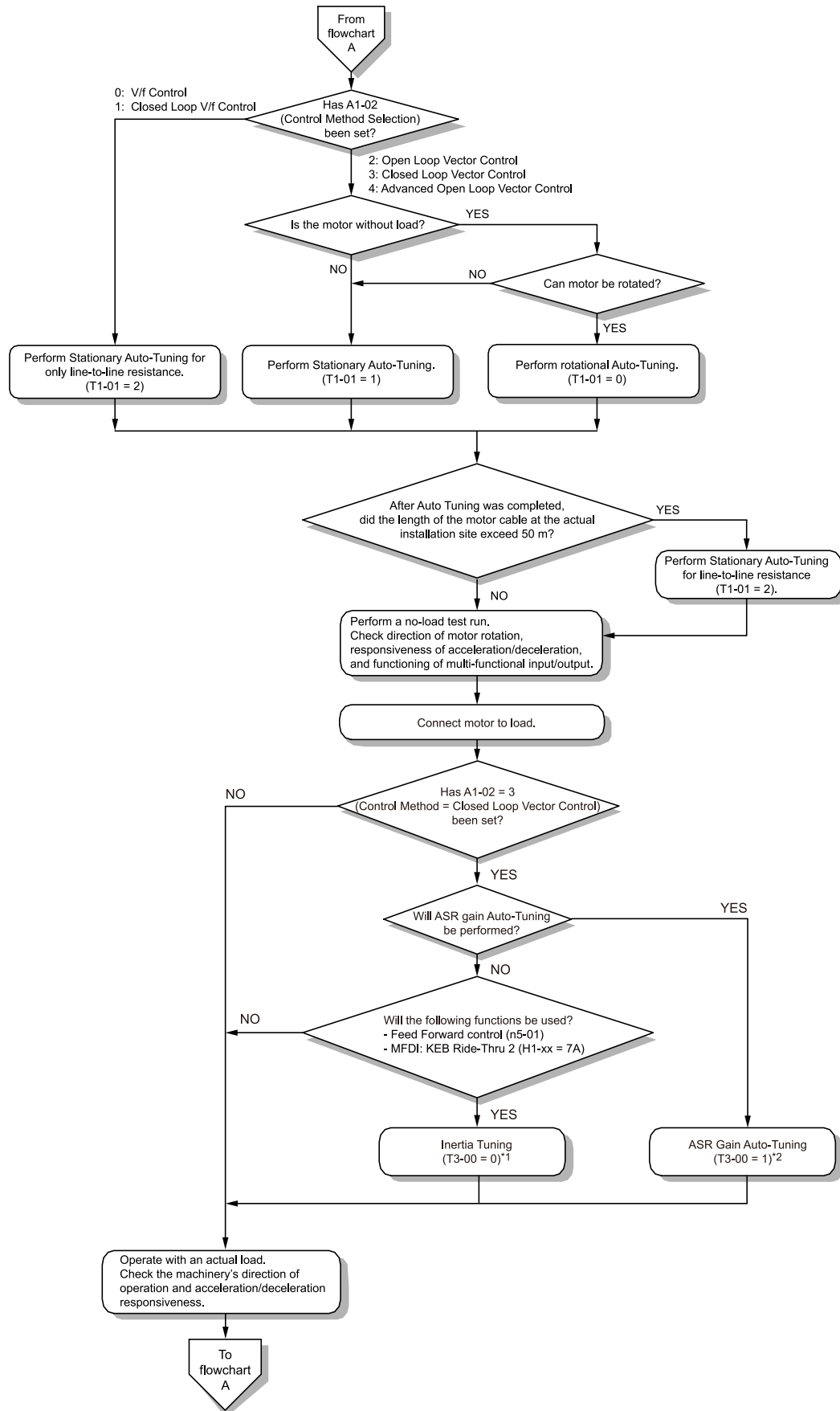

Figure 3.9 Induction Motor Auto-Tuning and Test Run Procedure

*1 Before performing Inertia Tuning, check to make sure that the holding brake is released.

- *2 Parameters related to Feed Forward control and KEB Ride-Thru 2 are automatically tuned when ASR Tuning is selected.

◆ Sub-Chart A-2 (PM Motor Auto-Tuning and Test Run Procedure)

Sub-Chart A-2 explains the basic steps to follow to start up the drive for a PM motor.

Note:

1. Although parameters for setting speed control with an encoder are also included as part of the settings made during Auto-Tuning, *F1-05 [PG 1 Rotation Selection]* must be set before Auto-Tuning is started.
2. Whenever the encoder has been replaced due to failure or other reasons, make sure to perform Z Pulse Offset Tuning.

WARNING! Crash Hazard. Conduct test operations to make sure that the drive operates safely after writing work is completed and parameters have been set. Failure to comply may cause injury or damage to equipment.

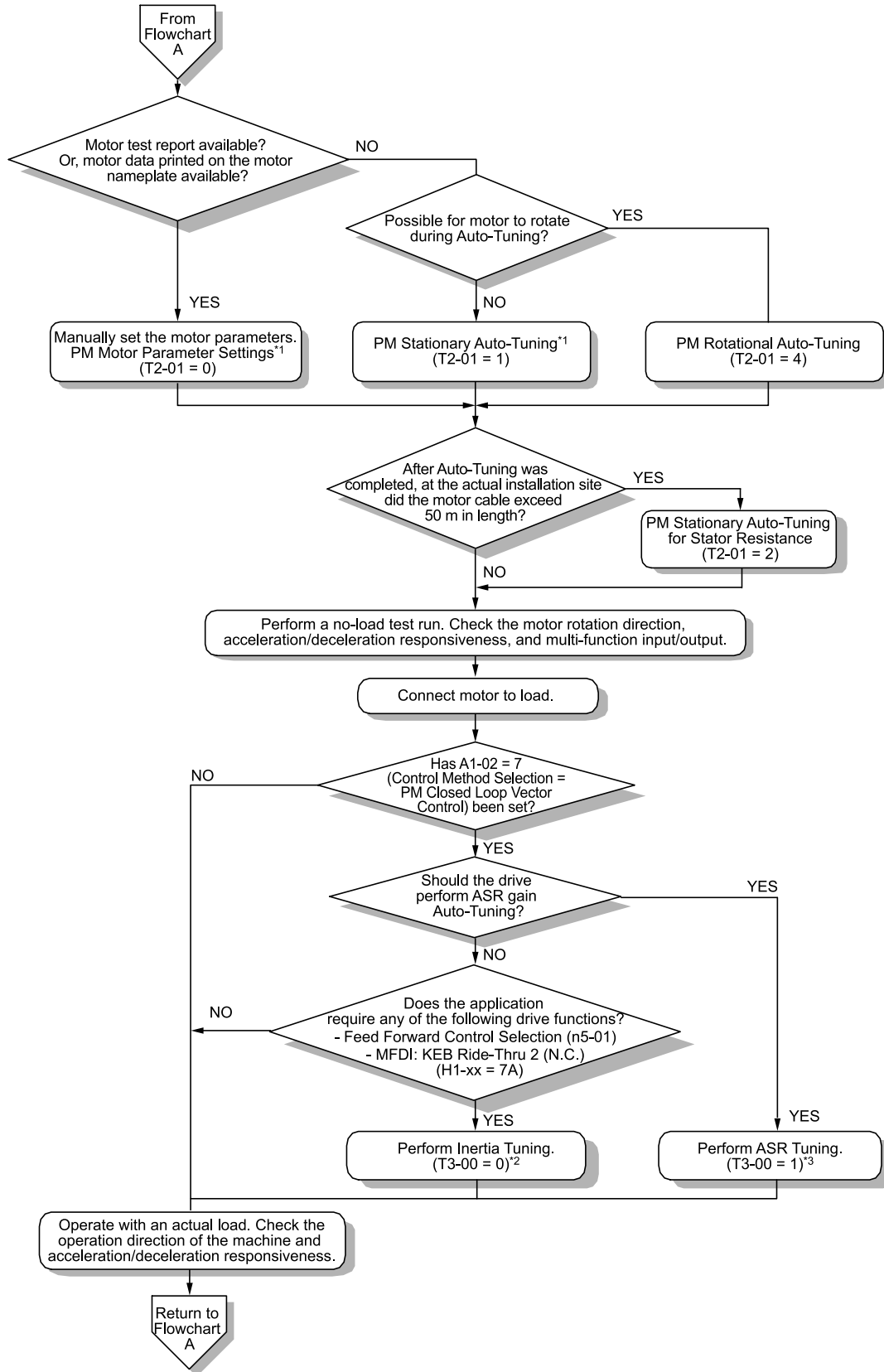

Figure 3.10 PM Motor Auto-Tuning and Test Run Procedure

*1 When using a Yaskawa PM motor (SMRA series, SSR1 series, or SST4 series), set E5-01 (Motor Code). When using a PM motor from another manufacturer, set *E5-01 = FFFF*.

*2 Before performing Inertia Tuning, check to make sure that the holding brake is released.

*3 Parameters related to Feed Forward control and KEB Ride-Thru 2 are automatically tuned when ASR Tuning is selected.

◆ Subchart A-3 (EZ Open Loop Vector Control Test Run Procedure)

Subchart A-3 the setup procedure for running a PM motor in EZ Open Loop Vector Control.

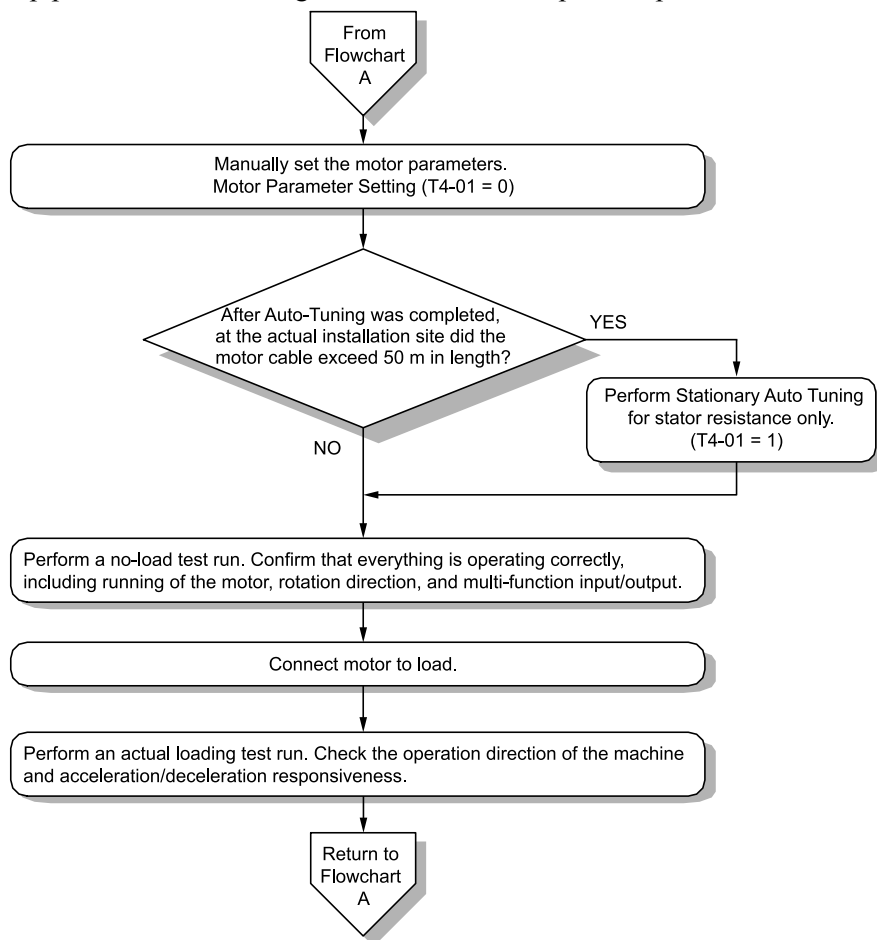

Figure 3.11 Procedure for Test Run of EZ Open Loop Vector Control Method

3.5 Items to Check before Starting Up Drive

◆ Check before Powering Up Drive

Be sure to check the following items before energizing the drive.

Table 3.5 Things to Check before Powering Up Drive

Items to Check	Description
Input power supply voltage	Confirm that the voltage of the input power supply is correct. 200 V class: three-phase AC 200 V to 240 V 50/60 Hz, DC 270 V to 340 V 400 V class: three-phase AC 380 V to 480 V 50/60 Hz, DC 510 V to 680 V
	Properly wire the power supply input terminals R/L1, S/L2, T/L3.
	Check for proper grounding of drive and motor.
Connection between drive output terminals and motor terminals	Ensure that the drive output terminals (U/T1, V/T2, and W/T3) and the motor terminals (U, V, and W) are wired correctly and that there are no loose screws.
Wiring of control circuit terminals	Ensure that the drive's control circuit terminals and all devices and switches are wired correctly and that there are no loose screws.
Status of control circuit terminals	Ensure that the inputs from all devices and switches connected to the control circuit terminals are OFF.
Status of connection between machine and Motor	Disengage all couplings and belts connecting the motor and machine.

◆ Check after Powering Up Drive

After energizing the drive, be sure to check the following items. Depending on the status of the drive, something like the following will be displayed on the keypad.

Table 3.6 State of Display at Power-Up

State	Display	Description
During Normal Operation	<p>Initial Start-Up Screen or</p> <p>HOME screen</p>	<ul style="list-style-type: none"> The initial start-up screen or the HOME screen will be displayed in the data display area. At the default settings, the initial start-up screen will be displayed when the drive is energized. To have the HOME screen be displayed instead, set [No] for the [Initial Start-Up Screen Selection] setting.
	When Fault is Detected	

◆ Perform the Initial Settings

The initial start-up screen is displayed on keypad when power to the drive is first energized. The date and time and the language displayed on the keypad can be selected. By using the setup wizard, the steps necessary for starting up the drive, from setting the basic parameters to performing Auto-Tuning, can be carried out. For details, refer to the section explaining the procedures for using the Setup Wizard.

Note:

If the initial start-up screen is not displayed, or a different screen is displayed, go to the main menu and select [Initial Settings] to display the initial start-up screen.

1. Perform the initial settings, item by item.

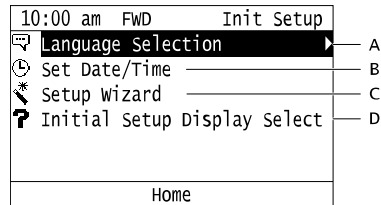

A - Select the Language Displayed on the Keypad

B - Set Date and Time

C - Setup Wizard

D - Select Display of Initial Settings Screen

Note:

Set [Yes] for the [Initial Start-Up Screen Selection] setting to display the initial start-up screen when the drive is energized. If set to [NO], the initial start-up screen will not be displayed the next time the drive is energized.

2. Press **F2** (Home).

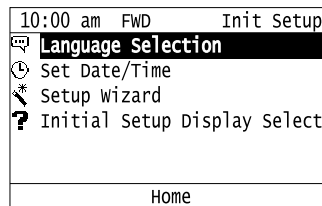

The HOME screen is displayed.

3.6 Keypad Operation

◆ Use the HOME Screen



The functions that can be controlled from the HOME screen and the content that is displayed are explained in the following.

10:00 am	FWD Rdy	Home
Freq Reference(AI)		0.00
U1-01	Hz	0.00
Output Frequency		0.00
U1-02	Hz	0.00
Output Current		0.00
U1-03	A	0.00
JOG	Menu	FWD/REV



■ View Monitors Shown in Home Screen

A monitor is shown in the data display area of the HOME screen, as shown in the following.



10:00 am	FWD Rdy	Home	
Freq Reference (AI)		0.00	Monitor
U1-01	Hz	0.00	
Output Frequency		0.00	
U1-02	Hz	0.00	
U1-03 A		0.00	
JOG	Menu	FWD/REV	

- The monitor that is displayed can be changed by changing the setting for *o1-40 [Home display selection]*.
- When “Custom Monitor” is set for *o1-40 [Home display selection]*, and there are a multiple number of screens, use  or  to switch among screens.

■ JOG Operation



Press  so the  is lit. The motor will rotate while  (JOG) is pressed. Cease from pressing the key, and the motor stops.

■ Change Motor between Forward/Reverse Run



The direction of motor rotation can be changed when running the drive from the keypad. Press  so the  is lit.

Press  (FWD/REV) to toggle the direction of motor rotation between forward and reverse.







■ Show the Standard Monitor

Press  to display the standard monitor (*Ux-xx*). Press  (HOME) to return to the HOME screen.

Note:

When a fault, minor fault, or an error occurs,  is pressed to display the content of the fault. If the  is then pressed again, the standard monitor (*Ux-xx*) is displayed.

■ Change the Frequency Reference Value

1. Press  to access the screen for changing the frequency.
2. Press  or  to select the digit, then use  or  to change the value.
3. Press  to confirm the changes in the value.

Note:

This function cannot be used when the keypad is not set to be the Run command source (REMOTE), or when *U1-01 [Freq Reference]* is not displayed in the HOME screen.

■ Show the Main Menu

Press **F2** to display the main menu. Press **F2** (HOME) to return to the HOME screen.

10:00 am	FWD	Rdy	Menu
Monitors			
Parameters			
User Custom Parameters			
Parameter Backup/Restore			
Modified Param / Fault Log			
Auto-Tuning			
Home			

◆ Show the Monitor

The following explains how to display the standard monitor (*Ux-xx*).

1. Press **F2** (Home) to display the HOME screen.

Note:

- [Home] appears in the upper right hand corner of the screen when in HOME mode.
- If [Home] is not displayed for **F2**, press **F1** (Back), and then press **F2** to display [Home].

2. Press **F2** (Menu).

10:00 am	FWD	Rdy	Home
Freq Reference (AI)			
U1-01	Hz		0.00
Output Frequency			
U1-02	Hz		0.00
Output Current			
U1-03	A		0.00
JOG	Menu	FWD/REV	

3. Press **▲** or **▼** to select [Display Monitor], and press **↵**.

10:00 am	FWD	Rdy	Menu
Monitors			
Parameters			
User Custom Parameters			
Parameter Backup/Restore			
Modified Param / Fault Log			
Auto-Tuning			
Home			

4. Press **▲** or **▼** to select [All Monitors], and press **↵**.

10:00 am	FWD	Rdy	Monitor
Standard Monitor			
Custom Monitor			
Bar Graph			
Analog Gauge			
Back Home			

5. Press **←** or **→** to position the cursor at the value to be changed.

10:00 am	FWD	Rdy	Monitor
Freq Reference (AI)			
U1-01	Hz		0.00
Output Frequency			
U1-02	Hz		0.00
Output Current			
U1-03	A		0.00
Back	Home	FWD/REV	

6. Press **▲** or **▼** to change the monitor number so the monitor to be checked is displayed.

10:00 am	FWD	Rdy	Monitor
Terminal A1 Input Lv			
U1-13	%		0.0
Terminal A2 Input Lv			
U1-14	%		0.0
Terminal A3 Input Lv			
U1-15	%		0.0
Back	Home	FWD/REV	

◆ Set Monitoring Favorites

A multiple number of things to be monitored can be selected and registered as items to be regularly displayed on the keypad. Up to a maximum of 12 monitors can be registered.

The following example shows how to assign Motor Speed to [Line 1 Monitor Selection] as a monitoring favorite.

1. Press **F2** (Home) to display the HOME screen.

Note:

- [Home] appears in the upper right hand corner of the screen when in HOME mode.
- If [Home] is not displayed for **F2**, press **F1** (Back), and then press **F2** to display [Home].

2. Press **F2** (Menu).

10:00 am	FWD	Rdy	Home
Freq Reference (AI)			
U1-01	Hz		0.00
Output Frequency			
U1-02	Hz		0.00
Output Current			
U1-03	A		0.00
JOG	Menu	FWD/REV	

3. Press **▲** or **▼** to select [Display Monitor], and press **↵**.

10:00 am	FWD	Rdy	Menu
Monitors			
Parameters			
User Custom Parameters			
Parameter Backup/Restore			
Modified Param / Fault Log			
Auto-Tuning			
Home			

4. Press **▲** or **▼** to select [Monitor Favorites], and press **F3** (Setup).

10:00 am	FWD	Rdy	Monitor
Standard Monitor			
Custom Monitor			
Bar Graph			
Analog Gauge			
Back	Home	Setup	

5. Press **▲** or **▼** to select the location to store the monitor, and press **↵**.

10:00 am	FWD	Setup	
1st Monitor Setting			
2nd Monitor Setting			
3rd Monitor Setting			
4th Monitor Setting			
5th Monitor Setting			
6th Monitor Setting			
Back	Home		

6. Press **▲** or **▼** to select the monitor number to register, and press **↵**.

When the *U Parameters* have been expressed as *Ux-xx* make settings for the “x-xx” portion. For example, if *U1-05* is to be monitored, set it to “105” as shown in the following.

10:00 am	FWD	Parameters	
1st Monitor Setting			
01-24			105
Motor Speed			
Default : 101			
Back	Default		

This completes the settings procedure.

◆ Show Monitoring Favorites

Following shows how to display monitors that have been registered as favorites.

1. Press **F2** (Home) to display the HOME screen.

Note:

- [Home] appears in the upper right hand corner of the screen when in HOME mode.
- If [Home] is not displayed for **F2**, press **F1** (Back), and then press **F2** to display [Home].

2. Press **F2** (Menu).

10:00 am	FWD	Rdy	Home
Freq Reference (AI)			
U1-01	Hz		0.00
Output Frequency			
U1-02	Hz		0.00
Output Current			
U1-03	A		0.00
JOG	Menu	FWD/REV	

3. Press **▲** or **▼** to select [Display Monitor], and press **↵**.

10:00 am	FWD	Rdy	Menu
Monitors			
Parameters			
User Custom Parameters			
Parameter Backup/Restore			
Modified Param / Fault Log			
Auto-Tuning			
Home			

4. Press **▲** or **▼** to select [Monitor Favorites], and press **↵**.

10:00 am	FWD	Rdy	Monitor
Standard Monitor			
Custom Monitor			
Bar Graph			
Analog Gauge			
Back	Home	Setup	

The monitor is displayed as follows.

10:00 am	FWD	Rdy	Monitor
Motor Speed			
U1-05	Hz		20.00
Output Power			
U1-08	kw		15.0
Terminal AI Input Lv			
U1-13	%		30.0
Back	Home	FWD/REV	

- When there are two or more screens, press **▲** or **▼** to switch among them.
- If [Line 1 Monitor Selection] is the only favorite that has been registered as a monitoring favorite, only one monitor is displayed. If [Line 1 Monitor Selection] and [Line 2 Monitor Selection] are the only favorites that have been registered, only two monitors are displayed.

◆ Set Monitor to be Displayed as Bar Graph

The following explains how to set the monitor to be displayed as a bar graph.

The following explains the procedure for displaying the frequency reference in the form of a bar graph.



1. Press **F2** (Home) to display the HOME screen.

Note:

- [Home] appears in the upper right hand corner of the screen when in HOME mode.
- If [Home] is not displayed for **F2**, press **F1** (Back), and then press **F2** to display [Home].

2. Press **F2** (Menu).

10:00 am	FWD	Rdy	Home
Freq Reference (AI)			
U1-01	Hz		0.00
Output Frequency			
U1-02	Hz		0.00
Output Current			
U1-03	A		0.00
JOG	Menu	FWD/REV	

3. Press  or  to select [Display Monitor], and press .

10:00 am	FWD	Rdy	Menu
Monitors			
Parameters			
User Custom Parameters			
Parameter Backup/Restore			
Modified Param / Fault Log			
Auto-Tuning			
Home			

4. Press  or  to select [Display Bar Graph], and press **F3** (Setup).

10:00 am	FWD	Rdy	Monitor
Standard Monitor			
Custom Monitor			
Bar Graph			
Analog Gauge			
Back	Home	Setup	

5. Press  or  to select the location to store the monitor, and press .

10:00 am	FWD		Setup
1st Monitor Setting			
2nd Monitor Setting			
3rd Monitor Setting			
Back	Home		

6. Press .

10:00 am	FWD		Setup
1st Monitor Setting			
1st Monitor Setting			
o1-24	101	(101)	
1st Monitor Area Selection			
o1-41	0	(0)	
Back	Home		

7. Press  or  to select the monitor number to register, and press .

When the *U Parameters* have been expressed as *Ux-xx* make settings for the “x-xx” portion. For example, if you want to monitor *U1-01 [Freq Reference]*, make a setting of “101,” as shown in the following.

10:00 am	FWD		Parameters
1st Monitor Setting			
o1-24		101	
Freq Reference			
Default : 101			
Back	Default		

This completes the settings procedure.

◆ Display Monitor as Bar Graph

The following explains how to display a specified monitor as a bar graph. Up to three can be displayed.

1. Press **F2** (Home) to display the HOME screen.

Note:

- [Home] appears in the upper right hand corner of the screen when in HOME mode.
- If [Home] is not displayed for **F2**, press **F1** (Back), and then press **F2** to display [Home].

2. Press **F2** (Menu).

10:00 am	FWD	Rdy	Home
Freq Reference (AI)			0.00
U1-01 Hz			0.00
Output Frequency			0.00
U1-02 Hz			0.00
Output Current			0.00
U1-03 A			0.00
JOG	Menu	FWD/REV	

3. Press **▲** or **▼** to select [Display Monitor], and press **↵**.

10:00 am	FWD	Rdy	Menu
Monitors			
Parameters			
User Custom Parameters			
Parameter Backup/Restore			
Modified Param / Fault Log			
Auto-Tuning			
Home			

4. Press **▲** or **▼** to select [Display Bar Graph], and press **↵**.

10:00 am	FWD	Rdy	Monitor
Standard Monitor			
Custom Monitor			
Bar Graph			
Analog Gauge			
Back	Home	Setup	

It will be displayed as follows.

10:00 am	FWD	Rdy	Monitor
U1-01			
40.00Hz	-100%	0%	100%
U1-02			
40.00Hz	-100%	0%	100%
U1-03			
3.0A	-100%	0%	100%
Back	Home	FWD/REV	

◆ Set Monitor to be Displayed as Analog Meter

The following explains how to set the monitor to be displayed as an analog meter.

1. Press **F2** (Home) to display the HOME screen.

Note:

- [Home] appears in the upper right hand corner of the screen when in HOME mode.
- If [Home] is not displayed for **F2**, press **F1** (Back), and then press **F2** to display [Home].

2. Press **F2** (Menu).

10:00 am	FWD	Rdy	Home
Freq Reference (AI)			0.00
U1-01 Hz			0.00
Output Frequency			0.00
U1-02 Hz			0.00
Output Current			0.00
U1-03 A			0.00
JOG	Menu	FWD/REV	

3. Press or to select [Display Monitor], and press .

10:00 am	FWD	Rdy	Menu
Monitors			
Parameters			
User Custom Parameters			
Parameter Backup/Restore			
Modified Param / Fault Log			
Auto-Tuning			
Home			

4. Press or to select [Display Analog Meter], and press (Setup).

10:00 am	FWD	Rdy	Monitor
Standard Monitor			
Custom Monitor			
Bar Graph			
Analog Gauge			
Back	Home	Setup	

5. Press .

10:00 am	FWD	Setup
Analog Gauge		
1st Monitor Setting		
o1-24	101	(101)
Analog Gauge Area Selection		
o1-55	1	(1)
Back	Home	

6. Press or to select the monitor number to register, and press .

When the *U Parameters* have been expressed as *Ux-xx* make settings for the “x-xx” portion. For example, if *U1-01* is to be monitored, set it to “101” as shown in the following.

10:00 am	FWD	Parameters
1st Monitor Setting		
o1-24	101	
Freq Reference		
Default : 101		
Back	Default	

This completes the settings procedure.

◆ Show Monitor as Analog Meter

The following explains how to display a monitor as an analog meter.



1. Press (Home) to display the HOME screen.

Note:

- [Home] appears in the upper right hand corner of the screen when in HOME mode.
- If [Home] is not displayed for , press (Back), and then press to display [Home].

2. Press (Menu).

10:00 am	FWD	Rdy	Home
Freq Reference (AI)			
U1-01	Hz		0.00
Output Frequency			
U1-02	Hz		0.00
Output Current			
U1-03	A		0.00
JOG	Menu	FWD/REV	

3. Press  or  to select [Display Monitor], and press .

10:00 am FWD Rdy Menu
Monitors
Parameters
User Custom Parameters
Parameter Backup/Restore
Modified Param / Fault Log
Auto-Tuning
Home

4. Press  or  to select [Display Analog Meter], and press .

10:00 am FWD Rdy Monitor
Standard Monitor
Custom Monitor
Bar Graph
Analog Gauge
Back Home Setup

It will be displayed as follows.

10:00 am FWD Rdy Monitor
Output Frequency
50.0
0.0 60.0Hz 100.0
Back Home FWD/REV



◆ Change Parameter Setting Values

Follow this procedure to set parameters according to the application.

This procedure shows an example of how to change the setting value of *C1-01 [Acceleration Time 1]*.

1. Press  (Home) to display the HOME screen.

Note:

- The keypad will display [Home] in the upper right corner when the HOME screen is active.
- Press  (Back) to display [Home] on  if [Home] does not appear on .

2. Press  (Menu).

10:00 am FWD Rdy Home
Freq Reference (AI)
U1-01 Hz 0.00
Output Frequency
U1-02 Hz 0.00
Output Current
U1-03 A 0.00
JOG Menu FWD/REV

3. Press  or  to select [Parameter], and press .

10:00 am FWD Menu
Monitors
Parameters
User Custom Parameters
Parameter Backup/Restore
Modified Param / Fault Log
Auto-Tuning
Home

4. Press  or  to select [C Tuning], and press .

10:00 am FWD Parameters
A Initialization Parameters
b Application
C Tuning
d References
E Motor Parameters
F Options
Back Home

5. Press or to select [C1 Accel & Decel Time], and press .

10:00 am	FWD	Parameters
C1 Accel & Decel Time		
C2 S-Curve Characteristics		
C3 Slip Compensation		
C4 Torque Compensation		
C6 Duty & Carrier Frequency		
Back	Home	

6. Press or to select C1-01, and press .

10:00 am	FWD	Parameters
Acceleration Time 1		
C1-01	10.0	(10.0)sec
Deceleration Time 1		
C1-02	10.0	(10.0)sec
Acceleration Time 2		
C1-03	10.0	(10.0)sec
Back	Home	

7. Press or to select a specific digit. Press or select the desired number.

10:00 am	FWD	Parameters
Acceleration Time 1		
C1-01	0010.0	sec
Default : 10.0sec		
Range : 0.0~6000.0		
Back	Default	Min/Max

- Press [Default] to reset the parameters to the factory default.
- Press [Min/Max] will alternate between the minimum value and maximum value.

8. Press to confirm changes.

10:00 am	FWD	Parameters
Acceleration Time 1		
C1-01	0020.0	sec
Default : 10.0sec		
Range : 0.0~6000.0		
Back	Default	Min/Max

9. Continue to set parameters or press (Back) to return to the HOME screen.

This completes the parameter changes.

◆ Checking Commonly Used Parameters

Displays the parameter set in A2-01 to A2-32 [User Parameter 1 to User Parameter 32]. In addition, not only is it possible to check the parameters that have been set, but further changes in their setting values can be made as well.

Note:

Always displays A1-06 [Application Selection] at the top of the list. The settings for A2-01 to A2-32 vary depending on the value selected for A1-06 making it easy to set and reference the required parameter settings.

1. Press (Home) to display the HOME screen.

Note:

- [Home] appears in the upper right hand corner of the screen when in HOME mode.
- If [Home] is not displayed for , press (Back), and then press to display [Home].

2. Press **F2** (Menu).

10:00 am	FWD	Rdy	Home
Freq Reference (AI)			
U1-01	Hz		0.00
Output Frequency			
U1-02	Hz		0.00
Output Current			
U1-03	A		0.00
JOG	Menu	FWD/REV	

3. Press **▲** or **▼** to select [Commonly Used Parameters], and press **↵**.

10:00 am	FWD	Menu
Monitors		
Parameters		
User Custom Parameters		
Parameter Backup/Restore		
Modified Param / Fault Log		
Auto-Tuning		
Home		

4. Press **▲** or **▼** to display the parameter to be checked.

10:00 am	FWD	Parameters
Application Preset		
A1-06	0	(0)
Control Method Selection		
A1-02	2	(2)
Frequency Reference Selection 1		
b1-01	1	(1)
Back	Home	

5. To change a parameter, press **▲** or **▼**, select the parameter to set, and press **↵**.

10:00 am	FWD	Parameters
Application Preset		
A1-06	0	(0)
Control Method Selection		
A1-02	2	(2)
Frequency Reference Selection 1		
b1-01	1	(1)
Back	Home	

6. Press **<** or **>** to select the digit, then use **▲** or **▼** to change the value.

10:00 am	FWD	Parameters
Control Method Selection		
A1-02	2	
Open Loop Vector Control		
Default : 2		
Back	Default	

7. When done changing the value, press **↵**.

10:00 am	FWD	Parameters
Control Method Selection		
A1-02	0	
V/f Control		
Default : 2		
Back	Default	

This completes the parameter setting procedure.

◆ Saving a Backup of Parameters

A backup of the drive's parameters can be saved to the keypad. The parameter setting values for 4 drives can be stored in separate storage areas. By creating backups of the parameter settings, time can be saved when replacing a drive, because the parameter settings do not need to be done over again. Additionally, when setting up a multiple number of drives, the parameter setting values for a drive that has already completed a test run can be copied to other drives.

3.6 Keypad Operation

Note:

- Always stop the motor before making a backup of the parameters.
- While a backup is being made, the drive will not accept any Run commands.

1. Press **F2** (Home) to display the HOME screen.

Note:

- [Home] appears in the upper right hand corner of the screen when in HOME mode.
- If [Home] is not displayed for **F2**, press **F1** (Back), and then press **F2** to display [Home].

2. Press **F2** (Menu).

10:00 am	FWD	Rdy	Home
Freq Reference (AI)			
U1-01	Hz		0.00
Output Frequency			
U1-02	Hz		0.00
Output Current			
U1-03	A		0.00
JOG	Menu	FWD/REV	

3. Press **▲** or **▼** to select [Parameter Backup], and press **↵**.

10:00 am	FWD	Menu
Monitors		
Parameters		
User Custom Parameters		
Parameter Backup/Restore		
Modified Param / Fault Log		
Auto-Tuning		
Home		

4. Press **▲** or **▼** to select the items to be backed up, and press **↵**.

10:00 am	FWD	Backup
Select Items to Backup/Restore		
Standard Parameters		
Back	Home	

5. Press **▲** or **▼** to select [Backup (Drive → Keypad)], and press **↵**.

10:00 am	FWD	Backup
Select Desired Action		
Backup (drive → keypad)		
Restore (Keypad → drive)		
Verify (check for mismatch)		
Back	Home	

6. Press **▲** or **▼** to select the area targeted for storage, and press **↵**.

10:00 am	FWD	Backup
Select Backup/Restore Location		
Memory Location 1		
Memory Location 2		
Memory Location 3		
Memory Location 4		
Back	Home	

“End” appears on the keypad, signifying that the backup completed successfully.

◆ Writing Backed-Up Parameters to the Drive

Parameters backed up on the keypad can be written to another drive.

Note:

- Always stop the drive before starting the restoration procedure for parameter backups.
- The drive does not accept Run commands while restoring parameters.

1. Press **F2** (Home) to display the HOME screen.

Note:

- [Home] appears in the upper right hand corner of the screen when in HOME mode.
- If [Home] is not displayed for **F2**, press **F1** (Back), and then press **F2** to display [Home].

2. Press **F2** (Menu).

10:00 am	FWD	Rdy	Home
Freq Reference (AI)			0.00
U1-01	Hz		0.00
Output Frequency			0.00
U1-02	Hz		0.00
Output Current			0.00
U1-03	A		0.00
JOG	Menu	FWD/REV	

3. Press **▲** or **▼** to select [Parameter Backup], and press **↵**.

10:00 am	FWD	Menu
Monitors		
Parameters		
User Custom Parameters		
Parameter Backup/Restore		
Modified Param / Fault Log		
Auto-Tuning		
Home		

4. Press **▲** or **▼** to select the item to be restored, and press **↵**.

10:00 am	FWD	Backup
Select Items to Backup/Restore		
Standard Parameters		
Back	Home	

5. Press **▲** or **▼** to select [Restore (Keypad → Drive)], and press **↵**.

10:00 am	FWD	Backup
Select Desired Action		
Backup (drive → keypad)		
Restore (Keypad → drive)		
Verify (check for mismatch)		
Back	Home	

6. Press **▲** or **▼** to select the parameter data that was stored, and press **↵**.

10:00 am	FWD	Backup
Select Backup/Restore Location		
Memory Location 1		
Memory Location 2		
Memory Location 3		
Memory Location 4		
Back	Home	

“End” is displayed on the keypad when the write procedure completes successfully.

◆ Verify Keypad Parameters and Drive Parameters

Verifies whether the parameter setting values backed up in the keypad match the parameter setting values in the drive.

Note:

- Always stop the drive before starting the verification procedure for parameters.
- The drive does not accept Run commands while verifying parameters.

1. Press **F2** (Home) to display the HOME screen.

Note:

- [Home] appears in the upper right hand corner of the screen when in HOME mode.
- If [Home] is not displayed for **F2**, press **F1** (Back), and then press **F2** to display [Home].

2. Press **F2** (Menu).

10:00 am	FWD	Rdy	Home
Freq Reference (AI)			
U1-01	Hz		0.00
Output Frequency			
U1-02	Hz		0.00
Output Current			
U1-03	A		0.00
JOG	Menu	FWD/REV	

3. Press **▲** or **▼** to select [Parameter Backup], and press **↵**.

10:00 am	FWD	Menu
Monitors		
Parameters		
User Custom Parameters		
Parameter Backup/Restore		▶
Modified Param / Fault Log		
Auto-Tuning		
Home		

4. Press **▲** or **▼** to select the item to verify, and press **↵**.

10:00 am	FWD	Backup
Select Items to Backup/Restore		
Standard Parameters		▶
Back	Home	

5. Press **▲** or **▼** to select [Verify (Drive ↔ Keypad)], and press **↵**.

10:00 am	FWD	Backup
Select Desired Action		

Backup (drive → keypad)		
Restore (keypad → drive)		
Verify (check for mismatch)		
▶		
Back	Home	

6. Press **▲** or **▼** to select the data to verify, and press **↵**.

10:00 am	FWD	Backup
Select Backup/Restore Location		
Memory Location 1		▶
Memory Location 2		
Memory Location 3		
Memory Location 4		
Back	Home	

If the parameter setting values backed up in the keypad match the parameter setting values copied to the drive, "End" is displayed.

Note:

If the parameter setting values backed up in the keypad do not match the parameter setting values copied to the drive, *vFyE [VERIFY ERROR]* is displayed. Press any key to return to the screen in Step 6.

◆ Checking Modified Parameters

All parameters changed from their default settings as the result of Auto-Tuning or setting changes will be displayed. This can be conveniently used to check for changed parameters when replacing a drive. If there are no parameters that have been changed, "0 Parameters" is displayed. In addition, not only is it possible to check the parameters that have been changed, but further changes in their setting values can be made as well.

1. Press **F2** (Home) to display the HOME screen.

Note:

- [Home] appears in the upper right hand corner of the screen when in HOME mode.
- If [Home] is not displayed for **F2**, press **F1** (Back), and then press **F2** to display [Home].

2. Press **F2** (Menu).

10:00 am	FWD	Rdy	Home
Freq Reference (AI)			
U1-01	Hz		0.00
Output Frequency			
U1-02	Hz		0.00
Output Current			
U1-03	A		0.00
JOG	Menu	FWD/REV	

3. Press **▲** or **▼** to select [Modified Parameters/Fault History], and press **↵**.

10:00 am	FWD	Menu
Monitors		
Parameters		
User Custom Parameters		
Parameter Backup/Restore		
Modified Param / Fault Log		
Auto-Tuning		
Home		

4. Press **▲** or **▼** to select [Modified Parameters], and press **↵**.

10:00 am	FWD	History
Modified Parameters		
Fault Log		
Back Home		

5. Press **↵**.





10:00 am	FWD	Modified
User Modified Parameters		
Standard Parameters		
2 Parameters		
Back Home		

6. Press **▲** or **▼** to display the parameter to be checked.

10:00 am	FWD	Modified
Acceleration Time 1		
C1-01	20.0	(10.0)sec
Motor Rated Current (FLA)		
E2-01	97.2	(77.2)A
Back Home		

7. To change a parameter again, press **▲** or **▼**, select the parameter to revise, and press **↵**.

10:00 am	FWD	Modified
Acceleration Time 1		
C1-01	20.0	(10.0)sec
Motor Rated Current (FLA)		
E2-01	97.2	(77.2)A
Back Home		

8. Press  or  to select the digit, then use  or  to change the value.

10:00 am	FWD	Parameters
Acceleration Time 1		
C1-01	0020.0	sec
Default : 10.0sec		
Range : 0.0~6000.0		
Back	Default	Min/Max

9. When done changing the value, press .

10:00 am	FWD	Parameters
Acceleration Time 1		
C1-01	0030.0	sec
Default : 10.0sec		
Range : 0.0~6000.0		
Back	Default	Min/Max



This completes the parameter revision procedure.

◆ Restoring Default Settings for Modified Parameters

All parameters modified as the result of Auto-Tuning, setting changes, or other reasons will be reset to their default settings.

1. Press  (Home) to display the HOME screen.

Note:

- [Home] appears in the upper right hand corner of the screen when in HOME mode.
- If [Home] is not displayed for , press  (Back), and then press  to display [Home].







2. Press  (Menu).

10:00 am	FWD	Rdy	Home
Freq Reference (AI)			
U1-01	Hz		0.00



Output Frequency			
U1-02	Hz		0.00

Output Current			
U1-03	A		0.00
JOG	Menu	FWD/REV	

3. Press  or  to select [Modified Parameters/Fault History], and press .



10:00 am	FWD	Menu
	Monitors	
	Parameters	
	User Custom Parameters	
	Parameter Backup/Restore	
	Modified Param / Fault Log	
	Auto-Tuning	
Home		

4. Press  or  to select [Modified Parameters], and press .

10:00 am	FWD	History
	Modified Parameters	
	Fault Log	
Back Home		

5. Press .

10:00 am	FWD	Modified
User Modified Parameters		
Standard Parameters		
2 Parameters		
Back	Home	

6. Press  or  to select the parameters to be returned to their default settings, and press .

10:00 am	FWD	Modified
Acceleration Time 1		
C1-01	20.0	(10.0)sec
Motor Rated Current (FLA)		
E2-01	97.2	(77.2)A
Back	Home	

7. Press  (Default).

10:00 am	FWD	Parameters
Acceleration Time 1		
C1-01	0020.0	sec
Default : 10.0sec		
Range : 0.0~6000.0		
Back	Default	Min/Max

8. Press .

10:00 am	FWD	Parameters
Acceleration Time 1		
C1-01	0010.0	sec
Default : 10.0sec		
Range : 0.0~6000.0		
Back	Default	Min/Max

The parameters are returned to their default settings.

◆ Display Fault History



The fault code and date and time of faults that occurred in the past can be checked. Up to a maximum of 10 past fault events can be checked.

Note:

- To keep a record of the date and time of fault events, the date and time need to be set beforehand.
- If the clock-use battery has not been installed in the keypad, the date and time will need to be set when the drive is energized again after it was de-energized.

1. Press  (Home) to display the HOME screen.

Note:

- [Home] appears in the upper right hand corner of the screen when in HOME mode.
- If [Home] is not displayed for , press  (Back), and then press  to display [Home].

2. Press  (Menu).

10:00 am	FWD	Rdy	Home
Freq Reference (AI)			
U1-01	Hz	0.00	
Output Frequency			
U1-02	Hz	0.00	
Output Current			
U1-03	A	0.00	
JOG	Menu	FWD/REV	

- Press or to select [Modified Parameters/Fault History], and press .

10:00 am FWD	Menu
Monitors	
Parameters	
User Custom Parameters	
Parameter Backup/Restore	
Modified Param / Fault Log	▶
Auto-Tuning	
Home	

- Press or to select [Fault History], and press .

10:00 am FWD	History
Modified Parameters	
Fault Log	▶
Back Home	

- Press or to display the fault history to be checked.

10:00 am FWD	History
Fault History Log	
01 ov	2016/01/01 14:00 Overvoltage
02 oc	2016/01/01 14:00 Overcurrent
Back Home	

◆ Perform Auto-Tuning

Parameters are automatically set based on the motor characteristics when Auto-Tuning is executed. Regarding the information required for Auto-Tuning, refer to the motor nameplate or the motor test report.

VARTISPEED									
3-PHASE PERMANENT MAGNET MOTOR									
TYPE SST4-					POLES E5-04				
PROTECTION					COOLING				
kW	V	Hz	RATING	A	r/min	r ₁	E5-05		
E5-02	E1-05			E5-03	E1-04,06	Ld	E5-06		
						Lq	E5-07		
						Ke	E5-09		
TNS.	COOLANT TEMP.	°C	ALTITUDE	m		Δθ	E5-11		
STD			MASS	kg		Δθ'			
BRG NO	DRIVE		OPP			Ki			
	END		END			Kt			
SER NO			YEAR			Si			
YASKAWA ELECTRIC CORPORATION JAPAN									

Figure 3.12 Motor Nameplate (Example)

WARNING! Sudden Movement Hazard. Clear the area surrounding the drive motor and load before Auto-Tuning. The drive and motor may start unexpectedly during Auto-Tuning, which could cause death or serious injury.

WARNING! Electrical Shock Hazard. High voltage will be supplied to the motor when Stationary Auto-Tuning is performed even with the motor stopped. Do not touch the motor until Auto-Tuning has been completed. Failure to comply may result in injury or death from electrical shock.

NOTICE: Rotational Auto-Tuning will not function properly if a holding brake is engaged on the load. Ensure the motor can freely spin before beginning Auto-Tuning. Failure to comply could result in improper operation of the drive.

NOTICE: Never perform Rotational Auto-Tuning with the load connected to the motor. Make sure that the load is uncoupled from the motor. Failing to do so may result in erroneous operation. The drive cannot accurately calculate motor parameters if the load is left connected to the motor while performing Rotational Auto-Tuning, and will not be able to operate the motor correctly.

The following Auto-Tuning example introduces the procedure for Rotational Auto-Tuning.

- Press (Home) to display the HOME screen.

Note:

- [Home] appears in the upper right hand corner of the screen when in HOME mode.
- If [Home] is not displayed for , press (Back), and then press to display [Home].

2. Press **F2** (Menu).

10:00 am	FWD Rdy	Home
Freq Reference (AI)		
U1-01	Hz	0.00
Output Frequency		
U1-02	Hz	0.00
Output Current		
U1-03	A	0.00
JOG	Menu	FWD/REV

3. Press  or  to select [Auto-Tuning], and press .

10:00 am	FWD	Menu
Parameters		
User Custom Parameters		
Parameter Backup/Restore		
Modified Param / Fault Log		
Auto-Tuning		
Initial Setup		
Home		





4. Press .

10:00 am	FWD	Auto Tuning
Select Auto-Tuning mode		
Motor Parameter Tuning		
Back		
Home		

5. Press  or  to select [Rotational Auto-Tuning], and press .

10:00 am	FWD	Auto Tuning
Select Auto-Tuning method		
Rotational Auto-Tuning		
Stationary Auto-Tuning		
Stationary Line-Line Resistance		
Back		
Home		

6. Follow along with the messages displayed on the keypad to input the data required for Auto-Tuning.

Ex.: Press  or  to select the digit, then use or  to change the numeric value. Then, press  to confirm the numeric value and go to the next entry field.

10:00 am	FWD	Auto Tuning
Enter motor rated power in kw		
007.50 kw		
Range : 0.00~650.00		
Back		
Home		

7. Follow the messages displayed on the keypad to carry out the steps that follow.

8. When the auto-tuning start screen appears, press .

10:00 am	FWD	Auto Tuning
Auto-Tuning		
Make sure the state of the motor and it is OK to run.		
Press "Run" to proceed		
Back		
Home		

Auto-Tuning begins.

With Rotational Auto-Tuning, the motor does not rotate immediately. It will begin rotating after power has been applied for about one minute.

9. After about 1 to 2 minutes, Auto-Tuning will complete, and the following screen will appear. Press or .

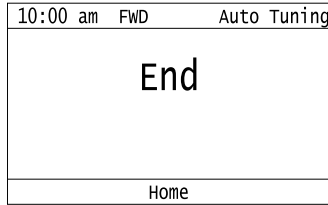

A list of the parameters that were changed as the result of Auto-Tuning will be displayed.

10. In the parameter change confirmation screen, press or to check the changed parameters. Then, select [End Tuning] at the bottom of the screen and press .

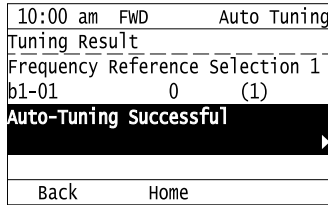

To change a parameter again, press or to select the parameter to revise, and press . The parameter setting screen appears.

Auto-Tuning is now complete.

Note:

During Auto-Tuning, if for example is pressed or an error is detected, an error code will be displayed on the keypad and Auto-Tuning will be discontinued. "Endx" is displayed if, after Auto-Tuning is completed, there appears to be a discrepancy in the tuning results. Check the cause of the error and perform Auto-Tuning again after fixing the cause, or set the motor parameters manually. Even if "Endx" is displayed, if it is inferred based on the cause of the detection that an error has not occurred, use the measurement results obtained from Auto-Tuning as is. Er-xx is displayed if Auto-Tuning did not end normally. Check for the cause of the error and perform Auto-Tuning again after fixing the cause.

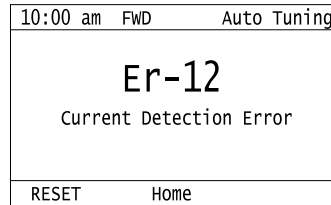
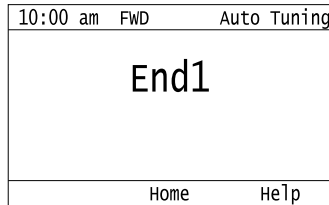

◆ Select Language of Display for Keypad

The following explains how to select the language displayed on the keypad.



1. Press (Home) to display the HOME screen.





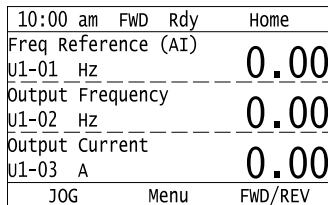

Note:



- [Home] appears in the upper right hand corner of the screen when in HOME mode.
- If [Home] is not displayed for , press (Back), and then press to display [Home].

2. Press (Menu).





3. Press  or  to select [Initial Settings], and press .

10:00 am	FWD	Menu
	User Custom Parameters	
	Parameter Backup/Restore	
	Modified Param / Fault Log	
	Auto-Tuning	
	Initial Setup	
	D diagnostic Tools	
	Home	

4. Press  or  to select [Language Selection], and press .

10:00 am	FWD	Init Setup
	Language Selection	
	Set Date/Time	
	Setup Wizard	
	Initial Setup Display Select	
	Back	Home

5. Press  or  to select the language, and press .

10:00 am	FWD	Init Setup
	Language Selection	
	English	
	Japanese	
	Deutsch	
	Frangais	
	Italiano	
	Back	Home

This completes the procedure for selecting the language.

◆ Set the Date and Time



The following explains how to set the date and time.

Note:

- Refer to “Replace the Keypad’s Battery” for details on the battery installation procedure. After installing the battery, set $o4-24 = 1$ [*bAT Detection selection = Enable*].
- If the clock-use battery has not been installed in the keypad, the date and time will need to be set when the drive is energized again after it was de-energized.

- Press  (Home) to display the HOME screen.







Note:



- [Home] appears in the upper right hand corner of the screen when in HOME mode.
- If [Home] is not displayed for , press  (Back), and then press  to display [Home].

- Press  (Menu).



10:00 am	FWD	Rdy	Home
	Freq Reference (AI)		0.00
	U1-01 Hz		0.00
	Output Frequency		0.00
	U1-02 Hz		0.00
	Output Current		0.00
	U1-03 A		0.00
	JOG	Menu	FWD/REV

- Press  or  to select [Initial Settings], and press .

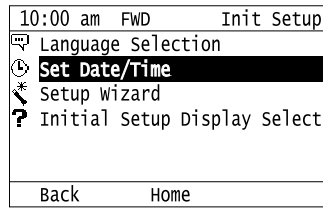

10:00 am	FWD	Menu
	User Custom Parameters	
	Parameter Backup/Restore	
	Modified Param / Fault Log	
	Auto-Tuning	
	Initial Setup	
	D diagnostic Tools	
	Home	

4. Press  or  to select [Set Date/Time], and press .



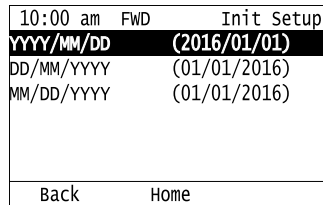



5. Press  or  to select the format of date display, and press .

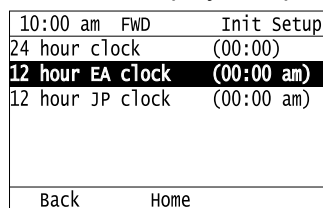

6. Press  or  to select the format of time display, and press .





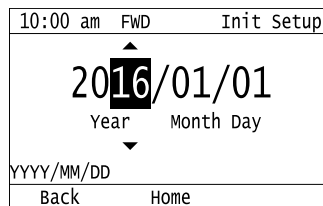

7. Press  or  to select yyyy/mm/dd, then use  or  to change the value.

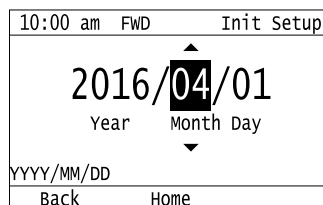

8. When done changing the value, press .



9. Press  or  to select the hour or minute, then use  or  to change the value.

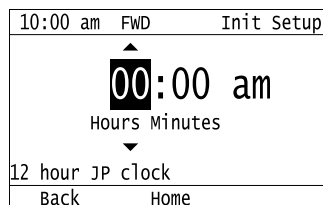

10. Once the time has been set, press .

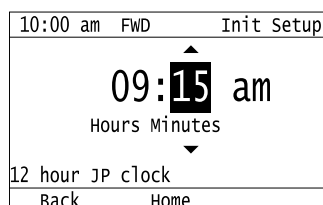

This completes the procedure for setting the date and time.

◆ Use Setup Wizard to Set Parameters

The following basic parameters can be easily set using the Setup Wizard. All that is needed is to follow along with the messages displayed on the keypad and perform the necessary operations.

- Frequency reference source
- Input signal level
- Run command source
- Duty Rating
- Motor Type
- Control method
- Maximum Frequency
- Input/Output Settings

1. Press **F2** (Home) to display the HOME screen.

Note:

- [Home] appears in the upper right hand corner of the screen when in HOME mode.
- If [Home] is not displayed for **F2**, press **F1** (Back), and then press **F2** to display [Home].

2. Press **F2** (Menu).

10:00 am	FWD	Rdy	Home
Freq Reference (AI)			
U1-01	Hz		0.00
Output Frequency			
U1-02	Hz		0.00
Output Current			
U1-03	A		0.00
JOG	Menu	FWD/REV	

3. Press **▲** or **▼** to select [Initial Settings], and press **↵**.

10:00 am	FWD	Menu
🔧	User Custom Parameters	
🔄	Parameter Backup/Restore	
⚠	Modified Param / Fault Log	
🔧	Auto-Tuning	
📄	Initial Setup	▶
🔧	Dagnostic Tools	
Home		

4. Press **▲** or **▼** to select [Setup Wizard], and press **↵**.

10:00 am	FWD	Init Setup
🗨	Language Selection	
🕒	Set Date/Time	
🔧	Setup Wizard	▶
?	Initial Setup Display Select	
Back Home		

5. Press **▲** or **▼** to select the item to be set, and press **↵**.

10:00 am	FWD	wizard
Select speed reference source		
🔧	Keypad	▶
	Analog Input	
	Memobus/Modbus Communications	
	Option PCB	
Back Home		

- Follow the instructions shown by the keypad for the steps that follow, until the “Parameter Change Confirmation Screen” is displayed.

10:00 am FWD wizard
Pending Parameter Changes
Control Method Selection
A1-02 0 (2)
Frequency Reference Selection 1
b1-01 0 (1)
Back Home

- In the parameter change confirmation screen, press or to check the changed parameter. Then, select [Confirm Parameter] at the bottom of the screen and press .

10:00 am FWD wizard
Pending Parameter Changes
Frequency Reference Selection 1
b1-01 0 (1)
Apply of each parameter
Back Home

Note:

To change a parameter again, press or to select the parameter to revise, and press . The parameter setting screen appears.

- Press or to select [Yes], and press .

10:00 am FWD wizard
Would you like to apply the parameter settings?
No
Yes
Back Home

This completes the procedure for using the Setup Wizard to make settings.

◆ Disable the Start-Up Screen

Refer to the following procedures to stop the initial start-up screen from being displayed when the drive is energized.

- Press (Home) to display the HOME screen.

Note:

- [Home] appears in the upper right hand corner of the screen when in HOME mode.
- If [Home] is not displayed for , press (Back), and then press to display [Home].

- Press (MENU).

10:00 am FWD Rdy Home
Freq Reference (AI)
U1-01 Hz 0.00
Output Frequency
U1-02 Hz 0.00
Output Current
U1-03 A 0.00
JOG Menu FWD/REV

- Press / to select [Initial Settings], and press .

10:00 am FWD Menu
User Custom Parameters
Parameter Backup/Restore
Modified Param / Fault Log
Auto-Tuning
 Initial Setup
Diagnostic Tools
Home

4. Press to select [Initial Start-Up Screen Selection], and press .

10:00 am	FWD	Init Setup
	Language Selection	
	Set Date/Time	
	Setup Wizard	
	Initial Setup Display select	
Back Home		

5. Press to select [No], and press .

10:00 am	FWD	Init Setup
Initial setup display select		
No		
Yes		
Back Home		

- [No]: Start-up screen is not displayed on keypad when the drive starts up.
- [Yes]: Start-up screen is displayed on keypad when the drive starts up.

◆ Start Data Logging

The data logging function keeps a record of the status of the drive. Monitor $Ux-xx$ is made the target of data logging. The following explains how to start the logging of data.

Up to a maximum of 10 monitors can be recorded.

1. Confirm that a microSD card is inserted in the keypad.
2. Press (Home) to display the HOME screen.

Note:

- [Home] appears in the upper right hand corner of the screen when in HOME mode.
- If [Home] is not displayed for , press (Back), and then press to display [Home].

3. Press (Menu).

10:00 am	FWD	Rdy	Home
Freq Reference (AI)			
U1-01	Hz	0.00	
Output Frequency			
U1-02	Hz	0.00	
Output Current			
U1-03	A	0.00	
JOG	Menu	FWD/REV	

4. Press or to select [Tools], and press .

10:00 am	FWD	Menu
	User Custom Parameters	
	Parameter Backup/Restore	
	Modified Param / Fault Log	
	Auto-Tuning	
	Initial Setup	
	Diagnostic Tools	
Home		

5. Press or to select [Data Log], and press .

10:00 am	FWD	Tools
Data Log		
Backlight		
Drive Information		
Back Home Setup		

6. Press  or  to select [Yes] or [No], and press .

10:00 am FWD	Tools
Data Log Start?	
Yes	▶
No	
Back	Home

- [Yes]: Data logging starts.
- [No]: No data logging. If the data logging function is already being used, it is stopped.



◆ Set Data to Log

■ Set Monitor to Log

The following explains how to set the monitor for which data is to be logged.



1. Press  (Home) to display the HOME screen.







Note:

- [Home] appears in the upper right hand corner of the screen when in HOME mode.
- If [Home] is not displayed for , press  (Back), and then press  to display [Home].

2. Press  (Menu).

10:00 am FWD Rdy	Home
Freq Reference (AI)	
U1-01 Hz	0.00
Output Frequency	
U1-02 Hz	0.00
Output Current	
U1-03 A	0.00
JOG	Menu FWD/REV

3. Press  or  to select [Tools], and press .

10:00 am FWD	Menu
 User Custom Parameters	
 Parameter Backup/Restore	
 Modified Param / Fault Log	
 Auto-Tuning	
 Initial Setup	
 Diagnostic Tools	▶
Home	

4. Press  or  to select [Data Log], and press  (Setup).

10:00 am FWD	Tools
Data Log	▶
Backlight	
Drive Information	
Back	Home Setup

5. Press  or  to select [Data Log Permit], and press .

10:00 am FWD	Setup
Log Monitor	▶
Log Sampling Interval	
Back	Home

6. Press  or  to select the save-destination monitor parameter, and press .

10:00 am	FWD	Setup
Log Monitor		
Log Monitor Data 1		
o5-03	101	(101)
Log Monitor Data 2		
o5-04	102	(102)
Back	Home	

7. Press  or  to select the monitor number to be logged, and press .

10:00 am	FWD	Parameters
Log Monitor Data 1		
o5-03	101	
Freq Reference		
Default : 101		
Back	Default	



This completes the settings procedure.

■ Setting the Sampling Time

The following explains how to set the sampling time for data logging.



1. Press  (Home) to display the HOME screen.







Note:

- [Home] appears in the upper right hand corner of the screen when in HOME mode.
- If [Home] is not displayed for , press  (Back), and then press  to display [Home].

2. Press  (Menu).

10:00 am	FWD	Rdy	Home
Freq Reference (AI)			
U1-01	Hz		0.00
Output Frequency			
U1-02	Hz		0.00
Output Current			
U1-03	A		0.00
JOG	Menu	FWD/REV	

3. Press  or  to select [Tools], and press .

10:00 am	FWD	Menu
	User Custom Parameters	
	Parameter Backup/Restore	
	Modified Param / Fault Log	
	Auto-Tuning	
	Initial Setup	
	Diagnostic Tools	▶
	Home	

4. Press  or  to select [Data Log], and press  (Setup).

10:00 am	FWD	Tools
Data Log ▶		
Backlight		
Drive Information		
Back	Home	Setup

5. Press  or  to select [Data Log Sampling Time Setting], and press .

10:00 am	FWD	Setup
Log Monitor		
Log Sampling Interval ▶		
Back	Home	

6. Press or to select the digit, then use or to change the value.

10:00 am	FWD	Parameters
Log Sampling Interval		
05-02	0 1000	ms
Default : 1000ms		
Range : 100~60000		
Back	Default	Min/Max

7. When done changing the value, press .

10:00 am	FWD	Parameters
Log Sampling Interval		
05-02	20 000	ms
Default : 1000ms		
Range : 100~60000		
Back	Default	Min/Max

This completes the procedure for setting the sampling time.

◆ Set Backlight to Be Automatically OFF

Screen backlighting can be set so it switches off after a set period of time has passed since the last keypress on the keypad. The following explains how to make the lit/OFF setting for the backlight.

1. Press (Home) to display the HOME screen.

Note:

- [Home] appears in the upper right hand corner of the screen when in HOME mode.
- If [Home] is not displayed for , press (Back), and then press to display [Home].

2. Press (Menu).

10:00 am	FWD	Rdy	Home
Freq Reference (AI)			
U1-01	Hz		0.00

Output Frequency			
U1-02	Hz		0.00

Output Current			
U1-03	A		0.00
JOG	Menu	FWD/REV	

3. Press or to select [Tools], and press .

10:00 am	FWD	Menu
User Custom Parameters		
Parameter Backup/Restore		
Modified Param / Fault Log		
Auto-Tuning		
Initial Setup		
Diagnostic Tools		
Home		

4. Press or to select [Backlight], and press .

10:00 am	FWD	Tools
Data Log		
Backlight		
Drive Information		
Back	Home	Setup

5. Press  or  to select [ON] or [OFF], and press .

10:00 am FWD	Tools
LCD backlight ON/OFF Selection	
OFF	
ON	
Back	Home





- [ON]: Backlight is constantly lit.
- [OFF]: Backlight switches off after set period of time passes.

6. Press  (Setup).

10:00 am FWD	Tools
Data Log	
Backlight	
Drive Information	
Back	Home Setup

7. Press .

10:00 am FWD	Setup
Energy Saving	
Time to turn off LCD backlight	
01-38 60 (60)sec	
Back	Home

8. Press  or  to select the digit, then use  or  to change the value.

10:00 am FWD	Parameters
Time to turn off LCD backlight	
01-38 060 sec	
Default : 60sec	
Range : 10~300	
Back	Default Min/Max

9. When done changing the value, press .

10:00 am FWD	Parameters
Time to turn off LCD backlight	
01-38 030 sec	
Default : 60sec	
Range : 10~300	
Back	Default Min/Max



This completes the setting for automatic extinction of backlight.

◆ Display the Drive Information

The drive's model name, maximum applicable motor output (HD/ND), rated output current (HD/ND), and the software version can be displayed.

1. Press  (Home) to display the HOME screen.



Note:

- [Home] appears in the upper right hand corner of the screen when in HOME mode.
- If [Home] is not displayed for , press  (Back), and then press  to display [Home].

3.6 Keypad Operation

2. Press **F2** (Menu).

10:00 am	FWD	Rdy	Home
Freq Reference (AI)		0.00	
U1-01 Hz		0.00	
Output Frequency		0.00	
U1-02 Hz		0.00	
Output Current		0.00	
U1-03 A		0.00	
JOG	Menu	FWD/REV	

3. Press  or  to select [Tools], and press .

10:00 am	FWD	Menu
User Custom Parameters		
Parameter Backup/Restore		
Modified Param / Fault Log		
Auto-Tuning		
Initial Setup		
Diagnostic Tools		
Home		

4. Press  or  to select [Drive Info], and press .

10:00 am	FWD	Tools
Data Log		
Backlight		
Drive Information		
Back		
Home		

The drive information is displayed as follows.

10:00 am	FWD	Tools	
GA700			A
200v, 22.0/30.0kw			B
88.00/110.0A			C
<VSAA01010>			D
Back			
Home			

A - Model Name

B - Maximum Applicable Motor Output (HD/ND)

C - Rated Output Current (HD/ND)

D - Software version

3.7 Automatic Parameter Settings Optimized for Specific Applications

The drive comes with the following application presets. Parameters related to the selected application will automatically be set to the optimum values. To check the parameter settings that have automatically been changed as the result of executing the application selection function by means of *A1-06*, refer to [User Parameters] on the main menu.

Note:

Be sure to initialize parameters by setting *A1-03* = 2220, 3330 [Initialize Parameters = 2-wire sequence, 3-wire sequence] prior to setting *A1-06*.

The procedure is shown in the following.

1. Press **F2** (Home) to display the HOME screen.

Note:

- [Home] appears in the upper right hand corner of the screen when in HOME mode.
- If [Home] is not displayed for **F2**, press **F1** (Back), and then press **F2** to display [Home].

2. Press **F2** (Menu).

10:00 am	FWD	Rdy	Home
Freq Reference (AI)			
U1-01	Hz		0.00
Output Frequency			
U1-02	Hz		0.00
Output Current			
U1-03	A		0.00
JOG	Menu	FWD/REV	

3. Press **▲** or **▼** to select [Set Parameter], and press **↵**.

10:00 am	FWD	Menu
Monitors		
Parameters		
User Custom Parameters		
Parameter Backup/Restore		
Modified Param / Fault Log		
Auto-Tuning		
Home		

4. Press **▲** or **▼** to select [A Environment Settings], and press **↵**.

10:00 am	FWD	Parameters
A Initialization Parameters		
b Application		
C Tuning		
d References		
E Motor Parameters		
F Options		
Back	Home	

5. Press **▲** or **▼** to select [A Environment Settings Mode], and press **↵**.

10:00 am	FWD	Parameters
A1 Initialization		
A2 User Parameters		
Back Home		

6. Press **▲** or **▼** to select *A1-06*, and press **↵**.

10:00 am	FWD	Parameters
Password		
A1-04	0	(0)
Application Preset		
A1-06	1	(0)
DriveWorkSEZ Function Selection		
A1-07	0	(0)
Back Home		

7. Press  or  to change the value, and press .

10:00 am FWD	Parameters
Application Preset	
A1-06	3
Exhaust fan	
Default : 0	
Back	Default

This completes the parameter setting procedure.

Note:

- Be sure to perform Auto-Tuning after setting *A1-06* for a hoist application.
- It is not possible to change the value set in *A1-06*. To select another application preset, initialize parameters first by setting *A1-03* = 2220 and then make another selection to *A1-06*. It is not necessary to change settings if initializing all parameters will create a problem.
- Parameters automatically registered to *A2-17* to *A2-32* [*User Parameters*] by setting *A2-33* = 1 [*User Parameter Auto Selection = Enabled*] will be reset when changing the setting of *A1-06*.

3.8 Auto-Tuning

Auto-Tuning automatically measures the motor characteristics needed for vector control and sets the drive accordingly. Select the optimum Auto-Tuning method after carefully considering the type of motor being used, the drive's control method, and the installation environment for the motor.

Messages prompting the input for necessary parameters will be displayed on the keypad. This will be in accordance with the selected Auto-Tuning method and the control method setting that's been made for A1-02.

WARNING! When performing Rotational Auto-Tuning, the motor rotates at a frequency that is 50% or more of the rated frequency of the motor. Make sure that there are no issues related to safety in the surrounding area. Failure to comply may result in death or serious injury and damage to machinery.

◆ Auto-Tuning for Induction Motors

The following explains the method of Auto-Tuning for induction motors. Set the following parameters for Auto-Tuning.

- Motor parameters $E1-xx$, $E2-xx$ (for motor 2 $E3-xx$, $E4-xx$)
- Speed feedback detection-use $F1-xx$ (only with Closed Loop Vector Control)

Note:

Stationary Auto-Tuning is used as a replacement measure when Rotational Auto-Tuning cannot be carried out. Consequently, a large discrepancy between the measured results and the motor characteristics could be observed when the Auto-Tuning is complete. After performing Stationary Auto-Tuning, check the parameters for the measured motor characteristics.

Table 3.7 Auto-Tuning for Induction Motors

Method	Parameter Settings	Applicable When/Advantages	Applicable Control Methods (Value set in A1-02)				
			V/f (0)	CL-V/f (1)	OLV (2)	CLV (3)	AOLV (4)
Rotational Auto-Tuning	T1-01 = 0	<ul style="list-style-type: none"> • Motor can be decoupled from machinery and rotate freely while Auto-Tuning is performed • When running motors having fixed output characteristics • When using motors requiring high-precision control • To assure high-precision motor control, if at all possible Rotational Auto-Tuning should be carried out. • Motor and load cannot be decoupled but the motor load is below 30%. 	x	x	x	x	x
Stationary Auto-Tuning 1	T1-01 = 1	<ul style="list-style-type: none"> • When motor cannot be decoupled from machinery • When information from the motor's test report or nameplate is not available <p>Note: With Stationary Auto-Tuning, the drive remains stopped while it is energized for about 1 minute. During this time the necessary motor parameters are automatically measured.</p>	-	-	x	x	x
Stationary Auto-Tuning for Line-to-Line Resistance	T1-01 = 2	<ul style="list-style-type: none"> • After Auto-Tuning was carried out, the wiring distance between the drive and motor changed by 50 m or more. • When the wiring distance exceeds 50 m with V/f Control method • When the motor output and drive capacity are different 	x	x	x	x	x

■ Input Data for Induction Motor Auto-Tuning

To perform Auto-Tuning, input data for the items marked with "x" in the following chart. Before starting Auto-Tuning, the motor's test report or nameplate should be available for ready reference.

Table 3.8 Input Data for Induction Motor Auto-Tuning

Input Data	Parameters	Unit	Auto-Tuning Method (Value set in T1-01)		
			Rotational Auto-Tuning (0)	Stationary Auto-Tuning 1 (1)	Stationary Auto-Tuning for Line-to-Line Resistance (2)
Motor Rated Power	T1-02	kW	x	x	x
Motor Rated Voltage	T1-03	V	x	x	-
Motor Rated Current	T1-04	A	x	x	x
Motor Base Frequency	T1-05	Hz	x	x	-
Number of Motor Poles	T1-06	-	x	x	-
Motor Base Speed	T1-07	min ⁻¹	x	x	-
PG Number of PulsesPerRevolution	T1-08	-	x *1	x *1	-
Motor No-Load Current	T1-09	A	-	x	-

*1 Input this when using a setting of A1-02 = 7 [Control Method Selection = PM Closed Loop Vector Control].

◆ Auto-Tuning for PM Motors

The following explains the method of Auto-Tuning for PM motors. Set the following parameters for Auto-Tuning.

- Motor parameters E1-xx, E5-xx
- Speed feedback detection-use F1-xx (only with Closed Loop Vector Control method for PM)

Table 3.9 Auto-Tuning for PM Motors

Method	Parameter Settings	Applicable When/Advantages	Applicable Control Methods (Value set in A1-02)		
			OLV/PM (5)	AOLV/PM (6)	CLV/PM (7)
PM Motor Parameter Settings	T2-01 = 0	<ul style="list-style-type: none"> • When information from the motor's test report or nameplate is available. • Rotational/Stationary Auto-Tuning that energizes the motor is not carried out. Manually input the necessary motor parameters. 	x	x	x
PM Stationary Auto-Tuning	T2-01 = 1	<ul style="list-style-type: none"> • When information from the motor's test report or nameplate is not available. <p>Note: With Stationary Auto-Tuning, the drive remains stopped while it is energized for about 1 minute. During this time the necessary motor parameters are automatically measured.</p>	x	x	x
PM Stationary Auto-Tuning for Stator Resistance	T2-01 = 2	<ul style="list-style-type: none"> • After Auto-Tuning was carried out, the wiring distance between the drive and motor changed by 50 m or more. • When the motor output and drive capacity are different. 	x	x	x

Method	Parameter Settings	Applicable When/Advantages	Applicable Control Methods (Value set in A1-02)		
			OLV/PM (5)	AOLV/PM (6)	CLV/PM (7)
Z Pulse Offset Tuning	T2-01 = 3	<ul style="list-style-type: none"> When the encoder Z-pulse offset is unknown. When encoder was replaced Deviation from Z phase ($\Delta\theta$) is compensated for. Note: Motor rotates slowly while encoder base position is measured.	-	-	x
PM Rotational Auto-Tuning	T2-01 = 4	<ul style="list-style-type: none"> When information from the motor's test report or nameplate is not available. Motor can be decoupled from machinery and rotate freely while Auto-Tuning is performed. Values measured during Auto-Tuning are automatically set to the motor parameters. 	x	x	x

■ Input Data for PM Motor Auto-Tuning

To perform Auto-Tuning, input data for the items marked with "x" in the following chart. Before starting Auto-Tuning, the motor's test report or nameplate should be available for ready reference.

Table 3.10 Input Data for PM Motor Auto-Tuning

Input Data	Parameters	Unit	Auto-Tuning Method (Value set in T2-01)									
			PM Motor Parameter Settings (0)			PM Stationary Auto-Tuning (1)		PM Stationary Auto-Tuning for Stator Resistance (2)	Z Pulse Offset Tuning (3)	PM Rotational Auto-Tuning (4)		
Control method	A1-02	-	5, 6, 7	5	6, 7	5	6, 7	5, 6, 7	7	5	6	7
PM Motor Code Selection	T2-02	-	Motor code of Yaskawa motor ^{*7}	FFFF ^{*2}	FFFF ^{*2}	-	-	-	-	-	-	-
PM Motor Type	T2-03	-	-	-	-	x	x	-	-	x	x	x
PM Motor Rated Power	T2-04	kW	-	x	x	x	x	-	-	x	x	x
PM Motor Rated Voltage	T2-05	V	-	x	x	x	x	-	-	x	x	x
PM Motor Rated Current	T2-06	A	-	x	x	x	x	x	-	x	x	x
PM Motor Base Frequency	T2-07	Hz	-	x	-	x	-	-	-	x	-	-
Number of PM Motor Poles	T2-08	-	-	x	x	x	x	-	-	x	x	x
PM Motor Base Speed	T2-09	min ⁻¹	-	-	x	-	x	-	-	-	x	x
PM Motor Stator Resistance	T2-10	Ω	x	x	x	-	-	-	-	-	-	-

3.8 Auto-Tuning

Input Data	Parameters	Unit	Auto-Tuning Method (Value set in T2-01)									
			PM Motor Parameter Settings (0)			PM Stationary Auto-Tuning (1)		PM Stationary Auto-Tuning for Stator Resistance (2)	Z Pulse Offset Tuning (3)	PM Rotational Auto-Tuning (4)		
Control method	A1-02	-	5, 6, 7	5	6, 7	5	6, 7	5, 6, 7	7	5	6	7
PM Motor Code Selection	T2-02	-	Motor code of Yaskawa motor */	FFFF *2	FFFF *2	-	-	-	-	-	-	-
PM Motor d-Axis Inductance	T2-11	mH	x	x	x	-	-	-	-	-	-	-
PM Motor q-Axis Inductance	T2-12	mH	x	x	x	-	-	-	-	-	-	-
Induced Voltage Const Unit Select	T2-13	-	x	x	x	-	-	-	-	-	-	-
PM Motor Induced Voltage Const	T2-14	*3	x	x	x	-	-	-	-	-	-	-
Pull-InCurrentLv forPM Motor Tun	T2-15	%	-	-	-	x	x	-	-	x	x	x
PGNumOfPulses/Rev forPMMotor Tun	T2-16	-	*4	-	*4	-	*4	-	-	-	-	x
Encoder Z-Pulse Offset for PM Motor	T2-17	Degrees	*4	-	*4	-	*4	-	-	-	-	-

*1 When using a Yaskawa PM motor, set the motor code.

*2 When using a PM motor from another manufacturer, set the motor code to FFFF.

*3 Varies depending on a value set in T2-13.

*4 Set this when using a setting of A1-02 = 7 [Control Method Selection = PM Closed Loop Vector Control].

◆ EZ Tuning

The following explains the Auto-Tuning method used for EZ Open Loop Vector Control. Set the following parameters for Auto-Tuning.

Motor parameters E9-xx

Table 3.11 EZ Tuning Method

Method	Parameter Settings	Applicable When/Advantages	Applicable Control Methods (Value set in A1-02)
Motor constant setting Auto-Tuning	T4-01 = 0	<ul style="list-style-type: none"> This is a control method for induction motors and PM motors. Follow easy steps to achieve efficient drive of a motor. For derating torque applications such as fans and pumps. 	EZOLV (8)
Stationary Auto-Tuning for Line-to-Line Resistance	T4-01 = 1	<ul style="list-style-type: none"> After Auto-Tuning was carried out, the wiring distance between the drive and motor changed by 50 m or more. When the motor output and drive capacity are different. 	EZOLV (8)

■ Input Data for EZ Tuning

To perform Auto-Tuning, input data for the items marked with “x” in the following chart. Before starting Auto-Tuning, the motor’s test report or nameplate should be available for ready reference.

Table 3.12 Input Data for EZ Tuning

Input Data	Parameters	Unit	Auto-Tuning Method (Value set in T4-01)	
			Motor constant setting Auto-Tuning (0)	Stationary Auto-Tuning for Line-to-Line Resistance (1)
Motor Type Selection	T4-02	-	x	-
Motor Max Revolutions	T4-03	min ⁻¹	x	-
Motor Rated Revolutions	T4-04	min ⁻¹	x	-
Motor Rated Frequency	T4-05	Hz	x	-
Motor Rated Voltage	T4-06	V	x	-
Motor Rated Current	T4-07	A	x	x
Motor Rated Capacity	T4-08	kW	x	-
Number of Motor Poles	T4-09	-	x	-
Motor Rated Slip	T4-10	Hz	x	-
Motor Line Resistance	T4-11	Ω	x	-

◆ ASR and Inertia Tuning

To enhance the drive’s responsiveness and prevent hunting, use Auto-Tuning, which automatically adjusts the control-related parameters.

The following types of Auto-Tuning are available for the control system:

- Inertia Tuning
- ASR Tuning

Table 3.13 Method of Control Auto-Tuning

Method	Parameter Settings	Applicable When/Advantages	Applicable Control Methods (Value set in A1-02)	
			CLV (3)	CLV/PM (7)
Inertia Tuning	T3-00 = 0	<ul style="list-style-type: none"> To perform Feed Forward control When set to L2-29 = 1 [KEB Method Selection = Single Drive KEB Ride-Thru 2]. When set to MFDI H1-xx = 7A [KEB Ride-Thru 2 (N.C.)]. 	x	x
ASR Tuning	T3-00 = 1	Performing ASR gain Auto-Tuning based on the set response frequency (including Inertia Tuning)	x	x

Table 3.14 Input Data for Control Auto-Tuning

Input Data	Parameters	Unit	Auto-Tuning Method (Value set in T3-00)	
			Inertia Tuning (0)	ASR Tuning (1)
Test Signal Frequency	T3-01	Hz	x	x
Test Signal Amplitude	T3-02	Rad	x	x
Motor Inertia	T3-03	Kg· m ²	x	x
System Response Frequency	T3-04	Hz	-	x

■ Inertia Tuning

Inertia Tuning measures the motor load inertia value based on the motor speed and torque reference. It then automatically sets the drive parameters related to the inertia ratio of the machinery and motor. Inertia Tuning is used when carrying out Feed Forward control or when set to H1-xx = 7A [MFDI = KEB Ride-Thru 2 (N.C.)].

Through identification of load inertia and optimization of speed loop gain and feed-forward gain, even higher level control capabilities can be achieved. Moreover, speed response can be set without regard to the load, so accuracy when synchronizing multiple drives is enhanced. Since motor operation can continue without interruption even if power outages occur, the deceleration curve for features such as the KEB Ride-Thru function, which produces a ramp to stop, can be maintained in an optimal way.

■ ASR Tuning

In a manner similar to that of Inertia Tuning, ASR Tuning measures the load inertia value of the motor and automatically sets the parameters accordingly. Additionally, an automatic adjustment is carried out after calculating the proportional gain of speed control (ASR), based on the measured load inertia value.

The following parameters are set automatically when Inertia Tuning or ASR Tuning is carried out.

Parameters that are set automatically	Inertia Tuning	ASR Tuning
C5-01 [ASR Proportional Gain 1 (P)]	-	x
C5-17 [Motor Inertia]	x	x
C5-37 [Motor 2 Inertia]	x	x
C5-18 [Load Inertia Ratio]	x	x
C5-38 [Motor 2 Load Inertia Ratio]	x	x
L3-24 [Motor Accel Time for Inertia Cal]	x	x
L3-25 [Load Inertia Ratio]	x	x
n5-02 [Motor Acceleration Time]	x	x
n5-03 [Feed Forward Control Gain]	x	x

◆ Precautions to Note before Auto-Tuning

Check the following points before starting Auto-Tuning.

■ General Precautions Related to Auto-Tuning

- To carry out Auto-Tuning for a drive, it is necessary to input data from the motor's test report or from its nameplate. Before starting Auto-Tuning, such data should already be prepared and kept at hand.
- To increase the accuracy of Auto-Tuning, see that the input power supply voltage for the drive exceeds the rated voltage of the motor.

Note:

If the speed or torque needs to be accurate in the high-speed range (exceeding approximately 90% of the rated rotation speed), select a motor with a rated voltage that is lower than the input power supply of the drive by more than 20 V (200 V class) or 40 V (400 V class). If the input power supply and the motor rated voltage are identical, the drive's output voltage will be deficient, making it difficult to obtain optimal performance.

- To halt Auto-Tuning while in progress, you must press the  on the keypad.
- If a Safe Disable input signal is input to the drive during Auto-Tuning, Auto-Tuning measurements cannot be carried out normally. In such cases, cancel the Auto-Tuning, then execute it again from the start.
- The status of input/output terminals during Auto-Tuning is shown in [Table 3.15](#).

Table 3.15 Status of Input/Output Terminals during Auto-Tuning

Motor Type	Method		Multi-function Input	Multi-function Output ^{*1}
Induction Motor	Rotation Speed	Rotational Auto-Tuning	Rejected	Same as with normal operation
		Inertia Tuning	Rejected	Same as with normal operation
		ASR Tuning	Rejected	Same as with normal operation
	Stationary	Stationary Auto-Tuning	Rejected	Status at start of tuning maintained
		Stationary Auto-Tuning for Line-to-Line Resistance	Rejected	Status at start of tuning maintained
PM motor	Rotation Speed	Z Pulse Offset Tuning	Rejected	Status at start of tuning maintained
		PM Rotational Auto-Tuning	Rejected	Same as with normal operation
		Inertia Tuning	Rejected	Same as with normal operation
		ASR Tuning	Rejected	Same as with normal operation
	Stationary	PM Motor Parameter Settings	Rejected	Rejected
		PM Stationary Auto-Tuning	Rejected	Status at start of tuning maintained
		PM Stationary Auto-Tuning for Stator Resistance	Rejected	Status at start of tuning maintained

*1 A terminal to which H2-xx = E [MFDO Terminal = Fault] is assigned will behave in the same manner as it would during normal operation.

WARNING! Sudden Movement Hazard. Make sure that the holding break does not open during Auto-Tuning when only performing Stationary Auto-Tuning for Line-to-Line Resistance with the machine connected to the motor. The sequence should be wired so that a multi-function output terminal does not cause the holding brake to be released during Auto-Tuning. Failure to do so may result in damage to the machine or personal injury.

WARNING! Sudden Movement Hazard. Disconnect the load from the motor when performing Rotational Auto-Tuning. Failure to comply could cause death or serious injury and damage machinery.

WARNING! Burn Hazard. When performing Rotational Auto-Tuning, the motor rotates at a frequency that is 50% or more of the rated frequency of the motor. Make sure that there are no issues related to safety in the surrounding area. Failure to comply may result in death or serious injury and damage to machinery.

NOTICE: Crush Hazard. When executing PM Rotational Auto-Tuning, voltage is applied to the motor before the motor rotates. Do not touch the motor until Auto-Tuning is completed. If PM Rotational Auto-Tuning is performed, the motor will remain stopped for approximately one minute with power applied and then the motor will rotate for one minute. Failure to comply could result in serious injury.

■ Precautions to Note before Rotational Auto-Tuning

WARNING! Electrical Shock Hazard. When executing Rotational Auto-Tuning, voltage is applied to the motor before the motor rotate. Do not touch the motor until Auto-Tuning is completed. Failure to comply may result in injury or death from electrical shock.

- To execute Rotational Auto-Tuning, be sure that the drive is uncoupled from the motor. Otherwise, the drive may malfunction. If Rotational Auto-Tuning is carried out with respect to a motor that is connected to a load, the motor parameters will not be correctly calculated, and the motor could behave abnormally.
- However, if the load is 30% or less of the motor's duty rating, Auto-Tuning can be carried out while the motor is connected to the load. If Rotational Auto-Tuning is carried out while connected to a load that is greater than 30%, not only will the correct acquisition of motor parameters be impossible, but it can be dangerous because the motor may rotate abnormally.
- Check to make sure that the motor's magnetic brake is released.
- Make sure that external force from the machinery will not cause the motor to rotate.

■ Precautions to Note before Stationary Auto-Tuning

- Confirm that the motor's magnetic brake is not open.
- Make sure that external force from the machinery will not cause the motor to rotate.

WARNING! *Electrical Shock Hazard. When executing Stationary Auto-Tuning, voltage is applied to the motor before the motor rotates.. Do not touch the motor until Auto-Tuning is completed. Failure to comply may cause electrical shock*

■ Precautions to Note before Stationary Auto-Tuning for Line-to-Line Resistance and Stator Resistance Auto-Tuning

Even when V/f Control is selected, if the motor cable is long (50 m or longer), Stationary Auto-Tuning for Line-to-Line Resistance should be carried out.

WARNING! *Electrical Shock Hazard. When executing Stationary Auto-Tuning, voltage is applied to the motor before the motor rotates.. Do not touch the motor until Auto-Tuning is completed. Failure to comply may cause electrical shock*

■ Precautions to Note before Inertia Tuning and ASR Tuning

Before performing Inertia Tuning or ASR Tuning, make sure that the following things are carried out.

WARNING! *Electrical Shock Hazard. When executing Rotational Auto-Tuning, voltage is applied to the motor before the motor rotate. Do not touch the motor until Auto-Tuning is completed. Failure to comply may result in injury or death from electrical shock.*

- Either perform rotational motor parameter tuning, or look at the motor's test report or nameplate and input the values manually.
- Check to make sure that the motor's magnetic brake is released.
- Connect the motor and load.
- Make sure that external force from the machinery will not cause the motor to rotate.
- Make sure that the machinery is not of the type for which reverse rotation is prohibited. Inertia Tuning and ASR Tuning cannot be carried out with machinery for which reverse rotation is prohibited.
- If it is all right for the motor to rotate during Auto-Tuning, check in the vicinity of the drive, motor, and machinery to make sure that there are no issues related to safety.

Note:

If there are gears between the machinery and motor shaft, the use of Inertia Tuning and ASR Tuning may not be appropriate.

3.9 Test Run

After using the Setup Wizard to make settings for the basic parameters, and Auto-Tuning of the motor has been completed, the next step is to perform a test run.

WARNING! Crash Hazard. Conduct test operations to make sure that the drive operates safely after writing work is completed and parameters have been set. Failure to comply may cause injury or damage to equipment.

◆ No-Load Test Run

Before connecting the motor with machinery, check the operation status of the motor.

■ Precautions to Note before Operation

Before rotating the motor, check the following items.

- Make sure there are no issues related to safety around the motor and machinery.
- Ensure that all emergency stop circuits and machine safety mechanisms are functioning correctly.

■ Items to Check before Operation

Before operation check the following items:

- Is the motor rotating in the forward direction?
- Is the motor rotating smoothly (no abnormal sounds or abnormal vibrations)?
- Does the motor accelerate/decelerate smoothly?

◆ Perform a No-Load Test Run

The basic steps to follow to perform a no-load test run are explained in the following.

1. Energize the drive, or press **F2** (Home) to display the HOME screen.
If [Home] is not displayed for **F2**, press **F1** (Back), and then press **F2** to display (Home).
2. Press **LO/RE** so the LOCAL/REMOTE indicator is lit.
3. Press **↶** to display *d1-01 [Reference 1]*, and set to 6.00 Hz.
4. Press **▶RUN**.
The RUN indicator lights, and the motor runs at 6.00 Hz in the forward direction.
5. Confirm that the motor is rotating in the correct direction and that there are no faults indicated by the drive.
If any faults were detected, eliminate their cause.

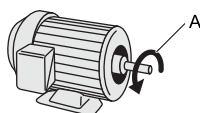

A - Forward Rotation of Motor (Counter Clockwise Direction as Seen from Load Shaft)

6. Raise the frequency reference value by pressing **▲**.
Change the setting value in increments of 10 Hz if needed while evaluating the response.
7. Check the drive's output current using *U1-03 [Output Current]* each time the setting value is raised.
The status is normal if the output current of the drive does not exceed the motor rated current.
Ex.: 6 Hz → 20 Hz → 30 Hz → 40 Hz → 50 Hz → 60 Hz
8. After confirming that the motor rotates normally, press **▶STOP**.
The RUN indicator will be flashing. Then, when the motor is completely stopped, it will go out.

◆ Actual-Load Test Run

After testing operation without a load, connect the motor and machinery to perform a test run.

■ Precautions to Note before Operation

- Make sure there are no issues related to safety around the motor and machinery.









- Confirm that the motor is completely stopped.
- Connect the motor with the machinery.
Confirm that none of the mounting screws are loose, and that the load shaft of the motor is securely joined with the machine coupling.
- As a precautionary safety measure in case of abnormal operation, make sure  of the keypad is at hand and can be pressed immediately.

■ Items to Check before Operation

- Check to make sure the direction of the machine's operation is correct (whether or not the motor will rotate in the correct direction).
- Does the motor accelerate/decelerate smoothly?

◆ Perform an Actual-Load Test Run

Once the motor and machinery have been connected, a test run should be carried out in accord with the same procedure that was used when performing a no-load test run.

- Confirm that *U1-03 [Output Current]* is not excessive.
 1. Energize the drive, or press  (Home) to display the HOME screen.
If [Home] is not displayed for , press  (Back), and then press  to display (Home).
 2. Set *d1-01 [Reference 1]* to 6.00 Hz.
 3. Press  so the LOCAL/REMOTE indicator is lit.
 4. Press .
The RUN indicator lights, and the motor runs at 6.00 Hz in the forward direction.
 5. Confirm that the motor is rotating in the correct direction and that there are no faults indicated by the drive.
If any faults were detected, eliminate their cause.
 6. Raise the frequency reference value by pressing .
Change the setting value in increments of 10 Hz if needed while evaluating the response.
 7. Check the drive's output current using *U1-03 [Output Current]* each time the setting value is raised.
The status is normal if the output current of the drive does not exceed the motor rated current.
Ex.: 6 Hz → 20 Hz → 30 Hz → 40 Hz → 50 Hz → 60 Hz
 8. After confirming that the motor rotates normally, press .
The RUN indicator will be flashing. Then, when the motor is completely stopped, it will go out.
 9. Change the frequency reference and direction of motor rotation, and check to see if there are any abnormal sounds or vibrations.
 10. If errors such as hunting or oscillation attributable to control functionality occur, adjust accordingly.

3.10 Fine Tuning during Test Runs (Adjustment of Control Functionality)

The following explains the adjustment procedures to follow when issues such as hunting or oscillation attributable to control functionality occur during a test run. Adjust the relevant parameters appearing in the chart, in accordance with the control method being used and the drive's status.

Note:

In this section, only the parameters that are frequently adjusted are listed. Please consult with a Yaskawa representative if adjustments having a higher degree of precision are required.

◆ V/f Control and Closed Loop V/f Control

Table 3.16 Parameters for Fine Tuning the Drive (V/f Control and Closed Loop V/f Control Methods)

Issue	Parameter Number	Solution	Default Setting	Suggested Setting
Hunting, oscillation at middle-range speeds (10 Hz to 40 Hz)	n1-02 [Hunting Prevention Gain Setting]	<ul style="list-style-type: none"> Reduce setting value when torque is insufficient with heavy loads. If hunting, oscillation occurs with light loads, increase the setting value. If hunting occurs with a low-inductance motor, such as a motor with a larger frame size or a high-frequency motor, lower the setting value. 	1.00	0.10 - 2.00
<ul style="list-style-type: none"> The motor excitation sound is significant. Hunting, oscillation at low speeds (10 Hz or lower), or at middle-range speeds (10 Hz to 40 Hz) 	C6-02 [Carrier Frequency Selection]	<ul style="list-style-type: none"> Raise the carrier frequency if the motor excitation sound is significant. Lower the carrier frequency if hunting or oscillation occurs at low or middle-range speeds. 	1(2 kHz) *1	1 to upper limit value
<ul style="list-style-type: none"> Torque, speed response is slow. Hunting, oscillation 	C4-02 [Torque Compensation Delay Time]	<ul style="list-style-type: none"> Reduce setting value when torque, speed response is slow. If hunting, oscillation occurs, increase the setting value. 	200 ms *2	100 - 1000 ms
<ul style="list-style-type: none"> Insufficient torque at low speeds (10 Hz or lower). Hunting, oscillation 	C4-01 [Torque Compensation Gain]	<ul style="list-style-type: none"> Increase setting value when torque is insufficient at low speeds. If hunting, oscillation occurs with light loads, reduce the setting value. 	1.00	0.50 - 1.50
<ul style="list-style-type: none"> Insufficient torque at low speeds (10 Hz or lower). Significant shock upon startup. 	<ul style="list-style-type: none"> E1-08 [Mid Point A Voltage] E1-10 [Minimum Output Voltage] 	<ul style="list-style-type: none"> Increase setting value when torque is insufficient at low speeds. Reduce setting value if there is marked shock upon drive startup. 	<ul style="list-style-type: none"> E1-08: 15.0 V *3 E1-10: 9.0 V *3 	Default setting +/- 5 V *4

3.10 Fine Tuning during Test Runs (Adjustment of Control Functionality)

Issue	Parameter Number	Solution	Default Setting	Suggested Setting
Speed accuracy is poor. (When using V/f Control Method)	C3-01 [Slip Compensation Gain]	After setting E2-01 [Motor Rated Current], E2-02 [Motor Rated Slip] and E2-03 [Motor No-Load Current], adjust C3-01.	0.0 (no slip compensation)	0.5 - 1.5
Speed accuracy is poor. (When using Closed Loop V/f Control Method)	<ul style="list-style-type: none"> C5-01 [ASR Proportional Gain 1 (P)] C5-02 [ASR Integral Time 1 (I)] *5 	Adjust C5-01, C5-02.	<ul style="list-style-type: none"> C5-01: 0.20 C5-02: 0.200 s 	<ul style="list-style-type: none"> Proportional gain = 0.10 to 1.00 Integral time = 0.100 to 2.000 s

*1 Differs depending on settings for o2-04 [Drive Model Selection] and C6-01 [Normal / Heavy Duty Selection], when at default settings.

*2 Differs depending on settings for A1-02 [Control Method Selection] and o2-04 [Drive Model Selection], when at default settings.

*3 Differs depending on settings for A1-02 [Control Method Selection] and E1-03 [V/f Pattern Selection], when at default settings.

*4 Suggested settings are for 200 V class drives. Voltage is double for 400 V class drives.

*5 When using Closed Loop V/f Control, ASR controls only the output frequency, so unlike Closed Loop Vector Control, a high-gain setting cannot be made.

◆ Open Loop Vector Control Method

With Open Loop Vector Control method, C4-01 [Torque Compensation Gain] should be left at its default setting (1.00). Do not adjust it.

If speed accuracy cannot be obtained during regeneration when using Open Loop Vector Control method, set C3-04 = 1 [Slip Compensation @ Regen Select = Enabled above 6 Hz].

Table 3.17 Parameters for Fine Tuning the Drive (Open Loop Vector Control Method)

Issue	Parameter Number	Solution	Default Setting	Suggested Setting
<ul style="list-style-type: none"> • Torque, speed response is slow. • Hunting, oscillation at middle-range speeds (10 Hz to 40 Hz) 	n2-01 [SpdFeedbackDetectCtr (AFR) Gain]	<ul style="list-style-type: none"> • To improve the torque, speed responsiveness, reduce the setting value in increments of 0.05. • If hunting, oscillation occurs, increase the setting value in increments of 0.05. 	1.00	0.50 - 2.00
	n2-02 [SpdFeedbackDetCtr (AFR)TimeConst1]	<ul style="list-style-type: none"> • To improve the torque, speed responsiveness, reduce the value in increments of 10 ms while evaluating the response. • If hunting, oscillation occurs, or if load inertia is excessive, raise the value in increments of 50 ms while evaluating the response. <p>Note: Always set this so that $n2-02 \leq n2-03$ [SpdFeedbackDetCtr (AFR)TimeConst2] holds true.</p> <p>Whenever n2-02 is adjusted, the value set for C4-02 [Torque Compensation Delay Time] must also be increased according to the same ratio.</p>	50 ms	50 - 2000 ms

3.10 Fine Tuning during Test Runs (Adjustment of Control Functionality)

Issue	Parameter Number	Solution	Default Setting	Suggested Setting
<p><i>ov [overvoltage]</i> occurs at the completion of acceleration, the beginning of deceleration, or when the load changes radically.</p>	n2-03 SpdFeedbackDetCtr (AFR)TimeConst2	<ul style="list-style-type: none"> When <i>ov</i> occurs, raise the value in increments of 50 ms while evaluating the response. If the response is deficient, reduce the value in increments of 10 ms while evaluating the response. <p>Note: Always set this so that $n2-02 [SpdFeedbackDetCtr (AFR)TimeConst1] \leq n2-03$ holds true. Whenever <i>n2-03</i> is adjusted, the value set for <i>C4-06 [Motor 2 Torque Comp Delay Time]</i> must also be increased according to the same ratio.</p>	750 ms	750 - 2000 ms
	C4-06 [Motor 2 Torque Comp Delay Time]	<ul style="list-style-type: none"> When <i>ov</i> occurs, raise the value in increments of 10 ms while evaluating the response. If the response is deficient, reduce the value in increments of 2 ms while evaluating the response. <p>Note: Always set this so that $C4-02 [Torque Compensation Delay Time] \leq C4-06$. Whenever <i>C4-06</i> is adjusted, the value set for $n2-03 [SpdFeedbackDetCtr (AFR)TimeConst2]$ must also be increased according to the same ratio.</p>	150 ms	150 - 750 ms
<ul style="list-style-type: none"> Torque, speed response is slow. Hunting, oscillation 	C4-02 [Torque Compensation Delay Time]	<ul style="list-style-type: none"> Reduce setting value in increments of 2 ms when torque, speed response is slow. If hunting, oscillation occurs, increase the setting value in increments of 10 ms. <p>Note: Always set this so that $C4-02 \leq C4-06 [Motor 2 Torque Comp Delay Time]$. Whenever <i>C4-02</i> is adjusted, the value set for $n2-02 [SpdFeedbackDetCtr (AFR)TimeConst1]$ must also be increased according to the same ratio.</p>	20 ms ^{*1}	20 - 100 ms ^{*1}
<ul style="list-style-type: none"> Speed response is slow. Speed is not stable. 	C3-02 [Slip Compensation Delay Time]	<ul style="list-style-type: none"> Reduce setting value in increments of 10 ms when speed response is slow. Increase setting value in increments of 10 ms if speed is not stable. 	200 ms ^{*1}	100 - 500 ms

Issue	Parameter Number	Solution	Default Setting	Suggested Setting
Speed accuracy is poor.	C3-01 [Slip Compensation Gain]	<ul style="list-style-type: none"> Increase setting value in increments of 0.1 if speed is slow. Reduce setting value in increments of 0.1 if speed is fast. 	1.0 *2	0.5 - 1.5
<ul style="list-style-type: none"> The motor excitation sound is significant. Hunting, oscillation at low speeds (10 Hz or lower) 	C6-02 [Carrier Frequency Selection]	<ul style="list-style-type: none"> Raise the carrier frequency if the motor excitation sound is significant. Lower the carrier frequency if hunting or oscillation occurs at low speeds. 	1(2 kHz) *3	0 to upper limit value
<ul style="list-style-type: none"> Insufficient torque at low speeds. Speed response is slow. Significant shock upon drive startup. 	<ul style="list-style-type: none"> E1-08 [Mid Point A Voltage] E1-10 [Minimum Output Voltage] 	<ul style="list-style-type: none"> Increase setting value when torque, speed response is slow. Reduce setting value if there is marked shock upon drive startup. <p>Note: If the setting value is set too high, a large torque reference may be output even with light loads.</p>	<ul style="list-style-type: none"> E1-08: 11.0 *2 E1-10: 2.0 *2 	Default setting +/- 2 V *4

- *1 Differs depending on settings for A1-02 [Control Method Selection] and o2-04 [Drive Model Selection], when at default settings.
- *2 Differs depending on settings for A1-02 [Control Method Selection] and E1-03 [V/f Pattern Selection], when at default settings.
- *3 Differs depending on settings for o2-04 [Drive Model Selection] and C6-01 [Normal / Heavy Duty Selection], when at default settings.
- *4 Suggested settings are for 200 V class drives. Voltage is double for 400 V class drives.

◆ Closed Loop Vector Control Method

Table 3.18 Parameters for Fine Tuning the Drive (Closed Loop Vector Control Method)

Issue	Parameter Number	Solution	Default Setting	Suggested Setting
<ul style="list-style-type: none"> Torque, speed response is slow. Hunting, oscillation 	<ul style="list-style-type: none"> High speed C5-01 [ASR Proportional Gain 1 (P)] Low speed C5-03 [ASR Proportional Gain 2 (P)] *1 	<ul style="list-style-type: none"> Increase setting value in increments of 5.00 when torque, speed response is slow. If hunting, oscillation occurs, reduce the setting value. 	20.00	10.00 - 50.00
	<ul style="list-style-type: none"> High speed C5-02 [ASR Integral Time 1 (I)] Low speed C5-04 [ASR Integral Time 2 (I)] *1 	<ul style="list-style-type: none"> Reduce setting value when torque, speed response is slow. If hunting, oscillation occurs, increase the setting value. 	0.500 s	0.300 to 1.000 seconds
ASR proportional gain or integral time cannot be established for low speed or high speed.	C5-07 [ASR Gain Switchover Frequency] *1	Change the ASR proportional gain and ASR integral time in accordance with the output frequency.	0.0 Hz	0.0 Hz to maximum output frequency

3.10 Fine Tuning during Test Runs (Adjustment of Control Functionality)

Issue	Parameter Number	Solution	Default Setting	Suggested Setting
Hunting, oscillation	C5-06 [ASR Delay Time] *1	<ul style="list-style-type: none"> Reduce setting value in increments of 0.010 when torque, speed response is slow. Raise setting value when vibration is likely to occur due to poor machine rigidity. 	0.004 s	0.004 to 0.020 seconds
<ul style="list-style-type: none"> The motor excitation sound is significant. Hunting, oscillation at low speeds (3 Hz or lower) 	C6-02 [Carrier Frequency Selection]	<ul style="list-style-type: none"> Raise the carrier frequency if the motor excitation sound is significant. Lower the carrier frequency if hunting or oscillation occurs at low speeds. 	1(2.0 kHz) *2	2.0 kHz to upper limit value

*1 For details on speed control (ASR), see the section where the *C5* parameter is explained.

*2 Differs depending on settings for *o2-04* [Drive Model Selection] and *C6-01* [Normal / Heavy Duty Selection], when at default settings.

◆ Advanced Open Loop Vector Control Method

Table 3.19 Parameters for Fine Tuning the Drive (Advanced Open Loop Vector Control Method)

Issue	Parameter Number	Solution	Default Setting	Suggested Setting
<ul style="list-style-type: none"> <i>oS</i> [Overspeed] occurs. Hunting, oscillation occurs. 	T1-01 [Auto-Tuning Mode Selection]	<ul style="list-style-type: none"> Confirm that the output of the drive and the motor are connected properly. Perform Rotational Auto-Tuning for the motor by itself. 	-	0
The motor excitation sound is significant.	C6-02 [Carrier Frequency Selection]	Raise the carrier frequency if the motor excitation sound is significant.	1(2 kHz) *1	1 to upper limit value
Improve speed accuracy	E2-02 [Motor Rated Slip]	<ul style="list-style-type: none"> Decouple the motor and machinery and perform Rotational Auto-Tuning. If the actual motor speed is slow, increase the value of <i>E2-02</i> in tiny increments (by approx. 0.1% of the default setting value). If the actual motor speed is fast, reduce the value of <i>E2-02</i> in tiny increments (by approx. 0.1% of the default setting value). 	*2	Adjust the value of <i>E2-02</i> that was automatically set as the result of Rotational Auto-Tuning within a range of $\pm 5\%$ of the current value.
<ul style="list-style-type: none"> Torque, speed response is slow. Hunting, oscillation 	<ul style="list-style-type: none"> High speed C5-01 [ASR Proportional Gain 1 (P)] Low speed C5-03 [ASR Proportional Gain 2 (P)] *3 	<ul style="list-style-type: none"> Increase setting value in increments of 5.00 when torque, speed response is slow. If hunting, oscillation occurs, reduce the setting value. 	20.00	10.00 - 50.00
	<ul style="list-style-type: none"> High speed C5-02 [ASR Integral Time 1 (I)] Low speed C5-04 [ASR Proportional Gain 2 (P)] *3 	<ul style="list-style-type: none"> Reduce setting value when torque, speed response is slow. If hunting, oscillation occurs, increase the setting value. 	0.500 s	0.300 to 1.000 seconds

Issue	Parameter Number	Solution	Default Setting	Suggested Setting
Speed response cannot be secured for low speed or high speed.	<ul style="list-style-type: none"> C5-07 [ASR Gain Switchover Frequency]^{*4} High speed C5-01 [ASR Proportional Gain 1 (P)] C5-02 [ASR Integral Time 1 (I)] Low speed C5-03 [ASR Proportional Gain 2 (P)]^{*3} C5-04 [ASR Integral Time 2 (I)] 	Change the ASR proportional gain and ASR integral time in accordance with the output frequency.	0.0 Hz	0.0 to maximum output frequency
Hunting, oscillation	C5-06 [ASR Delay Time] ^{*4}	<ul style="list-style-type: none"> Reduce setting value in increments of 0.010 when torque, speed response is slow. Raise setting value when vibration is likely to occur due to poor machine rigidity. 	0.004 s	0.004 to 0.020 seconds

- *1 Differs depending on settings for o2-04 [Drive Model Selection] and C6-01 [Normal / Heavy Duty Selection], when at default settings.
- *2 Differs depending on setting for o2-04 [Drive Model Selection], when at default settings.
- *3 For details on speed control (ASR), see the section where the C5 parameter is explained.
- *4 The optimal values for a no-load operation can differ from the optimal values for actual loading operation.

◆ Open Loop Vector Control Method for PM

Table 3.20 Parameters for Fine Tuning the Drive (Open Loop Vector Control Method for PM)

Issue	Parameter Number	Solution	Default Setting	Suggested Setting
Motor not operating according to settings.	E1 parameter, E5 parameter	<ul style="list-style-type: none"> Check the settings for E1-06, E1-04 [Base Frequency, Maximum Output Frequency]. Check the E5 parameters and ensure that all motor data has been set correctly. <p>Note: Do not set the value of line-to-line resistance to the stator resistance of the motor (r1) (E5-05).</p> <ul style="list-style-type: none"> Perform Auto-Tuning. 	-	-
Torque, speed response is slow.	n8-55 [Load Inertia]	Set the ratio according to the motor's inertia and that of the application machine.	0	Adjust to match the actual inertia ratio.
	n8-45 [Spd Feedback Detect Control Gain]	Reduce the setting value.	0.80	Change in increments of 0.05.
	C4-01 [Torque Compensation Gain]	Adjust the setting value. Note: If the value is set too high, it can result in overcompensation, which may cause motor oscillation.	0.00	1.00

3.10 Fine Tuning during Test Runs (Adjustment of Control Functionality)

Issue	Parameter Number	Solution	Default Setting	Suggested Setting
<ul style="list-style-type: none"> Oscillation occurs when motor starts. Motor stalls. 	n8-51 [Accel / Decel Pull-In Current]	Increase setting value.	50 %	Increase in increments of 5%.
	<ul style="list-style-type: none"> b2-02 [DC Injection Braking Current] b2-03 [DC Inject Braking Time at Start] 	Perform DC Injection Braking when the motor starts up. Note: When the motor starts, it may rotate in reverse for about 1/8 of a turn, so caution should be observed.	<ul style="list-style-type: none"> b2-02: 50% b2-03: 0.0 s 	<ul style="list-style-type: none"> b2-02: Adjust as necessary. b2-03: 0.5 s
	n8-55 [Load Inertia]	Increase setting value. Note: Caution should be observed when running the motor by itself or with a minimum amount of inertia. If too high a value is set, oscillation may be produced.	0	Adjust to match the actual inertia ratio.
Load is connected, and while running at a constant speed, motor stalls or oscillates.	n8-47 [Pull-InCurCompensationTime Const]	Reduce the setting value.	5.0 s	Reduce in increments of 0.2 s.
	n8-48 [Pull-In Current (for PM Motors)]	Increase setting value.	30 %	Increase in increments of 5%.
	n8-55 [Load Inertia]	Increase setting value. Note: Caution should be observed when running the motor by itself or with a minimum amount of inertia. If too high a value is set, oscillation may be produced.	0	Adjust to match the actual inertia ratio.
Hunting, oscillation	n8-45 [Spd Feedback Detect Control Gain]	Increase setting value.	0.80	Increase in increments of 0.05.
Even though the load is not large, <i>STPo</i> [Pull-Out Detection] occurs.	<ul style="list-style-type: none"> E5-09 [PM Back-EMF Vpeak (mV/(rad/s))] E5-24 [PM Back-EMF L-L Vrms (mV/rpm)] 	<ul style="list-style-type: none"> Adjust the setting value. While referring to the motor code on the motor nameplate or the data sheet, correctly input values for <i>E5-09</i> or <i>E5-24</i>. 	*1	<ul style="list-style-type: none"> Yaskawa motor Input the motor code found on the motor nameplate. Motor from another manufacturer Input the values listed in the test report.
Output voltage was saturated during high-speed operation and oscillation or <i>STPo</i> [Pull-Out Detection] occurred.	n8-62 [Output Voltage Limit (for PM)]	Set so it is lower than the actual input power supply voltage.	<ul style="list-style-type: none"> 200.0 V 400.0 V 	Set so it is lower than the actual input power supply voltage.

*1 Differs depending on settings for *E5-01* [Motor Code Selection] and *o2-04* [Drive Model Selection], when at default settings.

◆ Advanced Open Loop Vector Control Method for PM

Table 3.21 Parameters for Fine Tuning the Drive (Advanced Open Loop Vector Control Method for PM)

Issue	Parameter Number	Solution	Default Setting	Suggested Setting
<ul style="list-style-type: none"> Torque, speed response is slow. Hunting, oscillation 	<ul style="list-style-type: none"> High speed C5-01 [ASR Proportional Gain 1 (P)] Low speed C5-03 [ASR Proportional Gain 2 (P)] 	<ul style="list-style-type: none"> Increase setting value in increments of 5.00 when torque, speed response is slow. If hunting, oscillation occurs, reduce the setting value. 	10.00	5.00 - 30.00 ^{*1}
	<ul style="list-style-type: none"> High speed C5-02 [ASR Integral Time 1 (I)] Low speed C5-04 [ASR Integral Time 2 (I)] 	<ul style="list-style-type: none"> Reduce setting value when torque, speed response is slow. If hunting, oscillation occurs, increase the setting value. 	0.500 s	0.300 to 1.000 seconds ^{*1}
ASR proportional gain or integral time cannot be established for low speed or high speed.	C5-07 [ASR Gain Switchover Frequency]	Change the ASR proportional gain and ASR integral time in accordance with the output frequency.	0.0 %	0.0% to maximum rotation speed
Hunting, oscillation	C5-06 [ASR Delay Time]	Raise setting value in increments of 0.010 when vibration is likely to occur due to poor machine rigidity.	0.016 s	0.016 to 0.035 seconds ^{*1}
Step-out	E1 parameter, E5 parameter	Refer to the motor's test report or nameplate and set E1-xx or E5-xx correctly.	-	-

^{*1} The optimal values for a no-load operation can differ from the optimal values for actual loading operation.

◆ Closed Loop Vector Control Method for PM

Table 3.22 Parameters for Fine Tuning the Drive (Closed Loop Vector Control Method for PM)

Issue	Parameter Number	Solution	Default Setting	Suggested Setting
<ul style="list-style-type: none"> Torque, speed response is slow. Hunting, oscillation 	<ul style="list-style-type: none"> High speed C5-01 [ASR Proportional Gain 1 (P)] Low speed C5-03 [ASR Proportional Gain 2 (P)] 	<ul style="list-style-type: none"> Increase setting value in increments of 5.00 when torque, speed response is slow. If hunting, oscillation occurs, reduce the setting value. 	20.00	10.00 - 50.00 ^{*1}
	<ul style="list-style-type: none"> High speed C5-02 [ASR Integral Time 1 (I)] Low speed C5-04 [ASR Integral Time 2 (I)] 	<ul style="list-style-type: none"> Reduce setting value when torque, speed response is slow. If hunting, oscillation occurs, increase the setting value. 	0.500 s	0.300 to 1.000 seconds ^{*1}
Speed response cannot be secured for low speed or high speed.	<ul style="list-style-type: none"> C5-07 [ASR Gain Switchover Frequency] High speed C5-01 [ASR Proportional Gain 1 (P)] C5-02 [ASR Integral Time 1 (I)] Low speed C5-03 [ASR Proportional Gain 2 (P)] C5-04 [ASR Integral Time 2 (I)] 	Change the ASR proportional gain and ASR integral time in accordance with the output frequency.	0.0 %	0.0% to maximum rotation speed

3.10 Fine Tuning during Test Runs (Adjustment of Control Functionality)

Issue	Parameter Number	Solution	Default Setting	Suggested Setting
Hunting, oscillation	C5-06 [ASR Delay Time]	Raise setting value in increments of 0.010 when vibration is likely to occur due to poor machine rigidity.	0.004 s	0.004 to 0.020 seconds ^{*1}
Step-out	E1 parameter, E5 parameter	Refer to the motor's test report or nameplate and set <i>E1-xx</i> or <i>E5-xx</i> correctly.	-	-

*1 The optimal values for a no-load operation can differ from the optimal values for actual loading operation.

◆ EZ Open Loop Vector Control Method

Table 3.23 Parameters for Fine Tuning the Drive (EZ Open Loop Vector Control Method)

Issue	Parameter Number	Solution	Default Setting	Suggested Setting
<ul style="list-style-type: none"> Torque, speed response is slow. Hunting, oscillation 	<ul style="list-style-type: none"> High speed C5-01 [ASR Proportional Gain 1 (P)] Low speed C5-03 [ASR Proportional Gain 2 (P)] 	<ul style="list-style-type: none"> Increase setting value in increments of 5.00 when torque, speed response is slow. If hunting, oscillation occurs, reduce the setting value. 	10.00	10.00 - 50.00 ^{*1}
	<ul style="list-style-type: none"> High speed C5-02 [ASR Integral Time 1 (I)] Low speed C5-04 [ASR Integral Time 2 (I)] 	<ul style="list-style-type: none"> Reduce setting value when torque, speed response is slow. If hunting, oscillation occurs, increase the setting value. 	0.500 s	0.300 to 1.000 seconds ^{*1}
ASR proportional gain or integral time cannot be established for low speed or high speed.	C5-07 [ASR Gain Switchover Frequency]	Change the ASR proportional gain and ASR integral time in accordance with the output frequency.	0.0%	0.0% to maximum rotation speed
Hunting, oscillation	C5-06 [ASR Delay Time]	Raise setting value in increments of 0.010 when vibration is likely to occur due to poor machine rigidity.	0.004 s	0.004 to 0.020 seconds ^{*1}
Step-out	E9 parameter	Refer to the motor's test report or nameplate and set <i>E9-xx</i> correctly.	-	-
Oscillation occurs when motor starts.	n8-51 [Accel / Decel Pull-In Current]	Increase setting value.	80%	Increase in increments of 5%.
Motor stalls.	L7-01 to L7-04 [Torque Limit]	Increase setting value.	200%	Increase in increments of 10%.

*1 The optimal values for a no-load operation can differ from the optimal values for actual loading operation.

3.11 Test Run Checklist

Go through the following checklist before performing a test run.

Checked	No.	Description
	1	Was this manual read thoroughly before starting a test run?
	2	Was the "Wiring Checklist" gone through?
	3	Is the drive energized?
	4	Has the voltage value of the power supply to be used been set to <i>E1-01 [Input AC Supply Voltage]</i> ?

Check the necessary items depending on the control method.

WARNING! Sudden Movement Hazard. Properly wire the start/stop and safety circuits before energizing the drive. When programmed for 3-Wire control, a momentary closure on a digital input terminal could cause the drive to start. Failure to comply could cause death or serious injury from moving equipment.

Table 3.24 V/f Control [A1-02 = 0] and Closed Loop V/f Control [A1-02 = 1]

Checked	No.	Description
	5	Was the optimum V/f pattern selected, based on the application that the motor is to be used for, and its specifications? Ex.: if a motor with a rated frequency of 60 Hz is to be used, as a standard V/f pattern, <i>E1-03 = 1 [V/f Pattern Selection = Constant Trq_60Hz base_60Hz max]</i> is set.

Table 3.25 Closed Loop V/f Control [A1-02 = 1]

Checked	No.	Description
	6	Has <i>F1-01 [PG 1 Pulses Per Revolution]</i> been set?
	7	Have <i>C5-01 [ASR Proportional Gain 1]</i> and <i>C5-02 [ASR Integral Time 1]</i> been set?

Table 3.26 Open Loop Vector Control [A1-02 = 2]/Closed Loop Vector Control [A1-02 = 3]

Checked	No.	Description
	8	Was Rotational Auto-Tuning performed?
	9	Were the motor shaft and machinery decoupled when performing Rotational Auto-Tuning?
	10	Were the following items, which can be found on the motor nameplate, set correctly? <ul style="list-style-type: none"> • Motor rated power (kW) → <i>T1-02</i> • Rated (base) voltage (V) → <i>T1-03</i> • Rated (base) current (A) → <i>T1-04</i> • Rated (base) frequency (Hz) → <i>T1-05</i> • Number of poles → <i>T1-06</i> • Rated (base) speed (min⁻¹) → <i>T1-07</i>

Table 3.27 Closed Loop Vector Control [A1-02 = 3]

Checked	No.	Description
	11	Have <i>F1-01 [PG 1 Pulses Per Revolution]</i> and <i>F1-05 [PG 1 Rotation Selection]</i> been set?
	12	Have <i>C5-01 [ASR Proportional Gain 1]</i> and <i>C5-02 [ASR Integral Time 1]</i> been set?

Table 3.28 PM Open Loop Vector Control [A1-02 = 5]

Checked	No.	Description
	13	Have <i>E5-01 to E5-24 [PM Motor Parameters]</i> been set?

Table 3.29 PM Advanced Open Loop Vector [A1-02 = 6]

Checked	No.	Description
	14	Have E5-01 to E5-24 [PM Motor Parameters] been set?
	15	Have C5-01 [ASR Proportional Gain 1] and C5-02 [ASR Integral Time 1] been set?

Table 3.30 PM Closed Loop Vector Control [A1-02 = 7]

Checked	No.	Description
	16	Have E5-01 to E5-24 [PM Motor Parameters] been set?
	17	Have C5-01 [ASR Proportional Gain 1] and C5-02 [ASR Integral Time 1] been set?
	18	Have F1-01 [PG 1 Pulses Per Revolution] and F1-05 [PG 1 Rotation Selection] been set?
	19	Has E5-11 [Encoder Z-Pulse Offset] been set?

After checking Nos. 5 to 19, check the following items.

Checked	No.	Description
	20	When operation is started, is "Rdy" displayed on the keypad?
	21	When wanting to issue Run commands and frequency references from the keypad, was LO/RE pressed so the drive was put in LOCAL mode? (When in LOCAL mode, the LOCAL/REMOTE indicator lights).
	22	During a test run, when the direction of motor rotation was incorrect, were two of the wires of the drive's output terminals (U/T1, V/T2, W/T3) switched?
	23	Was C6-01 [Normal / Heavy Duty Selection] set in accordance with the load characteristics?
	24	To ensure that the "electronic thermal protector" functions properly and protects the motor from overheating, were E2-01 [Motor Rated Current (FLA)] and L1-01 [Motor Overload Protection Select] set correctly?
	25	When wanting to receive Run commands and frequency references at the control circuit terminals, was [LO/RE selection key] pressed so the drive was put in REMOTE mode? (When in REMOTE mode, the LOCAL/REMOTE indicator turns OFF.)
	26	When terminal A1 is to be used for the frequency reference <ul style="list-style-type: none"> • Voltage input <ul style="list-style-type: none"> – Have you checked to make sure that DIP switch S1-1 inside the drive is at the V position? – Have H3-01 = 0, 1 [Terminal A1 Signal Level Select = 0-10V (LowLim=0), 0-10V (BipolRef)] been set? – Has H3-02 = 0 [Terminal A1 Function Selection = Frequency Bias] been set? • Current input <ul style="list-style-type: none"> – Have you checked to make sure that DIP switch S1-1 inside the drive is at the I position? – Has H3-01 = 2, 3 [Terminal A1 Signal Level Select = 4-20 mA, 0-20 mA] been set? – Has H3-02 = 0 [Terminal A1 Function Selection = Frequency Bias] been set?
	27	When terminal A2 is to be used for the frequency reference <ul style="list-style-type: none"> • Voltage input <ul style="list-style-type: none"> – Have you checked to make sure that DIP switch S1-2 inside the drive is at the V position? – Have H3-09 = 0, 1 [Terminal A2 Signal Level Select = 0-10V (LowLim=0), 0-10V (BipolRef)] been set? – Has H3-10 = 0 [Terminal A2 Function Selection = Frequency Bias] been set? • Current input <ul style="list-style-type: none"> – Have you checked to make sure that DIP switch S1-2 inside the drive is at the I position? – Has H3-09 = 2, 3 [Terminal A2 Signal Level Select = 4-20mA, 0-20mA] been set? – Has H3-10 = 0 [Terminal A2 Function Selection = Frequency Bias] been set?

Checked	No.	Description
	28	<p>When terminal A3 is to be used for the frequency reference</p> <ul style="list-style-type: none"> • Voltage input <ul style="list-style-type: none"> – Have you checked to make sure that DIP switch S4 inside the drive is at the analog input side? – Have you checked to make sure that DIP switch S1-3 inside the drive is at the “V” side? – Have $H3-05 = 0, 1$ [Terminal A3 Signal Level Select = 0-10V (LowLim=0), 0-10V (BipolRef)] been set? – Has $H3-06 = 0$ [Terminal A3 Function Selection = Frequency Bias] been set? • Current input <ul style="list-style-type: none"> – Have you checked to make sure that DIP switch S4 inside the drive is at the analog input side? – Have you checked to make sure that DIP switch S1-3 inside the drive is at the “I” side? – Has $H3-05 = 2, 3$ [Terminal A3 Signal Level Select = 4-20mA, 0-20mA] been set? – Has $H3-06 = 0$ [Terminal A3 Function Selection = Frequency Bias] been set?
	29	<p>Have you checked to make sure that the frequency reference reaches the desired minimum and maximum values?</p> <p>Check the following items if the desired values are not reached.</p> <p>Gain adjustment: Set the maximum voltage and current values, then adjust the analog input gain until the frequency reference reaches the desired value. (For terminal A1 input: $H3-03$, for terminal A2 input: $H3-11$, for terminal A3 input: $H3-07$)</p> <p>Bias adjustment: Set the maximum voltage/current values, then adjust the analog input bias until the frequency reference reaches the desired minimum value. (For terminal A1 input: $H3-04$, for terminal A2 input: $H3-12$, for terminal A3 input: $H3-08$)</p>

Standards Compliance

This chapter describes the guidelines for machines and devices incorporating this product to comply with the European standard and UL standard.

4.1	Safety Precautions	178
4.2	European Standards	180
4.3	UL Standards	203
4.4	Safe Disable Input	224

4.1 Safety Precautions

DANGER

Electrical Shock Hazard

Do not perform inspections or wiring while the drive is energized. De-energize all devices before carrying out any wiring or repair operations. Voltage will remain within the capacitors inside the drive even after the power has been switched off. The Charge LED is extinguished once the DC bus voltage goes below 50 V DC. To prevent electric shock, always wait for at least the amount of time indicated on the warning labels and confirm that all indicators are OFF. Then, remove the front cover and terminal cover, measure the input power supply voltage and the DC bus voltage, and make sure that the voltages have been lowered to safe levels.

Failure to comply may result in death or serious injury.

WARNING

Electrical Shock Hazard

Do not operate equipment with covers removed. The diagrams in this section may include drives without covers or safety shields to illustrate details. Be sure to reinstall covers or shields before operating the drives and run the drives according to the instructions described in this manual.

Failure to comply could result in death or serious injury.

Always ground the motor-side grounding terminal.

Improper equipment grounding could cause death or serious injury from contacting the motor case.

Do not remove covers or touch the circuit boards while the power is on.

Failure to comply could cause death or serious injury.

Do not touch components while power is flowing through the device. Do not touch the output terminals directly with your hands. Also ensure that the output wiring do not come into contact with the drive case.

Failure to comply may result in injury or death from electrical shock.

Only authorized persons qualified in electrical work should perform installation, wiring, maintenance, inspections, parts replacement, and repairs.

Failure to comply may cause electrical shock.

Do not perform work on the drive while wearing loose clothing or jewelry. Before servicing, secure loose clothing and remove all metal objects such as watches or rings.

Failure to comply could cause death or serious injury.

Do not attempt to modify or alter the drive or drive circuitry in any way not explained in this manual.

Failure to comply could cause death or serious injury and will void warranty. Yaskawa is not responsible for any modification of the product made by the user. Do not modify this product.

Fire Hazard

Tighten all terminal screws to the specified tightening torque.

Loose or overtightened connections could cause erroneous operation and damage to the terminal block or start a fire and cause death or serious injury.

Do not use the main circuit power supply (Overcurrent Category III) at improper voltages. Before applying power, make sure the drive rated voltage and the power supply voltage match.

Using the main circuit power supply at improper voltages may result in batteries bursting and igniting, which could cause fire and injury.

⚠ WARNING

Do not place flammable or combustible materials on top of the drive and do not mount the drive to flammable or combustible materials. Attach the drive to metal or other noncombustible material.

Failure to comply could cause death or serious injury.

Crush Hazard

Do not perform work on the drive without eye protection. Wear eye protection before beginning work on the drive.

Failure to comply could result in serious injury.

NOTICE

Observe proper electrostatic discharge (ESD) procedures when handling the drive and circuit boards.

Failure to comply could cause ESD damage to the drive circuitry.

Never connect or disconnect the motor from the drive while the drive is outputting voltage.

Improper equipment sequencing could damage the drive.

Do not use unshielded wire for control wiring. Use shielded twisted-pair wires and ground the shield to the ground terminal of the drive.

Failure to comply may cause electrical interference resulting in poor system performance.

Carefully review instruction manual TOBPC72060001 before connecting a dynamic braking option to the drive.

Failure to comply could damage the drive or braking circuit.

Do not modify the drive circuitry.

Failure to comply could cause damage to the drive and will void warranty. Yaskawa is not responsible for any modification of the product made by the user.

Confirm that all connections are correct after installing the drive and connecting peripheral devices.

Failure to comply could damage the drive.

Do not energize the power or operate equipment soon after a fuse blows or the circuit breaker (ELCB) trips. Check the condition of cable wiring and peripheral devices to identify the root cause. If the root cause cannot be determined, do not turn on the power or operate equipment. Contact Yaskawa Support immediately.

4.2 European Standards



Figure 4.1 CE Mark

The CE Mark indicates that the product meets environmental and safety standards in the European Union. Products manufactured, sold, or imported within the European Union are required to display the CE Mark.

European Union standards include standards for electrical appliances (Low Voltage Directive), standards for electrical noise (EMC Directive), and standards for machinery (Machinery Directive).

This product displays the CE Mark in accordance with the Low Voltage Directive, the EMC Directive, and the Machinery Directive.

Contact Yaskawa or your nearest sales representative for details on models 2138 to 2415, 4089 to 4675.

Table 4.1 Harmonized Standard

European Directive	Harmonized Standard ^{*1}
Low Voltage Directive 2014/35/EU	IEC/EN 61800-5-1:2007
EMC Guidelines Compliance 2014/30/EU	EN 61800-3:2004+A1:2012
Machinery Directive 2006/42/EC	<ul style="list-style-type: none"> • EN ISO 13849-1/AC:2009 (PL e (Cat.III)) • IEC 62061/A1:2012 (SIL CL 3) • EN 62061/A1:2013 (SIL CL 3) • IEC/EN 61800-5-2:2007 (SIL3)

*1 Approval pending for models 2138 to 2415, 4089 to 4675.

Note:

Indicates that the device or machine containing this product is covered by the CE Mark.

The customer is responsible for displaying the CE Mark on the final device containing this product. Customers must verify themselves that the final device is compliant with EU standards.

◆ CE Low Voltage Directive Compliance

It has been confirmed that this product complies with the CE Low Voltage Directive by conducting a test according to IEC/EN 61800-5-1:2007.

The following conditions must be satisfied for machines and devices incorporating this product to comply with the CE Low Voltage Directive.

■ Area of Use

Install this product in a location with overvoltage category III and pollution degree 2 or less which are defined by IEC/EN 60664.

■ Guarding against Debris

When installing IP20 enclosure drives (model: 2xxxxB, 4xxxxB), use an enclosure that prevents foreign material from entering the drive from above or below.

■ Wiring Diagram

Figure 4.2 shows an example of a drive that is wired for compliance with the CE Low Voltage Directive.

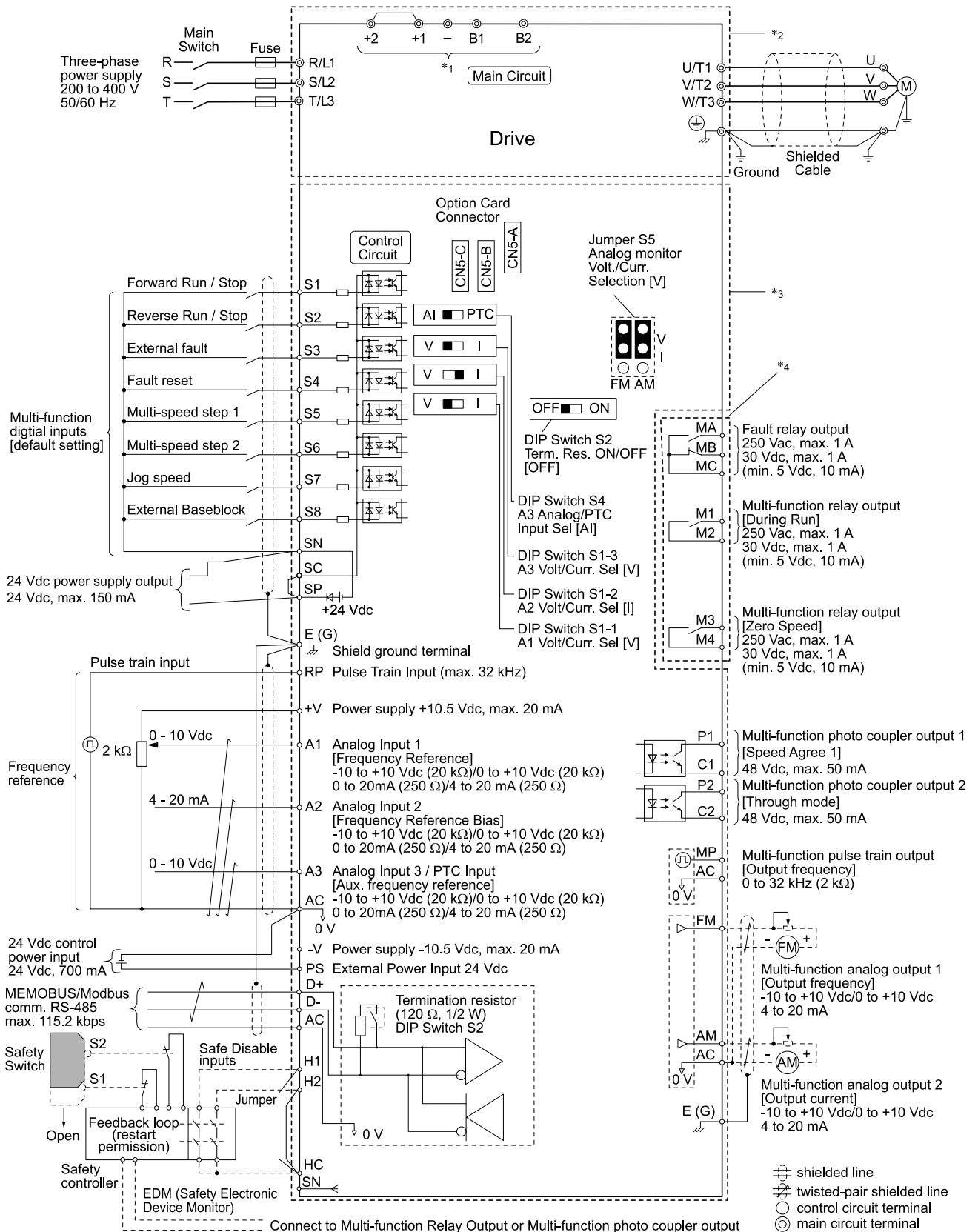

Figure 4.2 Wiring Diagram for Low Voltage Directive Compliance

- *1 Use terminals -, +1, +2, B1, and B2 to connect options to the drive. Never connect power supply lines to these terminals.
- *2 For circuit protection, the main circuit is separated from the surface case that would otherwise come into contact with the main circuit.
- *3 The control circuit is a Safety Extra-Low Voltage circuit, and therefore the control circuit must be separated from other circuits by reinforced insulation. Ensure that the Safety Extra-Low Voltage circuit is connected as required.

4.2 European Standards

*4 Reinforced insulation separates the output terminals from other circuits. Users may also connect circuits that are not Safety Extra-Low Voltage circuits if the drive output is 250 Vac 1 A max. or 30 Vdc 1 A max.

■ Main Circuit Wire Gauges and Tightening Torques for European Standards

Note:

- Wire gauge recommendations based on drive continuous current ratings using 75 °C (167 °F) 600 V class 2 heat resistant indoor PVC wire. Assume the following usage conditions:
 - Ambient temperature: 40 °C (104 °F) or lower
 - Wiring distance: 100 m (3281 ft.) or shorter
 - Rated current (ND) value
- Use terminals -, +1, +2, +3, B1, and B2 to connect peripheral options. Do not connect anything other than optional devices. Do not connect anything other than optional devices.
- When connecting peripheral devices or options to terminals -, +1, +2, B1, B2, refer to the specific instruction manual of each device for wire gauges. Contact Yaskawa or your nearest sales representative if the wire gauge recommended for the peripheral device or optional product is out of the range of the applicable gauge for the drive.

Table 4.2 Wire Gauges and Tightening Torques for 200 V Class Drives

Model	Terminal	For Europe and China		Wire Stripping Length mm */	Terminal Screw		Tightening Torque N·m (lb·in)
		Recommended Gauge mm ²	Wire Range mm ²		Size	Shape	
2004	R/L1, S/L2, T/L3	2.5	2.5 - 10	10	M4	Slot (-)	1.5 - 1.7 (13.5 - 15)
	U/T1, V/T2, W/T3	2.5	2.5 - 10	10	M4	Slot (-)	1.5 - 1.7 (13.5 - 15)
	-, +1, +2	2.5	2.5 - 16	18	M5	Slot (-)	2.3 - 2.5 (19.8 - 22) *2
	B1, B2	2.5	2.5 - 4	10	M4	Slot (-)	1.5 - 1.7 (13.5 - 15)
	⊕	2.5 *3	2.5 - 6	-	M4	Phillips/slot combo	1.2 - 1.5 (10.6 - 13.3)
2006	R/L1, S/L2, T/L3	2.5	2.5 - 10	10	M4	Slot (-)	1.5 - 1.7 (13.5 - 15)
	U/T1, V/T2, W/T3	2.5	2.5 - 10	10	M4	Slot (-)	1.5 - 1.7 (13.5 - 15)
	-, +1, +2	2.5	2.5 - 16	18	M5	Slot (-)	2.3 - 2.5 (19.8 - 22) *2
	B1, B2	2.5	2.5 - 4	10	M4	Slot (-)	1.5 - 1.7 (13.5 - 15)
	⊕	2.5 *3	2.5 - 6	-	M4	Phillips/slot combo	1.2 - 1.5 (10.6 - 13.3)
2008	R/L1, S/L2, T/L3	2.5	2.5 - 10	10	M4	Slot (-)	1.5 - 1.7 (13.5 - 15)
	U/T1, V/T2, W/T3	2.5	2.5 - 10	10	M4	Slot (-)	1.5 - 1.7 (13.5 - 15)
	-, +1, +2	2.5	2.5 - 16	18	M5	Slot (-)	2.3 - 2.5 (19.8 - 22) *2
	B1, B2	2.5	2.5 - 4	10	M4	Slot (-)	1.5 - 1.7 (13.5 - 15)
	⊕	2.5 *3	2.5 - 6	-	M4	Phillips/slot combo	1.2 - 1.5 (10.6 - 13.3)

Model	Terminal	For Europe and China		Wire Stripping Length mm *1	Terminal Screw		Tightening Torque N-m (lb-in)
		Recommended Gauge mm ²	Wire Range mm ²		Size	Shape	
2010	R/L1, S/L2, T/L3	2.5	2.5 - 10	10	M4	Slot (-)	1.5 - 1.7 (13.5 - 15)
	U/T1, V/T2, W/T3	2.5	2.5 - 10	10	M4	Slot (-)	1.5 - 1.7 (13.5 - 15)
	-, +1, +2	2.5	2.5 - 16	18	M5	Slot (-)	2.3 - 2.5 (19.8 - 22) *2
	B1, B2	2.5	2.5 - 4	10	M4	Slot (-)	1.5 - 1.7 (13.5 - 15)
	⊕	2.5 *3	2.5 - 6	-	M4	Phillips/slot combo	1.2 - 1.5 (10.6 - 13.3)
2012	R/L1, S/L2, T/L3	2.5	2.5 - 10	10	M4	Slot (-)	1.5 - 1.7 (13.5 - 15)
	U/T1, V/T2, W/T3	2.5	2.5 - 10	10	M4	Slot (-)	1.5 - 1.7 (13.5 - 15)
	-, +1, +2	2.5	2.5 - 16	18	M5	Slot (-)	2.3 - 2.5 (19.8 - 22) *2
	B1, B2	2.5	2.5 - 4	10	M4	Slot (-)	1.5 - 1.7 (13.5 - 15)
	⊕	2.5 *3	2.5 - 6	-	M4	Phillips/slot combo	1.2 - 1.5 (10.6 - 13.3)
2018	R/L1, S/L2, T/L3	2.5	2.5 - 10	10	M4	Slot (-)	1.5 - 1.7 (13.5 - 15)
	U/T1, V/T2, W/T3	2.5	2.5 - 10	10	M4	Slot (-)	1.5 - 1.7 (13.5 - 15)
	-, +1, +2	4	2.5 - 16	18	M5	Slot (-)	2.3 - 2.5 (19.8 - 22) *2
	B1, B2	2.5	2.5 - 4	10	M4	Slot (-)	1.5 - 1.7 (13.5 - 15)
	⊕	2.5 *3	2.5 - 6	-	M4	Phillips/slot combo	1.2 - 1.5 (10.6 - 13.3)
2021	R/L1, S/L2, T/L3	6	2.5 - 10	10	M4	Slot (-)	1.5 - 1.7 (13.5 - 15)
	U/T1, V/T2, W/T3	2.5	2.5 - 10	10	M4	Slot (-)	1.5 - 1.7 (13.5 - 15)
	-, +1, +2	6	2.5 - 16	18	M5	Slot (-)	2.3 - 2.5 (19.8 - 22) *2
	B1, B2	2.5	2.5 - 4	10	M4	Slot (-)	1.5 - 1.7 (13.5 - 15)
	⊕	6 *3	4 - 6	-	M4	Phillips/slot combo	1.2 - 1.5 (10.6 - 13.3)

4.2 European Standards

Model	Terminal	For Europe and China		Wire Stripping Length mm *1	Terminal Screw		Tightening Torque N·m (lb·in)
		Recommended Gauge mm ²	Wire Range mm ²		Size	Shape	
2030	R/L1, S/L2, T/L3	10	2.5 - 10	10	M4	Slot (-)	1.5 - 1.7 (13.5 - 15)
	U/T1, V/T2, W/T3	6	2.5 - 10	10	M4	Slot (-)	1.5 - 1.7 (13.5 - 15)
	-, +1, +2	10	2.5 - 16	18	M5	Slot (-)	2.3 - 2.5 (19.8 - 22) *2
	B1, B2	2.5	2.5 - 4	10	M4	Slot (-)	1.5 - 1.7 (13.5 - 15)
	⊕	10 *3	6 - 10	-	M5	Phillips/slot combo	2.0 - 2.5 (17.7 - 22.1)
2042	R/L1, S/L2, T/L3	10	2.5 - 10	10	M4	Slot (-)	1.5 - 1.7 (13.5 - 15)
	U/T1, V/T2, W/T3	10	2.5 - 10	10	M4	Slot (-)	1.5 - 1.7 (13.5 - 15)
	-, +1, +2	16	2.5 - 16	18	M5	Slot (-)	2.3 - 2.5 (19.8 - 22) *2
	B1, B2	4	2.5 - 4	10	M4	Slot (-)	1.5 - 1.7 (13.5 - 15)
	⊕	10	6 - 10	-	M5	Phillips/slot combo	2.0 - 2.5 (17.7 - 22.1)
2056	R/L1, S/L2, T/L3	25	10 - 25	18	M5	Slot (-)	2.3 - 2.5 (19.8 - 22) *2
	U/T1, V/T2, W/T3	16	6 - 16	18	M5	Slot (-)	2.3 - 2.5 (19.8 - 22) *2
	-, +1, +2	35	10 - 35	20	M6	Hex socket cap (WAF: 5 mm)	5 - 5.5 (45 - 49)
	B1, B2	10	2.5 - 10	10	M4	Slot (-)	1.5 - 1.7 (13.5 - 15)
	⊕	16	10 - 16	-	M6	Phillips/slot combo	5.4 - 6.0 (47.8 - 53.1)
2070	R/L1, S/L2, T/L3	Preparing					
	U/T1, V/T2, W/T3						
	-, +1, +2						
	B1, B2						
	⊕						
2082	R/L1, S/L2, T/L3	Preparing					
	U/T1, V/T2, W/T3						
	-, +1, +2						
	B1, B2						
	⊕						

Model	Terminal	For Europe and China		Wire Stripping Length mm */	Terminal Screw		Tightening Torque N·m (lb·in)
		Recommended Gauge mm ²	Wire Range mm ²		Size	Shape	
2110	R/L1, S/L2, T/L3						
	U/T1, V/T2, W/T3						
	-, +1						
	B1, B2						
	⊕						
2138	R/L1, S/L2, T/L3						
	U/T1, V/T2, W/T3						
	-, +1						
	B1, B2						
	⊕						
2169	R/L1, S/L2, T/L3						
	U/T1, V/T2, W/T3						
	-, -, +1, +1						
	+3						
	⊕						
2211	R/L1, S/L2, T/L3						
	U/T1, V/T2, W/T3						
	-, -, +1, +1						
	+3						
	⊕						
2257	R/L1, S/L2, T/L3						
	U/T1, V/T2, W/T3						
	-, +1						
	+3						
	⊕						
2313	R/L1, S/L2, T/L3						
	U/T1, V/T2, W/T3						
	-, +1						
	+3						
	⊕						

4.2 European Standards

Model	Terminal	For Europe and China		Wire Stripping Length mm <i>*1</i>	Terminal Screw		Tightening Torque N·m (lb·in)
		Recommended Gauge mm ²	Wire Range mm ²		Size	Shape	
2360	R/L1, S/L2, T/L3	Preparing					
	U/T1, V/T2, W/T3						
	-, +1						
	+3						
	⊕						
2415	R/L1, S/L2, T/L3	Preparing					
	U/T1, V/T2, W/T3						
	-, +1						
	+3						
	⊕						

*1 Remove the insulator from the tips of wires to the length shown in “Wire Stripping Length.”

*2 When using wire with a gauge over 30 mm², tighten to a tightening torque of 4.1 to 4.5 N·m (36 to 40 lb·in.).

*3 Install ELCB to maintain compliance with IEC/EN 61800-5-1:2007 with use of wire of this gauge.

Table 4.3 Wire Gauges and Tightening Torques for 400 V Class Drives

Model	Terminal	For Europe and China		Wire Stripping Length mm <i>*1</i>	Terminal Screw		Tightening Torque N·m (lb·in)
		Recommended Gauge mm ²	Wire Range mm ²		Size	Shape	
4002	R/L1, S/L2, T/L3	2.5	2.5 - 10	10	M4	Slot (-)	1.5 - 1.7 (13.5 - 15)
	U/T1, V/T2, W/T3	2.5	2.5 - 10	10	M4	Slot (-)	1.5 - 1.7 (13.5 - 15)
	-, +1, +2	2.5	2.5 - 16	18	M5	Slot (-)	2.3 - 2.5 (19.8 - 22) <i>*2</i>
	B1, B2	2.5	2.5 - 4	10	M4	Slot (-)	1.5 - 1.7 (13.5 - 15)
	⊕	2.5 <i>*3</i>	2.5 - 4	-	M4	Phillips/slot combo	1.2 - 1.5 (10.6 - 13.3)
4004	R/L1, S/L2, T/L3	2.5	2.5 - 10	10	M4	Slot (-)	1.5 - 1.7 (13.5 - 15)
	U/T1, V/T2, W/T3	2.5	2.5 - 10	10	M4	Slot (-)	1.5 - 1.7 (13.5 - 15)
	-, +1, +2	2.5	2.5 - 16	18	M5	Slot (-)	2.3 - 2.5 (19.8 - 22) <i>*2</i>
	B1, B2	2.5	2.5 - 4	10	M4	Slot (-)	1.5 - 1.7 (13.5 - 15)
	⊕	2.5 <i>*3</i>	2.5 - 4	-	M4	Phillips/slot combo	1.2 - 1.5 (10.6 - 13.3)

Model	Terminal	For Europe and China		Wire Stripping Length mm *1	Terminal Screw		Tightening Torque N-m (lb-in)
		Recommended Gauge mm ²	Wire Range mm ²		Size	Shape	
4005	R/L1, S/L2, T/L3	2.5	2.5 - 10	10	M4	Slot (-)	1.5 - 1.7 (13.5 - 15)
	U/T1, V/T2, W/T3	2.5	2.5 - 10	10	M4	Slot (-)	1.5 - 1.7 (13.5 - 15)
	-, +1, +2	2.5	2.5 - 16	18	M5	Slot (-)	2.3 - 2.5 (19.8 - 22) *2
	B1, B2	2.5	2.5 - 4	10	M4	Slot (-)	1.5 - 1.7 (13.5 - 15)
	⊕	2.5 *3	2.5 - 6	-	M4	Phillips/slot combo	1.2 - 1.5 (10.6 - 13.3)
4007	R/L1, S/L2, T/L3	2.5	2.5 - 10	10	M4	Slot (-)	1.5 - 1.7 (13.5 - 15)
	U/T1, V/T2, W/T3	2.5	2.5 - 10	10	M4	Slot (-)	1.5 - 1.7 (13.5 - 15)
	-, +1, +2	2.5	2.5 - 16	18	M5	Slot (-)	2.3 - 2.5 (19.8 - 22) *2
	B1, B2	2.5	2.5 - 4	10	M4	Slot (-)	1.5 - 1.7 (13.5 - 15)
	⊕	2.5 *3	2.5 - 6	-	M4	Phillips/slot combo	1.2 - 1.5 (10.6 - 13.3)
4009	R/L1, S/L2, T/L3	2.5	2.5 - 10	10	M4	Slot (-)	1.5 - 1.7 (13.5 - 15)
	U/T1, V/T2, W/T3	2.5	2.5 - 10	10	M4	Slot (-)	1.5 - 1.7 (13.5 - 15)
	-, +1, +2	2.5	2.5 - 16	18	M5	Slot (-)	2.3 - 2.5 (19.8 - 22) *2
	B1, B2	2.5	2.5 - 4	10	M4	Slot (-)	1.5 - 1.7 (13.5 - 15)
	⊕	2.5 *3	2.5 - 6	-	M4	Phillips/slot combo	1.2 - 1.5 (10.6 - 13.3)
4012	R/L1, S/L2, T/L3	2.5	2.5 - 10	10	M4	Slot (-)	1.5 - 1.7 (13.5 - 15)
	U/T1, V/T2, W/T3	2.5	2.5 - 10	10	M4	Slot (-)	1.5 - 1.7 (13.5 - 15)
	-, +1, +2	2.5	2.5 - 16	18	M5	Slot (-)	2.3 - 2.5 (19.8 - 22) *2
	B1, B2	2.5	2.5 - 4	10	M4	Slot (-)	1.5 - 1.7 (13.5 - 15)
	⊕	2.5 *3	2.5 - 6	-	M4	Phillips/slot combo	1.2 - 1.5 (10.6 - 13.3)

4.2 European Standards

Model	Terminal	For Europe and China		Wire Stripping Length mm *1	Terminal Screw		Tightening Torque N·m (lb·in)
		Recommended Gauge mm ²	Wire Range mm ²		Size	Shape	
4018	R/L1, S/L2, T/L3	2.5	2.5 - 10	10	M4	Slot (-)	1.5 - 1.7 (13.5 - 15)
	U/T1, V/T2, W/T3	2.5	2.5 - 10	10	M4	Slot (-)	1.5 - 1.7 (13.5 - 15)
	-, +1, +2	4	2.5 - 16	18	M5	Slot (-)	2.3 - 2.5 (19.8 - 22) *2
	B1, B2	2.5	2.5 - 4	10	M4	Slot (-)	1.5 - 1.7 (13.5 - 15)
	⊕	2.5 *3	2.5 - 6	-	M5	Phillips/slot combo	2.0 - 2.5 (17.7 - 22.1)
4023	R/L1, S/L2, T/L3	6	2.5 - 10	10	M4	Slot (-)	1.5 - 1.7 (13.5 - 15)
	U/T1, V/T2, W/T3	4	2.5 - 10	10	M4	Slot (-)	1.5 - 1.7 (13.5 - 15)
	-, +1, +2	6	2.5 - 16	18	M5	Slot (-)	2.3 - 2.5 (19.8 - 22) *2
	B1, B2	2.5	2.5 - 4	10	M4	Slot (-)	1.5 - 1.7 (13.5 - 15)
	⊕	6 *3	4 - 6	-	M5	Phillips/slot combo	2.0 - 2.5 (17.7 - 22.1)
4031	R/L1, S/L2, T/L3	10	10 - 25	18	M5	Slot (-)	2.3 - 2.5 (19.8 - 22) *2
	U/T1, V/T2, W/T3	6	6 - 16	18	M5	Slot (-)	2.3 - 2.5 (19.8 - 22) *2
	-, +1, +2	10	10 - 35	20	M6	Hex socket cap (WAF: 5 mm)	5 - 5.5 (45 - 49)
	B1, B2	2.5	2.5 - 10	10	M4	Slot (-)	1.5 - 1.7 (13.5 - 15)
	⊕	10 *3	6 - 10	-	M6	Phillips/slot combo	5.4 - 6.0 (47.8 - 53.1)
4038	R/L1, S/L2, T/L3	10	10 - 25	18	M5	Slot (-)	2.3 - 2.5 (19.8 - 22) *2
	U/T1, V/T2, W/T3	6	6 - 16	18	M5	Slot (-)	2.3 - 2.5 (19.8 - 22) *2
	-, +1, +2	16	10 - 35	20	M6	Hex socket cap (WAF: 5 mm)	5 - 5.5 (45 - 49)
	B1, B2	4	2.5 - 10	10	M4	Slot (-)	1.5 - 1.7 (13.5 - 15)
	⊕	10	6 - 16	-	M6	Phillips/slot combo	5.4 - 6.0 (47.8 - 53.1)
4044	R/L1, S/L2, T/L3	Preparing					
	U/T1, V/T2, W/T3						
	-, +1, +2						
	B1, B2						
	⊕						

Model	Terminal	For Europe and China		Wire Stripping Length mm */	Terminal Screw		Tightening Torque N·m (lb·in)
		Recommended Gauge mm ²	Wire Range mm ²		Size	Shape	
4060	R/L1, S/L2, T/L3						
	U/T1, V/T2, W/T3						
	-, +1						
	B1, B2						
	⊕						
4075	R/L1, S/L2, T/L3						
	U/T1, V/T2, W/T3						
	-, +1						
	B1, B2						
	⊕						
4089	R/L1, S/L2, T/L3						
	U/T1, V/T2, W/T3						
	-, +1						
	B1, B2						
	⊕						
4103	R/L1, S/L2, T/L3						
	U/T1, V/T2, W/T3						
	-, +1						
	B1, B2						
	⊕						
4140	R/L1, S/L2, T/L3						
	U/T1, V/T2, W/T3						
	-, -, +1, +1						
	B1, B2						
	⊕						
4168	R/L1, S/L2, T/L3						
	U/T1, V/T2, W/T3						
	-, -, +1, +1						
	B1, B2						
	⊕						

4.2 European Standards

Model	Terminal	For Europe and China		Wire Stripping Length mm */	Terminal Screw		Tightening Torque N·m (lb·in)
		Recommended Gauge mm ²	Wire Range mm ²		Size	Shape	
4208	R/L1, S/L2, T/L3						
	U/T1, V/T2, W/T3						
	-, +1						
	+3						
	⊕						
4250	R/L1, S/L2, T/L3						
	U/T1, V/T2, W/T3						
	-, +1						
	+3						
	⊕						
4296	R/L1, S/L2, T/L3						
	U/T1, V/T2, W/T3						
	-, +1						
	+3						
	⊕						
4371	R/L1, S/L2, T/L3						
	U/T1, V/T2, W/T3						
	-, +1						
	+3						
	⊕						
4414	R/L1, S/L2, T/L3						
	U/T1, V/T2, W/T3						
	-, +1						
	+3						
	⊕						
4453	R/L1, S/L2, T/L3 R1/L11, S1/L21, T1/L31						
	U/T1, V/T2, W/T3						
	-, +1						
	+3						
	⊕						

Model	Terminal	For Europe and China		Wire Stripping Length mm */	Terminal Screw		Tightening Torque N·m (lb·in)
		Recommended Gauge mm ²	Wire Range mm ²		Size	Shape	
4568	R/L1, S/L2, T/L3 R1/L11, S1/L21, T1/L31	Preparing					
	U/T1, V/T2, W/T3						
	-, +1						
	+3						
	⊕						
4675	R/L1, S/L2, T/L3 R1/L11, S1/L21, T1/L31	Preparing					
	U/T1, V/T2, W/T3						
	-, +1						
	+3						
	⊕						

*1 Remove the insulator from the tips of wires to the length shown in "Wire Stripping Length."

*2 When using wire with a gauge over 30 mm², tighten to a tightening torque of 4.1 to 4.5 N·m (36 to 40 lb·in.).

*3 Install ELCB to maintain compliance with IEC/EN 61800-5-1:2007 with use of wire of this gauge.

■ Drive Circuit Protection

Install the drive circuit protection devices listed in the following tables on the input side of the drive to comply with IEC/EN61800-5-1:2007 and in the event of a short circuit in the internal circuitry.

NOTICE: Do not energize the power or operate equipment soon after a fuse blows or the circuit breaker (ELCB) trips. Check the condition of cable wiring and peripheral devices to identify the root cause. If the root cause cannot be determined, do not turn on the power or operate equipment. Contact Yaskawa Support immediately.

Three-Phase 200 V Class

Table 4.4 Factory Recommended Drive Branch Circuit Protection (200 V Class)

Drive Model	Semiconductor Protection Fuse Rated Current Manufacturer: EATON/Bussmann
2004	FWH-45B
2006	FWH-45B
2008	FWH-45B
2010	FWH-45B
2012	FWH-50B
2018	FWH-80B
2021	FWH-80B
2030	FWH-125B
2042	FWH-150B
2056	FWH-200B
2070	FWH-225A
2082	FWH-225A FWH-250A */
2110	FWH-225A FWH-250A */

4.2 European Standards

Drive Model	Semiconductor Protection Fuse Rated Current Manufacturer: EATON/Bussmann
2138 *2	FWH-275A FWH-300A *1
2169 *2	FWH-275A FWH-350A *1
2211 *2	FWH-325A FWH-450A *1
2257 *2	FWH-600A
2313 *2	FWH-800A
2360 *2	FWH-1000A
2415 *2	FWH-1400A

*1 Fuses with larger rated currents are recommended for application with repetitive operations.

*2 Approval pending. Contact Yaskawa or your nearest sales representative.

Three-Phase 400 V Class

Table 4.5 Factory Recommended Drive Branch Circuit Protection (400 V Class)

Drive Model	Semiconductor Protection Fuse Rated Current Manufacturer: EATON/Bussmann
4002	FWH-50B
4004	FWH-50B
4005	FWH-50B
4007	FWH-60B
4009	FWH-60B
4012	FWH-60B
4018	FWH-80B
4023	FWH-90B
4031	FWH-150B
4038	FWH-200B
4044	FWH-200B
4060	FWH-225A
4075	FWH-250A
4089	FWH-275A
4103 *1	FWH-275A
4140 *1	FWH-300A
4168 *1	FWH-325A FWH-400A *2
4208 *1	FWH-500A
4250 *1	FWH-600A
4296 *1	FWH-700A
4371 *1	FWH-800A
4414 *1	FWH-1000A
4453 *1	FWH-1200A
4568 *1	FWH-1200A
4675 *1	FWH-1400A FWH-1600A *2

*1 Approval pending. Contact Yaskawa or your nearest sales representative.

*2 Fuses with larger rated currents are recommended for application with repetitive operations.

■ CE Standards Compliance for DC Power Supply Input

Install a fuse to the DC power supply input to comply with CE Standards.

Figure 4.3 shows a wiring example for using a DC power supply with two drives connected in parallel.

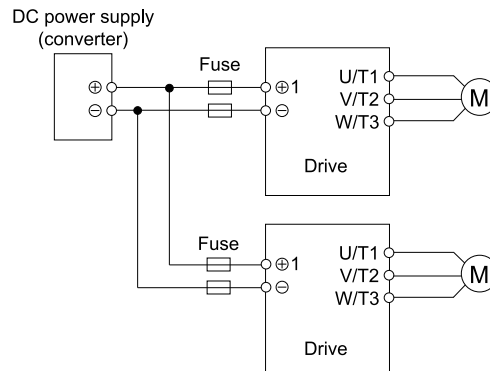

Figure 4.3 Wiring Example for DC Power Input

Note:

- Install a fuse to the DC power supply input for each drive when connecting multiple drives in parallel. Replace all fuses if any of the fuses blow.
- Use an external EMC filter and make sure if the system comply with the EMC Directive.
- Do not connect the DC bus line to the ground.

Refer to Table 4.6 and Table 4.7 for the recommended fuses and fuse holders.

Three-Phase 200 V Class

Table 4.6 Recommended Fuse (Three-Phase 200 V Class)

Drive Model	Fuse Manufacturer: Bussmann	
	Model	Qty
2004	FWH-45B	2
2006	FWH-45B	2
2008	FWH-45B	2
2010	FWH-45B	2
2012	FWH-50B	2
2018	FWH-80B	2
2021	FWH-80B	2
2030	FWH-125B	2
2042	FWH-150B	2
2056	FWH-200B	2
2070	FWH-250A	2
2082	FWH-250A FWH-300A ^{*/}	2
2110	FWH-250A FWH-275A ^{*/}	2
2138 ^{*2}	FWH-300A FWH-350A ^{*/}	2
2169 ^{*2}	FWH-350A FWH-450A ^{*/}	2
2211 ^{*2}	FWH-450A FWH-600A ^{*/}	2
2257 ^{*2}	FWH-600A FWH-700A ^{*/}	2

4.2 European Standards

Drive Model	Fuse Manufacturer: Bussmann	
	Model	Qty
2313 *2	FWH-800A FWH-1000A *1	2
2360 *2	FWH-1000A	2
2415 *2	FWH-1400A	2

*1 Fuses with larger rated currents are recommended for applications with repetitive operations.

*2 Approval pending. Contact Yaskawa or your nearest sales representative.

Three-Phase 400 V Class

Table 4.7 Recommended Fuse (Three-Phase 400 V Class)

Drive Model	Fuse Manufacturer: Bussmann	
	Model	Qty
4002	FWH-50B	2
4004	FWH-50B	2
4005	FWH-50B	2
4007	FWH-60B	2
4009	FWH-60B	2
4012	FWH-60B	2
4018	FWH-80B	2
4023	FWH-90B	2
4031	FWH-150B	2
4038	FWH-200B	2
4044	FWH-200B	2
4060	FWH-225A	2
4075	FWH-250A	2
4089 *1	FWH-275A	2
4103 *1	FWH-275A	2
4140 *1	FWH-300A FWH-325A *2	2
4168 *1	FWH-400A FWH-450A *2	2
4208 *1	FWH-500A FWH-600A *2	2
4250 *1	FWH-600A FWH-700A *2	2
4296 *1	FWH-700A FWH-800A *2	2
4371 *1	FWH-800A FWH-1000A *2	2
4389 *1	FWH-1000A FWH-1200A *2	2
4453 *1	FWH-1200A FWH-1400A *2	2
4568 *1	FWH-1200A FWH-1600A *2	2
4675 *1	FWH-1600A	2

- *1 Approval pending. Contact Yaskawa or your nearest sales representative.
 *2 Fuses with larger rated currents are recommended for applications with repetitive operations.

◆ EMC Directive

The drive was tested in accordance with European standard EN 61800-3:2004+A1:2012, and is compliant with the EMC Directive.

Use drives with built-in EMC filters or install external EMC filters to the drive input side to comply with the EMC Directive. *Refer to Installing the External EMC Noise Filter on page 199* for the installation of the EMC filter.

■ Installing a Drive to Conform to the EMC Directive

Install drive models 2xxxB/C and 4xxxB/C as described in the following procedure to comply with the EMC Directive when the drive is a single unit or integrated into a larger device.

1. Attach the drive to a metal plate or other noncombustible material.
2. Wire the drive and motor.
3. Ground the shield braid of the braided shield cable to the metal plate. Yaskawa recommends using cable clamps.

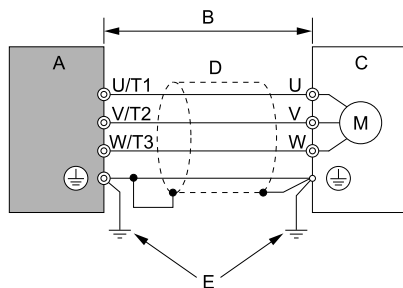

A - Drive
 B - 10 m (32.8 ft.) max.
 C - Motor
 D - Metal conduit
 E - Ground wire

Figure 4.4 Wiring the drive and motor

Note:

- Use braided shielded cable for the drive and motor wiring or pass the wires through a metal conduit.
- The maximum wiring length between the drive and motor is 10 m (32.8 ft).
- Keep the ground wire as short as possible.

4. Ground the motor cable using cable clamp to affix to the metal plate.

Note:

Make sure the protective earthing conductor complies with technical standards and local safety regulations.

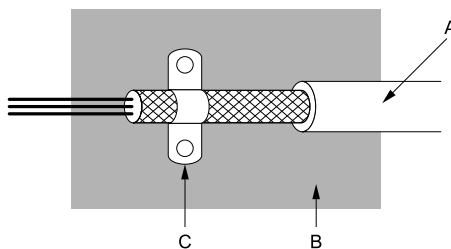

A - Braided shielded cable
 B - Metal plate
 C - Cable clamp (conductive)

Figure 4.5 Ground the shield

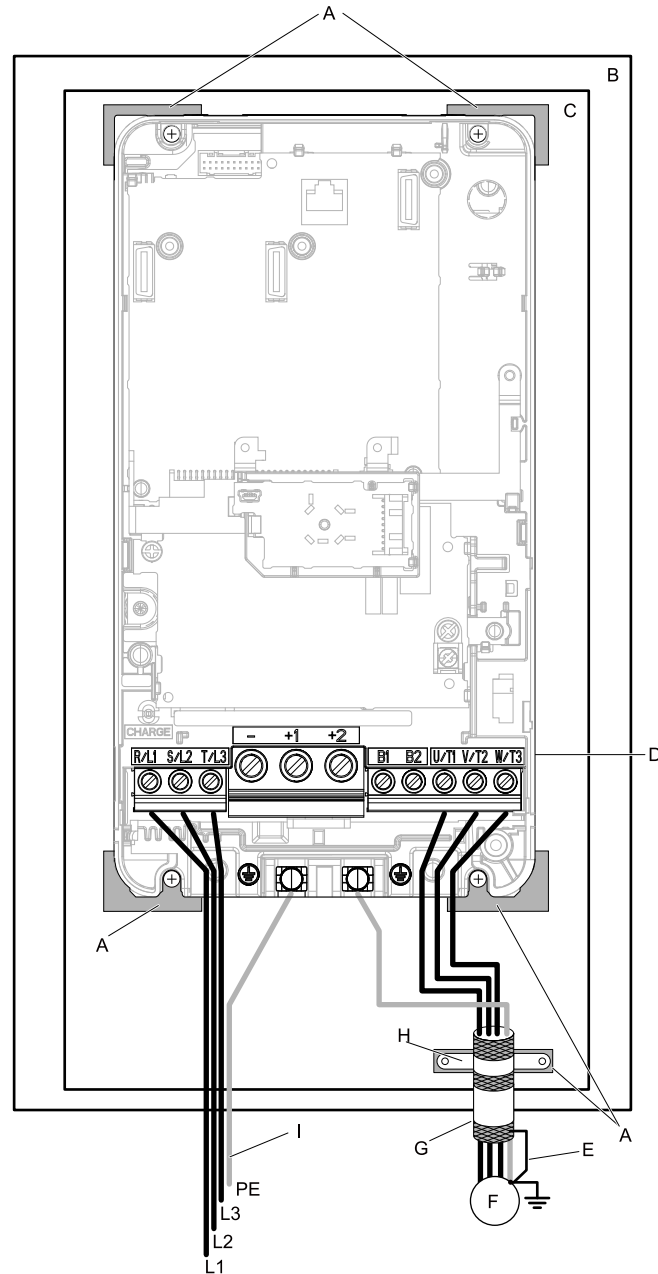

- | | |
|--|------------------------|
| A - Grounding surface (remove any paint or sealant) | F - Motor |
| B - Enclosure panel | G - Motor cable |
| C - Metal plate | H - Cable clamp |
| D - Drive | I - Ground wire |
| E - Shielded wire | |

Figure 4.6 Install a drive with a built-in EMC filter

5. Connect a DC reactor to reduce harmonic distortion. [Refer to DC Reactor on page 202](#) for details.

Note:

- Install a DC reactor specified in this manual for compliance with IEC/EN 61000-3-2 for drive models 2004, 2006, 4002, or 4004.
- The terminal blocks are different between the drive and the DC reactor. The drive has European type terminal blocks, and the DC reactor has screw type terminal blocks. Correctly prepare the ends of the wiring.

Ground Wiring

WARNING! Electrical Shock Hazard. Do not remove covers or touch the circuit boards while the power is on. Failure to comply could cause death or serious injury.

WARNING! Electrical Shock Hazard. Ensure that the neutral point on the power supply of this product (model number 2xxxB/C, 4xxxA/B/C) is grounded for compliance with the EMC Directive before EMC filter is switched ON or if there is high resistance grounding. Failure to comply could cause death or serious injury.

Enabling the Internal EMC Filter

To turn on (enable) and off (disable) the EMC filter built in the drive models 2xxxB, 2xxxC, 4xxxB, and 4xxxC, change the mounting position of the screw.

WARNING! *Electrical Shock Hazard. Confirm that the power to the drive is OFF and the CHARGE LED light is off before moving the EMC switch screws. Failure to comply could cause death or serious injury.*

WARNING! *Electrical Shock Hazard. Do not remove covers or touch the circuit boards while the power is on. Failure to comply could cause death or serious injury.*

WARNING! *Electrical Shock Hazard. Ensure that the neutral point on the power supply of this product (model number 2xxxB/C, 4xxxA/B/C) is grounded for compliance with the EMC Directive before EMC filter is switched ON or if there is high resistance grounding. Failure to comply could cause death or serious injury.*

WARNING! *Electrical Shock Hazard. Connect the ground cable correctly. Failure to comply could cause death or serious injury.*

NOTICE: *Do not completely remove the screws or tighten the screws to an incorrect torque when disabling the EMC filter. Failure to comply could cause drive failure.*

NOTICE: *Move the EMC switch screws to the OFF position for networks that are not symmetrically grounded. Failure to comply could cause damage to the drive.*

To make this product comply with the EMC Directive, confirm that the symmetric grounding network is applied, and mount the screw of the EMC filter switch to the ON position to turn on (enable) the built-in EMC filter. The screw of the EMC filter switch is set to OFF position by default.

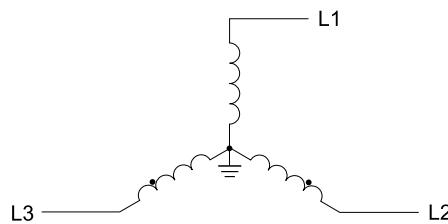

Figure 4.7 Symmetric Grounding

NOTICE: *When using a drive with a non-grounding network, high resistance grounding, asymmetric grounding network, place the screw for the EMC filter switch in the OFF position and disable the built-in EMC filter. Failure to follow the instructions may damage the drive.*

Table 4.8 shows the asymmetric grounding network.

Table 4.8 Asymmetric Grounding

Type of Grounding	Description
Grounding on a corner of the delta connection	
Grounding on a line of the delta connection	
Grounding on an end of the single-phase connection	
Three-phase variable transformer without neutral grounding	

Table 4.9 EMC Filter Switch Layout Drawing

Model	Switch layout drawing
2004B - 2042B, 4002B - 4023B 2004C - 2042C, 4002C - 4023C	Figure 4.8
2056B, 4031B, 4038B 2056C, 4031C, 4038C	Figure 4.9
2070B, 2082B, 4044B, 4060B 2070C, 2082C, 4044C, 4060C	Preparing
2110B, 4075B, 2138B - 2211B, 4089B - 4168B 2110C, 4075C, 2138C - 2211C, 4089C - 4168C	Preparing
2257B - 2415B, 4208B - 4675B 2257C - 2415C, 4208C - 4675C	Preparing

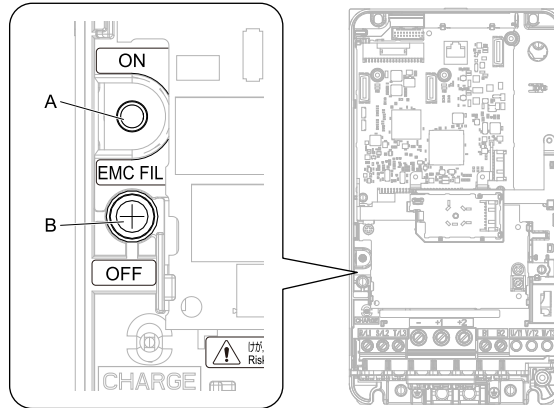

A - SW (ON)

B - Screw (OFF)

Figure 4.8 EMC Filter Switch Layout Drawing 1

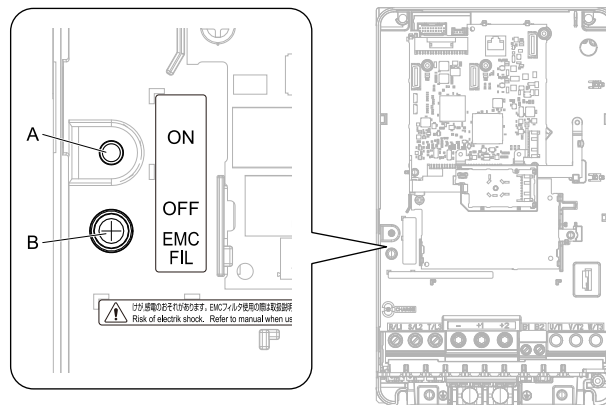

A - SW (ON)

B - Screw (OFF)

Figure 4.9 EMC Filter Switch Layout Drawing 2

If the screw of the EMC filter switch is lost, use a new one and tighten it to the specified tightening torque according the following table.

NOTICE: Use only the screws specified in this manual. Do not use different screws than what is recommended. Failure to comply could damage the drive.

Table 4.10 Screw Sizes and Tightening Torques

Model	Screw Size	Tightening Torque N·m
2004 - 2042, 4002 - 4023	M4 × 20	1.0 - 1.3
2056, 4031 - 4038	M4 × 20	1.0 - 1.3
2070, 4044, 4060	Preparing	Preparing

Model	Screw Size	Tightening Torque N·m
2082 - 2211, 4075 - 4168	Preparing	Preparing
2257 - 2415, 4208 - 4675	Preparing	Preparing

■ Installing the External EMC Noise Filter

This product (model: 2xxxA, 4xxxA) must satisfy the following conditions in order for it to comply with EN 61800-3:2004+A1:2012.

Be sure to connect a European standard-compliant EMC noise filter specified by Yaskawa to the input side (primary side). Refer to *External EMC Noise Filter Selection on page 201* for EMC noise filter selection.

Install the EMC noise filter following the procedure below so that machinery and devices inserted in the drive comply with the EMC Directive.

1. Install the drive and EMC noise filter on the same grounded metal plate.
2. Wire the drive and motor.
3. Ground the shield to the drive side and motor side.

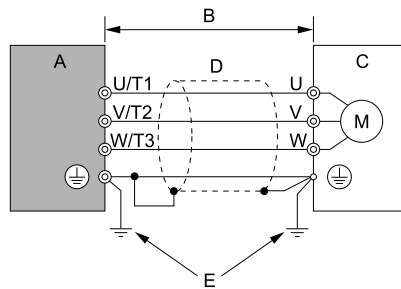

- A - Drive
- B - Max. 10 m (32.8 ft.)
- C - Motor
- D - Metal conduit
- E - Grounding wire

Figure 4.10 Wiring the Drive and Motor

Note:

- Wire the drive and motor using a braided shield cable or pass the wires through the metal conduit.
- Wiring length between the drive and motor is at least 10 m (32.8 ft.). The wiring should be as short as possible.
- The grounding wire should be as short as possible.

4. Fix and ground the motor cable to the metallic plate using the cable clamp.

Note:

Check to make sure that protective ground wire complies with technical standards and local safety regulations.

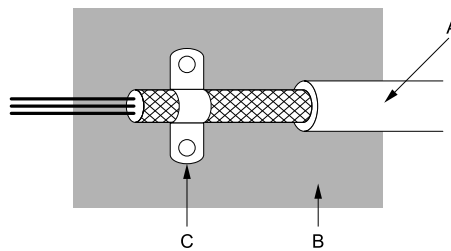

- A - Braided shield cable
- B - Metal plate
- C - Cable clamp (conductive)

Figure 4.11 Shield Grounding Method

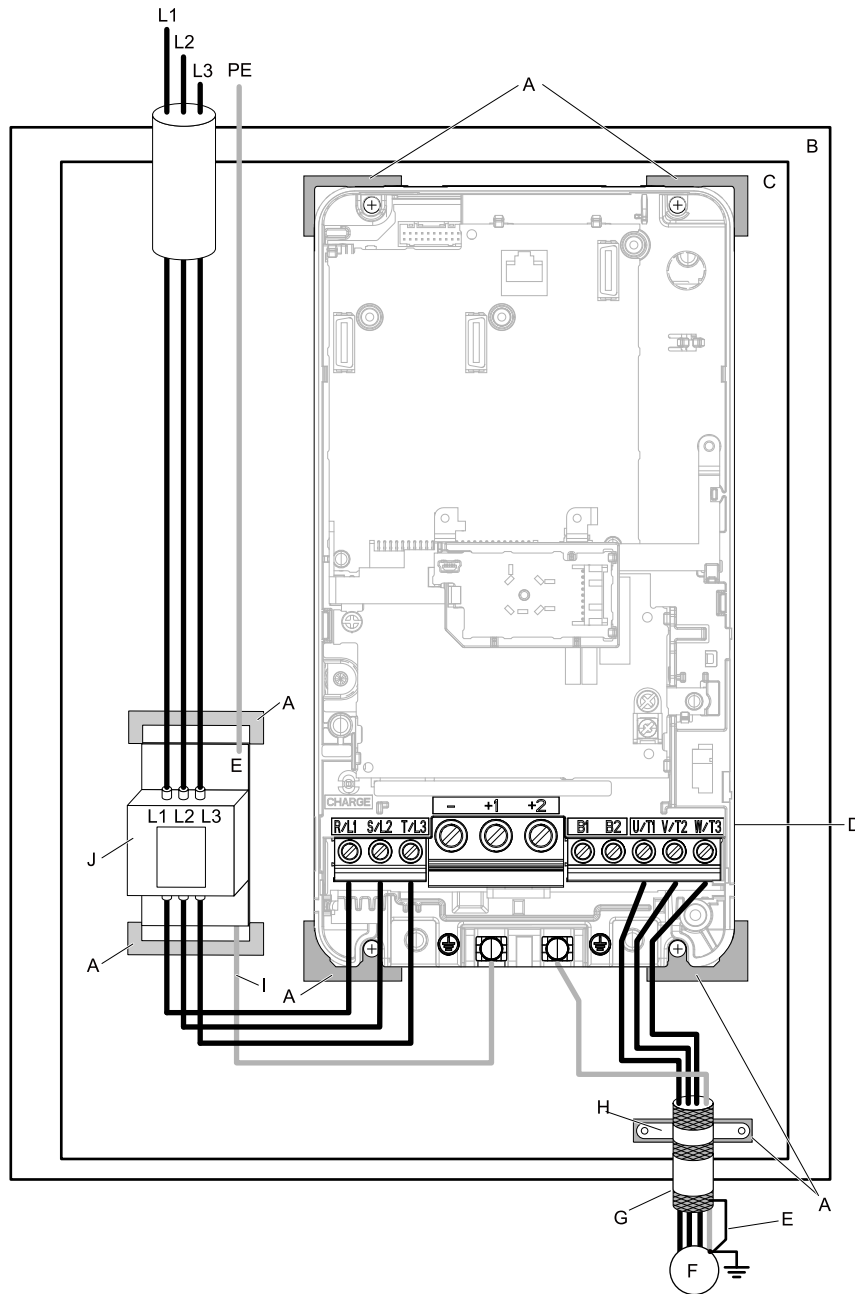

- | | |
|--|---|
| A - Grounding surface (Remove the paint.) | F - Motor |
| B - Control panel | G - Motor cable (Braided shield cable: max. 10 m (32.8 ft.)) |
| C - Metal plate | H - Cable clamp |
| D - Drive | I - Grounding wire |
| E - Ground the shield. | J - EMC noise filter |

Figure 4.12 EMC Noise Filter and Drive Installation Procedure

5. Connect the DC reactor to prevent harmonic distortion. [Refer to DC Reactor on page 202](#) for DC reactor selection.

Note:

- Install the DC reactor for drive models 2004, 2006, 4002, 4004 to maintain compliance with IEC/EN 61000-3-2.
- The main circuit terminal block for the drive, and the terminal blocks for the DC reactors come in different shapes. The drive comes with a European style terminal block, and the DC reactors come with a round terminal block. Take due care when preparing the ends of the wires.

Ground Wiring

WARNING! Electrical Shock Hazard. Do not remove covers or touch the circuit boards while the power is on. Failure to comply could cause death or serious injury.

WARNING! Electrical Shock Hazard. For the drive (model: 2xxxA, 4xxxA) to comply with the EMC Directive, be sure to ground its power supply with a neutral network. When your drive is not grounded with the neutral network or when it is grounded with a high resistance network, it may cause electrical shock.

External EMC Noise Filter Selection

Table 4.11 External EMC noise filter (2xxxA)

Model	EMC noise filter model Manufacturer: TDK	Quantity
2004A	RTEN-5006	1
2006A	RTEN-5010	1
2008A	RTEN-5010	1
2010A	RTEN-5020	1
2012A	RTEN-5020	1
2018A	RTEN-5030	1
2021A	RTEN-5030	1
2030A	RTEN-5060	1
2042A	RTEN-5060	1
2056A	RTEN-5080	1
2070A <i>*1</i>	RTHN-5100	1
2082A <i>*1</i>	RTHN-5200	1
2110A <i>*1</i>	RTHN-5200	1
2138A <i>*1</i>	RTHN-5200	1
2169A <i>*1</i>	RTHN-5200	1
2211A <i>*1</i>	RTHN-5200	1
2257A <i>*1</i>	RTHN-5150	2
2313A <i>*1</i>	RTHN-5200	2
2360A <i>*1</i>	RTHN-5200	2
2415A <i>*1</i>	RTHN-5200	2

*1 Approval pending. Contact Yaskawa or your nearest sales representative for details.

Table 4.12 External EMC noise filter (4xxxA)

Model	EMC noise filter model Manufacturer: TDK	Quantity
4002A	B84143A0010R106	1
4004A	B84143A0010R106	1
4005A	B84143A0010R106	1
4007A	B84143A0010R106	1
4009A	B84143A0020R106	1
4012A	B84143A0020R106	1
4018A	B84143A0035R106	1
4023A	B84143A0035R106	1
4031A	B84143A0050R106	1
4038A	B84143A0065R106	1
4044A <i>*1</i>	B84143A0065R106	1
4060A <i>*1</i>	B84143A0065R106	1
4075A <i>*1</i>	B84143A0080R106	1
4089A <i>*1</i>	B84143A0100R106	1
4103A <i>*1</i>	B84143B0150S020	1
4140A <i>*1</i>	B84143B0150S020	1
4168A <i>*1</i>	B84143B0180S020	1

4.2 European Standards

Model	EMC noise filter model Manufacturer: TDK	Quantity
4208A <i>*1</i>	B84143B0250S020	1
4250A <i>*1</i>	B84143B0250S020	1
4296A <i>*1</i>	B84143B0320S020	1
4371A <i>*1</i>	B84143B0400S020	1
4389A <i>*1</i>	B84143B0600S020	1
4453A <i>*1</i>	B84143B0600S020	1
4568A <i>*1</i>	B84143B0600S020	1
4675A <i>*1</i>	B84143B1000S020	1

*1 Approval pending. Contact Yaskawa or your nearest sales representative for details.

■ DC Reactor

Install a DC reactor for drive models 2004, 2006, 4002, and 4004 when using an internal or external EMC filter to comply with IEC/EN 61000-3-2. Refer to [Table 4.13](#) to select a DC reactor.

Table 4.13 DC Reactors for Harmonic Suppression (Manufacturer: Yaskawa Electric)

Drive Model	DC Reactor Model	DC Reactor Rating
2004	UZDA-B	5.4 A, 8 mH
2006	UZDA-B	5.4 A, 8 mH
4002	UZDA-B	3.2 A, 28 mH
4004	UZDA-B	3.2 A, 28 mH

4.3 UL Standards



Figure 4.13 UL/cUL Mark

The UL/cUL Mark indicates that this product satisfies stringent safety standards. This mark appears on products in the United States and Canada. It shows UL approval, indicating that it has been determined that the product complies with safety standards after undergoing strict inspection and assessment. UL-approved parts must be used for all major components that are built into electrical appliances that obtain UL approval.

This product has been tested in accordance with UL standard UL61800-5-1, and has been verified to be in compliance with UL standards.

Machines and devices integrated with this product must satisfy the following conditions for compliance with UL standards.

Contact Yaskawa or your nearest sales representative for details on models 2070 to 2415, 4044 to 4675.

◆ Area of Use

Install and use this product in a location of overvoltage category III and pollution degree 2 (UL standard) or less.

■ Ambient Temperature Setting

Maintain the ambient temperature within the following ranges according to the enclosure type.

- Enclosed wall-mounted type (UL Type 1): -10 °C to +40 °C (14 °F to 104 °F)
- Open chassis type (IP20): -10 °C to +50 °C (14 °F to 122 °F)

◆ Main Circuit Terminal Wiring

Follow the instructions in this manual when wiring the main circuit terminals.

Read through the following notes before wiring the screw clamp terminal blocks.

■ Notes on Wiring the Main Circuit Terminal Block

Note:

- Use copper wire. Non-copper wire such as aluminum wire cannot be used.
- Be sure remove any foreign objects on the wire connections for the terminal block.
- Remove the insulator from the connection wires to the wire stripping lengths listed in the manual.
- Do not use a wire with bent or crushed conductor. If a deformed wire is used for connection, cut off the bent end of the wire before using it.
- When using stranded wire, do not solder the conductor portion.
- When stranded wire is used, wire it so that no wire fibers protrude out of the connection. Do not excessively twist the stranded wire.
- Insert the wire until it is completely inside the terminal block. Once the insulator from the wire is removed to the suggested wire stripping length, the insulator will fit within the plastic housing.
- The tightening torque is different for each terminal. Tighten the screws to the specified tightening torque.
- Use a torque driver, torque ratchet or torque wrench that is designed for the screws. A flat end driver or a hex tool will be needed when wiring the screw clamp terminal. Refer to the recommended conditions listed in the product manual and provide tools accordingly.
- When using an electric driver to tighten, be especially careful and tighten at low speed, 300 to 400 r/min.
- Wiring tools can be purchased from Yaskawa. Contact Yaskawa or your nearest sales representative for details.
- When replacing your existing drive with this one, the existing wires may have wire gauges that are out of range of some of the gauges applicable to the new drive. For the usable and unusable wire gauges, contact Yaskawa or your nearest sales representative.
- After connecting the wires, gently pull on the wires to check that they do not pull out.
- Cut off an appropriate section of the wiring cover to facilitate the wiring.
- Regularly tighten any loose terminal block screws to their specified tightening torques.
- To protect the wiring connections from strain forces, be sure to secure wires near wiring parts using some sort of strain relief system. Refer to the following diagram.

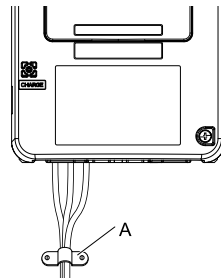

A - Strain relief

Figure 4.14 Wiring Example Using Strain Relief

Table 4.14 Recommended Wiring Tools

Screw Size	Screw Shape	Adapter	Bit Model	Torque Driver Model (Tightening Torque)	Torque Wrench Model	Manufacturer
M4	Slot (-)	Bit	SF-BIT-SL 1, 0X4,0-70	TSD-M 3NM (1.2 - 3 N·m)	-	PHOENIX CONTACT
M5	Slot (-)	Bit	SF-BIT-SL 1, 2X6,5-70	TSD-M 3NM (1.2 - 3 N·m) *1	*1	PHOENIX CONTACT
M6	Hex socket cap (WAF: 5 mm)	Socket	*2	-	*2	*2
M8	Hex socket cap (WAF: 6 mm)	Socket	*2	-	*2	*2
M10	Hex socket cap (WAF: 8 mm)	Socket	*2	-	*2	*2

*1 When wiring the drive models 2110 and 4075 or below, select tools correctly based on the wire gauges.

- ≤ 25 mm² (AWG 10): TSD-M 3NM
- ≥ 30 mm² (AWG 8): Torque wrench that includes a torque measurement range of 4.5 N·m

*2 Contact Yaskawa or your nearest sales representative for details.

■ Main Circuit Wire Gauges and Tightening Torques

Refer to [Table 4.15](#) and [Table 4.16](#) for the wire gauges and tightening torques of the main circuit terminals.

Comply with the local regulations applicable to the drive with regard to the correct wire gauges.

Note:

- Wire gauge recommendations based on drive continuous current ratings using 75 °C (167 °F) 600 V class 2 heat resistant indoor PVC wire.
- Use UL approved closed-loop crimp terminals for wires that connect to the main circuit terminal of drive models 2257 to 2415 and 4208 to 4675. Crimp the crimp terminal using a tool that is recommended by the manufacturer of the terminal.

Three-Phase 200 V Class

Table 4.15 Main Circuit Wire Gauges and Tightening Torques (Three-phase 200 V Class)

Model	Terminal	Recommended Gauge AWG, kcmil	Wire Range AWG, kcmil	Wire Stripping Length *1 mm	Terminal Screw		Tightening Torque N-m (lb-in)
					Terminal Screw Size	Shape	
2004	R/L1, S/L2, T/ L3	14	14 - 6	10	M4	Slot (-)	1.5 - 1.7 (13.5 - 15)
	U/T1, V/T2, W/ T3	14	14 - 6	10	M4	Slot (-)	1.5 - 1.7 (13.5 - 15)
	-, +1, +2	14	14 - 3	18	M5	Slot (-)	2.3 - 2.5 (19.8 - 22) *2
	B1, B2	14	14 - 10	10	M4	Slot (-)	1.5 - 1.7 (13.5 - 15)
	⊕	10	14 - 10	-	M4	Phillips/slot combo	1.2 - 1.5 (10.6 - 13.3)
2006	R/L1, S/L2, T/ L3	14	14 - 6	10	M4	Slot (-)	1.5 - 1.7 (13.5 - 15)
	U/T1, V/T2, W/ T3	14	14 - 6	10	M4	Slot (-)	1.5 - 1.7 (13.5 - 15)
	-, +1, +2	14	14 - 3	18	M5	Slot (-)	2.3 - 2.5 (19.8 - 22) *2
	B1, B2	14	14 - 10	10	M4	Slot (-)	1.5 - 1.7 (13.5 - 15)
	⊕	10	14 - 10	-	M4	Phillips/slot combo	1.2 - 1.5 (10.6 - 13.3)
2008	R/L1, S/L2, T/ L3	14	14 - 6	10	M4	Slot (-)	1.5 - 1.7 (13.5 - 15)
	U/T1, V/T2, W/ T3	14	14 - 6	10	M4	Slot (-)	1.5 - 1.7 (13.5 - 15)
	-, +1, +2	14	14 - 3	18	M5	Slot (-)	2.3 - 2.5 (19.8 - 22) *2
	B1, B2	14	14 - 10	10	M4	Slot (-)	1.5 - 1.7 (13.5 - 15)
	⊕	10	14 - 10	-	M4	Phillips/slot combo	1.2 - 1.5 (10.6 - 13.3)
2010	R/L1, S/L2, T/ L3	12	14 - 6	10	M4	Slot (-)	1.5 - 1.7 (13.5 - 15)
	U/T1, V/T2, W/ T3	14	14 - 6	10	M4	Slot (-)	1.5 - 1.7 (13.5 - 15)
	-, +1, +2	12	14 - 3	18	M5	Slot (-)	2.3 - 2.5 (19.8 - 22) *2
	B1, B2	14	14 - 10	10	M4	Slot (-)	1.5 - 1.7 (13.5 - 15)
	⊕	10	14 - 10	-	M4	Phillips/slot combo	1.2 - 1.5 (10.6 - 13.3)

4.3 UL Standards

Model	Terminal	Recommended Gauge AWG, kcmil	Wire Range AWG, kcmil	Wire Stripping Length *1 mm	Terminal Screw		Tightening Torque N-m (lb-in)
					Terminal Screw Size	Shape	
2012	R/L1, S/L2, T/ L3	10	14 - 6	10	M4	Slot (-)	1.5 - 1.7 (13.5 - 15)
	U/T1, V/T2, W/ T3	12	14 - 6	10	M4	Slot (-)	1.5 - 1.7 (13.5 - 15)
	-, +1, +2	10	14 - 3	18	M5	Slot (-)	2.3 - 2.5 (19.8 - 22) *2
	B1, B2	14	14 - 10	10	M4	Slot (-)	1.5 - 1.7 (13.5 - 15)
	⊕	10	14 - 10	-	M4	Phillips/slot combo	1.2 - 1.5 (10.6 - 13.3)
2018	R/L1, S/L2, T/ L3	10	14 - 6	10	M4	Slot (-)	1.5 - 1.7 (13.5 - 15)
	U/T1, V/T2, W/ T3	10	14 - 6	10	M4	Slot (-)	1.5 - 1.7 (13.5 - 15)
	-, +1, +2	8	14 - 3	18	M5	Slot (-)	2.3 - 2.5 (19.8 - 22) *2
	B1, B2	14	14 - 10	10	M4	Slot (-)	1.5 - 1.7 (13.5 - 15)
	⊕	10	14 - 10	-	M4	Phillips/slot combo	1.2 - 1.5 (10.6 - 13.3)
2021	R/L1, S/L2, T/ L3	8	14 - 6	10	M4	Slot (-)	1.5 - 1.7 (13.5 - 15)
	U/T1, V/T2, W/ T3	10	14 - 6	10	M4	Slot (-)	1.5 - 1.7 (13.5 - 15)
	-, +1, +2	8	14 - 3	18	M5	Slot (-)	2.3 - 2.5 (19.8 - 22) *2
	B1, B2	14	14 - 10	10	M4	Slot (-)	1.5 - 1.7 (13.5 - 15)
	⊕	10	12 - 10	-	M4	Phillips/slot combo	1.2 - 1.5 (10.6 - 13.3)
2030	R/L1, S/L2, T/ L3	6	14 - 6	10	M4	Slot (-)	1.5 - 1.7 (13.5 - 15)
	U/T1, V/T2, W/ T3	8	14 - 6	10	M4	Slot (-)	1.5 - 1.7 (13.5 - 15)
	-, +1, +2	6	14 - 3	18	M5	Slot (-)	2.3 - 2.5 (19.8 - 22) *2
	B1, B2	12	14 - 10	10	M4	Slot (-)	1.5 - 1.7 (13.5 - 15)
	⊕	8	10 - 8	-	M5	Phillips/slot combo	2.0 - 2.5 (17.7 - 22.1)

Model	Terminal	Recommended Gauge AWG, kcmil	Wire Range AWG, kcmil	Wire Stripping Length ^{*/} mm	Terminal Screw		Tightening Torque N·m (lb·in)
					Terminal Screw Size	Shape	
2042	R/L1, S/L2, T/ L3	6	14 - 6	10	M4	Slot (-)	1.5 - 1.7 (13.5 - 15)
	U/T1, V/T2, W/ T3	6	14 - 6	10	M4	Slot (-)	1.5 - 1.7 (13.5 - 15)
	-, +1, +2	3	14 - 3	18	M5	Slot (-)	2.3 - 2.5 (19.8 - 22) ^{*2}
	B1, B2	10	14 - 10	10	M4	Slot (-)	1.5 - 1.7 (13.5 - 15)
	⊕	8	10 - 8	-	M5	Phillips/slot combo	2.0 - 2.5 (17.7 - 22.1)
2056	R/L1, S/L2, T/ L3	3	8 - 3	18	M5	Slot (-)	2.3 - 2.5 (19.8 - 22) ^{*2}
	U/T1, V/T2, W/ T3	4	10 - 4	18	M5	Slot (-)	2.3 - 2.5 (19.8 - 22) ^{*2}
	-, +1, +2	1	8 - 1	20	M6	Hex socket cap (WAF: 5 mm)	5 - 5.5 (45 - 49)
	B1, B2	8	14 - 8	10	M4	Slot (-)	1.5 - 1.7 (13.5 - 15)
	⊕	6	8 - 6	-	M6	Phillips/slot combo	5.4 - 6.0 (47.8 - 53.1)
2070	R/L1, S/L2, T/ L3	Preparing					
	U/T1, V/T2, W/ T3						
	-, +1, +2						
	B1, B2						
	⊕						
2082	R/L1, S/L2, T/ L3	Preparing					
	U/T1, V/T2, W/ T3						
	-, +1, +2						
	B1, B2						
	⊕						
2110	R/L1, S/L2, T/ L3	Preparing					
	U/T1, V/T2, W/ T3						
	-, +1						
	B1, B2						
	⊕						

4.3 UL Standards

Model	Terminal	Recommended Gauge AWG, kcmil	Wire Range AWG, kcmil	Wire Stripping Length *1 mm	Terminal Screw		Tightening Torque N-m (lb-in)
					Terminal Screw Size	Shape	
2138	R/L1, S/L2, T/ L3						
	U/T1, V/T2, W/ T3						
	-, +1						
	B1, B2						
	⊕						
2169	R/L1, S/L2, T/ L3						
	U/T1, V/T2, W/ T3						
	-, -, +1, +1						
	+3						
	⊕						
2211	R/L1, S/L2, T/ L3						
	U/T1, V/T2, W/ T3						
	-, -, +1, +1						
	+3						
	⊕						
2257	R/L1, S/L2, T/ L3						
	U/T1, V/T2, W/ T3						
	-, +1						
	+3						
	⊕						
2313	R/L1, S/L2, T/ L3						
	U/T1, V/T2, W/ T3						
	-, +1						
	+3						
	⊕						
2360	R/L1, S/L2, T/ L3						
	U/T1, V/T2, W/ T3						
	-, +1						
	+3						
	⊕						

Model	Terminal	Recommended Gauge AWG, kcmil	Wire Range AWG, kcmil	Wire Stripping Length ^{*/} mm	Terminal Screw		Tightening Torque N·m (lb·in)
					Terminal Screw Size	Shape	
2415	R/L1, S/L2, T/ L3				Preparing		
	U/T1, V/T2, W/ T3						
	-, +1						
	+3						
	⊕						

*1 Remove the insulator from the tips of wires to the length shown in "Wire Stripping Length."

*2 When using wire with AWG 8 or higher, tighten to a tightening torque of 4.1 to 4.5 N·m (36 to 40 lb·in.).

Three-Phase 400 V Class

Table 4.16 Main Circuit Wire Gauges and Tightening Torques (Three-phase 400 V Class)

Model	Terminal	Recommended Gauge AWG, kcmil	Wire Range AWG, kcmil	Wire Stripping Length ^{*/} mm	Terminal Screw		Tightening Torque N·m (lb·in)
					Size	Shape	
4002	R/L1, S/L2, T/ L3	14	14 - 6	10	M4	Slot (-)	1.5 - 1.7 (13.5 - 15)
	U/T1, V/T2, W/ T3	14	14 - 6	10	M4	Slot (-)	1.5 - 1.7 (13.5 - 15)
	-, +1, +2	14	14 - 3	18	M5	Slot (-)	2.3 - 2.5 (19.8 - 22) ^{*2}
	B1, B2	14	14 - 10	10	M4	Slot (-)	1.5 - 1.7 (13.5 - 15)
	⊕	12	14 - 12	-	M4	Phillips/slot combo	1.2 - 1.5 (10.6 - 13.3)
4004	R/L1, S/L2, T/ L3	14	14 - 6	10	M4	Slot (-)	1.5 - 1.7 (13.5 - 15)
	U/T1, V/T2, W/ T3	14	14 - 6	10	M4	Slot (-)	1.5 - 1.7 (13.5 - 15)
	-, +1, +2	14	14 - 3	18	M5	Slot (-)	2.3 - 2.5 (19.8 - 22) ^{*2}
	B1, B2	14	14 - 10	10	M4	Slot (-)	1.5 - 1.7 (13.5 - 15)
	⊕	12	14 - 12	-	M4	Phillips/slot combo	1.2 - 1.5 (10.6 - 13.3)
4005	R/L1, S/L2, T/ L3	14	14 - 6	10	M4	Slot (-)	1.5 - 1.7 (13.5 - 15)
	U/T1, V/T2, W/ T3	14	14 - 6	10	M4	Slot (-)	1.5 - 1.7 (13.5 - 15)
	-, +1, +2	14	14 - 3	18	M5	Slot (-)	2.3 - 2.5 (19.8 - 22) ^{*2}
	B1, B2	14	14 - 10	10	M4	Slot (-)	1.5 - 1.7 (13.5 - 15)
	⊕	10	14 - 10	-	M4	Phillips/slot combo	1.2 - 1.5 (10.6 - 13.3)

4.3 UL Standards

Model	Terminal	Recommended Gauge AWG, kcmil	Wire Range AWG, kcmil	Wire Stripping Length *1 mm	Terminal Screw		Tightening Torque N·m (lb·in)
					Size	Shape	
4007	R/L1, S/L2, T/ L3	14	14 - 6	10	M4	Slot (-)	1.5 - 1.7 (13.5 - 15)
	U/T1, V/T2, W/ T3	14	14 - 6	10	M4	Slot (-)	1.5 - 1.7 (13.5 - 15)
	-, +1, +2	14	14 - 3	18	M5	Slot (-)	2.3 - 2.5 (19.8 - 22) *2
	B1, B2	14	14 - 10	10	M4	Slot (-)	1.5 - 1.7 (13.5 - 15)
	⊕	10	14 - 10	-	M4	Phillips/slot combo	1.2 - 1.5 (10.6 - 13.3)
4009	R/L1, S/L2, T/ L3	14	14 - 6	10	M4	Slot (-)	1.5 - 1.7 (13.5 - 15)
	U/T1, V/T2, W/ T3	14	14 - 6	10	M4	Slot (-)	1.5 - 1.7 (13.5 - 15)
	-, +1, +2	12	14 - 3	18	M5	Slot (-)	2.3 - 2.5 (19.8 - 22) *2
	B1, B2	14	14 - 10	10	M4	Slot (-)	1.5 - 1.7 (13.5 - 15)
	⊕	10	14 - 10	-	M4	Phillips/slot combo	1.2 - 1.5 (10.6 - 13.3)
4012	R/L1, S/L2, T/ L3	12	14 - 6	10	M4	Slot (-)	1.5 - 1.7 (13.5 - 15)
	U/T1, V/T2, W/ T3	14	14 - 6	10	M4	Slot (-)	1.5 - 1.7 (13.5 - 15)
	-, +1, +2	10	14 - 3	18	M5	Slot (-)	2.3 - 2.5 (19.8 - 22) *2
	B1, B2	14	14 - 10	10	M4	Slot (-)	1.5 - 1.7 (13.5 - 15)
	⊕	10	14 - 10	-	M4	Phillips/slot combo	1.2 - 1.5 (10.6 - 13.3)
4018	R/L1, S/L2, T/ L3	10	14 - 6	10	M4	Slot (-)	1.5 - 1.7 (13.5 - 15)
	U/T1, V/T2, W/ T3	10	14 - 6	10	M4	Slot (-)	1.5 - 1.7 (13.5 - 15)
	-, +1, +2	8	14 - 3	18	M5	Slot (-)	2.3 - 2.5 (19.8 - 22) *2
	B1, B2	14	14 - 10	10	M4	Slot (-)	1.5 - 1.7 (13.5 - 15)
	⊕	10	14 - 10	-	M5	Phillips/slot combo	2.0 - 2.5 (17.7 - 22.1)

Model	Terminal	Recommended Gauge AWG, kcmil	Wire Range AWG, kcmil	Wire Stripping Length ^{*/} mm	Terminal Screw		Tightening Torque N·m (lb·in)
					Size	Shape	
4023	R/L1, S/L2, T/ L3	8	14 - 6	10	M4	Slot (-)	1.5 - 1.7 (13.5 - 15)
	U/T1, V/T2, W/ T3	10	14 - 6	10	M4	Slot (-)	1.5 - 1.7 (13.5 - 15)
	-, +1, +2	8	14 - 3	18	M5	Slot (-)	2.3 - 2.5 (19.8 - 22) ^{*2}
	B1, B2	12	14 - 10	10	M4	Slot (-)	1.5 - 1.7 (13.5 - 15)
	⊕	10	12 - 10	-	M5	Phillips/slot combo	2.0 - 2.5 (17.7 - 22.1)
4031	R/L1, S/L2, T/ L3	6	8 - 3	18	M5	Slot (-)	2.3 - 2.5 (19.8 - 22) ^{*2}
	U/T1, V/T2, W/ T3	8	10 - 4	18	M5	Slot (-)	2.3 - 2.5 (19.8 - 22) ^{*2}
	-, +1, +2	6	8 - 1	20	M6	Hex socket cap (WAF: 5 mm)	5 - 5.5 (45 - 49)
	B1, B2	10	14 - 8	10	M4	Slot (-)	1.5 - 1.7 (13.5 - 15)
	⊕	8	10 - 8	-	M6	Phillips/slot combo	5.4 - 6.0 (47.8 - 53.1)
4038	R/L1, S/L2, T/ L3	6	8 - 3	18	M5	Slot (-)	2.3 - 2.5 (19.8 - 22) ^{*2}
	U/T1, V/T2, W/ T3	8	10 - 4	18	M5	Slot (-)	2.3 - 2.5 (19.8 - 22) ^{*2}
	-, +1, +2	4	8 - 1	20	M6	Hex socket cap (WAF: 5 mm)	5 - 5.5 (45 - 49)
	B1, B2	10	14 - 8	10	M4	Slot (-)	1.5 - 1.7 (13.5 - 15)
	⊕	6	10 - 6	-	M6	Phillips/slot combo	5.4 - 6.0 (47.8 - 53.1)
4044	R/L1, S/L2, T/ L3	Preparing					
	U/T1, V/T2, W/ T3						
	-, +1, +2						
	B1, B2						
	⊕						
4060	R/L1, S/L2, T/ L3	Preparing					
	U/T1, V/T2, W/ T3						
	-, +1						
	B1, B2						
	⊕						

4.3 UL Standards

Model	Terminal	Recommended Gauge AWG, kcmil	Wire Range AWG, kcmil	Wire Stripping Length *1 mm	Terminal Screw		Tightening Torque N-m (lb-in)
					Size	Shape	
4075	R/L1, S/L2, T/ L3						
	U/T1, V/T2, W/ T3						
	-, +1						
	B1, B2						
	⊕						
4089	R/L1, S/L2, T/ L3						
	U/T1, V/T2, W/ T3						
	-, +1						
	B1, B2						
	⊕						
4103	R/L1, S/L2, T/ L3						
	U/T1, V/T2, W/ T3						
	-, +1						
	B1, B2						
	⊕						
4140	R/L1, S/L2, T/ L3						
	U/T1, V/T2, W/ T3						
	-, -, +1, +1						
	B1, B2						
	⊕						
4168	R/L1, S/L2, T/ L3						
	U/T1, V/T2, W/ T3						
	-, -, +1, +1						
	B1, B2						
	⊕						
4208	R/L1, S/L2, T/ L3						
	U/T1, V/T2, W/ T3						
	-, +1						
	+3						
	⊕						

Model	Terminal	Recommended Gauge AWG, kcmil	Wire Range AWG, kcmil	Wire Stripping Length ^{*/} mm	Terminal Screw		Tightening Torque N·m (lb·in)
					Size	Shape	
4250	R/L1, S/L2, T/ L3						Preparing
	U/T1, V/T2, W/ T3						
	-, +1						
	+3						
	⊕						
4296	R/L1, S/L2, T/ L3						Preparing
	U/T1, V/T2, W/ T3						
	-, +1						
	+3						
	⊕						
4371	R/L1, S/L2, T/ L3						Preparing
	U/T1, V/T2, W/ T3						
	-, +1						
	+3						
	⊕						
4389	R/L1, S/L2, T/ L3						Preparing
	U/T1, V/T2, W/ T3						
	-, +1						
	+3						
	⊕						
4453	R/L1, S/L2, T/ L3, R1/L11, S1/ L21, T1/L31						Preparing
	U/T1, V/T2, W/ T3						
	-, +1						
	+3						
	⊕						
4568	R/L1, S/L2, T/ L3, R1/L11, S1/ L21, T1/L31						Preparing
	U/T1, V/T2, W/ T3						
	-, +1						
	+3						
	⊕						

4.3 UL Standards

Model	Terminal	Recommended Gauge AWG, kcmil	Wire Range AWG, kcmil	Wire Stripping Length ^{*1} mm	Terminal Screw		Tightening Torque N·m (lb·in)
					Size	Shape	
4675	R/L1, S/L2, T/ L3, R1/L11, S1/ L21, T1/L31			Preparing			
	U/T1, V/T2, W/ T3						
	-, +1						
	+3						
	⊕						

*1 Remove the insulator from the tips of wires to the length shown in “Wire Stripping Length.”

*2 When using wire with AWG 8 or higher, tighten to a tightening torque of 4.1 to 4.5 N·m (36 to 40 lb·in.).

■ Closed-Loop Crimp Terminals

Yaskawa recommends closed-loop crimp terminals from J.S.T.MFG. Co., Ltd., and insulation caps from Tokyo DIP Co., Ltd.

Contact Yaskawa or your nearest sales representative for details on selection of closed-loop crimp terminals and insulation caps.

Follow local standards concerning appropriate wire gauges in the region where the drive is used.

Note:

Use only insulated crimp terminals or crimp terminals with insulation tubing to comply with UL standards. Use UL-Listed, vinyl-coated insulated copper wires for operation with a continuous maximum allowable temperature of 75 °C at 600 V.

■ Factory Recommended Branch Circuit Protection

To maintain compliance with UL61800-5-1, execute branch circuit protection when a short occurs in the internal circuit. Yaskawa recommends connecting a semiconductor protective type fuses to the input side for branch circuit protection. Refer to [Table 4.17](#) to [Table 4.20](#) for the recommended fuses.

NOTICE: Do not energize the power or operate equipment soon after a fuse blows or the circuit breaker (ELCB) trips. Check the condition of cable wiring and peripheral devices to identify the root cause. If the root cause cannot be determined, do not turn on the power or operate equipment. Contact Yaskawa Support immediately.

- 200 V class

The drive is suitable for use on a circuit capable of delivering not more than 100,000 RMS symmetrical amperes and 240 Vac during short circuit of the power supply, when protected by fuses as specified in this document.

- 400 V class

The drive is suitable for use on a circuit capable of delivering not more than 100,000 RMS symmetrical amperes and 480 Vac during short circuit of the power supply, when protected by fuses as specified in this document.

Drive's built-in short circuit protection does not provide branch circuit protection. Branch circuit protection must be provided in accordance with the NEC (National Electric Code) the CEC (Canadian Electric Code, Part I), and any additional local codes.

Three-Phase 200 V Class

Table 4.17 Factory Recommended Drive Branch Circuit Protection (Normal Duty)

Drive Model	Maximum Applicable Motor Output kW (HP)	Input Current Rating A	Semiconductor Fuse Model Manufacturer: EATON/ Bussmann
2004	0.75 (0.75)	4.8	FWH-45B
2006	1.1 (1.5)	6.7	FWH-45B
2008	1.1 (1.5)	6.7	FWH-45B
2010	2.2 (3)	12.7	FWH-45B
2012	3 (4)	17	FWH-100B
2018	3.7 (5)	20.7	FWH-100B
2021	5.5 (7.5)	30	FWH-100B
2030	7.5 (10)	40.3	FWH-125B

Drive Model	Maximum Applicable Motor Output kW (HP)	Input Current Rating A	Semiconductor Fuse Model Manufacturer: EATON/ Bussmann
2042	11 (15)	52	FWH-150B
2056	15 (20)	78.4	FWH-200B
2070 *1	18.5 (25)	96	FWH-225A
2082 *1	22 (30)	114	FWH-225A FWH-250A *2
2110 *1	30 (40)	111	FWH-225A FWH-250A *2
2138 *1	37 (50)	136	FWH-275A FWH-300A *2
2169 *1	45 (60)	164	FWH-275A FWH-350A *2
2211 *1	55 (75)	200	FWH-325A FWH-450A *2
2257 *1	75 (100)	271	FWH-600A
2313 *1	90 (125)	324	FWH-800A
2360 *1	110 (150)	394	FWH-1000A
2415 *1	-	-	FWH-1400A

*1 Approval pending. Contact Yaskawa or your nearest sales representative.

*2 Fuses with larger rated currents are recommended for application with repetitive operations.

Table 4.18 Factory Recommended Drive Branch Circuit Protection (Heavy Duty)

Drive Model	Maximum Applicable Motor Output kW (HP)	Input Current Rating A	Semiconductor Fuse Model Manufacturer: EATON/ Bussmann
2004	0.55 (0.5)	3.6	FWH-45B
2006	0.75 (1)	4.8	FWH-45B
2008	0.75 (1)	4.8	FWH-45B
2010	1.5 (2)	8.9	FWH-45B
2012	2.2 (3)	12.7	FWH-50B
2018	3 (4)	17	FWH-80B
2021	3.7 (5)	20.7	FWH-80B
2030	5.5 (7.5)	30	FWH-125B
2042	7.5 (10)	40.3	FWH-150B
2056	11 (15)	58.2	FWH-200B
2070 *1	15 (20)	78.4	FWH-225A
2082 *1	18.5 (25)	96	FWH-225A FWH-250A *2
2110 *1	22 (30)	82	FWH-225A FWH-250A *2
2138 *1	30 (40)	111	FWH-275A FWH-300A *2
2169 *1	37 (50)	136	FWH-275A FWH-350A *2
2211 *1	45 (60)	164	FWH-325A FWH-450A *2
2257 *1	55 (75)	200	FWH-600A
2313 *1	75 (100)	271	FWH-800A

4.3 UL Standards

Drive Model	Maximum Applicable Motor Output kW (HP)	Input Current Rating A	Semiconductor Fuse Model Manufacturer: EATON/ Bussmann
2360 *1	90 (125)	324	FWH-1000A
2415 *1	110 (150)	394	FWH-1400A

*1 Approval pending. Contact Yaskawa or your nearest sales representative.

*2 Fuses with larger rated currents are recommended for application with repetitive operations.

Three-Phase 400 V Class

Table 4.19 Factory Recommended Drive Branch Circuit Protection (Normal Duty)

Drive Model	Maximum Applicable Motor Output kW (HP)	Input Current Rating A	Semiconductor Fuse Model Manufacturer: EATON/ Bussmann
4002	0.75 (1)	2.5	FWH-50B
4004	1.5 (2)	4.7	FWH-50B
4005	2.2 (3)	6.7	FWH-50B
4007	3.0 (4)	8.9	FWH-60B
4009	3.7 (5)	11.7	FWH-60B
4012	5.5 (7.5)	15.8	FWH-60B
4018	7.5 (10)	21.2	FWH-80B
4023	11 (15)	30.6	FWH-90B
4031	15 (20)	41.3	FWH-150B
4038	18.5 (25)	50.5	FWH-200B
4044 *1	22 (30)	59.7	FWH-200B
4060 *1	30 (40)	58.3	FWH-225A
4075 *1	37 (50)	71.5	FWH-250A
4089 *1	45 (60)	86.5	FWH-275A
4103 *1	55 (75)	105	FWH-275A
4140 *1	75 (100)	142	FWH-300A
4168 *1	90 (125)	170	FWH-325A FWH-400A *2
4208 *1	110 (150)	207	FWH-500A
4250 *1	150 (200)	248	FWH-600A
4296 *1	185 (250)	300	FWH-700A
4371 *1	220 (300)	373	FWH-800A
4389 *1	260 (350)	410	FWH-1000A
4453 *1	300 (400)	465	FWH-1200A
4568 *1	335 (450)	584	FWH-1200A
4675 *1	450 (600)	657	FWH-1400A FWH-1600A *2

*1 Approval pending. Contact Yaskawa or your nearest sales representative.

*2 Fuses with larger rated currents are recommended for application with repetitive operations.

Table 4.20 Factory Recommended Drive Branch Circuit Protection (Heavy Duty)

Drive Model	Maximum Applicable Motor Output kW (HP)	Input Current Rating A	Semiconductor Fuse Model Manufacturer: EATON/ Bussmann
4002	0.55 (0.75)	1.9	FWH-50B
4004	0.75 (1)	3.5	FWH-50B
4005	1.5 (2)	4.7	FWH-50B

Drive Model	Maximum Applicable Motor Output kW (HP)	Input Current Rating A	Semiconductor Fuse Model Manufacturer: EATON/ Bussmann
4007	2.2 (3)	6.7	FWH-60B
4009	3 (4)	8.9	FWH-60B
4012	3.7 (5)	11.7	FWH-60B
4018	5.5 (7.5)	15.8	FWH-80B
4023	7.5 (10)	21.2	FWH-90B
4031	11 (15)	30.6	FWH-150B
4038	15 (20)	41.3	FWH-200B
4044 *1	18.5 (25)	50.5	FWH-200B
4060 *1	22 (30)	43.1	FWH-225A
4075 *1	30 (40)	58.3	FWH-250A
4089 *1	37 (50)	71.5	FWH-275A
4103 *1	45 (60)	86.5	FWH-275A
4140 *1	55 (75)	105	FWH-300A
4168 *1	75 (100)	142	FWH-325A FWH-400A *2
4208 *1	90 (125)	170	FWH-500A
4250 *1	110 (150)	207	FWH-600A
4296 *1	150 (200)	248	FWH-700A
4371 *1	185 (250)	300	FWH-800A
4389 *1	220 (300)	373	FWH-1000A
4453 *1	260 (350)	410	FWH-1200A
4568 *1	300 (400)	465	FWH-1200A
4675 *1	370 (500)	584	FWH-1400A FWH-1600A *2

*1 Approval pending. Contact Yaskawa or your nearest sales representative.

*2 Fuses with larger rated currents are recommended for application with repetitive operations.

◆ Low Voltage Wiring for Control Circuit Terminals

Low voltage wiring must be provided in accordance with the NEC (National Electric Code), the CEC (Canadian Electric Code, Part I), and any additional local codes. The NEC class 1 circuit conductor is recommended. Use the UL approved class 2 power supply for external power supply.

Table 4.21 Power Supply Used for Control Circuit Terminals

Input/Output	Terminal sign	Power supply specifications
Digital inputs	S1 to S8, SN, SC, SP	The LVLC power supply in the drive is used. Use the UL approved class 2 power supply for external power supply.
Analog input	A1 to A3, AC, +V, -V	The LVLC power supply in the drive is used. Use the UL approved class 2 power supply for external power supply.
Analog output	FM, AM, AC	The LVLC power supply in the drive is used.
Pulse Train Output	MP, AC	The LVLC power supply in the drive is used. Use the UL approved class 2 power supply for external power supply.
Pulse train input	RP, AC	The LVLC power supply in the drive is used. Use the UL approved class 2 power supply for external power supply.

Input/Output	Terminal sign	Power supply specifications
Safe Disable input	H1, H2, HC	The LVLC power supply in the drive is used. Use the UL approved class 2 power supply for external power supply.
Open-collector output	P1, C1, P2, C2	Use the UL approved class 2 power supply.
Serial communication input/output	D+, D-, AC	The LVLC power supply in the drive is used. Use the UL approved class 2 power supply for external power supply.
24 V external power supply	PS, AC	Use the UL approved class 2 power supply.

◆ Drive Motor Overload and Overheat Protection

The drive motor overload and overheat protection function complies with the NEC (National Electric Code) and the CEC (Canadian Electric Code, Part I).

Set the *Motor Rated Current* and L1-01 through L1-04 [*Motor Overload Protection Select*] properly to enable motor overload and overheat protection.

Set the motor rated current according to the control method using *E2-01 [Motor Rated Current (FLA)]*, *E5-03 [PM Motor Rated Current (FLA)]*, or *E9-06 [Motor Rated FLA]*.

■ E2-01: Motor Rated Current (FLA)

No. (Hex.)	Name	Description	Default Setting (Range)
E2-01 (030E)	Motor Rated Current	<div style="display: flex; gap: 5px;"> V/f CL-V/f OLV CLV AOLV OLV/PM AOLV/PM CLV/PM EZOLV </div> Sets the motor rated current in amps.	Determined by o2-04 and C6-01 (10% to 200% of the drive rated current)

Note:

- If parameter *E2-01* < *E2-03 [Motor No-Load Current]* is set, *oPE02 [Parameter Range Setting Error]* will be detected.
- The units for the default setting and setting range vary depending on the model of the drive.
 - 2004 to 2042, 4002 to 4023: 0.01 A units
 - 2056 to 2415, 4031 to 4675: 0.1 A units

The value set in *E2-01* becomes the base value for motor protection, the torque limit, and torque control. Enter the motor rated current as written on the motor nameplate. The value of *E2-01* is automatically set to the value input for “Motor Rated Current” by the Auto-Tuning process.

■ E5-03: PM Motor Rated Current (FLA)

No. (Hex.)	Name	Description	Default Setting (Range)
E5-03 (032B)	PM Motor Rated Current (FLA)	<div style="display: flex; gap: 5px;"> V/f CL-V/f OLV CLV AOLV OLV/PM AOLV/PM CLV/PM EZOLV </div> Sets the motor rated current (FLA) for PM motors.	Determined by E5-01 (10 to 200% of the drive rated current)

The value of *E5-03* is automatically set to the value input for [PM Motor Rated Current] by the Auto-Tuning process when the following types of Auto-Tuning processes are performed.

- PM Motor Parameter Settings
- PM Stationary Auto-Tuning
- PM StaTun for Stator Resistance
- PM Rotational Auto-Tuning

Note:

- Display is in the following units:
- 2004 to 2042, 4002 to 4023: 0.01 A units
 - 2056 to 2415, 4031 to 4675: 0.1 A units

■ E9-06: Motor Rated Current

No. (Hex.)	Name	Description	Default Setting (Range)
E9-06 (11E9)	Motor Rated Current	<div style="display: flex; justify-content: space-between; font-size: small;"> V/f CL-V/f OLV CLV AOLV OLV/PM AOLV/PM CLV/PM EZOLV </div> Sets the motor rated current in amperes.	Determined by E9-01 and o2-04 (10% to 200% of the drive rated current)

Note:

Values appear in the following units.

•2004 to 2042, 4002 to 4023: 0.01 A units

•2056 to 2415, 4031 to 4675: 0.1 A units

The setting value of *E9-06* is the reference value for motor protection. Enter the motor rated current as written on the motor nameplate. The value of *E9-06* is automatically set to the value input for [*Motor Rated Current*] by the Auto-Tuning process for motor parameter settings.

■ L1-01: Motor Overload Protection Select

No. (Hex.)	Name	Description	Default Setting (Range)
L1-01 (0480)	Motor Overload (oL1) Protection	<div style="display: flex; justify-content: space-between; font-size: small;"> V/f CL-V/f OLV CLV AOLV OLV/PM AOLV/PM CLV/PM EZOLV </div> Enables or disables the motor overload protection using electronic thermal protectors.	Determined by A1-02 (0 - 6)

Enables or disables the motor overload protection using electronic thermal protectors.

Cooling capability varies depending on the speed control range of the motor. Select motor protection using an electronic thermal protector that matches the allowable load characteristics of the motor being used.

The drive has overload protection for the motor using an electronic thermal protector. The electronic thermal protector of the drive calculates motor overload tolerance based on output current, output frequency, motor thermal characteristics, and time characteristics to provide overload protection for the motor. The drive triggers an *oL1* [*Motor Overload*] and shuts off the drive output when the drive detects motor overload.

It is also possible to set a motor overload alarm. Set *H2-01 = 1F* [*Terminal M1-M2 Function Selection = Motor overload alarm (oL1)*] to set a motor overload alarm. When the motor overload level rises above 90% of the *oL1* detection level, the output terminal switches ON and triggers an overload alarm.

Note:

Set *L1-01 = 1 to 6* [*Enabled*] to enable motor protection when operating a single motor. External thermal relays are not necessary in such cases.

0 : Disabled

Disable motor protection when motor overload protection is not required or when the drive is operating more than one motor.

The following diagram shows an example of the circuit configuration when connecting multiple motors to a single drive.

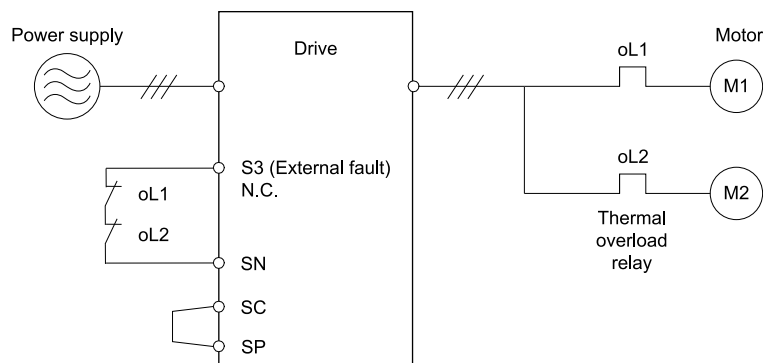

Figure 4.15 Protection Circuit Configuration when Connecting Multiple Motors to Single Drive

NOTICE: The motor cannot be protected by electronic thermal protection when one drive is running two or more motors simultaneously or the motor has a rated current significantly larger than that of standard motors (underwater motors, for example). Add thermal relays to each motor after setting *L1-01 = 0* [*Motor Overload Protection Select = Disabled*] and configure circuits to protect each motor. The motor may fail if handled improperly.

1 : Variable Torque

Use this setting for general-purpose motors with a base frequency of 60 Hz.

The motor has less cooling capability in the low speed range because the cooling fan slows down and there is lower overload tolerance as the speed drops. The trigger point for the electronic thermal protector changes according to the overload tolerance characteristics of the motor. This provides motor overheat protection from low speed to high speed across the entire speed range.

Load tolerance	Cooling Ability	Overload Characteristics (at 100% motor load)
<p>Torque (%)</p> <p>Rated speed = 100 % speed</p> <p>60 s short time</p> <p>Continuous</p> <p>Motor speed (%)</p> <p>(60 Hz)</p> <p>Max. speed over frame # 200LJ</p> <p>Max. speed frame # 160MJ to 180LJ</p> <p>Max. speed under frame # 132MHJ</p>	<p>Motor designed to operate from line power. The motor has maximum cooling capability when operating at a 60 Hz base frequency.</p>	<p>The drive detects oL1 when operating at frequencies lower than 60 Hz. The drive triggers a fault relay output and the motor coasts to stop.</p>

2 : Constant Torque 10:1 Speed Range

Use this setting for drive dedicated motors with a speed range for constant torque of 1:10.

The speed control for this motor is 10% to 100% when at 100% load. Operating slower than 10% speed at 100% load will trigger motor overload.

Load tolerance	Cooling Ability	Overload Characteristics (at 100% motor load)
<p>Torque (%)</p> <p>Rated speed = 100 % speed</p> <p>60 s short time</p> <p>Continuous</p> <p>Motor speed (%)</p> <p>Max. speed over frame # 200LJ</p> <p>Max. speed frame # 160MJ to 180LJ</p> <p>Max. speed under frame # 132MJ</p>	<p>This motor is designed to withstand increasing temperature during continuous operation even in the low speed range (10% base frequency).</p>	<p>The motor operates continuously at 10% to 100% base frequency.</p>

3 : Constant Torque 100:1 SpeedRange

Use this setting for vector motors with a speed range for constant torque of 1:100.

The speed control for this motor is 1 % to 100% when at 100% load. Operating slower than 1% speed at 100% load will trigger motor overload.

Load tolerance	Cooling Ability	Overload Characteristics (at 100% motor load)
<p>Torque (%)</p> <p>Rated speed = 100 % speed</p> <p>60 s short time</p> <p>Continuous</p> <p>Motor speed (%)</p> <p>Max. speed over frame # 200LJ</p> <p>Max. speed frame # 160MJ to 180LJ</p> <p>Max. speed under frame # 132MJ</p>	<p>This motor is designed to withstand increasing temperature during continuous operation even in the low speed range (1% base frequency).</p>	<p>The motor operates continuously at 1% to 100% base frequency. Motor overload is triggered when operating slower than 1% speed at 100% load.</p>

4 : PM Variable Torque

Use this setting for PM motors with derated torque characteristics.

The motor has less cooling capability in the low speed range because the cooling fan slows down and there is lower overload tolerance as the speed drops. The trigger point for the electronic thermal protector changes according to the overload tolerance characteristics of the motor. This provides motor overheat protection from low speed to high speed across the entire speed range.

Load tolerance	Cooling Ability	Overload Characteristics (at 100% motor load)
	<p>This motor is designed to withstand increasing temperature during continuous operation at both rated speed and rated torque.</p>	<p>The drive detects <i>oLL</i> when the motor operates continuously at lower speed than rated rotation speed at over 100% torque. The drive triggers a fault relay output and the motor coasts to stop.</p>

5 : PM Constant Torque

Use this setting with a PM motor for constant torque that has a speed range for constant torque of 1:500.

The speed control for this motor is 0.2% to 100% when at 100% load. Operating slower than 0.2% speed at 100% load will trigger motor overload.

Load tolerance	Cooling Ability	Overload Characteristics (at 100% motor load)
	<p>This motor is designed to withstand increasing temperature during continuous operation even in the low speed range (0.2% base frequency).</p>	<p>The motor operates continuously at 0.2% to 100% rated speed. Motor overload is triggered when operating slower than 0.2% speed at 100% load.</p>

6 : Variable Torque (50Hz)

Use this setting for general-purpose motors with a base frequency of 50 Hz.

The motor has less cooling capability in the low speed range because the cooling fan slows down and there is lower overload tolerance as the speed drops. The trigger point for the electronic thermal protector changes according to the overload tolerance characteristics of the motor. This provides motor overheat protection from low speed to high speed across the entire speed range.

Load tolerance	Cooling Ability	Overload Characteristics (at 100% motor load)
	<p>This motor is designed to operate using commercial line power. The motor has maximum cooling capability when operating at a 50 Hz base frequency.</p>	<p>The drive detects <i>oLL</i> when operating at frequencies lower than commercial line power. The drive triggers a fault relay output and the motor coasts to stop.</p>

■ **L1-02: Motor Overload Protection Time**

No. (Hex.)	Name	Description	Default Setting (Range)
L1-02 (0481)	Motor Overload (oL1) Protection	V/f CL-V/f OLV CLV AOLV OLV/PM AOLV/PM CLV/PM EZOLV Sets the operation time for the electronic thermal protector of the drive to protect the motor. Normally there is no need to change this setting.	1.0 min (0.1 - 5.0 min)

Set the overload tolerance time to the length of time that the motor is allowed to operate at 150% load from continuous operation at 100% load.

The default setting triggers the electronic thermal protector after the motor operates at 150% load continuously for 1 minute after continuous operation at 100% load (hot start).

The following diagram is an example of the electronic thermal protector operation time. Motor overload protection operates in the range between a cold start and a hot start.

This example shows a general-purpose motor operating at the base frequency with L1-02 set to 1.0 min.

- **Cold start**
Shows the motor protection operation time characteristics when the overload occurs immediately after starting operation from a complete stop.
- **Hot start**
Shows the motor protection operation time characteristics when overload occurs from continuous operation below the motor rated current.

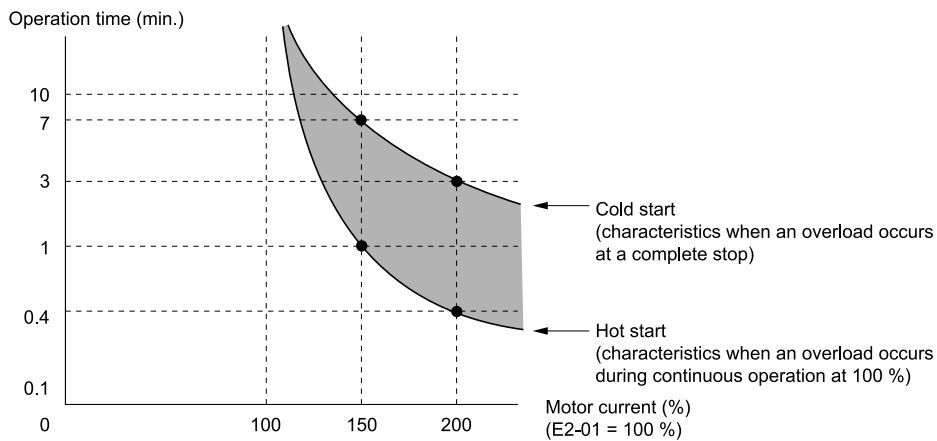

Figure 4.16 Protection Operation Time for a General-purpose Motor at Rated Output Frequency

■ **L1-03: Motor OH Alarm Operation Select**

No. (Hex.)	Name	Description	Default Setting (Range)
L1-03 (0482)	Motor OH Alarm Operation Select	V/f CL-V/f OLV CLV AOLV OLV/PM AOLV/PM CLV/PM EZOLV Selects the drive operation when the PTC input signal input into the drive reaches the detection level of oH3 [Motor Overheat Alarm].	3 (0 - 3)

0 : Ramp to stop

The drive ramps the motor to stop according to the deceleration time. Fault relay output terminal MA-MC will turn on, and MB-MC will turn off.

1 : Coast to stop

The drive shuts off output and the motor coasts to stop. Fault relay output terminal MA-MC will turn on, and MB-MC will turn off.

2 : Fast Stop

The drive stops the motor using the deceleration time set in C1-09 [Fast Stop Time]. Fault relay output terminal MA-MC will turn on, and MB-MC will turn off.

3 : Alarm only

oH3 appears on the keypad, and operation continues.

■ L1-04: Motor OH Fault Operation Select

No. (Hex.)	Name	Description	Default Setting (Range)
L1-04 (0483)	Motor OH Fault Operation Select	<div style="display: flex; justify-content: space-between; font-size: 0.8em; font-weight: bold; margin-bottom: 5px;"> V/f CL-V/f OLV CLV AOLV OLV/PM AOLV/PM CLV/PM EZOLV </div> Selects the drive operation when the PTC input signal input into the drive reaches the detection level of <i>oH4</i> [<i>Motor Overheat Failure</i>].	1 (0 - 2)

0 : Ramp to stop

The drive ramps the motor to stop according to the deceleration time. Fault relay output terminal MA-MC will turn on, and MB-MC will turn off.

1 : Coast to stop

The drive shuts off output and the motor coasts to stop. Fault relay output terminal MA-MC will turn on, and MB-MC will turn off.

2 : Fast Stop

The drive stops the motor using the deceleration time set in *C1-09* [*Fast Stop Time*]. Fault relay output terminal MA-MC will turn on, and MB-MC will turn off.

4.4 Safe Disable Input



Figure 4.17 TUV Mark

The TUV mark indicates that the product complies with the safety standards.

This section describes precautions for supporting the Safe Disable input. Contact us for more information.

The safety function complies with the standards shown in [Table 4.22](#).

Table 4.22 Safety Standards and Unified Standards Applied

Safety Standards	Unified Standards Applied ^{*1}
Functional Safety	IEC/EN 61508:2010 (SIL3)
	IEC 62061:2012 / EN 62061:2013 (SILCL3)
	IEC/EN 61800-5-2:2007 (SIL3)
Machine Safety	ISO 13849-1:2006 (Cat.III, PL e) / EN ISO 13849-1/AC:2009 (Cat.III, PL e)
EMC	IEC 61000-6-7:2014/FprEN 61000-6-7:2014, IEC/EN61326-3-1:2008

*1 Approval pending for models 2070 to 2415, 4044 to 4675.

Note:

SIL is an abbreviation of Safety Integrity Level.

◆ Specification

The Safe Disable input provides the stop function compliant to “Safe Torque Off” defined in IEC/EN 61800-5-2:2007. The Safe Disable input is designed to meet the requirements of EN ISO 13849-1 and IEC/EN 61508. It is also equipped with the safety status monitor to detect safety circuit errors.

The following table lists the specifications for the safety function.

Table 4.23 Specifications for the Safety Function

Item	Description
Input/output	<ul style="list-style-type: none"> Input: 2 Safe Disable input (H1, H2) Signal ON level: 18 Vdc to 28 Vdc Signal OFF level: -4 Vdc to +4 Vdc Output: 1 Safety monitor output EDM (MFDO)
Response time from opening the input to stopping the drive output	3 ms or less
Response time from opening H1 and H2 terminal inputs to operating the EDM signal	20 ms or less
Failure probability	Less frequent operation request mode PFD = 4.65E-6
	Frequent operation request mode or continuous mode PFH = 1.11E-9
Performance level	The Safe Disable input complies with the performance level requirements of EN ISO 13849-1 in consideration of the self-diagnostic function.
HFT (hardware fault tolerance)	N = 1
Type of subsystem	Type B

Note:

EDM = External Device Monitoring

PFD = Probability of Failure on Demand

PFH = Probability of Dangerous Failure per Hour

◆ Notes

DANGER! *Sudden Movement Hazard. Make sure the whole system or machinery in which the Safe Disable function is used complies with safety requirements. When implementing the Safe Disable function into the safety system of a machine, perform a thorough risk assessment for the entire system to assure compliance with relevant safety norms. Improper use of the Safe Disable function will cause serious injury or even death.*

DANGER! *Sudden Movement Hazard. An external holding brake and dynamic brake are not considered to be safety components for drives. Even when using an external holding brake or dynamic brake with a drive output signal (including EDM), it is still not considered a safe system because the drive output signal is not a safety component. A system is required that satisfies safety requirements. Failure to comply will cause death or serious injury.*

DANGER! *Sudden Movement Hazard. Connect the Safe Disable inputs to the devices in compliance with safety requirements. Failure to comply will cause death or serious injury.*

WARNING! *Sudden Movement Hazard. When using a PM motor, even if the drive output is shut off by the Safe Disable function, a breakdown of two output transistors can cause current to flow through the motor winding, resulting in a motor output axis movement for a maximum angle of 180 degrees (electrically). Make sure such a situation would have no effect on the safety of the application when using the Safe Disable function. Failure to comply could cause serious injury or death.*

WARNING! *Electrical Shock Hazard. The Safe Disable function can switch off the drive output, but does not cut the drive power supply and cannot electrically isolate the drive output from the input. Always shut off the drive power supply when performing maintenance or installations on the drive input side as well as the drive output side. Failure to comply could cause serious injury or death.*

WARNING! *Sudden Movement Hazard. The motor will move when an external gravitational force in the vertical axis is applied even if the Safe Disable function is in operation. Failure to comply could cause serious injury or death.*

WARNING! *Sudden Movement Hazard. When using the Safe Disable inputs, make sure to remove the wire links between terminals H1, H2, and HC that were installed prior to shipment. Failure to do so will keep the Safe Disable circuit from operating properly and could cause death or serious injury.*

WARNING! *Sudden Movement Hazard. All safety features (including Safe Disable) should be inspected daily and periodically. If the system is not operating normally, this could cause death or serious injury.*

WARNING! *Sudden Movement Hazard. Only a qualified technician with a thorough understanding of the drive, the instruction manual, and safety standards should be permitted to wire, inspect, and maintain the Safe Disable input. Failure to comply could cause death or serious injury.*

NOTICE: *From the moment terminal inputs H1 and H2 have opened, it takes up to 3 ms for drive output to shut off completely. The sequence set up to trigger terminals H1 and H2 should make sure that both terminals remain open for at least 3 ms in order to properly interrupt drive output.*

NOTICE: *The Safe Disable Monitor (multi-function output terminal assigned to the EDM function) should not be used for any other purpose than to monitor the Safe Disable status or to discover a malfunction in the Safe Disable inputs. The monitor output is not considered a safe output.*

NOTICE: *Replace drives with a built-in safety function 10 years after its first used.*

◆ Using the Safe Disable Function

■ Safe Disable Circuit

The Safe Disable circuit is comprised of two independent channels (terminals H1 and H2) that block the output transistors. The input can use the internal power supply of the drive.

Set the EDM function to one of the multifunction digital output terminals [$H2-xx = 21$ or 121] to monitor the status of the Safe Disable function. This is called the "Safe Disable monitor output function."

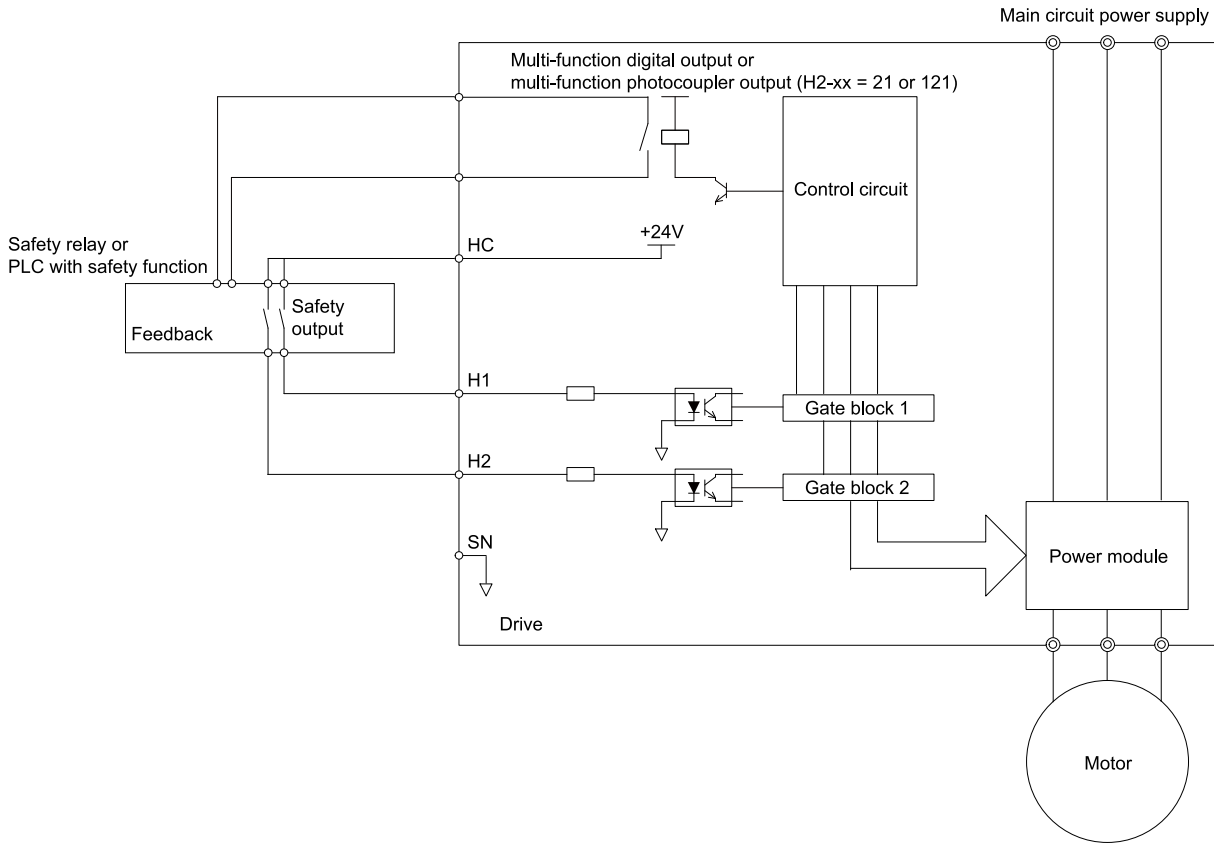

Figure 4.18 Safe Disable Function Wiring Example

■ Disabling and Enabling the Drive Output (“Safe Torque Off”)

Refer to Figure 4.19 for an example of drive operation when switching from the “Safe Torque Off” status until reaching normal operation.

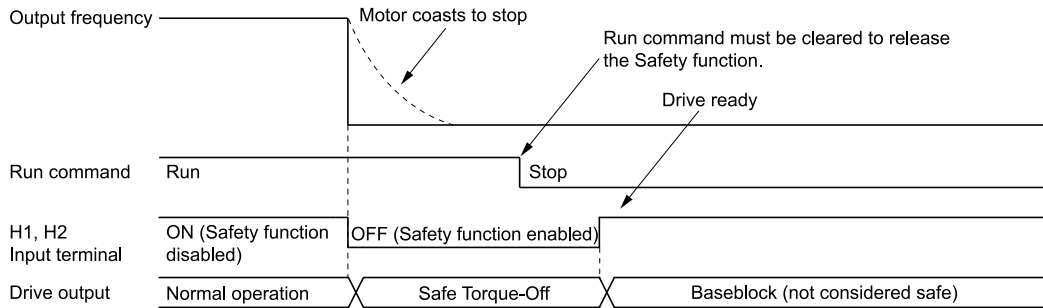

Figure 4.19 Safe Disable operation

Switching from Normal Operation to “Safe Torque Off”

Turning OFF (opening) either safety input terminal H1 or H2 will enable the Safe Disable function. Triggering the Safe Disable function while the motor is running will shut off the drive output and motor torque and the motor will coast to stop regardless of the *b1-03 [Stopping Method Selection]* setting value.

The “Safe Torque Off” status is only possible when using the Safe Disable function. Clear the Run command to stop the drive. Shutting off the drive output, as in a baseblock condition, is not the same as “Safe Torque Off”.

Note:

- A maximum of 3 ms will elapse from when terminals H1 or H2 shut off until the drive switches to the "Safe Torque Off" status. Set the OFF status for terminals H1 and H2 to hold for at least 2 ms. The drive may not be able to switch to the “Safe Torque Off” status if terminals H1 and H2 are only open for less than 2 ms.
- Switch OFF terminals H1 and H2 after the motor has come to a complete stop to prevent the motor from coasting to stop during normal operation.

Returning to Normal Operation from “Safe Torque Off”

The safety input releases only when the Run command is not present.

- During Stop:

Place one short circuit between terminals H1-HC and one between terminals H2-HC to disable "Safe Torque Off" when the Safe Disable function is triggered during stop. Enter the Run command after the drive stops normally.

- During run:
Place one short circuit between terminals H1-HC and one between terminals H2-HC to disable "Safe Torque Off" after clearing the Run command when the Safe Disable function is triggered during stop. Enter the Run command after entering the STOP command regardless of whether terminals H1 and H2 are ON.

■ Safe Disable Monitor Output Function and Keypad Display

Refer to [Table 4.24](#) for information on the relationship between each status of the input channel, Safety monitor output, and drive output.

Table 4.24 Safe Disable Input and EDM Terminal Status

Input Channel Status		Safety Monitor Output		Drive Output Status	Keypad Display	LED Status Ring
Input 1 (H1 - HC)	Input 2 (H2 - HC)	Multi-function Digital Output Terminal (H2-xx = 21)	Multi-function Digital Output Terminal (H2-xx = 121)			
ON (Short circuit)	ON (Short circuit)	OFF	ON	Baseblock (Drive ready)	Normally displayed	Ready: Lit
OFF (Open)	ON (Short circuit)	OFF	ON	Safety status (STo)	SToF (Flashing)	ALM/ERR: Flashing
ON (Short circuit)	OFF (Open)	OFF	ON	Safety status (STo)	SToF (Flashing)	ALM/ERR: Flashing
OFF (Open)	OFF (Open)	ON	OFF	Safety status (STo)	STo (Flashing)	Ready: Flashing

Safety Function Status Monitor

The drive Safety monitor output sends a feedback signal regarding the Safety function status. The Safety monitor output is one of the possible settings available for the multi-function digital output terminals. A controller (PTC or safety relay) must read this signal as an input signal to maintain the "Safe Torque Off" status in the event that the Safe Disable circuit is damaged. Refer to the manual for the safety device for more information on the Safety function.

It is possible to switch polarity of the Safety monitor output signal using the multi-function digital output functions settings. Refer to [Table 4.24](#) for setting instructions.

Keypad Display

The keypad will flash *STo* [*Safe Disable Signal Input*] when both input channels are OFF (Open).

The keypad flashes *SToF* [*Safe Disable Signal Fault*] when one input channel is OFF (Open), and the other is ON (Short circuit) to indicate that either the Safe disable circuit or the drive are damaged. The keypad will never display *SToF* when the Safe disable circuit is used correctly. Refer to the chapter on Troubleshooting for more information.

The keypad displays *SCF* [*Safe Circuit Fault*] when the drive detects a fault in the Safe disable circuit to indicate that the drive is damaged. Refer to the chapter on Troubleshooting for more information.

■ Validating Safe Disable Function

Perform the following Safe Disable input test when replacing parts or performing maintenance after completing all necessary wiring to start the drive. Keep a record of the test results.

- Ensure that the keypad flashes *STo* [*Safe Disable Signal Input*] when both input channels are OFF (Open) and confirm that the motor is not running. Also check that the motor is not running.
- Monitor the ON/OFF status of the input channels and ensure that multi-function digital output assigned to the EDM function operates as shown in [Table 4.24](#).
The ON/OFF status of the multi-function digital output may not display correctly on the keypad if one or more of the following are true:
 - Incorrect parameter settings
 - A problem with an external device
 - There is a short or disconnection in the external wiring.

4.4 Safe Disable Input

– The device is damaged.

Identify the cause and fix the problem to display the status properly.

- Ensure that the EDM signal operates during normal operation as described in [Table 4.24](#).

Network Communications

5.1	Safety Precautions	230
5.2	Field Bus Network Support.....	231
5.3	MEMOBUS/Modbus Communications	232

5.1 Safety Precautions

DANGER

Heed the safety messages in this manual. Failure to comply will result in death or serious injury.

The operating company is responsible for any injuries or equipment damage resulting from failure to heed the warnings in this manual.

5.2 Field Bus Network Support

The user can control and monitor the drive through the network from the PLC. This product comes standard with a RS-485 interface (MEMOBUS/Modbus communications). If a separately sold communication option is mounted to the drive, it will enable the drive to support various other network communications.

◆ Standard Internal Communication Interfaces

The following communication interfaces are built into this product as standard.

- MEMOBUS/Modbus(RS-485)

◆ Communication Option

The following table lists the field bus networks compatible with this product. Contact Yaskawa or your nearest sales representative to place a communication option order.

Type of Communications	Option model	Type of Communications	Option model
CC-Link	SI-C3	DeviceNet	SI-N3
MECHATROLINK-II	SI-T3	LonWorks	SI-W3
MECHATROLINK-III	SI-ET3	Modbus TCP/IP	SI-EM3
PROFIBUS-DP	SI-P3	PROFINET	SI-EP3
CANopen	SI-S3	EtherNet/IP	SI-EN3
EtherCAT	SI-ES3		

5.3 MEMOBUS/Modbus Communications

This section describes in detail the parameters, error codes and communication procedures for MEMOBUS/Modbus communications.

◆ Configure Master/Slave

Serial communication with programmable controllers (PLC) can be performed using the MEMOBUS/Modbus protocol.

MEMOBUS/Modbus communication can be configured using one master (PLC) and a maximum of 31 slaves. Serial communications between master and slave are normally started by the master and the slaves respond.

The address number for each slave must be set beforehand so that the master can perform signal communications using these address numbers. A slave that receives a command from the master performs the specified function and sends a response back to the master.

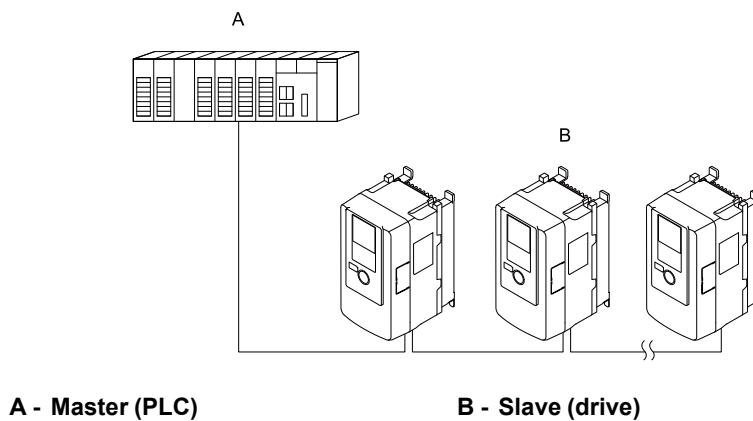

Figure 5.1 PLC and Drive Connection Example

◆ Communication Specifications

The following table lists the specifications for the MEMOBUS/Modbus communications.

Table 5.1 MEMOBUS/Modbus Specifications

Item	Specification
Interface	RS-485
Synchronization method	Asynchronous (start-stop synchronization)
Communication Parameter	Communications speed: 1.2, 2.4, 4.8, 9.6, 19.2, 38.4, 57.6, 76.8, 115.2 kbps
	Data length: 8 bit (fixed)
	Parity: even, odd, none
	Stop bit 1 bit (fixed)
Communication protocol	MEMOBUS/Modbus standard (RTU mode only)
No. of connectable units	Maximum: 31 units

◆ Communication with PLC

This section describes the settings for the termination resistor and how to connect to MEMOBUS/Modbus communications. It operates using RS-485 interface (2-wire seq).

■ Connect Communications Cable

To initiate communication between the PLC and drive, follow the procedure below.

Note:

Before connecting the communications cable, be sure to remove the LED Status Ring board. For the removal procedure, refer to "Wiring for the Control Circuit Terminal Block."

1. Connect the communications cable between the PLC and drive when the drive is de-energized. The connection terminal of the MEMOBUS/Modbus communications cable is TB4.

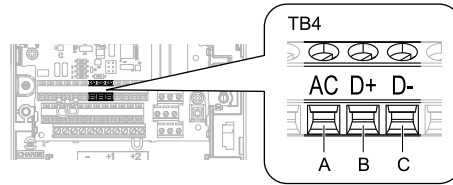

A - Terminal AC: Shield ground
B - Terminal D+: Communication input/output (+)

C - Terminal D-: Communication input/output (-)

Figure 5.2 Communications Cable Connection Terminal (TB4)

Note:

Separate the communications wiring from the main circuit wiring, other wiring and power lines. Use shielded wires for the communications wiring and connect cable sheaths to the ground terminal of the drive. This prevents malfunction due to noise.

2. Confirm that the termination resistor is installed to the network termination slave. Enable the termination resistor for the drive by setting the DIP switch S2 to the ON position.
3. Turn on the power.
4. Set necessary communications parameters *H5-01 through H5-12* using the keypad.
 - *H5-01 [Drive Node Address]*
 - *H5-02 [Communication Speed Selection]*
 - *H5-03 [Communication Parity Selection]*
 - *H5-04 [Stopping Method after Com Error]*
 - *H5-05 [Comm Fault Detection Select]*
 - *H5-06 [Drive Transmit Wait Time]*
 - *H5-09 [CE Detection Time]*
 - *H5-10 [Unit Sel for MEMOBUS/Modbus 0025H]*
 - *H5-11 [Communications ENTER Func Select]*
 - *H5-12 [Run Command Method Selection]*
5. Shut the power off and wait for the keypad display to go out completely.
6. Turn the power back on.
7. The drive is ready to begin communicating with the PLC.

■ Set the Termination Resistor

In MEMOBUS/Modbus communications, the termination resistor for the drive needs to be enabled on the slave terminal. The termination resistor built in this product can be turned ON and OFF with DIP switch S2 on the terminal block. If the drive is installed in the terminal of the communication line, set DIP switch S2 to ON. Also, confirm that DIP switch S2 is OFF for other drives. Setting the DIP switch S2 as shown in the following drawing. Use the tip of tweezers or a jig with a tip width of 0.8 mm to set the DIP switch.

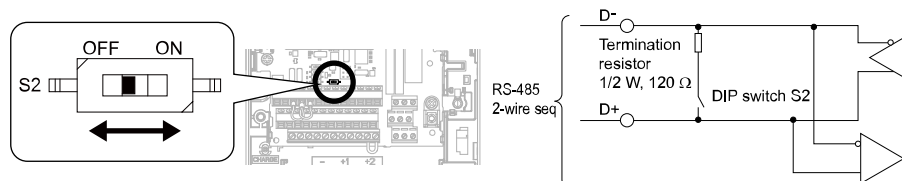
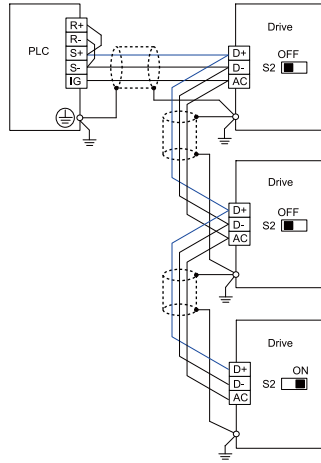

Figure 5.3 MEMOBUS/Modbus Communication Terminal and DIP Switch S2

■ Wiring Diagram for Multiple Connections

Describes the wiring for the running of multiple connected drive units using MEMOBUS/Modbus communications.



Note:

Set DIP switch S2 to the ON position to enable the termination resistor in the last drive of the MEMOBUS/Modbus communication network.

◆ **Drive Operations by MEMOBUS/Modbus**

The parameters of the drive apply to the settings even if the drive is run during MEMOBUS/Modbus communications. This section describes the types of usable functions and their related parameters.

■ **Executable Function**

If the PLC is used, the following operations can be executed during MEMOBUS/Modbus communications regardless of the setting of the parameters (excluding H5-xx).

- Run the drive from the PLC and monitor its operation status
- Parameter Settings/References
- Fault Reset
- Multi-function input setting (The input command for MEMOBUS/Modbus communications is the command input from MFDI terminal (S1 to S8) and OR.)

■ **Drive Control**

Select the external command for setting the frequency references and the motor run/stop using MEMOBUS/Modbus communications, and set the parameters according to the application using the following table.

Table 5.2 Required Parameter Setting for Drive Control from MEMOBUS/Modbus

Operation Mode	No.	Name	Setting
External reference 1	b1-01	Frequency Reference Selection 1	2 [Memobus/Modbus Communications]
	b1-02	Run Command Selection 1	2 [Memobus/Modbus Communications]
External reference 2	b1-15	Frequency Reference Selection 2	2 [Memobus/Modbus Communications]
	b1-16	Run Command Selection 2	2 [Memobus/Modbus Communications]

For more information on operation mode selection, refer to b1-01 [Frequency Reference Selection 1] and b1-02 [Run Command Selection 1]. For more information on external command, refer to H1-xx = 2 [MFDI = External Reference 1/2 Selection].

◆ **Communications Timing**

To prevent overrun of the slave side, the master cannot send a message to the same drive for a certain amount of time. Similarly, to prevent overrun of the master side, the slave cannot send a response message to the master for a certain amount of time. This section explains the message send/receive timing.

■ Command Message from Master to Slave

To prevent data loss and overrun, after the master receives a message from the slave, the master cannot send the same type of command message to the same slave for a certain amount of time. The minimum wait time differs depending on the type of message. Check by referencing the following table.

Table 5.3 Minimum Wait Time until Message Transmitted

Command type	Ex.	Minimum Wait Time
1	<ul style="list-style-type: none"> • Operation commands (Run command, stop command) • I/O settings • Reading the motor and parameter setting values 	5 ms ^{*1}
2	Parameter writing	50 ms ^{*1}
3	Writing of modified data with the Enter command	3 to 5 seconds ^{*1}

*1 If the drive receives a message within the minimum wait time, it executes command type 1 and sends a response message. If the drive receives command type 2 and command type 3 messages within the minimum wait time, a communications error is generated or the drive disregards the command it received.

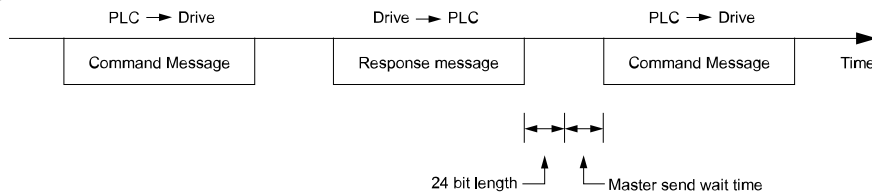

Figure 5.4 Minimum Wait Time until Transmit

The timer within the master must be set to check how long it takes for the slave to respond to the master. If the timer is set and a response message is not returned back from the slave within a certain amount of time, the master retransmits the message.

■ Response Message from Slave

When the slave receives the command message from the master, it processes the data that was sent. When the wait time set in H5-06 [Drive Transmit Wait Time] passes, it sends a response message to the master. Increase the wait time set in H5-06 when overrun occurs on the master.

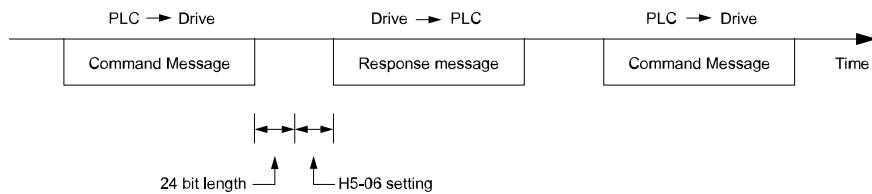
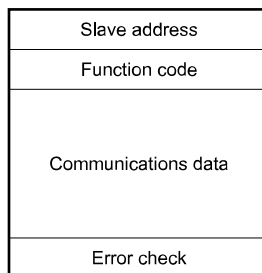

Figure 5.5 Response Wait Time

◆ Message Format

■ Communication Message Description

In MEMOBUS/Modbus communications, the master sends commands to the slave and the slave responds. The message format is sent and received in the following configuration. The length of the data portion changes depending on the description of the command (function).



■ Slave Address

Sets the slave address of the drive. Set 00 to FF (Hex.) value. When the slave address is set to 00 (Hex), the master broadcasts and all slaves receive the command.

The slave does not send a response message to the master regarding the broadcast.

■ Function Code

A code to set a command. The following are the three function codes.

Function Code (Hex.)	Function	Command message		Response message	
		Minimum data length (byte)	Maximum data length (byte)	Minimum data length (byte)	Maximum data length (byte)
03	Read the description of holding register	8	8	7	37
08	Loopback test	8	8	8	8
10	Writing to multiple holding registers	11	41	8	8

■ Communications Data

Communications data consists of a series of data based on the combination of communications register No. and the data for these registers. The data length changes depending on the description of the command. For a loopback test, it switches to test code.

The communications register for the drive has a 2 byte length. Therefore, data that is written to the register for the drive is normally 2 bytes. Register data that is read from the drive is also configured in 2 bytes.

■ Error Check

It detects errors when transmitting. It uses the CRC-16 method. Use the following calculation procedure.

Command Data

When the drive received data, it checks whether the data is error-free. It calculates CRC-16 in the following manner and compares it with the CRC-16 value that is included in the message. If the CRC-16 values do not match, no command message is executed.

In MEMOBUS/Modbus communications, set the starting value when calculating CRC-16 as FFFF (Hex.) (that is, all 16 bits must be 1).

Calculate CRC-16 using the following steps.

1. Ensure that the starting value is FFFF (Hex.).
2. Calculate the FFFF (Hex.) starting value and the XOR of the slave address (exclusive OR).
3. Shift the step 2 results one column to the right. Perform this shift until the carry bit is 1.
4. When the carry bit is 1, calculate XOR via the result from the above step 3 and A001 (Hex.).
5. Repeat steps 3 and 4 up to the 8th right shift.
6. Calculate the XOR using the result of step 5 and the data of the following messages (function code, register address, data). Repeat steps 3 to 5 up to the last data and calculate.
7. The result of the last right shift or the value of the last XOR calculation is the calculated result for CRC-16.

The following table lists the examples of the CRC-16 calculation of slave address 02 (Hex.) and function code 03 (Hex.). The calculated results of CRC-16 for this section is D140 (Hex.).

Note:

The calculation example only describes some error checks using CRC-16. The same error checks will be executed for the following data.

Description	Calculation	Overflow	Description	Calculation	Overflow	
Initial value (FFFF(Hex.))	1111 1111 1111 1111		Function code 03 (Hex.)	0000 0011		
Address 02 (Hex.)	0000 0010		XOR w result	1000 0001 0011 1101		
XOR w initial value	1111 1111 1111 1101		Shift 1	0100 0000 1001 1110	1	
Shift 1	0111 1111 1111 1110	1	XOR w A001 (Hex.)	1010 0000 0000 0001		
XOR w A001 (Hex.)	1010 0000 0000 0001		XOR result	1110 0000 1001 1111		
XOR result	1101 1111 1111 1111		Shift 2	0111 0000 0100 1111	1	
Shift 2	0110 1111 1111 1111	1	XOR w A001 (Hex.)	1010 0000 0000 0001		
XOR w A001 (Hex.)	1010 0000 0000 0001		XOR result	1101 0000 0100 1110		
XOR result	1100 1111 1111 1110		Shift 3	0110 1000 0010 0111	0	
Shift 3	0110 0111 1111 1111	0	Shift 4	0011 0100 0001 0011	1	
Shift 4	0011 0011 1111 1111	1	XOR w A001 (Hex.)	1010 0000 0000 0001		
XOR w A001 (Hex.)	1010 0000 0000 0001		XOR result	1001 0100 0001 0010		
XOR result	1001 0011 1111 1110		Shift 5	0100 1010 0000 1001	0	
Shift 5	0100 1001 1111 1111	0	Shift 6	0010 0101 0000 0100	1	
Shift 6	0010 0100 1111 1111	1	XOR w A001 (Hex.)	1010 0000 0000 0001		
XOR w A001 (Hex.)	1010 0000 0000 0001		XOR result	1000 0101 0000 0101		
XOR result	1000 0100 1111 1110		Shift 7	0100 0010 1000 0010	1	
Shift 7	0100 0010 0111 1111	0	XOR w A001 (Hex.)	1010 0000 0000 0001		
Shift 8	0010 0001 0011 1111	1	XOR result	1110 0010 1000 0011		
XOR w A001 (Hex.)	1010 0000 0000 0001		Shift 8	0111 0001 0100 0001	1	
XOR result	1000 0001 0011 1110		XOR w A001 (Hex.)	1010 0000 0000 0001		
Perform operations with next data (function code)			XOR result	1101 0001 0100 0000		
			CRC-16		1101 0001 0100 0000	
					D 1 4 0	
			(Lower) (Upper)			
Continue from here with next data.						

Figure 5.6 CRC-16 Calculation Example

Response Data

As mentioned above, it performs the CRC-16 calculation for the response message and checks whether the data is error-free. Check whether the calculated value is the same value as the CRC-16 within the response message.

◆ Examples of Messages for Commands/Responses

The following are examples of messages for commands/responses.

■ Read the Description of Holding Register

Reads the contents of a maximum of 16 holding registers using the function code 03 (Hex.).

The following table shows example messages when the status signal from the drive of slave 2, the error contents, Fault Contents, and frequency references are read.

Byte	Command Message		Response Message (normal)		Response Message (fault)			
		Setting Data (Hex.)		Setting Data (Hex.)		Setting Data (Hex.)		
0	Slave address	02	Slave address	02	Slave address	02		
1	Function code	03	Function code	03	Function code	83		
2	Starting No.	Upper	Data Qty		Error code			
3		Lower	20	First storage register	Upper	00	CRC-16	Upper
4	Data Qty	Upper	00		Lower	65		Lower
5		Lower	04	Next storage register	Upper	00	-	
6	CRC-16	Upper	45	Next storage register	Lower	00	-	
7		Lower	F0		Upper	00	-	
8	-		Next storage register	Lower	00	-		
9	-			Upper	01	-		
10	-		CRC-16	Lower	F4	-		
11	-			Upper	AF	-		
12	-		Lower	82	-			

■ Loopback Test

The loopback test is performed using the function code 08 (Hex.). The loopback test returns the command message as a response message. The test is used to check communication between the master and slave. The test code and data can use desired values.

The following table shows examples of messages given out when the loopback test is performed with the drive of slave 1.

Byte	Command Message		Response Message (normal)			
		Setting Data (Hex.)		Setting Data (Hex.)		
0	Slave address		Slave address			
1	Function code		Function code			
2	Test code	Upper	00	Test code	Upper	00
3		Lower	00		Lower	00
4	Data	Upper	A5	Data	Upper	A5
5		Lower	37		Lower	37
6	CRC-16	Upper	DA	CRC-16	Upper	DA
7		Lower	8D		Lower	8D

■ Writing to Multiple Holding Registers

The respective data that was set can be written to a set number of holding registers from the number that is set using the function code 10 (Hex.). The write data requires that the number of the holding registers and each 8 higher bits and 8 lower bits be configured in order inside the command message. The number of writable holding registers is 16.

The following table shows example messages when Forward run is set in the drive of slave 1 from the PLC with 60.00 Hz frequency reference.

When the parameter value is rewritten using the write command via the *H5-11 [Communications ENTER Func Select]* setting, the Enter command is required to save and enable the contents of the changes. For details, refer to “*H5-11 [Communications ENTER Func Select]*” and “Enter command.”

Byte	Command message		Response message (when normal)		Response message (when there is a fault)	
		Setting data (Hex.)		Setting data (Hex.)		Setting data (Hex.)
0	Slave address		Slave address		Slave address	
1	Function code		Function code		Function code	
2	Starting No.	Upper	00	Starting No.	Error code	
3		Lower	01		Upper	CD
4	Data Qty	Upper	00	Data Qty	CRC-16	Lower
5		Lower	02		Upper	C1
6	Byte No.		CRC-16		-	
7	First data	Upper	00	Upper	10	-
8		Lower	01	Lower	08	-
9	Next data	Upper	17	-		
10		Lower	70	-		
11	CRC-16	Upper	6D	-		
12		Lower	B7	-		

Note:

The number of bytes set within the command message determines the data quantity $\times 2$ during the command message. The response message will also be handled the same way.

◆ Enter Command

When writing the parameters from the PLC to the drive using MEMOBUS/Modbus communications, enabling these parameters from the Enter command will depend on the *H5-11 [Communications ENTER Func Select]* setting. This section explains the Enter command.

■ Types of Enter Command

The drive supports the two Enter commands shown on the following list.

The Enter command executes by writing 0 to register No. 0900 or 0910 (Hex.). These registers can only be written. If data is read using these registers, an error is generated.

Table 5.4 Types of Enter Command

Register No. (Hex.)	Description
0900	If parameter data is written to the EEPROM, data on the RAM is enabled simultaneously. Parameter changes are saved even if the drive is restarted.
0910	Only data on the RAM is updated and parameter data is not written to the EEPROM. When the drive is de-energized, parameter changes will be deleted.

Note:

- The maximum number of write times of the EEPROM used by the drive is 100000 times. Be careful not to frequently execute the Enter command (0900 (Hex.)) that is written to EEPROM. The Enter command register is write-only. Consequently, if this register is read, Register Number Error (02 (Hex.)) will occur.
- When the command data or broadcast message is transmitted to the drive, the Enter command is not necessary.

■ Enter Command Setting when Replacing an Old Product

When replacing an old Yaskawa model with this product, the Enter command function for this product must be set in the same manner as the old product. The functionality of the Enter command will vary among the Yaskawa G7, F7 series and V7 series. Set the functionality of the Enter command based on *H5-11*.

- When replacing G7 and F7 series, set *H5-11 = 0* [Enter Required].
- When replacing the V7 series, set *H5-11 = 1* [No Enter Required].
- When replacing the drive for the 1000 series, set it in the same manner as the drive it has replaced.

Table 5.5 Enter Command Function Differences

H5-11 setting value	H5-11 = 0	H5-11 = 1
Replacement target drive	G7, F7	V7
Timing at which parameter settings are enabled	When the Enter command is received from the master	When performing parameter settings
Upper and lower limit check	Checks the upper and lower limits bearing in mind the setting contents for the related parameters.	Performs an upper and lower limit check on the parameter that was changed only.
Default setting of related parameter	Not reflected (The setting of related parameters are not changed. If changes are required, do the changes manually.)	The default settings for the related parameters are automatically rewritten.
Fault detection when setting multiple parameters	Accepts and responds normally to valid setting data even if the data contains parameter setting errors. The disabled setting data will be discarded, but no error message is returned.	If there is a setting error in even one parameter, it responds with a fault. Sent data is completely discarded.

◆ Self-Diagnostics

The drive is capable of self-diagnosing the operation of the serial communications interface circuit. This function is called Self-Diagnostics. Self-Diagnostics connects the transmission terminal of the communication part with the reception terminal and transmits the data that the drive has sent, checking whether the drive is able to communicate normally.

Follow the procedure below to perform Self-Diagnostics.

1. Energize the drive.
2. Set the *H1-06 = 67* [Terminal S6 Function Select = Communications test mode].
3. De-energize the drive.
4. Connect the control circuit terminal S6 to SN.

Make sure terminal SC and terminal SP are connected by a wire jumper.

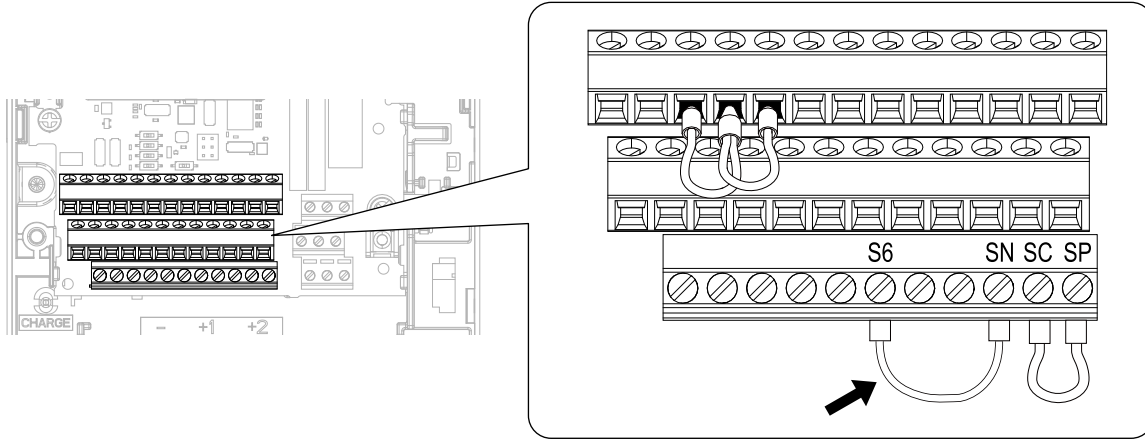

Figure 5.7 Terminal Connection of the Communication Part when Performing Self-Diagnostics

5. Energize the drive.
6. When normal, *PASS [MEMOBUS/Modbus Communications Test Mode Normal]* is displayed on the keypad.
When there is an error, *CE [MEMOBUS/Modbus Communications Error]* is displayed on the keypad.
7. De-energize the drive.
8. Disconnect the wire jumper from terminal S6-SN. Also, set terminal S6 to its original function.
9. Self-Diagnostics is completed and returns to normal functionality.

◆ Communications Data Table

The following table lists the communications data. The data types are command data, monitor data, and broadcast message.

The communications registers for the parameter numbers are listed on the “Parameter List.”

■ Command Data

The command data can be read and written.

Note:

Set the reserved bit to 0. Also, do not write the data in the reserved register and the monitor register.

Table 5.6 MEMOBUS/Modbus Communications Command Data

Register No. (Hex.)	Description	
0000	Reserved	
0001	Run command, multi-function input command	
	bit 0	When $H5-12 = 0$, Forward run/stop 1: Forward run, 0: Stop When $H5-12 = 1$, run/stop 1: Run, 0: Stop
	bit 1	When $H5-12 = 0$, Reverse run/stop 1: Reverse run, 0: Stop When $H5-12 = 1$, Forward/Reverse run 1: Reverse, 0: Forward run
	bit 2	External fault 1: EF0 [Option Card External Fault]
	bit 3	Fault Reset 1: Reset command
	bit 4	Multi-function input command 1 When the multi-function input command is $H1-01 = 40$ [Forward Run Command (2-Wire Seq)], bit 4 is "ComRef." Note: When the bit is switched ON as ComRef, the frequency reference source changes to MEMOBUS/Modbus communications. However, the frequency reference source gives priority to the communications option when the communication option is connected to the drive.
	bit 5	Multi-function input command 2 When the multi-function input command is $H1-02 = 41$ [Reverse Run Command (2-Wire Seq)], bit 5 is "ComCtrl." Note: When the bit is switched ON as ComCtrl, the Run command source changes to MEMOBUS/Modbus communications. However, the Run command source gives priority to the communications option when the communication option is connected to the drive.
	bit 6	Multi-function input command 3
	bit 7	Multi-function input command 4
	bit 8	Multi-function input command 5
	bit 9	Multi-function input command 6
	bit A	Multi-function input command 7
	bit B	Multi-function input command 8
bit C - F	Reserved	
0002	Frequency reference	The units are determined by $o1-03$ [Keypad Display Selection] (unsigned).
0003	Output voltage gain	Units: 0.1% Setting range: 20 (2.0%) to 2000 (200.0%), the default value at power up: 1000 (100.0%)
0004	Torque reference/torque limit (0.1% signed)	
0005	Torque compensation (0.1% signed)	
0006	PID setpoint (0.01% signed)	
0007	Setting for the multi-function analog monitor output terminal 1 (10 V/4000 (Hex.))	
0008	Setting for the multi-function analog monitor output terminal 2 (10 V/4000 (Hex.))	

5.3 MEMOBUS/Modbus Communications

Register No. (Hex.)	Description	
0009	MFDO setting	
	bit 0	MFDO (terminal M1-M2) 1: ON, 0: OFF
	bit 1	MFDO (terminal M2-M3) 1: ON, 0: OFF
	bit 2	Multi-function photocoupler output 1 1: ON, 0: OFF
	bit 3	Multi-function photocoupler output 2 1: ON, 0: OFF
	bit 4	Reserved
	bit 5	Reserved
	bit 6	1: bit 7 function is enabled
	bit 7	Fault relay output (terminal MA/MB-MC) 1: ON, 0: OFF
	bit 8 - F	Reserved
000A	Pulse train output (Units: 1/1 Hz, setting range: 0 to 32000)	
000B - 000E	Reserved	
000F	Command selection setting	
	bit 0	Reserved
	bit 1	Input for the PID setpoint 1: Target values from the MEMOBUS/Modbus are enabled
	bit 2	Torque reference/torque limit input 1: Setting values from the MEMOBUS/Modbus are enabled
	bit 3	Torque Compensation Input 1: Setting values from the MEMOBUS/Modbus are enabled
	bit 4	Reserved
	bit 5	PID feedback from the MEMOBUS/Modbus 1: PID feedback (15FF (Hex.)) from the MEMOBUS/Modbus is enabled
	bit 6 - B	Reserved
	bit C	Terminal S5 input of broadcast message 1: Enabled, 0: Disabled
	bit D	Terminal S6 input of broadcast message 1: Enabled, 0: Disabled
	bit E	Terminal S7 input of broadcast message 1: Enabled, 0: Disabled
	bit F	Terminal S8 input of broadcast message 1: Enabled, 0: Disabled
0010 - 001A	Reserved	
001B	Analog monitor option AO-A3 analog output 1 value (10 V/4000 (Hex.))	
001C	Analog monitor option AO-A3 analog output 2 value (10 V/4000 (Hex.))	
001D	Digital output option DO-A3 output value (binary)	
001E - 001F	Reserved	
15C0	bit 0	Extended multi-function input command 1
	bit 1	Extended multi-function input command 2
	bit 2	Extended multi-function input command 3
	bit 3 - F	Reserved

■ Monitor Data

Monitor data can only be read.

Table 5.7 Monitor Data for MEMOBUS/Modbus Communication

Register No. (Hex.)	Description	
0020	Drive status 1	
	bit 0	During Run 1: During run, 0: During stop
	bit 1	During Reverse 1: During reverse, 0: Forward run
	bit 2	Drive ready 1: Ready, 0: Not ready
	bit 3	Fault 1: Fault
	bit 4	Data Setting Error 1: oPExx error
	bit 5	MFDO (terminal M1-M2) 1: ON, 0: OFF
	bit 6	MFDO (terminal M3-M4) 1: ON, 0: OFF
	bit 7	Multi-function photocoupler output 1 (terminal P1-C1) 1: ON, 0: OFF
	bit 8	Multi-function photocoupler output 2 (terminal P2-C2) 1: ON, 0: OFF
	bit 9 - D	Reserved
	bit E	ComRef status 1: Enabled
	bit F	ComCtrl status 1: Enabled
	0021	Fault description 1
bit 0		oC [Overcurrent], GF [Ground Fault]
bit 1		ov [DC Bus Overvoltage]
bit 2		oL2 [Drive Overloaded]
bit 3		oH1 [Heatsink Overheat], oH2 [Drive Overheat Warning]
bit 4		rH [Braking Resistor Overheat], tr [Dynamic Braking Transistor]
bit 5		Reserved
bit 6		FbL [PID Feedback Loss], FbH [Excessive PID Feedback]
bit 7		EF0 [Option Card External Fault], EF1 to EF8 [External fault]
bit 8		CPFxx [Hardware Fault] Note: Includes <i>oFx</i> .
bit 9		oL1 [Motor Overload], oL3, L4 [Overtorque Detection 1/2], UL3, L4 [Undertorque Detection 1/2]
bit A		PGo [PG Disconnect], PGoH [PG Hardware Fault], oS [Overspeed], dEv [Speed Deviation]
bit B		During Uv [DC Bus Undervoltage] detection
bit C		Uv1 [DC Bus Undervoltage], Uv2 [Ctrl Power Supply Voltage Fault], Uv3 [SoftCharge Bypass Circuit Fault]
bit D		LF [Output Phase Loss], PF [Input Phase Loss]
bit E		CE [MEMOBUS/Modbus Communications Error], bUS [Option Communication Error]
bit F		oPr [Keypad Connection Fault]

5.3 MEMOBUS/Modbus Communications

Register No. (Hex.)	Description	
0022	Fault Contents	
	bit 0	1: During data writing, during motor switching
	bit 1	Reserved
	bit 2	
	bit 3	1: Upper/Lower Limit Fault
	bit 4	1: Data Integrity Fault
	bit 5	1: During EEPROM writing
	bit 6	0: EEPROM writing 1: Change only data on the RAM Note: Enabled when $H5-17 = 1$ [<i>Busy Enter Selection = Write in RAM only</i>].
bit 7 - F	Reserved	
0023	U1-01 [Freq Reference] Note: The unit changes depending on the setting of $o1-03$ [<i>Keypad Display Selection</i>].	
0024	U1-02 [Output Frequency] Note: The unit changes depending on the setting of $o1-03$ [<i>Keypad Display Selection</i>].	
0025	U1-06 [OutVoltage Reference] (units: 0.1 V) Note: Able to replace the setting unit with $H5-10$ [<i>Unit Sel for MEMOBUS/Modbus 0025H</i>].	
0026	U1-03 [Output Current] Note: The unit of display varies depending on the model. 2004 to 2042, 4002 to 4023: 0.01 A 2056 to 2415, 4031 to 4675: 0.1 A	
0027	U1-08 [Output Power]	
0028	U1-09 [Torque Reference]	
0029	Fault description 2	
	bit 0	Reserved
	bit 1	GF [Ground Fault]
	bit 2	PF [Input Phase Loss]
	bit 3	LF [Output Phase Loss]
	bit 4	rH [Braking Resistor Overheat]
	bit 5	Reserved
	bit 6	oH4 [Motor Overheat Fault (PTC Input)]
bit 7 - F	Reserved	

Register No. (Hex.)	Description	
002A	Minor Fault Description 1	
	bit 0 - 1	Reserved
	bit 2	EF [FWD/REV Run Command Input Error]
	bit 3	bb [Baseblock]
	bit 4	oL3 [Overtorque 1]
	bit 5	oH [Heatsink Overheat]
	bit 6	ov [DC Bus Overvoltage]
	bit 7	Uv [DC Bus Undervoltage]
	bit 8	FAn [Internal Fan Fault]
	bit 9	CE [MEMOBUS/Modbus Communication Err]
	bit A	bUS [Option Communication Error]
	bit B	UL3/UL4 [Undertorque Detection 1/2]
	bit C	oH3 [Motor Overheat (PTC)]
	bit D	FbL [PID Feedback Loss], FbH [Excessive PID Feedback]
	bit E	Reserved
bit F	CALL [Serial Comm Transmission Error]	
002B	U1-10 [Input Terminal Status]	
	bit 0	1: Control circuit terminal S1 ON
	bit 1	1: Control circuit terminal S2 ON
	bit 2	1: Control circuit terminal S3 ON
	bit 3	1: Control circuit terminal S4 ON
	bit 4	1: Control circuit terminal S5 ON
	bit 5	1: Control circuit terminal S6 ON
	bit 6	1: Control circuit terminal S7 ON
	bit 7	1: Control circuit terminal S8 ON
	bit 8 - F	Reserved

5.3 MEMOBUS/Modbus Communications

Register No. (Hex.)	Description	
002C	Drive status 2	
	bit 0	During Run 1: During run
	bit 1	During zero speed 1: During zero speed
	bit 2	Speed agreement 1: During agreement
	bit 3	User-defined speed agreement 1: During agreement
	bit 4	Frequency Detection 1 1: Output frequency \leq L4-01
	bit 5	Frequency Detection 2 1: Output frequency \geq L4-01
	bit 6	Drive ready 1: Run ready
	bit 7	During low voltage detection 1: During detection
	bit 8	During baseblock 1: Drive output during baseblock
	bit 9	Frequency reference mode 1: No communication option, 0: Communication option
	bit A	Run command mode 1: No communication option, 0: Communication option
	bit B	During overtorque/undertorque 1, 2 detection
	bit C	Frequency reference loss 1: Loss
	bit D	Restart Enabled 1: Restart Enabled
	bit E	Fault 1: Fault generated
bit F	MEMOBUS/Modbus communications timeout 1: At Timeout	
002D	U1-11 [Output Terminal Status]	
	bit 0	MFDO (terminal M1-M2) 1: ON, 0: OFF
	bit 1	MFDO (terminal M3-M4) 1: ON, 0: OFF
	bit 2	Multi-function PHC output 1 (terminal P1-C1) 1: ON, 0: OFF
	bit 3	Multi-function PHC output 2 (terminal P2-C2) 1: ON, 0: OFF
	bit 4 - 6	Reserved
	bit 7	Fault relay output (terminal MA/MB-MC) 1: ON, 0: OFF
	bit 8 - F	Reserved
002E	Reserved	
002F	Frequency reference bias (Up 2/Down 2 function) (Units: 0.1%)	
0030	Reserved	

Register No. (Hex.)	Description	
0031	U1-07 [DC Bus Voltage] (Units: 1 V)	
0032	U1-09 [Torque Reference] (Units: 1%)	
0033	Reserved	
0034	Product code 1 [ASCII], product type (GA700 =0A)	
0035	Product code 2 [ASCII], region	
0036 - 0037	Reserved	
0038	PID Feedback: Unsigned, input is equivalent to 100%/maximum output frequency (Units:0.1%)	
0039	PID Input: Unsigned, $\pm 100\%$ / \pm maximum output frequency (Units:0.1%)	
003A	PID Output: Unsigned, $\pm 100\%$ / \pm maximum output frequency (Units:0.1%)	
003B - 003C	Reserved	
003D	Communications error description Note: The description of the communications error is saved until the fault is reset.	
	bit 0	CRC Error
	bit 1	Data Length Error
	bit 2	Reserved
	bit 3	Parity Error
	bit 4	Overrun Error
	bit 5	Framing Error
	bit 6	Timeout
bit 7 - F	Reserved	
003E	Output frequency	Units: min^{-1} or r/min Note: Set E2-04, E4-04, E5-04, E9-08 [Motor Pole Count].
003F		0.01%
0040 - 004A	Used with U1-xx [Operation Status Monitors]. Refer to the U Monitor for details.	
004B	U1-12 [Drive Status]	
	bit 0	1: During run
	bit 1	1: During zero speed
	bit 2	1: During reverse
	bit 3	1: During reset signal input
	bit 4	1: During speed agreement
	bit 5	1: Drive operation ready
	bit 6	1: Minor Fault
	bit 7	1: Fault
	bit 8	1: oPExx [Operation Error] generation
	bit 9	1: Recovery from momentary power loss, 0: Power recovery
	bit A	1: Motor 2 Selection
	bit B	Reserved
	bit E	ComRef status/ NetRef status
bit F	ComCtrl status/ NetCtrl status	
004C - 007E	Use with U1-xx, U4-xx, U5-xx, U6-xx [Monitors]. Refer to "U2: Fault Trace" and "U3: Fault History" for details.	
007F	Minor fault code (Refer to "Minor fault description" for more information on the minor fault codes.)	

5.3 MEMOBUS/Modbus Communications

Register No. (Hex.)	Description	
0080 - 0097	Use with <i>U2-xx, U3-xx [Monitors]</i> . Refer to "U Monitor," and refer to "Fault Trace/Fault History Descriptions" for details on register values.	
0098 - 0099	U4-01 [Cumulative Ope Time] (Ex.) When <i>U4-01 [Cumulative Ope Time]</i> is 12345, 0098(Hex.) = 1234 and 0099(Hex.) = 5.	
009A - 009B	U4-03 [Cooling Fan Ope Time] (Ex.) When <i>U4-03 [Cooling Fan Ope Time]</i> is 12345, 009A(Hex.) = 1234 and 009B (Hex.) = 5.	
009C - 00AA	Reserved	
00AB	Drive rated current Note: The unit of display varies depending on the model. 2004 to 2042, 4002 to 4023: 0.01 A 2056 to 2415, 4031 to 4675: 0.1 A	
00AC	U1-05 [Motor Speed]	Units: min ⁻¹ or r/min Note: Set <i>E2-04, E4-04, E5-04, E9-08 [Motor Pole Count]</i> .
00AD		Units: 0.01%
00AE, 00AF	Reserved	
00B0	Optional codes connected to CN5-A	Optional connected codes are stored in the register. AI-A3 = 0003(Hex.) AO-A3 = 0004(Hex.) DI-A3 = 0001(Hex.) DO-A3 = 0002(Hex.) PG-B3 = 0011(Hex.) PG-F3 = 0021(Hex.) PG-RT3 = 0023(Hex.) PG-X3 = 0012(Hex.) SI-C3 = 5343(Hex.) SI-EM3 = 1005(Hex.) SI-EN3 = 1006(Hex.) SI-ET3 = 1004(Hex.) SI-N3 = 534E(Hex.) SI-P3 = 5350(Hex.) SI-S3 = 5353(Hex.) SI-T3 = 5354(Hex.) SI-W3 = 1003(Hex.)
00B1	Reserved	
00B2	Optional codes connected to CN5-B	
00B3	Optional codes connected to CN5-C	
00B4	Reserved	
00B5	U1-16 [Output Freq afterSFS]	Units: min ⁻¹ or r/min Note: Set <i>E2-04, E4-04, E5-04, E9-08 [Motor Pole Count]</i> .
00B6		Units: 0.01%
00B7	Frequency reference monitor	Units: min ⁻¹ or r/min Note: Set <i>E2-04, E4-04, E5-04, E9-08 [Motor Pole Count]</i> .
00B8		Units: 0.01%
00B9 - 00BE	Reserved	
00BF	Operation error number xx of <i>oPExx</i> is displayed.	

Register No. (Hex.)	Description	
00C0	Fault description 3	
	bit 0	Reserved
	bit 1	Uv1 [DC Bus Undervoltage]
	bit 2	Uv2 [Ctrl Power Supply Voltage Fault]
	bit 3	Uv3 [SoftCharge Bypass Circuit Fault]
	bit 4	SC [Out Short Circuit or IGBT Fault]
	bit 5	GF [Ground Fault]
	bit 6	oC [Overcurrent]
	bit 7	ov [DC Bus Overvoltage]
	bit 8	oH [Heatsink Overheat]
	bit 9	oH1 [Heatsink Overheat]
	bit A	oL1 [Motor Overload]
	bit B	oL2 [Drive Overloaded]
	bit C	oL3 [Overtorque Detection 1]
	bit D	oL4 [Overtorque Detection 2]
bit E	rr [Dynamic Braking Transistor]	
bit F	rH [Braking Resistor Overheat]	
00C1	Fault description 4	
	bit 0	EF3 [External Fault (terminal S3)]
	bit 1	EF4 [External Fault (terminal S4)]
	bit 2	EF5 [External Fault (terminal S5)]
	bit 3	EF6 [External Fault (terminal S6)]
	bit 4	EF7 [External Fault (terminal S7)]
	bit 5	EF8 [External Fault (terminal S8)]
	bit 6	FAn [Internal Fan Fault]
	bit 7	oS [Overspeed]
	bit 8	dEv [Speed Deviation]
	bit 9	PGo [PG Disconnect]
	bit A	PF [Input Phase Loss]
	bit B	LF [Output Phase Loss]
	bit C	oH3 [Motor Overheat Alarm (PTC Input)]
	bit D	oPr [Keypad Connection Fault]
bit E	Err [EEPROM Write Error]	
bit F	oH4 [Motor Overheat Fault (PTC Input)]	

5.3 MEMOBUS/Modbus Communications

Register No. (Hex.)	Description	
00C2	Fault description 5	
	bit 0	CE [MEMOBUS/Modbus Communication Fault]
	bit 1	bUS [Option Communication Error]
	bit 2 - 3	Reserved
	bit 4	CF [Control Fault]
	bit 5	SvE [Zero Servo Fault]
	bit 6	EF0 [Option Card External Fault]
	bit 7	FbL [PID Feedback Loss]
	bit 8	UL3 [Undertorque Detection 1]
	bit 9	UL4 [Undertorque Detection 2]
	bit A	oL7 [High Slip Braking oL]
	bit B - E	Reserved
	bit F	Hardware Fault (includes <i>oFx</i> fault)
00C3	Fault description 6	
	bit 0	Reserved
	bit 1	dv1 [Z Pulse Fault]
	bit 2	dv2 [Z Pulse Noise Fault Detection]
	bit 3	dv3 [Inversion Detection]
	bit 4	dv4 [Inversion Prevention Detection]
	bit 5	LF2 [Output Current Imbalance]
	bit 6	STPo [Pull-Out Detection]
	bit 7	PGoH [PG Hardware Fault]
	bit 8	E5 [MECHATROLINK Watchdog Timer Err]
	bit 9	Reserved
	bit A	SEr [Too Many Speed Search Restarts]
	bit B - F	Reserved
00C4	Fault description 7	
	bit 0	FbH [Excessive PID Feedback]
	bit 1	EF1 [External Fault (terminal S1)]
	bit 2	EF2 [External Fault (terminal S2)]
	bit 3	oL5 [Mechanical Weakening Detection 1]
	bit 4	UL5 [Mechanical Weakening Detection 2]
	bit 5	CoF [Current Offset Fault]
	bit 6 - 7	Reserved
	bit 8	dWFL [DriveWorksEZ Fault]
	bit 9	dWF1 [EEPROM Memory DWEZ Data Error]
	bit A	dWF2 [DriveWorksEZ Fault 2]
	bit B	dWF3 [DriveWorksEZ Fault 3]
	bit C	Reserved
	bit D	rF [Braking Resistor Fault]
	bit E	boL [Braking Transistor Overload Fault]
bit F	Reserved	

Register No. (Hex.)	Description	
00C5	Fault description 8	
	bit 0	LSo [LSo Fault]
	bit 1	nSE [Node Setup Error]
	bit 2 - 9	Reserved
	bit A	dv7 [Polarity Judge Timeout]
	bit B - D	Reserved
	bit E	LF3 [Output Phase Loss 3]
	bit F	UnbC [Current Imbalance]
00C6	Fault description 9	
	bit 0	Uv4 [Gate Drive Board Power Supply Voltage Low]
	bit 1 - F	Reserved
00C7	Reserved	
00C8	Minor Fault Description 2	
	bit 0	Uv [DC Bus Undervoltage]
	bit 1	ov [DC Bus Overvoltage]
	bit 2	oH [Heatsink Overheat]
	bit 3	oH2 [Drive Overheat Warning]
	bit 4	oL3 [Overtorque 1]
	bit 5	oL4 [Overtorque 2]
	bit 6	EF [FWD/REV Run Command Input Error]
	bit 7	bb [Baseblock]
	bit 8	EF3 [External Fault (terminal S3)]
	bit 9	EF4 [External Fault (terminal S4)]
	bit A	EF5 [External Fault (terminal S5)]
	bit B	EF6 [External Fault (terminal S6)]
	bit C	EF7 [External Fault (terminal S7)]
	bit D	EF8 [External Fault (terminal S8)]
	bit E	FAn [Internal Fan Fault]
bit F	oS [Overspeed]	

5.3 MEMOBUS/Modbus Communications

Register No. (Hex.)	Description	
00C9	Minor Fault Description 3	
	bit 0	dEv [Speed Deviation]
	bit 1	PGo [PG Disconnect]
	bit 2	oPr [Keypad Connection Fault]
	bit 3	CE [MEMOBUS/Modbus Communication Err]
	bit 4	bUS [Option Communication Error]
	bit 5	CALL [Serial Comm Transmission Error]
	bit 6	oL1 [Motor Overload]
	bit 7	oL2 [Drive Overloaded]
	bit 8	Reserved
	bit 9	EF0 [Option Card External Fault]
	bit A	rUn [Motor Switch during Run]
	bit B	Reserved
	bit C	CALL [Serial Comm Transmission Error]
	bit D	UL3 [Undertorque Detection 1]
	bit E	UL4 [Undertorque Detection 2]
bit F	SE [MEMOBUS/Modbus Comm Test Mode Err]	
00CA	Minor Fault Description 4	
	bit 0	Reserved
	bit 1	oH3 [Motor Overheat (PTC)]
	bit 2 - 5	Reserved
	bit 6	FbL [PID Feedback Loss]
	bit 7	FbH [Excessive PID Feedback]
	bit 8	Reserved
	bit 9	dnE [Drive Disabled]
	bit A	PGoH [PG Hardware Fault]
	bit B - F	Reserved
00CB	Minor Fault Description 5	
	bit 0	E5 [MECHATROLINK Watchdog Timer Err]
	bit 1	AEr [Station Address Setting Error (CC-Link, CANopen, MECHATROLINK)]
	bit 2	CyC [MECHATROLINK CommCycleSettingErr]
	bit 3	HCA [Current Alarm]
	bit 4	LT-1 [Cooling Fan Maintenance Time]
	bit 5	LT-2 [Capacitor Maintenance Time]
	bit 6 - 7	Reserved
	bit 8	EF1 [External Fault (terminal S1)]
	bit 9	EF2 [External Fault (terminal S2)]
	bit A	SToF [Safe Disable Signal Input]
	bit B	STo [Safe Disable Signal Input]
	bit C	oL5 [Mechanical Weakening Detection 1]
	bit D	UL5 [Mechanical Weakening Detection 2]
bit E - F	Reserved	

Register No. (Hex.)	Description	
00CC	Minor Fault Description 6	
	bit 0	Reserved
	bit 1	TrPC [IGBT Maintenance Time (90%)]
	bit 2	LT-3 [SoftChargeBypassRelay MainteTime]
	bit 3	LT-4 [IGBT Maintenance Time (50%)]
	bit 4	boL [BrakingTransistor Overload Fault]
	bit 5 - 7	Reserved
	bit 8	dWAL [DriveWorksEZ Fault]
	bit 9	dWA2 [DriveWorksEZ Alarm 2]
	bit A	dWA3 [DriveWorksEZ Alarm 3]
bit B - F	Reserved	
00CD - 00CF	Reserved	
00D0	CPF description 1	
	bit 0 - 1	Reserved
	bit 2	CPF02 [A/D Conversion Failure]
	bit 3	CPF03 [PWM Motor Failure]
	bit 4 - 5	Reserved
	bit 6	CPF06 [Control Circuit Error]
	bit 7	CPF07 [Terminal Board Connection Error]
	bit 8	CPF08 [EEPROM Serial Communications Error]
	bit 9	Reserved
	bit A	CRF10 [ASIC Verify Fault]
	bit B	CRF11 [RAM Fault]
	bit C	CRF12 [FLASH Memory Fault]
	bit D	CPF13 [Watchdog Circuit Exception]
	bit E	CPF14 [Control Circuit Fault]
bit F	Reserved	

5.3 MEMOBUS/Modbus Communications

Register No. (Hex.)	Description	
00D1	CPF description 2	
	bit 0	CPF16 [Clock Fault]
	bit 1	CPF17 [Timing Fault]
	bit 2	CPF18 [Control Circuit Fault]
	bit 3	CPF19 [Control Circuit Fault]
	bit 4	CPF20 [Hardware Fault (at power ON)]
	bit 5	CPF21 [Hardware Fault (after communication start up)]
	bit 6	CPF22 [A/D Conversion Failure]
	bit 7	CPF23 [PWM Feedback Fault]
	bit 8	CPF24 [Drive Capacity Signal Fault]
	bit 9	CPF25 [Terminal Board not Connected]
	bit A	CPF26 [ASIC BB Circuit Error]
	bit B	CPF27 [ASIC PWM Setting Register Error]
	bit C	CPF28 [ASIC PWM Pattern Error]
	bit D	CPF29 [ASIC On-delay Error]
	bit E	CPF30 [ASIC BB ON Error]
bit F	CPF31 [ASIC Code Error]	
00D2	CPF description 3	
	bit 0	CPF32 [ASIC Start-up Error]
	bit 1	CPF33 [Watchdog Circuit Exception Circuit Fault]
	bit 2	CPF34 [ASIC Power, Clock Error]
	bit 3	CPF35 [External A/D Conversion Failure]
	bit 4	CPU36 [ASIC Communications Error (Initial)]
	bit 5	CPU37 [ASIC Communications Error (Online)]
	bit 6	CPU38 [EEPROM Data Fault (I/F board side)]
	bit 7	CPU39 [CPU-ASIC Communications Fault]
	bit 8	CPF40 [Control Circuit Error]
	bit 9	CPF41 [Control Circuit Error]
	bit A	CPF42 [Control Circuit Error]
	bit B	CPF43 [Control Circuit Error]
	bit C	CPF44 [Control Circuit Error]
	bit D	CPF45 [Control Circuit Error]
	bit E - F	Reserved
00D3 - 00D7	Reserved	
00D8	oFA0x Description (CN5-A)	
	bit 0	oFA00 [Not supported]
	bit 1	oFA01 [Option Connection Error]
	bit 2 - 4	Reserved
	bit 5	oFA05 [A/D Conversion Error]
	bit 6	oFA06 [Option Response Error]
	bit 7 - F	Reserved

Register No. (Hex.)	Description	
00D9	oFA1x Description (CN5-A)	
	bit 0	oFA10 [RAM Fault]
	bit 1	oFA11 [Option Operation Mode Fault (SLMOD)]
	bit 2	oFA12 [CRC Error (Drive receive)]
	bit 3	oFA13 [Frame Error (Drive receive)]
	bit 4	oFA14 [Abort Error (Drive receive)]
	bit 5	oFA15 [CRC Error (Option card receive)]
	bit 6	oFA16 [Frame Error (option card receive)]
	bit 7	oFA17 [Abort Error (option card receive)]
bit 8 - F	Reserved	
00DA	Reserved	
00DB	oFA3x Description (CN5-A)	
	bit 0	oFA30 [Comm. ID Error]
	bit 1	oFA31 [Model Code Error]
	bit 2	oFA32 [Checksum Error]
	bit 3	oFA33 [Comm. option timeout waiting for response]
	bit 4	oFA34 [MEMOBUS/Modbus communications timeout]
	bit 5	oFA35 [Drive timeout waiting for response]
	bit 6	oFA36 [CI Check Error]
	bit 7	oFA37 [Drive timeout waiting for response]
	bit 8	oFA38 [Control Command Selection Error]
	bit 9	oFA39 [Drive timeout waiting for response]
	bit A	oFA40 [Control Response Selection 1 Error]
	bit B	oFA41 [Drive timeout waiting for response]
	bit C	oFA42 [Control Response Selection 2 Error]
	bit D	oFA43 [Drive timeout waiting for response]
bit E - F	Reserved	
00DC	oFb0x Description (CN5-B)	
	bit 0	oFb00 [Not supported]
	bit 1	oFb01 [Option Connection Error]
	bit 2	oFb02 [DuplicateOptions]
	bit 3 - 4	Reserved
	bit 5	oFb05 [A/D Conversion Error]
	bit 6	oFb06 [Option Response Error]
bit 7 - F	Reserved	

5.3 MEMOBUS/Modbus Communications

Register No. (Hex.)	Description	
00DD	oFb1x Description (CN5-B)	
	bit 0	oFb10 [RAM Fault]
	bit 1	oFb11 [Option Operation Mode Fault (SLMOD)]
	bit 2	oFb12 [CRC Error (Drive receive)]
	bit 3	oFb13 [Frame Error (Drive receive)]
	bit 4	oFb14 [Abort Error (Drive receive)]
	bit 5	oFb15 [CRC Error (Option card receive)]
	bit 6	oFb16 [Frame Error (option card receive)]
	bit 7	oFb17 [Abort Error (option card receive)]
	bit 8 - F	Reserved
00DE - 00DF	Reserved	
00E0	oFb3x Description (CN5-B)	
	bit 0	oFb30 [Comm. ID Error]
	bit 1	oFb31 [Model Code Error]
	bit 2	oFb32 [Checksum Error]
	bit 3	oFb33 [Comm. option timeout waiting for response]
	bit 4	oFb34 [MEMOBUS/Modbus communications timeout]
	bit 5	oFb35 [Drive timeout waiting for response]
	bit 6	oFb36 [CI Check Error]
	bit 7	oFb37 [Drive timeout waiting for response]
	bit 8	oFb38 [Control Command Selection Error]
	bit 9	oFb39 [Drive timeout waiting for response]
	bit A	oFb40 [Control Response Selection 1 Error]
	bit B	oFb41 [Drive timeout waiting for response]
	bit C	oFb42 [Control Response Selection 2 Error]
	bit D	oFb43 [Drive timeout waiting for response]
bit E - F	Reserved	
00E1	oFC0x Description (CN5-C)	
	bit 0	oFC00 [Not supported]
	bit 1	oFC01 [Connection Error]
	bit 2	oFC02 [DuplicateOptions]
	bit 3 - 4	Reserved
	bit 5	oFC05 [A/D Conversion Error]
	bit 6	oFC06 [Option Response Error]
	bit 7 - F	Reserved

Register No. (Hex.)	Description	
00E2	oFC1x Description (CN5-C)	
	bit 0	oFC10 [RAM Fault]
	bit 1	oFC11 [Option Operation Mode Fault (SLMOD)]
	bit 2	oFC12 [CRC Error (Drive receive)]
	bit 3	oFC13 [Frame Error (Drive receive)]
	bit 4	oFC14 [Abort Error (Drive receive)]
	bit 5	oFC15 [CRC Error (Option card receive)]
	bit 6	oFC16 [Frame Error (option card receive)]
	bit 7	oFC17 [Abort Error (option card receive)]
bit 8 - F	Reserved	
00E3	Reserved	
00E4	oFC5x Description (CN5-C)	
	bit 0	oFC50 [Encoder Option AD Conversion Error]
	bit 1	oFC51 [Encoder Option Analog Circuit Error]
	bit 2	oFC52 [Encoder Communication Timeout]
	bit 3	oFC53 [Encoder Communication Data Error]
	bit 4	oFC54 [Encoder Error]
	bit 5	oFC55 [Resolver Error]
bit 6 - F	Reserved	
00E5	Minor Fault Description 9	
	bit 0	EP24v [External Power 24V Supply]
	bit 1 - 3	Reserved
	bit 4	bAT [Keypad Battery Voltage Low]
	bit 5 - F	Reserved
00E6 - 00E9	Reserved	
00EA	Fault description 11	
	bit 0- D	Reserved
	bit E	SCF [Safety Circuit Fault]
	bit F	Reserved
00EB - 00FA	Reserved	
00FB	Output current Note: The unit of display varies depending on the model. 2004 to 2042, 4002 to 4023: 0.01 A 2056 to 2415, 4031 to 4675: 0.1 A	

■ Broadcast Messages

Broadcast messages are available as read-only.

The undefined bit signal in the broadcast operation signal continues using the local data signal.

Table 5.8 Broadcast Messages for MEMOBUS/Modbus Communication

Register No. (Hex.)	Description	
0001	Operation signal	
	bit 0	Run command 1: Run, 0: Stop
	bit 1	Reverse run command 1: Reverse, 0: Forward run
	bit 2 - 3	Reserved
	bit 4	External fault 1: EF0 [Option Card External Fault]
	bit 5	Fault Reset 1: Reset command
	bit 6 - B	Reserved
	bit C	MFDI terminal S5 input
	bit D	MFDI terminal S6 input
	bit E	MFDI terminal S7 input
	bit F	MFDI terminal S8 input
0002	Frequency reference	30000/100%

■ Fault Trace/Fault History Contents

The following table lists the fault codes read using the commands from monitors [*U2-xx*, *U3-xx*].

Table 5.9 Fault Trace/Fault History Contents

Fault code (Hex.)	Name	Fault code (Hex.)	Name
0002	Uv1 [DC Bus Undervoltage]	0017	FAn [Internal Fan Fault]
0003	Uv2 [Ctrl Power Supply Voltage Fault]	0018	oS [Overspeed]
0004	Uv3 [SoftCharge Bypass Circuit Fault]	0019	dEv [Speed Deviation]
0005	SC [Out Short Circuit or IGBT Fault]	001A	PGo [PG Disconnect]
0006	GF [Ground Fault]	001B	PF [Input Phase Loss]
0007	oC [Overcurrent]	001C	LF [Output Phase Loss]
0008	ov [DC Bus Overvoltage]	001D	oH3 [Motor Overheat Alarm (PTC Input)]
0009	oH [Heatsink Overheat]	001E	oPr [Keypad Connection Fault]
000A	oH1 [Heatsink Overheat]	001F	Err [EEPROM Write Error]
000B	oL1 [Motor Overload]	0020	oH4 [Motor Overheat Fault (PTC Input)]
000C	oL2 [Drive Overloaded]	0021	CE [MEMOBUS/Modbus Communication Fault]
000D	oL3 [Overtorque Detection 1]	0022	bUS [Option Communication Error]
000E	oL4 [Overtorque Detection 2]	0025	CF [Control Fault]
000F	rr [Dynamic Braking Transistor]	0026	SvE [Zero Servo Fault]
0010	rH [Braking Resistor Overheat]	0027	EF0 [Option Card External Fault]
0011	EF3 [External Fault (terminal S3)]	0028	FbL [PID Feedback Loss]
0012	EF4 [External Fault (terminal S4)]	0029	UL3 [Undertorque Detection 1]
0013	EF5 [External Fault (terminal S5)]	002A	UL4 [Undertorque Detection 2]
0014	EF6 [External Fault (terminal S6)]	002B	oL7 [High Slip Braking oL]
0015	EF7 [External Fault (terminal S7)]	0030	Includes oFx Fault [Hardware Fault]
0016	EF8 [External Fault (terminal S8)]	0032	dv1 [Z Pulse Fault]

Fault code (Hex.)	Name	Fault code (Hex.)	Name
0033	dv2 [Z Pulse Noise Fault Detection]	0098	CPF23 [PWM Feedback Fault]
0034	dv3 [Inversion Detection]	0099	CPF24 [Drive Capacity Signal Fault]
0035	dv4 [Inversion Prevention Detection]	009A	CPF25 [Terminal Board not Connected]
0036	LF2 [Output Current Imbalance]	009B	CPF26 [ASIC BB Circuit Error]
0037	STPo [Pull-Out Detection]	009C	CPF27 [ASIC PWM Setting Register Error]
0038	PGoH [PG Hardware Fault]	009D	CPF28 [ASIC PWM Pattern Error]
0039	E5 [MECHATROLINK Watchdog Timer Err]	009E	CPF29 [ASIC On-delay Error]
003B	SEr [Too Many Speed Search Restarts]	009F	CPF30 [ASIC BB ON Error]
0041	FbH [Excessive PID Feedback]	00A0	CPF31 [ASIC Code Error]
0042	EF1 [External Fault (terminal S1)]	00A1	CPF32 [ASIC Start-up Error]
0043	EF2 [External Fault (terminal S2)]	00A2	CPF33 [Watchdog Circuit Exception Circuit Fault]
0044	oL5 [Mechanical Weakening Detection 1]	00A3	CPF34 [ASIC Power, Clock Error]
0045	UL5 [Mechanical Weakening Detection 2]	00A4	CPF35 [External A/D Conversion Failure]
0046	CoF [Current Offset Fault]	00A5	CPF36 [ASIC Reception Error]
0049	dWFL [DriveWorksEZ Fault]	00A6	CPF37 [ASIC Reception Error]
004A	dWF1 [EEPROM Memory DWEZ Data Error]	00A7	CPF38 [EEPROM Motor Failure]
004B	dWF2 [DriveWorksEZ Fault 2]	00A9	CPF40 [Control Circuit Error]
004C	dWF3 [DriveWorksEZ Fault 3]	00AA	CPF41 [Control Circuit Error]
004E	rF [Braking Resistor Fault]	00AB	CPF42 [Control Circuit Error]
004F	boL [Braking Transistor Overload Fault]	00AC	CPF43 [Control Circuit Error]
0051	LSo [LSo Fault]	00AD	CPF44 [Control Circuit Error]
0052	nSE [Node Setup Error]	00AE	CPF45 [Control Circuit Error]
005B	dv7 [Polarity Judge Timeout]	0101	oFA00 [Not supported]
005F	LF3 [Output Phase Loss 3]	0102	oFA01 [Connection Error]
0060	UnbC [Current Imbalance]	0106	oFA05 [A/D Conversion Error]
0061	Uv4 [Gate Drive Board Power Supply Voltage Low]	0107	oFA06 [Option Response Error]
0083	CPF02 [A/D Conversion Failure]	0111	oFA10 [RAM Fault]
0084	CPF03 [PWM Motor Failure]	0112	oFA11 [Option Operation Mode Fault (SLMOD)]
0087	CPF06 [Control Circuit Error]	0113	oFA12 [CRC Error (Drive receive)]
0088	CPF07 [Terminal Board Connection Error]	0114	oFA13 [Frame Error (Drive receive)]
0089	CPF08 [EEPROM Serial Communications Error]	0115	oFA14 [Abort Error (Drive receive)]
008C	CRF11 [RAM Fault]	0116	oFA15 [CRC Error (Option receive)]
008D	CRF12 [FLASH Memory Fault]	0117	oFA16 [Frame Error (option receive)]
008E	CPF13 [Watchdog Circuit Exception]	0118	oFA17 [Abort Error (option receive)]
008F	CPF14 [Control Circuit Fault]	0131	oFA30 [Comm. ID Error]
0091	CPF16 [Clock Fault]	0132	oFA31 [Model Code Error]
0092	CPF17 [Timing Fault]	0133	oFA32 [Checksum Error]
0093	CPF18 [Control Circuit Fault]	0134	oFA33 [Comm. option timeout waiting for response]
0094	CPF19 [Control Circuit Fault]	0135	oFA34 [MEMOBUS/Modbus communications timeout]
0095	CPF20 [Hardware Fault (at power ON)]	0136	oFA35 [Drive timeout waiting for response]
0096	CPF21 [Hardware Fault (after communication start up)]	0137	oFA36 [CI Check Error]
0097	CPF22 [A/D Conversion Failure]	0138	oFA37 [Drive timeout waiting for response]

Fault code (Hex.)	Name
0139	oFA38 [Control Command Selection Error]
013A	oFA39 [Drive timeout waiting for response]
013B	oFA40 [Control Response Selection 1 Error]
013C	oFA41 [Drive timeout waiting for response]
013D	oFA42 [Control Response Selection 2 Error]
013E	oFA43 [Drive timeout waiting for response]
0201	oFb00 [Not supported]
0202	oFb01 [Connection Error]
0203	oFb02 [DuplicateOptions]
0206	oFb05 [A/D Conversion Error]
0207	oFb06 [Option Response Error]
0211	oFb10 [RAM Fault]
0212	oFb11 [Option Operation Mode Fault (SLMOD)]
0213	oFb12 [CRC Error (Drive receive)]
0214	oFb13 [Frame Error (Drive receive)]
0215	oFb14 [Abort Error (Drive receive)]
0216	oFb15 [CRC Error (Option receive)]
0217	oFb16 [Frame Error (Option receive)]
0218	oFb17 [Abort Error (Option receive)]
0231	oFb30 [Comm. ID Error]
0232	oFb31 [Model Code Error]
0233	oFb32 [Checksum Error]
0234	oFb33 [Comm. option timeout waiting for response]
0235	oFb34 [MEMOBUS/Modbus communications timeout]
0236	oFb35 [Drive timeout waiting for response]
0237	oFb36 [CI Check Error]
0238	oFb37 [Drive timeout waiting for response]

Fault code (Hex.)	Name
0239	oFb38 [Control Command Selection Error]
023A	oFb39 [Drive timeout waiting for response]
023B	oFb40 [Control Response Selection 1 Error]
023C	oFb41 [Drive timeout waiting for response]
023D	oFb42 [Control Response Selection 2 Error]
023E	oFb43 [Drive timeout waiting for response]
0301	oFC00 [Not supported]
0302	oFC01 [Connection Error]
0303	oFC02 [DuplicateOptions]
0306	oFC05 [A/D Conversion Error]
0307	oFC06 [Option Response Error]
0311	oFC10 [RAM Fault]
0312	oFC11 [Option Operation Mode Fault (SLMOD)]
0313	oFC12 [CRC Error (Drive receive)]
0314	oFC13 [Frame Error (Drive receive)]
0315	oFC14 [Abort Error (Drive receive)]
0316	oFC15 [CRC Error (Option receive)]
0317	oFC16 [Frame Error (option receive)]
0318	oFC17 [Abort Error (Option receive)]
0351	oFC50 [Encoder Option AD Conversion Error]
0352	oFC51 [Encoder Option Analog Circuit Error]
0353	oFC52 [Encoder Communication Timeout]
0354	oFC53 [Encoder Communication Data Error]
0355	oFC54 [Encoder Error]
0356	oFC55 [Resolver Error]
040F	SCF [Safety Circuit Fault]
0413	FAn1 [Drive Cooling Fan Failure]

■ **Minor Fault Contents**

The following table lists the minor fault codes read using the communications register (007 (Hex.)).

Table 5.10 Minor Fault Contents (007 (Hex.))

Minor fault code (Hex.)	Name	Minor fault code (Hex.)	Name
0001	Uv [DC Bus Undervoltage]	000A	EF4 [External Fault (terminal S4)]
0002	ov [DC Bus Overvoltage]	000B	EF5 [External Fault (terminal S5)]
0003	oH [Heatsink Overheat]	000C	EF6 [External Fault (terminal S6)]
0004	oH2 [Drive Overheat Warning]	000D	EF7 [External Fault (terminal S7)]
0005	oL3 [Overtorque 1]	000E	EF8 [External Fault (terminal S8)]
0006	oL4 [Overtorque 2]	000F	FAn [Internal Fan Fault]
0007	EF [FWD/REV Run Command Input Error]	0010	oS [Overspeed]
0008	bb [Baseblock]	0011	dEv [Speed Deviation]
0009	EF3 [External Fault (terminal S3)]	0012	PGo [PG Disconnect]

Minor fault code (Hex.)	Name	Minor fault code (Hex.)	Name
0014	CE [MEMOBUS/Modbus Communication Err]	0034	HCA [Current Alarm]
0015	bUS [Option Communication Error]	0035	LT-1 [Cooling Fan Maintenance Time]
0016	CALL [Serial Comm Transmission Error]	0036	LT-2 [Capacitor Maintenance Time]
0017	oL1 [Motor Overload]	0039	EF1 [External Fault (terminal S1)]
0018	oL2 [Drive Overloaded]	003A	EF2 [External Fault (terminal S2)]
001A	EF0 [Option Card External Fault]	003B	SToF [Safe Disable Signal Input]
001B	rUn [Motor Switch during Run]	003C	STo [Safe Disable Signal Input]
001D	CALL [Serial Comm Transmission Error]	003D	oL5 [Mechanical Weakening Detection 1]
001E	UL3 [Undertorque Detection 1]	003E	UL5 [Mechanical Weakening Detection 2]
001F	UL4 [Undertorque Detection 2]	0042	TrPC [IGBT Maintenance Time (90%)]
0020	SE [MEMOBUS/Modbus Comm Test Mode Err]	0043	LT-3 [SoftChargeBypassRelay MainteTime]
0021	L24v [External 24V Power Supply Depletion]	0044	LT-4 [IGBT Maintenance Time (50%)]
0022	oH3 [Motor Overheat (PTC)]	0045	boL [BrakingTransistor Overload Fault]
0027	FbL [PID Feedback Loss]	0049	dWAL [DriveWorksEZ Fault]
0028	FbH [Excessive PID Feedback]	004A	dWA2 [DriveWorksEZ Alarm 2]
002A	dnE [Drive Disabled]	004B	dWA3 [DriveWorksEZ Alarm 3]
002B	PGoH [PG Hardware Fault]	0081	EP24v [External Power 24V Supply]
0031	E5 [MECHATROLINK Watchdog Timer Err]	0082	LoG [Log Communication Fault]
0032	AEr [Station Address Setting Error (CC-Link, CANopen, MECHATROLINK)]	0085	bAT [Keypad Battery Voltage Low]
0033	CyC [MECHATROLINK CommCycleSettingErr]		

◆ Error Code

■ MEMOBUS/Modbus Communications Error Code List

The following table lists the MEMOBUS/Modbus communications error codes.

When an error occurs, resolve the cause of the error and restart the communications.

Table 5.11 MEMOBUS/Modbus Communications Error Code

Error Code (Hex.)	Name	Cause
01	Function code error	A function code other than 03, 08, and 10 (Hex.) was set from PLC.
02	Register Number Error	<ul style="list-style-type: none"> No register No. is registered while attempting to access. Starting numbers other than 0001 or 0002 (Hex.) were set when broadcasting.
03	Bit Count Error	<ul style="list-style-type: none"> Read and write data quantities have exceeded the 1 to 16 range. (Command message data quantity is disabled.) In the write mode, the number of bytes in the message is not the number of data × 2.
21	Data Setting Error	<ul style="list-style-type: none"> Writing control data or parameters made settings go outside the allowable setting range. A parameter setting error occurred when writing a parameter.

5.3 MEMOBUS/Modbus Communications

Error Code (Hex.)	Name	Cause
22	Write Mode Error	<ul style="list-style-type: none"> • Attempted to write a disabled parameter during run. • When <i>CPF06 [EEPROM Data Error]</i> occurs, a parameter other than the following was attempted to be written from the master. <ul style="list-style-type: none"> – <i>A1-00 [Language Selection]</i> – <i>A1-01 [Access Level Selection]</i> – <i>A1-02 [Control Method Selection]</i> – <i>A1-03 [Initialize Parameters]</i> – <i>A1-04: [Password]</i> – <i>A1-05: [Password Setting]</i> – <i>E1-03 [V/f Pattern Selection]</i> – <i>o2-04 [Drive Model Selection]</i> • Writes the read-only data.
23	DC Bus Undervoltage Write Error	During <i>Uv [DC Bus Undervoltage]</i> , a <i>Uv</i> write disabled parameter was written.
24	Error Writing Data during parameter processing	Attempted to write a parameter from the master during parameter processing on the drive side.
25	Writing into EEPROM disabled	EEPROM write was executed from the MEMOBUS/Modbus communications while writing into EEPROM write is disabled. When this error occurs, a message is displayed and operation continues.

■ Slave Non Reply

In the following cases, the slave ignores the command message from the master and sends no response message.

- When a communications error (overrun, framing, parity, CRC-16) is detected in the command message.
- When the slave address inside the command message and the slave address for the drive side do not match (the slave address of the drive is set in *H5-01 [Drive Node Address]*).
- When the time interval between the data of which the message is composed exceeds the 24 bit length
- When the data length for the command message is inaccurate

Note:

- When *CALL [Serial Comm Transmission Error]* appears on the keypad, refer to “Troubleshooting” to resolve the cause of the abnormality, and try to execute communications again. If *CALL* does not appear on the keypad, check for the presence of an error and the type of error in *U1-19 [MEMOBUS/Modbus Error Code]*.
- When write function code is executed and when the slave address that is set inside the command message is 00 (Hex.), write is executed by all slaves, but response messages are not sent to the master.

Troubleshooting

6.1	Safety Precautions	264
6.2	Types of Faults, Minor Faults, Alarms, and Errors	266
6.3	List of Fault, Minor Fault, Alarm, and Error Codes	267
6.4	Fault	273
6.5	Minor Faults/Alarms	296
6.6	Parameter Setting Errors.....	309
6.7	Auto-Tuning Errors	315
6.8	Backup Function Operating Mode Display and Errors.....	320
6.9	Diagnosing and Resetting Faults.....	322
6.10	Troubleshooting without Fault Display	323

6.1 Safety Precautions

DANGER

Electrical Shock Hazard

Do not perform inspections or wiring while the drive is energized. De-energize all devices before carrying out any wiring or repair operations. Voltage will remain within the capacitors inside the drive even after the power has been switched off. The Charge LED is extinguished once the DC bus voltage goes below 50 V DC. To prevent electric shock, always wait for at least the amount of time indicated on the warning labels and confirm that all indicators are OFF. Then, remove the front cover and terminal cover, measure the input power supply voltage and the DC bus voltage, and make sure that the voltages have been lowered to safe levels.

Failure to comply may result in death or serious injury.

WARNING

Electrical Shock Hazard

Do not operate equipment with covers removed. The diagrams in this section may include drives without covers or safety shields to illustrate details. Be sure to reinstall covers or shields before operating the drives and run the drives according to the instructions described in this manual.

Failure to comply could result in death or serious injury.

Always ground the motor-side grounding terminal.

Improper equipment grounding could cause death or serious injury from contacting the motor case.

Do not immediately restart the drive or operate any peripheral devices after blowing a fuse or tripping an Earth Leakage Circuit Breaker (ELCB). Wait for at least the time specified on the warning label and check the wiring and peripheral device ratings to identify the cause when all indicators are OFF. Contact Yaskawa before restarting the drive or the peripheral devices if the cause cannot be identified.

Failure to comply could cause death or serious injury and damage to the drive.

Only authorized persons qualified in electrical work should perform installation, wiring, maintenance, inspections, parts replacement, and repairs.

Failure to comply may cause electrical shock.

Do not perform work on the drive while wearing loose clothing or jewelry. Before servicing, secure loose clothing and remove all metal objects such as watches or rings.

Failure to comply could cause death or serious injury.

Do not remove covers or touch circuit boards while the power is on.

Failure to comply could cause death or serious injury.

Fire Hazard

Tighten all terminal screws to the specified tightening torque.

Loose or overtightened connections could cause erroneous operation and damage to the terminal block or start a fire and cause death or serious injury.

Do not use the main circuit power supply (Overcurrent Category III) at improper voltages. Before applying power, make sure the drive rated voltage and the power supply voltage match.

Using the main circuit power supply at improper voltages may result in batteries bursting and igniting, which could cause fire and injury.

Do not place flammable or combustible materials on top of the drive and do not mount the drive to flammable or combustible materials. Attach the drive to metal or other noncombustible material.

Failure to comply could cause death or serious injury.

⚠ WARNING**Crush Hazard**

Do not perform work on the drive without eye protection. Wear eye protection before beginning work on the drive.

Failure to comply could result in serious injury.

Use a dedicated lifter when transporting the drive by a lifter.

Failure to comply could cause death or serious injury from falling equipment.

NOTICE

Observe proper electrostatic discharge (ESD) procedures when handling the drive and circuit boards.

Failure to comply could cause ESD damage to the drive circuitry.

Never connect or disconnect the motor from the drive while the drive is outputting voltage.

Improper equipment sequencing could damage the drive.

Do not use unshielded wire for control wiring. Use shielded, twisted-pair wires and ground the shield to the ground terminal of the drive.

Failure to comply could cause electrical interference resulting in poor system performance.

Do not modify the drive circuitry.

Failure to comply could cause damage to the drive and will void warranty. Yaskawa is not responsible for any modification of the product made by the user.

Confirm that all connections are correct after installing the drive and connecting peripheral devices.

Failure to comply could damage the drive.

6.2 Types of Faults, Minor Faults, Alarms, and Errors

Check for a code or message displayed on the keypad if the drive or motor fails to operate.



If problems occur that are not covered in this manual, contact the nearest Yaskawa representative with the following information:

- Drive model
- Software version
- Date of purchase
- Description of the problem (such as failure conditions)

The following table contains descriptions of the various types of faults, minor faults, alarms, and errors that may occur while operating the drive.

If the drive is damaged, contact Yaskawa Electric Engineering Corporation. The contact information appears on the back cover of the manual.

Table 6.1 Types of Faults, Minor Faults, Alarms, and Errors

Type	Drive Response
Fault	<p>The following state results when a fault is detected. The drive will remain inoperable until the fault is cleared using Fault Reset and the drive returns to its normal state.</p> <ul style="list-style-type: none"> • When the drive detects an alarm, the alarm message is displayed on the keypad and ALM/ERR of the LED Status Ring begin flashing.  • The fault interrupts drive output and the motor coasts to a stop. Some faults allow the user to select a stopping method with parameters when the fault occurs. • Fault relay output MA-MC will turn ON, and MB-MC will turn OFF.
Minor Faults/Alarms	<p>The following state results when a minor fault or alarm is detected. It is not necessary to perform Fault Reset.</p> <ul style="list-style-type: none"> • When the drive detects a fault, the fault message is displayed on the keypad and ALM/ERR of the LED Status Ring light continuously.  • Normally the drive continues running the motor. Some minor faults allow the user to select a stopping method with parameters when the minor fault occurs. • When the drive detects a minor fault, $H2-xx = 10$ [MFDO Function Select = Minor Fault] will be ON. Terminals for which $H2-xx$ has not been set will not output a signal even if the drive detects a minor fault. • A minor fault signal will not be output even if the drive detects an alarm.
Operation Error	<p>An error occurs when parameter settings conflict or a parameter combination is incorrect. The drive will not operate the motor until the parameters are set properly.</p> <p>The following state results when an operation error is detected. Investigate the parameters that caused the error, and correct the settings.</p> <ul style="list-style-type: none"> • The keypad displays a code indicating the specific error. • Multi-function outputs do not output an alarm signal.
Auto-Tuning Errors	<p>An error occurs while performing Auto-Tuning.</p> <p>The following state results when a tuning error is detected. Remove the cause of the error and perform Auto-Tuning again.</p> <ul style="list-style-type: none"> • The keypad displays a code indicating the specific error. • Multi-function outputs do not output an alarm signal. • The motor coasts to stop.
Copy Function Error	<p>An error occurs when using the keypad for a backup, restore, or verify operation.</p> <p>The following state results when an error is detected.</p> <ul style="list-style-type: none"> • The keypad displays a code indicating the specific error. • Multi-function outputs do not output an alarm signal. <p>Pressing any key on the keypad will clear the error. Remove the cause of the error and try the backup, restore, or verify operation again.</p>

6.3 List of Fault, Minor Fault, Alarm, and Error Codes

The following table gives an overview of possible fault, minor fault, alarm, and error codes.

All of the display codes are listed in alphabetical order. Search the table for the code displayed on the keypad, and identify the causes and possible solutions shown for it.

Note:

The number in parentheses beside the code in the table indicates the fault code (hex number) that was read in during MEMOBUS/Modbus communications.

Example: AEr (0032)

Table 6.2 List of Fault, Minor Fault, Alarm, and Error Codes

Display (Hex.)	Name	ALM LED	Type	Ref.
AEr (0032)	Station Address Setting Error	Flashing	Minor Fault	296
bAT (0085)	Voltage of keypad's battery deficient	Flashing	Minor Fault	296
bb (0008)	Baseblock	Flashing	Alarm	296
boL (0045)	BrakingTransistor Overload Fault	Flashing	Minor Fault	296
boL (004F)	BrakingTransistor Overload Fault	Lit	Fault	273
bUS (0015)	Option Communication Error	Flashing	Minor Fault	296
bUS (0022)	Option Communication Error	Lit	Fault	273
CALL (001D)	Serial Comm Transmission Error	Flashing	Minor Fault	297
CE (0014)	MEMOBUS/Modbus Communication Err	Flashing	Minor Fault	297
CE (0021)	MEMOBUS/Modbus Communication Err	Lit	Fault	273
CF (0025)	Control Fault	Lit	Fault	274
CoF (0046)	Current Offset Fault	Lit	Fault	274
CPEr	Control Mode Mismatch	-	Copy Function Error	320
CPF00, CPF01 CPF02, CPF03 (0083, 0084) CPF07, CPF08 (0088, 0089) CPF11 to CPF14 (008C to 008F) CPF16 to CPF24 (0091 to 0099) CPF26 to CPF38 (009B to 00A7) CPF40 to CPF45 (00A9 to 00AE)	Control Circuit Error	Lit	Fault	275
CPF06 (0087)	Control Circuit Error	Lit	Fault	275
CPF25 (009A)	Terminal Board not Connected	Lit	Fault	275
CPyE	Error Writing Data	-	Copy Function Error	320
CrST	Cannot Reset	Flashing	Minor Fault	298
CSEr	EEPROM Write Error	-	Copy Function Error	320
CyC (0033)	MECHATROLINK CommCycleSettingErr	Flashing	Minor Fault	298
dEv (0011)	Speed Deviation	Flashing	Minor Fault	298
dEv (0019)	Speed Deviation	Lit	Fault	275
dFPS	Drive Model Mismatch	-	Copy Function Error	320
dnE (002A)	Drive Disabled	Flashing	Minor Fault	298
dv1 (0032)	Z Pulse Fault	Lit	Fault	276
dv2 (0033)	Z Pulse Noise Fault Detection	Lit	Fault	276
dv3 (0034)	Inversion Detection	Lit	Fault	276

6.3 List of Fault, Minor Fault, Alarm, and Error Codes

Display (Hex.)	Name	ALM LED	Type	Ref.
dv4 (0035)	Inversion Prevention Detection	Lit	Fault	276
dv7 (005B)	Polarity Judge Timeout	Lit	Fault	277
dWA2 (004A)	DriveWorksEZ Fault 2	Flashing	Minor Fault	298
dWA3 (004B)	DriveWorksEZ Fault 3	Flashing	Minor Fault	298
dWAL (0049)	DriveWorksEZ Fault	Flashing	Minor Fault	298
dWF1 (004A)	EEPROM Memory DWEZ Data Error	Lit	Fault	277
dWF2 (004B)	DriveWorksEZ Fault 2	Lit	Fault	277
dWF3 (004C)	DriveWorksEZ Fault 3	Lit	Fault	277
dWFL (0049)	DriveWorksEZ Fault	Lit	Fault	277
E5 (0031)	MECHATROLINK Watchdog Timer Err	Flashing	Minor Fault	299
E5 (0039)	MECHATROLINK Watchdog Timer Err	Lit	Fault	278
EF (0007)	FWD/REV Run Command Input Error	Flashing	Minor Fault	299
EF0 (001A)	Option Card External Fault	Flashing	Minor Fault	299
EF0 (0027)	Option Card External Fault	Lit	Fault	278
EF1 (0042)	External Fault (terminal S1)	Lit	Fault	278
EF1 (0039)	External Fault (terminal S1)	Flashing	Minor Fault	299
EF2 (003A)	External Fault (terminal S2)	Flashing	Minor Fault	299
EF2 (0043)	External Fault (terminal S2)	Lit	Fault	278
EF3 (0009)	External Fault (terminal S3)	Flashing	Minor Fault	300
EF3 (0011)	External Fault (terminal S3)	Lit	Fault	278
EF4 (000A)	External Fault (terminal S4)	Flashing	Minor Fault	300
EF4 (0012)	External Fault (terminal S4)	Lit	Fault	279
EF5 (000B)	External Fault (terminal S5)	Flashing	Minor Fault	300
EF5 (0013)	External Fault (terminal S5)	Lit	Fault	279
EF6 (000C)	External Fault (terminal S6)	Flashing	Minor Fault	300
EF6 (0014)	External Fault (terminal S6)	Lit	Fault	279
EF7 (000D)	External Fault (terminal S7)	Flashing	Minor Fault	300
EF7 (0015)	External Fault (terminal S7)	Lit	Fault	279
EF8 (000E)	External Fault (terminal S8)	Flashing	Minor Fault	301
EF8 (0016)	External Fault (terminal S8)	Lit	Fault	279
End1	Excessive V/f Setting	Flashing	Auto-Tuning Errors	315
End2	Iron Core Saturation Coefficient	Flashing	Auto-Tuning Errors	315
End3	Rated Current Setting Alarm	Flashing	Auto-Tuning Errors	315
End4	Adjusted Slip Calculation Error	Flashing	Auto-Tuning Errors	315
End5	Resistance Tuning Error	Flashing	Auto-Tuning Errors	315
End6	Leakage Inductance Alarm	Flashing	Auto-Tuning Errors	315
End7	No-Load Current Alarm	Flashing	Auto-Tuning Errors	316
EP24v (0081)	External Power 24V Supply	Flashing	Alarm	301
Er-01	Motor Data Error	Flashing	Auto-Tuning Errors	316
Er-02	Minor Fault	Flashing	Auto-Tuning Errors	316
Er-03	STOP Button Input	Flashing	Auto-Tuning Errors	316
Er-04	Line-to-Line Resistance Error	Flashing	Auto-Tuning Errors	316
Er-05	No-Load Current Error	Flashing	Auto-Tuning Errors	317

Display (Hex.)	Name	ALM LED	Type	Ref.
Er-08	Rated Slip Error	Flashing	Auto-Tuning Errors	317
Er-09	Acceleration Error	Flashing	Auto-Tuning Errors	317
Er-10	Motor Direction Error	Flashing	Auto-Tuning Errors	317
Er-11	Motor Speed Error	Flashing	Auto-Tuning Errors	317
Er-12	Current Detection Error	Flashing	Auto-Tuning Errors	318
Er-13	Leakage Inductance Error	Flashing	Auto-Tuning Errors	318
Er-14	Motor Speed Error 2	Flashing	Auto-Tuning Errors	318
Er-15	Torque Saturation Error	Flashing	Auto-Tuning Errors	318
Er-16	Inertia ID Error	Flashing	Auto-Tuning Errors	318
Er-17	Reverse Prohibited Error	Flashing	Auto-Tuning Errors	318
Er-18	Induction Voltage Error	Flashing	Auto-Tuning Errors	318
Er-19	PM Inductance Error	Flashing	Auto-Tuning Errors	318
Er-20	Stator Resistance Error	Flashing	Auto-Tuning Errors	319
Er-21	Z Pulse Correction Error	Flashing	Auto-Tuning Errors	319
Er-25	HighFreq Inject Param Tuning Err	Flashing	Auto-Tuning Errors	319
Err (001F)	EEPROM Write Error	Lit	Fault	280
FAn (000F)	Internal Fan Fault	Flashing	Minor Fault	301
FAn (0017)	Internal Fan Fault	Lit	Fault	280
FAn1 (0413)	Drive cooling fan failure	Lit	Fault	280
FbH (0028)	Excessive PID Feedback	Flashing	Minor Fault	301
FbH (0041)	Excessive PID Feedback	Lit	Fault	280
FbL (0027)	PID Feedback Loss	Flashing	Minor Fault	301
FbL (0028)	PID Feedback Loss	Lit	Fault	280
GF (0006)	Ground Fault	Lit	Fault	281
HCA (0034)	Current Alarm	Flashing	Minor Fault	302
iFEr	MEMOBUS/Modbus Communication Err	-	Copy Function Error	320
L24v (0021)	External Power 24V Supply	Flashing	Alarm	302
LF (001C)	Output Phase Loss	Lit	Fault	281
LF2 (0036)	Output Current Imbalance	Lit	Fault	281
LoG (0082)	Log Communication Fault	Flashing	Minor Fault	302
LSo (0051)	LSo Fault	Lit	Fault	282
LT-1 (0035)	Cooling Fan Maintenance Time	Flashing	Alarm	303
LT-2 (0036)	Capacitor Maintenance Time	Flashing	Alarm	303
LT-3 (0043)	SoftChargeBypassRelay MainteTime	Flashing	Alarm	303
LT-4 (0044)	IGBT Maintenance Time (50%)	Flashing	Alarm	303
ndAT	Model,VolClass,Capacity Mismatch	-	Copy Function Error	320
nSE (0052)	Node Setup Error	Lit	Fault	282
oC (0007)	Overcurrent	Lit	Fault	282
oFA00 (0101)	Not supported	Lit	Fault	284
oFA01 (0102)	Connection Error	Lit	Fault	284
oFA02 (0103)	DuplicateOptions	Lit	Fault	284
oFA03 to oFA06 (0104 to 0107)	Option card error occurred at Option Port CN5-A	Lit	Fault	284

6.3 List of Fault, Minor Fault, Alarm, and Error Codes

Display (Hex.)	Name	ALM LED	Type	Ref.
oFA10, oFA11 (0111, 0112)	Option card error occurred at Option Port CN5-A	Lit	Fault	284
oFA12 to oFA17 (0113 to 0118)	Option card error occurred at Option Port CN5-A	Lit	Fault	284
oFA30 to oFA43 (0131 to 013E)	Communication Option Card Connection Error (CN5-A)	Lit	Fault	284
oFb00 (0201)	Not supported	Lit	Fault	285
oFb01 (0202)	Connection Error	Lit	Fault	285
oFb02 (0203)	DuplicateOptions	Lit	Fault	285
oFb03 to oFb11 (0204 to 0212)	Option card error occurred at Option Port CN5-B	Lit	Fault	285
oFb12 to oFb17 (0213 to 0218)	Option card error occurred at Option Port CN5-B	Lit	Fault	285
oFC00 (0301)	Not supported	Lit	Fault	285
oFC01 (0302)	Connection Error	Lit	Fault	285
oFC02 (0303)	DuplicateOptions	Lit	Fault	285
oFC03 to oFC11 (0304 to 0312)	Option card error occurred at Option Port CN5-C	Lit	Fault	286
oFC12 to oFC17 (0313 to 0318)	Option card error occurred at Option Port CN5-C	Lit	Fault	286
oFC50 to oFC55 (0351 to 0356)	Option card error occurred at Option Port CN5-C	Lit	Fault	286
oH (0003)	Overheat 1 (Heatsink Overheat)	Flashing	Minor Fault	303
oH (0009)	Overheat 1 (Heatsink Overheat)	Lit	Fault	286
oH1 (000A)	Overheat 1 (Heatsink Overheat)	Lit	Fault	286
oH2 (0004)	Drive Overheat Warning	Flashing	Minor Fault	303
oH3 (001D)	Motor Overheat Alarm (PTC Input)	Lit	Fault	286
oH3 (0022)	Motor Overheat	Flashing	Minor Fault	304
oH4 (0020)	Motor Overheat Fault (PTC Input)	Lit	Fault	287
oL1 (000B)	Motor Overload	Lit	Fault	287
oL2 (000C)	Drive Overloaded	Lit	Fault	288
oL3 (0005)	Overtorque 1	Flashing	Minor Fault	304
oL3 (000D)	Overtorque Detection 1	Lit	Fault	289
oL4 (0006)	Overtorque 2	Flashing	Minor Fault	304
oL4 (000E)	Overtorque Detection 2	Lit	Fault	289
oL5 (003D)	Mechanical Weakening Detection 1	Flashing	Minor Fault	304
oL5 (0044)	Mechanical Weakening Detection 1	Lit	Fault	289
oL7 (002B)	High Slip Braking oL	Lit	Fault	290
oPE01	Thermistor Disconnect	Flashing	Parameter Setting Errors	309
oPE02	Parameter Range Setting Error	Flashing	Parameter Setting Errors	309
oPE03	Multi-Function Input Setting Err	Flashing	Parameter Setting Errors	309
oPE05	Run Cmd/Freq Ref Source Sel Err	Flashing	Parameter Setting Errors	311
oPE06	Control Method Selection Error	Flashing	Parameter Setting Errors	311
oPE07	MF Analog Input Selection Error	Flashing	Parameter Setting Errors	312
oPE08	Parameter Selection Error	Flashing	Parameter Setting Errors	312
oPE09	PID Control Selection Fault	Flashing	Parameter Setting Errors	313
oPE10	V/f Data Setting Error	Flashing	Parameter Setting Errors	313

Display (Hex.)	Name	ALM LED	Type	Ref.
oPE11	Carrier Frequency Setting Error	Flashing	Parameter Setting Errors	313
oPE13	Pulse Monitor Selection Error	Flashing	Parameter Setting Errors	314
oPE15	Torque Control Setting Error	Flashing	Parameter Setting Errors	314
oPE16	Energy Saving Constants Error	Flashing	Parameter Setting Errors	314
oPE18	Online Tuning Param Setting Err	Flashing	Parameter Setting Errors	314
oPE20	PG-F3 Setting Error	Flashing	Parameter Setting Errors	314
oPr (001E)	Keypad connection fault	Lit	Fault	290
oS (0010)	Overspeed	Flashing	Minor Fault	305
oS (0018)	Overspeed	Lit	Fault	290
ov (0002)	Overvoltage	Flashing	Minor Fault	305
ov (0008)	Overvoltage	Lit	Fault	290
PASS	PASS	Flashing	Not an alarm.	305
PF (001B)	Input Phase Loss	Lit	Fault	291
PF (0047)	Input Phase Loss	Flashing	Minor Fault	305
PGo (0012)	PG Disconnect	Flashing	Minor Fault	306
PGo (001A)	PG Disconnect	Lit	Fault	292
PGoH (002B)	PG Hardware Fault	Flashing	Minor Fault	306
PGoH (0038)	PG Hardware Fault	Lit	Fault	292
rdEr	Error Reading Data	-	Copy Function Error	321
rF (004E)	Braking Resistor Fault	Lit	Fault	292
rH (0010)	Braking Resistor Overheat	Lit	Fault	292
rr (000F)	Dynamic Braking Transistor	Lit	Fault	293
rUn (001B)	Motor Switch during Run	Flashing	Minor Fault	306
SC (0005)	Out Short Circuit or IGBT Fault	Lit	Fault	293
SCF (040F)	Safety Circuit Fault	Lit	Fault	293
SE (0020)	MEMOBUS/Modbus Comm TestMode Err	Flashing	Minor Fault	306
SEr (003B)	Too Many Speed Search Restarts	Lit	Fault	293
STo (003C)	Safe Torque OFF	Flashing	Minor Fault	306
SToF (003B)	Safe Torque OFF	Flashing	Minor Fault	307
STPo (0037)	Pull-Out Detection	Lit	Fault	294
SvE (0026)	Zero Servo Fault	Lit	Fault	294
TrPC (0042)	IGBT Maintenance Time (90%)	Flashing	Minor Fault	307
UL3 (001E)	Undertorque Detection 1	Flashing	Minor Fault	307
UL3 (0029)	Undertorque Detection 1	Lit	Fault	294
UL4 (001F)	Undertorque Detection 2	Flashing	Minor Fault	307
UL4 (002A)	Undertorque Detection 2	Lit	Fault	294
UL5 (003E)	Mechanical Weakening Detection 2	Flashing	Minor Fault	307
UL5 (0045)	Mechanical Weakening Detection 2	Lit	Fault	294
Uv (0001)	DC Bus Undervoltage	Flashing	Minor Fault	307
Uv1 (0002)	DC Bus Undervoltage	Lit	Fault	295
Uv2 (0003)	Ctrl Power Supply Voltage Fault	Lit	Fault	295
Uv3 (0004)	SoftCharge Bypass Circuit Fault	Lit	Fault	295

6.3 List of Fault, Minor Fault, Alarm, and Error Codes

Display (Hex.)	Name	ALM LED	Type	Ref.
vAEr	Voltage Class, Capacity Mismatch	-	Copy Function Error	321
vFyE	VERIFY ERROR	-	Copy Function Error	321

6.4 Fault

This section explains the causes and possible solutions when a fault occurs. The drive will remain inoperable until the fault is cleared using the Fault Reset operation. Remove the cause of the fault referring to the following table.

Code	Name	Cause	Possible Solution
boL	BrakingTransistor Overload Fault	The duty cycle of the braking transistor is high (the regeneration power or repetition frequency is high).	<ul style="list-style-type: none"> Install a braking unit (CDBR series). Install a regenerative converter. Lengthen the deceleration time.
		The braking transistor protective function is enabled when a regenerative converter is being used.	Set $L8-55 = 0$ [<i>InternalBrakingTransistorProtect = Disable</i>].
		The braking transistor in the drive is broken.	Replace the entire drive.

Note:

Perform Fault Reset to clear the fault.

Code	Name	Cause	Possible Solution
bUS	Option Communication Error	No signal was received from the controller.	Correct any wiring errors.
		The communications cable wiring is incorrect.	
		There is a short circuit or disconnection in the communications cable.	<ul style="list-style-type: none"> Repair disconnected cables and short circuits for proper wiring. Replace a faulty communications cable with a normal one.
		Communication data error occurred due to noise.	<ul style="list-style-type: none"> Check the control circuit lines, main circuit lines, and ground wiring, and minimize the effects of noise. Check whether an electromagnetic contactor is the noise source, and use Surge Protective Device if necessary. Use only recommended cables or other shielded line. Ground the shield on the controller side or the drive input power side. Separate all communication wiring from drive power lines, and install a noise filter to the input side of the power supply for communication. Minimize the effects of controller noise.
		The option card is not properly connected to the drive.	Mount the option card to the drive correctly.
		The option card is damaged.	Replace the option card if the error continues to occur even though the wiring is correct.

Note:

- Detected if the Run command or frequency reference is assigned to the option card.
- Perform Fault Reset to clear the fault.
- If detected, the drive will operate the motor according to the stop method set in *F6-01 [Communication Error Selection]*.

Code	Name	Cause	Possible Solution
CE	MEMOBUS/Modbus Communication Err	The communications cable wiring is incorrect.	Correct any wiring errors.
		There is a short circuit or disconnection in the communications cable.	

6.4 Fault

Code	Name	Cause	Possible Solution
		Communication data error occurred due to noise.	<ul style="list-style-type: none"> • Check the control circuit lines, main circuit lines, and ground wiring, and minimize the effects of noise. • Check whether an electromagnetic contactor is the noise source, and use Surge Protective Device if necessary. • Use only recommended cables or other shielded line. Ground the shield on the controller side or the drive input power side. • Separate all communication wiring from drive power lines, and install a noise filter to the input side of the power supply for communication. • Minimize the effects of controller noise.
<p>Note:</p> <ul style="list-style-type: none"> • Detected if control data was not received for the CE detection time set to <i>H5-09 [CE Detection Time]</i>. • Perform Fault Reset to clear the fault. • If detected, the drive will operate the motor according to the stop method set in <i>H5-04 [Stopping Method after Com Error]</i>. 			
Code	Name	Cause	Possible Solution
CF	Control Fault	Motor parameters are set improperly.	Set the motor parameters properly and perform Auto-Tuning again.
		The torque limit is too low.	Adjust <i>L7-01 to L7-04 [Torque Limit]</i> .
		The load inertia is too big.	<ul style="list-style-type: none"> • Adjust <i>C1-02, C1-04, C1-06, and C1-08 [Deceleration Time]</i>. • Set the frequency reference to the minimum output frequency, and interrupt the Run command when the drive finishes decelerating.
		Ramp to stop is being applied on a machine that cannot perform ramp to stop or on a machine for which deceleration is not necessary.	Set <i>b1-03 [Stopping Method Selection]</i> appropriately.
		The motor and drive are not connected correctly.	Correct any wiring errors.
		Line-to-line resistance tuning has not been performed.	Perform Stationary Auto-Tuning for Line-to-Line Resistance.
		The Run command was input while the motor was coasting.	<ul style="list-style-type: none"> • Reevaluate the sequence to ensure that the Run command is input after the motor has come to a complete stop. • Set <i>b3-01 = 1 [Speed Search Selection at Start = Enabled]</i>.
<p>Note:</p> <ul style="list-style-type: none"> • Detected if the torque reference exceeds the torque limit for three seconds or longer while ramping to stop. • Perform Fault Reset to clear the fault. 			
Code	Name	Cause	Possible Solution
CoF	Current Offset Fault	Drive starts operation while the induced voltage remains in the motor (during coasting to a stop or after rapid deceleration).	<ul style="list-style-type: none"> • Specify a sequence in which operation is not restarted when induced voltage remains in the motor. • Set <i>b3-01 = 1 [Speed Search Selection at Start = Enabled]</i>. • Use <i>External Speed Search commands 1 or 2 [H1-xx = 61, 62]</i> to perform a speed search via one of the external terminals. <p>Note: When controlling the PM motor, External Speed Search commands 1 and 2 have the same behavior.</p>
		A drive hardware problem occurred.	Replace the entire drive.
<p>Note:</p> <ul style="list-style-type: none"> • Detected if the current offset value exceeds the allowable setting range while the drive automatically adjusts the current offset. • Perform Fault Reset to clear the fault. 			

Code	Name	Cause	Possible Solution
CPF00 to CPF03, CPF07 to CPF08, CPF11 to CPF14, CPF16 to CPF24, CPF26 to CPF38, CPF40 to CPF45	Control Circuit Error	A drive hardware problem occurred.	<ul style="list-style-type: none"> Restart the drive and check if the fault still remains. Replace either the control board or the entire drive if the fault continues. For instructions on replacing the control board, contact Yaskawa or your nearest sales representative.
		For CPF00, the drive was energized with the miniUSB cable connected.	For CPF00, disconnect the miniUSB cable and energize the drive.
Note: <ul style="list-style-type: none"> Perform Fault Reset to clear the fault. Fault tracing cannot be executed. 			
Code	Name	Cause	Possible Solution
CPF06	EEPROM Memory Data Error	The drive power supply was switched off while the parameter Write command was entered from a communications option card.	Set <i>A1-03 = 2220, 3330</i> [<i>Initialize Parameters = 2-Wire initialization, 3-Wire initialization</i>] and initialize the drive.
		An EEPROM peripheral circuit error occurred.	<ul style="list-style-type: none"> Re-energize the drive and check if the fault still remains. Replace either the control board or the entire drive if the fault continues. For instructions on replacing the control board, contact Yaskawa or your nearest sales representative.
Note: <ul style="list-style-type: none"> Detected if there is an error in the data written to the EEPROM of the drive. Perform Fault Reset to clear the fault. Fault tracing cannot be executed. 			
Code	Name	Cause	Possible Solution
CPF25	Terminal Board not Connected	The terminal board is not securely inserted into the connector.	<ol style="list-style-type: none"> De-energize the drive. Ensure that the terminal board and drive are properly connected. Reapply power to the drive.
Note: Perform Fault Reset to clear the fault.			
Code	Name	Cause	Possible Solution
dEv	Speed Deviation	The load is too heavy.	Reduce the load.
		Acceleration and deceleration times are set too short.	Increase the value set in <i>C1-01 to C1-08</i> [<i>Acceleration/Deceleration Time</i>].
		The dEv detection level settings are inappropriate.	Adjust <i>F1-10</i> [<i>Speed Deviation Detection Level</i>] and <i>F1-11</i> [<i>Speed Deviation Detect DelayTime</i>].
		The load is locked up.	Check the machine.
		The holding brake is being applied to the motor.	Release the holding brake.
Note: <ul style="list-style-type: none"> Detected if the deviation between the detected speed and the speed reference is greater than the setting in <i>F1-10</i> [<i>Speed Deviation Detection Level</i>] for longer than <i>F1-11</i> [<i>Speed Deviation Detect DelayTime</i>]. Perform Fault Reset to clear the fault. If detected, the drive will operate the motor according to the stop method set in <i>F1-04</i> [<i>Operation Selection at Deviation</i>]. 			

6.4 Fault

Code	Name	Cause	Possible Solution
dv1	Z Pulse Fault	The PG option card or the encoder on the motor side is damaged.	<ol style="list-style-type: none"> 1. Check for any wiring errors or disconnected wires in the encoder cable, and fix any problems. Properly ground the shielded wire of the encoder cable. 2. Re-energize the drive and check if the fault still remains. 3. If the fault persists, replace the PG option card or the encoder.
		The encoder cable is improperly wired or disconnected.	
Note: <ul style="list-style-type: none"> • Detected if a Z pulse is not detected during a single rotation of the motor. • Perform Fault Reset to clear the fault. 			
Code	Name	Cause	Possible Solution
dv2	Z Pulse Noise Fault Detection	Noise interference along the encoder cable	Separate the encoder cable from the source of the noise such as the drive output line.
		The encoder cable is improperly wired or disconnected.	Check for any wiring errors or disconnected wires in the encoder cable, and fix any problems. Properly ground the shielded wire of the encoder cable.
		The PG option card or the encoder on the motor side is damaged.	Replace the PG option card or the encoder if the problem continues even after fixing the wiring and re-energizing the drive.
Note: <ul style="list-style-type: none"> • Detected if Z pulses are detected two or more times during a single rotation of the motor. • Perform Fault Reset to clear the fault. 			
Code	Name	Cause	Possible Solution
dv3	Inversion Detection	Parameter <i>E5-11 [Encoder Z Pulse Offset]</i> is not set properly.	Properly set the value for $\Delta\theta$ to <i>E5-11</i> as specified on the motor nameplate.
		The encoder was replaced or the direction of motor rotation changed.	Perform Z Pulse Offset Tuning.
		An external force on the load side caused the motor to move.	<ul style="list-style-type: none"> • Make sure the motor is rotating in the proper direction. • Identify and fix any problems on the load side causing the motor to rotate from the load side.
		Noise interference along the encoder cable	Properly ground the shielded wire of the encoder cable.
		The encoder cable is improperly wired or disconnected.	Check for any wiring errors or disconnected wires in the encoder cable, and fix any problems.
		The setting for <i>F1-05 [PG 1 Rotation Selection]</i> is the opposite of the direction of motor rotation.	Properly connect the motor wiring for each phase (U, V, W).
		The PG option card or the encoder on the motor side is damaged.	Replace the PG option card or the encoder if the problem continues even after all counter-measures have been taken and the drive re-energized.
Note: <ul style="list-style-type: none"> • Detected if the torque reference and acceleration are in opposite directions and the speed reference and actual motor speed differ by more than 30% for the number of times set to <i>F1-18 [Deviation 3 Detection Selection]</i>. • Perform Fault Reset to clear the fault. 			
Code	Name	Cause	Possible Solution
dv4	Inversion Prevention Detection	An external force on the load side caused the motor to move.	<ul style="list-style-type: none"> • Make sure the motor is rotating in the proper direction. • Identify and fix any problems on the load side causing the motor to rotate from the load side. • For applications in which the motor is rotated from the load side in the opposite direction of the speed reference, disable detection of this fault. This fault will not be detected if <i>F1-19 = 0 [Deviation 4 Detection Selection = Disabled]</i>.
		Parameter <i>E5-11 [Encoder Z Pulse Offset]</i> is not set properly.	Properly set the value for $\Delta\theta$ to <i>E5-11</i> as specified on the motor nameplate.
		The encoder was replaced or the direction of motor rotation changed.	Perform Z Pulse Offset Tuning.

Code	Name	Cause	Possible Solution
		Noise interference along the encoder cable	Properly ground the shielded wire of the encoder cable.
		The encoder cable is improperly wired or disconnected.	Check for any wiring errors or disconnected wires in the encoder cable, and fix any problems.
		The PG option card or the encoder on the motor side is damaged.	Replace the PG option card or the encoder if the problem continues even after all counter-measures have been taken and the drive re-energized.
Note: <ul style="list-style-type: none"> • Detected if it is detected that pulses in the opposite direction of the speed reference exceeds the value set in <i>F1-19 [Deviation 4 Detection Selection]</i>. • Perform Fault Reset to clear the fault. 			
Code	Name	Cause	Possible Solution
dv7	Polarity Judge Timeout	Disconnection in the motor coil winding.	Measure the motor line-to-line resistance and replace the motor if a coil is disconnected.
		The output terminal screws of the drive are loose.	Properly tighten the terminals according to the specified tightening torque.
Note: <ul style="list-style-type: none"> • Detected if polarity cannot be detected within a prescribed amount of time. • Perform Fault Reset to clear the fault. 			
Code	Name	Cause	Possible Solution
dWF1	EEPROM Memory DWEZ Data Error	EEPROM peripheral circuit error	<ul style="list-style-type: none"> • Restart the drive and check if the fault still remains. • Replace either the control board or the entire drive if the fault continues. For instructions on replacing the control board, contact Yaskawa or your nearest sales representative.
		Problem with EEPROM data	Reinitialize the drive by setting <i>A1-03 = 2220, 3330 [Initialize Parameters = 2-Wire initialization, 3-Wire initialization]</i> , and download the DriveWorksEZ project to the drive again.
Note: <ul style="list-style-type: none"> • Detected if there is an error in the DriveWorksEZ program saved to EEPROM. • Perform Fault Reset to clear the fault. 			
Code	Name	Cause	Possible Solution
dWF2	DriveWorksEZ Fault 2	The DriveWorksEZ program output a fault.	Check the DriveWorksEZ program and remove the cause of the fault. This is not a drive fault.
Note: Perform Fault Reset to clear the fault.			
Code	Name	Cause	Possible Solution
dWF3	DriveWorksEZ Fault 3	The DriveWorksEZ program output a fault.	Check the DriveWorksEZ program and remove the cause of the fault. This is not a drive fault.
Note: Perform Fault Reset to clear the fault.			
Code	Name	Cause	Possible Solution
dWFL	DriveWorksEZ Fault	The DriveWorksEZ program output a fault.	Check the DriveWorksEZ program and remove the cause of the fault. This is not a drive fault.
Note: Perform Fault Reset to clear the fault.			

6.4 Fault

Code	Name	Cause	Possible Solution
E5	MECHATROLINK Watchdog Timer Err	A watchdog circuit exception was detected while receiving data from the controller.	<p>Check the MECHATROLINK cable connection. If this error occurs frequently, check the wiring and minimize the effects of noise in accordance with the following manuals:</p> <ul style="list-style-type: none"> MECHATROLINK-II Installation Guide (MECHATROLINK Members Association, manual number MMATDEP011) MECHATROLINK-III Installation Guide (MECHATROLINK Members Association, manual number MMATDEP018)
<p>Note:</p> <ul style="list-style-type: none"> Perform Fault Reset to clear the fault. If detected, the drive will operate the motor according to the stop method set in <i>F6-25 [MECHATROLINK Watchdog Error Sel]</i>. 			
Code	Name	Cause	Possible Solution
EF0	Option Card External Fault	The communication option card received an external fault from the controller.	<ol style="list-style-type: none"> Identify the device that triggered the external faults and remove the cause. Clear the external fault input from the controller.
		Programming error occurred on the controller side.	Check the operation of the controller program.
<p>Note:</p> <ul style="list-style-type: none"> Detected if the alarm function on the external device side is being operated. Perform Fault Reset to clear the fault. If detected, the drive will operate the motor according to the stop method set in <i>F6-03 [Comm External Fault (EF0) Select]</i>. 			
Code	Name	Cause	Possible Solution
EF1	External Fault (terminal S1)	The multi-function digital input terminal S1 triggered an external fault via an external device.	<ol style="list-style-type: none"> Identify the device that triggered the external faults and remove the cause. Clear the external fault input in the multi-function digital input.
		The wiring is incorrect.	Connect the signal line to multi-function digital input terminal S1 properly.
		<i>External fault [H1-01 = 20 to 2B] is assigned to MFDI terminal S1 that is not in use.</i>	Set the multi-function digital input properly.
<p>Note:</p> <p>Perform Fault Reset to clear the fault.</p>			
Code	Name	Cause	Possible Solution
EF2	External Fault (terminal S2)	The multi-function digital input terminal S2 triggered an external fault via an external device.	<ol style="list-style-type: none"> Identify the device that triggered the external faults and remove the cause. Clear the external fault input in the multi-function digital input.
		The wiring is incorrect.	Connect the signal line to multi-function digital input terminal S2 properly.
		<i>External fault [H1-02 = 20 to 2B] is assigned to MFDI terminal S2 that is not in use.</i>	Set the multi-function digital input properly.
<p>Note:</p> <p>Perform Fault Reset to clear the fault.</p>			
Code	Name	Cause	Possible Solution
EF3	External Fault (terminal S3)	The multi-function digital input terminal S3 triggered an external fault via an external device.	<ol style="list-style-type: none"> Identify the device that triggered the external faults and remove the cause. Clear the external fault input in the multi-function digital input.
		The wiring is incorrect.	Connect the signal line to multi-function digital input terminal S3 properly.
		<i>External fault [H1-03 = 20 to 2B] is assigned to MFDI terminal S3 that is not in use.</i>	Set the multi-function digital input properly.
<p>Note:</p> <p>Perform Fault Reset to clear the fault.</p>			

Code	Name	Cause	Possible Solution
EF4	External Fault (terminal S4)	The multi-function digital input terminal S4 triggered an external fault via an external device.	1. Identify the device that triggered the external faults and remove the cause. 2. Clear the external fault input in the multi-function digital input.
		The wiring is incorrect.	Connect the signal line to multi-function digital input terminal S4 properly.
		<i>External fault [H1-04 = 20 to 2B] is assigned to MFDI terminal S4 that is not in use.</i>	Set the multi-function digital input properly.
Note: Perform Fault Reset to clear the fault.			
Code	Name	Cause	Possible Solution
EF5	External Fault (terminal S5)	The multi-function digital input terminal S5 triggered an external fault via an external device.	1. Identify the device that triggered the external faults and remove the cause. 2. Clear the external fault input in the multi-function digital input.
		The wiring is incorrect.	Connect the signal line to multi-function digital input terminal S5 properly.
		<i>External fault [H1-05 = 20 to 2B] is assigned to MFDI terminal S5 that is not in use.</i>	Set the multi-function digital input properly.
Note: Perform Fault Reset to clear the fault.			
Code	Name	Cause	Possible Solution
EF6	External Fault (terminal S6)	The multi-function digital input terminal S6 triggered an external fault via an external device.	1. Identify the device that triggered the external faults and remove the cause. 2. Clear the external fault input in the multi-function digital input.
		The wiring is incorrect.	Connect the signal line to multi-function digital input terminal S6 properly.
		<i>External fault [H1-06 = 20 to 2B] is assigned to MFDI terminal S6 that is not in use.</i>	Set the multi-function digital input properly.
Note: Perform Fault Reset to clear the fault.			
Code	Name	Cause	Possible Solution
EF7	External Fault (terminal S7)	The multi-function digital input terminal S7 triggered an external fault via an external device.	1. Identify the device that triggered the external faults and remove the cause. 2. Clear the external fault input in the multi-function digital input.
		The wiring is incorrect.	Connect the signal line to multi-function digital input terminal S7 properly.
		<i>External fault [H1-07 = 20 to 2B] is assigned to MFDI terminal S7 that is not in use.</i>	Set the multi-function digital input properly.
Note: Perform Fault Reset to clear the fault.			
Code	Name	Cause	Possible Solution
EF8	External Fault (terminal S8)	The multi-function digital input terminal S8 triggered an external fault via an external device.	1. Identify the device that triggered the external faults and remove the cause. 2. Clear the external fault input in the multi-function digital input.
		The wiring is incorrect.	Connect the signal line to multi-function digital input terminal S8 properly.
		<i>External fault [H1-08 = 20 to 2B] is assigned to MFDI terminal S8 that is not in use.</i>	Set the multi-function digital input properly.
Note: Perform Fault Reset to clear the fault.			

6.4 Fault

Code	Name	Cause	Possible Solution
Err	EEPROM Write Error	An EEPROM hardware problem occurred.	<ul style="list-style-type: none"> Re-energize the drive and check if the fault still remains. Replace either the control board or the entire drive if the fault continues. For instructions on replacing the control board, contact Yaskawa or your nearest sales representative.
		Noise has corrupted data while writing to the EEPROM of the drive.	<ul style="list-style-type: none"> Press . Set the parameters again.
Note: Perform Fault Reset to clear the fault.			
Code	Name	Cause	Possible Solution
FAn	Internal Fan Fault	The circulation fan has malfunctioned.	<ul style="list-style-type: none"> Check for circulation fan operation. Restart the drive and check if the fault still remains. Check U4-03 [Cooling Fan Ope Time] and U4-04 [Cool Fan Maintenance]. If the circulation fan has exceeded its expected performance life or is damaged in any other way, follow the replacement instructions in this manual.
		A fault detected in the power supply of the electromagnetic contactor and the circulation fan.	<ul style="list-style-type: none"> Re-energize the drive and check if the fault still remains. Replace either the control board or the entire drive if the fault continues. For instructions on replacing the control board, contact Yaskawa or your nearest sales representative.
Note: Perform Fault Reset to clear the fault.			
Code	Name	Cause	Possible Solution
FAn1	Drive cooling fan failure	The cooling fan has malfunctioned.	<ul style="list-style-type: none"> Check to see if the cooling fan is operating. Restart the drive and check if the fault still remains. Check U4-03 [Cooling Fan Ope Time] and U4-04 [Cool Fan Maintenance]. If the cooling fan has exceeded its expected performance life or is damaged in any way, replace it according to the instructions in this manual.
Note: Perform Fault Reset to clear the fault.			
Code	Name	Cause	Possible Solution
FbH	Excessive PID Feedback	The <i>FbH</i> detection level has not been set appropriately.	Adjust <i>b5-36</i> and <i>b5-37</i> .
		The PID feedback wiring is faulty.	Correct any PID control wiring errors.
		Feedback sensor has malfunctioned.	Check the state of the sensors on the control device side.
		A fault occurred in the feedback input circuit of the drive.	Replace the board or the entire drive. For instructions on replacing the control board, contact Yaskawa or your nearest sales representative.
Note: <ul style="list-style-type: none"> Detected if PID feedback input has exceeded the level set in <i>b5-36</i> [PID Feedback High Detection Lvl] for longer than <i>b5-37</i> [PID Feedback High Detection Time]. Perform Fault Reset to clear the fault. If detected, the drive will operate the motor according to the stop method set in <i>b5-12</i> [Feedback Loss Detection Select]. 			
Code	Name	Cause	Possible Solution
FbL	PID Feedback Loss	The <i>FbL</i> detection level has not been set appropriately.	Adjust <i>b5-13</i> and <i>b5-14</i> .
		The PID feedback wiring is faulty.	Correct any PID control wiring errors.
		Feedback sensor has malfunctioned.	Check the state of the sensors on the control device side.

Code	Name	Cause	Possible Solution
		A fault occurred in the feedback input circuit of the drive.	Replace the board or the entire drive. For instructions on replacing the control board, contact Yaskawa or your nearest sales representative.
Note: <ul style="list-style-type: none"> • Detected if PID feedback input is lower than the level set in <i>b5-13 [PID Feedback Loss Detection Lvl]</i> for longer than <i>b5-14 [PID Feedback Loss Detection Time]</i>. • Perform Fault Reset to clear the fault. • If detected, the drive will operate the motor according to the stop method set in <i>b5-12 [Feedback Loss Detection Select]</i>. 			
Code	Name	Cause	Possible Solution
GF	Ground Fault	The motor is damaged from overheat or the motor insulation is deteriorated.	Measure the motor insulation resistance, and replace the motor if there is electrical conduction or worn insulation.
		The contact with a damaged motor main circuit cable is creating a short circuit.	<ul style="list-style-type: none"> • Check whether the motor main circuit cable is damaged, and remove any short circuits. • Measure the resistance between the motor main circuit cable and the ground terminal. If there is electrical conduction, replace the cable.
		The leakage current has become large due to the stray capacitance of the cable and the grounding terminal becoming large.	<ul style="list-style-type: none"> • If the wiring length of the cable exceeds 100 m, reduce the carrier frequency. • Reduce the stray capacitance.
		A drive hardware problem occurred.	Replace the board or the entire drive. For instructions on replacing the control board, contact Yaskawa or your nearest sales representative.
Note: <ul style="list-style-type: none"> • Detected if a current short to ground exceeded 50% of rated current on the output side of the drive. • Perform Fault Reset to clear the fault. 			
Code	Name	Cause	Possible Solution
LF	Output Phase Loss	The motor main circuit cable is disconnected.	Correct any disconnected wires in the motor main circuit cable. Correct any wiring errors in the main circuit drive input power.
		Disconnection in the motor coil winding.	Measure the motor line-to-line resistance and replace the motor if a coil is disconnected.
		The output terminal screws of the drive are loose.	Properly tighten the terminals according to the specified tightening torque.
		The rated output current of the motor being used is less than 5% of the drive rated current.	Check the drive capacity or the motor output to be applied.
		A single-phase motor is being used.	This product cannot operate a single-phase motor.
		The output transistor in the drive is damaged.	Replace the control board or the entire drive if the fault still remains even after all counter-measures have been taken. For more information on replacing the control board, contact Yaskawa or your nearest sales representative.
Note: <ul style="list-style-type: none"> • Detected if phase loss occurs on the output side of the drive. • Perform Fault Reset to clear the fault. • Use <i>L8-07 [Output Phase Loss Protect Select]</i> to enable/disable <i>LF</i> detection. 			
Code	Name	Cause	Possible Solution
LF2	Output Current Imbalance	Phase loss occurred in the wiring on the output side of the drive.	Check for any wiring errors or disconnected wires on the output side of the drive, and fix any problems.
		The output terminal screws of the drive are loose.	Properly tighten the terminals according to the specified tightening torque.
		Balance was lost between the three phases of the PM motor impedance.	<ul style="list-style-type: none"> • Measure the line-to-line resistance for each motor phase, ensuring that resistance is even between the three phases, and that all wires are connected properly. • Replace the motor.

6.4 Fault

Code	Name	Cause	Possible Solution
		The drive output circuit is broken.	Replace the control board or the entire drive if the fault still remains even after all counter-measures have been taken. For more information on replacing the control board, contact Yaskawa or your nearest sales representative.
Note: <ul style="list-style-type: none"> • Detected if balance is lost between the three phases of the output current from the PM motor. • Perform Fault Reset to clear the fault. 			
Code	Name	Cause	Possible Solution
LSo	LSo Fault	The motor code is not set correctly.	<ul style="list-style-type: none"> • Set <i>E5-01 [PM Motor Code Selection]</i> correctly based on the motor being used. • For specialized motors, refer to the motor's test report and set <i>E5-xx</i> correctly.
		The load is too heavy.	<ul style="list-style-type: none"> • Reduce the load. • Replace the drive and motor with a larger model.
		An external force on the load side caused the motor to move at start.	Identify and fix any problems on the load side causing the motor to rotate from the load side.
		The drive incorrectly detected the motor magnetic pole position.	<ul style="list-style-type: none"> • Set <i>b3-01 = 1 [Speed Search Selection at Start = Enabled]</i>. • Check <i>U6-57 [PoleDis IdDifVal]</i>, and if the value is lower than 819, increase the value set in <i>n8-84 [InitPolarityEstimationTimeoutCur]</i>.
		Values set in parameters <i>L8-93 [LSo Detection Time at Low Speed]</i> , <i>L8-94 [LSo Detection Level at Low Speed]</i> , and <i>L8-95 [Average LSo Freq at Low Speed]</i> are incorrect.	Increase the values set in <i>L8-93 to L8-95</i> .
Note: <ul style="list-style-type: none"> • Detected if step-out is detected while running at low speed. • Perform Fault Reset to clear the fault. • <i>LSo</i> is a protective function which stops the motor to discontinue reverse running if a motor without a motor code mistakenly detects the initial polarity. To detect motor reversal quickly, lower the values set in <i>L8-93 to L8-95</i> to a range in which the drive does not malfunction. 			
Code	Name	Cause	Possible Solution
nSE	Node Setup Error	The terminal to which <i>H1-xx = 47 [Node Setup]</i> was set was triggered during run.	Stop the drive when using the Node Setup function.
		The Run command was input while the Node Setup function was active.	
Note: <ul style="list-style-type: none"> • Perform Fault Reset to clear the fault. 			
Code	Name	Cause	Possible Solution
oC	Overcurrent	The load is too heavy.	<ul style="list-style-type: none"> • Measure the current flowing into the motor. • Replace the drive with a larger capacity model if the current value exceeds the drive rated current. • If the current value changes suddenly, reduce the load change or switch to a larger drive.
		The motor is damaged from overheat or the motor insulation is deteriorated.	Measure the motor insulation resistance, and replace the motor if there is electrical conduction or worn insulation.
		The contact with a damaged motor main circuit cable is creating a short circuit.	<ul style="list-style-type: none"> • Check whether the motor main circuit cable is damaged, and remove any short circuits. • Measure the resistance between the motor main circuit cable and the ground terminal. If there is electrical conduction, replace the cable.
		The output transistor of the drive has been damaged due to a short circuit or ground fault on the drive output side.	<ul style="list-style-type: none"> • Make sure terminal B1 and terminals U/T1, V/T2, and W/T3 are not shorted. Also make sure terminal - and terminals U/T1, V/T2, and W/T3 are not shorted. • If a short circuit has occurred, contact Yaskawa or your nearest sales representative.

Code	Name	Cause	Possible Solution
		The acceleration time is too short.	<ul style="list-style-type: none"> Calculate the torque necessary during acceleration relative to the load inertia and the specified acceleration time. Increase the value set in <i>C1-01</i>, <i>C1-03</i>, <i>C1-05</i>, or <i>C1-07</i> [<i>Acceleration Time</i>] until the necessary torque is achieved. Increase the value set in <i>C2-01</i> to <i>C2-04</i> [<i>S-Curve Characteristics</i>] until the necessary torque is achieved. Replace the drive with a larger capacity model.
		The drive is attempting to operate a specialized motor or a motor that exceeds the maximum applicable motor output of the drive.	<ul style="list-style-type: none"> Check the motor nameplate and reevaluate the motor and drive to ensure that the drive rated current is larger than the motor rated current. Replace the drive with a larger capacity model.
		A magnetic contactor was switched at the output.	Set up the operation sequence in which the electromagnetic contactor is not turned on/off while the drive is outputting voltage.
		Wrong V/f pattern settings.	<ul style="list-style-type: none"> Check the ratios between the V/f pattern frequency and voltage. Lower the voltage if it is too high relative to the frequency. Adjust <i>E1-04</i> to <i>E1-10</i> [<i>V/f Pattern Parameters</i>]. For motor 2, adjust <i>E3-04</i> to <i>E3-10</i>.
		Torque compensation gain is too large.	Lower the value set in <i>C4-01</i> [<i>Torque Compensation Gain</i>] enough that the motor does not stall.
		A malfunction occurred due to noise.	Check the control circuit lines, main circuit lines, and ground wiring, and minimize the effects of noise.
		The gain during overexcitation operation is set too large.	<ul style="list-style-type: none"> Identify the timing under which the fault occurs. If the fault occurs simultaneously with overexcitation operation, reduce the value of <i>n3-13</i> [<i>Overexcitation Deceleration Gain</i>], considering the motor flux saturation.
		The Run command was input while the motor was coasting.	<ul style="list-style-type: none"> Reevaluate the sequence to ensure that the stop command is input after the motor has come to a complete stop. Set <i>b3-01</i> = 1 [<i>Speed Search Selection at Start = Enabled</i>] or assign <i>H1-xx</i> = 61, 62 [<i>External Speed Search command</i>] to input speed search commands from the multi-function digital input terminals.
		The motor code is not set correctly. (PM Control Method)	<ul style="list-style-type: none"> Enter the correct motor code to <i>E5-01</i> [<i>PM Motor Code Selection</i>] based on the PM motor being used. In the case of a specialized motor, refer to the test report of the motor and set <i>E5-xx</i> correctly.
		The current flowing in the motor exceeded the value set in <i>L8-27</i> [<i>Overcurrent Detection Gain</i>]. (PM Control Method)	Correct the value set in <i>L8-27</i> .
		The control method is not set correctly for the motor being used.	Set <i>A1-02</i> [<i>Control Method Selection</i>] correctly.
		The motor main circuit cable is too long.	Replace the drive with a larger capacity model.
<p>Note:</p> <ul style="list-style-type: none"> Occurs if the drive sensors detect a drive output current exceeding the specified overcurrent detection level. Perform Fault Reset to clear the fault. 			

6.4 Fault

Code	Name	Cause	Possible Solution
oFA00	Not supported	An option card that is not compatible with the CN5-A connector was connected.	Connect the option card to the correct connector. Note: The PG option card could not be connected to the CN5-A connector.
Note: •Perform Fault Reset to clear the fault. •Fault tracing cannot be executed.			
Code	Name	Cause	Possible Solution
oFA01	Connection Error	The option card connected to the CN5-A connector was changed during operation.	1. De-energize the drive. 2. Properly connect the option card to the connector on the drive, referring to the manual for the option card.
Note: Perform Fault Reset to clear the fault.			
Code	Name	Cause	Possible Solution
oFA02	DuplicateOptions	The same option card or the same type of option card has been connected to the CN5-A, B, and C connectors.	Connect the option card to the correct connector. Note: Use the CN5-C and CN5-B connectors when mounting two PG option cards.
Note: Perform Fault Reset to clear the fault.			
Code	Name	Cause	Possible Solution
oFA03 to oFA06	Option Card Error Occurred at Option Port CN5-A	A fault occurred in the option card.	1. De-energize the drive. 2. Check whether the option card is connected securely to the connector. 3. If the problem continues, replace the option card.
Note: Perform Fault Reset to clear the fault.			
Code	Name	Cause	Possible Solution
oFA10, oFA11	Option Card Error Occurred at Option Port CN5-A	A fault occurred in the option card.	1. De-energize the drive. 2. Check whether the option card is connected securely to the connector. 3. If the problem continues, replace the option card.
Note: Perform Fault Reset to clear the fault.			
Code	Name	Cause	Possible Solution
oFA12 to oFA17	Option Card Connection Error (CN5-A)	A fault occurred in the option card.	1. De-energize the drive. 2. Check whether the option card is connected securely to the connector. 3. If the problem continues, replace the option card.
Note: Perform Fault Reset to clear the fault.			
Code	Name	Cause	Possible Solution
oFA30 to oFA43	Communication Option Card Connection Error (CN5-A)	A fault occurred in the option card.	1. De-energize the drive. 2. Check whether the option card is connected securely to the connector. 3. If the problem continues, replace the option card.
Note: Perform Fault Reset to clear the fault.			

Code	Name	Cause	Possible Solution
oFb00	Not supported	An option card that is not compatible with the CN5-B connector was connected.	Connect the option card to the correct connector. Note: The option cards that can be connected to the CN5-B connector are the DO-A3, AO-A3, PG-B3, and PG-X3. Use the CN5-C connector when mounting only one PG option card.
Note: • Perform Fault Reset to clear the fault. • Fault tracing cannot be executed.			
Code	Name	Cause	Possible Solution
oFb01	Connection Error	The option card connected to the CN5-B connector was changed during operation.	1. De-energize the drive. 2. Properly connect the option card to the connector on the drive, referring to the manual for the option card.
Note: Perform Fault Reset to clear the fault.			
Code	Name	Cause	Possible Solution
oFb02	DuplicateOptions	The same option card or the same type of option card has been connected to the CN5-A, B, and C connectors.	Connect the option card to the correct connector.
Note: Perform Fault Reset to clear the fault.			
Code	Name	Cause	Possible Solution
oFb03 to oFb11	Option card error occurred at Option Port CN5-B	A fault occurred in the option card.	1. De-energize the drive. 2. Check whether the option card is connected securely to the connector. 3. If the problem continues, replace the option card.
Note: Perform Fault Reset to clear the fault.			
Code	Name	Cause	Possible Solution
oFb12 to oFb17	Option card error occurred at Option Port CN5-B	A fault occurred in the option card.	1. De-energize the drive. 2. Check whether the option card is connected securely to the connector. 3. If the problem continues, replace the option card.
Note: Perform Fault Reset to clear the fault.			
Code	Name	Cause	Possible Solution
oFC00	Not supported	An option card that is not compatible with the CN5-C connector was connected.	Connect the option card to the correct connector. Note: AI-A3, DI-D3, and communication option cards cannot be connected to the CN5-C connector.
Note: • Perform Fault Reset to clear the fault. • Fault tracing cannot be executed.			
Code	Name	Cause	Possible Solution
oFC01	Connection Error	The option card connected to the CN5-C connector was changed during operation.	1. De-energize the drive. 2. Properly connect the option card to the connector on the drive, referring to the manual for the option card.
Note: Perform Fault Reset to clear the fault.			
Code	Name	Cause	Possible Solution
oFC02	DuplicateOptions	The same option card or the same type of option card has been connected to the CN5-A, B, and C connectors.	Connect the option card to the correct connector.
Note: Perform Fault Reset to clear the fault.			

6.4 Fault

Code	Name	Cause	Possible Solution
oFC03 to oFC11	Option Card Error Occurred at Option Port CN5-C	A fault occurred in the option card.	<ol style="list-style-type: none"> 1. De-energize the drive. 2. Check whether the option card is connected securely to the connector. 3. If the problem continues, replace the option card.
Note: Perform Fault Reset to clear the fault.			
Code	Name	Cause	Possible Solution
oFC12 to oFC17	Option Card Error Occurred at Option Port CN5-C	A fault occurred in the option card.	<ol style="list-style-type: none"> 1. De-energize the drive. 2. Check whether the option card is connected securely to the connector. 3. If the problem continues, replace the option card.
Note: Perform Fault Reset to clear the fault.			
Code	Name	Cause	Possible Solution
oFC50 to oFC55	Option card error occurred at Option Port CN5-C	A fault occurred in the option card.	Refer to the manual for the PG-RT3 or PG-F3 option card.
Note: Perform Fault Reset to clear the fault.			
Code	Name	Cause	Possible Solution
oH	Overheat 1 (Heatsink Overheat)	The ambient temperature is too high.	<ul style="list-style-type: none"> • Check the ambient temperature. • Improve the ventilation within the control panel. • Install a cooling device (cooling fan or air conditioner) to lower the ambient temperature. • Remove anything near the drive that might be producing excessive heat.
		The load is too heavy.	<ul style="list-style-type: none"> • Measure the output current. • Reduce the load. • Lower the value set in C6-02 [Carrier Frequency Selection].
		The internal cooling fan of the drive is stopped.	<ol style="list-style-type: none"> 1. Follow the description in this manual to replace cooling fan. 2. Set o4-03 = 0 [CoolingFan OperationTime Setting = 0 h].
Note:			
<ul style="list-style-type: none"> • Detected if the heatsink temperature of the drive exceeds the value set in L8-02 [Overheat Alarm Level]. • Perform Fault Reset to clear the fault. • If detected, the drive will operate the motor according to the stop method set in L8-03 [Overheat Pre-Alarm Ope Selection]. 			
Code	Name	Cause	Possible Solution
oH1	Overheat 1 (Heatsink Overheat)	The ambient temperature is too high.	<ul style="list-style-type: none"> • Check the ambient temperature. • Improve the ventilation within the control panel. • Install a cooling device (cooling fan or air conditioner) to lower the ambient temperature. • Remove anything near the drive that might be producing excessive heat.
		The load is too heavy.	<ul style="list-style-type: none"> • Measure the output current. • Reduce the load. • Lower the value set in C6-02 [Carrier Frequency Selection].
Note:			
<ul style="list-style-type: none"> • Detected if the heatsink temperature of the drive exceeds the oH1 detection level. The oH1 detection level is determined by o2-04 [Drive Model Selection]. • Perform Fault Reset to clear the fault. 			
Code	Name	Cause	Possible Solution
oH3	Motor Overheat Alarm (PTC Input)	The wiring with the thermistor used to detect motor temperature is faulty.	Correct any wiring errors.
		A fault occurred on the machine side. Example: The machine is locked.	Check the condition of the machine and remove the cause of the fault.

Code	Name	Cause	Possible Solution
		The motor has overheated.	<ul style="list-style-type: none"> Check the load level, acceleration/deceleration time, and motor start/stop frequency (cycle time). Reduce the load. Increase the value set in <i>C1-01 to C1-08</i> [<i>Acceleration/Deceleration Time</i>]. Set <i>E2-01</i> [<i>Motor Rated Current (FLA)</i>] correctly to the value that indicated on the motor nameplate. Check whether the motor cooling system is operating normally, and repair or replace it if it is damaged. Adjust <i>E1-04 to E1-10</i> [<i>V/f Pattern Parameters</i>]. For motor 2, adjust <i>E3-04 to E3-10</i>. In particular, reduce the values set in <i>E1-08</i> [<i>Mid Point A Voltage</i>] and <i>E1-10</i> [<i>Minimum Output Voltage</i>]. <p>Note: If <i>E1-08</i> and <i>E1-10</i> are reduced too much, the overload tolerance is reduced at low speeds.</p>
<p>Note:</p> <ul style="list-style-type: none"> Detected if the motor overheat signal entered to an analog input terminal A1, A2, or A3 exceeds the alarm detection level. (If <i>H3-02</i>, <i>H3-10</i>, or <i>H3-06 = E</i> [<i>MFAI Function Select = Motor Temperature (PTC input)</i>] has been set.) Perform Fault Reset to clear the fault. If detected, the drive will operate the motor according to the stop method set in <i>L1-03</i> [<i>Motor OH Alarm Operation Select</i>]. 			
Code	Name	Cause	Possible Solution
oH4	Motor Overheat Fault (PTC Input)	The motor has overheated.	<ul style="list-style-type: none"> Check the load level, acceleration/deceleration time, and motor start/stop frequency (cycle time). Reduce the load. Increase the value set in <i>C1-01 to C1-08</i> [<i>Acceleration/Deceleration Time</i>]. Set <i>E2-01</i> [<i>Motor Rated Current (FLA)</i>] correctly to the value that indicated on the motor nameplate. Check whether the motor cooling system is operating normally, and repair or replace it if it is damaged. Adjust <i>E1-04 to E1-10</i> [<i>V/f Pattern Parameters</i>]. For motor 2, adjust <i>E3-04 to E3-10</i>. In particular, reduce the values set in <i>E1-08</i> [<i>Mid Point A Voltage</i>] and <i>E1-10</i> [<i>Minimum Output Voltage</i>]. <p>Note: If <i>E1-08</i> and <i>E1-10</i> are reduced too much, the overload tolerance is reduced at low speeds.</p>
<p>Note:</p> <ul style="list-style-type: none"> Detected if the motor overheat signal to analog input terminal A1, A2, or A3 exceeds the fault detection level. (If <i>H3-02</i>, <i>H3-10</i>, or <i>H3-06 = E</i> [<i>MFAI Function Select = Motor Temperature (PTC input)</i>] has been set.) Perform Fault Reset to clear the fault. 			
Code	Name	Cause	Possible Solution
oL1	Motor Overload	The load is too heavy.	<p>Reduce the load.</p> <p>Note: Reset <i>oL1</i> after <i>U4-16</i> [<i>MotorOLEstimate(oL1)</i>] has fallen below 100. The value set in <i>U4-16</i> must be less than 100 before <i>oL1</i> can be reset.</p>
		The acceleration/deceleration time or cycle time is too short.	<ul style="list-style-type: none"> Check the acceleration/deceleration time and the motor start/stop frequency (cycle time). Increase the value set in <i>C1-01 to C1-08</i> [<i>Acceleration/Deceleration Time</i>].

6.4 Fault

Code	Name	Cause	Possible Solution
		Overload occurred while running at low speed.	<ul style="list-style-type: none"> Lower the load when running at low speed. Raise the motor speed. If the motor is run frequently at low speeds, either replace it with one that is a size larger or use a drive dedicated motor. <p>Note: If a general-purpose motor is used, overload may occur while running at low speed even when operating at below the rated current.</p>
		<i>L1-01 [Motor Overload Protection Select]</i> is not set correctly.	Set <i>L1-01</i> in accordance with the motor characteristics if a specialized motor is used.
		The V/f pattern does not fit the motor characteristics.	<ul style="list-style-type: none"> Check the ratios between the V/f pattern frequency and voltage. Lower the voltage if it is too high relative to the frequency. Adjust <i>E1-04</i> to <i>E1-10 [V/f Pattern Parameters]</i>. For motor 2, adjust <i>E3-04</i> to <i>E3-10</i>. In particular, reduce the values set in <i>E1-08 [Mid Point A Voltage]</i> and <i>E1-10 [Minimum Output Voltage]</i>. <p>Note: If <i>E1-08</i> and <i>E1-10</i> are reduced too much, the overload tolerance is reduced at low speeds.</p>
		Set <i>E1-06 [Base Frequency]</i> correctly.	Set <i>E1-06</i> correctly to the rated frequency that indicated on the motor nameplate.
		Multiple motors are running off the same drive.	Set <i>L1-01 = 0 [Motor Overload Protection Select = Disabled]</i> , and then configure a circuit to protect the motors by connecting a thermal overload relay to each motor.
		The characteristics of the electronic thermal protector and the characteristics of the motor overload do not match.	<ul style="list-style-type: none"> Check the motor characteristics and set <i>L1-01 [Motor Overload Protection Select]</i> correctly. Connect a thermal overload relay to the motor.
		The electronic thermal protector is operating at the wrong level.	Set <i>E2-01 [Motor Rated Current (FLA)]</i> correctly to the value that indicated on the motor nameplate.
		Motor loss due to overexcitation operation is increasing.	<ul style="list-style-type: none"> Lower the value set in <i>n3-13 [Overexcitation Deceleration Gain]</i>. Set <i>L3-04 ≠ 4 [Decel Stall Prevention Selection ≠ Overexcitation/High Flux]</i>. Set <i>n3-23 = 0 [Overexcitation Operation Select = Enabled in both directions]</i>.
		The speed search-related parameters are set incorrectly.	<ul style="list-style-type: none"> Check the settings for all speed search related parameters. Adjust <i>b3-03 [Speed Search Deceleration Time]</i>. Set <i>b3-24 = 1 [Speed Search Method Selection = Speed Estimation]</i> after Auto-Tuning.
		The output current is fluctuating due to input power supply phase loss.	Check whether or not there is input phase loss, and remedy any phase loss.
<p>Note:</p> <ul style="list-style-type: none"> Detected if the electronic thermal protector of the drive triggered the motor overload protection. Perform Fault Reset to clear the fault. 			
Code	Name	Cause	Possible Solution
oL2	Drive Overloaded	The load is too heavy.	Reduce the load.
		The acceleration/deceleration time or cycle time is too short.	<ul style="list-style-type: none"> Check the acceleration/deceleration time and the motor start/stop frequency (cycle time). Increase the value set in <i>C1-01</i> to <i>C1-08 [Acceleration/Deceleration Time]</i>.

Code	Name	Cause	Possible Solution
		The V/f pattern does not fit the motor characteristics.	<ul style="list-style-type: none"> Check the ratios between the V/f pattern frequency and voltage. Lower the voltage if it is too high relative to the frequency. Adjust <i>E1-04</i> to <i>E1-10</i> [<i>V/f Pattern Parameters</i>]. For motor 2, adjust <i>E3-04</i> to <i>E3-10</i>. In particular, reduce the values set in <i>E1-08</i> [<i>Mid Point A Voltage</i>] and <i>E1-10</i> [<i>Minimum Output Voltage</i>]. <p>Note: If <i>E1-08</i> and <i>E1-10</i> are reduced too much, the overload tolerance is reduced at low speeds.</p>
		The drive capacity is too small.	Replace the drive with a larger capacity model.
		Overload occurred while running at low speed.	<ul style="list-style-type: none"> Lower the load when running at low speed. Replace the drive with a larger capacity model. Lower the value set in <i>C6-02</i> [<i>Carrier Frequency Selection</i>].
		Torque compensation gain is too large.	Lower the value set in <i>C4-01</i> [<i>Torque Compensation Gain</i>] enough that the motor does not stall.
		The speed search-related parameters are set incorrectly.	<ul style="list-style-type: none"> Check the settings for all speed search related parameters. Adjust <i>b3-03</i> [<i>Speed Search Deceleration Time</i>]. Set <i>b3-24</i> = 1 [<i>Speed Search Method Selection = Speed Estimation</i>] after Auto-Tuning.
		The output current is fluctuating due to input power supply phase loss.	<ul style="list-style-type: none"> Correct any wiring errors in the main circuit drive input power. Check whether or not there is input phase loss, and remedy any phase loss.
<p>Note:</p> <ul style="list-style-type: none"> Detected if the electronic thermal protector of the drive triggered the drive overload protection. Perform Fault Reset to clear the fault. 			
Code	Name	Cause	Possible Solution
oL3	Overtorque Detection 1	A fault occurred on the machine side. Example: The machine is locked.	Check the condition of the machine and remove the cause of the fault.
		The parameters for load are not appropriate.	Adjust <i>L6-02</i> and <i>L6-03</i> .
<p>Note:</p> <ul style="list-style-type: none"> Detected if the drive output current has exceeded the level set in <i>L6-02</i> [<i>Torque Detection Level 1</i>] for longer than <i>L6-03</i> [<i>Torque Detection Time 1</i>]. Perform Fault Reset to clear the fault. If detected, the drive will operate the motor according to the stop method set in <i>L6-01</i> [<i>Torque Detection Selection 1</i>]. 			
Code	Name	Cause	Possible Solution
oL4	Overtorque Detection 2	A fault occurred on the machine side. Example: The machine is locked.	Check the condition of the machine and remove the cause of the fault.
		The parameters for load are not appropriate.	Adjust <i>L6-05</i> and <i>L6-06</i> .
<p>Note:</p> <ul style="list-style-type: none"> Detected if the drive output current has exceeded the level set in <i>L6-05</i> [<i>Torque Detection Level 2</i>] for longer than <i>L6-06</i> [<i>Torque Detection Time 2</i>]. Perform Fault Reset to clear the fault. If detected, the drive will operate the motor according to the stop method set in <i>L6-04</i> [<i>Torque Detection Selection 2</i>]. 			
Code	Name	Cause	Possible Solution
oL5	Mechanical Weakening Detection 1	Overtorque was detected based on the conditions for mechanical weakening detection set in <i>L6-08</i> [<i>Mechanical Weakening Detect Ope</i>].	Perform deterioration diagnostics on the machine side.
<p>Note:</p> <ul style="list-style-type: none"> Perform Fault Reset to clear the fault. If detected, the drive will operate the motor according to the stop method set in <i>L6-08</i> [<i>Mechanical Weakening Detect Ope</i>]. 			

6.4 Fault

Code	Name	Cause	Possible Solution
oL7	High Slip Braking oL	The load inertia is too big.	<ul style="list-style-type: none"> Reduce deceleration times in <i>C1-02</i>, <i>C1-04</i>, <i>C1-06</i>, and <i>C1-08</i> [<i>Deceleration Time</i>] for applications that do not use High Slip Braking. Shorten the deceleration time using a braking resistor.
		An external force on the load side caused the motor to move.	
		Something is restricting deceleration on the load side.	<ul style="list-style-type: none"> Increase the value set in <i>n3-04</i>. Connect a thermal overload relay to the motor, and set <i>n3-04</i> = 1200 s (<i>maximum value</i>).
		The value set in <i>n3-04</i> is too small.	
Note: <ul style="list-style-type: none"> Detected if the output frequency stayed constant for longer than <i>n3-04</i> [<i>High-Slip Braking Overload Time</i>]. Perform Fault Reset to clear the fault. 			
Code	Name	Cause	Possible Solution
oPr	Keypad Connection Fault	The keypad is not securely connected to the connector on the drive.	Check the connection between the keypad and the drive.
		The extension cable between the drive and the keypad is disconnected.	Replace the cable if damaged.
Note: <ul style="list-style-type: none"> Detected if all of the following conditions are true: <ul style="list-style-type: none"> <i>-o2-06</i> = 1 [<i>Ope Select @Keypad is Disconnect = Enabled</i>] has been set. <i>-b1-02</i> = 0 [<i>Run Command Selection 1 = Keypad</i>] has been set, or operation in LOCAL is being executed using the keypad. Perform Fault Reset to clear the fault. 			
Code	Name	Cause	Possible Solution
oS	Overspeed	Overshoot is occurring.	<ul style="list-style-type: none"> Reduce <i>C5-01</i> [<i>ASR Proportional Gain 1</i>] and increase <i>C5-02</i> [<i>ASR Integral Time 1</i>]. Adjust the pulse train gain using the pulse train input setting parameters <i>H6-02</i> to <i>H6-05</i>.
		Incorrect number of PG pulses has been set.	Set <i>H6-02</i> [<i>Pulse Train Input Scaling</i>] to the pulse train frequency during 100% reference (maximum motor rotation speed).
		The oS detection level has not been set appropriately.	Adjust <i>F1-08</i> and <i>F1-09</i> .
Note: <ul style="list-style-type: none"> Detected if the motor speed remains above the value set in <i>F1-08</i> [<i>Overspeed Detection Level</i>] for longer than <i>F1-09</i> [<i>Overspeed Detection Delay Time</i>]. Perform Fault Reset to clear the fault. If detected, the drive will operate the motor according to the stop method set in <i>F1-03</i> [<i>Operation Select at Overspeed</i>]. 			
Code	Name	Cause	Possible Solution
ov	Overvoltage	Deceleration time is too short and regenerative energy is flowing from the motor into the drive.	<ul style="list-style-type: none"> Set <i>L3-04</i> = 1 [<i>Decel Stall Prevention Selection = General Purpose</i>]. Increase the value set in <i>C1-02</i>, <i>C1-04</i>, <i>C1-06</i>, or <i>C1-08</i> [<i>Deceleration Time</i>]. Connect a dynamic braking option to the drive.
		The acceleration time is too short.	<ul style="list-style-type: none"> Check if sudden drive acceleration triggers an overvoltage fault. Increase the value set in <i>C1-01</i>, <i>C1-03</i>, <i>C1-05</i>, or <i>C1-07</i> [<i>Acceleration Time</i>]. Increase the value set in <i>C2-02</i> [<i>S-Curve Time @ end of Accel</i>]. Set <i>L3-11</i> = 1 [<i>OV Suppression Function Select = Enabled</i>].
		The braking load is too large.	Connect a dynamic braking option to the drive.
		Surge voltages are entered into input power supply.	Connect a DC reactor to the drive. Note: Within the same power supply system, turning phase advancing capacitors on and off, operating thyristor converters, and the like may apply surge voltages and cause the input voltage to rise abnormally.

Code	Name	Cause	Possible Solution
		The drive output cable or motor is shorted to ground. (The current short to ground is charging the main circuit capacitor of the drive through the power supply.)	<ol style="list-style-type: none"> 1. Check the motor main circuit cable, terminals, and motor terminal box, and eliminate any ground faults. 2. Restart the drive.
		The speed search-related parameters are set incorrectly. (This fault also occurs during recovery from momentary power loss and after Auto Restarts.)	<ul style="list-style-type: none"> • Check the settings for all speed search related parameters. • Set $b3-19 \neq 0$ [<i>Number of Speed Search Restarts $\neq 0$ times</i>]. • Adjust $b3-03$ [<i>Speed Search Deceleration Time</i>]. • Perform Stationary Auto-Tuning for Line-to-Line Resistance and then set $b3-24 = 1$ [<i>Speed Search Method Selection = Speed Estimation</i>].
		The power supply voltage is too high.	Lower the power supply voltage so that it matches the drive rated voltage.
		The braking resistor or braking resistor unit wiring is faulty.	Correct any wiring errors in the connections with the braking resistor or braking resistor unit.
		The encoder cable is improperly wired or disconnected.	Check for any wiring errors or disconnected wires in the encoder cable, and fix any problems.
		Noise interference along the encoder cable	Separate the encoder cable from the source of the noise such as the drive output line.
		A drive malfunction occurred due to noise.	<ul style="list-style-type: none"> • Check the control circuit lines, main circuit lines, and ground wiring, and minimize the effects of noise. • Check whether an electromagnetic contactor is the noise source, and use Surge Protective Device if necessary.
		The load inertia is not set correctly.	<ul style="list-style-type: none"> • Check the load inertia settings when using KEB, overvoltage suppression, or stall prevention during deceleration. • Adjust $L3-25$ [<i>Load Inertia Ratio</i>] in accordance with the machine.
		The Short Circuit Braking function is being used in Open Loop Vector Control for PM.	Connect a braking resistor to the drive.
		Motor hunting occurs.	<ul style="list-style-type: none"> • Adjust the parameters that control hunting. • Adjust $n1-02$ [<i>Hunting Prevention Gain Setting</i>]. • Adjust $n2-02$ [<i>SpdFeedbackDetCtr(AFR)TimeConst1</i>] and $n2-03$ [<i>SpdFeedbackDetCtr(AFR)TimeConst2</i>]. • Adjust $n8-45$ [<i>Spd Feedback Detect Control Gain</i>] and $n8-47$ [<i>Pull-InCurCompensationTime Const</i>].

Note:

- Detected if the DC bus voltage exceeds the *ov* detection level while the drive is running.
- The *ov* detection level is about 410 V when using a 200 V class drive. For a 400 V class drive, the detection level is around 820 V.
- Perform Fault Reset to clear the fault.

Code	Name	Cause	Possible Solution
PF	Input Phase Loss	Phase loss in the drive input power.	Correct any wiring errors in the main circuit drive input power.
		There is loose wiring in the drive input power terminals.	Properly tighten the terminals according to the specified tightening torque.
		Excessive fluctuation in the drive input power voltage.	<ul style="list-style-type: none"> • Check for any problems with the input power. • Review the possible solutions for stabilizing the drive input power. • Take steps to stabilize the power supply. • Check for any problems with the magnetic contactor on the main circuit side if no problems are found with the power supply.

6.4 Fault

Code	Name	Cause	Possible Solution
		Poor balance between voltage phases.	<ul style="list-style-type: none"> Check for any problems with the input power. Check the voltage from the drive input power and review the possible solutions for stabilizing the drive input power. Set $L8-05 = 0$ [<i>Input Phase Loss Protect Select = Disabled</i>].
		The main circuit capacitors are worn.	<ul style="list-style-type: none"> Check the capacitor maintenance time in monitor $U4-05$ [<i>Capacitor Maintenance</i>]. If $U4-05$ exceeds 90 %, replace the control board or the entire drive. For more information on replacing the control board, contact Yaskawa or your nearest sales representative. If drive input power appears normal but the fault continues to occur, replace either the control board or the entire drive. For instructions on replacing the control board, contact Yaskawa or your nearest sales representative.
Note: <ul style="list-style-type: none"> Detected if the DC bus voltage fluctuates abnormally despite regeneration not being performed. Perform Fault Reset to clear the fault. Use $L8-05$ [<i>Input Phase Loss Protect Select</i>] to enable/disable PF detection. 			
Code	Name	Cause	Possible Solution
PGo	PG Disconnect	The encoder cable is improperly wired or disconnected.	Check for any wiring errors or disconnected wires in the encoder cable, and fix any problems.
		Power supply is not being supplied to the encoder.	Check the encoder power supply.
		The holding brake is being applied to the motor.	Release the holding brake.
Note: <ul style="list-style-type: none"> Detected if the speed detection pulse signal is not received from the encoder within the detection time set in $F1-14$ [<i>PG Open-Circuit Detection Time</i>]. Perform Fault Reset to clear the fault. If detected, the drive will operate the motor according to the stop method set in $F1-02$ [<i>PG Feedback Loss Selection</i>]. 			
Code	Name	Cause	Possible Solution
PGoH	PG Hardware Fault	The encoder cable is disconnected.	Correct any disconnected wires in the encoder cable.
Note: <ul style="list-style-type: none"> Perform Fault Reset to clear the fault. If detected, the drive will operate the motor according to the stop method set in $F1-02$ [<i>PG Feedback Loss Selection</i>]. 			
Code	Name	Cause	Possible Solution
rF	Braking Resistor Fault	The resistance of the dynamic braking option connected to the drive is too low.	Select a dynamic braking option that fits the model and duty rating of the drive.
		A regenerative converter, regenerative unit, or braking unit is connected to the drive.	Set $L8-55 = 0$ [<i>Internal Braking Transistor Protect = Disable</i>].
Note: <ul style="list-style-type: none"> Perform Fault Reset to clear the fault. 			
Code	Name	Cause	Possible Solution
rH	Braking Resistor Overheat	The deceleration time is too short and excessive regenerative energy is flowing back into the drive.	<ul style="list-style-type: none"> Check the load level, deceleration time, and speed. Reduce the load. Increase the value set in $C1-02$, $C1-04$, $C1-06$, or $C1-08$ [<i>Deceleration Time</i>]. Switch to a dynamic braking option with a larger allowable power consumption.
		The duty cycle is too high.	Check the duty cycle. Note: Setting to $L8-01 = 1$ [<i>Internal DB Resistor Protect Sel = Provided</i>] allows a braking duty cycle of maximum 3%.

Code	Name	Cause	Possible Solution
		The braking load is too large.	<ul style="list-style-type: none"> Recalculate braking load and braking power, and reduce the braking load. Improve braking power by checking the choice of braking resistor.
		The chosen braking resistor is not appropriate.	Check the braking resistor specifications again, and select a suitable braking resistor.
<p>Note:</p> <ul style="list-style-type: none"> Detected if the braking resistor overheat protective function was triggered. The magnitude of the braking load trips the braking resistor overheat alarm, NOT the surface temperature. Consequently, the alarm will be tripped when the duty cycle exceeds the rating permits of the braking resistor. Perform Fault Reset to clear the fault. Fault detection is enabled by <i>L8-01 [Internal DB Resistor Protect Sel]</i>. 			
Code	Name	Cause	Possible Solution
rr	Dynamic Braking Transistor	The drive control circuit is damaged. The internal braking transistor of the drive has malfunctioned.	<ul style="list-style-type: none"> Restart the drive and check if the fault still remains. Replace either the control board or the entire drive if the fault continues. For instructions on replacing the control board, contact Yaskawa or your nearest sales representative.
<p>Note:</p> Perform Fault Reset to clear the fault.			
Code	Name	Cause	Possible Solution
SC	Out Short Circuit or IGBT Fault	The motor is damaged from overheat or the motor insulation is deteriorated. The contact with a damaged motor main circuit cable is creating a short circuit. The output transistor of the drive has been damaged due to a short circuit or ground fault on the drive output side.	Measure the motor insulation resistance, and replace the motor if there is electrical conduction or worn insulation. <ul style="list-style-type: none"> Check whether the motor main circuit cable is damaged, and remove any short circuits. Measure the resistance between the motor main circuit cable and the ground terminal. If there is electrical conduction, replace the cable. Make sure terminal B1 and terminals U/T1, V/T2, and W/T3 are not shorted. Also make sure terminal - and terminals U/T1, V/T2, and W/T3 are not shorted. If a short circuit has occurred, contact Yaskawa or your nearest sales representative.
<p>Note:</p> <ul style="list-style-type: none"> Occurs if a short circuit or ground fault on the drive output side, or an IGBT failure, is detected. Perform Fault Reset to clear the fault. 			
Code	Name	Cause	Possible Solution
SCF	Safety Circuit Fault	The safety circuit is broken.	Replace the board or the entire drive. For instructions on replacing the control board, contact Yaskawa or your nearest sales representative.
<p>Note:</p> Perform Fault Reset to clear the fault.			
Code	Name	Cause	Possible Solution
SEr	Too Many Speed Search Restarts	The speed search-related parameter settings are not appropriate. The motor is coasting in the opposite direction of the Run command.	<ul style="list-style-type: none"> Lower the value set in <i>b3-10 [Speed Estimation Detection Gain]</i>. Increase the value set in <i>b3-17 [Speed Est. Retry Current Level]</i>. Increase the value set in <i>b3-18 [Speed Est. Retry Detection Time]</i>. Perform Auto-Tuning again. Set <i>b3-14 = 1 [Bi-Direction Speed Search Select = Enabled]</i> .
<p>Note:</p> <ul style="list-style-type: none"> Detected if the number of speed search restarts exceeds the value set in <i>b3-19 [Number of Speed Search Restarts]</i>. Perform Fault Reset to clear the fault. 			

6.4 Fault

Code	Name	Cause	Possible Solution
STPo	Pull-Out Detection	The motor code is not set correctly.	<ul style="list-style-type: none"> Set <i>E5-01 [PM Motor Code Selection]</i> correctly based on the motor being used. In the case of a specialized motor, refer to the test report of the motor and set <i>E5-xx</i> correctly.
		The load is too heavy.	<ul style="list-style-type: none"> Increase the value set in <i>n8-55 [Load Inertia]</i>. Increase the value set in <i>n8-51 [Accel / Decel Pull-In Current]</i>. Reduce the load. Replace the drive and motor with a larger model.
		The load inertia is too big.	Increase the value set in <i>n8-55 [Load Inertia]</i> .
		The acceleration/deceleration time is too short.	<ul style="list-style-type: none"> Increase the value set in <i>C1-01 to C1-08 [Acceleration/Deceleration Time]</i>. Increase the value set in <i>C2-01 [S-Curve Time @ start of Accel]</i>.
		Responsiveness is poor.	Increase the value set in <i>n8-55 [Load Inertia]</i> .
Note: Perform Fault Reset to clear the fault.			
Code	Name	Cause	Possible Solution
SvE	Zero Servo Fault	The value set in the torque limit is too small.	Adjust the torque limit-related parameters <i>L7-01 to L7-04</i> .
		The load torque is too large.	Lower the load torque.
		Noise interference along the encoder cable	Separate the encoder cable from the source of the noise such as the drive output line.
Note: <ul style="list-style-type: none"> Detected if motor rotation position has shifted during Zero Servo. Perform Fault Reset to clear the fault. 			
Code	Name	Cause	Possible Solution
UL3	Undertorque Detection 1	A fault occurred on the machine side. Example: The pulley belt has broken.	Check the condition of the machine and remove the cause of the fault.
		The parameters for load are not appropriate.	Adjust <i>L6-02</i> and <i>L6-03</i> .
Note: <ul style="list-style-type: none"> Detected if the drive output current remains below the level set in <i>L6-02 [Torque Detection Level 1]</i> for longer than <i>L6-03 [Torque Detection Time 1]</i>. Perform Fault Reset to clear the fault. If detected, the drive will operate the motor according to the stop method set in <i>L6-01 [Torque Detection Selection 1]</i>. 			
Code	Name	Cause	Possible Solution
UL4	Undertorque Detection 2	A fault occurred on the machine side. Example: The pulley belt has broken.	Check the condition of the machine and remove the cause of the fault.
		The parameters for load are not appropriate.	Adjust <i>L6-05</i> and <i>L6-06</i> .
Note: <ul style="list-style-type: none"> Detected if the drive output current remains below the level set in <i>L6-05 [Torque Detection Level 2]</i> for longer than <i>L6-06 [Torque Detection Time 2]</i>. Perform Fault Reset to clear the fault. If detected, the drive will operate the motor according to the stop method set in <i>L6-04 [Torque Detection Selection 2]</i>. 			
Code	Name	Cause	Possible Solution
UL5	Mechanical Weakening Detection 2	Undertorque was detected based on the conditions for mechanical weakening detection set in <i>L6-08 [Mechanical Weakening Detect Ope]</i> .	Check whether the machine exhibits any deterioration.
Note: <ul style="list-style-type: none"> Perform Fault Reset to clear the fault. If detected, the drive will operate the motor according to the stop method set in <i>L6-08 [Mechanical Weakening Detect Ope]</i>. 			

Code	Name	Cause	Possible Solution
Uv1	DC Bus Undervoltage	Phase loss in the drive input power.	Check for any faulty wiring or disconnected wires in the main circuit power supply, and fix any problems.
		There is loose wiring in the drive input power terminals.	Properly tighten the terminals according to the specified tightening torque.
		Excessive fluctuation in the drive input power voltage.	<ul style="list-style-type: none"> Review the possible solutions for stabilizing the drive input power. Take steps to stabilize the power supply. Check for any problems with the magnetic contactor on the main circuit side if no problems are found with the power supply.
		Power loss occurred.	Improve the power supply.
		The main circuit capacitors are worn.	Check the capacitor maintenance period in <i>U4-05 [Capacitor Maintenance]</i> . If <i>U4-05</i> exceeds 90%, replace the control board or the entire drive. For more information on replacing the control board, contact Yaskawa or your nearest sales representative.
		The relay or contactor on the soft-charge bypass relay is damaged.	Check monitor <i>U4-06 [SChgBypassRelayMaint]</i> for the performance life of the soft-charge bypass relay. If <i>U4-06</i> exceeds 90%, replace the control board or the entire drive. For more information on replacing the control board, contact Yaskawa or your nearest sales representative.
Note: <ul style="list-style-type: none"> Detected if the DC bus voltage drops below the level set in <i>L2-05 [Undervoltage Detect Level (Uv1)]</i> while the drive is running. The <i>Uv1</i> detection level is about 190 V when using a 200 V class drive. For a 400 V class drive, the detection level is around 380 V. It is about 350 V when <i>E1-01 [Input AC Supply Voltage]</i> is set lower than 400. Perform Fault Reset to clear the fault. Fault tracing cannot be executed. 			
Code	Name	Cause	Possible Solution
Uv2	Ctrl Power Supply Voltage Fault	The value set in <i>L2-02 [MomentaryPowerLossRide-Thru Time]</i> was increased with the momentary power loss recovery unit not connected to the drive.	Connect the momentary power loss recovery unit to the drive.
		A drive hardware problem occurred.	<ul style="list-style-type: none"> Restart the drive and check if the fault still remains. Replace either the control board or the entire drive if the fault continues. For instructions on replacing the control board, contact Yaskawa or your nearest sales representative.
Note: <ul style="list-style-type: none"> Detected if the control power supply voltage has dropped. Perform Fault Reset to clear the fault. Fault tracing cannot be executed. 			
Code	Name	Cause	Possible Solution
Uv3	SoftCharge Bypass Circuit Fault	The relay or contactor on the soft-charge bypass relay is damaged.	<ul style="list-style-type: none"> Cycle power to the drive and see if the fault reoccurs. Replace either the control board or the entire drive if the fault continues. Check monitor <i>U4-06 [SChgBypassRelayMaint]</i> for the performance life of the soft-charge bypass relay. If <i>U4-06</i> exceeds 90%, replace the control board or the entire drive. Note: For more information on replacing the control board, contact Yaskawa or your nearest sales representative.
Note: <ul style="list-style-type: none"> Perform Fault Reset to clear the fault. Fault tracing cannot be executed. 			

6.5 Minor Faults/Alarms

This section explains the causes and possible solutions when a minor fault or alarm occurs. Remove the cause of the fault referring to the following table.

Code	Name	Cause	Possible Solution
AEr	Station Address Setting Error	Option card node address is outside of the acceptable setting range.	<ul style="list-style-type: none"> For CC-Link communication, set <i>F6-10 [CC-Link Node Address]</i> correctly. For MECHATROLINK communication, set <i>F6-20 [MECHATROLINK Station Address]</i> correctly. For CANopen communication, set <i>F6-35 [CANopen Node ID Selection]</i> correctly.
Note: If detected, <i>H2-xx = 10 [MFDO Function Select = Minor Fault]</i> will be ON.			
Code	Name	Cause	Possible Solution
bAT	Voltage of keypad's battery deficient	The voltage of keypad's battery is reduced.	Replace the keypad's battery.
Note: <ul style="list-style-type: none"> If detected, <i>H2-xx = 10 [MFDO Function Select = Minor Fault]</i> will be ON. Use <i>o4-24 [bAT Detection selection]</i> to enable/disable bAT detection. 			
Code	Name	Cause	Possible Solution
bb	Baseblock	External baseblock command was entered via one of the multi-function digital input terminals S1 to S8, and the drive output interrupted as indicated by an external baseblock command.	Check external sequence and baseblock command input timing.
Note: A minor fault signal will not be output even if the drive detects this minor fault.			
Code	Name	Cause	Possible Solution
boL	Braking Transistor Overload Fault	The duty cycle of the braking transistor is high (the regeneration power or repetition frequency is high).	<ul style="list-style-type: none"> Install a braking unit (CDBR series). Install a regenerative converter. Lengthen the deceleration time.
		The braking transistor protective function is enabled when a regenerative converter is being used.	Set <i>L8-55 = 0 [InternalBrakingTransistorProtect = Disable]</i> .
		The braking transistor in the drive is broken.	Replace the entire drive.
Note: If detected, <i>H2-xx = 10 [MFDO Function Select = Minor Fault]</i> will be ON.			
Code	Name	Cause	Possible Solution
bUS	Option Communication Error	The communications cable wiring is incorrect.	Correct any wiring errors.
		There is a short circuit or disconnection in the communications cable.	<ul style="list-style-type: none"> Repair disconnected cables and short circuits for proper wiring. Replace a faulty communications cable with a normal one.
		Communication data error occurred due to noise.	<ul style="list-style-type: none"> Check the control circuit lines, main circuit lines, and ground wiring, and minimize the effects of noise. Check whether an electromagnetic contactor is the noise source, and use Surge Protective Device if necessary. Use only recommended cables or other shielded line. Ground the shield on the controller side or the drive input power side. Separate all communication wiring from drive power lines, and install a noise filter to the input side of the power supply for communication. Minimize the effects of controller noise.
		The option card is not properly connected to the drive.	Mount the option card to the drive correctly.

Code	Name	Cause	Possible Solution
		The option card is damaged.	If the alarm continues even after wiring has been corrected, replace the option card.
Note: <ul style="list-style-type: none"> • Detected if the Run command or frequency reference is assigned to the option card. • If detected, $H2-xx = 10$ [MFDO Function Select = Minor Fault] will be ON. • If detected, the drive will operate the motor according to the stop method set in $F6-01$ [Communication Error Selection]. 			
Code	Name	Cause	Possible Solution
CALL	Serial Comm Transmission Error	The communications cable wiring is incorrect.	Correct any wiring errors.
		There is a short circuit or disconnection in the communications cable.	<ul style="list-style-type: none"> • Repair disconnected cables and short circuits for proper wiring. • Replace a faulty communications cable with a normal one.
		Programming error occurred on the controller side.	Check communications at start-up and correct programming errors.
		Communications circuitry is damaged.	<ul style="list-style-type: none"> • Perform a self-diagnostics check. • If the problem continues, replace either the control board or the entire drive. For instructions on replacing the control board, contact Yaskawa or your nearest sales representative.
		Termination resistor setting for MEMOBUS/Modbus communications is incorrect.	Enable the termination resistor in the last drive in a MEMOBUS/Modbus network by setting DIP switch S2 to the ON position.
Note: <ul style="list-style-type: none"> • Detected if control data cannot be received from the controller correctly when energizing the drive. • If detected, $H2-xx = 10$ [MFDO Function Select = Minor Fault] will be ON. 			
Code	Name	Cause	Possible Solution
CE	MEMOBUS/Modbus Communication Err	The communications cable wiring is incorrect.	Correct any wiring errors.
		There is a short circuit or disconnection in the communications cable.	<ul style="list-style-type: none"> • Repair disconnected cables and short circuits for proper wiring. • Replace a faulty communications cable with a normal one.
		Communication data error occurred due to noise.	<ul style="list-style-type: none"> • Check the control circuit lines, main circuit lines, and ground wiring, and minimize the effects of noise. • Check whether an electromagnetic contactor is the noise source, and use Surge Protective Device if necessary. • Use only recommended cables or other shielded line. Ground the shield on the controller side or the drive input power side. • Separate all communication wiring from drive power lines, and install a noise filter to the input side of the power supply for communication. • Minimize the effects of controller noise.
		Communication protocol is incompatible.	<ul style="list-style-type: none"> • Check the values set in $H5-xx$. • Check the settings on the controller side and correct the difference in communication conditions.
		The time set in $H5-09$ is too short for the communications cycle.	<ul style="list-style-type: none"> • Change the controller software settings. • Lengthen the time set in $H5-09$.
		Something in the controller software or hardware is causing a communication problem.	Check the controller and remove the cause of the error.
Note: <ul style="list-style-type: none"> • Detected if control data was not received correctly for the CE detection time set to $H5-09$ [CE Detection Time]. • If detected, $H2-xx = 10$ [MFDO Function Select = Minor Fault] will be ON. • If detected, the drive will operate the motor according to the stop method set in $H5-04$ [Stopping Method after Com Error]. 			

6.5 Minor Faults/Alarms

Code	Name	Cause	Possible Solution
CrST	Cannot Reset	Fault reset was input when a Run command was active.	Turn off the Run command that was entered from the drive's control circuit terminal or communication option card, and the reset the drive.
Note: If detected, $H2-xx = 10$ [MFDO Function Select = Minor Fault] will be ON.			
Code	Name	Cause	Possible Solution
CyC	MECHATROLINK CommCycleSettingErr	The communications cycle of the controller was set outside the allowable range of the MECHATROLINK interface option card.	Set the communications cycle of the controller so that it falls within the allowable range of the MECHATROLINK interface option card.
Note: If detected, $H2-xx = 10$ [MFDO Function Select = Minor Fault] will be ON.			
Code	Name	Cause	Possible Solution
dEv	Speed Deviation	The load is too heavy.	Reduce the load.
		Acceleration and deceleration times are set too short.	Increase the value set in $C1-01$ to $C1-08$ [Acceleration/Deceleration Time].
		The dEv detection level settings are inappropriate.	Adjust $F1-10$ and $F1-11$.
		The load is locked up.	Check the machine.
		The holding brake is being applied to the motor.	Release the holding brake.
Note: <ul style="list-style-type: none"> Detected if the deviation between the detected speed and the speed reference is greater than the setting in $F1-10$ [Speed Deviation Detection Level] for longer than $F1-11$ [Speed Deviation Detect DelayTime]. If detected, $H2-xx = 10$ [MFDO Function Select = Minor Fault] will be ON. If detected, the drive will operate the motor according to the stop method set in $F1-04$ [Operation Selection at Deviation]. 			
Code	Name	Cause	Possible Solution
dnE	Drive Disabled	A terminal for which $H1-xx = 6A$ [Drive Enable] had been set was switched OFF.	Reevaluate the operation sequence.
Note: If detected, $H2-xx = 10$ [MFDO Function Select = Minor Fault] will be ON.			
Code	Name	Cause	Possible Solution
dWA2	DriveWorksEZ Fault 2	The DriveWorksEZ program output a minor fault.	Check the DriveWorksEZ program and remove the cause of the fault. This is not a drive fault.
Note: If detected, $H2-xx = 10$ [MFDO Function Select = Minor Fault] will be ON.			
Code	Name	Cause	Possible Solution
dWA3	DriveWorksEZ Fault 3	The DriveWorksEZ program output a minor fault.	Check the DriveWorksEZ program and remove the cause of the fault. This is not a drive fault.
Note: If detected, $H2-xx = 10$ [MFDO Function Select = Minor Fault] will be ON.			
Code	Name	Cause	Possible Solution
dWAL	DriveWorksEZ Fault	The DriveWorksEZ program output a minor fault.	Check the DriveWorksEZ program and remove the cause of the fault. This is not a drive fault.
Note: If detected, $H2-xx = 10$ [MFDO Function Select = Minor Fault] will be ON.			

Code	Name	Cause	Possible Solution
E5	MECHATROLINK Watchdog Timer Err	A watchdog circuit exception was detected while receiving data from the controller.	Check the MECHATROLINK cable connection. If this error occurs frequently, check the wiring and minimize the effects of noise in accordance with the following manuals: <ul style="list-style-type: none"> MECHATROLINK-II Installation Guide (MECHATROLINK Members Association, manual number MMATDEP011) MECHATROLINK-III Installation Manual (MECHATROLINK Members Association, publication number MMATDEP018)
Note: <ul style="list-style-type: none"> If detected, $H2-xx = 10$ [MFDO Function Select = Minor Fault] will be ON. If detected, the drive will operate the motor according to the stop method set in F6-25 [MECHATROLINK Watchdog Error Sel]. 			
Code	Name	Cause	Possible Solution
EF	FWD/REV Run Command Input Error	A forward command and a reverse command were input simultaneously for longer than 500 ms.	Check the sequence and confirm that the forward and reverse inputs are not set simultaneously.
Note: <ul style="list-style-type: none"> The motor ramps to stop when EF is detected. If detected, $H2-xx = 10$ [MFDO Function Select = Minor Fault] will be ON. 			
Code	Name	Cause	Possible Solution
EF0	Option Card External Fault	The communication option card received an external fault from the controller.	<ol style="list-style-type: none"> Identify the device that triggered the external faults and remove the cause. Clear the external fault input from the controller.
		Programming error occurred on the controller side.	Check the operation of the controller program.
Note: <ul style="list-style-type: none"> Detected if the alarm function on the external device side is being operated. If detected, $H2-xx = 10$ [MFDO Function Select = Minor Fault] will be ON. If detected, the drive will operate the motor according to the stop method set in F6-03 [Comm External Fault (EF0) Select]. 			
Code	Name	Cause	Possible Solution
EF1	External Fault (terminal S1)	The multi-function digital input terminal S1 triggered an external fault via an external device.	<ol style="list-style-type: none"> Identify the device that triggered the external faults and remove the cause. Clear the external fault input in the multi-function digital input.
		The wiring is incorrect.	Connect the signal line to multi-function digital input terminal S1 properly.
		External fault [H1-01 = 2C to 2F] is assigned to MFDI terminal S1 that is not in use.	Set the multi-function digital input properly.
Note: <ul style="list-style-type: none"> If detected, $H2-xx = 10$ [MFDO Function Select = Minor Fault] will be ON. 			
Code	Name	Cause	Possible Solution
EF2	External Fault (terminal S2)	The multi-function digital input terminal S2 triggered an external fault via an external device.	<ol style="list-style-type: none"> Identify the device that triggered the external faults and remove the cause. Clear the external fault input in the multi-function digital input.
		The wiring is incorrect.	Connect the signal line to multi-function digital input terminal S2 properly.
		External fault [H1-02 = 2C to 2F] is assigned to MFDI terminal S2 that is not in use.	Set the multi-function digital input properly.
Note: <ul style="list-style-type: none"> If detected, $H2-xx = 10$ [MFDO Function Select = Minor Fault] will be ON. 			

6.5 Minor Faults/Alarms

Code	Name	Cause	Possible Solution
EF3	External Fault (terminal S3)	The multi-function digital input terminal S3 triggered an external fault via an external device.	1. Identify the device that triggered the external faults and remove the cause. 2. Clear the external fault input in the multi-function digital input.
		The wiring is incorrect.	Connect the signal line to multi-function digital input terminal S3 properly.
		<i>External fault [H1-03 = 2C to 2F] is assigned to MFDI terminal S3 that is not in use.</i>	Set the multi-function digital input properly.
Note: If detected, H2-xx = 10 [MFDO Function Select = Minor Fault] will be ON.			
Code	Name	Cause	Possible Solution
EF4	External Fault (terminal S4)	The multi-function digital input terminal S4 triggered an external fault via an external device.	1. Identify the device that triggered the external faults and remove the cause. 2. Clear the external fault input in the multi-function digital input.
		The wiring is incorrect.	Connect the signal line to multi-function digital input terminal S4 properly.
		<i>External fault [H1-04 = 2C to 2F] is assigned to MFDI terminal S4 that is not in use.</i>	Set the multi-function digital input properly.
Note: If detected, H2-xx = 10 [MFDO Function Select = Minor Fault] will be ON.			
Code	Name	Cause	Possible Solution
EF5	External Fault (terminal S5)	The multi-function digital input terminal S5 triggered an external fault via an external device.	1. Identify the device that triggered the external faults and remove the cause. 2. Clear the external fault input in the multi-function digital input.
		The wiring is incorrect.	Connect the signal line to multi-function digital input terminal S5 properly.
		<i>External fault [H1-05 = 2C to 2F] is assigned to MFDI terminal S5 that is not in use.</i>	Set the multi-function digital input properly.
Note: If detected, H2-xx = 10 [MFDO Function Select = Minor Fault] will be ON.			
Code	Name	Cause	Possible Solution
EF6	External Fault (terminal S6)	The multi-function digital input terminal S6 triggered an external fault via an external device.	1. Identify the device that triggered the external faults and remove the cause. 2. Clear the external fault input in the multi-function digital input.
		The wiring is incorrect.	Connect the signal line to multi-function digital input terminal S6 properly.
		<i>External fault [H1-06 = 2C to 2F] is assigned to MFDI terminal S6 that is not in use.</i>	Set the multi-function digital input properly.
Note: If detected, H2-xx = 10 [MFDO Function Select = Minor Fault] will be ON.			
Code	Name	Cause	Possible Solution
EF7	External Fault (terminal S7)	The multi-function digital input terminal S7 triggered an external fault via an external device.	1. Identify the device that triggered the external faults and remove the cause. 2. Clear the external fault input in the multi-function digital input.
		The wiring is incorrect.	Connect the signal line to multi-function digital input terminal S7 properly.
		<i>External fault [H1-07 = 2C to 2F] is assigned to MFDI terminal S7 that is not in use.</i>	Set the multi-function digital input properly.
Note: If detected, H2-xx = 10 [MFDO Function Select = Minor Fault] will be ON.			

Code	Name	Cause	Possible Solution
EF8	External Fault (terminal S8)	The multi-function digital input terminal S8 triggered an external fault via an external device.	<ol style="list-style-type: none"> Identify the device that triggered the external faults and remove the cause. Clear the external fault input in the multi-function digital input.
		The wiring is incorrect.	Connect the signal line to multi-function digital input terminal S8 properly.
		<i>External fault [H1-08 = 2C to 2F] is assigned to MFDI terminal S8 that is not in use.</i>	Set the multi-function digital input properly.
Note: If detected, <i>H2-xx = 10 [MFDO Function Select = Minor Fault]</i> will be ON.			
Code	Name	Cause	Possible Solution
EP24v	External Power 24V Supply	The voltage of the main circuit power supply dropped, and power is being supplied to the drive from the external 24 V power supply.	<ul style="list-style-type: none"> Check the main circuit power supply. To run the drive, switch on the main circuit power supply.
Note: A minor fault signal will not be output even if the drive detects this alarm.			
Code	Name	Cause	Possible Solution
FAn	Internal Fan Fault	The circulation fan has malfunctioned.	<ul style="list-style-type: none"> Check for circulation fan operation. Restart the drive and check if the fault still remains. Check <i>U4-03 [Cooling Fan Ope Time]</i> and <i>U4-04 [Cool Fan Maintenance]</i>. If the circulation fan has exceeded its expected performance life or is damaged in any other way, follow the replacement instructions in this manual.
		A fault detected in the power supply of the electromagnetic contactor and the circulation fan.	<ul style="list-style-type: none"> Re-energize the drive and check if the fault still remains. Replace either the control board or the entire drive if the fault continues. For instructions on replacing the control board, contact Yaskawa or your nearest sales representative.
Note: If detected, <i>H2-xx = 10 [MFDO Function Select = Minor Fault]</i> will be ON.			
Code	Name	Cause	Possible Solution
FbH	Excessive PID Feedback	The <i>FbH</i> detection level has not been set appropriately.	Adjust <i>b5-36</i> and <i>b5-37</i> .
		The PID feedback wiring is faulty.	Correct any PID control wiring errors.
		Feedback sensor has malfunctioned.	Check the state of the sensors on the control device side.
		A fault occurred in the feedback input circuit of the drive.	Replace the board or the entire drive. For instructions on replacing the control board, contact Yaskawa or your nearest sales representative.
Note: <ul style="list-style-type: none"> Detected if PID feedback input has exceeded the level set in <i>b5-36 [PID Feedback High Detection Lvl]</i> for longer than <i>b5-37 [PID Feedback High Detection Time]</i>. If detected, <i>H2-xx = 10 [MFDO Function Select = Minor Fault]</i> will be ON. If detected, the drive will operate the motor according to the stop method set in <i>b5-12 [Feedback Loss Detection Select]</i>. 			
Code	Name	Cause	Possible Solution
FbL	PID Feedback Loss	The <i>FbL</i> detection level has not been set appropriately.	Adjust <i>b5-13</i> and <i>b5-14</i> .
		The PID feedback wiring is faulty.	Correct any PID control wiring errors.
		Feedback sensor has malfunctioned.	Check the state of the sensors on the control device side.

6.5 Minor Faults/Alarms

Code	Name	Cause	Possible Solution
		A fault occurred in the feedback input circuit of the drive.	Replace the board or the entire drive. For instructions on replacing the control board, contact Yaskawa or your nearest sales representative.
<p>Note:</p> <ul style="list-style-type: none"> • Detected if PID feedback input is lower than the level set in <i>b5-13 [PID Feedback Loss Detection Lvl]</i> for longer than <i>b5-14 [PID Feedback Loss Detection Time]</i>. • If detected, <i>H2-xx = 10 [MFDO Function Select = Minor Fault]</i> will be ON. • If detected, the drive will operate the motor according to the stop method set in <i>b5-12 [Feedback Loss Detection Select]</i>. 			
Code	Name	Cause	Possible Solution
HCA	Current Alarm	The load is too heavy.	<ul style="list-style-type: none"> • Reduce the load for applications with repetitive starts and stops. • Replace the drive with a larger capacity model.
		The acceleration/deceleration time is too short.	<ul style="list-style-type: none"> • Calculate the torque necessary during acceleration relative to the load inertia and the specified acceleration time. • Increase the value set in <i>C1-01 to C1-08 [Acceleration/Deceleration Time]</i> until the necessary torque is achieved. • Replace the drive with a larger capacity model.
		The drive is attempting to operate a specialized motor or a motor that exceeds the maximum applicable motor output of the drive.	<ul style="list-style-type: none"> • Check the motor nameplate and reevaluate the motor and drive to ensure that the drive rated current is larger than the motor rated current. • Replace the drive with a larger capacity model.
		The current level increased temporarily due to speed search after a momentary power loss or while attempting to perform Auto Restart.	If a rise in current occurs due to a speed search or Auto Restart, <i>HCA</i> may be temporarily displayed. The alarm will only appear briefly. There is no need to take action to prevent the alarm from occurring in such instances.
<p>Note:</p> <ul style="list-style-type: none"> • Detected if the drive output current exceeded the overcurrent alarm level (150% of the rated current). • If detected, <i>H2-xx = 10 [MFDO Function Select = Minor Fault]</i> will be ON. 			
Code	Name	Cause	Possible Solution
L24v	External Power 24V Supply	The voltage of the external 24 V power supply being used as a backup power supply has dropped. The main circuit power supply is in its normal state.	<ul style="list-style-type: none"> • Check for any wiring errors or disconnected wires in the external 24 V power supply, and fix any problems. • Check for any problems with the external 24 V power supply. • Set <i>o2-23 = 0 [Lost Detection of Ext. Power 24V = Disabled]</i>.
<p>Note:</p> <p>The minor fault signal is not output when a minor fault is detected even after setting <i>o2-23 = 1 [Lost Detection of Ext. Power 24V = Enabled]</i>.</p>			
Code	Name	Cause	Possible Solution
LoG	Log Communication Fault	A micro SD card is not inserted into the keypad.	Insert a micro SD card into the keypad.
		<ul style="list-style-type: none"> • USB connected • The number of log communication files has grown to 1000 or higher. • The capacity of the micro SD card has been exceeded. • Attributes 1 and 2 were written to a file with a log communication file number that does not exist. • The line number data in a log communication file was modified. • A log end command was transmitted despite the fact that the log communication file was closed. 	Set <i>o5-01 = 1 [Log Start/Stop Selection = ON]</i> .
<p>Note:</p> <p>If detected, <i>H2-xx = 10 [MFDO Function Select = Minor Fault]</i> will be ON.</p>			

Code	Name	Cause	Possible Solution
LT-1	Cooling Fan Maintenance Time	The cooling fan has reached 90% of its expected performance life.	<ol style="list-style-type: none"> Follow the description in this manual to replace cooling fan. Set $o4-03 = 0$ [<i>CoolingFan OperationTime Setting = 0 h</i>] to reset the cooling fan operation time.
Note: When the estimated performance life of the cooling fan has elapsed, $H2-xx = 2F$ [<i>MFDO Function Select = Maintenance Period</i>] will be ON.			
Code	Name	Cause	Possible Solution
LT-2	Capacitor Maintenance Time	The main circuit and control circuit capacitors has reached 90% of their expected performance life.	Replace the board or the entire drive. For instructions on replacing the control board, contact Yaskawa or your nearest sales representative.
Note: When the estimated performance life of the cooling fan has elapsed, $H2-xx = 2F$ [<i>MFDO Function Select = Maintenance Period</i>] will be ON.			
Code	Name	Cause	Possible Solution
LT-3	SoftChargeBypassRelay MainteTime	The inrush current prevention relay has reached 90% of its expected performance life.	Replace the board or the entire drive. For instructions on replacing the control board, contact Yaskawa or your nearest sales representative.
Note: When the estimated performance life of the cooling fan has elapsed, $H2-xx = 2F$ [<i>MFDO Function Select = Maintenance Period</i>] will be ON.			
Code	Name	Cause	Possible Solution
LT-4	IGBT Maintenance Time (50%)	IGBTs have reached 50% of their expected performance life.	Check the load, carrier frequency, and output frequency.
Note: When the estimated performance life of the cooling fan has elapsed, $H2-xx = 2F$ [<i>MFDO Function Select = Maintenance Period</i>] will be ON.			
Code	Name	Cause	Possible Solution
oH	Overheat 1 (Heatsink Overheat)	The ambient temperature is too high.	<ul style="list-style-type: none"> Check the ambient temperature. Improve the ventilation within the control panel. Install a cooling device (cooling fan or air conditioner) to lower the ambient temperature. Remove anything near the drive that might be producing excessive heat.
		Airflow around the drive is restricted.	<ul style="list-style-type: none"> Provide proper installation space around the drive as indicated in the manual. Allow for the proper space and ensure that there is sufficient circulation around the control panel. Check for dust or other foreign materials clogging the cooling fan. Clear debris caught in the fan that restricts air circulation.
		Internal cooling fan has stopped.	<ol style="list-style-type: none"> Follow the description in this manual to replace cooling fan. Set $o4-03 = 0$ [<i>CoolingFan OperationTime Setting = 0 h</i>].
Note: <ul style="list-style-type: none"> Detected if the heatsink temperature of the drive exceeds the level set in $L8-02$ [<i>Overheat Alarm Level</i>]. If detected, $H2-xx = 10$ [<i>MFDO Function Select = Minor Fault</i>] will be ON. If detected, the drive will operate the motor according to the stop method set in $L8-03$ [<i>Overheat Pre-Alarm Ope Selection</i>]. 			
Code	Name	Cause	Possible Solution
oH2	Drive Overheat Warning	$oH2$ [<i>Drive Overheat Warning</i>] signal was input from an external device.	<ol style="list-style-type: none"> Identify the external device that output the overheat alarm and take measures to address the problem. Clear the <i>Drive Overheat Alarm (oH2)</i> [$H1-xx = B$] which has been set to multi-function digital input terminals S1 to S8.
Note: If detected, $H2-xx = 10$ [<i>MFDO Function Select = Minor Fault</i>] will be ON.			

6.5 Minor Faults/Alarms

Code	Name	Cause	Possible Solution
oH3	Motor Overheat	The wiring with the thermistor used to detect motor temperature is faulty.	Correct any wiring errors.
		A fault occurred on the machine side. Example: The machine is locked.	Check the condition of the machine and remove the cause of the fault.
		The motor has overheated.	<ul style="list-style-type: none"> Check the load level, acceleration/deceleration time, and motor start/stop frequency (cycle time). Reduce the load. Increase the value set in C1-01 to C1-08 [Acceleration/Deceleration Time]. Set E2-01 [Motor Rated Current (FLA)] correctly to the value that indicated on the motor nameplate. Check whether the motor cooling system is operating normally, and repair or replace it if it is damaged. Adjust E1-04 to E1-10 [V/f Pattern Parameters]. For motor 2, adjust E3-04 to E3-10. In particular, reduce the values set in E1-08 [Mid Point A Voltage] and E1-10 [Minimum Output Voltage]. <p>Note: If E1-08 and E1-10 are reduced too much, the overload tolerance is reduced at low speeds.</p>
<p>Note:</p> <ul style="list-style-type: none"> Detected if the motor overheat signal entered to an analog input terminal A1, A2, or A3 exceeds the alarm detection level. (If H3-02, H3-10, or H3-06 = E [MFAI Function Select = Motor Temperature (PTC input)] has been set.) If detected, H2-xx = 10 [MFDO Function Select = Minor Fault] will be ON. If detected, the drive will operate the motor according to the stop method set in L1-03 [Motor OH Alarm Operation Select]. 			
Code	Name	Cause	Possible Solution
oL3	Overtorque 1	A fault occurred on the machine side. Example: The machine is locked.	Check the condition of the machine and remove the cause of the fault.
		The parameters for load are not appropriate.	Adjust L6-02 and L6-03.
<p>Note:</p> <ul style="list-style-type: none"> Detected if the drive output current exceeded the value set in L6-02 [Torque Detection Level 1] for longer than L6-03 [Torque Detection Time 1]. If detected, H2-xx = 10 [MFDO Function Select = Minor Fault] will be ON. If detected, the drive will operate the motor according to the stop method set in L6-01 [Torque Detection Selection 1]. 			
Code	Name	Cause	Possible Solution
oL4	Overtorque 2	A fault occurred on the machine side. Example: The machine is locked.	Check the condition of the machine and remove the cause of the fault.
		The parameters for load are not appropriate.	Adjust L6-05 and L6-06.
<p>Note:</p> <ul style="list-style-type: none"> Detected if the drive output current exceeded the level set in L6-05 [Torque Detection Level 2] for longer than L6-06 [Torque Detection Time 2]. If detected, H2-xx = 10 [MFDO Function Select = Minor Fault] will be ON. If detected, the drive will operate the motor according to the stop method set in L6-04 [Torque Detection Selection 2]. 			
Code	Name	Cause	Possible Solution
oL5	Mechanical Weakening Detection 1	Overtorque was detected based on the conditions for mechanical weakening detection set in L6-08 [Mechanical Weakening Detect Ope].	Perform deterioration diagnostics on the machine side.
<p>Note:</p> <ul style="list-style-type: none"> If detected, H2-xx = 10 [MFDO Function Select = Minor Fault] will be ON. If detected, the drive will operate the motor according to the stop method set in L6-08 [Mechanical Weakening Detect Ope]. 			

Code	Name	Cause	Possible Solution
oS	Overspeed	Overshoot is occurring.	<ul style="list-style-type: none"> Reduce C5-01 [ASR Proportional Gain 1] and increase C5-02 [ASR Integral Time 1]. Adjust the pulse train gain using the H6-02 to H6-05 [Pulse Train Input Setting Parameters].
		Incorrect number of PG pulses has been set.	Set H6-02 [Pulse Train Input Scaling] to the pulse train frequency during 100% reference (maximum motor rotation speed).
		The oS detection level has not been set appropriately.	Adjust F1-08 and F1-09.
<p>Note:</p> <ul style="list-style-type: none"> Detected if the motor speed exceeded the value set in F1-08 [Overspeed Detection Level] for longer than F1-09 [Overspeed Detection Delay Time]. If detected, H2-xx = 10 [MFDO Function Select = Minor Fault] will be ON. If detected, the drive will operate the motor according to the stop method set in F1-03 [Operation Select at Overspeed]. 			
Code	Name	Cause	Possible Solution
ov	Overvoltage	Surge voltages are entered into input power supply.	Connect a DC reactor to the drive. <p>Note: Within the same power supply system, turning phase advancing capacitors on and off, operating thyristor converters, and the like may apply surge voltages and cause the input voltage to rise abnormally.</p>
		The drive output cable or motor is shorted to ground. (The current short to ground is charging the main circuit capacitor of the drive through the power supply.)	<ol style="list-style-type: none"> Check the motor main circuit cable, terminals, and motor terminal box, and eliminate any ground faults. Restart the drive.
		The power supply voltage is too high.	Lower the power supply voltage so that it matches the drive rated voltage.
		A drive malfunction occurred due to noise.	<ul style="list-style-type: none"> Check the control circuit lines, main circuit lines, and ground wiring, and minimize the effects of noise. Check whether an electromagnetic contactor is the noise source, and use Surge Protective Device if necessary. Set L5-01 $\neq 0$ [Number of Auto Restart Attempts $\neq 0$ times].
<p>Note:</p> <ul style="list-style-type: none"> Detected if the DC bus voltage exceeds the ov detection level when the Run command has not been input (while the drive is stopped). The ov detection level is about 410 V when using a 200 V class drive. For a 400 V class drive, the detection level is around 820 V. If detected, H2-xx = 10 [MFDO Function Select = Minor Fault] will be ON. 			
Code	Name	Cause	Possible Solution
PASS	PASS	The MEMOBUS/Modbus communications test has finished normally.	PASS display will disappear when communications test mode is cleared.
Code	Name	Cause	Possible Solution
PF	Input Phase Loss	Phase loss in the drive input power.	Correct any wiring errors in the main circuit drive input power.
		Loose wiring in the input power terminals.	Properly tighten the terminals according to the specified tightening torque.
		Excessive fluctuation in the drive input power voltage.	Check the voltage from the drive input power and review the possible solutions for stabilizing the drive input power.
		Poor balance between voltage phases.	<ul style="list-style-type: none"> Check the voltage from the drive input power and review the possible solutions for stabilizing the drive input power. Disable input phase loss detection.

6.5 Minor Faults/Alarms

Code	Name	Cause	Possible Solution
		The main circuit capacitors are worn.	<p>Check U4-05 [Capacitor Maintenance], and perform maintenance on the drive if its value exceeds 90%.</p> <ul style="list-style-type: none"> • Check for any problems with the input power. • The alarm occurs frequently despite there being no problem with the power supply, replace the board or the drive. For more information on replacing the control board, contact Yaskawa or your nearest sales representative.
<p>Note:</p> <ul style="list-style-type: none"> • Detected if the DC bus voltage fluctuates abnormally while the motor is stopped. (Detected when L8-05 = 1 [Input Phase Loss Protect Select = Enabled] is set) • If detected, H2-xx = 10 [MFDO Function Select = Minor Fault] will be ON. • Use L8-05 [Input Phase Loss Protect Select] to enable/disable PF detection. 			
Code	Name	Cause	Possible Solution
PGo	PG Disconnect	The encoder cable is improperly wired or disconnected.	Check for any wiring errors or disconnected wires in the encoder cable, and fix any problems.
		Power supply is not being supplied to the encoder.	Check the encoder power supply.
		The holding brake is being applied to the motor.	Release the holding brake.
<p>Note:</p> <ul style="list-style-type: none"> • Detected if no PG pulses for speed detection are received for a time longer than setting in F1-14 [PG Open-Circuit Detection Time]. • If detected, H2-xx = 10 [MFDO Function Select = Minor Fault] will be ON. • If detected, the drive will operate the motor according to the stop method set in F1-02 [PG Feedback Loss Selection]. 			
Code	Name	Cause	Possible Solution
PGoH	PG Hardware Fault	The encoder cable is disconnected.	Correct any disconnected wires in the encoder cable.
<p>Note:</p> <ul style="list-style-type: none"> • If detected, H2-xx = 10 [MFDO Function Select = Minor Fault] will be ON. • If detected, the drive will operate the motor according to the stop method set in F1-02 [PG Feedback Loss Selection]. 			
Code	Name	Cause	Possible Solution
rUn	Motor Switch during Run	Motor 2 Selection [H1-xx = 16] was input during run.	Review the sequence to ensure that Motor 2 Selection is input while the drive is stopped.
<p>Note:</p> <p>If detected, H2-xx = 10 [MFDO Function Select = Minor Fault] will be ON.</p>			
Code	Name	Cause	Possible Solution
SE	MEMOBUS/Modbus Comm TestMode Err	The MEMOBUS/Modbus communications self-diagnostics [H1-xx = 67] were executed while the drive was running.	Stop the drive and perform the MEMOBUS/Modbus communications self-diagnostics.
<p>Note:</p> <p>If detected, H2-xx = 10 [MFDO Function Select = Minor Fault] will be ON.</p>			
Code	Name	Cause	Possible Solution
STo	Safe Torque OFF	Both Safe Disable inputs H1-HC and H2-HC are open.	<ul style="list-style-type: none"> • Check whether the Safe Disable signal is input from an external source to terminal H1-HC or H2-HC. • Link terminals HC, H1, and H2 if the Safe Disable function does not disable the drive or is not used.
		Both two Safe Disable channels are internally damaged.	Replace the board or the entire drive. For instructions on replacing the control board, contact Yaskawa or your nearest sales representative.
<p>Note:</p> <ul style="list-style-type: none"> • If detected, H2-xx = 10 [MFDO Function Select = Minor Fault] will be ON. • If detected, the drive will operate the motor according to the stop method set in b5-12 [Feedback Loss Detection Select]. 			

Code	Name	Cause	Possible Solution
SToF	Safe Torque OFF	The Safe Disable input signal was input to terminal H1-HC or H2-HC but not both.	<ul style="list-style-type: none"> Check whether the Safe Disable signal is input from an external source to terminal H1-HC or H2-HC. If the Safe Disable input function is not to be used, insert wire jumpers across the terminals H1-HC and H2-HC.
		The Safe Disable input signal is wired incorrectly.	
		One Safe Disable channel is internally damaged.	Replace the board or the entire drive. For instructions on replacing the control board, contact Yaskawa or your nearest sales representative.
Note: If detected, H2-xx = 10 [MFDO Function Select = Minor Fault] will be ON.			
Code	Name	Cause	Possible Solution
TrPC	IGBT Maintenance Time (90%)	IGBTs have reached 90% of their expected performance life.	Replace the IGBT or the entire drive. For instructions on replacing the control board, contact Yaskawa or your nearest sales representative.
Note: If detected, H2-xx = 10 [MFDO Function Select = Minor Fault] will be ON.			
Code	Name	Cause	Possible Solution
UL3	Undertorque Detection 1	A fault occurred on the machine side. Example: The pulley belt has broken.	Check the condition of the machine and remove the cause of the fault.
		The parameters for load are not appropriate.	Adjust L6-02 and L6-03.
Note: <ul style="list-style-type: none"> Detected if the drive output current remains below the level set in L6-02 [Torque Detection Level 1] for longer than L6-03 [Torque Detection Time 1]. If detected, H2-xx = 10 [MFDO Function Select = Minor Fault] will be ON. If detected, the drive will operate the motor according to the stop method set in L6-01 [Torque Detection Selection 1]. 			
Code	Name	Cause	Possible Solution
UL4	Undertorque Detection 2	A fault occurred on the machine side. Example: The pulley belt has broken.	Check the condition of the machine and remove the cause of the fault.
		The parameters for load are not appropriate.	Adjust L6-05 and L6-06.
Note: <ul style="list-style-type: none"> Detected if the drive output current remains below the level set in L6-05 [Torque Detection Level 2] for longer than L6-06 [Torque Detection Time 2]. If detected, H2-xx = 10 [MFDO Function Select = Minor Fault] will be ON. If detected, the drive will operate the motor according to the stop method set in L6-04 [Torque Detection Selection 2]. 			
Code	Name	Cause	Possible Solution
UL5	Mechanical Weakening Detection 2	Undertorque was detected based on the conditions for mechanical weakening detection set in L6-08 [Mechanical Weakening Detect Ope].	Check whether the machine exhibits any deterioration.
Note: <ul style="list-style-type: none"> If detected, H2-xx = 10 [MFDO Function Select = Minor Fault] will be ON. If detected, the drive will operate the motor according to the stop method set in L6-08 [Mechanical Weakening Detect Ope]. 			
Code	Name	Cause	Possible Solution
Uv	DC Bus Undervoltage	Excessive fluctuation in the drive input power voltage.	<ul style="list-style-type: none"> Review the possible solutions for stabilizing the drive input power. Take steps to stabilize the power supply. Check for any problems with the magnetic contactor on the main circuit side if no problems are found with the power supply.
		Phase loss in the drive input power.	Correct any wiring errors in the main circuit drive input power.
		There is loose wiring in the drive input power terminals.	Properly tighten the terminals according to the specified tightening torque.
		Power loss occurred.	Improve the power supply.

6.5 Minor Faults/Alarms

Code	Name	Cause	Possible Solution
		The main circuit capacitors are worn.	Check the capacitor maintenance period in <i>U4-05 [Capacitor Maintenance]</i> . If <i>U4-05</i> exceeds 90%, replace the control board or the entire drive. For more information on replacing the control board, contact Yaskawa or your nearest sales representative.
		The drive input power transformer is too small and voltage drops when the power is switched on.	<ul style="list-style-type: none"> • Check for an alarm when a molded-case circuit breaker, Leakage Breaker (ELCB, GFCI, or RCM/RCD) (with overcurrent protective function), or electromagnetic contactor is ON. • Check the capacity of the drive power supply transformer.
		Air inside the drive is too hot.	Check the ambient temperature of the drive.
		The Charge LED is broken.	Replace the board or the entire drive. For instructions on replacing the control board, contact Yaskawa or your nearest sales representative.
<p>Note:</p> <ul style="list-style-type: none"> • Detected if one of the following situations was true when the drive was stopped or when the Run command was not entered: <ul style="list-style-type: none"> –The DC bus voltage dropped below the value set in <i>L2-05 [Undervoltage Detect Level (Uv1)]</i>. –Contactor for restraining inrush current in the drive was opened. –Low voltage in the control drive input power.. • If detected, <i>H2-xx = 10 [MFDO Function Select = Minor Fault]</i> will be ON. 			

6.6 Parameter Setting Errors

Parameter setting errors occur when multiple parameter settings conflict, or parameter setting values are not appropriate. Referring to the following table, check the parameter setting that caused the error and remove the cause of the error. The drive will not run until the parameters that caused the error are corrected. In addition, notification signals for the faults and alarms will not be output even if these errors occur.

Code	Name	Cause	Possible Solution
oPE01	Thermistor Disconnect	The value set in <i>o2-04 [Drive Model Selection]</i> does not match the actual drive model.	Set <i>o2-04</i> correctly.
Code	Name	Cause	Possible Solution
oPE02	Parameter Range Setting Error	Parameters were set outside the possible setting range.	<ol style="list-style-type: none"> Press  to display <i>U1-18 [oPE Fault Parameter]</i>, and find parameters set outside the setting range. Correct the parameter settings. <p>Note: If multiple errors occur simultaneously, other <i>oPExx</i> errors are given precedence over <i>oPE02</i>.</p>
		Set $E2-01 \leq E2-03$ [<i>Motor Rated Current (FLA) ≤ Motor No-Load Current</i>].	<p>Make sure that $E2-01 > E2-03$.</p> <p>Note: If it is necessary to set $E2-01 < E2-03$, first lower the value set in <i>E2-03</i>, and subsequently set <i>E2-01</i> as needed.</p>
Code	Name	Cause	Possible Solution
oPE03	Multi-Function Input Setting Err	A contradictory setting is assigned to multi-function digital inputs <i>H1-01</i> to <i>H1-08</i> .	Correct the parameter settings.
		The settings for the standby mode function are contradicting in the following way: <ul style="list-style-type: none"> $b8-50 = 0$ [<i>Standby mode selection = Disabled</i>] and $H2-xx = 65$ [<i>MFDO Function Select = Standby output</i>] $b8-50 = 1$ [<i>Enabled</i>] and $H2-xx \neq 65$ 	Correct the parameter settings.
		The settings for multi-function digital input overlap. <p>Note: Excludes $H1-xx = 20$ to $2F$ [<i>External fault</i>] and [<i>Reserved</i>].</p>	Set the parameters correctly so that the functions assigned to multi-function digital input do not overlap.
		The following two functions are not set to <i>H1-xx</i> [<i>MFDI Function Select</i>] simultaneously: <ul style="list-style-type: none"> Setting values <i>10</i> [<i>Up Command</i>] and <i>11</i> [<i>Down Command</i>] Setting values <i>75</i> [<i>Up 2 Command</i>] and <i>76</i> [<i>Down 2 Command</i>] Setting values <i>42</i> [<i>Run Command (2-Wire Sequence 2)</i>] and <i>43</i> [<i>FWD/REV Command (2-Wire Seq 2)</i>] 	Assign the remaining multi-function digital input.
		Two or more of the following function combinations are assigned to <i>H1-xx</i> [<i>MFDI Function Select</i>] simultaneously. <ul style="list-style-type: none"> Setting values <i>10</i> [<i>Up Command</i>] and <i>11</i> [<i>Down Command</i>] Setting values <i>75</i> [<i>Up 2 Command</i>] and <i>76</i> [<i>Down 2 Command</i>] Setting value <i>A</i> [<i>Accel/Decel Ramp Hold</i>] Setting value <i>1E</i> [<i>Reference sample hold</i>] Setting values <i>44</i> to <i>46</i> [<i>Offset Frequency</i>] 	Remove the function assignments that will not be used.

6.6 Parameter Setting Errors

Code	Name	Cause	Possible Solution
		<p>PID control and Up/Down command are enabled simultaneously.</p> <ul style="list-style-type: none"> • <i>b5-01 [PID Function Setting]</i> • <i>H1-xx = 10 [Up Command]</i> and <i>H1-xx = 11 [Down Command]</i> 	<ul style="list-style-type: none"> • Set <i>b5-01 = 0 [PID Function Setting = Disabled]</i>. • Remove the function Up/Down command assignments.
		<p>The following commands are set in H1-xx [MFDI Function Select] simultaneously:</p> <ul style="list-style-type: none"> • Setting values <i>61 [External Speed Search command 1]</i> and <i>62 [External Speed Search command 2]</i> • Setting values <i>65, 66, 7A, 7B [KEB Ride-Thru 1/2]</i> and <i>68 [High Slip Braking (HSB)]</i> • Setting values <i>16 [Motor 2 Selection]</i> and <i>1A [Accel/Decel Time Selection 2]</i> • Setting values <i>65, 66 [KEB Ride-Thru 1]</i> and <i>7A, 7B [KEB Ride-Thru 2]</i> • Setting values <i>40, 41 [Forward Run Command (2-Wire Seq), Reverse Run Command (2-Wire Seq)]</i> and <i>42, 43 [Run Command (2-Wire Sequence 2), FWD/REV Command (2-Wire Seq 2)]</i> • Setting values <i>60 [DC Injection Braking command]</i> and <i>6A [Drive Enable]</i> • Setting values <i>16 [Motor 2 Selection]</i> and <i>75, 76 [Up 2 Command, Down 2 Command]</i> 	Remove the function assignments that will not be used.
		<p>Settings for N.C. and N.O. input [H1-xx] for the following functions were selected simultaneously:</p> <ul style="list-style-type: none"> • Setting value <i>15 [Fast Stop (N.O.)]</i> • Setting value <i>17 [Fast Stop (N.C.)]</i> 	Remove one of the function assignments.
		<p>The following settings were entered while <i>H1-xx = 2 [External Reference 1/2 Selection]</i>:</p> <ul style="list-style-type: none"> • <i>b1-15 = 4 [Frequency Reference Selection 2 = Pulse Train Input]</i> • <i>H6-01 ≠ 0 [PulseTrain InTerm RP Func Select ≠ Frequency reference]</i> 	Set <i>H6-01 = 0</i> .
		<p>The following settings were entered while <i>H1-xx = 2 [External Reference 1/2 Selection]</i>:</p> <ul style="list-style-type: none"> • <i>b1-15 = 3 [Frequency Reference Selection 2 = Option PCB]</i> or <i>b1-16 = 3 [Run Command Selection 2 = Option PCB]</i> • No option card is connected to the drive. 	Connect an input option card to the drive.
		<p>The following settings were entered while <i>H1-xx = 2 [External Reference 1/2 Selection]</i>:</p> <ul style="list-style-type: none"> • <i>b1-15 = 1 [Frequency Reference Selection 2 = Analog Input]</i> • <i>H3-02 ≠ 0 [Terminal A1 Function Selection ≠ Frequency Bias]</i> or <i>H3-10 ≠ 0 [Terminal A2 Function Selection ≠ Frequency Bias]</i> 	Set <i>H3-02 = 0</i> or <i>H3-10 = 0</i> .
		<p>The following parameters are set simultaneously:</p> <ul style="list-style-type: none"> • <i>H1-xx ≠ 6A [Drive Enable]</i> • <i>H2-xx = 38 [Drive Enabled]</i> 	Correct the parameter settings.

Code	Name	Cause	Possible Solution
		The following parameters are set simultaneously: <ul style="list-style-type: none"> • $H6-01 \neq 3$ [PG Feedback] • $H1-xx = 7E$ [FWD/REV Detect (V/f w/ simplePG)] 	Correct the parameter settings.
		The following parameters are set simultaneously: <ul style="list-style-type: none"> • $H1-xx = 75/76$ [Up/Down 2 Command] • $H3-01, H3-05, H3-09 = 1$ [Terminal A1, A2, A3 Signal Level Select = 0-10V (BipolRef)] 	Remove one of the function assignments.
		The settings are contradictory in the following way: <ul style="list-style-type: none"> • A PG-RT3 is attached to the drive. • $H1-xx = 16$ [Motor 2 Selection] has been set. 	Correct the parameter settings. Note: Motor Switch function is not available when using the PG-RT3..
Code	Name	Cause	Possible Solution
oPE05	Run Cmd/Freq Ref Source Sel Err	The setting to assign the Run command or frequency reference to an option card or the pulse train input is incorrect.	Correct the parameter settings.
		Parameter $b1-01 = 3$ [Frequency Reference Selection 1 = Option PCB] has been set, but an option card is not connected to the drive.	Connect an option card to the drive.
		Parameter $b1-02 = 3$ [Run Command Selection 1 = Option PCB] has been set, but an option card is not connected to the drive.	
		The following parameters are set simultaneously: <ul style="list-style-type: none"> • $b1-01 = 4$ [Pulse Train Input] • $H6-01 \neq 0$ [PulseTrain InTerm RP Func Select \neq Frequency reference] 	Set $H6-01 = 0$.
		The following parameters are set simultaneously: <ul style="list-style-type: none"> • $F3-01 = 6$ [Digital Input Function Selection = BCD (5-digit), 0.01 Hz] • $F3-03 = 0, 1$ [DI Data Length Selection = 8bit, 12bit] 	Set $F3-03 = 2$ [16bit].
		The following parameters have been set while the A1-A3 option card is installed: <ul style="list-style-type: none"> • $H1-xx = 2$ [External Reference 1/2 Selection] • $b1-15 = 3$ [Frequency Reference Selection 2 = Option PCB] • $F2-01 = 0$ [Analog Input Function Selection = 3 channel individual] 	Correct the parameter settings.
Code	Name	Cause	Possible Solution
oPE06	Control Method Selection Error	$A1-02 = 1, 3, \text{ or } 7$ [Control Method Selection = CL-V/f, CLV, CLV/PM] has been set, but a PG option card is not connected to the drive.	<ul style="list-style-type: none"> • Connect a PG option card to the drive. • Set $A1-02$ correctly.

6.6 Parameter Setting Errors

Code	Name	Cause	Possible Solution
oPE07	MF Analog Input Selection Error	The settings for <i>H3-02</i> , <i>H3-06</i> , and <i>H3-10</i> [<i>MFAI Function Select</i>] overlap.	Change the settings to <i>H3-02</i> , <i>H3-06</i> , and <i>H3-10</i> so that the functions assigned to them no longer overlap. Note: The following functions can be set to multiple analog input terminals simultaneously: • Setting value 0 [<i>Frequency Bias</i>] • Setting values <i>F</i> and <i>1F</i> [<i>Through Mode</i>]
		The following parameters are set simultaneously: • <i>H3-02</i> , <i>H3-06</i> , <i>H3-10</i> = <i>B</i> [<i>PID Feedback</i>] • <i>H6-01</i> = 1 [<i>PulseTrain InTerm RP Func Select = PID feedback value</i>]	Remove the function assignments that will not be used.
		The following parameters are set simultaneously: • <i>H3-02</i> , <i>H3-06</i> , <i>H3-10</i> = <i>C</i> [<i>MFAI Function Select = PID Setpoint</i>] • <i>H6-01</i> = 2 [<i>PulseTrain InTerm RP Func Select = PID setpoint value</i>]	
		The following parameters are set simultaneously: • <i>H3-02</i> , <i>H3-06</i> , <i>H3-10</i> = <i>C</i> [<i>MFAI Function Select = PID Setpoint</i>] • <i>b5-18</i> = 1 [<i>PID Setpoint Selection = Enabled</i>]	
		The following parameters are set simultaneously: • <i>H6-01</i> = 2 [<i>PulseTrain InTerm RP Func Select = PID setpoint value</i>] • <i>b5-18</i> = 1 [<i>PID Setpoint Selection = Enabled</i>]	
Code	Name	Cause	Possible Solution
oPE08	Parameter Selection Error	A function was set that cannot be used in the control method selected in <i>A1-02</i> .	1. Press  to display <i>U1-18</i> [<i>oPE Fault Parameter</i>], and find parameters that caused setting errors. 2. Correct the parameter settings. Note: If multiple errors occur simultaneously, other <i>oPExx</i> errors are given precedence over <i>oPE02</i> .
		The following settings were specified in Open Loop Vector Control: • $n2-02 > n2-03$ [<i>SpdFeedbackDetCtr (AFR)TimeConst1 > SpdFeedbackDetCtr (AFR)TimeConst2</i>] • $C4-02 > C4-06$ [<i>Torque Compensation Delay Time > Motor 2 Torque Comp Delay Time</i>]	• Adjust parameter values so that $n2-02 < n2-03$. • Adjust parameter values so that $C4-02 < C4-06$.
		In Open Loop Vector Control for PM, <i>E5-02</i> to <i>E5-07</i> [<i>PM Motor Parameters</i>] = 0 are set.	• Set <i>E5-01</i> [<i>PM Motor Code Selection</i>] correctly based on the motor. • In the case of a specialized motor, refer to the test report of the motor and set <i>E5-xx</i> correctly.
		In PM motor control mode, $E5-09 = 0.0$ [<i>PM Back-EMF Vpeak (mV/(rad/s)) = 0.0 mV/(rad/s)</i>] and $E5-24 = 0.0$ [<i>PM Back-EMF L-L Vrms (mV/rpm) = 0.0 mV/min⁻¹</i>] are set.	Set either <i>E5-09</i> or <i>E5-24</i> to the correct value.

Code	Name	Cause	Possible Solution
		In PM motor control, $E5-09 \neq 0$ and $E5-24 \neq 0$ are set.	Set $E5-09 = 0$ or $E5-24 = 0$.
		In Advanced Open Loop Vector Control for PM, $n8-57 = 0$ [<i>High Frequency Injection = Disabled</i>] is set and $E1-09$ [<i>Minimum Output Frequency</i>] is set lower than the lower limit value.	Correct the parameter settings.
Code	Name	Cause	Possible Solution
oPE09	PID Control Selection Fault	The following parameters are set simultaneously: <ul style="list-style-type: none"> $b5-15 \neq 0.0$ [<i>PID Sleep Function Start Level $\neq 0.0$ Hz</i>] $b1-03 = 2, 3$ [<i>Stopping Method Selection = DC Injection Braking to Stop, Coast-to-Stop with Timer</i>] 	<ul style="list-style-type: none"> Set $b5-15 \neq 0.0$. Set $b1-03 = 0, 1$ [<i>Ramp to Stop, Coast to Stop</i>].
		The following parameters are set simultaneously: <ul style="list-style-type: none"> $b5-01 = 1, 2$ [<i>Enabled D=Fdbk, Enabled D=Fdfwd</i>] $d2-02 \neq 0.0$ [<i>Frequency Reference Lower Limit $\neq 0.0\%$</i>] 	Correct the parameter settings.
		The following parameters are set simultaneously: <ul style="list-style-type: none"> $b5-01 = 1, 2$ [<i>Enabled D=Fdbk, Enabled D=Fdfwd</i>] $b5-11 = 1$ [<i>PID Output Reverse Selection = Enabled: Negative lower limit</i>] 	Correct the parameter settings.
		The following parameters are set simultaneously: <ul style="list-style-type: none"> $b5-01 = 3, 4$ [<i>Fref+PID D=Fdbk, Fref+PID D=Fdfwd</i>] $d2-02 \neq 0.0$ 	Correct the parameter settings.
Note: Detected if the PID control function selection is incorrect. (When $b5-01 = 1$ to 4 [<i>PID Function Setting = PID control enabled</i>])			
Code	Name	Cause	Possible Solution
oPE10	V/f Data Setting Error	The parameters that set the V/f pattern do not satisfy the following conditions: <ul style="list-style-type: none"> For motor 1: $E1-09 \leq E1-07 < E1-06 \leq E1-11 \leq E1-04$ [<i>Minimum Output Frequency \leq Mid Point A Frequency $<$ Base Frequency \leq Mid Point B Frequency \leq Maximum Output Frequency</i>] For motor 2: $E3-09 \leq E3-07 < E3-06 \leq E3-11 \leq E3-04$ [<i>Minimum Output Frequency \leq Mid Point A Frequency $<$ Base Frequency \leq Mid Point B Frequency \leq Maximum Output Frequency</i>] 	Set the parameters correctly so that the conditions are satisfied.
Code	Name	Cause	Possible Solution
oPE11	Carrier Frequency Setting Error	The following parameters are set simultaneously: <ul style="list-style-type: none"> $C6-05 > 6$ [<i>Carrier Freq Proportional Gain > 6</i>] $C6-04 > C6-03$ [<i>Carrier Frequency Lower Limit $>$ Carrier Frequency Upper Limit</i>] Note: When $C6-05 < 7$, $C6-04$ becomes disabled. $C6-03$ stays active.	Set $C6-02$ to $C6-05$ correctly.
		$C6-02$ to $C6-05$ were set outside their allowable setting range.	

6.6 Parameter Setting Errors

Code	Name	Cause	Possible Solution
oPE13	Pulse Monitor Selection Error	<i>H6-06 = 101, 102, 105, or 116 [Pulse Train Monitor Selection = Freq Reference, Output Frequency, Motor Speed, Output Freq afterSFS]</i> has not been set when <i>H6-07 = 0 [Pulse Train Monitor Scaling = 0 Hz]</i> .	Set <i>H6-06</i> correctly.
Code	Name	Cause	Possible Solution
oPE15	Torque Control Setting Error	Multiple parameters are simultaneously selecting torque control. <ul style="list-style-type: none"> <i>d5-01 = 1 [Torque Control Selection = Torque Control]</i> <i>H1-xx = 71 [MFDI Function Select = Speed/Torque Control Switch]</i> 	Correct the parameter settings.
		Droop control and Feed Forward control are enabled at the same time as torque control is selected. <ul style="list-style-type: none"> <i>d5-01 = 1 or H1-xx = 71</i> <i>b7-01 ≠ 0.0 [Droop Control Gain ≠ 0.0%] or n5-01 = 1 [Feed Forward Control Selection = Enabled]</i> 	Correct the parameter settings.
		KEB Ride-Thru 2 (N.O., N.C.) is enabled at the same time as torque control is selected. <ul style="list-style-type: none"> <i>d5-01 = 1 or H1-xx = 71</i> <i>H1-xx = 7A [KEB Ride-Thru 2 (N.C.)] or H1-xx = 7b [KEB Ride-Thru 2 (N.O.)]</i> 	Correct the parameter settings.
		Optimal deceleration or overexcitation deceleration 2 is enabled at the same time as torque control is selected. <ul style="list-style-type: none"> <i>d5-01 = 1 or H1-xx = 71</i> <i>L3-04 = 2, 5 [Decel Stall Prevention Selection = Automatic Decel Reduction, Overexcitation/High Flux 2]</i> 	Correct the parameter settings.
Code	Name	Cause	Possible Solution
oPE16	Energy Saving Constants Error	Energy Saving parameters were set outside their allowable setting range.	Ensure that <i>E5-xx</i> is set correctly according to the data on the motor nameplate.
Code	Name	Cause	Possible Solution
oPE18	Online Tuning Param Setting Err	Parameters controlling online tuning are not set correctly. One of the following was set when <i>n6-01 = 2 [Online Tuning Selection = Voltage Adjustm]</i> in Open Loop Vector Control: <ul style="list-style-type: none"> <i>E2-02 [Motor Rated Slip]</i> is set to 30% of the default setting or lower. <i>E2-06 [Motor Leakage Inductance]</i> is set to 50% of the default setting or lower. <i>E2-03 = 0 [Motor No-Load Current = 0 A]</i> has been set. 	Set <i>E2-02</i> , <i>E2-03</i> , and <i>E2-06</i> correctly.
Code	Name	Cause	Possible Solution
oPE20	PG-F3 Setting Error	The value set in <i>F1-01 [PG 1 Pulses Per Revolution]</i> and the number of PG pulses do not match.	<ul style="list-style-type: none"> Check the value set in <i>F1-01</i> and the number of PG pulses being used. Set <i>F1-01</i> correctly.
		The calculation encoder signal frequency at maximum speed exceeded 20 kHz.	Reduce the value set for <i>E1-04 [Maximum Output Frequency]</i> so the output frequency of the encoder does not exceed 20 kHz.

6.7 Auto-Tuning Errors

The following shows errors detected during Auto-Tuning. Auto-Tuning errors are displayed on the keypad and will cause the motor to coast to a stop. Notification signals for the faults and alarms will not be output even if Auto-Tuning errors occur.

Two types of Auto-Tuning errors are displayed: *Endx* and *Erx*.

Endx indicates Auto-Tuning has successfully completed with discrepancies in the calculations. Check the cause of the error and perform Auto-Tuning again after fixing the cause, or set the motor parameters manually. The drive may be used in the application if no cause can be identified despite the existence of an *Endx* error.

Erx indicates that Auto-Tuning has not completed successfully. Check for the cause of the error and perform Auto-Tuning again after fixing the cause.

Code	Name	Cause	Possible Solution
End1	Excessive V/f Setting	The torque reference exceeded 20% during Auto-Tuning or the no-load current measured after Auto-Tuning exceeded 80%.	<ul style="list-style-type: none"> Make sure the input motor nameplate data is correct. Perform Auto-Tuning again and correctly set the data that appears on the motor nameplate. If motor and load can be uncoupled, remove the motor from the machine and perform Rotational Auto-Tuning again. If motor and load cannot be uncoupled, use the measurement results obtained from Auto-Tuning as is.
Code	Name	Cause	Possible Solution
End2	Iron Core Saturation Coefficient	The motor nameplate data entered during Auto-Tuning is incorrect.	<ul style="list-style-type: none"> Make sure the input motor nameplate data is correct. Perform Auto-Tuning again and correctly set the data that appears on the motor nameplate.
		Results from Auto-Tuning were outside the parameter setting range, assigning <i>E2-07</i> or <i>E2-08</i> [<i>Motor Saturation Coefficient 2</i>] to temporary values.	<ul style="list-style-type: none"> Check and correct faulty motor wiring. If motor and load can be uncoupled, remove the motor from the machine and perform Rotational Auto-Tuning again.
Code	Name	Cause	Possible Solution
End3	Rated Current Setting Alarm	The rated current value that was input is incorrect.	Perform Auto-Tuning again and set the correct rated current that printed on the motor nameplate.
Code	Name	Cause	Possible Solution
End4	Adjusted Slip Calculation Error	The Auto-Tuning results were outside the allowable parameter setting range.	<ul style="list-style-type: none"> Make sure the input motor nameplate data is correct. If motor and load can be uncoupled, remove the motor from the machine and perform Rotational Auto-Tuning again. If motor and load cannot be uncoupled, perform Stationary Auto-Tuning 2.
		The motor rated slip measured after Stationary Auto-Tuning were 0.2 Hz or lower.	
		The motor rated slip measured after compensation using <i>E2-08</i> [<i>Motor Saturation Coefficient 2</i>] were outside the allowable range.	
		The secondary resistor measurement results were outside the allowable range.	
Code	Name	Cause	Possible Solution
End5	Resistance Tuning Error	The Auto-Tuning results of the Line-to-Line Resistance were outside the allowable range.	<ul style="list-style-type: none"> Make sure the input motor nameplate data is correct. Check and correct faulty motor wiring.
Code	Name	Cause	Possible Solution
End6	Leakage Inductance Alarm	The Auto-Tuning results were outside the allowable parameter setting range.	Check whether the input motor nameplate data is correct, and perform Auto-Tuning again.
		The setting for <i>A1-02</i> [<i>Control Method Selection</i>] is not appropriate.	<ul style="list-style-type: none"> Check the value set in <i>A1-02</i> [<i>Control Method Selection</i>]. Check whether the input motor nameplate data is correct, and perform Auto-Tuning again.

6.7 Auto-Tuning Errors

Code	Name	Cause	Possible Solution
End7	No-Load Current Alarm	The Auto-Tuning results of the motor no-load current value were outside the allowable range.	Check and correct faulty motor wiring.
		Auto-Tuning results were less than 5% of the motor rated current.	Check whether the input motor nameplate data is correct, and perform Auto-Tuning again.
Code	Name	Cause	Possible Solution
Er-01	Motor Data Error	The motor nameplate data entered during Auto-Tuning is incorrect.	Check whether the motor nameplate data input before Auto-Tuning is correct. Perform Auto-Tuning again and correctly set the data that appears on the motor nameplate.
		The combination of the motor rated power and motor rated current do not match.	<ul style="list-style-type: none"> Check the combination of drive capacity and motor output. Perform Auto-Tuning again, and correctly set the motor rated power and motor rated current.
		The combination of the motor rated current that was entered during Auto-Tuning and <i>E2-03 [Motor No-Load Current]</i> do not match.	<ol style="list-style-type: none"> Check the motor rated current and the no-load current. Set <i>E2-03</i> correctly. Perform Auto-Tuning again, and correctly set the motor rated current.
		The combination of the setting values of Motor Base Frequency and Motor Base Speed do not match.	Perform Auto-Tuning again, and correctly set the Motor Base Frequency and Motor Base Speed.
Code	Name	Cause	Possible Solution
Er-02	Minor Fault	The motor nameplate data entered during Auto-Tuning is incorrect.	<ul style="list-style-type: none"> Check whether the motor nameplate data input at the time of Auto-Tuning is correct. Perform Auto-Tuning again and correctly set the data that appears on the motor nameplate.
		Faulty motor cable or cable connection.	Check and correct faulty motor wiring.
		The load is too heavy.	<ul style="list-style-type: none"> Reduce the load. Check the vicinity of the machine, determining for example whether the motor shaft is locked.
		A minor fault was detected during Auto-Tuning.	<ol style="list-style-type: none"> Discontinue Auto-Tuning. Check the minor fault code and remove the cause of the problem. Perform Auto-Tuning again.
Code	Name	Cause	Possible Solution
Er-03	STOP Button Input	During Auto-Tuning, the  was pressed and Auto-Tuning was interrupted.	Auto-Tuning did not complete properly. Restart Auto-Tuning.
Code	Name	Cause	Possible Solution
Er-04	Resistance Tuning Error	The Auto-Tuning results were outside the allowable parameter setting range.	<ul style="list-style-type: none"> Check and correct faulty motor wiring. Disconnect the machine from the motor and perform Rotational Auto-Tuning again.
		Auto-Tuning did not complete within a prescribed amount of time.	
		Faulty motor cable or cable connection.	<ul style="list-style-type: none"> Check whether the motor nameplate data input at the time of Auto-Tuning is correct. Perform Auto-Tuning again and correctly set the data that appears on the motor nameplate.
		The motor nameplate data entered during Auto-Tuning is incorrect.	

Code	Name	Cause	Possible Solution
Er-05	No-Load Current Alarm	The Auto-Tuning results were outside the allowable parameter setting range.	<ul style="list-style-type: none"> Check and correct faulty motor wiring. Disconnect the machine from the motor and perform Rotational Auto-Tuning again.
		Auto-Tuning did not end within a prescribed amount of time.	
		The motor nameplate data entered during Auto-Tuning is incorrect.	<ul style="list-style-type: none"> Check whether the motor nameplate data input at the time of Auto-Tuning is correct. Perform Auto-Tuning again and correctly set the data that appears on the motor nameplate.
		Rotational Auto-Tuning was performed with a load exceeding 30% of the rating connected to the motor.	<ul style="list-style-type: none"> Disconnect the machine from the motor and perform Rotational Auto-Tuning again. If motor and load cannot be uncoupled, make sure the load is lower than 30% of the motor rating. If a mechanical brake is installed in the motor, release the brake during Rotational Auto-Tuning.
Code	Name	Cause	Possible Solution
Er-08	Adjusted Slip Calculation Error	The motor nameplate data entered during Auto-Tuning is incorrect.	<ul style="list-style-type: none"> Check whether the motor nameplate data input at the time of Auto-Tuning is correct. Correctly set the data from the motor nameplate, then perform Auto-Tuning again.
		Auto-Tuning did not end within a prescribed amount of time.	<ul style="list-style-type: none"> Check and correct the motor wiring. If the motor and machine are connected during Rotational Auto-Tuning, decouple the motor from the machinery.
		The Auto-Tuning results were outside the allowable parameter setting range.	
		Rotational Auto-Tuning was performed with a load exceeding 30% of the rating connected to the motor.	<ul style="list-style-type: none"> Disconnect the machine from the motor and perform Rotational Auto-Tuning again. If motor and load cannot be uncoupled, make sure the load is lower than 30% of the motor rating. If a mechanical brake is installed in the motor, release the brake during Rotational Auto-Tuning.
Code	Name	Cause	Possible Solution
Er-09	Acceleration Error	The motor did not accelerate for the specified acceleration time.	<ol style="list-style-type: none"> Increase the value set in <i>C1-01 [Acceleration Time 1]</i>. Disconnect the machine from the motor and perform Rotational Auto-Tuning again.
		The value of <i>L7-01</i> or <i>L7-02 [Forward/Reverse Torque Limit]</i> is small.	Increase the value set in <i>L7-01</i> or <i>L7-02 [Forward/Reverse Torque Limit]</i> .
		Rotational Auto-Tuning was performed with a load exceeding 30% of the rating connected to the motor.	<ul style="list-style-type: none"> Disconnect the machine from the motor and perform Rotational Auto-Tuning again. If motor and load cannot be uncoupled, make sure the load is lower than 30% of the motor rating. If a mechanical brake is installed in the motor, release the brake during Rotational Auto-Tuning.
Code	Name	Cause	Possible Solution
Er-10	Motor Rotation Direction Error	The wiring of the drive and motor is faulty.	Check and correct faulty motor wiring.
		The wiring of the drive and PG is faulty.	Check and correct wiring to the encoder.
		Motor direction and the <i>F1-05 [PG 1 Rotation Selection]</i> setting are opposite.	Set <i>F1-05</i> correctly.
		The motor, pulled by the machine, rotated in the opposite direction.	Disconnect the machine from the motor and perform Rotational Auto-Tuning again.
		When the torque reference is 100% or higher, the sign of the speed reference was opposite that of the detected speed.	
Code	Name	Cause	Possible Solution
Er-11	Motor Speed Error	The torque reference during acceleration is too high (100%).	<ul style="list-style-type: none"> Increase the value set in <i>C1-01 [Acceleration Time 1]</i>. Disconnect the machine from the motor and perform Rotational Auto-Tuning again.

6.7 Auto-Tuning Errors

Code	Name	Cause	Possible Solution
Er-12	Current Detection Error	Phase loss is occurring. (U/T1, V/T2, W/T3)	Check and correct faulty motor wiring.
		The current exceeded the current rating of the drive.	<ul style="list-style-type: none"> Check the motor wiring for any short circuits between the wires.
		The output current is too low.	<ul style="list-style-type: none"> Check and turn ON any magnetic contactors used between motors. Replace the board or the entire drive. For more information on replacing the control board, contact Yaskawa or your nearest sales representative.
		Attempted Auto-Tuning without motor connected to the drive.	Connect the motor and restart Auto-Tuning.
		A current detection signal error occurred.	Replace the board or the entire drive. For more information on replacing the control board, contact Yaskawa or your nearest sales representative.
Code	Name	Cause	Possible Solution
Er-13	Leakage Inductance Alarm	The value that was input for the motor rated current is incorrect.	Correctly set the rated current indicated on the motor nameplate and perform Auto-Tuning again.
		Drive was unable to complete tuning for leakage inductance within 300 seconds.	Check and correct faulty motor wiring.
Code	Name	Cause	Possible Solution
Er-14	Motor Speed Error 2	The motor speed exceeded twice the amplitude of speed reference during Inertia Tuning.	Reduce the value set in <i>C5-01 [ASR Proportional Gain 1]</i> .
Code	Name	Cause	Possible Solution
Er-15	Torque Saturation Error	During Inertia Tuning, the output torque exceeded the value set in <i>L7-01 to L7-04 [Torque Limit]</i> .	<ul style="list-style-type: none"> Increase the value set in <i>L7-01 to L7-04 [Torque Limit]</i> as much as possible. Reduce the values set for the frequency and amplitude of the test signals used when carrying out inertia tuning. First, reduce the test signal amplitude, and then perform Inertia Tuning. If the error persists, reduce the test signal frequency and perform Inertia Tuning again.
Code	Name	Cause	Possible Solution
Er-16	Inertia ID Error	The inertia identified by the drive was abnormally small or abnormally large during Inertia Tuning (10% or less, or 50000% or more).	<ul style="list-style-type: none"> Reduce the values set for the frequency and amplitude of the test signals used when carrying out inertia tuning. First, reduce the test signal amplitude, and then perform Inertia Tuning. If the error persists, reduce the test signal frequency and perform Inertia Tuning again. Correctly set the motor inertia according to the motor, and then perform Inertia Tuning again.
Code	Name	Cause	Possible Solution
Er-17	Reverse Prohibited Error	<i>b1-04 = 1 [Reverse Operation Selection = Reverse disabled]</i> has been set. Note: Inertia Tuning cannot be performed if the drive is prohibited from rotating the motor in reverse.	<ol style="list-style-type: none"> Check that the target machine has reverse enabled. Set <i>b1-04 = 0 [Reverse enabled]</i>. Perform Inertia Tuning again.
Code	Name	Cause	Possible Solution
Er-18	Induction Voltage Error	The result of the induced voltage tuning was outside the allowable range.	<ol style="list-style-type: none"> Make sure the input motor nameplate data is correct. Perform Auto-Tuning again and correctly set the data that appears on the motor nameplate.
Code	Name	Cause	Possible Solution
Er-19	PM Inductance Error	The Auto-Tuning results of the PM motor inductance were outside the allowable range.	<ol style="list-style-type: none"> Make sure the input motor nameplate data is correct. Perform Auto-Tuning again and correctly set the data that appears on the motor nameplate.

Code	Name	Cause	Possible Solution
Er-20	Stator Resistance Error	The Auto-Tuning results of the PM Motor Stator Resistance were outside the allowable range.	<ol style="list-style-type: none"> 1. Make sure the input motor nameplate data is correct. 2. Perform Auto-Tuning again and correctly set the data that appears on the motor nameplate.
Code	Name	Cause	Possible Solution
Er-21	Z Pulse Correction Error	The motor is not wired correctly.	<ol style="list-style-type: none"> 1. Correct any motor and PG wiring errors. 2. Perform Z Pulse Offset Tuning again.
		The encoder is not wired correctly.	
		Auto-Tuning was performed when the motor was coasting.	<ol style="list-style-type: none"> 1. Make sure the motor has stopped completely. 2. Perform Z Pulse Offset Tuning again.
		The setting for the direction of motor rotation of the encoder is incorrect.	<ol style="list-style-type: none"> 1. Set the direction of motor rotation of the encoder correctly. [F1-05] 2. Perform Z Pulse Offset Tuning again.
		The number of PG pulses is incorrect.	<ol style="list-style-type: none"> 1. Set the number of PG pulses correctly. [F1-01] 2. Perform Z Pulse Offset Tuning again.
		The encoder is damaged.	<ul style="list-style-type: none"> • Check the signal output from the encoder. • Replace the encoder if damaged.
Code	Name	Cause	Possible Solution
Er-25	HighFreq Inject Param Tuning Err	The motor data is incorrect.	<p>Perform Stationary Auto-Tuning again.</p> <p>Note: If <i>Er-25</i> is detected again even after executing Stationary Auto-Tuning, high frequency injection control might not be possible with that motor. For details, contact Yaskawa or your nearest sales representative.</p>

6.8 Backup Function Operating Mode Display and Errors

◆ Operating Mode Display

When executing the tasks offered by the backup function, the keypad will show the task being performed. These indicators do not indicate that an error has occurred.

Keypad Display	Name	Display	State
Different keypad is connected Do you restore parameters backed up in the keypad?	Detection of inconsistency between the drive and keypad	Normally displayed	It was detected that a keypad of another drive is connected. Select [Yes] to copy parameters backed up in the keypad to the connected drive.
Restore Restore from keypad	Restoring parameters	Flashing	The parameters stored in the keypad have been restored to the drive.
End	Backup/restore/verify operation ended normally	Normally displayed	The parameter backup, restore, or verify operation ended normally.
Backup Backup from Drive	Backing up parameters	Flashing	The parameters stored in the drive are being backed up to the keypad.
Verify Keypad & Drive	Verifying parameters	Flashing	The parameter settings stored in the keypad and the parameter settings in the drive match or are being compared.

◆ Backup Function Runtime Errors

When an error occurs, a code appears on the keypad to indicate the error.

The following table shows a list of error codes. Refer to these and take the corrective action when an error occurs.

Note:

To clear an error, simply press any key on the keypad and the error display will disappear.

Code	Name	Cause	Possible Solution
CPEr	Control Mode Mismatch	The settings for <i>A1-02 [Control Method Selection]</i> differ between the keypad and the drive.	1. Set <i>A1-02</i> on the drive to the same value as that on the keypad. 2. Restore the parameter again.
Code	Name	Cause	Possible Solution
CPyE	Error Writing Data	Parameter restore did not end normally.	Restore the parameter again.
Code	Name	Cause	Possible Solution
CSEr	EEPROM Write Error	The keypad is broken.	Replace the keypad.
Code	Name	Cause	Possible Solution
dFPS	Drive Model Mismatch	An attempt was made to restore parameters that were backed up on a drive of a different model.	1. Check the model of drive for which the parameters were backed up on the keypad. 2. Restore the parameter again.
Code	Name	Cause	Possible Solution
iFEr	MEMOBUS/Modbus Communication Err	A communications error between the keypad and drive occurred.	Check the connector or cable connection.
Code	Name	Cause	Possible Solution
ndAT	Model, Power Supply Voltage, Capacity, Control Mode Mismatch	The parameter settings for model and specifications (power supply voltage and capacity) differ between the keypad and the drive.	1. Make the drive model and the value set in <i>o2-04 [Drive Model Selection]</i> match. 2. Restore the parameter again.
		The parameters are not stored in the keypad.	1. Connect a keypad in which the correct parameters are stored to the drive. 2. Restore the parameter again.

Code	Name	Cause	Possible Solution
rdEr	Error Reading Data	Backup was executed with <i>o3-02 = 0</i> [<i>Copy Allowed Selection = Disabled</i>] set.	Set <i>o3-02 = 1</i> [<i>Enabled</i>] and execute backup again.
Code	Name	Cause	Possible Solution
vAer	Voltage Class, Capacity Mismatch	The power supply specifications or drive capacity parameter settings differ between the keypad and the drive.	<ol style="list-style-type: none"> 1. Make the drive model and the value set in <i>o2-04</i> [<i>Drive Model Selection</i>] match. 2. Restore the parameter again.
Code	Name	Cause	Possible Solution
vFyE	VERIFY ERROR	Indicates that the parameters backed up in the keypad and the parameters in the drive do not match.	<ol style="list-style-type: none"> 1. Restore or backup the parameter again. 2. Verify the parameter again.

6.9 Diagnosing and Resetting Faults

When a fault occurs and the drive stops, follow the instructions below to remove whatever conditions triggered the fault, then restart the drive.

◆ Fault Occurs Simultaneously with Power Loss

WARNING! Crush Hazard. Do not perform work on the drive without eye protection. Wear eye protection before beginning work on the drive. Failure to comply could result in serious injury.

WARNING! Electrical Shock Hazard. Do not immediately restart the drive or operate any peripheral devices after blowing a fuse or tripping an Earth Leakage Circuit Breaker (ELCB). Wait for at least the time specified on the warning label and check the wiring and peripheral device ratings to identify the cause when all indicators are OFF. Contact Yaskawa before restarting the drive or the peripheral devices if the cause cannot be identified. Failure to comply could cause death or serious injury and damage to the drive.

1. Supply power to the control circuit from the external 24 V input.
2. Use monitor parameters $U2-xx$ to display the fault code and data on the operating status of the drive just before the fault occurred.
3. Remove the fault referring to Troubleshooting.

Note:

1. To find out what faults were triggered, check the fault history in $U2-02$ [Previous Fault]. Information on drive status when the fault occurred such as the frequency, current, and voltage can be found in $U2-03$ to $U2-20$.
2. When the fault continues to be displayed after cycling power, remove the cause of the fault and reset.

◆ If the Drive Still has Power After a Fault Occurs

1. Check the fault code displayed on the keypad.
2. Remove the fault referring to Troubleshooting.
3. Execute a fault reset.

◆ Fault Reset

When a fault occurs, the cause of the fault must be removed and the drive must be restarted. The table below lists the different ways to restart the drive.

Table 6.3 Fault Reset Methods

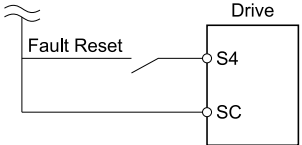
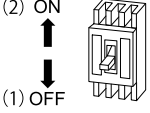
Method 1	Press  on the keypad while the keypad is displaying the error code.	
Method 2	Turn $H1-xx = 14$ [MFDI Function Select = Fault Reset] ON. Note: The default setting for $H1-04$ [Terminal S4 Function Select] is 14 [Fault Reset].	
Method 3	<ol style="list-style-type: none"> 1. Turn off the drive main circuit power supply. 2. Reapply power after the keypad display has turned off. 	

Note:

If the Run command is present from a communication option card or control circuit terminal, the drive will disregard any attempts to reset the fault. Remove the Run command before attempting to clear a fault situation. If a fault reset is executed when a Run command was present, the minor fault $CrST$ [Cannot Reset] will be displayed on the drive.

6.10 Troubleshooting without Fault Display

If the drive or motor operates abnormally but a fault code or error code is not displayed on the keypad, refer to this section and take appropriate measures.

- Motor hunting and oscillation
- Poor motor torque
- Poor speed precision
- Poor motor torque and speed response
- Motor noise



◆ Cannot Change Parameter Settings

Cause	Possible Solution
The drive is running the motor. (The drive is in Drive Mode.)	Stop the drive and switch over to Programming Mode.
$A1-01 = 0$ [Access Level Selection = Operation Only] has been set.	Set $A1-01 = 2$ [Access Level Selection = Advanced Level].
$H1-xx = 1B$ [MFDI Function Select = Program Lockout] has been set.	Turn on the terminals to which $H1-xx = 1B$ has been assigned, and then change the parameters. Note: When terminals to which $H1-xx = 1B$ has been assigned have been turned off, the parameters cannot be changed.
The wrong password was entered.	<ul style="list-style-type: none"> • Enter the password to $A1-04$ [Password] again. • If the password has been forgotten, set the password again using $A1-04$ and $A1-05$ [Password Setting]. Note: If the password has been set, the following parameters cannot be changed unless the password matches: <ul style="list-style-type: none"> • $A1-01$ [Access Level Selection] • $A1-02$ [Control Method Selection] • $A1-03$ [Initialize Parameters] • $A1-06$ [Application Preset] • $A1-07$ [DriveWorksEZ Function Selection] • $A2-01$ to $A2-32$ [User Parameters 1 to 32]
Uv [Undervoltage] has been detected.	<ul style="list-style-type: none"> • Check the power supply voltage using $U1-07$ [DC Bus Voltage]. • Check the main circuit wiring.

◆ Motor Does Not Rotate After Entering Run Command

Cause	Possible Solution
The drive is not in Drive Mode.	<ol style="list-style-type: none"> 1. Check whether [Rdy] is displayed on the keypad. 2. If [Rdy] is not displayed, return to the Home screen.
LO/RE was pressed while the drive was stopped, so the Run command source switched to the keypad.	Perform one of the following operations: <ul style="list-style-type: none"> • Press LO/RE. • Restart the drive. Note: Switching the Run command source using LO/RE can be disabled by setting $o2-01 = 0$ [LO/RE Key Function Selection = Disabled].
Auto-Tuning has just completed.	Switch the keypad to the Home screen. Note: When Auto-Tuning completes, the drive is switched back to the Programming Mode. The Run command will not be accepted unless the drive is in the Drive Mode.
The fast stop command has been entered.	Turn off the fast stop input signal.
Settings are incorrect for the source that provides the Run command.	Set $b1-02$ [Run Command Selection 1] correctly.
The frequency reference source is not set correctly.	Set $b1-01$ [Frequency Reference Selection 1] correctly.

6.10 Troubleshooting without Fault Display

Cause	Possible Solution
There is faulty wiring in the control circuit terminals.	<ul style="list-style-type: none"> • Wire the drive's control circuit terminals correctly. • Check the input terminal status using <i>U1-10 [Input Terminal Status]</i>.
The settings for voltage input and current input of the master frequency reference are incorrect.	<p>Check the analog input terminal signal level settings.</p> <ul style="list-style-type: none"> • Terminal A1: DIP switch <i>S1-1</i> and <i>H3-01 [Terminal A1 Signal Level Select]</i> • Terminal A2: DIP switch <i>S1-2</i> and <i>H3-09 [Terminal A2 Signal Level Select]</i> • Terminal A3: DIP switch <i>S1-3</i> and <i>H3-05 [Terminal A3 Signal Level Select]</i>
Selection for the sinking/sourcing mode and the internal/external power supply is incorrect.	<ul style="list-style-type: none"> • For sinking mode, short circuit terminals SC-SP using a wire jumper. • For sourcing mode, short circuit terminals SC-SN using a wire jumper. • In the case of an external power supply, remove the wire jumper.
The frequency reference is too low.	<ul style="list-style-type: none"> • Check <i>U1-01 [Freq Reference]</i>. • Make the frequency reference higher than <i>E1-09 [Minimum Output Frequency]</i>.
The multi-function analog input setting is incorrect.	<ul style="list-style-type: none"> • Check if the functions assigned to the analog input terminals being used are correct. When <i>H3-02, H3-10, H3-06 = 1 [MFAI Function Select = Frequency Gain]</i> has been set and voltage (current) is not input, the frequency reference will be 0. • Check if the analog input values assigned to terminals A1, A2, and A3 are appropriate using <i>U1-13 to U1-15 [Terminal A1, A2, A3 Input Voltage]</i>.
 was pressed.	<p>Turn off the Run command from external input, and then turn it on again.</p> <p>Note:</p> <p>If  is pressed during operation, the drive will ramp to stop. The  function can be disabled by setting <i>o2-02 = 0 [STOP Key Function Selection = Disabled]</i>.</p>
The 2-wire sequence and 3-wire sequence are set incorrectly.	<ul style="list-style-type: none"> • Setting any of <i>H1-03 to H1-08 [Terminals S3 to S8 Function Select]</i> to 0 [<i>3-Wire Sequence</i>] enables the 3-wire sequence. • If the drive is supposed to be set up for a 2-wire sequence, then ensure <i>H1-03 to H1-08 = 0</i> has not been set. • If the drive is supposed to be set up for a 3-wire sequence, then one of the parameters <i>H1-03 to H1-08</i> must be set to 0.

◆ Motor Rotates in the Opposite Direction from the Run Command

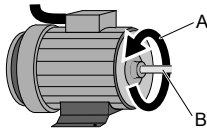
Cause	Possible Solution
Phase wiring between the drive and motor is incorrect.	<ul style="list-style-type: none"> Check the wiring between the drive and motor. Connect drive output terminals U/T1, V/T2, and W/T3 in the right order to match motor terminals U, V, and W. Switch two motor cables (U, V, and W) to reverse motor direction.
The forward direction for the motor is set up incorrectly.	<ul style="list-style-type: none"> Connect drive output terminals U/T1, V/T2, and W/T3 in the right order to match motor terminals U, V, and W. Switch two motor cables (U, V, and W) to reverse motor direction. <div style="text-align: center;">  <p>A - Forward Rotation Direction B - Load Shaft</p> </div> <p style="text-align: center;">Figure 6.1 Forward Rotating Motor</p> <p>Note:</p> <ul style="list-style-type: none"> For Yaskawa motors, forward is designated as being counterclockwise when looking from the motor shaft. Refer to the specifications of the motor being used, and confirm the forward rotation direction. The forward rotation direction of motors may differ depending on manufacturer and type.
The forward run and reverse run signal connections of the drive's control circuit terminals and control panel side are incorrect.	Wire the control circuit correctly.
The motor is running at almost 0 Hz and the Speed Search estimated the speed to be in the opposite direction.	Disable bi-directional search by setting $b3-14 = 0$ [<i>Bi-Direction Speed Search Select = Disabled</i>] so that speed search is performed only in the specified direction.

◆ Motor Rotates in One Direction Only

Cause	Possible Solution
The drive prohibits reverse rotation.	Set $b1-04 = 0$ [<i>Reverse Operation Selection = Reverse enabled</i>].
A Reverse run signal has not been entered, although 3-Wire sequence is selected.	Enable the reverse operation by setting $H1-xx = 0$ [<i>3-Wire Sequence</i>] ON.

◆ Motor is Too Hot

Cause	Possible Solution
The load is too heavy.	<ul style="list-style-type: none"> Reduce the load. Increase the acceleration and deceleration times. Check the values set in $L1-01$ [<i>Motor Overload Protection Select</i>], $L1-02$ [<i>Motor Overload Protection Time</i>], and $E2-01$ [<i>Motor Rated Current (FLA)</i>]. Use a larger motor. <p>Note: Keep in mind that the motor also has a short-term overload rating. Check this carefully before drive settings.</p>
The motor is running continuously at an extremely low speed.	<ul style="list-style-type: none"> Change the run speed. Switch to a drive dedicated motor.
The drive is operating in a vector control mode but Auto-Tuning has not yet been performed.	<ul style="list-style-type: none"> Perform Auto-Tuning. Calculate motor data and reset motor parameters. Switch to $A1-02 = 0$ [<i>Control Method Selection = V/f Control</i>].

Cause	Possible Solution
Insufficient voltage insulation between motor phases.	<ul style="list-style-type: none"> Use a motor with a voltage tolerance higher than the maximum voltage surge. Use a drive dedicated motor rated for use with AC drives when using the motor on drives rated higher than 400 V class. Install an AC reactor on the output side of the drive and set <i>C6-02 = 1</i> [<i>Carrier Frequency Selection = 2.0 kHz</i>]. <p>Note: When the motor is connected to the drive output terminals (UT/1, V/T2, and W/T3), surges occur between the drive switching and the motor coils. Normally, surges can reach up to three times the drive input power supply voltage (600 V for a 200 V class drive, 1200 V for a 400 V class drive).</p>
The air around the motor is too hot.	<ul style="list-style-type: none"> Check the ambient temperature. Cool the area until it is within the specified temperature range.
The motor fan has stopped or is clogged.	<ul style="list-style-type: none"> Clean the motor fan. Improve the surrounding environment.

◆ Drive Does Not Allow Selection of the Desired Auto-Tuning Mode

Cause	Possible Solution
The desired Auto-Tuning mode is not available for the selected control mode.	<ul style="list-style-type: none"> Check if the desired tuning mode is available for the selected control mode. Change the motor control method by setting <i>A1-02</i> [<i>Control Method Selection</i>].

◆ Motor Stalls during Acceleration or Accel/Decel Time is Too Long

Cause	Possible Solution
Torque limit has been reached or current suppression keeps the drive from accelerating.	<ul style="list-style-type: none"> Reduce the load. Use a larger motor. <p>Note: Although the drive has a Stall Prevention function and a Torque Compensation Limit function, accelerating too quickly or trying to drive an excessively large load can exceed the capabilities of the motor.</p>
Torque limit is not set properly.	Check the torque limit setting.
Acceleration time has been set too short.	Check the value set in <i>C1-01</i> , <i>C1-03</i> , <i>C1-05</i> , or <i>C1-07</i> [<i>Acceleration Time</i>] and set them to appropriate values.
The load is too heavy.	<ul style="list-style-type: none"> Increase the acceleration time. Check if the mechanical brake is fully releasing as it should. Reduce the load so that the output current remains within the motor rated current. Use a larger motor. <p>Note: • In extruder and mixer applications, the load will sometimes increase as the temperature drops. • Although the drive has a Stall Prevention function and a Torque Compensation Limit function, accelerating too quickly or trying to drive an excessively large load can exceed the capabilities of the motor.</p>
The frequency reference is low.	<ul style="list-style-type: none"> Check <i>E1-04</i> [<i>Maximum Output Frequency</i>] and increase the setting if it is set too low. Check <i>U1-01</i> [<i>Freq Reference</i>] for proper frequency reference. Check if a frequency reference signal switch has been set to one of the multi-function input terminals. Check for low gain level set to <i>H3-03</i>, <i>H3-11</i>, <i>H3-07</i> [<i>Terminal A1, A2, A3 Input Gain</i>].
Incorrect frequency reference setting.	<p>If <i>H3-02</i>, <i>H3-10</i>, <i>H3-06 = 1</i> [<i>MFAI Function Select = Frequency Gain</i>] has been set, check whether voltage (current) has been set.</p> <ul style="list-style-type: none"> Check the values set in <i>H3-02</i>, <i>H3-10</i>, and <i>H3-06</i>. Check if the analog input values assigned to terminals A1, A2, and A3 are appropriate using <i>U1-13</i> to <i>U1-15</i> [<i>Terminal A1, A2, A3 Input Voltage</i>].

Cause	Possible Solution
Motor characteristics and drive parameter settings are incompatible with one another.	<ul style="list-style-type: none"> Set the correct V/f pattern so that it matches the characteristics of the motor being used. Check the V/f pattern set to <i>E1-03 [V/f Pattern Selection]</i>. Perform Rotational Auto-Tuning.
Although the drive is operating in vector control mode, Auto-Tuning has not been performed.	<ul style="list-style-type: none"> Perform Auto-Tuning. Calculate motor data and reset motor parameters. Switch to <i>A1-02 = 0 [Control Method Selection = V/f Control]</i>.
The Stall Prevention level during acceleration set too low.	<p>Increase the value set in <i>L3-02 [Stall Prevent Level during Accel]</i>.</p> <p>Note: If <i>L3-02</i> is set too low, acceleration may be taking too long.</p>
The Stall Prevention level during run has been set too low.	<p>Increase the value set in <i>L3-06 [Stall Prevent Level during Run]</i>.</p> <p>Note: If <i>L3-06</i> is set too low, speed will drop as the drive outputs torque.</p>
Drive reached the limitations of the V/f motor control method.	<ul style="list-style-type: none"> The motor cable may be long enough (over 50 m) to require Auto-Tuning for line-to-line resistance. Change the V/f pattern to "High Starting Torque." Consider switching to Vector Control mode. <p>Note: Be aware that V/f Control is comparatively limited when it comes to producing torque at low speeds.</p>

◆ Drive Frequency Reference Differs from the Controller Frequency Reference Command

Cause	Possible Solution
The analog input gain and bias for the frequency reference input are set to incorrect values.	<p>Check the gain and bias settings for the analog inputs that are used to set the frequency reference.</p> <ul style="list-style-type: none"> Terminal A1: <i>H3-03 [Terminal A1 Gain Setting]</i>, <i>H3-04 [Terminal A1 Bias Setting]</i> Terminal A2: <i>H3-11 [Terminal A2 Gain Setting]</i>, <i>H3-12 [Terminal A2 Bias Setting]</i> Terminal A3: <i>H3-07 [Terminal A3 Gain Setting]</i>, <i>H3-08 [Terminal A3 Bias Setting]</i>
Frequency bias signals are being entered via analog input terminals A1 to A3 and the sum of all signals builds the frequency reference.	<ul style="list-style-type: none"> Check whether two or more of <i>H3-02</i>, <i>H3-10</i>, <i>H3-06 [MFAI Function Select]</i> have a setting value of 0, and change the settings if necessary. Check if the analog input values assigned to terminals A1, A2, and A3 are appropriate using <i>U1-13 to U1-15 [Terminal A1, A2, A3 Input Voltage]</i>.
During low speed operation the motor rotates faster than the frequency reference.	<p>Lower the value set in <i>n4-70 [SpdCommandCompensator ofLow-Freq]</i>.</p>
PID control is enabled.	<p>If PID control is not necessary, set <i>b5-01 = 0 [PID Function Setting = Disabled]</i>.</p> <p>Note: When PID control is enabled, the drive adjusts the output frequency according to the target value. The drive will only accelerate to the maximum output frequency set in <i>E1-04 [Maximum Output Frequency]</i> while PID control is active.</p>

◆ Unstable Motor Speed When Using PM Motor

Cause	Possible Solution
<i>E5-01 [PM Motor Code Selection]</i> is not set correctly.	See "Motor Performance Fine-Tuning" in the technical manual.
Drive is attempting to operate the motor beyond the speed control range listed in the specifications.	Check the speed control range and adjust the speed accordingly.
The motor is operating at a speed reference of 5% or lower.	Use a different drive to operate a motor at a speed reference of 5% or lower. Contact Yaskawa or your nearest sales representative.

Cause	Possible Solution
Motor hunting occurs.	Adjust the following parameters and readjust those which have the most effect: <ul style="list-style-type: none"> • <i>n8-55 [Load Inertia]</i> • <i>n8-45 [Spd Feedback Detect Control Gain]</i> • <i>C4-02 [Torque Compensation Delay Time]</i>
Hunting occurs at start.	Increase the value set in <i>C2-01 [S-Curve Time @ start of Accel]</i> .
Too much current is flowing through the drive.	Set <i>E5-01 [PM Motor Code Selection]</i> correctly based on the motor being used. For special-purpose motors, enter the correct data to <i>E5-xx</i> according to the test report provided for the motor.

◆ Excessive Motor Oscillation and Erratic Rotation

Cause	Possible Solution
Poor balance between motor phases.	<ul style="list-style-type: none"> • Check drive input power voltage to ensure that it provides stable power. • Set <i>L8-05 = 0 [Input Phase Loss Protect Select = Disabled]</i>.
The hunting prevention function is disabled.	<ul style="list-style-type: none"> • Set <i>n1-01 = 1 [Hunting Prevention Selection = Enabled]</i>. • Increase the value of <i>n2-01 [SpdFeedbackDetectCtr (AFR) Gain]</i> or <i>n2-02 [SpdFeedbackDetCtr(AFR)TimeConst1]</i>.

◆ Deceleration Takes Longer Than Expected with Dynamic Braking Enabled

Cause	Possible Solution
The setting for stall prevention during deceleration is incorrect.	<ul style="list-style-type: none"> • Check the setting for <i>L3-04 [Decel Stall Prevention Selection]</i>. • If a dynamic braking option has been installed, set <i>L3-04 = 0 [Disabled]</i>. • If the drive detects <i>ov [Overvoltage]</i>, set <i>L3-04 = 3 [General Purpose w/ DB resistor]</i>.
The deceleration time is set too long.	Set <i>C1-02, C1-04, C1-06, or C1-08 [Deceleration Time]</i> to appropriate values.
The motor torque is insufficient.	Use a larger motor. Note: Assuming parameter settings are normal and that no <i>ov [Overvoltage]</i> occurs when there is insufficient torque, it is likely that the demand on the motor has exceeded the motor capacity.
Reaching the torque limit.	<ul style="list-style-type: none"> • Check the value set in <i>L7-01 to L7-04 [Torque Limit]</i> and increase them if necessary. Note: If the torque limit is enabled, deceleration might take longer than expected because the drive cannot output more torque than the limit setting. • If <i>H3-02, H3-10, H3-06 = 10, 11, 12, 15 [MFAI Function Select = Torque Limit]</i> has been set, check the settings for the multi-function analog inputs. <ul style="list-style-type: none"> • Check the values set in <i>H3-02, H3-10, and H3-06</i>. • Check if the analog input values assigned to terminals A1, A2, and A3 are appropriate using <i>U1-13 to U1-15 [Terminal A1, A2, A3 Input Voltage]</i>.
Load exceeded the internal torque limit determined by the drive rated current.	Replace the drive with a larger capacity model.

◆ Load Falls When Brake is Applied

Cause	Possible Solution
The open/close timing of the brake is incorrect.	Refer to “Notes on Controlling the Brake when Using the Hoist Application Preset” in the technical manual and take appropriate measures.
The DC injection braking is insufficient.	Increase the value set in <i>b2-02 [DC Injection Braking Current]</i> .

◆ Noise From Drive or Motor Cables When the Drive is Powered On

Cause	Possible Solution
Relay switching in the drive generates excessive noise.	<ul style="list-style-type: none"> • Lower the carrier frequency by changing the setting of <i>C6-02 [Carrier Frequency Selection]</i>. • Connect a noise filter to the input side of the drive's power supply. • Connect a noise filter to the output side of the drive. • Separate the control circuit wiring from the main circuit wiring. • Perform wiring using a metallic cable gland. • Shield the periphery of the drive with metal. • Reevaluate the grounding of the drive and motor. • Check that ground faults have not occurred in the wiring or motor.

◆ Earth Leakage Circuit Breaker (ELCB) Trips During Run

Cause	Possible Solution
There is excessive leakage current from the drive.	<ul style="list-style-type: none"> • Increase the ELCB sensitivity or use ELCB with a higher threshold. • Lower the carrier frequency by changing the setting of <i>C6-02 [Carrier Frequency Selection]</i>. • Reduce the length of the cable used between the drive and the motor. • Install a noise filter or AC reactor on the output side of the drive. Set <i>C6-02 = 1 [2.0 kHz]</i> when connecting an AC reactor. • Disable the internal EMC filter.

◆ Unexpected Noise from Connected Machinery Occurs When Motor Rotates

Cause	Possible Solution
The carrier frequency is at the resonant frequency of the connected machinery.	<ul style="list-style-type: none"> • Adjust <i>C6-02 to C6-05 [Carrier Frequency]</i>. • Set <i>C6-02 = 1 to 6 [Carrier Frequency Selection = Frequency other than Swing PWM]</i>, and check whether the abnormal noise persists. <p>Note: The drive may have trouble assessing whether white noise is being generated from the drive or from the machine if <i>C6-02 = 7 to A [Carrier Frequency Selection = Swing PWM]</i> has been set.</p>
The drive output frequency is the same as the resonant frequency of the connected machinery.	<ul style="list-style-type: none"> • Adjust <i>d3-01 to d3-04 [Jump Frequency]</i>. • Place the motor on a rubber pad to reduce vibration.

◆ Oscillation or Hunting Occurs When Motor Rotates

Cause	Possible Solution
The frequency reference is assigned to an external source and the signal is noisy.	<p>Ensure that noise is not affecting the signal lines.</p> <ul style="list-style-type: none"> • Separate main circuit wiring and control circuit wiring. • Use twisted-pair cables or shielded wiring for the control circuit. • Increase the value of <i>H3-13 [Analog Input FilterTime Constant]</i>.
The cable between the drive and motor is too long.	<ul style="list-style-type: none"> • Perform Auto-Tuning. • Make the wiring as short as possible.
The PID parameters are not sufficiently adjusted.	Readjust <i>b5-xx [PID control]</i> .

◆ PID Output Fault

Cause	Possible Solution
No PID feedback input.	<ul style="list-style-type: none"> Check the multi-function analog input terminal settings. Check whether $H3-02$, $H3-10$, $H3-06 = B$ [<i>MFAI Function Select = PID Feedback</i>] has been set. Check whether the multi-function analog input terminal settings match the actual signal inputs. Check the connection of the feedback signal. Check whether $b5-xx$ [<i>PID Control</i>] has been set correctly. <p>Note: No PID feedback input to the terminal causes the value detected to be 0, causing a PID fault and the drive to operate at max frequency.</p>
The level of detection and the target value do not correspond with each other.	<p>Use $H3-03$, $H3-11$, $H3-07$ [<i>Terminal A1, A2, A3 Gain Setting</i>] to adjust PID target and feedback signal scaling.</p> <p>Note: The PID function performs control such that the deviation between the target value and the detected value becomes 0. PID control keeps the difference between target and detection values at 0. For this reason, set the input level for the values relative to one another.</p>
Reverse drive output frequency and speed detection. When output frequency rises, the sensor detects a speed decrease.	Set $b5-09 = 1$ [<i>PID Output Level Selection = Reverse output (reverse acting)</i>].

◆ Insufficient Starting Torque

Cause	Possible Solution
Auto-Tuning has not been performed in vector control mode.	Perform Auto-Tuning.
The control mode was changed after performing Auto-Tuning.	Perform Auto-Tuning again.
Stationary Auto-Tuning for Line-to-Line Resistance was performed.	Perform Rotational Auto-Tuning.

◆ Motor Rotates after the Drive Output is Shut Off

Cause	Possible Solution
DC Injection Braking is set too low and the drive cannot decelerate properly.	<ul style="list-style-type: none"> Increase the value set in $b2-02$ [<i>DC Injection Braking Current</i>]. Increase the value set in $b2-04$ [<i>DC Inject Braking Time at Stop</i>].
The stopping method is set so that the drive coasts to stop.	Set $b1-03 = 0$ or 2 [<i>Stopping Method Selection = Ramp to Stop, DC Injection Braking to Stop</i>].

◆ Output Frequency is not as High as Frequency Reference

Cause	Possible Solution
Frequency reference is set within the range of the Jump frequency.	<p>Adjust $d3-01$ to $d3-03$ [<i>Jump Frequency 1 to 3</i>] and $d3-04$ [<i>Jump Frequency Width</i>].</p> <p>Note: Enabling the Jump frequency prevents the drive from outputting the frequencies specified in the Jump range.</p>
Upper limit for the frequency reference has been exceeded.	<p>Set $E1-04$ [<i>Maximum Output Frequency</i>] and $d2-01$ [<i>Frequency Reference Upper Limit</i>] to optimal values.</p> <p>Note: The following calculation yields the upper value for the output frequency: $E1-04 \times d2-01 / 100$</p>
Large load triggered Stall Prevention function during acceleration.	<ul style="list-style-type: none"> Reduce the load. Adjust $L3-02$ [<i>Stall Prevent Level during Accel</i>].

Cause	Possible Solution
<i>L3-01 = 3 [Stall Prevent Select during Accel = ILim Mode]</i> has been set.	<ol style="list-style-type: none"> 1. Check whether the V/f pattern and motor parameter settings are appropriate, and set them correctly. 2. If this does not solve the problem, and it is not necessary to limit the current level of stall during acceleration, adjust <i>L3-02</i>. 3. If this does not solve the problem, set <i>L3-01 = 1 [General Purpose]</i>.
The motor is rotating at the following speed: <i>b2-01 [DC Injection/Zero SpeedThreshold] ≤ Motor Speed < E1-09 [Minimum Output Frequency]</i>	<ul style="list-style-type: none"> • Set <i>b1-21 = 1 [CLV Start Selection = Accept Run command at any speed]</i>. • Set the value of <i>E1-09</i> lower than the value of <i>b2-01</i>.

◆ Sound from Motor

Cause	Possible Solution
Exceeded 100% of the rated output current of the drive while operating at low speeds.	<ul style="list-style-type: none"> • If the sound is coming from the motor, set <i>L8-38 = 0 [Carrier Frequency Reduction = Disabled]</i>. • If <i>oL2 [Drive Overloaded]</i> occurs frequently after setting <i>L8-38 = 0</i>, replace the drive with a high-capacity one.

◆ Motor Does Not Restart after Power Loss

Cause	Possible Solution
The Run command was not issued again when power was restored.	<ul style="list-style-type: none"> • Check the sequence and wiring that has been set up to enter the Run command. • A relay should be set up to make sure the Run command remains enabled throughout any power loss.
When running based on the 3-wire sequence, the momentary power loss lasted a long time, so the relay that is supposed to maintain the Run command has been switched off.	Check wiring and circuitry for the relay intended to keep the Run command enabled throughout the momentary power loss ride-thru time.

Periodic Inspection & Maintenance

This chapter describes how to inspect and maintain drives in use, how to replace cooling fans and other parts, and how to store drives.

7.1	Section Safety	334
7.2	Inspection.....	336
7.3	Maintenance	339
7.4	Replace a Cooling Fan and Circulation Fan	342
7.5	Replace the Drive	349
7.6	Replace the Keypad Battery	353
7.7	Storage Guidelines	355

7.1 Section Safety

DANGER

Electrical Shock Hazard

Do not perform inspections or wiring while the drive is energized. De-energize all devices before carrying out any wiring or repair operations. Voltage will remain within the capacitors inside the drive even after the power has been switched off. The Charge LED is extinguished once the DC bus voltage goes below 50 V DC. To prevent electric shock, always wait for at least the amount of time indicated on the warning labels and confirm that all indicators are OFF. Then, remove the front cover and terminal cover, measure the input power supply voltage and the DC bus voltage, and make sure that the voltages have been lowered to safe levels.

Failure to comply may result in death or serious injury.

While the drive is ON, never attempt to change any wiring, disconnect any option cards or connectors, or replace the cooling fan. Before performing any repairs, shut OFF the power supply to the drive and verify that there is no residual voltage in the unit.

Failure to do so may result in serious electric shock.

A motor will continue to run even when the power supply to the drive has been turned OFF. PM motors generate induced voltage to the terminal of the motor even when the power supply to the drive has been switched OFF.

Failure to comply could result in death or serious injury.

WARNING

Electrical Shock Hazard

Do not operate equipment with covers removed. The diagrams in this section may include drives without covers or safety shields to illustrate details. Be sure to reinstall covers or shields before operating the drives and run the drives according to the instructions described in this manual.

Failure to comply could result in death or serious injury.

Always ground the motor-side grounding terminal.

Improper equipment grounding could cause death or serious injury from contacting the motor case.

Only authorized persons qualified in electrical work should perform installation, wiring, maintenance, inspections, parts replacement, and repairs.

Failure to comply may cause electrical shock.

Do not perform work on the drive while wearing loose clothing or jewelry. Before servicing, secure loose clothing and remove all metal objects such as watches or rings.

Failure to comply could cause death or serious injury.

Fire Hazard

Tighten all terminal screws to the specified tightening torque.

Loose or overtightened connections could cause erroneous operation and damage to the terminal block or start a fire and cause death or serious injury.

Do not use the main circuit power supply (Overcurrent Category III) at improper voltages. Before applying power, make sure the drive rated voltage and the power supply voltage match.

Using the main circuit power supply at improper voltages may result in batteries bursting and igniting, which could cause fire and injury.

Do not place flammable or combustible materials on top of the drive and do not mount the drive to flammable or combustible materials. Attach the drive to metal or other noncombustible material.

Failure to comply could cause death or serious injury.

⚠ CAUTION**Preventing Burns**

Do not touch the heatsink of the drive as it is very hot. To replace cooling fans, de-energize the drive and wait at least 15 minutes. Make sure the heatsink has sufficiently cooled before proceeding to replace a fan.

Touching the device may result in burns in certain circumstances.

NOTICE

Observe proper electrostatic discharge (ESD) procedures when handling the drive.

Failure to comply could result in ESD damage to the drive circuitry.

Follow cooling fan replacement instructions. Replace all fans when performing maintenance to help ensure maximum useful product life.

Improper fan replacement could cause damage the drive.

Do not use unshielded wire for control wiring. Use shielded twisted-pair wires and ground the shield to the ground terminal of the drive.

Failure to comply may cause electrical interference resulting in poor system performance.

Do not modify the drive circuitry.

Failure to comply could cause damage to the drive and will void warranty. Yaskawa is not responsible for any modification of the product made by the user.

Confirm that all connections are correct after installing the drive and connecting peripheral devices.

Failure to comply could damage the drive.

Comply with proper wiring practices. Connect motor input terminals U, V and W to drive output terminals U/T1, V/T2, and W/T3. The phase order for the drive and motor should match.

The motor may run in reverse if the phase order is backward.

To extend the service life of the relay contacts and electrolytic capacitors inside the drive, the MC on the power source side for turning the drive on (run) and off (stop) should be operated a maximum of one time in 30 minutes. Running and stopping the motor should be done as much as possible via the run and stop operations of the drive.

The drive can be run and stopped by turning it on and off via the MC on the power source side, but if this is done frequently, it may cause the drive to fail. Improper operation may shorten the service life of the relay contact and electrolytic capacitor.

Do not connect or operate any equipment with visible damage or missing parts.

Failure to comply could further damage the equipment.

7.2 Inspection

Power electronics have limited life and may exhibit changes in characteristics or performance deterioration after years of use under normal conditions. To help avoid such problems, it is important to perform preventive maintenance and periodic inspection, and replace parts on the drive.

Drives contain a variety of power electronics such as power transistors, semiconductors, capacitors, resistors, fans, and relays. The electronics in the drive serve a critical role in maintaining proper motor control.

Follow the inspection lists provided in this chapter as a part of a regular maintenance program.

Note:

Perform periodic inspections at least once per year.

The frequency at which inspections should be performed on various equipment varies depending on operating conditions, environmental conditions, and usage conditions.

When using the drive under harsh conditions or in the following environments, inspections must be performed more often.

- High ambient temperatures
- Frequent starting and stopping
- Fluctuations in the AC power supply or load
- Excessive vibrations or shock loading
- Dust, metal dust, salt, sulfuric acid, chlorine atmospheres
- Poor storage conditions.

◆ Recommended Daily Inspection

The following table outlines the recommended daily inspection for Yaskawa drives. Check the following items on a daily basis to avoid premature deterioration in performance or product failure. Copy this checklist and mark the “Checked” column after each inspection.

Table 7.1 Daily Inspection Checklist

Inspection Area	Inspection Points	Corrective Action	Checked
Motor	Inspect for abnormal oscillation or noise coming from the motor.	<ul style="list-style-type: none"> • Check the load coupling. • Measure motor vibration. • Tighten all loose components. 	
Cooling System	Inspect for abnormal heat generated from the drive or motor and visible discoloration.	<ul style="list-style-type: none"> • Check for the excessive load. • Tighten loose screws. • Check for the dirty heatsink or motor. • Check for the ambient temperature. 	
	Inspect the cooling fans, circulation fans, and circuit board cooling fans.	<ul style="list-style-type: none"> • Check for the clogged or dirty fan. • Check for the correct fan operation using the performance life monitor. 	
Surrounding Environment	Check that the installation environment is suitable.	Eliminate the source of contaminants or correct poor environment.	
Load	The drive output current should not be higher than the motor or drive rating for an extended period of time.	<ul style="list-style-type: none"> • Check for the excessive load. • Check the correct motor parameter settings. 	
Power Supply Voltage	Check main power supply and control voltages.	<ul style="list-style-type: none"> • Correct the voltage or power supply to within nameplate specifications. • Verify all main circuit phases. 	

◆ Recommended Periodic Inspection

The table outlines the recommended periodic inspections for Yaskawa drive installations. Although periodic inspections should generally be performed once a year; the drive may require more frequent inspection in harsh environments or with rigorous use. Operating and environmental conditions, along with experience in each application, will determine the actual inspection frequency for each installation. Periodic inspections will help to

avoid performance deterioration and product failure. Copy this checklist and mark the “Checked” column after each inspection.

DANGER! Electrical Shock Hazard. Do not perform inspections or wiring while the drive is energized. De-energize all devices before carrying out any wiring or repair operations. Voltage will remain within the capacitors inside the drive even after the power has been switched off. The Charge LED is extinguished once the DC bus voltage goes below 50 V DC. To prevent electric shock, always wait for at least the amount of time indicated on the warning labels and confirm that all indicators are OFF. Then, remove the front cover and terminal cover, measure the input power supply voltage and the DC bus voltage, and make sure that the voltages have been lowered to safe levels. Failure to comply may result in death or serious injury.

Table 7.2 Main Circuit Periodic Inspection Checklist

Inspection Area	Inspection Points	Corrective Action	Checked
General	<ul style="list-style-type: none"> Inspect equipment for discoloration from overheating or deterioration. Inspect for damaged or deformed parts. 	<ul style="list-style-type: none"> Replace damaged components as required. The drive has few serviceable parts and may require complete drive replacement. 	
	Inspect for dirt, foreign particles, or dust collection on components.	<ul style="list-style-type: none"> Inspect enclosure door seal if used. Remove foreign particles and dust with a vacuum cleaner to avoid touching parts. Replace components if cleaning is not possible. 	
Conductors and Wiring	<ul style="list-style-type: none"> Inspect wiring and connections for discoloration or damage. Inspect wiring and connections for discoloration from overheating. Inspect wire insulation, shielding or discoloration for wear. 	Repair or replace damaged wiring.	
Terminal Block	Inspect terminals for stripped, damaged, or loose connections.	<ul style="list-style-type: none"> Tighten loose screws. Replace damaged screws or terminals. <p>Note: Hex screws for drive models 2056, 2070, 4031, and 4038 cannot be replaced.</p>	
Electromagnetic Contactors and Relays	<ul style="list-style-type: none"> Inspect contactors and relays for excessive noise during operation. Inspect coils for signs of overheating such as melted or cracked insulation. 	<ul style="list-style-type: none"> Check coil voltage for overvoltage or undervoltage conditions. Replace damaged removable relays, contactors, or circuit board. 	
Dynamic Braking Option	Inspect the insulation material for discoloration from overheating.	If the option is discolored, check to make sure that the wiring is not damaged. A small amount of discoloration is not problematic.	
Electrolytic Capacitor	<ul style="list-style-type: none"> Inspect for leaking, discoloration, or cracks. Check if the cap has come off, if there is any swelling, or the sides have ruptured and are leaking. 	The drive has few serviceable parts and may require complete drive replacement.	
Diodes, IGBT (Power Transistor)	Inspect for dust or other foreign material collected on the surface.	Remove foreign particles and dust with a vacuum cleaner to avoid touching parts.	

Table 7.3 Motor Periodic Inspection Checklist

Inspection Area	Inspection Points	Corrective Action	Checked
Operation Check	Check for increased vibration or abnormal noise.	Stop the motor and contact qualified maintenance personnel as required.	

Table 7.4 Control Circuit Periodic Inspection Checklist

Inspection Area	Inspection Points	Corrective Action	Checked
General	<ul style="list-style-type: none"> Inspect terminals for stripped, damaged, or loose connections. Make sure all terminals have been properly tightened. 	<ul style="list-style-type: none"> Tighten loose screws. Replace damaged screws or terminals. If terminals are integral to a circuit board, then board or drive replacement may be required. 	
Circuit Boards	<ul style="list-style-type: none"> Check for any odor, discoloration, and rust. Make sure connections are properly fastened. Make sure that no dust or oil mist has accumulated on the surface of the board. 	<ul style="list-style-type: none"> Fix any loose connections. If an antistatic cloth or vacuum plunger cannot be used, replace the board. Do not use any solvents to clean the board. Remove foreign particles and dust with a vacuum cleaner to avoid touching parts. The drive has few serviceable parts and may require complete drive replacement. 	

Table 7.5 Cooling System Periodic Inspection Checklist

Inspection Area	Inspection Points	Corrective Action	Checked
Cooling Fans	<ul style="list-style-type: none"> Check for abnormal oscillation or unusual noise. Check for damaged or missing fan blades. 	Clean or replace the fans as required.	
Heatsink	<ul style="list-style-type: none"> Inspect for dust or other foreign material collected on the surface. Inspect for dirt. 	Remove foreign particles and dust with a vacuum cleaner to avoid touching parts.	
Air Duct	Inspect air intake, exhaust openings and that there are no foreign materials on the surface.	Clear obstructions and clean air duct as required.	

Table 7.6 Keypad Periodic Inspection Checklist

Inspection Area	Inspection Points	Corrective Action	Checked
General	<ul style="list-style-type: none"> Make sure data appears on the display properly. Inspect for dust or other foreign material that may have collected on surrounding components. 	<ul style="list-style-type: none"> Contact Yaskawa or your nearest sales representative if you have any problems with the display or key. Clean the keypad. 	

7.3 Maintenance

The drive has Maintenance Monitors that keep track of component wear. This drive is equipped with a function to inform the user of the maintenance period when a specific component is approaching its expected performance life. This feature provides advance maintenance warning and eliminates the need to shut down the entire system for unexpected problems. The parts whose maintenance period can be checked using the performance life monitor are as follows. For more information on part replacement, contact Yaskawa or your nearest sales representative.

- Cooling fan
- Electrolytic Capacitor
- Soft charge bypass relay
- IGBT

◆ Replaceable Parts

The parts of this product that can be replaced are as follows.

- Control circuit terminal board
- Cooling fan, circulation fan
- Keypad

Replace the drive itself completely if the main circuit fails.

Contact Yaskawa or your nearest sales representative before replacing parts if the drive is still under warranty. Yaskawa reserves the right to replace or repair the drive according to Yaskawa warranty policy.

WARNING! Electrical Shock Hazard. Do not perform inspections or wiring while the drive is energized. De-energize all devices before carrying out any wiring or repair operations. Voltage will remain within the capacitors inside the drive even after the power has been switched off. The Charge LED is extinguished once the DC bus voltage goes below 50 V DC. To prevent electric shock, always wait for at least the amount of time indicated on the warning labels and confirm that all indicators are OFF. Then, remove the front cover and terminal cover, measure the input power supply voltage and the DC bus voltage, and make sure that the voltages have been lowered to safe levels. Failure to comply may result in death or serious injury.

◆ Part Replacement Guidelines

The following table shows the standard replacement period of periodic replacement parts. When replacing parts, only use Yaskawa replacement parts for the appropriate model and design revision number of the drive being used.

Table 7.7 Standard Replacement Period

Part	Standard Replacement Period
Cooling fan	10 years
Electrolytic Capacitor <i>*1</i>	10 years

*1 Replace the drive itself completely if parts that cannot be repaired or replaced become damaged.

NOTICE: Estimated performance life based on specific usage conditions. These conditions are provided for the purpose of replacing parts to maintain performance. Some parts may require more frequent replacement due to poor environments or rigorous use. Usage conditions for estimated performance life: Ambient temperature: Yearly average of 40 °C (IP00/Open Type enclosure) Load factor: 80% maximum Operation time: 24 hours a day

◆ Drive Component Lifespan Monitor Function

As a periodic part replacement guideline, the keypad displays percentage values to determine when parts should be replaced. To check replacement periods, use the following lifespan monitors. When the maintenance period reaches 100%, the part replacement period has arrived and there is increased risk that the drive may malfunction. Yaskawa recommends checking the maintenance period regularly to ensure maximum performance life.

Table 7.8 Performance Life Monitors

Monitor No.	Part	Description
U4-03	Cooling fan	Displays the cumulative operation time of fans from 0 to 99999 hours. This value is automatically reset to 0 after it reaches 99999.
U4-04		Displays the accumulated fan operation time as a percentage of the specified maintenance period.
U4-05	Electrolytic Capacitor	Displays the accumulated time the capacitors are used as a percentage of the specified maintenance period.

Monitor No.	Part	Description
U4-06	Soft charge bypass relay	Displays the number of times the drive is powered up as a percentage of the performance life of the inrush circuit.
U4-07	IGBT	Displays the percentage of the maintenance period reached by the IGBTs.

◆ Alarm Outputs for Maintenance Monitors

A message can be set up to inform the user when a specific component is approaching the end of its expected performance life using $H2-xx$ [*MFDO Function Select*]. Set the appropriate setting value to $H2-xx$ as shown in the following table.

When a specific component is approaching the end of its expected performance life, the multi-function digital output terminals set for $H2-xx = 2F$ [*Maintenance Period*] will close, and the keypad will display an alarm indicating the part that must be replaced.

Table 7.9 Maintenance Period Alarms

Display	Alarm Name	Cause	Solution	Multi-function digital output (Setting Value in $H2-xx$)
LT-1	Cooling Fan Maintenance Time	The cooling fan has reached 90% of its expected performance life.	After replacing a cooling fan, set $o4-03 = 0$ [<i>CoolingFan OperationTime Setting = 0</i>] to reset the cooling fan operation time.	2F
LT-2	Capacitor Maintenance Time	The main circuit and control circuit capacitors has reached 90% of their expected performance life.	Replace the board or the entire drive. Contact Yaskawa or your nearest sales representative on possible board replacement.	
LT-3	SoftChargeBy passRelay MainteTime	The use of the soft charge bypass relay has reached 90% of its expected performance life.	Replace the board or the entire drive. Contact Yaskawa or your nearest sales representative on possible board replacement.	
LT-4	IGBT Maintenance Time (50%)	IGBTs have reached 50% of their expected performance life.	Check the load, carrier frequency, and output frequency.	
TrPC	IGBT Maintenance Time (90 %)	IGBTs have reached 90% of their expected performance life.	Replace the IGBT or the entire drive.	10

◆ Related Parameters

Set $o4-03$, $o4-05$, $o4-07$, and $o4-09$ [*Maintenance Setting*] to 0. Reset the Maintenance Monitor after replacing the specific component. If these parameters are not reset after the corresponding parts have been replaced, the Maintenance Monitor function will continue to count down the performance life from the value that was reached with the old part. If the Maintenance Monitor is not reset, the drive will not have the correct value of the performance life for the new component.

Note:

The maintenance period differs depending on the environment in which the drive is used.

Table 7.10 Maintenance Setting Parameters

Parameter Number	Name	Function
$o4-03$	CoolingFan OperationTime Setting	Sets the value from which to start the cumulative drive cooling fan operation time in 10-hour units. Note: If $o4-03 = 30$ has been set, the operation time for the cooling fan setting will be counted from 300 hours, and 300H will be displayed on the $U4-03$ [<i>Cooling Fan Ope Time</i>].
$o4-05$	Capacitor Maintenance Setting	Sets the value from which to start the count for the main circuit capacitor maintenance period as a percentage.

Parameter Number	Name	Function
o4-07	DCBusPreChargeRelayMainteSetting	Sets as a percentage the value from which to start the count for the soft charge bypass relay maintenance time.
o4-09	IGBT Maintenance Setting	Sets the value from which to start the count for the IGBT maintenance period as a percentage.

7.4 Replace a Cooling Fan and Circulation Fan

NOTICE: Follow cooling fan replacement instructions. Replace all fans when performing maintenance to help ensure maximum useful product life. Improper fan replacement could cause damage the drive.

To replace a cooling fan or circulation fan, contact Yaskawa or your nearest sales representative.

To ensure that the product has the longest possible service life, replace all cooling fans at the same time when replacing them.

◆ Number of Cooling Fans and Circulation Fans Used

Table 7.11 Cooling Fans and Circulation Fans (Three-Phase 200 V)

Model	Cooling fan	Circulation Fans	Replacement Procedure
2004 to 2012	-	-	-
2018, 2021	1	-	Procedure A
2030, 2042	2	-	Procedure B
2056	2	-	Procedure C
2070 to 2110	Preparing		
2138 to 2313			
2360, 2415			

Table 7.12 Cooling Fans and Circulation Fans (Three-Phase 400 V)

Model	Cooling fan	Circulation Fans	Circuit Board Cooling Fans	Replacement Procedure
4002 to 4005	-	-	-	-
4007 to 4012	1	-	-	Procedure A
4018, 4023	2	-	-	Procedure B
4031, 4038	2	-	-	Procedure C
4044 to 4075	Preparing			
4089 to 4296				
4371, 4389				
4453 to 4675				

◆ Replace a Fan (Procedure A)

WARNING! Electrical Shock Hazard. Do not perform inspections or wiring while the drive is energized. De-energize all devices before carrying out any wiring or repair operations. Voltage will remain within the capacitors inside the drive even after the power has been switched off. The Charge LED is extinguished once the DC bus voltage goes below 50 V DC. To prevent electric shock, always wait for at least the amount of time indicated on the warning labels and confirm that all indicators are OFF. Then, remove the front cover and terminal cover, measure the input power supply voltage and the DC bus voltage, and make sure that the voltages have been lowered to safe levels. Failure to comply may result in death or serious injury.

CAUTION! Preventing Burns. Do not touch the heatsink of the drive as it is very hot. To replace cooling fans, de-energize the drive and wait at least 15 minutes. Make sure the heatsink has sufficiently cooled before proceeding to replace a fan. Touching the device may result in burns in certain circumstances.

NOTICE: Follow cooling fan replacement instructions. Replace all fans when performing maintenance to help ensure maximum useful product life. Improper fan replacement could cause damage the drive.

Remove a Fan

- Free the fan finger guard by pulling upward while pressing in on the hooks located on the left and right sides of the fan finger guard.

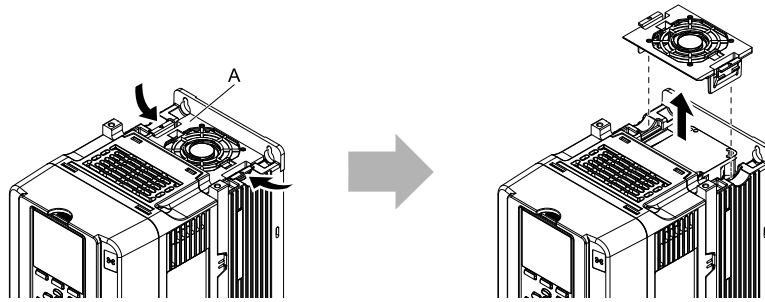

A - Fan finger guard

Figure 7.1 Remove a Fan Finger Guard

- Lift up directly on the cooling fan. Unplug the power supply connector and release the fan from the drive.

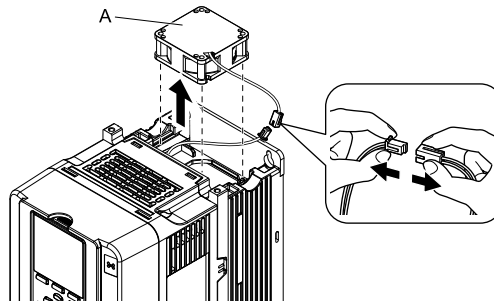

A - Cooling fan

Figure 7.2 Remove a Cooling Fan

Install a Fan

Reverse the removal procedure to reinstall the cooling fan.

- Install the replacement cooling fan into the drive, ensuring the protrusions on the drive line up with the notches on the fan.

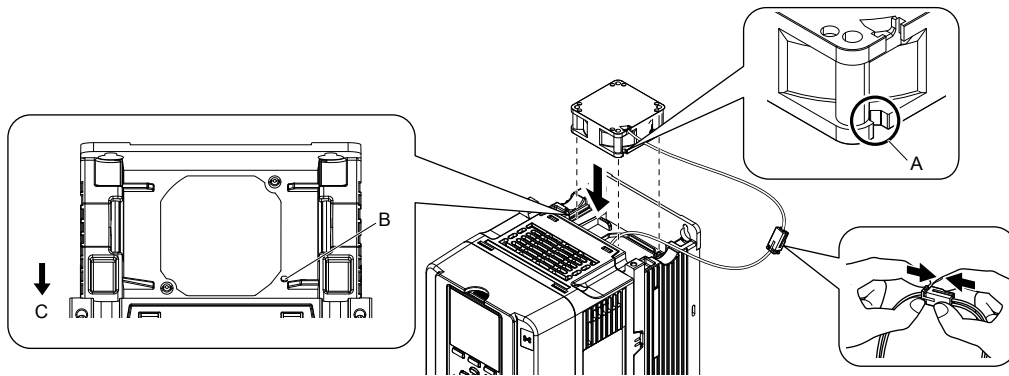

A - Notch of fan
B - Protrusions of drive

C - Drive front surface

Figure 7.3 Install a Cooling Fan

7.4 Replace a Cooling Fan and Circulation Fan

2. Properly connect the fan power lines, then place the cable back into the recess of the drive.

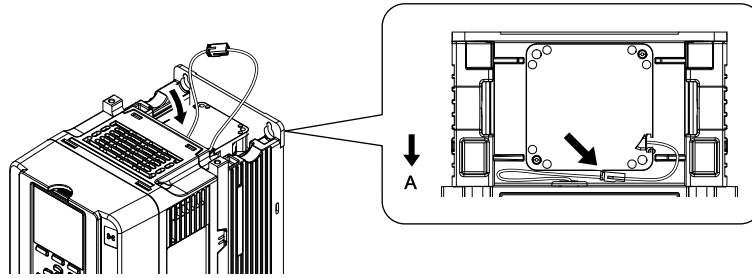

A - Drive front surface

Figure 7.4 Connect Cooling Fan Power Supply Connectors

3. Guide the fan finger guard until it clicks back into place while pressing in on the hooks on the left and right sides of the fan finger guard.

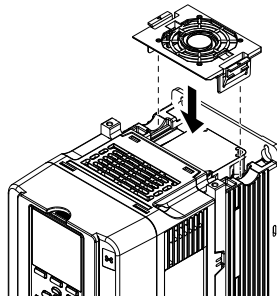

Figure 7.5 Reattach a Fan Finger Guard

4. Energize the drive and set $\alpha 4-03 = 0$ [CoolingFan OperationTime Setting = 0 h] to reset it.

◆ Replace a Fan (Procedure B)

WARNING! Electrical Shock Hazard. Do not perform inspections or wiring while the drive is energized. De-energize all devices before carrying out any wiring or repair operations. Voltage will remain within the capacitors inside the drive even after the power has been switched off. The Charge LED is extinguished once the DC bus voltage goes below 50 V DC. To prevent electric shock, always wait for at least the amount of time indicated on the warning labels and confirm that all indicators are OFF. Then, remove the front cover and terminal cover, measure the input power supply voltage and the DC bus voltage, and make sure that the voltages have been lowered to safe levels. Failure to comply may result in death or serious injury.

CAUTION! Preventing Burns. Do not touch the heatsink of the drive as it is very hot. To replace cooling fans, de-energize the drive and wait at least 15 minutes. Make sure the heatsink has sufficiently cooled before proceeding to replace a fan. Touching the device may result in burns in certain circumstances.

NOTICE: Follow cooling fan replacement instructions. Replace all fans when performing maintenance to help ensure maximum useful product life. Improper fan replacement could cause damage the drive.

■ Remove a Fan

1. Depress the back sides of the fan finger guard tabs forward and pull upward. Remove the fan finger guard from the top of the drive.

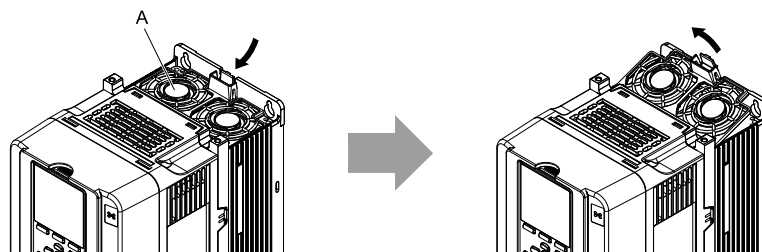

A - Fan finger guard

Figure 7.6 Remove a Fan Finger Guard

- Lift up directly on the cooling fan. Unplug the power supply connector and release the fan from the drive.

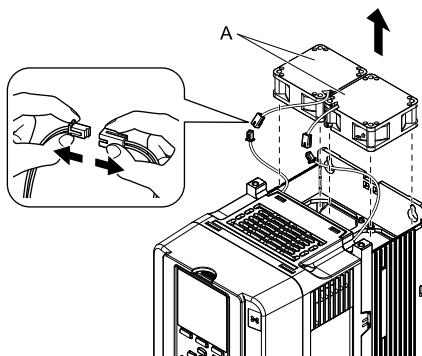

A - Cooling fan

Figure 7.7 Remove a Cooling Fan

■ Install a Fan

Reverse the removal procedure to reinstall the cooling fan.

- Install the replacement cooling fan into the drive, ensuring the protrusions on the drive line up with the notches on the fan.

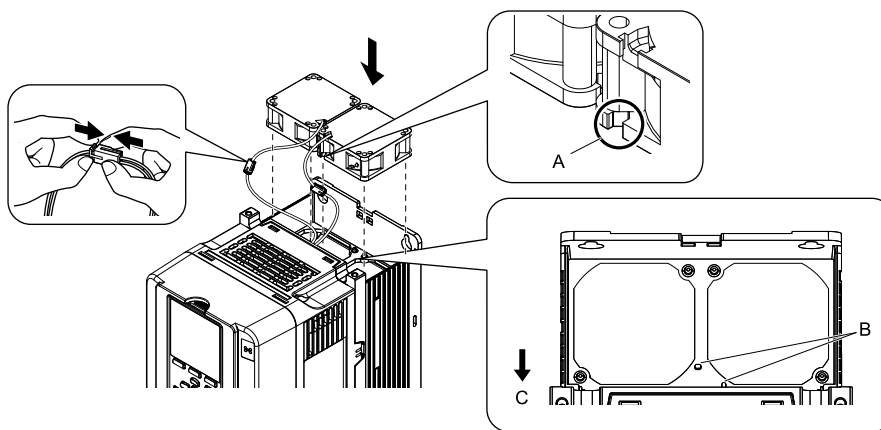
A - Notch of fan
B - Protrusions of drive

C - Drive front surface

Figure 7.8 Install a Cooling Fan

- Properly connect the fan power lines, then place the cable back into the recess of the drive.

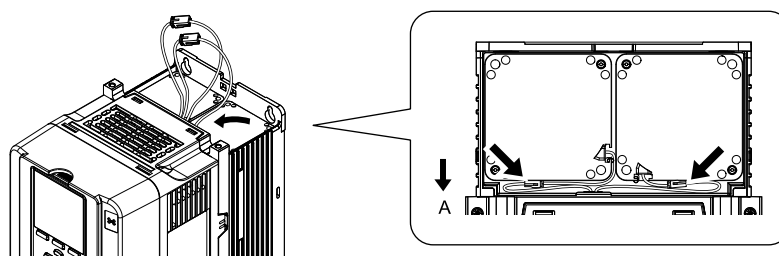

A - Drive front surface

Figure 7.9 Connect Cooling Fan Power Supply Connectors

3. Angle the fan finger guard and insert the connector tabs into the corresponding holes on the drive.

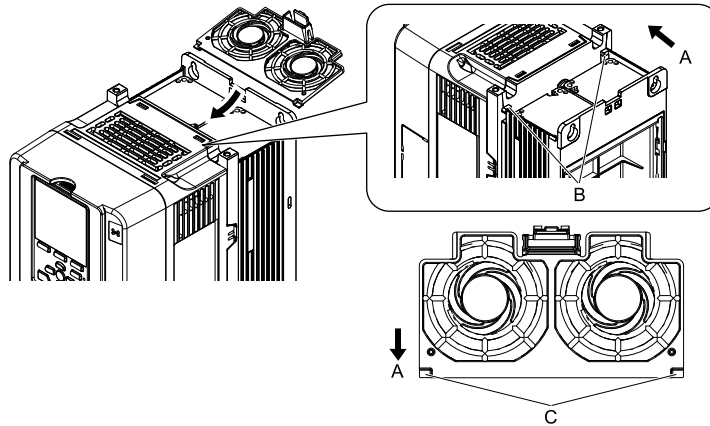

A - Drive front surface

B - Holes for connector tabs

C - Tabs

Figure 7.10 Reattach a Fan Finger Guard

4. Guide the fan finger guard until it clicks back into place while pressing in on the hooks of the left and right sides of the fan finger guard.

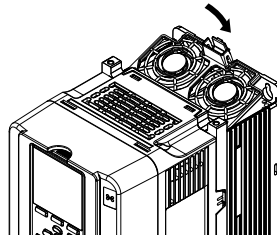

Figure 7.11 Reattach a Fan Finger Guard

5. Energize the drive and set $o4-03 = 0$ [CoolingFan OperationTime Setting = 0 h] to reset it.

◆ Replace a Fan (Procedure C)

WARNING! Electrical Shock Hazard. Do not perform inspections or wiring while the drive is energized. De-energize all devices before carrying out any wiring or repair operations. Voltage will remain within the capacitors inside the drive even after the power has been switched off. The Charge LED is extinguished once the DC bus voltage goes below 50 V DC. To prevent electric shock, always wait for at least the amount of time indicated on the warning labels and confirm that all indicators are OFF. Then, remove the front cover and terminal cover, measure the input power supply voltage and the DC bus voltage, and make sure that the voltages have been lowered to safe levels. Failure to comply may result in death or serious injury.

CAUTION! Preventing Burns. Do not touch the heatsink of the drive as it is very hot. To replace cooling fans, de-energize the drive and wait at least 15 minutes. Make sure the heatsink has sufficiently cooled before proceeding to replace a fan. Touching the device may result in burns in certain circumstances.

NOTICE: Follow cooling fan replacement instructions. Replace all fans when performing maintenance to help ensure maximum useful product life. Improper fan replacement could cause damage the drive.

■ Remove a Fan

1. Free the fan finger guard by pulling upward while pressing in on the hooks located on the left and right sides of the fan finger guard.

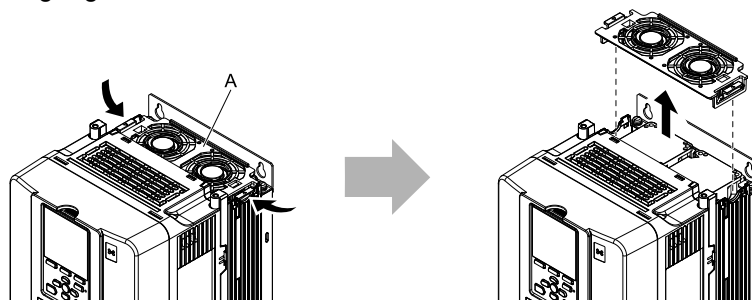

A - Fan finger guard

Figure 7.12 Remove a Fan Finger Guard

2. Lift up directly on the cooling fan. Unplug the power supply connector and release the fan from the drive.

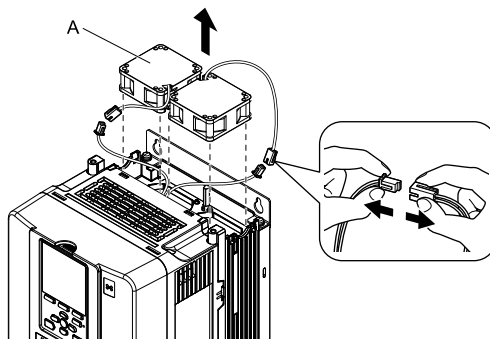

A - Cooling fan

Figure 7.13 Remove a Cooling Fan

■ Install a Fan

Reverse the removal procedure to reinstall the cooling fan.

1. Install the replacement cooling fan into the drive, ensuring the protrusions on the drive line up with the notches on the fan.

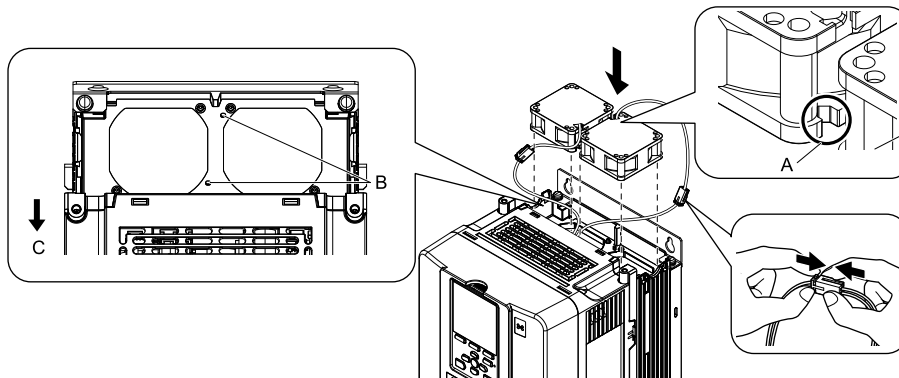

A - Notch of fan

B - Protrusions of drive

C - Drive front surface

Figure 7.14 Install a Cooling Fan

2. Properly connect the fan power lines, then place the cable back into the recess of the drive.

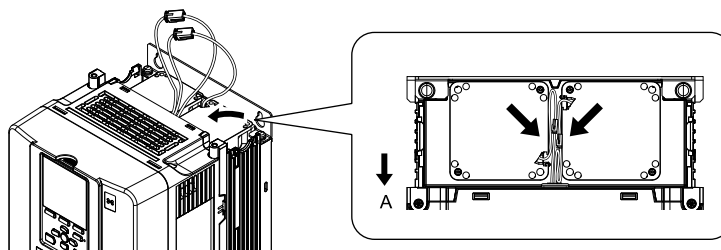

A - Drive front surface

Figure 7.15 Connect Cooling Fan Power Supply Connectors

7.4 Replace a Cooling Fan and Circulation Fan

3. Guide the fan finger guard until it clicks back into place while pressing in on the hooks on the left and right sides of the fan finger guard.

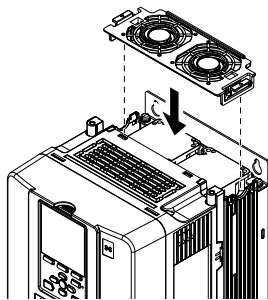

Figure 7.16 Reattach a Fan Finger Guard

4. Energize the drive and set $o4-03 = 0$ [*CoolingFan OperationTime Setting = 0 h*] to reset it.

7.5 Replace the Drive

◆ About the Control Circuit Terminal Block

The control circuit terminal block of this product can be attached and detached. The control circuit terminal block can be easily replaced if the drive fails to operate correctly.

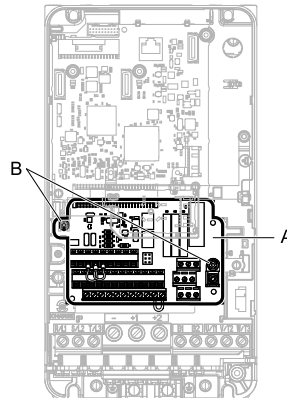

A - Control circuit terminal block

B - Control circuit terminal block fastening screw

Figure 7.17 Control Circuit Terminal Block

◆ Replace the Drive

WARNING! Electrical Shock Hazard. While the drive is ON, never attempt to change any wiring, disconnect any option cards or connectors, or replace the cooling fan. Before performing any repairs, shut OFF the power supply to the drive and verify that there is no residual voltage in the unit. Failure to do so may result in serious electric shock.

WARNING! Electrical Shock Hazard. Only authorized persons qualified in electrical work should perform installation, wiring, maintenance, inspections, parts replacement, and repairs. Failure to comply may cause electrical shock.

WARNING! Electrical Shock Hazard. Do not perform inspections or wiring while the drive is energized. De-energize all devices before carrying out any wiring or repair operations. Voltage will remain within the capacitors inside the drive even after the power has been switched off. The Charge LED is extinguished once the DC bus voltage goes below 50 V DC. To prevent electric shock, always wait for at least the amount of time indicated on the warning labels and confirm that all indicators are OFF. Then, remove the front cover and terminal cover, measure the input power supply voltage and the DC bus voltage, and make sure that the voltages have been lowered to safe levels. Failure to comply may result in death or serious injury.

NOTICE: Observe proper electrostatic discharge (ESD) procedures when handling the drive and circuit boards. Failure to comply could cause ESD damage to the drive circuitry.

■ Remove the Control Circuit Terminal Block

First remove the keypad and front cover.

1. Loosen the screws on the control circuit terminal block.

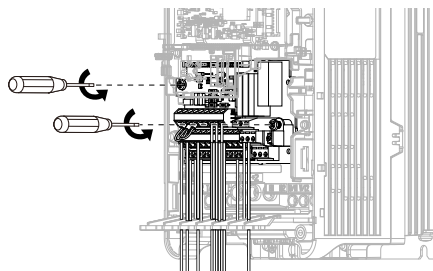

Figure 7.18 Loosen Fastening Screws

- Slide the wired control circuit terminal block in the direction of the arrow to remove it.

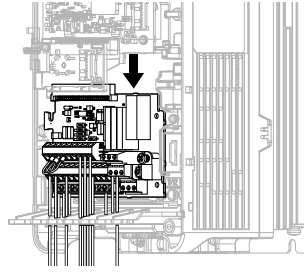

Figure 7.19 Remove the Control Circuit Terminal Block

■ Wire a New Drive

First remove the keypad, front cover, and control circuit terminal block of the newly installed drive. Wire the drive to the main circuit terminal block before installing a wired control circuit terminal block.

Note:

- Do not twist the core wire of the electric wire. Failure to comply may result in a decrease in the clamping strength of the terminal blocks.
- Do not shake the electrical wire excessively.
- Do not use wires in which the core wire is crushed or bent.
- Be sure to use only the wires with size, stripped wire length, and tightening torque specified by Yaskawa.
- Use tools that fit the shape of the screw head when tightening or loosening the terminal block screws.
- Confirm that there is no slack in wiring or that there are no frayed wires after the wiring process is completed.
- Install strain relief to prevent excessive stress.

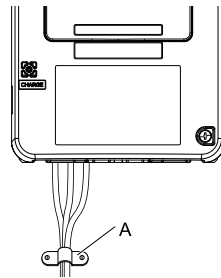

A - Strain relief

Figure 7.20 Install Stress Relief

- Remove the wiring cover by pulling it forward.

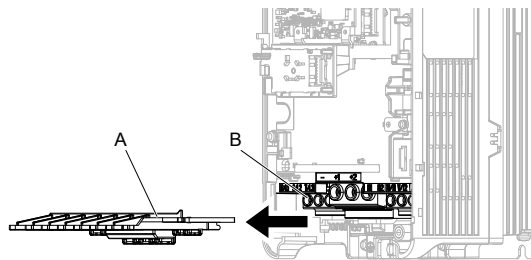

A - Wiring cover

B - Main circuit terminal block

Figure 7.21 Remove the Wiring Cover

- Turn the screw in the direction as illustrated in the figure for the desired main circuit terminal block to completely open the terminal block opening.

Note:

The terminal block opening is shipped from the factory in the open state.

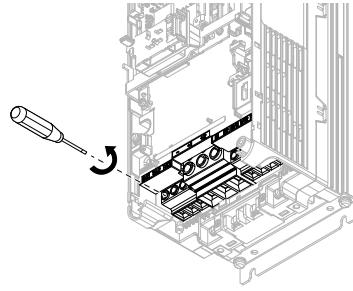

Figure 7.22 Loosen Terminal Block Screws

3. Insert a wire with prepared ends into the main circuit terminal block.

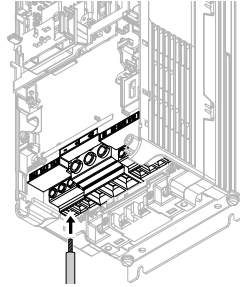

Figure 7.23 Install the Electrical Wire

Note:

- When wiring to terminals +1 and +2, if a jumper connects terminals +1 and +2, first loosen the terminal block screws and remove the jumper.

4. Tighten the screws to the specified torque.

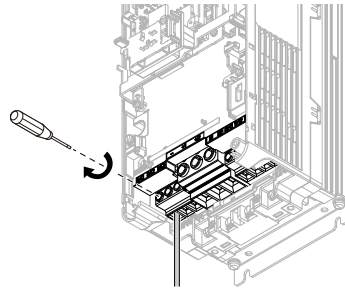
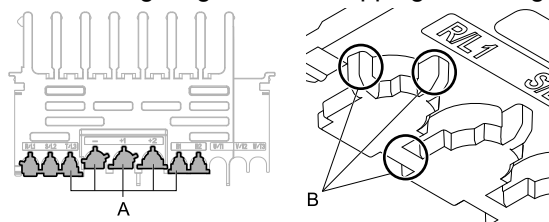

Figure 7.24 Tighten Terminal Block Screws

5. Check the signal from the wired terminal and use a nipper to clip the cutaway section of the corresponding wiring cover.

Use nippers as shown in the following diagram when clipping the wiring cover.



A - Cutaway section

B - Clip here with nippers

Figure 7.25 Clip the Cutaway Section of the Wiring Cover

Note:

- The shape of the wiring cover differs depending on the drive model.
- Detach the cutaway section of the wiring cover by clipping only the areas that apply to the wired terminal. If areas that do not apply to the wired terminal are clipped, the protective enclosure will not maintain the IP20 protective level.
- Be careful when clipping the cutaway section of the wiring cover, as the section may fly out in unpredictable directions.
- Process the cross section to prevent the cutaway section of the wiring cover from damaging the electric wires.
- If electrical wires other than those specified by Yaskawa are used, the protective enclosure may not maintain the IP20 protective level, even if the wiring cover is used correctly. Contact Yaskawa or your nearest sales representative for details.

7.5 Replace the Drive

6. Install the wiring cover at its original position. Pass the cables through the holes that were cut out of the wiring cover.

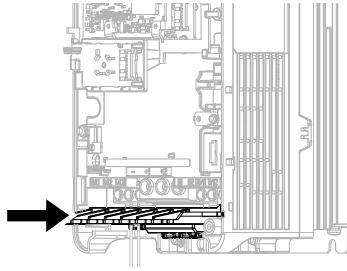
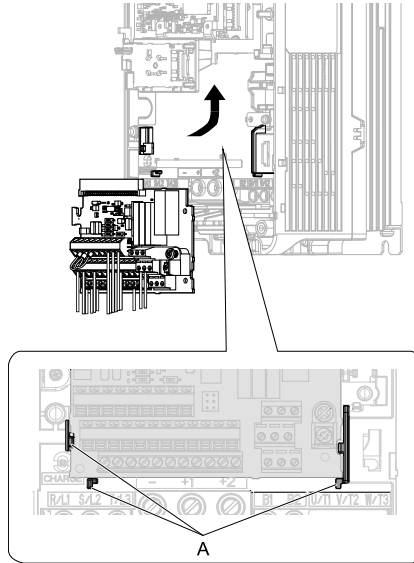

Figure 7.26 Reattach the Wiring Cover

7. Insert the wired control circuit terminal block and then slide it into the connector. Slide the control terminal block while aligning the bottom with the guide.



A - Guide

Figure 7.27 Insert the Terminal Block into the Connector

8. Tighten the fastening screw.

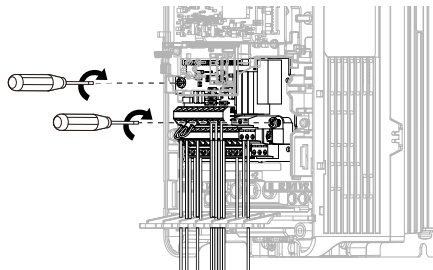

Figure 7.28 Secure the Terminal Block

9. Install the front cover and the keypad at their original positions.
10. Check *o2-04 [Drive Model Selection]*.

Note:

- If parameter information has been stored in the keypad that was installed prior to replacement, use the keypad to restore that information.
- To reset the performance life monitors for the parts, set *o4-01 to o4-13 [Maintenance Period]*.

7.6 Replace the Keypad Battery

When the keypad battery runs out, the date and time return to the factory settings. Replace the battery according to the following procedure.

WARNING! Preventing Fire. Handle keypad batteries properly. Do not attempt to charge the battery or disassemble the keypad. Improper handling may result in batteries bursting and igniting, which could cause fire and injury.

When replacing the battery, use a Hitachi Maxell “CR2016 Lithium Manganese Dioxide Battery” or the equivalent.

- Voltage: 3 V
- Operating temperature range: -20°C - +85°C (-4°F - +185°F)

WARNING! Preventing Fire. Do not disassemble batteries. Do not expose batteries to heat or fire. Improper handling may result in batteries bursting and igniting, which could cause fire and injury.

NOTICE: The battery remains in use even when power to the drive has been shut off. Be sure to also remove the battery in the keypad when the drive will be shut off for long periods of time. Replace the battery with a new one immediately after the expected lifespan has passed. A dead battery left inside the keypad may leak and damage the keypad and drive.

1. De-energize the drive and remove the keypad.
2. Insert the tip of a straight-edge screwdriver into the slot in the center of the battery cover, and turn the battery cover counterclockwise to remove it.

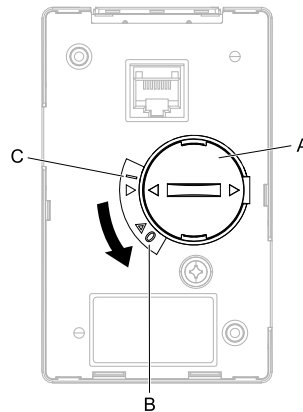

A - Battery cover
B - Open

C - Close

Figure 7.29 Remove the Battery Cover

3. Remove the used battery from the keypad.
4. Insert the new battery.

Note:

- The battery cover side is the positive pole. Insert the battery with the correct orientation into the keypad to ensure that the polarity is correct.
- Discard the used battery in accordance with local regulations.

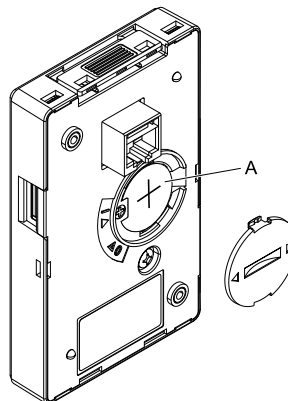

A - Battery

Figure 7.30 Insert a New Battery

5. Install the keypad battery cover, then insert the tip of a straight-edge screwdriver into the slot in the center of the battery cover, and turn the battery cover clockwise to close it.

7.6 Replace the Keypad Battery

6. Install the keypad into the drive.
7. Energize the drive and set $o4-17 = 1$ [*RTC Time Setting = Time Setting Screen Display*] to set the time.

7.7 Storage Guidelines

The drive contains electrolytic capacitors and fine electronic parts that undergo chemical changes. Observe the following precautions to help maintain the expected performance life and reliability during long-term storage.

◆ Storage Location

- Temperature and Humidity

Store the drive in a location that is between $-10\text{ }^{\circ}\text{C}$ to $+40\text{ }^{\circ}\text{C}$ ($14\text{ }^{\circ}\text{F}$ to $104\text{ }^{\circ}\text{F}$) with a relative humidity of 95% or less. Do not store the drive in direct sunlight or where condensation or ice will form.

Storage temperatures between $-20\text{ }^{\circ}\text{C}$ to $+70\text{ }^{\circ}\text{C}$ ($4\text{ }^{\circ}\text{F}$ to $158\text{ }^{\circ}\text{F}$) are allowed when storing the drive for approximately one month.

Note:

Package and store the drive during shipping to protect it from vibration and shock.

- Dust and Oil Mist

Do not store the drive in dusty locations or locations that are subject to oil mist, such as the site of a cement factory or cotton mill.

- Corrosive Gas

Do not store the drive in locations that are subject to corrosive gas, such as the site of a chemical plant, a refinery, or sewage plant.

- Salt Damage

Do not store the drive in locations that are subject to salt damage, such as near the ocean, and salt damage-designated zones, in particular.

Do not store the drive in adverse environments. Store all drives in storage rooms that are not subjected to adverse environmental elements.

◆ Periodic Power Application

Yaskawa recommends applying power to the drive once per year for at least 30 minutes to prevent the capacitors from deteriorating.

When applying power after power has not been applied for more than two years, Yaskawa recommends using a variable power source and gradually increasing the power from 0 V to the rated drive voltage over a period of 2 to 3 minutes. Apply power for at least 1 hour with no load to age the main circuit electrolytic capacitor. Wire the drive normally and check for drive faults, overcurrents, motor vibration, speed fluctuations, and other abnormalities during operation after performing the above procedure.

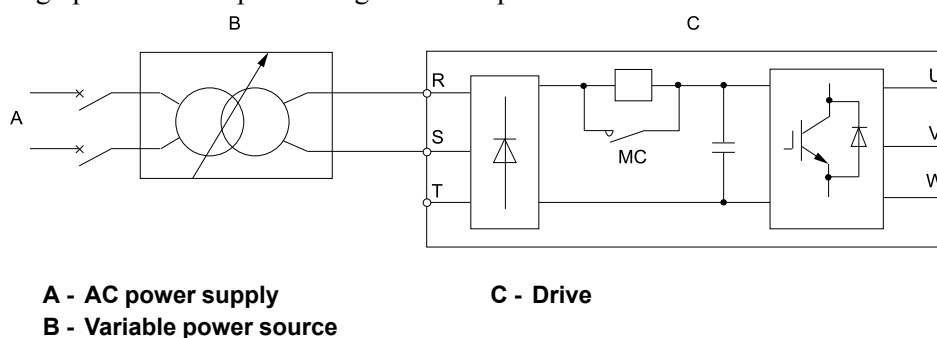

Figure 7.31 Power Distribution Method

Disposal

8.1	Section Safety	358
8.2	Disposal Instructions	359

8.1 Section Safety

DANGER

Electrical Shock Hazard

After wiring the drive, safely check that all electrical connects are correct and that all covers are correctly installed before turning on the power. If the drive is already energized, de-energize the power and wait at least 5 minutes until the Charge LED completely turns off. Remove the front cover and terminal cover to access wiring, circuit boards, and other parts. Terminals must only be used for their intended purpose.

Improper wiring, improper ground connections, and improper repair of protective covers could result in electric shock, which could lead to equipment damage, injury, and even death.

WARNING

Electrical Shock Hazard

Only authorized persons qualified in electrical work should perform installation, wiring, maintenance, inspections, parts replacement, and repairs.

Failure to comply may cause electrical shock.

Do not perform work on the drive while wearing loose clothing or jewelry. Before servicing, secure loose clothing and remove all metal objects such as watches or rings.

Failure to comply could cause death or serious injury.

Preventing Fire

Handle keypad batteries properly. Do not attempt to charge the battery or disassemble the keypad.

Improper handling may result in batteries bursting and igniting, which could cause fire and injury.

Do not disassemble batteries. Do not expose batteries to heat or fire.

Improper handling may result in batteries bursting and igniting, which could cause fire and injury.

Crush Hazard

Do not perform work on the drive without eye protection. Wear eye protection before beginning work on the drive.

Failure to comply could result in serious injury.

Only allow qualified personnel to operate a crane or hoist to transport the drive.

Failure to comply could cause death or serious injury from falling equipment.

Use a dedicated lifter when transporting the drive by a lifter.

Failure to comply could cause death or serious injury from falling equipment.

CAUTION

Crush Hazard

Do not carry the drive by the front cover or terminal cover. Make sure that screws are tightened properly during transport.

The cover of the drive may come off and the drive may fall if it is carried by the front cover or terminal cover or if screws are loose, which can result in injury.

NOTICE

The battery remains in use even when power to the drive has been shut off. Be sure to also remove the battery in the keypad when the drive will be shut off for long periods of time. Replace the battery with a new one immediately after the expected lifespan has passed.

A dead battery left inside the keypad may leak and damage the keypad and drive.

8.2 Disposal Instructions

Properly dispose of the following parts and materials in accordance with local and municipal laws for this product. Carry out disposal in accordance with the laws and regulations for each country outside the territory of Japan. (Example: European Waste 16 02 14)

- Drive
- Packing material
- Battery
- microSD card

CAUTION! *Crush Hazard. Discard the battery after insulating the electrodes with tape. Heat generation and rupturing cause accidents.*

Note:

- Before disposing of the drive, remove the battery and microSD card from the keypad.
- The battery is not recyclable. Dispose of the old battery in accordance with the procedure described in the battery manufacturer's manual.
- It is the customer's responsibility to protect the data in the microSD card.
Formatting and deleting using PC functions may not be enough to completely wipe the data in the microSD card. Yaskawa recommends that the microSD card be physically destroyed in a shredder or the data on the microSD card be completely erased with data wipe software that is available for PCs.

Specifications

9.1	Safety Precautions	362
9.2	Heavy Duty and Normal Duty Ratings.....	363
9.3	Model Specifications (200 V Class)	364
9.4	Model Specifications (400 V Class)	367
9.5	Drive Specifications.....	371
9.6	Drive Derating	375
9.7	Drive Exterior and Mounting Dimensions.....	379
9.8	Knock-out Hole Dimensions (UL Type 1).....	385
9.9	Peripheral Devices and Options.....	386

9.1 Safety Precautions

DANGER

Heed the safety messages in this manual. Failure to comply will result in death or serious injury.

The operating company is responsible for any injuries or equipment damage resulting from failure to heed the warnings in this manual.

9.2 Heavy Duty and Normal Duty Ratings

The ratings for this product are based on two types of load ratings depending on the load characteristics of an application: Heavy Duty Rating (HD) and Normal Duty Rating (ND).

Refer to the following table for more information on the differences between a Heavy Duty Rating and a Normal Duty Rating.

Duty Rating	C6-01 Setting	Application	Default Carrier Frequency	Overload Tolerance (oL2)
Heavy Duty Rating 1 (HD1)	0	<ul style="list-style-type: none"> • Extruder • Conveyor • Crane or hoist • Applications that require constant torque or high overload capacity 	2 kHz	150% of the rated output current for 60 s
Normal Duty Rating 1 (ND1)	1	<ul style="list-style-type: none"> • Fan • Pump • Blower • Applications that require variable speed control 	2 kHz Swing-PWM	110% of the rated output current for 60 s

9.3 Model Specifications (200 V Class)

Table 9.1 Rating (200 V Class)

Model		2004	2006	2008	2010	2012	2018	2021	2030	2042	2056	2070	2082	2110	2138																
Max. Applicable Motor Output (kW)	HD *1	0.4	0.75	1.1	1.5	2.2	3	3.7	5.5	7.5	11	Preparing																			
	ND *2	0.75	1.1	1.5	2.2	3	3.7	5.5	7.5	11	15																				
Input	Rated Input Current *3 (A)	HD	3.6	4.8	6.7	8.9	12.7	17	20.7	30	40.3					58.2	Preparing														
		ND	4.8	6.7	8.9	12.7	17	20.7	30	40.3	52					78.4															
Output	Rated Output Capacity (kVA)	HD *4	1.2	1.9	2.6	3.0	4.2	5.3	6.7	9.5	12.6					17.9					Preparing										
		ND *5	1.3	2.3	3.0	3.7	4.6	6.7	8.0	11.4	16.0					21.3															
	Rated Output Current (A)	HD	3.2	5	6.9	8	11	14	17.5	25	33					47									Preparing						
		ND	3.5	6	8	9.6	12.2	17.5	21	30	42					56															
Output	Overload Tolerance	<ul style="list-style-type: none"> Heavy Duty (Rating): 150% of the rated output current for 60 seconds Normal Duty (Rating): 110% of the rated output current for 60 seconds Note: Derating may be required for applications that start and stop frequently.																													
	Carrier Frequency	HD: Usable up to 8 kHz without derating ND: Usable up to 2 kHz without derating Derating the output current enables use up to a maximum of 15 kHz.																													
	Maximum Output Voltage (V)	Three-phase 200 V to 240 V Note: The maximum output voltage is proportional to the input voltage.																													
	Maximum Output Frequency	<ul style="list-style-type: none"> AOLV (Advanced Open Loop Vector Control) and EZOLV (EZ Open Loop Vector Control): 120 Hz CL-V/f (Closed Loop V/f Control), CLV (Closed Loop Vector Control), AOLV/PM (Advanced Open Loop Vector Control for PM), and CLV/PM (Closed Loop Vector Control): 400 Hz V/f (V/f Control), OLV (Open Loop Vector Control), and OLV/PM (Open Loop Vector Control for PM): 590 Hz 																													
Measures for Harmonics	DC reactor	External options											Standard internal features																		
Braking Device	Braking Transistor	Standard internal features																													
EMC filter	EMC filter IEC61800-3, C2/C3	Factory option <ul style="list-style-type: none"> Models 2xxxB: A category C3 EMC filter is built into the device. Models 2xxxC: A category C2 EMC filter is built into the device. 																													

Model		2004	2006	2008	2010	2012	2018	2021	2030	2042	2056	2070	2082	2110	2138
Power supply	Rated Voltage/ Rated Frequency	<ul style="list-style-type: none"> Three-phase AC power supply 200 V to 240 V at 50/60 Hz DC power supply 270 V to 340 V 													
	Allowable Voltage Fluctuation	-15% to +10%													
	Allowable Frequency Fluctuation	±5%													
	Power Facility Capacity (kVA)	HD	1.5	2.0	2.8	3.7	5.3	7.1	8.6	12.5	16.8	24.2	Preparing		
	ND	2.0	2.8	3.7	5.3	7.1	8.6	12.5	16.8	21.6	32.6				

- *1 The maximum applicable motor output is compliant with 208 V motor ratings as described in NEC Table 430.250. The rated output current of the drive output amps should be equal to or greater than the motor rated current.
- *2 The maximum applicable motor output is compliant with general use, 4-pole 220 V motor ratings. The rated output current of the drive output amps should be equal to or greater than the motor rated current.
- *3 Assumes the value at the rated output current. Input current rating varies depending on the power supply transformer, input reactor, wiring connections, and power supply impedance.
- *4 The rated output capacity is calculated with a rated output voltage of 208 V.
- *5 The rated output capacity is calculated with a rated output voltage of 220 V.

Table 9.2 Rating (200 V Class)

Model		2169	2211	2257	2313	2360	2415	
Max. Applicable Motor Output (kW)	HD *1	Preparing						
	ND *2							
Input	Rated Input Current *3(A)							HD
	ND							
Output	Rated Output Capacity (kVA)							HD *4
								ND *5
	Rated Output Current (A)							HD
								ND
	Overload Tolerance							<ul style="list-style-type: none"> Heavy Duty (Rating): 150% of the rated output current for 60 seconds Normal Duty (Rating): 110% of the rated output current for 60 seconds Note: Derating may be required for applications that start and stop frequently.
	Carrier Frequency							HD: Usable up to 5 kHz without derating ND: Usable up to 2 kHz without derating Derating the output current enables use up to a maximum of 10 kHz.
Maximum Output Voltage (V)	Three-phase 200 V to 240 V Note: The maximum output voltage is proportional to the input voltage.							
Maximum Output Frequency	<ul style="list-style-type: none"> AOLV (Advanced Open Loop Vector Control) and EZOLV (EZ Open Loop Vector Control): 120 Hz CL-V/f (Closed Loop V/f Control), CLV (Closed Loop Vector Control), AOLV/PM (Advanced Open Loop Vector Control for PM), and CLV/PM (Closed Loop Vector Control): 400 Hz V/f (V/f Control), OLV (Open Loop Vector Control), and OLV/PM (Open Loop Vector Control for PM): 590 Hz 							
Measures for Harmonics	DC reactor	Standard internal features						
Braking Device	Braking Transistor	External options						
EMC filter	EMC filter IEC61800-3, C2/C3	Factory option <ul style="list-style-type: none"> Models 2xxxB: A category C3 EMC filter is built into the device. Models 2xxxC: A category C2 EMC filter is built into the device. 						

9.3 Model Specifications (200 V Class)

Model		2169	2211	2257	2313	2360	2415
Power supply	Rated Voltage/Rated Frequency	<ul style="list-style-type: none"> • Three-phase AC power supply 200 V to 240 V at 50/60 Hz • DC power supply 270 V to 340 V 					
	Allowable Voltage Fluctuation	-15% to +10%					
	Allowable Frequency Fluctuation	±5%					
	Power Facility Capacity (kVA)	HD	Preparing				
	ND						

- *1 The maximum applicable motor output is compliant with 208 V motor ratings as described in NEC Table 430.250. The rated output current of the drive output amps should be equal to or greater than the motor rated current.
- *2 The maximum applicable motor output is compliant with general use, 4-pole 220 V motor ratings. The rated output current of the drive output amps should be equal to or greater than the motor rated current.
- *3 Assumes the value at the rated output current. Input current rating varies depending on the power supply transformer, input reactor, wiring connections, and power supply impedance.
- *4 The rated output capacity is calculated with a rated output voltage of 208 V.
- *5 The rated output capacity is calculated with a rated output voltage of 220 V.

9.4 Model Specifications (400 V Class)

Table 9.3 Rating (400 V Class)

Model		Duty Rating	4002	4004	4005	4007	4009	4012	4018	4023	4031	4038	4044	4060	4075	4089	4103					
Max. Applicable Motor Output *1 (kW)	HD		0.4	0.75	1.5	2.2	3	3.7	5.5	7.5	11	15	Preparing									
	ND		0.75	1.5	2.2	3	3.7	5.5	7.5	11	15	18.5										
Input	Rated Input Current *2 (A)	HD	1.9	3.5	4.7	6.7	8.9	11.7	15.8	21.2	30.6	41.3										
		ND	2.5	4.7	6.7	8.9	11.7	15.8	21.2	30.6	41.3	50.5										
	Rated Output Capacity *3 (kVA)	HD	1.2	2.2	3.2	3.6	4.7	6.1	10	12	16	20										
		ND	1.4	2.7	3.6	4.7	5.9	7.8	12	15	20	25										
	Rated Output Current (A)	HD	1.8	3.4	4.8	5.5	7.2	9.2	14.8	18	24	31										
		ND	2.1	4.1	5.4	7.1	8.9	11.9	17.5	23.4	31	38										
Output	Overload Tolerance	<ul style="list-style-type: none"> Heavy Duty (Rating): 150% of the rated output current for 60 seconds Normal Duty (Rating): 110% of the rated output current for 60 seconds Note: Derating may be required for applications that start and stop frequently.																				
	Carrier Frequency	HD: Usable up to 8 kHz without derating ND: Usable up to 2 kHz without derating Derating the output current enables use up to a maximum of 15 kHz.																				
	Maximum Output Voltage (V)	Three-phase 380 V to 480 V Note: The maximum output voltage is proportional to the input voltage.																				
	Maximum Output Frequency	<ul style="list-style-type: none"> AOLV (Advanced Open Loop Vector Control) and EZOLV (EZ Open Loop Vector Control): 120 Hz CL-V/f (Closed Loop V/f Control), CLV (Closed Loop Vector Control), AOLV/PM (Advanced Open Loop Vector Control for PM), and CLV/PM (Closed Loop Vector Control): 400 Hz V/f (V/f Control), OLV (Open Loop Vector Control), and OLV/PM (Open Loop Vector Control for PM): 590 Hz 																				
Measures for Harmonics	DC reactor	External options										Standard internal features										
Braking Device	Braking Transistor	Standard internal features																				
EMC filter	EMC filter IEC61800-3, C2/C3	Factory option <ul style="list-style-type: none"> Models 4xxxB: A category C3 EMC filter is built into the device. Models 4xxxC: A category C2 EMC filter is built into the device. 																				

9.4 Model Specifications (400 V Class)

Model		Duty Rating	4002	4004	4005	4007	4009	4012	4018	4023	4031	4038	4044	4060	4075	4089	4103
Power supply	Rated Voltage/Rated Frequency	<ul style="list-style-type: none"> Three-phase AC power supply 380 V to 480 V at 50/60 Hz DC power supply 513 V to 679 V 															
	Allowable Voltage Fluctuation	-15% to +10%															
	Allowable Frequency Fluctuation	±5%															
	Power Facility Capacity (kVA)	HD	1.5	2.8	3.7	5.3	7.1	9.3	13	17	24	33	Preparing				
ND	2.0	3.7	5.3	7.1	9.3	13	17	24	33	40							

*1 The maximum applicable motor output is compliant with 380 V motor ratings as described in Annex G of IEC 60947-4-1. The rated output current of the drive output amps should be equal to or greater than the motor rated current.

*2 Assumes operation at the rated output current. Input current rating varies depending on the power supply transformer, input reactor, wiring connections, and power supply impedance.

*3 The rated output capacity is calculated with a rated output voltage of 380 V.

Table 9.4 Rating (400 V Class)

Model		Duty Rating	4140	4168	4208	4250	4296	4371	4389	
Max. Applicable Motor Output ^{*1} (kW)	HD		Preparing							
	ND									
Input	Rated Input Current ^{*2} (A)	HD								
		ND								
Output	Rated Output Capacity ^{*3} (kVA)	HD								
		ND								
	Rated Output Current (A)	HD								
		ND								
	Overload Tolerance	<ul style="list-style-type: none"> Heavy Duty (Rating): 150% of the rated output current for 60 seconds Normal Duty (Rating): 110% of the rated output current for 60 seconds Note: Derating may be required for applications that start and stop frequently.								
	Carrier Frequency	HD: Usable up to 5 kHz without derating ND: Usable up to 2 kHz without derating Derating the output current enables use up to a maximum of 10 kHz.								
Maximum Output Voltage (V)	Three-phase 380 V to 480 V Note: The maximum output voltage is proportional to the input voltage.									
Maximum Output Frequency	<ul style="list-style-type: none"> AOLV (Advanced Open Loop Vector Control) and EZOLV (EZ Open Loop Vector Control): 120 Hz CL-V/f (Closed Loop V/f Control), CLV (Closed Loop Vector Control), AOLV/PM (Advanced Open Loop Vector Control for PM), and CLV/PM (Closed Loop Vector Control): 400 Hz V/f (V/f Control), OLV (Open Loop Vector Control), and OLV/PM (Open Loop Vector Control for PM): 590 Hz 									
Measures for Harmonics	DC reactor	Standard internal features								
Braking Device	Braking Transistor	Standard internal features	External options							

Model		Duty Rating	4140	4168	4208	4250	4296	4371	4389
EMC filter	EMC filter IEC61800-3, C2/C3	Factory option <ul style="list-style-type: none"> Models 4xxxB: A category C3 EMC filter is built into the device. Models 4xxxC: A category C2 EMC filter is built into the device. 							
Power supply	Rated Voltage/Rated Frequency	<ul style="list-style-type: none"> Three-phase AC power supply 380 V to 480 V at 50/60 Hz DC power supply 513 V to 679 V 							
	Allowable Voltage Fluctuation	-15% to +10%							
	Allowable Frequency Fluctuation	±5%							
	Power Facility Capacity (kVA)	HD	Preparing						
	ND								

- *1 The maximum applicable motor output is compliant with 380 V motor ratings as described in Annex G of IEC 60947-4-1. The rated output current of the drive output amps should be equal to or greater than the motor rated current.
- *2 Assumes operation at the rated output current. Input current rating varies depending on the power supply transformer, input reactor, wiring connections, and power supply impedance.
- *3 The rated output capacity is calculated with a rated output voltage of 380 V.

Table 9.5 Rating (400 V Class)

Model		Duty Rating	4453	4568	4675	
Max. Applicable Motor Output *1(kW)		HD	Preparing			
		ND				
Input	Rated Input Current *2(A)	HD				
		ND				
Output	Rated Output Capacity *3(kVA)	HD				
		ND				
	Rated Output Current (A)	HD				
		ND				
	Overload Tolerance	<ul style="list-style-type: none"> Heavy Duty (Rating): 150% of the rated output current for 60 seconds Normal Duty (Rating): 110% of the rated output current for 60 seconds Note: Derating may be required for applications that start and stop frequently.				
	Carrier Frequency	HD: Usable up to 2 kHz without derating ND: Usable up to 2 kHz without derating Derating the output current enables use up to a maximum of 5 kHz.				
Maximum Output Voltage (V)	Three-phase 380 V to 480 V Note: The maximum output voltage is proportional to the input voltage.					
Maximum Output Frequency	<ul style="list-style-type: none"> AOLV (Advanced Open Loop Vector Control) and EZOLV (EZ Open Loop Vector Control): 120 Hz CL-V/f (Closed Loop V/f Control), CLV (Closed Loop Vector Control), AOLV/PM (Advanced Open Loop Vector Control for PM), and CLV/PM (Closed Loop Vector Control): 400 Hz V/f (V/f Control), OLV (Open Loop Vector Control), and OLV/PM (Open Loop Vector Control for PM): 590 Hz 					
Measures for Harmonics	DC reactor	Standard internal features				
Braking Device	Braking Transistor	External options				
EMC filter	EMC filter IEC61800-3, C2/C3	Factory option <ul style="list-style-type: none"> Models 4xxxB: A category C3 EMC filter is built into the device. Models 4xxxC: A category C2 EMC filter is built into the device. 				

9.4 Model Specifications (400 V Class)

Model		Duty Rating	4453	4568	4675
Power supply	Rated Voltage/Rated Frequency		<ul style="list-style-type: none"> • Three-phase AC power supply 380 V to 480 V at 50/60 Hz • DC power supply 513 V to 679 V 		
	Allowable Voltage Fluctuation		-15% to +10%		
	Allowable Frequency Fluctuation		±5%		
	Power Facility Capacity (kVA)	HD	Preparing		
	ND				

- *1 The maximum applicable motor output is compliant with 380 V motor ratings as described in Annex G of IEC 60947-4-1. The rated output current of the drive output amps should be equal to or greater than the motor rated current.
- *2 Assumes operation at the rated output current. Input current rating varies depending on the power supply transformer, input reactor, wiring connections, and power supply impedance.
- *3 The rated output capacity is calculated with a rated output voltage of 380 V.

9.5 Drive Specifications

Note:

- Perform Rotational Auto-Tuning to achieve the specifications listed for OLV, CLV, and AOLV.
- Install the drive in an environment that meets the required specifications for optimum performance life.

Table 9.6 Control Characteristics

Item	Specification
Control Method	The following control methods can be set using drive parameters: <ul style="list-style-type: none"> • V/f (V/f Control) • CL-V/f (Closed Loop V/f Control) • OLV (Open Loop Vector Control) • CLV (Closed Loop Vector Control) • AOLV (Advanced Open Loop Vector Control) • OLV/PM (Open Loop Vector Control for PM) • AOLV/PM (Advanced Open Loop Vector Control for PM) • CLV/PM (Closed Loop Vector Control for PM) • EZOLV (EZ Open Loop Vector Control)
Frequency control range	<ul style="list-style-type: none"> • AOLV and EZOLV: 0.01 to 120 Hz • CL-V/f, CLV, AOLV/PM, and CLV/PM: 0.01 to 400 Hz • V/f, OLV, and OLV/PM: 0.01 to 590 Hz
Frequency accuracy (temperature fluctuation)	Digital inputs: Within $\pm 0.01\%$ of the maximum output frequency ($-10\text{ }^{\circ}\text{C}$ to $+40\text{ }^{\circ}\text{C}$ ($14\text{ }^{\circ}\text{F}$ to $104\text{ }^{\circ}\text{F}$)) Analog inputs: Within $\pm 0.1\%$ of the maximum output frequency ($25\text{ }^{\circ}\text{C} \pm 10\text{ }^{\circ}\text{C}$ ($77\text{ }^{\circ}\text{F} \pm 18\text{ }^{\circ}\text{F}$))
Frequency Setting Resolution	Digital inputs: 0.01 Hz Analog input: 1/2048 of the maximum output frequency (11-bit signed)
Output Frequency Resolution	0.001 Hz
Frequency Setting Signal	Main speed frequency reference: -10 Vdc to $+10\text{ Vdc}$ (20 k Ω), 0 Vdc to 10 Vdc (20 k Ω), 4 mA to 20 mA (250 Ω), 0 mA to 20 mA (250 Ω) Main speed reference: Pulse train input (max. 32 kHz)
Starting Torque	<ul style="list-style-type: none"> • V/f Control: 150% / 3 Hz • Closed Loop V/f Control: 150% / 3 Hz • PM Open Loop Vector Control: 200% / 0.3 Hz • PM Closed Loop Vector Control: 200% / 0 min⁻¹ • PM Advanced Open Loop Vector: 200% / 0.3 Hz • PM Open Loop Vector Control: 100% / 5% speed • PM Advanced Open Loop Vector: 200% / 0 min⁻¹ • PM Closed Loop Vector Control: 200% / 0 min⁻¹ • EZ Open Loop Vector Control: 100% / 1% speed <p>Note: Drive capacity must be selected appropriately to obtain this starting torque under Open Loop Vector Control, Closed Loop Vector Control, Advanced Open Loop Vector Control for PM, and Closed Loop Vector Control for PM.</p>
Speed Control Range	<ul style="list-style-type: none"> • V/f Control: 1:40 • Closed Loop V/f Control: 1:40 • Open Loop Vector Control: 1:200 • Closed Loop V/f Control: 1:1500 • Advanced Open Loop Vector Control: 1:200 • Open Loop Vector Control Method for PM: 1:20 • PM Advanced Open Loop Vector: 1:100 (when high frequency injection is enabled) • Closed Loop Vector Control for PM: 1:1500 • EZ Open Loop Vector Control: 1:100

9.5 Drive Specifications

Item	Specification
Speed Control Accuracy	<ul style="list-style-type: none"> Open Loop Vector Control: $\pm 0.2\%$ (25 °C ± 10 °C (77 °F ± 18 °F)) Closed Loop Vector Control: $\pm 0.02\%$ (25 °C ± 10 °C (77 °F ± 18 °F)) Advanced Open Loop Vector Control: $\pm 0.2\%$ (25 °C ± 10 °C (77 °F ± 18 °F)) Open Loop Vector Control for PM: $\pm 0.2\%$ (25 °C ± 10 °C (77 °F ± 18 °F)) Advanced Open Loop Vector Control for PM: $\pm 0.2\%$ (25 °C ± 10 °C (77 °F ± 18 °F)) Closed Loop Vector Control for PM: $\pm 0.02\%$ (25 °C ± 10 °C (77 °F ± 18 °F)) EZ Open Loop Vector Control: $\pm 0.2\%$ (25 °C ± 10 °C (77 °F ± 18 °F)) <p>Note: Speed control accuracy varies depending on drive installation method and motor type. Contact Yaskawa or your nearest sales representative for details.</p>
Speed Response	<ul style="list-style-type: none"> V/f Control: Approximately 3 Hz Closed Loop V/f Control: Approximately 3 Hz Open Loop Vector Control: ± 10 (25 °C ± 10 °C (77 °F ± 18 °F)) Closed Loop Vector Control: 50 Hz (25 °C ± 10 °C (77 °F ± 18 °F)) Advanced Open Loop Vector Control: 20 Hz (25 °C ± 10 °C (77 °F ± 18 °F)) Open Loop Vector Control for PM: 10 Hz (25 °C ± 10 °C (77 °F ± 18 °F)) Advanced Open Loop Vector Control for PM: 40 Hz (25 °C ± 10 °C (77 °F ± 18 °F)) Closed Loop Vector Control for PM: 250 Hz (25 °C ± 10 °C (77 °F ± 18 °F)) EZ Open Loop Vector Control: 5 Hz (25 °C ± 10 °C (77 °F ± 18 °F)) <p>Note: Speed response varies depending on drive installation method and motor type.</p>
Zero Speed Control	Possible in CLV, AOLV/PM, and CLV/PM.
Torque Control	Parameter settings allow separate limits in four quadrants in OLV, CLV, AOLV, AOLV/PM, CLV/PM, EZOLV.
Accel and Decel Times	0.0 s to 6000.0 s The drive allows four selectable combinations of independent acceleration and deceleration settings.
Braking Torque	<p>Approx. 20%</p> <p>Approx. 125% with a dynamic braking option</p> <ul style="list-style-type: none"> Short-time average deceleration torque Motor capacity 0.4/0.75 kW: over 100% Motor capacity 1.5 kW: over 50% Motors 2.2 kW and larger: over 20%, Overexcitation Braking / High Slip Braking allow for approx. 40% Continuous regenerative torque: Approx. 20%. Dynamic braking option allows for approx. 125%, 10% ED, 10 s <p>Note:</p> <ul style="list-style-type: none"> Models 2004 to 2138 and 4002 to 4168 have a built-in braking transistor. Set $L3-04 = 0$ [<i>Decel Stall Prevention Selection = Disabled</i>] to disable Stall Prevention when using a regenerative converter, regenerative unit, dynamic braking unit, braking resistor, or braking resistor unit. The drive may not stop within the designated deceleration time if Stall Prevention is not disabled. Short-time deceleration torque refers to the torque required to decelerate the motor (uncoupled from the load) from the rated speed to zero. Actual specifications may vary depending on motor characteristics. Continuous regenerative torque and short-time deceleration torque for motors 2.2 kW and larger vary depending on motor characteristics.
V/f Characteristics	Select from 15 predefined V/f patterns, or a user-set V/f pattern.
Main Control Functions	Torque Control, Droop Control, Speed/Torque Control Switching, Feed Forward Control, Zero Servo Function, Restart After Momentary Power Loss, Speed Search, Overtorque/Undertorque Detection, Torque Limit, 17 Step Speed (max.), Accel/Decel Switch, S-curve Accel/Decel, 3-wire Sequence, Auto-Tuning (Rotational and Stationary), Dwell, Cooling Fan ON/OFF Switch, Slip Compensation, Torque Compensation, Frequency Jump, Upper/lower Limits for Frequency Reference, DC Injection Braking at Start and Stop, Overexcitation Braking, High Slip Braking, PID Control (with Sleep Function), Energy Saving Control, MEMOBUS/Modbus Communication (RS-485 max, 115.2 kbps), Fault Restart, Application Presets, DriveWorksEZ (customizable functions), Removable Terminal Block with Parameter Backup Function, Online Tuning, KEB, Overexcitation Deceleration, Inertia (ASR) Tuning, Overvoltage Suppression, High Frequency Injection.

Table 9.7 Protection Function

Item	Specification
Motor Protection	Electronic thermal overload protection
Momentary Overcurrent Protection	Drive stops when output current exceeds 200% of the HD output current.

Item	Specification
Overload Protection	Drive stops when output current exceeds 150% of the HD output current for 60 s. Note: The drive may trigger the overload protection function at 150% of the drive rated output in under 60 s if the output frequency is less than 6 Hz.
Overvoltage Protection	200 V class: Stops when DC bus voltage exceeds approx. 410 V 400 V class: Stops when DC bus voltage exceeds approx. 820 V
Undervoltage Protection	200 V class: Stops when DC bus voltage falls below approx. 190 V 400 V class: Stops when DC bus voltage falls below approx. 380 V
Momentary Power Loss Ride-thru	Stops when power loss is longer than 15 ms. Continues operation if power loss is shorter than 2 s (depending on parameter settings). Note: • Stop time may be shortened depending on the load and motor speed. • Continuous operation time varies by drive capacity. Models 2004 to 2056 and 4002 to 4031 require a Momentary Power Loss Recovery Unit to continue operation through a 2 s power loss.
Heatsink Overheat Protection	Thermistor
Braking Resistor Overheat Protection	Overheat detection for braking resistor (optional ERF-type, 3% ED)
Stall Prevention	Stall Prevention is available during acceleration, deceleration, and during run.
Ground Protection	Electronic circuit protection Note: This protection detects any ground faults during run. The drive will not provide protection when: • There is a low-resistance ground fault for the motor cable or terminal block • Energizing the drive when there is a ground fault present.
DC Bus Charge LED	Charge LED lits when DC bus voltage is above 50 V.

Table 9.8 Environment

Item	Specification
Area of Use	Indoors
Power supply	Overcurrent Category III
Ambient Temperature	Open chassis type (IP20): -10 °C to +50 °C (14 °F to 122 °F) Enclosed wall-mounted type (UL Type 1): -10 °C to +40 °C (14 °F to 104 °F) • Drive reliability improves in environments without wide temperature fluctuations. • When using the drive in a control panel, install a cooling fan or air conditioner in the area to ensure that the air temperature inside the enclosure does not exceed the specified levels. • Do not allow ice to develop on the drive. • Derate the output current and output voltage to install the drive in areas with ambient temperatures up to 60 °C (140 °F).
Humidity	95 RH% or less Do not allow condensation to develop on the drive.
Storage Temperature	-20 °C to +70 °C (-4 °F to +158 °F)
Surrounding Area	Pollution degree of no more than 2 Install the drive in an area free from: • oil mist and dust • metal shavings, oil, water, or other foreign materials • radioactive materials or flammable materials (e.x., wood) • Harmful gases and liquids • Low salinity • Chlorides Keep wood or other flammable materials away from the drive.

9.5 Drive Specifications

Item	Specification
Altitude	<p>1000 m (3281 ft) maximum</p> <p>Note: Derate the output current by 1% for every 100 m (328 ft.) to install the drive in altitudes between 1000 to 3000 m (3281 to 9843 ft.). Rated voltage derating is not required:</p> <ul style="list-style-type: none"> • when installing the drive at 2000 m (6562 ft.) or lower • if the drive is grounded with the neutral network when installing the drive at an altitude between 2000 to 3000 m (6562 to 9843 ft.) <p>Contact Yaskawa or your nearest sales representative when the drive is not grounded with the neutral network.</p>
Shock	<ul style="list-style-type: none"> • 10 Hz to 20 Hz: 1 G (9.8 m/s², 32.15 ft/s²) • 20 Hz to 55 Hz: 2004 to 2211, 4002 to 4168: 0.6 G (5.9 m/s², 19.36 ft/s²) 2257 to 2415, 4208 to 4675: 0.2 G (2.0 m/s², 6.56 ft/s²)
Installation Orientation	Install the drive upright to allow for proper cooling.

Table 9.9 Standard

Item	Specification
Harmonized Standard	<ul style="list-style-type: none"> • UL 61800-5-1 *1 • EN 61800-3 *2 • IEC/EN 61800-5-1:2007 *2 • Two Safe Disable inputs and one EDM output according to ISO/EN13849-1 Cat.III PL_e, IEC/EN61508 SIL3 (multi-function digital output) *2
Protection Design	<p>Open-chassis type (IP20) Enclosed wall-mounted type (UL Type 1)</p> <p>Note: Installing UL Type 1 kit on an open-chassis type (IP20) drive to convert the drive to a wall-mount enclosure (UL Type 1).</p>

*1 Approval pending for models 2070 to 2415, 4044 to 4675.

*2 Approval pending for models 2138 to 2415, 4089 to 4675.

9.6 Drive Derating

The drive can be operated at above the rated temperature, altitude, and default carrier frequency by derating the drive capacity.

◆ Carrier Frequency Settings and Rated Current Value

Table 9.10 and Table 9.11 illustrates the manner in which the drive rated output current changed depending on the carrier frequency settings. The output current value changes linearly in accordance with carrier frequency changes. Frequencies not listed in the following table can also be obtained by performing calculations with the values listed in the table. Refer to Table 9.12 and Table 9.13 when configured with Advanced Open Loop Vector Control.

Table 9.10 Carrier Frequency and Rated Current Derating (200 V Class)

Model	Rated Current (A)						
	Heavy Duty Rating (HD1)				Normal Duty Rating (ND1)		
	2 kHz	8 kHz	10 kHz	15 kHz	2 kHz	8 kHz	15 kHz
2004	3.2	3.2	-	2.78	3.5	2.9	2.10
2006	5.0	5.0	-	4.3	6	5	3.6
2008	6.9	6.9	-	5.4	8	6.9	5.4
2010	8.0	8.0	-	5.8	9.6	8	5.8
2012	11.0	11.0	-	8.8	12	11	9.3
2018	14.0	14.0	-	9.1	17.5	14	9.1
2021	17.5	17.5	-	12.6	21	17	12.5
2030	25.0	25.0	-	18.0	30	25	18.0
2042	33.0	33.0	29.3	-	42	33	20.4
2056	47.0	47.0	43.4	-	56	47	34.4
2070	Preparing						
2082							
2110							
2138							
2169							
2211							
2257							
2313							
2360							
2415							

Table 9.11 Carrier Frequency and Rated Current Derating (400 V Class)

Model	Rated Current (A)							
	Heavy Duty Rating (HD1)				Normal Duty Rating (ND1)			
	2 kHz	8 kHz	10 kHz	15 kHz	2 kHz	8 kHz	10 kHz	15 kHz
4002	1.8	1.8	-	1.0	2.1	1.8	-	1.4
4004	3.4	3.4	-	1.7	4.1	3.4	-	2.4
4005	4.8	4.8	-	3.0	5.4	4.8	-	3.9
4007	5.5	5.5	-	3.2	7.1	5.5	-	3.2
4009	7.2	7.2	-	4.8	8.9	7.2	-	4.8
4012	9.2	9.2	-	5.4	11.9	9.2	-	5.4
4018	14.8	14.8	13.7	-	17.5	14.8	13.7	-

9.6 Drive Derating

Model	Rated Current (A)							
	Heavy Duty Rating (HD1)				Normal Duty Rating (ND1)			
	2 kHz	8 kHz	10 kHz	15 kHz	2 kHz	8 kHz	10 kHz	15 kHz
4023	18.0	18.0	15.8	-	23	18.0	15.8	-
4031	24.0	24.0	21.2	-	31	24.0	21.1	-
4038	31.0	31.0	28.2	-	38	31.0	28.2	-
4044	Preparing							
4060								
4075								
4089								
4103								
4140								
4168								
4208								
4250								
4296								
4371								
4389								
4453								
4568								
4675								

Table 9.12 Advanced Open Loop Vector Control for PM Carrier Frequency and Rated Current Derating (200 V Class)

Model	Rated Current (A)						
	Heavy Duty Rating (HD1)				Normal Duty Rating (ND1)		
	2 kHz	4 kHz	8 kHz	12 kHz	2 kHz	4kHz	12 kHz
2004	3.2	3.2	-	2.6	3.5	3.1	1.7
2006	5.0	5.0	-	4.1	6.0	5.4	3.0
2008	6.9	6.9	-	4.7	8.0	7.3	4.7
2010	8.0	8.0	-	4.8	9.6	8.6	4.8
2012	11.0	11.0	-	7.9	12.2	11.5	8.6
2018	14.0	14.0	-	6.9	17.5	15.4	6.9
2021	17.5	17.5	-	10.4	21.0	18.9	10.4
2030	25.0	25.0	-	15.0	30.0	27.0	15.0
2042	33.0	33.0	25.7	-	42.0	36.6	15.0
2056	47.0	47.0	39.8	-	56.0	50.6	29.0

Model	Rated Current (A)						
	Heavy Duty Rating (HD1)				Normal Duty Rating (ND1)		
	2 kHz	4 kHz	8 kHz	12 kHz	2 kHz	4kHz	12 kHz
2070	Preparing						
2082							
2110							
2138							
2169							
2211							
2257							
2313							
2360							
2415							

Table 9.13 Advanced Open Loop Vector Control for PM Carrier Frequency and Rated Current Derating (400 V Class)

Model	Rated Current (A)							
	Heavy Duty Rating (HD1)				Normal Duty Rating (ND1)			
	2 kHz	4 kHz	8 kHz	12 kHz	2 kHz	4 kHz	8 kHz	12 kHz
4002	1.8	1.8	-	0.6	2.1	1.9	-	1.2
4004	3.4	3.4	-	1.0	4.1	3.7	-	2.0
4005	4.8	4.8	-	2.3	5.4	5.0	-	3.6
4007	5.5	5.5	-	2.3	7.1	6.1	-	2.3
4009	7.2	7.2	-	3.8	8.9	7.9	-	3.7
4012	9.2	9.2	-	3.8	11.9	10.3	-	3.8
4018	14.8	14.8	12.6	-	17.5	15.9	12.6	-
4023	18.0	18.0	13.7	-	23.4	20.1	13.6	-
4031	24.0	24.0	18.4	-	31.0	26.8	18.3	-
4038	31.0	31.0	25.4	-	38.0	33.8	25.4	-
4044	Preparing							
4060								
4075								
4089								
4103								
4140								
4168								
4208								
4250								
4296								
4371								
4389								
4453								
4568								
4675								

◆ Altitude Derating

Drive installations presumed to be located at altitudes of 1000 m (3281 ft.) or less.

Derate the output current by 1% for every 100 m (328 ft.) to install the drive in altitudes between 1000 m to 3000 m (3281 ft. to 9843 ft.).

Rated voltage derating is not required:

- when installing the drive at 2000 m (6562 ft.) or lower
 - if the drive is grounded with the neutral network when installing the drive at an altitude between 2000 m to 3000 m (6562 ft. to 9843 ft.)
- Contact Yaskawa or your nearest sales representative when the drive is not grounded with the neutral network.

9.7 Drive Exterior and Mounting Dimensions

◆ Open Chassis Type (IP20)

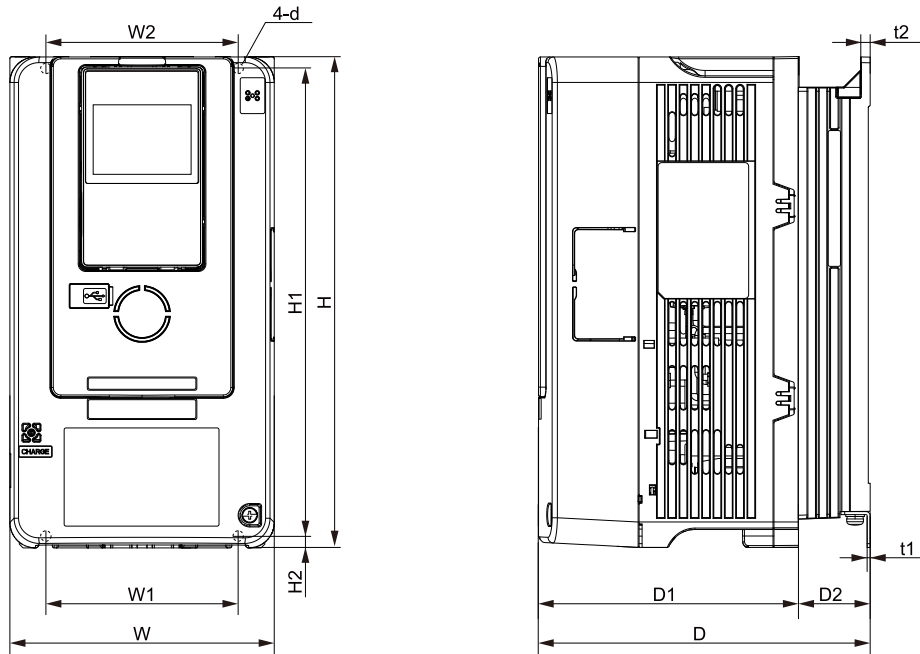

Figure 9.1 Exterior and Mounting Dimensions Diagram 1 (Models: 2004 to 2042 and 4002 to 4023)

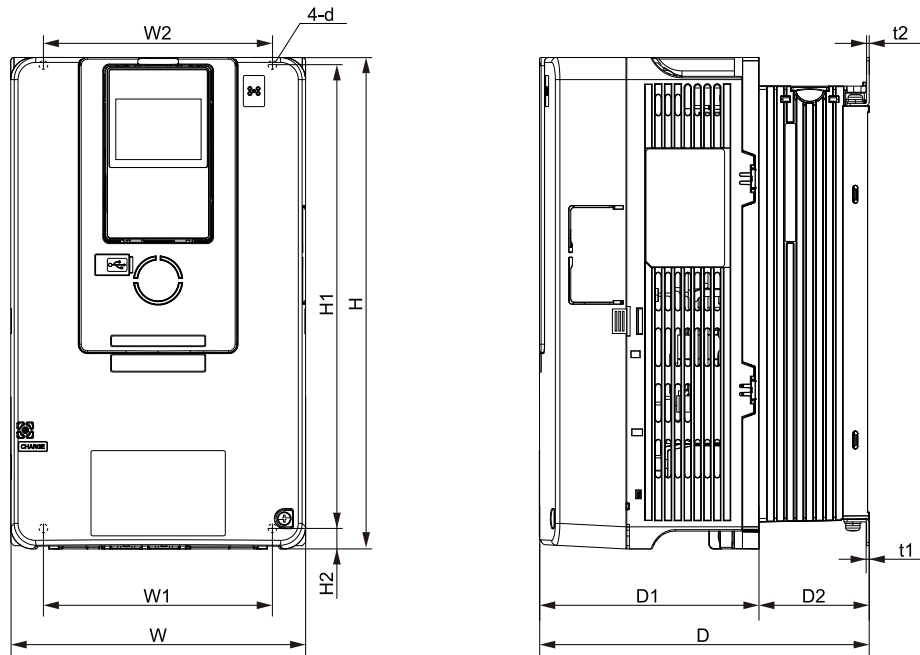

Figure 9.2 Exterior and Mounting Dimensions Diagram 2 (Models: 2056, 4031, and 4038)

9.7 Drive Exterior and Mounting Dimensions

Table 9.14 Exterior Dimensions (200 V class: IP20)

Model	Exterior and Mounting Dimensions	Dimensions in mm												Estimated weight kg
		W	H	D	D1	D2	W1	W2	H1	H2	t1	t2	d	
2004	Figure 9.1	140	260	176	138	38	102	102	248	6	1.6	5	M5	3.5
2006		140	260	176	138	38	102	102	248	6	1.6	5	M5	3.5
2008		140	260	176	138	38	102	102	248	6	1.6	5	M5	3.5
2010		140	260	176	138	38	102	102	248	6	1.6	5	M5	3.5
2012		140	260	176	138	38	102	102	248	6	1.6	5	M5	3.5
2018		140	260	211	138	73	102	102	248	6	1.6	5	M5	3.9
2021		140	260	211	138	73	102	102	248	6	1.6	5	M5	3.9
2030		140	260	211	138	73	102	102	248	6	1.6	5	M5	4.2
2042		140	260	211	138	73	102	102	248	6	1.6	5	M5	4.2
2056	Figure 9.2	180	300	202	134	68	140	140	284	8	1.6	1.6	M5	6
2070	-	Preparing												
2082														
2110														
2138														
2169														
2211														
2257														
2313														
2360														
2415														

Table 9.15 Exterior Dimensions (400 V class: IP20)

Model	Exterior and Mounting Dimensions	Dimensions in mm														Estimated weight kg
		W	H	D	D1	D2	W1	W2	W3	W4	H1	H2	t1	t2	d	
4002	Figure 9.1	140	260	176	138	38	102	102	-	-	248	6	1.6	5	M5	3.5
4004		140	260	176	138	38	102	102	-	-	248	6	1.6	5	M5	3.5
4005		140	260	176	138	38	102	102	-	-	248	6	1.6	5	M5	3.5
4007		140	260	211	138	73	102	102	-	-	248	6	1.6	5	M5	3.9
4009		140	260	211	138	73	102	102	-	-	248	6	1.6	5	M5	3.9
4012		140	260	211	138	73	102	102	-	-	248	6	1.6	5	M5	3.9
4018		140	260	211	138	73	102	102	-	-	248	6	1.6	5	M5	4.2
4023		140	260	211	138	73	102	102	-	-	248	6	1.6	5	M5	4.2
4031		Figure 9.2	180	300	202	134	68	140	140	-	-	284	8	1.6	1.6	M5
4038	180		300	202	134	68	140	140	-	-	284	8	1.6	1.6	M5	6

Model	Exterior and Mounting Dimensions	Dimensions in mm														Estimated weight kg
		W	H	D	D1	D2	W1	W2	W3	W4	H1	H2	t1	t2	d	
4044	-	Preparing														
4060																
4075																
4089																
4103																
4140																
4168																
4208																
4250																
4296																
4371																
4414																
4453																
4568																
4675																

◆ Enclosed Wall-mounted Type (UL Type 1)

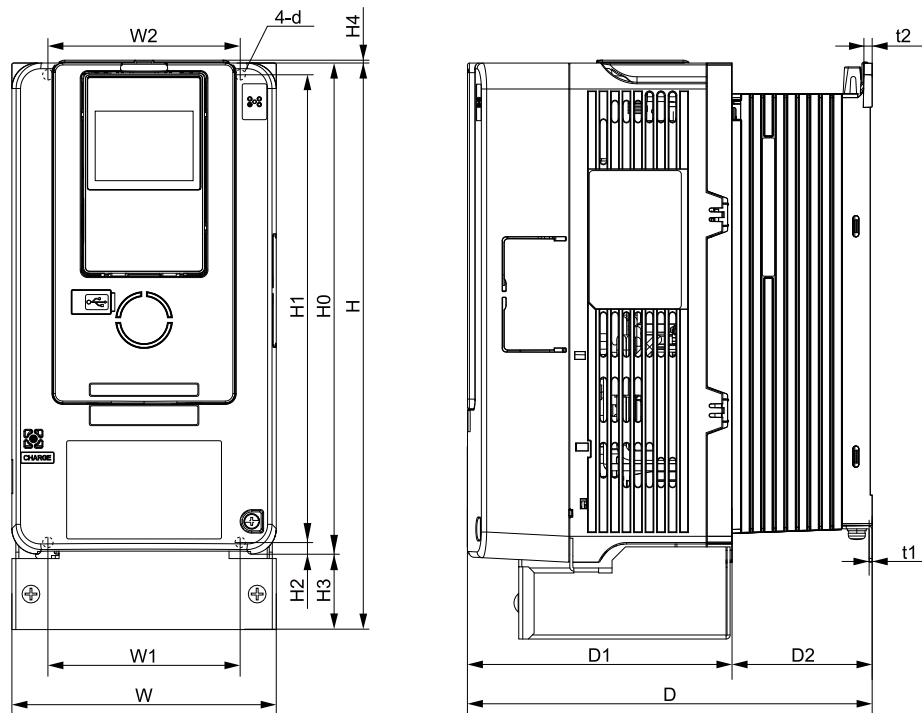

Figure 9.3 Exterior and Mounting Dimensions Diagram 1 (Models: 2004 to 2042 and 4002 to 4023)

9.7 Drive Exterior and Mounting Dimensions

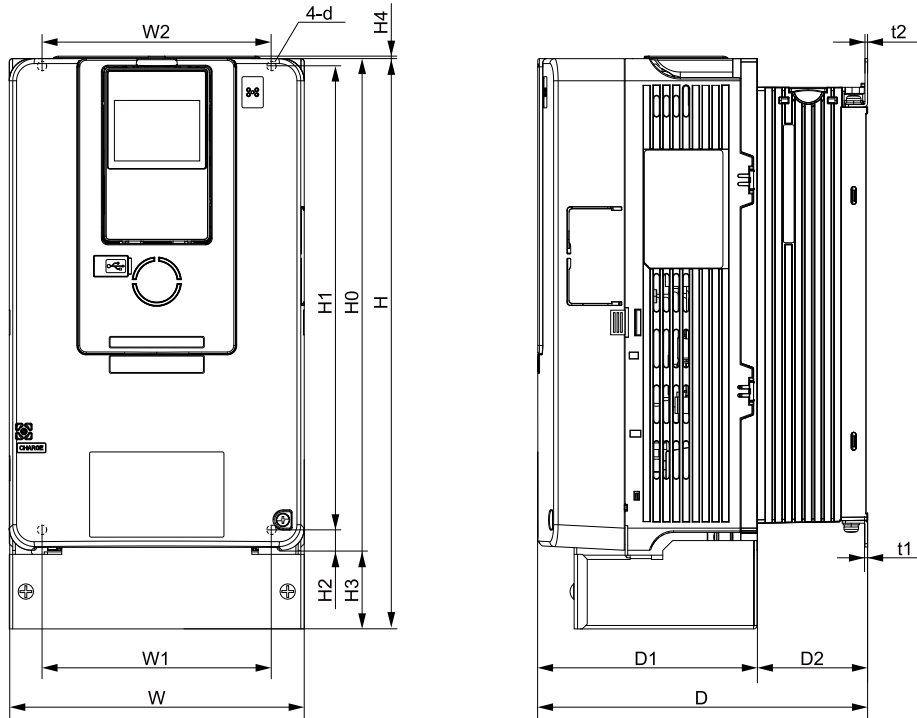

Figure 9.4 Exterior and Mounting Dimensions Diagram 2 (Models: 2056, 4031, and 4038)

Table 9.16 Exterior Dimensions (200 V class: UL Type 1)

Model	Exterior and Mounting Dimensions	Dimensions in mm															Estimated weight kg	
		W	H	D	D1	D2	W1	W2	W3 (maximum)	H0	H1	H2	H3	H4 (maximum)	t1	t2		d
2004	Figure 9.3	140	300	176	138	38	102	102	-	260	248	6	40	1.5	1.6	5	M5	4.1
2006		140	300	176	138	38	102	102	-	260	248	6	40	1.5	1.6	5	M5	4.1
2008		140	300	176	138	38	102	102	-	260	248	6	40	1.5	1.6	5	M5	4.1
2010		140	300	176	138	38	102	102	-	260	248	6	40	1.5	1.6	5	M5	4.1
2012		140	300	176	138	38	102	102	-	260	248	6	40	1.5	1.6	5	M5	4.1
2018		140	300	211	138	73	102	102	-	260	248	6	40	1.5	1.6	5	M5	4.5
2021		140	300	211	138	73	102	102	-	260	248	6	40	1.5	1.6	5	M5	4.5
2030		140	300	211	138	73	102	102	-	260	248	6	40	1.5	1.6	5	M5	4.8
2042		140	300	211	138	73	102	102	-	260	248	6	40	1.5	1.6	5	M5	4.8
2056	Figure 9.4	180	340	202	134	68	140	140	-	300	284	8	40	1.5	1.6	1.6	M5	7

Model	Exterior and Mounting Dimensions	Dimensions in mm																Estimated weight kg
		W	H	D	D1	D2	W1	W2	W3 (maximum)	H0	H1	H2	H3	H4 (maximum)	t1	t2	d	
2070	-	Preparing																
2082																		
2110																		
2138																		
2169																		
2211																		
2257																		
2313																		
2360																		
2415																		

Table 9.17 Exterior Dimensions (400 V class: UL Type 1)

Model	Exterior and Mounting Dimensions	Dimensions in mm																Estimated weight kg
		W	H	D	D1	D2	W1	W2	W3 (maximum)	H0	H1	H2	H3	H4 (maximum)	t1	t2	d	
4002	Figure 9.3	140	300	176	138	38	102	102	-	260	248	6	40	1.5	1.6	5	M5	4.1
4004		140	300	176	138	38	102	102	-	260	248	6	40	1.5	1.6	5	M5	4.1
4005		140	300	176	138	38	102	102	-	260	248	6	40	1.5	1.6	5	M5	4.1
4007		140	300	211	138	73	102	102	-	260	248	6	40	1.5	1.6	5	M5	4.5
4009		140	300	211	138	73	102	102	-	260	248	6	40	1.5	1.6	5	M5	4.5
4012		140	300	211	138	73	102	102	-	260	248	6	40	1.5	1.6	5	M5	4.5
4018		140	300	211	138	73	102	102	-	260	248	6	40	1.5	1.6	5	M5	4.8
4023		140	300	211	138	73	102	102	-	260	248	6	40	1.5	1.6	5	M5	4.8
4031	Figure 9.4	180	340	202	134	68	140	140	-	300	284	8	40	1.5	1.6	1.6	M5	7
4038		180	340	202	134	68	140	140	-	300	284	8	40	1.5	1.6	1.6	M5	7
4044	-	Preparing																
4060																		
4075																		
4089																		
4103																		
4140																		
4168																		
4208																		
4250																		
4296																		
4371																		
4389																		

9.7 Drive Exterior and Mounting Dimensions

*1 Contact Yaskawa or your nearest sales representative for details.

9.8 Knock-out Hole Dimensions (UL Type 1)

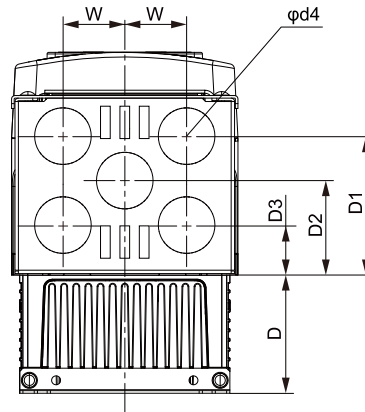

Figure 9.5 Exterior and Mounting Dimensions Diagram 1 (Models: 2004 to 2042 and 4002 to 4023)

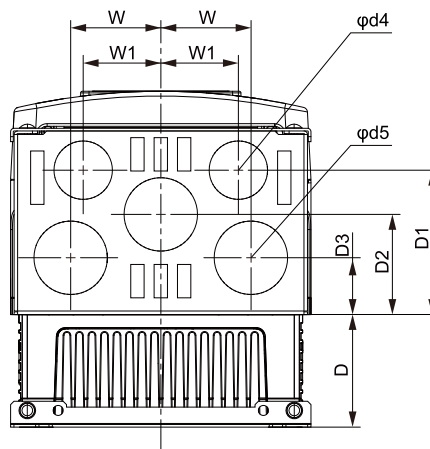

Figure 9.6 Exterior and Mounting Dimensions Diagram 2 (Models: 2056, 4031, and 4038)

Model	Diagram	Dimensions mm							
		D	D1	D2	D3	W	W1	φd4	φd5
2004 to 2042 4002 to 4023	Figure 9.5	74	85	57.5	30	38.2	-	35	-
2056 4031, 4038	Figure 9.6	67.5	86.5	60	34	54	46.5	35	44

9.9 Peripheral Devices and Options

The following table lists the available peripheral devices and options. Contact Yaskawa or your nearest sales representative to place an order.

- Selection: Refer to our catalog for information on available products.
- Installation and wiring: Refer to the instruction manual for each option.

Table 9.18 Main Circuit Option

Name	Model	Intended Use
DC reactor	UZDA series	This option is used to improve the input power factor of drives. <ul style="list-style-type: none"> • This option protects the drive when the power supply capacity is significant. This option must be used when the power supply capacity exceeds 600 kVA. • This option reduces harmonic current. • This option improves the power supply total power factor.
AC reactor	UZBA series	This option is used to improve the input power factor of drives. <ul style="list-style-type: none"> • This option protects the drive when the power supply capacity is significant. This option must be used when the power supply capacity exceeds 600 kVA. • This option reduces harmonic current. • This option improves the power supply total power factor.
Braking resistor	ERF-150WJ series	A braking resistor reduces the regenerative energy of the motor to shorten the deceleration time (duty cycle of 3% ED). The installation attachment is required.
Braking resistor with fuse	CF120-B579 series	A braking resistor reduces the regenerative energy of the motor to shorten the deceleration time (duty cycle of 3% ED). The installation attachment is required.
Braking resistor unit	LKEB series	A braking resistor unit reduces the regenerative energy of the motor to shorten the deceleration time (duty cycle of 10% ED). A thermal overload relay is integrated into the unit.
Braking unit	CDBR series	A combination including a braking resistor unit is used to reduce motor deceleration times.
Molded-case circuit breaker (MCCB)	NF series	Install this option to the power side to protect the power supply system in the event of a short circuit and to provide overload protection for wiring.
Earth leakage circuit breaker (ELCB, RCM/RCD).	NV and NS series	Install this option to the power side to protect the power supply system in the event of a short circuit, to provide overload protection for wiring, to prevent electric shock, and to provide ground fault protection against earth leakage fires. <p>Note:</p> <ul style="list-style-type: none"> • A molded-case circuit breaker can be used instead of an ELCB or RCM/RCD when an ELCB or RCM/RCD is used upstream in the power supply system. • Each drive should have a cumulative sensitivity amperage of at least 30 mA when used together with an ELCB or RCM/RCD designed specifically for high frequencies (usable with drive devices) that is not one of our recommendations.
Input side magnetic contactor (MC)	SC series	This option completely opens the circuit between the power supply and drive. Install this option to prevent burn damage when connecting a braking resistor.
Surge protective device	200 V class: DCR2-xA 400 V class: RFN3AL-504KD	This option absorbs open/close surges from the magnetic contactor and control relay. This option must be connected to magnetic contactors, control relays, magnetic valves, and magnetic brake coils.
Zero-phase reactor	F6045GB F11080GB F200160PB	This option is placed around the drive input power system to reduce noise emitted from wiring. This option can be used for both the input and output sides of the drive. <p>Note:</p> <p>Install this option as close to the drive as possible.</p>
Fuse Fuse Holder	200 V class: CR2LS series, CR2L series, or FWX series 400 V class: CR6L series, CS5F series, or FWH series	Yaskawa recommends to connect a fuse to the input side of the drive to protect parts from failing in the event of some unforeseen situation.
Input side noise filter	LNFB, LNFD, and FN series	This option is placed around the drive input power system to reduce noise emitted from wiring. Install this option as close to the drive as possible.
Output side noise filter	LF series	This option reduces noise emitted from wiring for the output side of the drive. Install this option as close to the drive as possible.

Name	Model	Intended Use
Capacitor type noise filter	3XYG 1003	This option is placed around the drive input power system to reduce noise emitted from wiring. This option can also be used in combination with the zero-phase reactor. Note: This option is specifically designed for use on the input side of the drive. Do not connect this option to the output side.
Momentary power loss recovery unit	200V class: P0010 400 V class: P0020	This option ensure the momentary power loss ride-thru time (power supply is maintained for 2 seconds) of drives.
Low-voltage manual load switch	“AICUT” LB series	PM motors act as generators when coasting to provide voltage to terminals. Install this option to prevent electric shock.

Table 9.19 Frequency Settings and Monitor Options

Name	Model	Intended Use
Frequency meter and ammeter	DCF-6A	This option monitors the output frequency and current using analog signals from the drive.
Output voltmeter	SDF-12NH	This option monitors output voltage using analog signals from the drive.
Frequency setting potentiometer (2 kΩ)	RH000739	This option sets the frequency via analog input.
Frequency meter scale correction resistor (20 kΩ)	RH000850	This option adjusts the frequency scaling.
Control dial for frequency setting potentiometer	CM-3S	This option is used with the frequency setting potentiometer.
Potential transformer	UPN-B	This option adjusts the voltage for meters.
Scale plate	NPJT41561-1	This option is used with the frequency setting potentiometer.

Table 9.20 Keypad

Name	Model	Intended Use
LED keypad	JVOP-KPLEA04xxx	The display is composed of LEDs. This keypad is used for remote operation. Use connection cables that are no longer than 3 m.
LCD Operator Extension Cable	WV001 WV003	This option is used to connect the keypad and drive (1 m or 3 m). RJ-45, 8-pin straight-through UTP CAT5e cable
Installation support set A	900-192-933-001	This option mounts the keypad to the control panel (secured with screws).
Installation support set B	900-192-933-002	This option mounts the keypad to the control panel (nut clamp). Use this option when weld studs are located inside the control panel.

Table 9.21 Attachments

Name	Model	Intended Use
Panel through mount kit	900-193-209-001 900-193-209-002 900-193-209-003	Use this option to mount the drive cooling fin outside of the control panel. Note: Current may need to be reduced when using panel through mounting for drives.
UL Type 1 Kit	900-192-121-001 900-192-121-002 900-192-121-003 900-192-121-004 900-192-121-005	Install this kit to an open chassis type (IP20) drive to configure the drive as an enclosed wall-mounted type (UL Type 1) drive.
Braking resistor installation attachment	EZZ020805A	Use this option to install a braking resistor to a drive.
External mounting attachment for braking unit fin	EZZ021711A	Use this option to mount the heatsink for the braking unit outside of the control panel.

Table 9.22 Engineering Tools

Name	Model	Intended Use
DriveWizardPlus	-	Engineering tools are used with a PC to configure drives and manage parameters.
DriveWorksEZ	-	Advanced drive programming can be accomplished by using a PC.

Table 9.23 Option PCB

Name	Model	Intended Use	Document No.
Complementary type PG	PG-B3	<p>This option can be used with Closed Loop V/f Control and Open Loop Vector Control. Motor rotation speed is detected from the pulse generator as feedback, which enables control of the output frequency of drives to ensure constant motor speeds.</p> <ul style="list-style-type: none"> • Complementary output PG support • A, B, and Z pulse (Three-phase pulse) input • Maximum input frequency: 50 kHz • Pulse monitor output: Open-collector (24 V, maximum of 30 mA) • Encoder power supply: 12 V, maximum current of 200 mA <p>Note: Closed Loop Vector Control for PM is not supported.</p>	TOBP C73060075A
Motor PG feedback line driver interface	PG-X3	<p>This option can be used with Closed Loop Vector Control, Closed Loop V/f Control, and Closed Loop Vector Control for PM. Motor rotation speed is detected from the pulse generator as feedback, which enables control of the output frequency of drives to ensure constant motor speeds.</p> <ul style="list-style-type: none"> • RS-422 output encoder support • A, B, and Z pulse (differential pulse) input • Maximum input frequency: 300 kHz • Pulse monitor: Equivalent to RS-422 level • Encoder voltage output: 5 V or 12V, maximum current of 200 mA 	TOBP C73060076A
Encoder type (EnDat)	PG-F3	<p>This option can be used with CLV/PM. Motor rotation speed is detected from the pulse generator as feedback, which enables control of the output frequency of drives to ensure constant motor speeds.</p> <ul style="list-style-type: none"> • Supports EnDat 2.1/01, EnDat 2.2/01, EnDat 2.2/22 models from HEIDENHAIN • Supports HIPERFACE models from SICK STEGMANN • Maximum input frequency: 20 kHz (use for low-speed applications such as gearless motors) <p>Note: EnDat 2.2/22 has no restrictions on input frequencies.</p> <ul style="list-style-type: none"> • Cable length: Maximum of 20 m for encoders and maximum of 30 m for pulse monitors • Pulse monitor: Equivalent to RS-422 level <p>Note: EnDat 2.2/22 cannot be used.</p> <ul style="list-style-type: none"> • Encoder voltage output: 5 V at a maximum current of 330 mA, or 8 V at a maximum current of 150 mA <p>Note: Use the following types of encoder cables.</p> <ul style="list-style-type: none"> • EnDat 2.1/01 and EnDat 2.2/01: HEIDENHAIN 17-pin cables • EnDat 2.2/22: HEIDENHAIN 8-pin cables • HIPERFACE: SICK STEGMANN 8-pin cables 	TOBP C73060077A
Resolver interface	PG-RT3	<p>This option can be used with Closed Loop Vector Control and Closed Loop Vector Control for PM. Resolvers that are electrically compatible with resolver model TS2640N321E64 from Tamagawa Seiki Co., Ltd. can be connected. The following table lists the typical electrical characteristics of model TS2640N321E64.</p> <ul style="list-style-type: none"> • Resolver motor excitation voltage: 10 Vac rms at 10 kHz • Transformation ratio [K]: 0.5 ±5% • Resolver input current: 100 mA rms • Cable length: Up to 10 m (or up to 100 m when using SS5 or SS7 series motors from Yaskawa Motor Co., Ltd. and encoder cables from Yaskawa Controls Co., Ltd.) 	TOBP C73060087A

Name	Model	Intended Use	Document No.
Analog input	AI-A3	<p>Highly precise analog references can be configured at high resolution.</p> <ul style="list-style-type: none"> • Input signal level: -10 Vdc to +10 Vdc (20 kΩ) at 4 mA to 20 mA (250 Ω) • Input channel: 3 channels Voltage input and current input can be selected with a dip switch. • Input resolution <ul style="list-style-type: none"> – Voltage input: 13 bits (1/8192) + encoding – Current input: 1/4096 	TOBP C73060078A
Analog monitor	AO-A3	<p>Analog signals are output to monitor the output state of the drive (output frequency and output current).</p> <ul style="list-style-type: none"> • Output resolution: 11 bits (1/2048) + encoding • Output voltage: -10 Vdc to +10 Vdc (non-insulated) • Output channels: 2 channels 	TOBP C73060079A
Digital inputs	DI-A3	<p>Digital speed references and multi-function digital input of up to 16 bits of resolution can be used.</p> <ul style="list-style-type: none"> • Input signals: Binary, 16 bits: BCD4 digits + SIGN signal + SET signal Parameters are used to select between 6 bits, 8 bits, and 12 bits. • Input voltage: 24 V (insulated) • Input current: 8 mA 	TOBP C73060080A
Digital output	DO-A3	<p>Insulated digital signals for monitoring the operation status of the drive (alarm signals and detecting zero speed) are output.</p> <p>Type of output:</p> <ul style="list-style-type: none"> • Photocoupler relays: 6 channels (48 V, up to 50 mA) • Relay contact output: 2 channels (250 Vac at 1 A or less, 30 Vdc at 1 A or less) 	TOBP C73060081A
PROFIBUS-DP	SI-P3	<p>This option is used to perform the following operations using the host controller over PROFIBUS-DP communication.</p> <ul style="list-style-type: none"> • Operating and stopping the drive • Setting and viewing parameters • Monitoring output frequency, output current, and similar 	TOBP C73060082A SIJPC73060082A
CC-Link	SI-C3	<p>This option is used to perform the following operations using the host controller over CC-Link communication.</p> <ul style="list-style-type: none"> • Operating and stopping the drive • Setting and viewing parameters • Monitoring output frequency, output current, and similar 	TOBP C73060083A SIJPC73060083A
DeviceNet	SI-N3	<p>This option is used to perform the following operations using the host controller over DeviceNet communication.</p> <ul style="list-style-type: none"> • Operating and stopping the drive • Setting and viewing parameters • Monitoring output frequency, output current, and similar <p>Note: Use options with software versions of 1114 or later.</p>	TOBP C73060084A SIJPC73060084A
CANopen	SI-S3	<p>This option is used to perform the following operations using the host controller over CANopen communication.</p> <ul style="list-style-type: none"> • Operating and stopping the drive • Setting and viewing parameters • Monitoring output frequency, output current, and similar 	TOBP C73060085A SIJPC73060085A
MECHATROLINK-II	SI-T3	<p>This option is used to perform the following operations using the host controller over MECHATROLINK-II communication.</p> <ul style="list-style-type: none"> • Operating and stopping the drive • Setting and viewing parameters • Monitoring output frequency, output current, and similar <p>Note: Use options with software versions of 6108 or later.</p>	TOBP C73060086A SIJPC73060086A

9.9 Peripheral Devices and Options

Name	Model	Intended Use	Document No.
MECHATROLINK-III	SI-ET3	<p>This option is used to perform the following operations using the host controller over MECHATROLINK-III communication.</p> <ul style="list-style-type: none"> • Operating and stopping the drive • Setting and viewing parameters • Monitoring output frequency, output current, and similar <p>Note: Use options with software versions of 6202 or later.</p>	TOBP C73060088A SIJPC73060088A
EtherNet/IP	SI-EN3	<p>This option is used to perform the following operations using the host controller over EtherNet/IP communication.</p> <ul style="list-style-type: none"> • Operating and stopping the drive • Setting and viewing parameters • Monitoring output frequency, output current, and similar 	*1
ModbusTCP/IP	SI-EM3	<p>This option is used to perform the following operations using the host controller over Modbus TCP/IP communication.</p> <ul style="list-style-type: none"> • Operating and stopping the drive • Setting and viewing parameters • Monitoring output frequency, output current, and similar 	*1
LonWorks	SI-W3	<p>Used to perform the following operations using the host controller over LonWorks communication.</p> <ul style="list-style-type: none"> • Operating and stopping the drive • Setting and viewing parameters • Monitoring output frequency, output current, and similar 	*1
PROFINET	SI-EP3	<p>Used to perform the following operations using the host controller over PROFINET communication.</p> <ul style="list-style-type: none"> • Operating and stopping the drive • Setting and viewing parameters • Monitoring output frequency, output current, and similar 	TOBP C73060089A SIJPC73060089A

*1 Contact Yaskawa or your nearest sales representative for details.

Table 9.24 Types of Option Cards and Connectors

Option PCB	Mountable connectors	Number of mountable cards
PG-B3 and PG-X3	CN5-C (CN5-B)	2 *1
PG-F3 *2 and PG-RT3 *2	CN5-C	1
AO-A3 and DO-A3	CN5-A, B, and C	1
AI-A3 *3, DI-A3 *3, SI-B3, SI-C3, SI-EM3, SI-EN3, SI-EP3, SI-ET3, SI-N3, SI-P3, SI-S3, SI-T3, and SI-W3	CN5-A	1

*1 Use the CN5-C connector when mounting only one PG option card. Use the CN5-C and CN5-B connectors when mounting two PG option cards.

*2 This cannot be used when using the motor switching function.

*3 When AI-A3 and DI-A3 input statuses are used as monitors, these option cards can be connected to any of CN5-A, CN5-B, and CN5-C. The AI-A3 input status can be confirmed with U1-21, U1-22, and U1-23. the DI-A3 input status can be confirmed with U1-17.

Parameter List

10.1	Section Safety	392
10.2	How to Read the Parameter List	393
10.3	Parameter Groups	394
10.4	A: Initialization Parameters.....	398
10.5	b: Application	400
10.6	C: Tuning	411
10.7	d: Reference Settings.....	417
10.8	E: Motor Parameters	423
10.9	F: Options.....	429
10.10	H: Terminal Functions	444
10.11	L: Protection Function	466
10.12	n: Special Adjustment.....	477
10.13	o: Keypad-Related Settings	484
10.14	q: DriveWorksEZ Parameters	490
10.15	r: DWEZ Connection 1-20	491
10.16	T: Motor Tuning	492
10.17	U: Monitors.....	496
10.18	A1-02 [Motor 1 Control Mode] Dependent Parameters.....	511
10.19	E3-01 [Motor 2 Control Mode] Dependent Parameters	517
10.20	Parameters Changed by E1-03 [V/f Pattern Selection]	518
10.21	Defaults by Drive Model and Duty Rating ND/HD.....	520
10.22	Parameters Changed by PM Motor Code Selection	543

10.1 Section Safety

DANGER









Heed the safety messages in this manual. Failure to comply will result in death or serious injury.

The operating company is responsible for any injuries or equipment damage resulting from failure to heed the warnings in this manual.

10.2 How to Read the Parameter List

◆ Icons and Terms Used to Represent Control Modes

The following table lists terms and symbols used in this section.

Icon	Description
	Parameter is available when operating the drive with V/f Control.
	Parameter is available when operating the drive with Closed Loop V/f Control.
	Parameter is available when operating the drive with Open Loop Vector Control.
	Parameter is available when operating the drive with Closed Loop Vector Control.
	Parameter is available when operating the drive with Advanced Open Loop Vector Control.
	Parameter is available when operating the drive with Open Loop Vector Control for PM motors.
	Parameter is available when operating the drive with Advanced Open Loop Vector Control for PM motors.
	Parameter is available when operating the drive with Closed Loop Vector Control for PM motors.
	Parameter is available when operating the drive with EZ Open Loop Vector Control.
Hex.	MEMOBUS addresses used to change parameters over network communication are represented in hexadecimal numbers.
RUN	Parameter can be changed during run.
EXP	Parameters that are enabled in Expert Mode only. <i>*1</i>

*1 When $A1-01 = 3$ [Access Level Selection = Expert Level], Expert Mode parameters can be displayed on and set with the keypad. Refer to for more information on parameters available in Expert Mode.

Note:

Icons in gray indicate that the parameter is not available in control mode.

10.3 Parameter Groups

Represents the type of product parameters.

Parameters	Name
A1	Initialization
A2	User Parameters
b1	Operation Mode Selection
b2	DC Injection Braking and Short Circuit Braking
b3	Speed Search
b4	Timer Function
b5	PID Control
b6	Dwell Function
b7	Droop Control
b8	Energy Saving
b9	Zero Servo
C1	Accel and Decel Times
C2	S-Curve Characteristics
C3	Slip Compensation
C4	Torque Compensation
C5	Automatic Speed Regulator Automatic Speed Regulator)
C6	Carrier Frequency
d1	Frequency Reference
d2	Reference Limits
d3	Jump Frequency
d4	Frequency Reference Hold and Up/Down 2 Function
d5	Torque control
d6	Field Weakening and Field Forcing
d7	Offset Frequency
E1	V/f Pattern for Motor 1
E2	Motor Parameters
E3	V/f Pattern for Motor 2
E4	Motor 2 Parameters
E5	PM Motor Settings
E9	Motor Setting
F1	PG Speed Control Card Encoder
F2	Analog Input Option
F3	Digital Input Option
F4	Analog Monitor Option
F5	Digital Output Option
F6	Communication Options
F7	Communication Options
H1	Multi-function digital input

Parameters	Name
H2	Multi-function digital output
H3	Multi-Function Analog In
H4	Analog Outputs
H5	MEMOBUS/Modbus communications
H6	Pulse Train Input/Output
H7	Virtual Multi-Function I/O
L1	Motor Protection
L2	Momentary Power Loss Ride-Thru
L3	Stall Prevention
L4	Speed Detection
L5	Auto Restart
L6	Detection of Overtorque/Undertorque
L7	Torque Limit
L8	Drive Protection
L9	Drive Protection 2
n1	Hunting prevention function
n2	Speed feedback detection control
n3	High Slip Braking (HSB) and Overexcitation Braking
n4	Adv Vect Tune
n5	Feed Forward Control
n6	Online Tuning
n7	EZ Drive
n8	PM Motor Control Tuning
o1	Keypad Display Selection
o2	Keypad Operation
o3	Copy Function
o4	Maintenance Mon Settings
o5	Log Function
q	DriveWorksEZ Parameters
r	DWEZ Connection 1-20
T0	Tuning Mode Selection
T1	Induction Motor Auto-Tuning
T2	PM Motor Auto-Tuning
T3	ASR and Inertia Tuning
T4	EZ Tuning
U1	Operation Status Monitor
U2	Fault Trace
U3	Fault History
U4	Maintenance Monitors

Parameters	Name
U5	PID Monitors
U6	Operation Status Monitors

Parameters	Name
U8	DriveWorksEZ Monitors

◆ List of Parameters Enabled in Expert Mode

Table 10.1 Parameters Enabled in Expert Mode

No.	Name	No.	Name
A1-11	Firmware update lock	b8-19	E-Save Search Injection Freq
b1-21	CLV Start Selection	b8-20	PM E-Save Search Width
b1-35	Multi-Function DI dead band time	b8-21	PM E-Save Search Gain
b3-06	Speed Estimation Current Level 1	b8-22	PM E-Save Search LPF Cutoff Freq
b3-07	Speed Estimation Current Level 2	b8-23	PM E-Save Search Limit
b3-08	Speed Estimation ACR P Gain	b8-24	PM E-Save High Freq ACR Gain
b3-09	Speed Estimation ACR I Time	b8-25	PM E-Save Search Start level
b3-10	Speed Estimation Detection Gain	b8-26	PM E-Save Power Setpoint
b3-17	Speed Est. Retry Current Level	b8-28	Save Energy Priority Function
b3-18	Speed Est. Retry Detection Time	C3-16	Vout Modulation Limit Start Lvl
b3-25	Speed Search Wait Time	C3-17	Vout Modulation Limit Max Level
b3-26	Direction Determining Level	C3-18	Output Voltage Limit Level
b3-27	Start Speed Search Select	C3-28	Adaptive Slip Contrl Mode Select
b3-29	Speed Search Back-EMF Threshold	C4-19	T-ripple suppress freq
b3-31	Search current Level 1	C4-20	vol compensation adjust 1
b3-32	Search current Level 2	C4-21	vol compensation adjust 2
b3-33	Spd Search during UV Selection	C5-17	Motor Inertia
b3-35	Voltage Detection Low Level	C5-18	Load Inertia Ratio
b3-36	Wait Restart Level	C5-29	Speed Control Response
b3-55	Current Increment Time	C5-37	Motor 2 Inertia
b4-03	H2-01 ON Delay Time	C5-38	Motor 2 Load Inertia Ratio
b4-04	H2-01 OFF Delay Time	C5-50	Notch Filter Frequency
b4-05	H2-02 ON Delay Time	C5-51	Notch Filter Bandwidth
b4-06	H2-02 OFF Delay Time	E1-11	Mid Point B Frequency
b4-07	H2-03 ON Delay Time	E1-12	Mid Point B Voltage
b4-08	H2-03 OFF Delay Time	E1-13	Base Voltage
b4-09	H2-04 ON Delay Time	E2-09	Motor Mechanical Loss
b4-10	H2-04 OFF Delay Time	E3-11	Motor 2 Mid Point B Frequency
b5-08	PID Primary Delay Time Constant	E3-12	Motor 2 Mid Point B Voltage
b8-02	Energy Saving Gain	E3-13	Motor 2 Base Voltage
b8-03	Energy Saving Filter Time	E4-09	Motor 2 Mechanical Loss
b8-04	Energy Saving Coefficient Value	E5-25	Polarity Estimation Reversal
b8-05	Power Detection Filter Time	F3-10	Terminal D0 Function Selection
b8-06	Search Operation Voltage Limit	F3-11	Terminal D1 Function Selection
b8-16	PM E-Save Coefficient Ki	F3-12	Terminal D2 Function Selection
b8-17	PM E-Save Coefficient Kt	F3-13	Terminal D3 Function Selection
b8-18	E-Save d-axis Current FilterTime	F3-14	Terminal D4 Function Selection

10.3 Parameter Groups

No.	Name
F3-15	Terminal D5 Function Selection
F3-16	Terminal D6 Function Selection
F3-17	Terminal D7 Function Selection
F3-18	Terminal D8 Function Selection
F3-19	Terminal D9 Function Selection
F3-20	Terminal DA Function Selection
F3-21	Terminal DB Function Selection
F3-22	Terminal DC Function Selection
F3-23	Terminal DD Function Selection
F3-24	Terminal DE Function Selection
F3-25	Terminal DF Function Selection
H2-60	Terminal M1-M2 Function B Select
H2-61	Terminal M1-M2 Logical Operation
H2-62	Terminal M1-M2 Delay Time
H2-63	Terminal M3-M4 Function B Select
H2-64	Terminal M3-M4 Logical Operation
H2-65	Terminal M3-M4 Delay Time
H2-66	Terminal M5-M6 Function B Select
H2-67	Terminal M5-M6 Logical Operation
H2-68	Terminal M5-M6 Delay Time
H2-69	Digital Output4 Secondary Func
H2-70	DigitalOutput4 Logical Operation
H2-71	Digital Output 4 Delay Time
H2-72	Digital Output 5 Secondary Func
H2-73	DigitalOutput5 Logical Operation
H2-74	Digital Output 5 Delay Time
H5-17	Busy Enter Selection
H5-20	Comm. Parameters Activation Sel
H7-00	Virtual Multi-Function I/O
H7-01	Virtual Multi-Function Input 1
H7-02	Virtual Multi-Function Input 2
H7-03	Virtual Multi-Function Input 3
H7-04	Virtual Multi-Function Input 4
H7-10	Virtual Multi-Function Output 1
H7-11	Virtual Output 1 Delay Time
H7-12	Virtual Multi-Function Output 2
H7-13	Virtual Output 2 Delay Time
H7-14	Virtual Multi-Function Output 3
H7-15	Virtual Output 3 Delay Time
H7-16	Virtual Multi-Function Output 4
H7-17	Virtual Output 4 Delay Time
H7-30	Virtual Analog Input Selection
H7-31	Virtual Analog Input Gain

No.	Name
H7-32	Virtual Analog Input Bias
L2-06	KEB Deceleration Time
L2-07	KEB Acceleration Time
L2-08	Frequency Gain at KEB Start
L2-09	KEB Minimum Frequency Level
L2-10	KEB Detect Time (Min KEB Time)
L2-11	DC Bus Vol Setpoint during KEB
L2-29	KEB Method Selection
L2-30	KEB Zero Speed Operation
L2-31	KEB Start Voltage Offset Level
L3-20	DC Bus Voltage Adjustment Gain
L3-21	Accel/Decel Rate Calculate Gain
L3-24	Motor Accel Time for Inertia Cal
L3-25	Load Inertia Ratio
L3-26	Additional DC Bus Capacitors
L3-34	Torque Limit Delay Time
L3-35	IntDecSpdAgrWdth
L3-37	Current Limit P Gain duringAccel
L3-38	Current Limit I Time duringAccel
L7-35	DeratingTrqLimForLowFreq&Regratn
L7-36	Ope Freq band for deratingTrqLim
L8-20	CF/STPo Fault Detection Select
L8-51	STPo I Detection Level
L8-52	STPo Integration Level
L8-53	STPo Integration Time
L8-54	STPo Id Diff Detection
L8-56	Stl Act Time
L8-57	Stl Retry Count
L8-90	STPo Detection Level
L8-93	LSo Detection Time at Low Speed
L8-94	LSo Detection Level at Low Speed
L8-95	Average LSo Freq at Low Speed
L9-16	FAN1 Detect Time
n1-02	Hunting Prevention Gain Setting
n1-03	Hunting Prevention Time Constant
n1-05	HuntingPreventionGain whileinRev
n1-08	Leak cur antivib
n1-13	DC Bus Stabilization Control
n1-14	DC Bus Stabilization Time
n1-15	Voltage Calibration Select
n1-17	Hunt Prev Time
n3-01	HSB Deceleration Frequency Width
n3-02	High-Slip Braking Current Limit

No.	Name
n3-03	HSB Dwell Time at Stop
n3-04	High-Slip Braking Overload Time
n3-14	HarmInj@HiFlxBrk
n4-74	Limit of Flux loop
n5-04	Spd Response F
n6-05	Online Tuning Gain
n6-11	online resister tuning
n7-01	Flux Estimation Cut-off Freq
n7-05	Torque Control Response Gain
n7-07	PLL response 1
n7-08	PLL response 2
n7-10	Sensorless Switchover StartSpeed
n8-01	Init Rotor Position Est Current
n8-02	Pole Attraction Current
n8-04	Polar Attraction Time
n8-11	Induction Volt Estimation Gain 2
n8-14	Polarity Compensation Gain 3
n8-15	Polarity Compensation Gain 4
n8-21	Motor Ke Gain
n8-37	High Freq Injection Amplitude
n8-41	HFI Overlap Pole Detection Pgain
n8-42	HFI Overlap Pole Detection iTime
n8-49	d-Axis Cur forHighEfficiencyCont
n8-54	VoltErrorCompensationTime Const
n8-62	Output Voltage Limit (for PM)
n8-65	SpdFdbkDetectCtrlGainduringOVSup
n8-69	Speed Calculation Gain

No.	Name
n8-72	Speed Estimation Method Select
n8-74	LghtLoadCurLvl 1
n8-75	LghtLoadCurLvl 2
n8-77	IPM HiEffCtrLev2
n8-78	MedLoad Id Level
n8-84	InitPolarityEstimationTimeoutCur
n8-94	Selection of Recognition Criteria
n8-95	Observer Estimation TimeConstant
U1-50	Virtual Ai
U1-91	Output Voltage
U2-21	STO Det Sts
U5-21	AutoCalEnSav Coef Ki
U5-22	AutoCalEnSav Coef Kt
U6-07	q-Axis ACR Output
U6-08	d-Axis ACR Output
U6-09	AdvPhase Compen $\Delta\theta$
U6-10	ContAxisDeviation $\Delta\theta$
U6-13	FluxPosDetect sensor
U6-14	FluxPosEstimObserver
U6-17	ESav Coeff Value
U6-25	Fdbk Control Output
U6-26	Feed Fwd Cont Output
U6-27	FF Estimate SPD
U6-36	Comm Errors-HOST
U6-37	Comm Errors-HOST
U6-48	ASIC Comm Errors

10.4 A: Initialization Parameters

◆ A1: Initialization

No. (Hex.)	Name	Description	Default (Range)	Ref.
A1-00 (0100) RUN	Language Selection	<p>V/f CL-V/f OLV CLV AOLV OLV/PM AOLV/PM CLV/PM EZOLV</p> <p>Selects the language for the LCD keypad.</p> <p>Note: This parameter is not reset when the drive is initialized using parameter <i>A1-03</i> [Initialize Parameters].</p> <p>0 : English 1 : Japanese 2 : Deutsch 3 : Français 4 : Italiano 5 : Español 6 : Português 7 : Chinese 8 : Czech 9 : Russian 10 : Turkish 11 : Polish 12 : Greek</p>	1 (0 - 12)	571
A1-01 (0101) RUN	Access Level Selection	<p>V/f CL-V/f OLV CLV AOLV OLV/PM AOLV/PM CLV/PM EZOLV</p> <p>Restricts user access to parameter settings. The set access level restricts what parameters the keypad will display, and what parameters the user can set.</p> <p>0 : Operation Only 1 : User Parameters 2 : Advanced Level 3 : Expert Level</p>	2 (0 - 3)	571
A1-02 (0102)	Control Method Selection	<p>V/f CL-V/f OLV CLV AOLV OLV/PM AOLV/PM CLV/PM EZOLV</p> <p>Selects the control method for the drive application and the motor.</p> <p>0 : V/f Control 1 : V/f Control w/ PG 2 : Open Loop Vector 3 : Closed Loop Vector 4 : Advanced Open Loop Vector 5 : PM Open Loop Vector 6 : PM Advanced Open Loop Vector 7 : PM Closed Loop Vector 8 : EZ Vector Control</p>	2 (0 - 8)	572
A1-03 (0103)	Initialize Parameters	<p>V/f CL-V/f OLV CLV AOLV OLV/PM AOLV/PM CLV/PM EZOLV</p> <p>Resets parameters to default values.</p> <p>0 : Keypad or Multi-Speed Selection 1110 : User Initialization 2220 : 2-Wire initialization 3330 : 3-Wire initialization</p>	0 (0 - 3330)	573
A1-04 (0104)	Password	<p>V/f CL-V/f OLV CLV AOLV OLV/PM AOLV/PM CLV/PM EZOLV</p> <p>Enter the correct password set in <i>A1-05</i> [Password Setting] to unlock parameters. The user can still view parameter settings while they are locked without entering the password. Enter the password in <i>A1-04</i> [Password] to unlock and change the settings.</p>	0000 (0000 - 9999)	574

No. (Hex.)	Name	Description	Default (Range)	Ref.
A1-05 (0105)	Password Setting	<p>V/f CL-V/f OLV CLV AOLV OLV/PM AOLV/PM CLV/PM EZOLV</p> <p>The drive locks the following parameters once the password has been set. The following parameters can be changed if the user enters the correct password in <i>A1-04 [Password]</i> that matches the password set in <i>A1-05</i>.</p> <ul style="list-style-type: none"> • <i>A1-01 [Access Level Selection]</i> • <i>A1-02 [Control Method Selection]</i> • <i>A1-03 [Initialize Parameters]</i> • <i>A1-06 [Application Preset]</i> • <i>A1-07 [DriveWorksEZ Function Selection]</i> • <i>A2-01 to A2-32 [User Parameters 1 to 32]</i> 	0000 (0000 - 9999)	575
A1-06 (0127)	Application Preset	<p>V/f CL-V/f OLV CLV AOLV OLV/PM AOLV/PM CLV/PM EZOLV</p> <p>This parameter conveniently sets up the drive for certain applications.</p> <p>0 : Disabled 1 : Water supply pump 2 : Conveyor 3 : Exhaust fan 4 : HVAC 5 : Air compressor 6 : Hoist 7 : Traveling</p>	0 (0 - 7)	575
A1-07 (0128)	DriveWorksEZ Function Selection	<p>V/f CL-V/f OLV CLV AOLV OLV/PM AOLV/PM CLV/PM EZOLV</p> <p>Sets the drive for operation with a program created in DriveWorksEZ.</p> <p>0 : DWEZ Disabled 1 : DWEZ Enabled 2 : Digital input</p>	0 (0 - 2)	590
A1-11 (111D)	Firmware update lock	<p>V/f CL-V/f OLV CLV AOLV OLV/PM AOLV/PM CLV/PM EZOLV</p> <p>Enables and disables the firmware update function via cloud service.</p> <p>0 : Disable 1 : Enable</p>	0 (0, 1)	590

◆ A2: User Parameters

No. (Hex.)	Name	Description	Default Setting (Range)	Ref.
A2-01 to A2-32 (0106 - 0125)	User Parameters 1 to 32	<p>V/f CL-V/f OLV CLV AOLV OLV/PM AOLV/PM CLV/PM EZOLV</p> <p>The user can select up to 32 parameters for the drive and assign them to parameters <i>A2-01 through A2-32</i>. Registered parameters can be displayed in [User Parameters] under the main menu. The user can immediately access necessary parameters.</p> <p>Note: Settings for <i>A2-01 to A2-32</i> vary depending on the value selected for <i>A1-06 [Application Preset]</i>.</p>	Parameters in General-Purpose Setup Mode (Determined by A1-07)	591
A2-33 (0126)	User Parameter Auto Selection	<p>V/f CL-V/f OLV CLV AOLV OLV/PM AOLV/PM CLV/PM EZOLV</p> <p>Determines if the drive automatically saves the history of parameter changes to <i>A2-17 to A2-32 [User Parameters 17 to 32]</i>.</p> <p>0 : Disabled 1 : Enabled</p>	Determined by A1-06 (0, 1)	591

10.5 b: Application

◆ b1: Operation Mode Selection

No. (Hex.)	Name	Description	Default (Range)	Ref.
b1-01 (0180)	Frequency Reference Selection 1	<p>V/f CL-V/f OLV CLV AOLV OLV/PM AOLV/PM CLV/PM EZOLV</p> <p>Selects frequency reference input method. 0 : Keypad or Multi-Speed Selection 1 : Analog Input 2 : MEMOBUS/Modbus communications 3 : Option PCB 4 : Pulse Train Input</p>	1 (0 - 4)	592
b1-02 (0181)	Run Command Selection 1	<p>V/f CL-V/f OLV CLV AOLV OLV/PM AOLV/PM CLV/PM EZOLV</p> <p>Selects the Run command input method. 0 : Keypad 1 : Digital Input 2 : Memobus/Modbus Communications 3 : Option PCB</p>	1 (0 - 3)	594
b1-03 (0182)	Stopping Method Selection	<p>V/f CL-V/f OLV CLV AOLV OLV/PM AOLV/PM CLV/PM EZOLV</p> <p>Selects how the drive stops the motor after removing a Run command or entering a Stop command. Note: The setting range is 0, 1, and 3 when A1-02 = 3, 4, 5, 6, 7, or 8 [Control Method Selection = CLV, AOLV, OLV/PM, AOLV/PM, CLV/PM, or EZOLV]. 0 : Ramp to Stop 1 : Coast to Stop 2 : DC Injection Braking to Stop 3 : Coast to Stop with Timer</p>	0 (0 - 3)	594
b1-04 (0183)	Reverse Operation Selection	<p>V/f CL-V/f OLV CLV AOLV OLV/PM AOLV/PM CLV/PM EZOLV</p> <p>Enables and disables reverse operation. Used in applications such as fans or pumps where reverse motor rotation is potentially problematic. 0 : Reverse Enabled 1 : Reverse Disabled</p>	0 (0, 1)	597
b1-05 (0184)	Operation Below Minimum Freq	<p>V/f CL-V/f OLV CLV AOLV OLV/PM AOLV/PM CLV/PM EZOLV</p> <p>Sets the operation to perform when the frequency reference falls below the value set in E1-09 [Minimum Output Frequency]. 0 : Operate at frequency reference 1 : Baseblock (motor coasts) 2 : Operate at minimum frequency 3 : Operate at zero speed</p>	0 (0 - 3)	598
b1-06 (0158)	Digital Input Reading	<p>V/f CL-V/f OLV CLV AOLV OLV/PM AOLV/PM CLV/PM EZOLV</p> <p>Selects if the drive should read the sequence input (FWD/REV, multi-function input) command once or twice to prevent problems from noise. 0 : Input status is read once 1 : Input status is read twice</p>	1 (0, 1)	599
b1-07 (0186)	LOCAL/REMOTE Run Selection	<p>V/f CL-V/f OLV CLV AOLV OLV/PM AOLV/PM CLV/PM EZOLV</p> <p>When switching from LOCAL to REMOTE, or between External reference 1 and External reference 2, the Run command may already be present at the location to which the source is being switched. In this case, use parameter b1-07 to determine how the Run command is treated. 0 : Cycle existing RUN command 1 : Accept existing RUN command</p>	0 (0, 1)	599

No. (Hex.)	Name	Description	Default (Range)	Ref.
b1-08 (0187)	Run Command Select in PRG Mode	V/f CL-V/f OLV CLV AOLV OLV/PM AOLV/PM CLV/PM EZOLV Sets the conditions for the drive to accept a Run command entered from an external source when using the keypad to set parameters. 0 : Do not accept RUN at Programming 1 : Accept RUN while Programming 2 : Allow Programming only at Stop	0 (0 - 2)	600
b1-14 (01C3)	Phase Order Selection	V/f CL-V/f OLV CLV AOLV OLV/PM AOLV/PM CLV/PM EZOLV Sets the phase order for output terminals U/T1, V/T2, and W/T3. This parameter is useful for making sure the Forward Run command from the drive and the forward direction of the motor match, without needing to change any wiring. 0 : Standard 1 : Switch phase order	0 (0, 1)	600
b1-15 (01C4)	Frequency Reference Selection 2	V/f CL-V/f OLV CLV AOLV OLV/PM AOLV/PM CLV/PM EZOLV Selects the input method for frequency reference 2. 0 : Keypad 1 : Analog Input 2 : Memobus/Modbus Communications 3 : Option PCB 4 : Pulse Train Input	0 (0 - 4)	600
b1-16 (01C5)	Run Command Selection 2	V/f CL-V/f OLV CLV AOLV OLV/PM AOLV/PM CLV/PM EZOLV Sets the input method for Run Command 2 when changing the source of the Run command by switching the control circuit terminals ON/OFF. 0 : Keypad 1 : Analog Input 2 : Memobus/Modbus Communications 3 : Option PCB	0 (0 - 3)	602
b1-17 (01C6)	Run Command at Power Up	V/f CL-V/f OLV CLV AOLV OLV/PM AOLV/PM CLV/PM EZOLV Selects what action to take when the power supply is switched ON and the Run command is input from an external source. It is necessary to set this parameter in applications where the Run command is already enabled when the power supply switches ON/OFF. 0 : Disregard existing RUN command 1 : Accept existing RUN command	0 (0, 1)	603
b1-21 (0748)	CLV Start Selection	V/f CL-V/f OLV CLV AOLV OLV/PM AOLV/PM CLV/PM EZOLV Selects the condition used to accept the Run command when $A1-02 = 3$ or 7 [Control Method Selection = Closed Loop Vector Control or PM Closed Loop Vector Control]. Normally there is no need to change this setting. 0 : Reject Run if $b2-01 < Nfdbk < E1-09$ 1 : Accept Run command at any speed	0 (0, 1)	603
b1-35 (1117)	Multi-Function DI dead band time	V/f CL-V/f OLV CLV AOLV OLV/PM AOLV/PM CLV/PM EZOLV Sets the dead band time for multi-function digital inputs.	0.0 ms (0.0 to 100.0 ms)	604

◆ b2: DC Injection Braking and Short Circuit Braking

No. (Hex.)	Name	Description	Default Setting (Range)	Ref.
b2-01 (0189)	DC Injection/Zero SpeedThreshold	V/f CL-V/f OLV CLV AOLV OLV/PM AOLV/PM CLV/PM EZOLV Sets the frequency to begin DC Injection Braking, Short Circuit Braking, and Zero Servo. Note: This parameter is available when $b1-03 = 0$ [Stopping Method Selection = Ramp to Stop].	Determined by A1-02 (0.0 - 10.0 Hz)	604
b2-02 (018A)	DC Injection Braking Current	V/f CL-V/f OLV CLV AOLV OLV/PM AOLV/PM CLV/PM EZOLV Sets the DC Injection Braking current as a percentage of the drive rated current.	50% (0 - 100%)	605

No. (Hex.)	Name	Description	Default Setting (Range)	Ref.
b2-03 (018B)	DC Inject Braking Time at Start	<input type="checkbox"/> V/f <input type="checkbox"/> CL-V/f <input type="checkbox"/> OLV <input type="checkbox"/> CLV <input type="checkbox"/> AOLV <input type="checkbox"/> OLV/PM <input type="checkbox"/> AOLV/PM <input type="checkbox"/> CLV/PM <input type="checkbox"/> EZOLV Sets the DC Inject Braking Time at start. Configures the zero speed control at start when using Closed Loop Vector Control, Advanced Open Loop Vector Control, or Closed Loop Vector Control for PM.	A1-02 = 4: 0.03 s Other than A1-02 = 4: 0.00 s (0.00 - 10.00 s)	605
b2-04 (018C)	DC Inject Braking Time at Stop	<input type="checkbox"/> V/f <input type="checkbox"/> CL-V/f <input type="checkbox"/> OLV <input type="checkbox"/> CLV <input type="checkbox"/> AOLV <input type="checkbox"/> OLV/PM <input type="checkbox"/> AOLV/PM <input type="checkbox"/> CLV/PM <input type="checkbox"/> EZOLV Sets the DC Inject Braking Time at stop. Configures the zero speed control at stop when using Closed Loop Vector Control, Advanced Open Loop Vector Control, or Closed Loop Vector Control for PM.	Determined by A1-02 (0.00 - 10.00 s)	606
b2-08 (0190)	Magnetic Flux Compensation Value	<input type="checkbox"/> V/f <input type="checkbox"/> CL-V/f <input type="checkbox"/> OLV <input type="checkbox"/> CLV <input type="checkbox"/> AOLV <input type="checkbox"/> OLV/PM <input type="checkbox"/> AOLV/PM <input type="checkbox"/> CLV/PM <input type="checkbox"/> EZOLV Sets the amount of current injected in the beginning of DC Injection Braking at start (initial excitation) as a percentage of the value set in E2-03 [Motor No-Load Current].	0% (0 - 1000%)	606
b2-12 (01BA)	Short Circuit Brake Time @ Start	<input type="checkbox"/> V/f <input type="checkbox"/> CL-V/f <input type="checkbox"/> OLV <input type="checkbox"/> CLV <input type="checkbox"/> AOLV <input type="checkbox"/> OLV/PM <input type="checkbox"/> AOLV/PM <input type="checkbox"/> CLV/PM <input type="checkbox"/> EZOLV Sets the Short Circuit Braking time at start.	0.00 s (0.00 - 25.50 s)	606
b2-13 (01BB)	Short Circuit Brake Time @ Stop	<input type="checkbox"/> V/f <input type="checkbox"/> CL-V/f <input type="checkbox"/> OLV <input type="checkbox"/> CLV <input type="checkbox"/> AOLV <input type="checkbox"/> OLV/PM <input type="checkbox"/> AOLV/PM <input type="checkbox"/> CLV/PM <input type="checkbox"/> EZOLV Sets the Short Circuit Braking time at stop.	A1-02 = 8: 0.00 s Other than A1-02 = 8: 0.50 s (0.00 - 25.50 s)	607
b2-18 (0177)	Short Circuit Braking Current	<input type="checkbox"/> V/f <input type="checkbox"/> CL-V/f <input type="checkbox"/> OLV <input type="checkbox"/> CLV <input type="checkbox"/> AOLV <input type="checkbox"/> OLV/PM <input type="checkbox"/> AOLV/PM <input type="checkbox"/> CLV/PM <input type="checkbox"/> EZOLV Sets the Short Circuit Braking current as a percentage of the motor rated current.	100.0% (0.0 - 200.0%)	607

◆ b3: Speed Search

No. (Hex.)	Name	Description	Default (Range)	Ref.
b3-01 (0191)	Speed Search Selection at Start	<input type="checkbox"/> V/f <input type="checkbox"/> CL-V/f <input type="checkbox"/> OLV <input type="checkbox"/> CLV <input type="checkbox"/> AOLV <input type="checkbox"/> OLV/PM <input type="checkbox"/> AOLV/PM <input type="checkbox"/> CLV/PM <input type="checkbox"/> EZOLV Sets whether to execute Speed Search or not with each Run command. 0 : Disabled 1 : Enabled	Determined by A1-02 (0, 1)	610
b3-02 (0192)	Speed Search Deactivation Current	<input type="checkbox"/> V/f <input type="checkbox"/> CL-V/f <input type="checkbox"/> OLV <input type="checkbox"/> CLV <input type="checkbox"/> AOLV <input type="checkbox"/> OLV/PM <input type="checkbox"/> AOLV/PM <input type="checkbox"/> CLV/PM <input type="checkbox"/> EZOLV Sets the current level that ends Speed Search as a percentage of the drive rated output current. Normally there is no need to change this setting.	Determined by A1-02 (0 - 200%)	611
b3-03 (0193)	Speed Search Deceleration Time	<input type="checkbox"/> V/f <input type="checkbox"/> CL-V/f <input type="checkbox"/> OLV <input type="checkbox"/> CLV <input type="checkbox"/> AOLV <input type="checkbox"/> OLV/PM <input type="checkbox"/> AOLV/PM <input type="checkbox"/> CLV/PM <input type="checkbox"/> EZOLV Determines the deceleration time during Speed Search operation. Set the time it takes to decelerate from the maximum output frequency to the minimum output frequency.	2.0 s (0.1 - 10.0 s)	611
b3-04 (0194)	V/f Gain during Speed Search	<input type="checkbox"/> V/f <input type="checkbox"/> CL-V/f <input type="checkbox"/> OLV <input type="checkbox"/> CLV <input type="checkbox"/> AOLV <input type="checkbox"/> OLV/PM <input type="checkbox"/> AOLV/PM <input type="checkbox"/> CLV/PM <input type="checkbox"/> EZOLV Configures the ratio used to reduce the V/f during searches to reduce the output current during speed searches.	Determined by o2-04 (10 - 100)	611
b3-05 (0195)	Speed Search Delay Time	<input type="checkbox"/> V/f <input type="checkbox"/> CL-V/f <input type="checkbox"/> OLV <input type="checkbox"/> CLV <input type="checkbox"/> AOLV <input type="checkbox"/> OLV/PM <input type="checkbox"/> AOLV/PM <input type="checkbox"/> CLV/PM <input type="checkbox"/> EZOLV If a magnetic contactor is installed between the drive and the motor, this parameter sets a delay time to activate the magnetic contactor by delaying Speed Search.	0.2 s (0.0 - 100.0 s)	611
b3-06 (0196)	Speed Estimation Current Level 1	<input type="checkbox"/> V/f <input type="checkbox"/> CL-V/f <input type="checkbox"/> OLV <input type="checkbox"/> CLV <input type="checkbox"/> AOLV <input type="checkbox"/> OLV/PM <input type="checkbox"/> AOLV/PM <input type="checkbox"/> CLV/PM <input type="checkbox"/> EZOLV Configure the amount of current that flows to the motor as a coefficient of the motor rated current when executing the Speed Estimation Speed Search. Normally there is no need to change this setting.	Determined by o2-04 (0.0 - 2.0)	611
b3-07 (0197)	Speed Estimation Current Level 2	<input type="checkbox"/> V/f <input type="checkbox"/> CL-V/f <input type="checkbox"/> OLV <input type="checkbox"/> CLV <input type="checkbox"/> AOLV <input type="checkbox"/> OLV/PM <input type="checkbox"/> AOLV/PM <input type="checkbox"/> CLV/PM <input type="checkbox"/> EZOLV The amount of current that flows to the motor when Speed Estimation Speed Searches are executed is configured as a coefficient of E2-03 [Motor No-Load Current] or E4-03 [Motor 2 Rated No-Load Current]. Normally there is no need to change this setting.	1.0 (0.0 - 3.0)	612

No. (Hex.)	Name	Description	Default (Range)	Ref.
b3-08 (0198)	Speed Estimation ACR P Gain	V/f CL-V/f OLV CLV AOLV OLV/PM AOLV/PM CLV/PM EZOLV Configures the proportional gain for the current controller used when executing the Speed Estimation Speed Search. Adjusts the speed search responsiveness. Normally there is no need to change this setting.	A1-02 = 0 through 4: Determined by $\alpha 2-04$, A1-02 = 5, 6, or 8: Determined by A1-02 (0.00 - 6.00)	612
b3-09 (0199)	Speed Estimation ACR I Time	V/f CL-V/f OLV CLV AOLV OLV/PM AOLV/PM CLV/PM EZOLV Configures the integral time for the current controller used when executing the Speed Estimation Speed Search. Adjusts the speed search responsiveness. Normally there is no need to change this setting.	Determined by A1-02 (0.0 - 1000.0 ms)	612
b3-10 (019A)	Speed Estimation Detection Gain	V/f CL-V/f OLV CLV AOLV OLV/PM AOLV/PM CLV/PM EZOLV Configures the gain used to correct frequencies estimated by the Speed Estimation Speed Search.	1.05 (1.00 - 1.20)	612
b3-14 (019E)	Bi-Direction Speed Search Select	V/f CL-V/f OLV CLV AOLV OLV/PM AOLV/PM CLV/PM EZOLV Selects which direction to start Speed Estimation Speed Search, either in the direction of the frequency reference, or the direction that the drive detected the motor is rotating. 0 : Disabled 1 : Enabled	Determined by A1-02 (0, 1)	612
b3-17 (01F0)	Speed Est. Retry Current Level	V/f CL-V/f OLV CLV AOLV OLV/PM AOLV/PM CLV/PM EZOLV Configures the current level used to operate the search retry function for Speed Estimation Speed Search, as a percentage, on the basis that the drive rated current is the 100% value.	150% (0 - 200%)	613
b3-18 (01F1)	Speed Est. Retry Detection Time	V/f CL-V/f OLV CLV AOLV OLV/PM AOLV/PM CLV/PM EZOLV Configures the time until the speed search is reexecuted (retried) when a speed search is interrupted due to significant current flowing during Speed Estimation Speed Search.	0.10 s (0.00 - 1.00 s)	613
b3-19 (01F2)	Number of Speed Search Restarts	V/f CL-V/f OLV CLV AOLV OLV/PM AOLV/PM CLV/PM EZOLV Sets the number of times to restart Speed Search if Speed Search fails.	3 times (0 - 10 times)	613
b3-24 (01C0)	Speed Search Method Selection	V/f CL-V/f OLV CLV AOLV OLV/PM AOLV/PM CLV/PM EZOLV Selects the type of Speed Search to perform when starting the motor, or when power is restored following a momentary power loss. 1 : Speed Estimation 2 : Current Detection 2	2 (1, 2)	613
b3-25 (01C8)	Speed Search Wait Time	V/f CL-V/f OLV CLV AOLV OLV/PM AOLV/PM CLV/PM EZOLV Configures the wait time used until the speed search retry function is executed.	0.5 s (0.0 - 30.0 s)	613
b3-26 (01C7)	Direction Determining Level	V/f CL-V/f OLV CLV AOLV OLV/PM AOLV/PM CLV/PM EZOLV Configures the level used to determine the direction of motor rotation. Increase the setting value if determination fails.	1000 (40 to 60000)	614
b3-27 (01C9)	Start Speed Search Select	V/f CL-V/f OLV CLV AOLV OLV/PM AOLV/PM CLV/PM EZOLV Configures the conditions used to start the speed search. 0 : SS only if RUN applied before BB 1 : SS regardless of RUN/BB sequence	0 (0, 1)	614
b3-29 (077C)	Speed Search Back-EMF Threshold	V/f CL-V/f OLV CLV AOLV OLV/PM AOLV/PM CLV/PM EZOLV Configures the induced voltage of motors for which speed searches are performed. Speed searches are performed when the level of the motor induced voltage reaches the setting value. Normally there is no need to change this setting.	10% (0 - 10%)	614
b3-31 (0BC0)	Search current Level 1	V/f CL-V/f OLV CLV AOLV OLV/PM AOLV/PM CLV/PM EZOLV Configures the current level used to restrict the output current during the Current Detection Speed Search.	1.50 (1.50 - 3.50)	614
b3-32 (0BC1)	Search current Level 2	V/f CL-V/f OLV CLV AOLV OLV/PM AOLV/PM CLV/PM EZOLV Configures the current level used to complete motor speed searches.	1.20 (0.00 - 1.49)	614

No. (Hex.)	Name	Description	Default (Range)	Ref.
b3-33 (0B3F)	Spd Search during UV Selection	<p>V/f CL-V/f OLV CLV AOLV OLV/PM AOLV/PM CLV/PM EZOLV</p> <p>Selects whether or not to execute the speed search at start-up when the Run command is input while <i>Uv</i> [DC Bus Undervoltage] is detected. 0 : Disabled 1 : Enabled</p>	1 (0, 1)	615
b3-35 (0BC3)	Voltage Detection Low Level	<p>V/f CL-V/f OLV CLV AOLV OLV/PM AOLV/PM CLV/PM EZOLV</p> <p>The speed search is enabled when the detected induced voltage of motors $\geq b3-35$.</p>	10% (5 - 50%)	615
b3-36 (0BC4)	Wait Restart Level	<p>V/f CL-V/f OLV CLV AOLV OLV/PM AOLV/PM CLV/PM EZOLV</p> <p>The restart process is prohibited and the drive enters the standby state when the detected induced voltage of the motor \geq power supply voltage $\times b3-36$. The restart process is executed when the detected induced voltage of the motor $<$ power supply voltage $\times b3-36$. Normally there is no need to change this setting.</p>	0.970 (0.500 - 1.000)	615
b3-54 (3123)	Search Time	<p>V/f CL-V/f OLV CLV AOLV OLV/PM AOLV/PM CLV/PM EZOLV</p> <p>Configures the speed search time.</p>	400 ms (10 - 2000 ms)	615
b3-55 (3124)	Current Increment Time	<p>V/f CL-V/f OLV CLV AOLV OLV/PM AOLV/PM CLV/PM EZOLV</p> <p>Configures the time used to increase the current value from zero current until the setting value of <i>b3-06</i> [Speed Estimation Current Level 1].</p>	10 ms (10 - 2000 ms)	615

◆ b4: Timer Function

No. (Hex.)	Name	Description	Default (Range)	Ref.
b4-01 (01A3)	Timer Function On-Delay Time	<p>V/f CL-V/f OLV CLV AOLV OLV/PM AOLV/PM CLV/PM EZOLV</p> <p>Sets the ON-delay time for the timer input.</p>	0.0 s (0.0 - 3000.0 s)	616
b4-02 (01A4)	Timer Function Off-Delay Time	<p>V/f CL-V/f OLV CLV AOLV OLV/PM AOLV/PM CLV/PM EZOLV</p> <p>Sets the OFF-delay time for the timer input.</p>	0.0 s (0.0 - 3000.0 s)	616
b4-03 (0B30)	H2-01 ON Delay Time	<p>V/f CL-V/f OLV CLV AOLV OLV/PM AOLV/PM CLV/PM EZOLV</p> <p>Configures the delay time until the contact is turned on after the function selected with <i>H2-01</i> turns on.</p>	0 ms (0 - 65000 ms)	617
b4-04 (0B31)	H2-01 OFF Delay Time	<p>V/f CL-V/f OLV CLV AOLV OLV/PM AOLV/PM CLV/PM EZOLV</p> <p>Configures the delay time until the contact is turned off after the function selected with <i>H2-01</i> turns off.</p>	0 ms (0 - 65000 ms)	617
b4-05 (0B32)	H2-02 ON Delay Time	<p>V/f CL-V/f OLV CLV AOLV OLV/PM AOLV/PM CLV/PM EZOLV</p> <p>Configures the delay time until the contact is turned on after the function selected with <i>H2-02</i> turns on.</p>	0 ms (0 - 65000 ms)	617
b4-06 (0B33)	H2-02 OFF Delay Time	<p>V/f CL-V/f OLV CLV AOLV OLV/PM AOLV/PM CLV/PM EZOLV</p> <p>Configures the delay time until the contact is turned off after the function selected with <i>H2-02</i> turns off.</p>	0 ms (0 - 65000 ms)	617
b4-07 (0B34)	H2-03 ON Delay Time	<p>V/f CL-V/f OLV CLV AOLV OLV/PM AOLV/PM CLV/PM EZOLV</p> <p>Configures the delay time until the contact is turned on after the function selected with <i>H2-03</i> turns on.</p>	0 ms (0 - 65000 ms)	617
b4-08 (0B35)	H2-03 OFF Delay Time	<p>V/f CL-V/f OLV CLV AOLV OLV/PM AOLV/PM CLV/PM EZOLV</p> <p>Configures the delay time until the contact is turned off after the function selected with <i>H2-03</i> turns off.</p>	0 ms (0 - 65000 ms)	617
b4-09 (0B36)	H2-04 ON Delay Time	<p>V/f CL-V/f OLV CLV AOLV OLV/PM AOLV/PM CLV/PM EZOLV</p> <p>Sets the delay time until the contact is turned on after the function selected with <i>H2-04</i> turns on.</p>	0 ms (0 - 65000 ms)	617
b4-10 (0B37)	H2-04 OFF Delay Time	<p>V/f CL-V/f OLV CLV AOLV OLV/PM AOLV/PM CLV/PM EZOLV</p> <p>Sets the delay time until the contact is turned off after the function selected with <i>H2-04</i> turns off.</p>	0 ms (0 - 65000 ms)	617

◆ b5: PID Control

No. (Hex.)	Name	Description	Default (Range)	Ref.
b5-01 (01A5)	PID Function Setting	<p>V/f CL-V/f OLV CLV AOLV OLV/PM AOLV/PM CLV/PM EZOLV</p> <p>Selects the type of PID control.</p> <p>0 : Disabled 1 : Enabled D=Fdbk 2 : Enabled D=Fdfwd 3 : Fref+PID D=Fdbk 4 : Fref+PID D=Fdfwd 5 : Enabled D=Fdbk2 6 : Enabled D=Fdfwd2 7 : Fref+PID D=Fdbk2 8 : Fref+PIDD=Fdfwd2</p> <p>Note: Use settings 5 to 8 instead of settings 1 to 4 if retrofitting the drive with a Varispeed series drive, or a similar product from a previous product line.</p>	0 (0 - 8)	623
b5-02 (01A6) RUN	Proportional Gain Setting (P)	<p>V/f CL-V/f OLV CLV AOLV OLV/PM AOLV/PM CLV/PM EZOLV</p> <p>Sets the proportional gain (P) applied to PID input.</p>	1.00 (0.00 - 25.00)	624
b5-03 (01A7) RUN	Integral Time Setting (I)	<p>V/f CL-V/f OLV CLV AOLV OLV/PM AOLV/PM CLV/PM EZOLV</p> <p>Sets the integral time (I) in seconds that is applied to PID input.</p>	1.0 s (0.0 - 360.0 s)	624
b5-04 (01A8) RUN	Integral Limit Setting	<p>V/f CL-V/f OLV CLV AOLV OLV/PM AOLV/PM CLV/PM EZOLV</p> <p>Sets the upper limit for I control as a percentage of <i>E1-04 [Maximum Output Frequency]</i>.</p>	100.0% (0.0 - 100.0%)	624
b5-05 (01A9) RUN	Derivative Time (D)	<p>V/f CL-V/f OLV CLV AOLV OLV/PM AOLV/PM CLV/PM EZOLV</p> <p>Sets the derivative time (D) for PID control. This parameter adjusts system responsiveness.</p>	0.00 s (0.00 - 10.00 s)	624
b5-06 (01AA) RUN	PID Output Limit	<p>V/f CL-V/f OLV CLV AOLV OLV/PM AOLV/PM CLV/PM EZOLV</p> <p>Sets the maximum output possible from the entire PID controller as a percentage of <i>E1-04 [Maximum Output Frequency]</i>.</p>	100.0% (0.0 - 100.0%)	625
b5-07 (01AB) RUN	PID Offset Adjustment	<p>V/f CL-V/f OLV CLV AOLV OLV/PM AOLV/PM CLV/PM EZOLV</p> <p>Sets the offset for the PID control output as a percentage of <i>E1-04 [Maximum Output Frequency]</i>.</p>	0.0% (-100.0 - +100.0%)	625
b5-08 (01AC)	PID Primary Delay Time Constant	<p>V/f CL-V/f OLV CLV AOLV OLV/PM AOLV/PM CLV/PM EZOLV</p> <p>Configures the primary delay time constant for the PID control output. Normally there is no need to change this setting.</p>	0.00 s (0.00 - 10.00 s)	625
b5-09 (01AD)	PID Output Level Selection	<p>V/f CL-V/f OLV CLV AOLV OLV/PM AOLV/PM CLV/PM EZOLV</p> <p>Reverses the polarity of the PID output.</p> <p>0 : Normal output (direct acting) 1 : Reverse output (reverse acting)</p>	0 (0, 1)	625
b5-10 (01AE) RUN	PID Output Gain Setting	<p>V/f CL-V/f OLV CLV AOLV OLV/PM AOLV/PM CLV/PM EZOLV</p> <p>Adjusts the degree of compensation by multiplying the gain by the PID output.</p>	1.00 (0.00 - 25.00)	625
b5-11 (01AF)	PID Output Reverse Selection	<p>V/f CL-V/f OLV CLV AOLV OLV/PM AOLV/PM CLV/PM EZOLV</p> <p>Sets whether or not the motor should rotate in reverse when the PID control output is negative.</p> <p>0 : Disabled: 0 lower limit 1 : Enabled: Negative lower limit</p>	0 (0, 1)	625

No. (Hex.)	Name	Description	Default (Range)	Ref.
b5-12 (01B0)	Feedback Loss Detection Select	V/f CL-V/f OLV CLV AOLV OLV/PM AOLV/PM CLV/PM EZOLV Enables or disables PID feedback loss detection. Sets operation after the drive detects PID feedback loss. 0 : No alarm_Always detected_DO only 1 : Alarm_Always detected 2 : Fault_Always detected 3 : No alarm_only @ PID enbl_DO only 4 : Alarm_only detected @ PID Enbl 5 : Fault_only detected @ PID Enbl	0 (0 - 5)	626
b5-13 (01B1)	PID Feedback Loss Detection Lvl	V/f CL-V/f OLV CLV AOLV OLV/PM AOLV/PM CLV/PM EZOLV Sets the level that triggers <i>PID Feedback Loss [FbL]</i> as a percentage of the maximum output frequency.	0% (0 - 100%)	627
b5-14 (01B2)	PID Feedback Loss Detection Time	V/f CL-V/f OLV CLV AOLV OLV/PM AOLV/PM CLV/PM EZOLV Sets the time that the PID feedback has to fall below <i>b5-13 [PID Feedback Loss Detection Lvl]</i> before <i>PID Feedback Loss [FbL]</i> is detected.	1.0 s (0.0 - 25.5 s)	627
b5-15 (01B3)	PID Sleep Function Start Level	V/f CL-V/f OLV CLV AOLV OLV/PM AOLV/PM CLV/PM EZOLV Sets the output level that triggers the PID Sleep function.	Determined by A1-02 (0.0 - 590.0)	627
b5-16 (01B4)	PID Sleep Delay Time	V/f CL-V/f OLV CLV AOLV OLV/PM AOLV/PM CLV/PM EZOLV Sets a delay time to activate or deactivate the PID Sleep function.	0.0 s (0.0 - 25.5 s)	627
b5-17 (01B5)	PID Accel/Decel Time	V/f CL-V/f OLV CLV AOLV OLV/PM AOLV/PM CLV/PM EZOLV Raises or lowers the PID setpoint using the acceleration and deceleration times set to the drive. This is a soft-starter for the PID setpoint.	0.0 s (0.0 - 6000.0 s)	627
b5-18 (01DC)	PID Setpoint Selection	V/f CL-V/f OLV CLV AOLV OLV/PM AOLV/PM CLV/PM EZOLV Enables or disables <i>b5-19 [PID Setpoint Value]</i> . 0 : Disabled 1 : Enabled	0 (0, 1)	627
b5-19 (01DD) RUN	PID Setpoint Value	V/f CL-V/f OLV CLV AOLV OLV/PM AOLV/PM CLV/PM EZOLV This setting is the PID setpoint when <i>b5-18 = 1 [PID Setpoint Selection = Enabled]</i> .	0.00% (0.00 - 100.00%)	628
b5-20 (01E2)	PID Setpoint Scaling	V/f CL-V/f OLV CLV AOLV OLV/PM AOLV/PM CLV/PM EZOLV Determines the units used to set and display <i>b5-19 [PID Setpoint Value]</i> .	1 (0 - 3)	628
b5-34 (019F) RUN	PID Output Lower Limit	V/f CL-V/f OLV CLV AOLV OLV/PM AOLV/PM CLV/PM EZOLV Sets the output lower limit for the PID control as a percentage of <i>E1-04 [Maximum Output Frequency]</i> .	0.0% (-100.0 - +100.0%)	628
b5-35 (01A0) RUN	PID Input Limit	V/f CL-V/f OLV CLV AOLV OLV/PM AOLV/PM CLV/PM EZOLV Sets the input upper limit for the PID control as a percentage of <i>E1-04 [Maximum Output Frequency]</i> .	1000.0% (0.0 - 1000.0%)	628
b5-36 (01A1)	PID Feedback High Detection Lvl	V/f CL-V/f OLV CLV AOLV OLV/PM AOLV/PM CLV/PM EZOLV Sets the level that triggers <i>Excessive PID Feedback [FbH]</i> as a percentage of <i>E1-04 [Maximum Output Frequency]</i> .	100% (0 - 100%)	629
b5-37 (01A2)	PID Feedback High Detection Time	V/f CL-V/f OLV CLV AOLV OLV/PM AOLV/PM CLV/PM EZOLV Sets the time that triggers <i>Excessive PID Feedback [FbH]</i> when the feedback signal rises above the level set in <i>b5-36 [PID Feedback High Detection Lvl]</i> .	1.0 s (0.0 - 25.5 s)	629
b5-38 (01FE)	PID Setpoint User Display	V/f CL-V/f OLV CLV AOLV OLV/PM AOLV/PM CLV/PM EZOLV Determines the value for setting and displaying <i>U5-01, U5-04</i> when outputting the maximum output frequency.	Determined by b5-20 (1 - 60000)	629
b5-39 (01FF)	PID Setpoint Display Digits	V/f CL-V/f OLV CLV AOLV OLV/PM AOLV/PM CLV/PM EZOLV Sets the number of digits for setting and displaying the PID setpoint. 0 : No decimal places 1 1 : One decimal place 2 : Two decimal places 3 : Three decimal places	Determined by b5-20 (0 - 3)	629

No. (Hex.)	Name	Description	Default (Range)	Ref.
b5-40 (017F)	Frequency Reference Monitor @PID	V/f CL-V/f OLV CLV AOLV OLV/PM AOLV/PM CLV/PM EZOLV Selects the contents displayed in monitor <i>U1-01 [Freq Reference]</i> when using PID control. 0 : with PID 1 : without PID	0 (0, 1)	629
b5-47 (017D)	PID Output Reverse Selection 2	V/f CL-V/f OLV CLV AOLV OLV/PM AOLV/PM CLV/PM EZOLV Sets whether or not the motor should rotate in reverse when the PID control output is negative. 0 : Disabled: 0 lower limit 1 : Enabled: Negative lower limit	1 (0, 1)	630
b5-53 (0B8F) RUN	Integrator Ramp Limit	V/f CL-V/f OLV CLV AOLV OLV/PM AOLV/PM CLV/PM EZOLV Adjusts the responsiveness of PID control when the PID feedback changes rapidly.	0.0 Hz (0.0 - 10.0 Hz)	630
b5-54 (0BB7)	PID softstarter cancel selection	V/f CL-V/f OLV CLV AOLV OLV/PM AOLV/PM CLV/PM EZOLV Selects the relationship between the soft starter and PID input/output. 0 : None 1 : Softstarter is canceled	0 (0, 1)	630
b5-55 (0BE1)	PID feedback monitor selection	V/f CL-V/f OLV CLV AOLV OLV/PM AOLV/PM CLV/PM EZOLV Selects the monitor (<i>Ux-xx</i>) used as the PID Feedback.	000 (000 - 999)	630
b5-56 (0BE2)	PID feedback monitor gain	V/f CL-V/f OLV CLV AOLV OLV/PM AOLV/PM CLV/PM EZOLV Configures the gain for the monitor selected with <i>b5-55 [PID feedback monitor selection]</i> .	1.00 (0.00 - 10.00)	631
b5-57 (11DD)	PID Feedback Monitor Bias	V/f CL-V/f OLV CLV AOLV OLV/PM AOLV/PM CLV/PM EZOLV Configures the bias for the monitor selected with <i>b5-55 [PID feedback monitor selection]</i> .	0.00 (-10.00 - +10.00)	631
b5-58 through b5-60 (1182 - 1184) RUN	PID Setpoints 2 through 4	V/f CL-V/f OLV CLV AOLV OLV/PM AOLV/PM CLV/PM EZOLV Configures the PID setpoint selected with <i>H1-xx = 3E or 3F [Terminal Sx Function Select = PID Setpoint Selection 1/2]</i> . This parameter is configured on the basis of the maximum output frequency being the 100% value.	0.00% (0.00 - 100.00%)	631
b5-61 (119A)	PID Trim lower limit selection	V/f CL-V/f OLV CLV AOLV OLV/PM AOLV/PM CLV/PM EZOLV Configures the function used to adjust the PID output in proportion with the frequency reference. 0 : Disabled 1 : Enabled	0 (0, 1)	631
b5-62 (119B)	PID Trim lower limit	V/f CL-V/f OLV CLV AOLV OLV/PM AOLV/PM CLV/PM EZOLV Configures the lower limit of the PID frequency reference trim on the basis of the maximum output frequency as the 100% value.	0.00% (0.00 - 100.00%)	632
b5-63 (119C)	Differential PID Feedback Select	V/f CL-V/f OLV CLV AOLV OLV/PM AOLV/PM CLV/PM EZOLV Selects the monitor (<i>Ux-xx</i>) used as the PID Differential Feedback.	000 (000 - 999)	632
b5-64 (119D)	Differential PID Feedback Gain	V/f CL-V/f OLV CLV AOLV OLV/PM AOLV/PM CLV/PM EZOLV Configures the gain of the monitor configured with <i>b5-63 [Differential PID Feedback Select]</i> .	1.00 (0.00 - 10.00)	632
b5-65 (119F)	PID Diff Fdbk Monitor Bias	V/f CL-V/f OLV CLV AOLV OLV/PM AOLV/PM CLV/PM EZOLV Configures the bias for the monitor selected with <i>b5-63 [Differential PID Feedback Select]</i> .	0.00 (-10.00 - +10.00)	632
b5-66 (11DE)	PID feedback monitor Lvl	V/f CL-V/f OLV CLV AOLV OLV/PM AOLV/PM CLV/PM EZOLV Configures the signal level for the monitor selected with <i>b5-55 [PID feedback monitor selection]</i> . 0 : Absolute 1 : +-	0 (0, 1)	632
b5-67 (11DF)	PID Diff Fdbk monitor Lvl	V/f CL-V/f OLV CLV AOLV OLV/PM AOLV/PM CLV/PM EZOLV Configures the signal level for the monitor selected with <i>b5-63 [Differential PID Feedback Select]</i> . 0 : Absolute 1 : +-	0 (0, 1)	633

No. (Hex.)	Name	Description	Default (Range)	Ref.
b5-89 (0B89) RUN	Sleep Method Selection	V/f CL-V/f OLV CLV AOLV OLV/PM AOLV/PM CLV/PM EZOLV Configures the sleep and start operations modes when using the PID function. 0 : Standard 1 : EZ Sleep/Wake-up	0 (0, 1)	633
b5-90 (0B90)	EZ Sleep Unit	V/f CL-V/f OLV CLV AOLV OLV/PM AOLV/PM CLV/PM EZOLV Configures the unit of measure for b5-91 [EZ Minimum Speed] and b5-92 [EZ Sleep Level]. 0 : 0.1Hz units 1 : rev/min	0 (0, 1)	633
b5-91 (0B91) RUN	EZ Minimum Speed	V/f CL-V/f OLV CLV AOLV OLV/PM AOLV/PM CLV/PM EZOLV Configures the minimum speed for the EZ Sleep/Wake-up function. The larger value between b5-91, b5-34 [PID Output Lower Limit], and d2-02 [Frequency Reference Lower Limit] is used internally to configure this parameter.	0.0 Hz or 0 min ⁻¹ (r/min) (0.0 to 590.0 Hz or 0 to 35400 min ⁻¹ (r/min))	633
b5-92 (0B92) RUN	EZ Sleep Level	V/f CL-V/f OLV CLV AOLV OLV/PM AOLV/PM CLV/PM EZOLV The drive enters the sleep state when the output frequency or motor speed drops below the value of b5-92 for a time longer than the setting value of b5-93 [EZ Sleep Time].	0.0 Hz or 0 min ⁻¹ (r/min) (0.0 to 590.0 Hz or 0 to 35400 min ⁻¹ (r/min))	633
b5-93 (0B93) RUN	EZ Sleep Time	V/f CL-V/f OLV CLV AOLV OLV/PM AOLV/PM CLV/PM EZOLV The drive enters the sleep state when the output frequency or motor speed drops below the value of b5-92 [EZ Sleep Level] for a time longer than the setting value of b5-93.	5.0 s (0.0 - 1000.0 s)	634
b5-94 (0B94) RUN	EZ Wake-up Level	V/f CL-V/f OLV CLV AOLV OLV/PM AOLV/PM CLV/PM EZOLV Configures the level at which the drive resumes operation from the Sleep mode.	0.00% (0.00 - 600.00%)	634
b5-95 (0B95)	EZ Wake-up Mode	V/f CL-V/f OLV CLV AOLV OLV/PM AOLV/PM CLV/PM EZOLV Selects the wake-up mode used when resuming operation from the Sleep mode. 0 : Absolute 1 : Setpoint Delta	0 (0, 1)	634
b5-96 (0B96)	EZ Wake-up Time	V/f CL-V/f OLV CLV AOLV OLV/PM AOLV/PM CLV/PM EZOLV Configures the EZ Wake-up time.	1.0 s (0.0 - 1000.0 s)	634

◆ b6: Dwell Function

No. (Hex.)	Name	Description	Default (Range)	Ref.
b6-01 (01B6)	Dwell Reference at Start	V/f CL-V/f OLV CLV AOLV OLV/PM AOLV/PM CLV/PM EZOLV Sets the output frequency to briefly maintain when starting the motor.	0.0 (Determined by A1-02)	635
b6-02 (01B7)	Dwell Time at Start	V/f CL-V/f OLV CLV AOLV OLV/PM AOLV/PM CLV/PM EZOLV Sets the time for the drive to hold the output frequency when starting the motor.	0.0 s (0.0 - 10.0 s)	635
b6-03 (01B8)	Dwell Reference at Stop	V/f CL-V/f OLV CLV AOLV OLV/PM AOLV/PM CLV/PM EZOLV Sets the output frequency to briefly maintain when ramping to stop.	0.0 (Determined by A1-02)	635
b6-04 (01B9)	Dwell Time at Stop	V/f CL-V/f OLV CLV AOLV OLV/PM AOLV/PM CLV/PM EZOLV Sets the time for the drive to hold the output frequency when ramping to stop.	0.0 s (0.0 - 10.0 s)	635

◆ b7: Droop Control

No. (Hex.)	Name	Description	Default (Range)	Ref.
b7-01 (01CA) RUN	Droop Control Gain	<input type="checkbox"/> V/f <input type="checkbox"/> CL-V/f <input type="checkbox"/> OLV <input checked="" type="checkbox"/> CLV <input type="checkbox"/> AOLV <input type="checkbox"/> OLV/PM <input type="checkbox"/> AOLV/PM <input type="checkbox"/> CLV/PM <input type="checkbox"/> EZOLV Sets the amount of deceleration when the torque reference is at 100% as a percentage of Maximum Output Frequency.	0.0% (0.0 - 100.0%)	636
b7-02 (01CB) RUN	Droop Control Delay Time	<input type="checkbox"/> V/f <input type="checkbox"/> CL-V/f <input type="checkbox"/> OLV <input checked="" type="checkbox"/> CLV <input type="checkbox"/> AOLV <input type="checkbox"/> OLV/PM <input type="checkbox"/> AOLV/PM <input type="checkbox"/> CLV/PM <input type="checkbox"/> EZOLV Adjusts the responsiveness of Droop control. Lower this setting when drive response is slow. Raise this setting when hunting or oscillation occur.	0.05 s (0.03 - 2.00 s)	636
b7-03 (017E)	Droop Control Limit Selection	<input type="checkbox"/> V/f <input type="checkbox"/> CL-V/f <input type="checkbox"/> OLV <input checked="" type="checkbox"/> CLV <input type="checkbox"/> AOLV <input type="checkbox"/> OLV/PM <input type="checkbox"/> AOLV/PM <input type="checkbox"/> CLV/PM <input type="checkbox"/> EZOLV Enables or disables the limit when using Droop control. 0 : Disabled 1 : Enabled	1 (0, 1)	636

◆ b8: Energy Saving

No. (Hex.)	Name	Description	Default (Range)	Ref.
b8-01 (01CC)	Energy Saving Control Selection	<input type="checkbox"/> V/f <input type="checkbox"/> CL-V/f <input type="checkbox"/> OLV <input checked="" type="checkbox"/> CLV <input type="checkbox"/> AOLV <input type="checkbox"/> OLV/PM <input type="checkbox"/> AOLV/PM <input type="checkbox"/> CLV/PM <input type="checkbox"/> EZOLV Enables or disables Energy-saving control. 0 : Disabled 1 : Enabled 2 : Search Enabled	0 (Determined by A1-02)	637
b8-02 (01CD) RUN	Energy Saving Gain	<input type="checkbox"/> V/f <input type="checkbox"/> CL-V/f <input type="checkbox"/> OLV <input checked="" type="checkbox"/> CLV <input type="checkbox"/> AOLV <input type="checkbox"/> OLV/PM <input type="checkbox"/> AOLV/PM <input type="checkbox"/> CLV/PM <input type="checkbox"/> EZOLV Configures the gain for energy-saving control.	Determined by A1-02 (0.0 - 10.0)	637
b8-03 (01CE) RUN	Energy Saving Filter Time	<input type="checkbox"/> V/f <input type="checkbox"/> CL-V/f <input type="checkbox"/> OLV <input checked="" type="checkbox"/> CLV <input type="checkbox"/> AOLV <input type="checkbox"/> OLV/PM <input type="checkbox"/> AOLV/PM <input type="checkbox"/> CLV/PM <input type="checkbox"/> EZOLV Configures the responsiveness for energy-saving control.	Determined by A1-02, C6-01, and o2-04 (0.00 - 10.00 s)	637
b8-04 (01CF)	Energy Saving Coefficient Value	<input type="checkbox"/> V/f <input type="checkbox"/> CL-V/f <input type="checkbox"/> OLV <input checked="" type="checkbox"/> CLV <input type="checkbox"/> AOLV <input type="checkbox"/> OLV/PM <input type="checkbox"/> AOLV/PM <input type="checkbox"/> CLV/PM <input type="checkbox"/> EZOLV Configures the energy-saving coefficient. The energy-saving coefficient is used to maintain maximum motor efficiency. The default setting is the Yaskawa motor value.	Determined by C6-01, E2-11, and o2-04. (0.00 - 655.00)	637
b8-05 (01D0)	Power Detection Filter Time	<input type="checkbox"/> V/f <input checked="" type="checkbox"/> CL-V/f <input type="checkbox"/> OLV <input type="checkbox"/> CLV <input type="checkbox"/> AOLV <input type="checkbox"/> OLV/PM <input type="checkbox"/> AOLV/PM <input type="checkbox"/> CLV/PM <input type="checkbox"/> EZOLV Configures the time constant used by the drive to measure output power.	20 ms (0 - 2000 ms)	638
b8-06 (01D1)	Search Operation Voltage Limit	<input type="checkbox"/> V/f <input checked="" type="checkbox"/> CL-V/f <input type="checkbox"/> OLV <input type="checkbox"/> CLV <input type="checkbox"/> AOLV <input type="checkbox"/> OLV/PM <input type="checkbox"/> AOLV/PM <input type="checkbox"/> CLV/PM <input type="checkbox"/> EZOLV On the basis that the motor rated voltage is the 100% value, this parameter configures the limit value of the voltage range defined for Search Operations as a percentage.	0% (0 - 100%)	638
b8-16 (01F8)	PM E-Save Coefficient Ki	<input type="checkbox"/> V/f <input type="checkbox"/> CL-V/f <input type="checkbox"/> OLV <input type="checkbox"/> CLV <input type="checkbox"/> AOLV <input type="checkbox"/> OLV/PM <input checked="" type="checkbox"/> AOLV/PM <input checked="" type="checkbox"/> CLV/PM <input type="checkbox"/> EZOLV This coefficient maintains torque linearity. Enter the Ki value written on the motor nameplate. Normally there is no need to change this setting.	1.00 (0.00 - 3.00)	638
b8-17 (01F9)	PM E-Save Coefficient Kt	<input type="checkbox"/> V/f <input type="checkbox"/> CL-V/f <input type="checkbox"/> OLV <input type="checkbox"/> CLV <input type="checkbox"/> AOLV <input type="checkbox"/> OLV/PM <input checked="" type="checkbox"/> AOLV/PM <input checked="" type="checkbox"/> CLV/PM <input type="checkbox"/> EZOLV This coefficient maintains torque linearity. Enter the Kt value written on the motor nameplate. Normally there is no need to change this setting.	1.00 (0.00 - 3.00)	638
b8-18 (01FA)	E-Save d-axis Current FilterTime	<input type="checkbox"/> V/f <input type="checkbox"/> CL-V/f <input type="checkbox"/> OLV <input type="checkbox"/> CLV <input type="checkbox"/> AOLV <input type="checkbox"/> OLV/PM <input checked="" type="checkbox"/> AOLV/PM <input checked="" type="checkbox"/> CLV/PM <input type="checkbox"/> EZOLV Configures the d-axis current reference filter time constant.	0.100 s (0.000 - 5.000 s)	639
b8-19 (0B40)	E-Save Search Injection Freq	<input type="checkbox"/> V/f <input type="checkbox"/> CL-V/f <input type="checkbox"/> OLV <input type="checkbox"/> CLV <input type="checkbox"/> AOLV <input type="checkbox"/> OLV/PM <input checked="" type="checkbox"/> AOLV/PM <input checked="" type="checkbox"/> CLV/PM <input type="checkbox"/> EZOLV Configures the energy-saving control search operation frequency. Normally there is no need to change this setting.	Determined by A1-02 (20 - 300 Hz)	639
b8-20 (0B41)	PM E-Save Search Width	<input type="checkbox"/> V/f <input type="checkbox"/> CL-V/f <input type="checkbox"/> OLV <input type="checkbox"/> CLV <input type="checkbox"/> AOLV <input type="checkbox"/> OLV/PM <input checked="" type="checkbox"/> AOLV/PM <input checked="" type="checkbox"/> CLV/PM <input type="checkbox"/> EZOLV Configures the amplitude of energy-saving control search operations.	1.0 degrees (0.1 to 5.0 degrees)	639

10.5 b: Application

No. (Hex.)	Name	Description	Default (Range)	Ref.
b8-21 (0B42)	PM E-Save Search Gain	V/f CL-V/f OLV CLV AOLV OLV/PM AOLV/PM CLV/PM EZOLV Configures the gain of search operations.	0.3Hz (0.1 - 20.0 Hz)	639
b8-22 (0B43)	PM E-Save Search LPF Cutoff Freq	V/f CL-V/f OLV CLV AOLV OLV/PM AOLV/PM CLV/PM EZOLV Configures the frequency of the filter used to extract the high-efficiency phase from search operations. Normally there is no need to change this setting.	10.0 Hz (1.0 - 30.0 Hz)	639
b8-23 (0B44)	PM E-Save Search Limit	V/f CL-V/f OLV CLV AOLV OLV/PM AOLV/PM CLV/PM EZOLV Configures the limit value of search operation output. Normally there is no need to change this setting.	15.0 degrees (0.0 to 30.0 degrees)	639
b8-24 (0B45)	PM E-Save High Freq ACR Gain	V/f CL-V/f OLV CLV AOLV OLV/PM AOLV/PM CLV/PM EZOLV Configures the gain for high-frequency current control.	200.0 Hz (100.0 - 1000.0 Hz)	640
b8-25 (0B46)	PM E-Save Search Start level	V/f CL-V/f OLV CLV AOLV OLV/PM AOLV/PM CLV/PM EZOLV Configures the level at which search operations start.	10.0% (0.0 - 100.0%)	640
b8-26 (0B47)	PM E-Save Power Setpoint	V/f CL-V/f OLV CLV AOLV OLV/PM AOLV/PM CLV/PM EZOLV Adjust this parameter when torque accuracy cannot be ensured.	0.0% (-10.0 - +10.0%)	640
b8-28 (0B8B)	Save Energy Priority Function	V/f CL-V/f OLV CLV AOLV OLV/PM AOLV/PM CLV/PM EZOLV Enables and disables operation toward an overexcitation state. 0 : Priority:Followingness 1 : Priority:Save Energy	0 (0, 1)	640
b8-29 (0B8C)	Save Energy Priority Function	V/f CL-V/f OLV CLV AOLV OLV/PM AOLV/PM CLV/PM EZOLV Switches between prioritizing the capability to respond to load changes or the energy-saving control. 0 : Priority:Followingness 1 : Priority:Save Energy	0 (0, 1)	640
b8-50 (0B0D)	Standby mode selection	V/f CL-V/f OLV CLV AOLV OLV/PM AOLV/PM CLV/PM EZOLV Enables and disables standby mode. 0 : Disabled 1 : Enabled	0 (0, 1)	640
b8-51 (0B01)	Standby mode waiting time	V/f CL-V/f OLV CLV AOLV OLV/PM AOLV/PM CLV/PM EZOLV Configures the delay time until the input side electromagnetic contactor shuts off after the drive stops.	600 s (0 - 6000 s)	641

◆ b9: Zero Servo

No. (Hex.)	Name	Description	Default (Range)	Ref.
b9-01 (01DA)	Zero Servo Gain	V/f CL-V/f OLV CLV AOLV OLV/PM AOLV/PM CLV/PM EZOLV Sets the responsiveness for the Zero Servo function.	5 (0 - 100)	642
b9-02 (01DB)	Zero Servo Completion Width	V/f CL-V/f OLV CLV AOLV OLV/PM AOLV/PM CLV/PM EZOLV Sets the output width that triggers the Zero Servo complete command. Set the allowable position displacement (deviation) from Zero Servo start position.	10 (0 - 16383)	642

10.6 C: Tuning

◆ C1: Accel and Decel Times

No. (Hex.)	Name	Description	Default (Range)	Ref.
C1-01 (0200) RUN	Acceleration Time 1	V/f CL-V/f OLV CLV AOLV OLV/PM AOLV/PM CLV/PM EZOLV Sets the time it takes to accelerate from zero to the maximum output frequency.	10.0 s (0.0 - 6000.0 s)	645
C1-02 (0201) RUN	Deceleration Time 1	V/f CL-V/f OLV CLV AOLV OLV/PM AOLV/PM CLV/PM EZOLV Sets the time it takes to decelerate from the maximum output frequency to zero.	10.0 s (0.0 - 6000.0 s)	645
C1-03 (0202) RUN	Acceleration Time 2	V/f CL-V/f OLV CLV AOLV OLV/PM AOLV/PM CLV/PM EZOLV Sets the time to accelerate from 0 to maximum frequency.	10.0 s (0.0 - 6000.0 s)	645
C1-04 (0203) RUN	Deceleration Time 2	V/f CL-V/f OLV CLV AOLV OLV/PM AOLV/PM CLV/PM EZOLV Sets the time to decelerate from maximum frequency to 0.	10.0 s (0.0 - 6000.0 s)	645
C1-05 (0204) RUN	Acceleration Time 3	V/f CL-V/f OLV CLV AOLV OLV/PM AOLV/PM CLV/PM EZOLV Sets the time to accelerate from 0 to maximum frequency.	10.0 s (0.0 - 6000.0 s)	645
C1-06 (0205) RUN	Deceleration Time 3	V/f CL-V/f OLV CLV AOLV OLV/PM AOLV/PM CLV/PM EZOLV Sets the time to decelerate from maximum frequency to 0.	10.0 s (0.0 - 6000.0 s)	645
C1-07 (0206) RUN	Acceleration Time 4	V/f CL-V/f OLV CLV AOLV OLV/PM AOLV/PM CLV/PM EZOLV Sets the time to accelerate from 0 to maximum frequency.	10.0 s (0.0 - 6000.0 s)	646
C1-08 (0207) RUN	Deceleration Time 4	V/f CL-V/f OLV CLV AOLV OLV/PM AOLV/PM CLV/PM EZOLV Sets the time to decelerate from maximum frequency to 0.	10.0 s (0.0 - 6000.0 s)	646
C1-09 (0208)	Fast Stop Time	V/f CL-V/f OLV CLV AOLV OLV/PM AOLV/PM CLV/PM EZOLV Sets the deceleration time for the drive to trigger the Fast Stop. Note: Rapid deceleration can trigger <i>ov</i> [Overvoltage]. The drive output shuts off when <i>ov</i> is detected and the motor coasts. Set an appropriate Fast Stop time to C1-09 to avoid motor coasting and to ensure that the motor stops quickly and safely.	10.0 s (0.0 - 6000.0 s)	646
C1-10 (0209)	Accel/Decel Time Setting Units	V/f CL-V/f OLV CLV AOLV OLV/PM AOLV/PM CLV/PM EZOLV Selects the setting units for C1-01 to C1-08 [Acceleration Time 1 through Deceleration Time 4], C1-09 [Fast Stop Time], L2-06 [KEB Deceleration Time], and L2-07 [KEB Acceleration Time]. 0 : 0.01 s units 1 : 0.1 s units	1 (0, 1)	646
C1-11 (020A)	Accel/Decel Time Switchover Freq	V/f CL-V/f OLV CLV AOLV OLV/PM AOLV/PM CLV/PM EZOLV Sets the frequency at which acceleration and deceleration times are automatically changed.	Determined by A1-02 (0.0 - 590.0 Hz)	647

◆ C2: S-Curve Characteristics

No. (Hex.)	Name	Description	Default (Range)	Ref.
C2-01 (020B)	S-Curve Time @ Start of Accel	V/f CL-V/f OLV CLV AOLV OLV/PM AOLV/PM CLV/PM EZOLV Sets the S-curve time to the time to start acceleration.	Determined by A1-02 (0.00 to 10.00 s)	648
C2-02 (020C)	S-Curve Time @ End of Accel	V/f CL-V/f OLV CLV AOLV OLV/PM AOLV/PM CLV/PM EZOLV Sets the S-curve time to the time to complete acceleration.	0.20 s (0.00 - 10.00 s)	648

No. (Hex.)	Name	Description	Default (Range)	Ref.
C2-03 (020D)	S-Curve Time @ Start of Decel	V/f CL-V/f OLV CLV AOLV OLV/PM AOLV/PM CLV/PM EZOLV Sets the S-curve time to the time to start deceleration.	0.20 s (0.00 - 10.00 s)	648
C2-04 (020E)	S-Curve Time @ End of Decel	V/f CL-V/f OLV CLV AOLV OLV/PM AOLV/PM CLV/PM EZOLV Sets the S-curve time to the time to complete deceleration.	0.00 s (0.00 - 10.00 s)	648

◆ C3: Slip Compensation

No. (Hex.)	Name	Description	Default (Range)	Ref.
C3-01 (020F) RUN	Slip Compensation Gain	V/f CL-V/f OLV CLV AOLV OLV/PM AOLV/PM CLV/PM EZOLV Sets the gain for the slip compensation function. Normally there is no need to change this setting. Note: Confirm that the following parameters are correctly set before changing the slip compensation gain. If <i>A1-02</i> = 2 [Control Method Selection = Open Loop Vector Control], <i>E2-02</i> [Motor Rated Slip] can be set by Auto-Tuning. • <i>E2-01</i> [Motor Rated Current (FLA)] • <i>E2-02</i> [Motor Rated Slip] • <i>E2-03</i> [Motor No-Load Current]	Determined by A1-02 (0.0 - 2.5)	648
C3-02 (0210) RUN	Slip Compensation Delay Time	V/f CL-V/f OLV CLV AOLV OLV/PM AOLV/PM CLV/PM EZOLV Adjusts the slip compensation delay time when speed is unstable or when the slip compensation response is too slow. There is normally no need to change this parameter from the default value.	Determined by A1-02 (0 - 10000 ms)	649
C3-03 (0211)	Slip Compensation Limit	V/f CL-V/f OLV CLV AOLV OLV/PM AOLV/PM CLV/PM EZOLV Sets the upper limit for the slip compensation function as a percentage of the motor rated slip.	200% (0 - 250%)	649
C3-04 (0212) RUN	Slip Compensation @ Regen Select	V/f CL-V/f OLV CLV AOLV OLV/PM AOLV/PM CLV/PM EZOLV Enables or disables slip compensation during regenerative operation. 0 : Disabled 1 : Enabled (6 Hz and above) 2 : Enabled (compensation provided wherever possible)	0 (0 - 2)	649
C3-05 (0213)	Output Voltage limit Selection	V/f CL-V/f OLV CLV AOLV OLV/PM AOLV/PM CLV/PM EZOLV Selects whether to automatically reduce the motor magnetic flux when the output voltage is saturated. 0 : Disabled 1 : Enabled	0 (0, 1)	650
C3-16 (0261)	Vout Modulation Limit Start Lvl	V/f CL-V/f OLV CLV AOLV OLV/PM AOLV/PM CLV/PM EZOLV Sets the level (modulation factor) used to start the output voltage limit operation when <i>C3-05</i> = 1 [Output Voltage limit Selection = Enabled].	90.0% (70.0 - 90.0%)	650
C3-17 (0262)	Maximum Output Voltage Limit Level	V/f CL-V/f OLV CLV AOLV OLV/PM AOLV/PM CLV/PM EZOLV Sets the level (modulation factor) used with <i>C3-18</i> [Output Voltage Limit Level] for the output voltage limit operation when <i>C3-05</i> = 1 [Output Voltage limit Selection = Enabled].	100.0% (85.0 - 100.0%)	650
C3-18 (0263)	Output Voltage Limit Level	V/f CL-V/f OLV CLV AOLV OLV/PM AOLV/PM CLV/PM EZOLV Sets the maximum drop width of the voltage reference when <i>C3-05</i> = 1 [Output Voltage limit Selection = Enabled].	90.0% (50.0 - 100.0%)	650
C3-21 (033E) RUN	Motor 2 Slip Compensation Gain	V/f CL-V/f OLV CLV AOLV OLV/PM AOLV/PM CLV/PM EZOLV Sets the gain for the motor 2 slip compensation function. There is normally no need to change this parameter from the default value. Note: Confirm that the following parameters are correctly set before changing the slip compensation gain. If <i>E3-01</i> = 2 [Motor 2 Control Mode Selection = Open Loop Vector Control], <i>E4-02</i> [Motor 2 Rated Slip] can be set by Auto-Tuning. • <i>E4-01</i> [Motor 2 Rated Current] • <i>E4-02</i> [Motor 2 Rated Slip] • <i>E4-03</i> [Motor 2 Rated No-Load Current]	Determined by E3-01 (0.0 - 2.5)	650

No. (Hex.)	Name	Description	Default (Range)	Ref.
C3-22 (0241) RUN	Motor 2 Slip Comp DelayTime	<input type="checkbox"/> V/f <input type="checkbox"/> CL-V/f <input type="checkbox"/> OLV <input type="checkbox"/> CLV <input type="checkbox"/> AOLV <input type="checkbox"/> OLV/PM <input type="checkbox"/> AOLV/PM <input type="checkbox"/> CLV/PM <input type="checkbox"/> EZOLV Adjusts the slip compensation delay time for motor 2 when speed is unstable or when the slip compensation response is too slow. Normally there is no need to change this setting.	Determined by E3-01 (0 - 10000 ms)	651
C3-23 (0242) RUN	Motor 2 Slip Compensation Limit	<input type="checkbox"/> V/f <input type="checkbox"/> CL-V/f <input type="checkbox"/> OLV <input type="checkbox"/> CLV <input type="checkbox"/> AOLV <input type="checkbox"/> OLV/PM <input type="checkbox"/> AOLV/PM <input type="checkbox"/> CLV/PM <input type="checkbox"/> EZOLV Sets the upper limit for the slip compensation function as a percentage of the motor 2 rated slip.	200% (0 - 250%)	651
C3-24 (0243) RUN	Motor 2 Slip Comp @ Regen Select	<input type="checkbox"/> V/f <input type="checkbox"/> CL-V/f <input type="checkbox"/> OLV <input type="checkbox"/> CLV <input type="checkbox"/> AOLV <input type="checkbox"/> OLV/PM <input type="checkbox"/> AOLV/PM <input type="checkbox"/> CLV/PM <input type="checkbox"/> EZOLV Enables or disables slip compensation for motor 2 during regenerative operation. 0 : Disabled 1 : Enabled (6 Hz and above) 2 : Enabled (compensation provided wherever possible)	0 (0 - 2)	651
C3-28 (1B5B)	Adaptive Slip Control Mode Select	<input type="checkbox"/> V/f <input type="checkbox"/> CL-V/f <input type="checkbox"/> OLV <input checked="" type="checkbox"/> CLV <input type="checkbox"/> AOLV <input type="checkbox"/> OLV/PM <input type="checkbox"/> AOLV/PM <input type="checkbox"/> CLV/PM <input type="checkbox"/> EZOLV Selects the mode for the slip compensation function. 0 : Normal 1 : Advance	0 (0, 1)	652

◆ C4: Torque Compensation

No. (Hex.)	Name	Description	Default (Range)	Ref.
C4-01 (0215) RUN	Torque Compensation Gain	<input type="checkbox"/> V/f <input type="checkbox"/> CL-V/f <input type="checkbox"/> OLV <input type="checkbox"/> CLV <input type="checkbox"/> AOLV <input checked="" type="checkbox"/> OLV/PM <input type="checkbox"/> AOLV/PM <input type="checkbox"/> CLV/PM <input type="checkbox"/> EZOLV Sets the gain for the torque compensation function. Sets the gain for motor 1 when multiple motors are driven.	Determined by A1-02 (0.00 - 2.50)	652
C4-02 (0216) RUN	Torque Compensation Delay Time	<input type="checkbox"/> V/f <input type="checkbox"/> CL-V/f <input type="checkbox"/> OLV <input type="checkbox"/> CLV <input type="checkbox"/> AOLV <input checked="" type="checkbox"/> OLV/PM <input type="checkbox"/> AOLV/PM <input type="checkbox"/> CLV/PM <input type="checkbox"/> EZOLV Sets the torque compensation delay time in milliseconds. Normally there is no need to change this setting.	Determined by A1-02 (0 - 60000 ms)	653
C4-03 (0217)	Torque Compensation @ FWD Start	<input type="checkbox"/> V/f <input type="checkbox"/> CL-V/f <input type="checkbox"/> OLV <input type="checkbox"/> CLV <input type="checkbox"/> AOLV <input type="checkbox"/> OLV/PM <input type="checkbox"/> AOLV/PM <input type="checkbox"/> CLV/PM <input type="checkbox"/> EZOLV Sets the amount of torque reference at start in the forward direction as a percentage of the motor rated torque.	0.0% (0.0 - 200.0%)	653
C4-04 (0218)	Torque Compensation @ REV Start	<input type="checkbox"/> V/f <input type="checkbox"/> CL-V/f <input type="checkbox"/> OLV <input type="checkbox"/> CLV <input type="checkbox"/> AOLV <input type="checkbox"/> OLV/PM <input type="checkbox"/> AOLV/PM <input type="checkbox"/> CLV/PM <input type="checkbox"/> EZOLV Sets the amount of torque reference at start in the reverse direction as a percentage of the motor rated torque.	0.0% (-200.0 - 0.0%)	653
C4-05 (0219)	Torque Compensation Time	<input type="checkbox"/> V/f <input type="checkbox"/> CL-V/f <input type="checkbox"/> OLV <input type="checkbox"/> CLV <input type="checkbox"/> AOLV <input type="checkbox"/> OLV/PM <input type="checkbox"/> AOLV/PM <input type="checkbox"/> CLV/PM <input type="checkbox"/> EZOLV Sets the starting torque constant used with C4-03 and C4-04 [Torque Compensation @ REV Start].	10 ms (0 - 200 ms)	653
C4-06 (021A)	Motor 2 Torque Comp Delay Time	<input type="checkbox"/> V/f <input type="checkbox"/> CL-V/f <input type="checkbox"/> OLV <input type="checkbox"/> CLV <input type="checkbox"/> AOLV <input type="checkbox"/> OLV/PM <input type="checkbox"/> AOLV/PM <input type="checkbox"/> CLV/PM <input type="checkbox"/> EZOLV Sets the value if <i>ov</i> [Overvoltage] occurs with sudden changes in the load, at the end of acceleration, or at the start of deceleration.	150 ms (0 - 10000 ms)	653
C4-07 (0341) RUN	Motor 2 Torque Compensation Gain	<input type="checkbox"/> V/f <input type="checkbox"/> CL-V/f <input type="checkbox"/> OLV <input type="checkbox"/> CLV <input type="checkbox"/> AOLV <input type="checkbox"/> OLV/PM <input type="checkbox"/> AOLV/PM <input type="checkbox"/> CLV/PM <input type="checkbox"/> EZOLV Sets the motor 2 gain for the torque compensation function when using the Motor Switch function.	1.00 (0.00 - 2.50)	654
C4-19 (0B8D)	T-ripple suppress freq	<input type="checkbox"/> V/f <input type="checkbox"/> CL-V/f <input type="checkbox"/> OLV <input type="checkbox"/> CLV <input type="checkbox"/> AOLV <input checked="" type="checkbox"/> OLV/PM <input type="checkbox"/> AOLV/PM <input type="checkbox"/> CLV/PM <input type="checkbox"/> EZOLV Increase the setting in increments of approximately 1.0 when current ripples and torque ripples occur during low-speed operation. If this still does not improve the situation, set C4-19 = 0 to disable this function. Normally there is no need to change this setting.	0.1 Hz (0.0 - 10.0 Hz)	654
C4-20 (0BCB)	vol compensation adjust 1	<input type="checkbox"/> V/f <input type="checkbox"/> CL-V/f <input type="checkbox"/> OLV <input type="checkbox"/> CLV <input type="checkbox"/> AOLV <input checked="" type="checkbox"/> OLV/PM <input type="checkbox"/> AOLV/PM <input type="checkbox"/> CLV/PM <input type="checkbox"/> EZOLV This parameter compensates the voltage accuracy. Normally there is no need to change this setting.	120 (0 - 200)	654
C4-21 (0BCC)	vol compensation adjust 2	<input type="checkbox"/> V/f <input type="checkbox"/> CL-V/f <input type="checkbox"/> OLV <input type="checkbox"/> CLV <input type="checkbox"/> AOLV <input checked="" type="checkbox"/> OLV/PM <input type="checkbox"/> AOLV/PM <input type="checkbox"/> CLV/PM <input type="checkbox"/> EZOLV This parameter compensates the voltage accuracy. Normally there is no need to change this setting.	5 (0 - 10)	654

◆ C5: Automatic Speed Regulator Automatic Speed Regulator

No. (Hex.)	Name	Description	Default (Range)	Ref.
C5-01 (021B) RUN	ASR Proportional Gain 1	<input type="checkbox"/> V/f <input checked="" type="checkbox"/> CL-V/f <input type="checkbox"/> OLV <input checked="" type="checkbox"/> CLV <input type="checkbox"/> AOLV <input type="checkbox"/> OLV/PM <input type="checkbox"/> AOLV/PM <input type="checkbox"/> CLV/PM <input type="checkbox"/> EZOLV Sets the gain to adjust ASR response.	Determined by A1-02 (0.00 - 300.00)	658
C5-02 (021C) RUN	ASR Integral Time 1	<input type="checkbox"/> V/f <input checked="" type="checkbox"/> CL-V/f <input type="checkbox"/> OLV <input checked="" type="checkbox"/> CLV <input type="checkbox"/> AOLV <input type="checkbox"/> OLV/PM <input type="checkbox"/> AOLV/PM <input type="checkbox"/> CLV/PM <input type="checkbox"/> EZOLV Sets the ASR integral time.	Determined by A1-02 (0.000 - 10.000 s)	658
C5-03 (021D) RUN	ASR Proportional Gain 2	<input type="checkbox"/> V/f <input checked="" type="checkbox"/> CL-V/f <input type="checkbox"/> OLV <input checked="" type="checkbox"/> CLV <input type="checkbox"/> AOLV <input type="checkbox"/> OLV/PM <input type="checkbox"/> AOLV/PM <input type="checkbox"/> CLV/PM <input type="checkbox"/> EZOLV Sets the gain to adjust ASR response.	Determined by A1-02 (0.00 - 300.00)	659
C5-04 (021E) RUN	ASR Integral Time 2	<input type="checkbox"/> V/f <input checked="" type="checkbox"/> CL-V/f <input type="checkbox"/> OLV <input checked="" type="checkbox"/> CLV <input type="checkbox"/> AOLV <input type="checkbox"/> OLV/PM <input type="checkbox"/> AOLV/PM <input type="checkbox"/> CLV/PM <input type="checkbox"/> EZOLV Sets the ASR integral time.	Determined by A1-02 (0.000 - 10.000 s)	659
C5-05 (021F) RUN	ASR Limit	<input type="checkbox"/> V/f <input checked="" type="checkbox"/> CL-V/f <input type="checkbox"/> OLV <input checked="" type="checkbox"/> CLV <input type="checkbox"/> AOLV <input type="checkbox"/> OLV/PM <input type="checkbox"/> AOLV/PM <input type="checkbox"/> CLV/PM <input type="checkbox"/> EZOLV Sets the ASR output limit as a percentage of E1-04 [Maximum Output Frequency].	5.0% (0.0 - 20.0%)	659
C5-06 (0220) RUN	ASR Delay Time	<input type="checkbox"/> V/f <input checked="" type="checkbox"/> CL-V/f <input type="checkbox"/> OLV <input checked="" type="checkbox"/> CLV <input type="checkbox"/> AOLV <input type="checkbox"/> OLV/PM <input type="checkbox"/> AOLV/PM <input type="checkbox"/> CLV/PM <input type="checkbox"/> EZOLV Sets the filter time constant for the time from the speed loop to the torque command output. There is normally no need to change this parameter from the default value.	Determined by A1-02 (0.000 - 0.500 s)	659
C5-07 (0221)	ASR Gain Switchover Frequency	<input type="checkbox"/> V/f <input checked="" type="checkbox"/> CL-V/f <input type="checkbox"/> OLV <input checked="" type="checkbox"/> CLV <input type="checkbox"/> AOLV <input type="checkbox"/> OLV/PM <input type="checkbox"/> AOLV/PM <input type="checkbox"/> CLV/PM <input type="checkbox"/> EZOLV Sets the frequency where the drive should switch between C5-01 [ASR Proportional Gain 1] and C5-03 [ASR Proportional Gain 2] as well as between integral time 1 and 2 (C5-02, C5-04). Sets the frequency where the drive should switch between C5-02 [ASR Integral Time 1] and C5-04 [ASR Integral Time 2] as well as between C5-01 and C5-03.	Determined by A1-02 (Determined by A1-02)	659
C5-08 (0222)	ASR Integral Limit	<input type="checkbox"/> V/f <input checked="" type="checkbox"/> CL-V/f <input type="checkbox"/> OLV <input checked="" type="checkbox"/> CLV <input type="checkbox"/> AOLV <input type="checkbox"/> OLV/PM <input type="checkbox"/> AOLV/PM <input type="checkbox"/> CLV/PM <input type="checkbox"/> EZOLV Sets the upper limit for ASR as a percentage of the rated load.	400% (0 - 400%)	660
C5-12 (0386)	Integral Operation @ Accel/Decel	<input type="checkbox"/> V/f <input checked="" type="checkbox"/> CL-V/f <input type="checkbox"/> OLV <input checked="" type="checkbox"/> CLV <input type="checkbox"/> AOLV <input type="checkbox"/> OLV/PM <input type="checkbox"/> AOLV/PM <input type="checkbox"/> CLV/PM <input type="checkbox"/> EZOLV Enables or disables integral operation during acceleration and deceleration. 0 : Disabled 1 : Enabled	0 (0, 1)	660
C5-17 (0276)	Motor inertia	<input type="checkbox"/> V/f <input checked="" type="checkbox"/> CL-V/f <input type="checkbox"/> OLV <input checked="" type="checkbox"/> CLV <input type="checkbox"/> AOLV <input type="checkbox"/> OLV/PM <input type="checkbox"/> AOLV/PM <input type="checkbox"/> CLV/PM <input type="checkbox"/> EZOLV Sets the motor inertia.	Determined by o2-04, C6-01, and E5-01 (0.0001 - 600.00 kgm ²)	660
C5-18 (0277)	Load Inertia Ratio	<input type="checkbox"/> V/f <input checked="" type="checkbox"/> CL-V/f <input type="checkbox"/> OLV <input checked="" type="checkbox"/> CLV <input type="checkbox"/> AOLV <input type="checkbox"/> OLV/PM <input type="checkbox"/> AOLV/PM <input type="checkbox"/> CLV/PM <input type="checkbox"/> EZOLV Sets the load inertia ratio for the motor inertia.	1.0 (0.0 - 6000.0)	660
C5-21 (0356) RUN	Motor 2 ASR Proportional Gain 1	<input type="checkbox"/> V/f <input checked="" type="checkbox"/> CL-V/f <input type="checkbox"/> OLV <input checked="" type="checkbox"/> CLV <input type="checkbox"/> AOLV <input type="checkbox"/> OLV/PM <input type="checkbox"/> AOLV/PM <input type="checkbox"/> CLV/PM <input type="checkbox"/> EZOLV Sets the gain to adjust ASR response.	Determined by E3-01 (0.00 - 300.00)	660
C5-22 (0357) RUN	Motor 2 ASR Integral Time 1	<input type="checkbox"/> V/f <input checked="" type="checkbox"/> CL-V/f <input type="checkbox"/> OLV <input checked="" type="checkbox"/> CLV <input type="checkbox"/> AOLV <input type="checkbox"/> OLV/PM <input type="checkbox"/> AOLV/PM <input type="checkbox"/> CLV/PM <input type="checkbox"/> EZOLV Sets the ASR integral time.	Determined by E3-01 (0.000 - 10.000 s)	661
C5-23 (0358) RUN	Motor 2 ASR Proportional Gain 2	<input type="checkbox"/> V/f <input checked="" type="checkbox"/> CL-V/f <input type="checkbox"/> OLV <input checked="" type="checkbox"/> CLV <input type="checkbox"/> AOLV <input type="checkbox"/> OLV/PM <input type="checkbox"/> AOLV/PM <input type="checkbox"/> CLV/PM <input type="checkbox"/> EZOLV Sets the gain to adjust ASR response.	Determined by E3-01 (0.00 - 300.00)	661
C5-24 (0359) RUN	Motor 2 ASR Integral Time 2	<input type="checkbox"/> V/f <input checked="" type="checkbox"/> CL-V/f <input type="checkbox"/> OLV <input checked="" type="checkbox"/> CLV <input type="checkbox"/> AOLV <input type="checkbox"/> OLV/PM <input type="checkbox"/> AOLV/PM <input type="checkbox"/> CLV/PM <input type="checkbox"/> EZOLV Sets the ASR integral time.	Determined by E3-01 (0.000 - 10.000 s)	661

No. (Hex.)	Name	Description	Default (Range)	Ref.
C5-25 (035A)	Motor 2 ASR Limit	<input type="checkbox"/> V/f <input checked="" type="checkbox"/> CL-V/f <input type="checkbox"/> OLV <input type="checkbox"/> CLV <input type="checkbox"/> AOLV <input type="checkbox"/> OLV/PM <input type="checkbox"/> AOLV/PM <input type="checkbox"/> CLV/PM <input type="checkbox"/> EZOLV Sets the ASR output limit as a percentage of E1-04 [Maximum Output Frequency].	5.0% (0.0 - 20.0%)	661
C5-26 (035B)	Motor 2 ASR Delay Time	<input type="checkbox"/> V/f <input type="checkbox"/> CL-V/f <input type="checkbox"/> OLV <input checked="" type="checkbox"/> CLV <input type="checkbox"/> AOLV <input type="checkbox"/> OLV/PM <input type="checkbox"/> AOLV/PM <input type="checkbox"/> CLV/PM <input type="checkbox"/> EZOLV Sets the filter time constant for the time from the speed loop to the torque command output. There is normally no need to change this parameter from the default value.	Determined by E3-01 (0.000 - 0.500 s)	662
C5-27 (035C)	Motor 2 ASR Gain Switchover Freq	<input type="checkbox"/> V/f <input type="checkbox"/> CL-V/f <input type="checkbox"/> OLV <input checked="" type="checkbox"/> CLV <input type="checkbox"/> AOLV <input type="checkbox"/> OLV/PM <input type="checkbox"/> AOLV/PM <input type="checkbox"/> CLV/PM <input type="checkbox"/> EZOLV Sets the frequency where the drive should switch between C5-21 [Motor 2 ASR Proportional Gain 1] and C5-23 [Motor 2 ASR Proportional Gain 2]. Sets the frequency where the drive should switch between C5-22 [Motor 2 ASR Integral Time 1] and C5-24 [Motor 2 ASR Integral Time 2] as well as between C5-21 and C5-23.	0.0 (Determined by A1-02)	662
C5-28 (035D)	Motor 2 ASR Integral Limit	<input type="checkbox"/> V/f <input type="checkbox"/> CL-V/f <input type="checkbox"/> OLV <input checked="" type="checkbox"/> CLV <input type="checkbox"/> AOLV <input type="checkbox"/> OLV/PM <input type="checkbox"/> AOLV/PM <input type="checkbox"/> CLV/PM <input type="checkbox"/> EZOLV Sets the upper limit for ASR in units of %. Sets the percentage of the rated load.	400% (0 - 400%)	662
C5-29 (0B18)	Speed Control Response	<input checked="" type="checkbox"/> V/f <input type="checkbox"/> CL-V/f <input type="checkbox"/> OLV <input type="checkbox"/> CLV <input type="checkbox"/> AOLV <input checked="" type="checkbox"/> OLV/PM <input type="checkbox"/> AOLV/PM <input type="checkbox"/> CLV/PM <input type="checkbox"/> EZOLV Selects the responsiveness of speed control. Normally there is no need to change this setting. 0 : Standard 1 : High speed	0 (0, 1)	662
C5-32 (0361)	Motor 2 Integral Oper @ Acc/Dec	<input type="checkbox"/> V/f <input checked="" type="checkbox"/> CL-V/f <input type="checkbox"/> OLV <input type="checkbox"/> CLV <input type="checkbox"/> AOLV <input type="checkbox"/> OLV/PM <input type="checkbox"/> AOLV/PM <input type="checkbox"/> CLV/PM <input type="checkbox"/> EZOLV Enables or disables integral operation during acceleration and deceleration. 0 : Disabled 1 : Enabled	0 (0, 1)	662
C5-37 (0278)	Motor 2 Inertia	<input type="checkbox"/> V/f <input type="checkbox"/> CL-V/f <input type="checkbox"/> OLV <input checked="" type="checkbox"/> CLV <input type="checkbox"/> AOLV <input type="checkbox"/> OLV/PM <input type="checkbox"/> AOLV/PM <input type="checkbox"/> CLV/PM <input type="checkbox"/> EZOLV Configures the motor inertia.	Determined by o2-04 and C6-01 (0.0001 - 6.0000 kgm ²)	663
C5-38 (0279)	Motor 2 Load Inertia Ratio	<input type="checkbox"/> V/f <input type="checkbox"/> CL-V/f <input type="checkbox"/> OLV <input checked="" type="checkbox"/> CLV <input type="checkbox"/> AOLV <input type="checkbox"/> OLV/PM <input type="checkbox"/> AOLV/PM <input type="checkbox"/> CLV/PM <input type="checkbox"/> EZOLV Sets the load inertia ratio for the motor inertia.	1.0 (0.0 - 6000.0)	663
C5-39 (030D)	ASR Primary Delay Time Const 2	<input type="checkbox"/> V/f <input type="checkbox"/> CL-V/f <input type="checkbox"/> OLV <input type="checkbox"/> CLV <input type="checkbox"/> AOLV <input type="checkbox"/> OLV/PM <input checked="" type="checkbox"/> AOLV/PM <input checked="" type="checkbox"/> CLV/PM <input type="checkbox"/> EZOLV Sets the filter time constant used for the time from the speed loop to the torque command output. There is normally no need to change this parameter from the default value.	0.000 s (0.000 - 0.500 s)	663
C5-50 (0B14)	Notch filter frequency	<input type="checkbox"/> V/f <input type="checkbox"/> CL-V/f <input type="checkbox"/> OLV <input checked="" type="checkbox"/> CLV <input type="checkbox"/> AOLV <input type="checkbox"/> OLV/PM <input type="checkbox"/> AOLV/PM <input checked="" type="checkbox"/> CLV/PM <input type="checkbox"/> EZOLV Sets the machine resonance frequency in increments of 1 Hz. Note: Setting C5-50 to 0 Hz disables the notch filter.	0 Hz (0, or 2 to 100 Hz)	663
C5-51 (0B15)	Notch Filter Bandwidth	<input type="checkbox"/> V/f <input type="checkbox"/> CL-V/f <input type="checkbox"/> OLV <input checked="" type="checkbox"/> CLV <input type="checkbox"/> AOLV <input type="checkbox"/> OLV/PM <input type="checkbox"/> AOLV/PM <input checked="" type="checkbox"/> CLV/PM <input type="checkbox"/> EZOLV Sets the notch width of the notch filter. Note: Setting this parameter to 0 Hz disables the function.	1.0 (0.5 - 5.0)	663

◆ C6: Carrier Frequency

No. (Hex.)	Name	Description	Default (Range)	Ref.
C6-01 (0223)	Normal / Heavy Duty Selection	<p>V/f CL-V/f OLV CLV AOLV OLV/PM AOLV/PM CLV/PM EZOLV</p> <p>Selects the drive duty rating. 0 : Constant Torque Application Heavy Duty Rating 1 (HD1) 1 : Variable Torque Application Normal Duty Rating 1 (ND1)</p>	0 (0, 1)	664
C6-02 (0224)	Carrier Frequency Selection	<p>V/f CL-V/f OLV CLV AOLV OLV/PM AOLV/PM CLV/PM EZOLV</p> <p>Selects the switching frequency (carrier frequency) for the transistors inside the drive. 1 : 2.0 kHz 2 : 5.0 kHz (4.0 kHz) 3 : 8.0 kHz (6.0 kHz) 4 : 10.0 kHz (8.0 kHz) 5 : 12.5 kHz (10.0 kHz) 6 : 15.0 kHz (12.0 kHz) 7 : Swing PWM1 (Audible Sound 1) 8 : Swing PWM2 (Audible Sound 2) 9 : Swing PWM3 (Audible Sound 3) A : Swing PWM4 (Audible Sound 4) F : User Defined (C6-03 to C6-05)</p> <p>Note:</p> <ul style="list-style-type: none"> The carrier frequency for Swing PWM 1 to 4 is equivalent to 2.0 kHz. The value in parenthesis indicates the carrier frequency when $A1-02 = 6$ [Control Method Selection = PM Advanced Open Loop Vector]. 	Determined by A1-02, C6-01, and o2-04 (Determined by A1-02)	665
C6-03 (0225)	Carrier Frequency Upper Limit	<p>V/f CL-V/f OLV CLV AOLV OLV/PM AOLV/PM CLV/PM EZOLV</p> <p>Sets the upper limit of the carrier frequency. This parameter can only be set when $C6-02 = F$ [Carrier Frequency Selection = User Defined (C6-03 to C6-05)].</p>	Determined by C6-02 (1.0 - 15.0 kHz)	666
C6-04 (0226)	Carrier Frequency Lower Limit	<p>V/f CL-V/f OLV CLV AOLV OLV/PM AOLV/PM CLV/PM EZOLV</p> <p>Sets the lower limit of the carrier frequency. This parameter can only be set when $C6-02 = F$ [Carrier Frequency Selection = User Defined (C6-03 to C6-05)].</p>	Determined by C6-02 (1.0 - 15.0 kHz)	666
C6-05 (0227)	Carrier Freq Proportional Gain	<p>V/f CL-V/f OLV CLV AOLV OLV/PM AOLV/PM CLV/PM EZOLV</p> <p>Sets the proportional gain for the carrier frequency. This parameter can only be set when $C6-02 = F$ [Carrier Frequency Selection = User Defined (C6-03 to C6-05)].</p>	Determined by C6-02 (0 - 99)	666
C6-09 (022B)	Carrier Frequency @ Rotate Tuning	<p>V/f CL-V/f OLV CLV AOLV OLV/PM AOLV/PM CLV/PM EZOLV</p> <p>Selects the carrier frequency while performing Auto-Tuning. There is normally no need to change this parameter from the default value. 0 : 5 kHz 1 : use C6-03</p>	0 (0, 1)	667

10.7 d: Reference Settings

◆ d1: Frequency reference

No. (Hex.)	Name	Description	Default (Range)	Ref.
d1-01 (0280) RUN	Reference 1	<p>V/f CL-V/f OLV CLV AOLV OLV/PM AOLV/PM CLV/PM EZOLV</p> <p>Sets the frequency reference in the unit set in <i>o1-03</i> [Keypad Display Selection].</p> <p>Note: The value set to <i>o1-03</i> [Keypad Display Selection] is changed to 1 [0.01% (100% = E1-04)] when <i>A1-02</i> = 6, 7 [Control Method Selection = AOLV/PM, CLV/PM].</p>	0.00 Hz (0.00 - 590.00 Hz)	670
d1-02 (0281) RUN	Reference 2	<p>V/f CL-V/f OLV CLV AOLV OLV/PM AOLV/PM CLV/PM EZOLV</p> <p>Sets the frequency reference in the unit set in <i>o1-03</i> [Keypad Display Selection].</p> <p>Note: The value set to <i>o1-03</i> [Keypad Display Selection] is changed to 1 [0.01% (100% = E1-04)] when <i>A1-02</i> = 6, 7 [Control Method Selection = AOLV/PM, CLV/PM].</p>	0.00 Hz (0.00 - 590.00 Hz)	671
d1-03 (0282) RUN	Reference 3	<p>V/f CL-V/f OLV CLV AOLV OLV/PM AOLV/PM CLV/PM EZOLV</p> <p>Sets the frequency reference in the unit set in <i>o1-03</i> [Keypad Display Selection].</p> <p>Note: The value set to <i>o1-03</i> [Keypad Display Selection] is changed to 1 [0.01% (100% = E1-04)] when <i>A1-02</i> = 6, 7 [AOLV/PM, CLV/PM].</p>	0.00 Hz (0.00 - 590.00 Hz)	671
d1-04 (0283) RUN	Reference 4	<p>V/f CL-V/f OLV CLV AOLV OLV/PM AOLV/PM CLV/PM EZOLV</p> <p>Sets the frequency reference in the unit set in <i>o1-03</i> [Keypad Display Selection].</p> <p>Note: The value set to <i>o1-03</i> [Keypad Display Selection] is changed to 1 [0.01% (100% = E1-04)] when <i>A1-02</i> = 6, 7 [AOLV/PM, CLV/PM].</p>	0.00 Hz (0.00 - 590.00 Hz)	671
d1-05 (0284) RUN	Reference 5	<p>V/f CL-V/f OLV CLV AOLV OLV/PM AOLV/PM CLV/PM EZOLV</p> <p>Sets the frequency reference in the unit set in <i>o1-03</i> [Keypad Display Selection].</p> <p>Note: The value set to <i>o1-03</i> [Keypad Display Selection] is changed to 1 [0.01% (100% = E1-04)] when <i>A1-02</i> = 6, 7 [Control Method Selection = AOLV/PM, CLV/PM].</p>	0.00 Hz (0.00 - 590.00 Hz)	671
d1-06 (0285) RUN	Reference 6	<p>V/f CL-V/f OLV CLV AOLV OLV/PM AOLV/PM CLV/PM EZOLV</p> <p>Sets the frequency reference in the unit set in <i>o1-03</i> [Keypad Display Selection].</p> <p>Note: The value set to <i>o1-03</i> [Keypad Display Selection] is changed to 1 [0.01% (100% = E1-04)] when <i>A1-02</i> = 6, 7 [Control Method Selection = PM Advanced Open Loop Vector, PM Closed Loop Vector Control].</p>	0.00 Hz (0.00 - 590.00 Hz)	672
d1-07 (0286) RUN	Reference 7	<p>V/f CL-V/f OLV CLV AOLV OLV/PM AOLV/PM CLV/PM EZOLV</p> <p>Sets the frequency reference in the unit set in <i>o1-03</i> [Keypad Display Selection].</p> <p>Note: The value set to <i>o1-03</i> [Keypad Display Selection] is changed to 1 [0.01% (100% = E1-04)] when <i>A1-02</i> = 6, 7 [Control Method Selection = AOLV/PM, CLV/PM].</p>	0.00 Hz (0.00 - 590.00 Hz)	672
d1-08 (0287) RUN	Reference 8	<p>V/f CL-V/f OLV CLV AOLV OLV/PM AOLV/PM CLV/PM EZOLV</p> <p>Sets the frequency reference in the unit set in <i>o1-03</i> [Keypad Display Selection].</p> <p>Note: The value set to <i>o1-03</i> [Keypad Display Selection] is changed to 1 [0.01% (100% = E1-04)] when <i>A1-02</i> = 6, 7 [Control Method Selection = AOLV/PM, CLV/PM].</p>	0.00 Hz (0.00 - 590.00 Hz)	672

10.7 d: Reference Settings

No. (Hex.)	Name	Description	Default (Range)	Ref.
d1-09 (0288) RUN	Reference 9	<p>V/f CL-V/f OLV CLV AOLV OLV/PM AOLV/PM CLV/PM EZOLV</p> <p>Sets the frequency reference in the unit set in <i>o1-03</i> [Keypad Display Selection].</p> <p>Note: The value set to <i>o1-03</i> [Keypad Display Selection] is changed to 1 [0.01% (100% = E1-04)] when <i>A1-02</i> = 6, 7 [Control Method Selection = AOLV/PM, CLV/PM].</p>	0.00 Hz (0.00 - 590.00 Hz)	672
d1-10 (028B) RUN	Reference 10	<p>V/f CL-V/f OLV CLV AOLV OLV/PM AOLV/PM CLV/PM EZOLV</p> <p>Sets the frequency reference in the unit set in <i>o1-03</i> [Keypad Display Selection].</p> <p>Note: The value set to <i>o1-03</i> [Keypad Display Selection] is changed to 1 [0.01% (100% = E1-04)] when <i>A1-02</i> = 6, 7 [Control Method Selection = AOLV/PM, CLV/PM].</p>	0.00 Hz (0.00 - 590.00 Hz)	672
d1-11 (028C) RUN	Reference 11	<p>V/f CL-V/f OLV CLV AOLV OLV/PM AOLV/PM CLV/PM EZOLV</p> <p>Sets the frequency reference in the unit set in <i>o1-03</i> [Keypad Display Selection].</p> <p>Note: The value set to <i>o1-03</i> [Keypad Display Selection] is changed to 1 [0.01% (100% = E1-04)] when <i>A1-02</i> = 6, 7 [Control Method Selection = AOLV/PM, CLV/PM].</p>	0.00 Hz (0.00 - 590.00 Hz)	673
d1-12 (028D) RUN	Reference 12	<p>V/f CL-V/f OLV CLV AOLV OLV/PM AOLV/PM CLV/PM EZOLV</p> <p>Sets the frequency reference in the unit set in <i>o1-03</i> [Keypad Display Selection].</p> <p>Note: The value set to <i>o1-03</i> [Keypad Display Selection] is changed to 1 [0.01% (100% = E1-04)] when <i>A1-02</i> = 6, 7 [Control Method Selection = AOLV/PM, CLV/PM].</p>	0.00 Hz (0.00 - 590.00 Hz)	673
d1-13 (028E) RUN	Reference 13	<p>V/f CL-V/f OLV CLV AOLV OLV/PM AOLV/PM CLV/PM EZOLV</p> <p>Sets the frequency reference in the unit set in <i>o1-03</i> [Keypad Display Selection].</p> <p>Note: The value set to <i>o1-03</i> [Keypad Display Selection] is changed to 1 [0.01% (100% = E1-04)] when <i>A1-02</i> = 6, 7 [Control Method Selection = AOLV/PM, CLV/PM].</p>	0.00 Hz (0.00 - 590.00 Hz)	673
d1-14 (028F) RUN	Reference 14	<p>V/f CL-V/f OLV CLV AOLV OLV/PM AOLV/PM CLV/PM EZOLV</p> <p>Sets the frequency reference in the unit set in <i>o1-03</i> [Keypad Display Selection].</p> <p>Note: The value set to <i>o1-03</i> [Keypad Display Selection] is changed to 1 [0.01% (100% = E1-04)] when <i>A1-02</i> = 6, 7 [Control Method Selection = AOLV/PM, CLV/PM].</p>	0.00 Hz (0.00 - 590.00 Hz)	673
d1-15 (0290) RUN	Reference 15	<p>V/f CL-V/f OLV CLV AOLV OLV/PM AOLV/PM CLV/PM EZOLV</p> <p>Sets the frequency reference in the unit set in <i>o1-03</i> [Keypad Display Selection].</p> <p>Note: The value set to <i>o1-03</i> [Keypad Display Selection] is changed to 1 [0.01% (100% = E1-04)] when <i>A1-02</i> = 6, 7 [Control Method Selection = AOLV/PM, CLV/PM].</p>	0.00 Hz (0.00 - 590.00 Hz)	674

No. (Hex.)	Name	Description	Default (Range)	Ref.
d1-16 (0291) RUN	Reference 16	<p>V/f CL-V/f OLV CLV AOLV OLV/PM AOLV/PM CLV/PM EZOLV</p> <p>Sets the frequency reference in the unit set in <i>o1-03</i> [Keypad Display Selection].</p> <p>Note: The value set to <i>o1-03</i> [Keypad Display Selection] is changed to 1 [0.01% (100% = E1-04)] when <i>A1-02</i> = 6, 7 [Control Method Selection = AOLV/PM, CLV/PM].</p>	0.00 Hz (0.00 - 590.00 Hz)	674
d1-17 (0292) RUN	Jog Reference	<p>V/f CL-V/f OLV CLV AOLV OLV/PM AOLV/PM CLV/PM EZOLV</p> <p>Sets the Jog frequency reference according to the units set in <i>o1-03</i> [Frequency Display Unit Selection]. Set <i>H1-xx</i> = 6 [Terminal Sx Function Selection = Jog Reference Selection] to use the Jog frequency reference.</p> <p>Note: The value set to <i>o1-03</i> [Keypad Display Selection] is changed to 1 [0.01% (100% = E1-04)] when <i>A1-02</i> = 6, 7 [Control Method Selection = AOLV/PM, CLV/PM].</p>	6.00 Hz (0.00 - 590.00 Hz)	674

◆ d2: Reference Limits

No. (Hex.)	Name	Description	Default (Range)	Ref.
d2-01 (0289)	Frequency Reference Upper Limit	<p>V/f CL-V/f OLV CLV AOLV OLV/PM AOLV/PM CLV/PM EZOLV</p> <p>Sets the maximum frequency reference as a percentage of <i>E1-04</i> [Maximum Output Frequency]. This limit applies to all frequency references.</p>	100.0% (0.0 - 110.0%)	675
d2-02 (028A)	Frequency Reference Lower Limit	<p>V/f CL-V/f OLV CLV AOLV OLV/PM AOLV/PM CLV/PM EZOLV</p> <p>Sets the minimum frequency reference as a percentage of <i>E1-04</i> [Maximum Output Frequency]. This limit applies to all frequency references.</p>	0.0% (0.0 - 110.0%)	675
d2-03 (0293)	Analog Speed Reference Low Limit	<p>V/f CL-V/f OLV CLV AOLV OLV/PM AOLV/PM CLV/PM EZOLV</p> <p>Sets the lower limit of the master frequency reference (Multi-Step Speed 1) as a percentage of <i>E1-04</i> [Maximum Output Frequency].</p>	0.0% (0.0 - 110.0%)	675

◆ d3: Jump Frequency

No. (Hex.)	Name	Description	Default (Range)	Ref.
d3-01 (0294)	Jump Frequency 1	<p>V/f CL-V/f OLV CLV AOLV OLV/PM AOLV/PM CLV/PM EZOLV</p> <p>Sets the median value of the specific frequency band that needs to be jumped.</p>	0.0 Hz (Determined by A1-02)	676
d3-02 (0295)	Jump Frequency 2	<p>V/f CL-V/f OLV CLV AOLV OLV/PM AOLV/PM CLV/PM EZOLV</p> <p>Sets the median value of the specific frequency band that needs to be jumped.</p>	0.0 Hz (Determined by A1-02)	676
d3-03 (0296)	Jump Frequency 3	<p>V/f CL-V/f OLV CLV AOLV OLV/PM AOLV/PM CLV/PM EZOLV</p> <p>Sets the median value of the specific frequency band that needs to be jumped.</p>	0.0 Hz (Determined by A1-02)	676
d3-04 (0297)	Jump Frequency Width	<p>V/f CL-V/f OLV CLV AOLV OLV/PM AOLV/PM CLV/PM EZOLV</p> <p>Sets the width of a specific frequency band that needs to be jumped.</p>	1.0 Hz (Determined by A1-02)	676

◆ d4: Frequency Reference Hold and Up/Down 2 Function

No. (Hex.)	Name	Description	Default (Range)	Ref.
d4-01 (0298)	Freq Reference Retention Select	<p>V/f CL-V/f OLV CLV AOLV OLV/PM AOLV/PM CLV/PM EZOLV</p> <p>Determines whether the frequency reference or the frequency bias (Up/Down 2) value is saved when the Stop command is entered or the power supply is shut down.</p> <p>This parameter is effective when <i>H1-xx</i> [<i>MFDI Function Select</i>] has been set to one of the following.</p> <ul style="list-style-type: none"> • <i>H1-xx</i> = A [<i>Accel/Decel Ramp Hold</i>] • <i>H1-xx</i> = 10/11 [<i>Up/Down Command</i>] • <i>H1-xx</i> = 75/76 [<i>Up/Down 2 Command</i>] <p>The Frequency Reference Hold function depends on which function it is combined with.</p> <p>0 : Disabled 1 : Enabled</p>	0 (0, 1)	677
d4-03 (02AA) RUN	Up/Down 2 Bias Level	<p>V/f CL-V/f OLV CLV AOLV OLV/PM AOLV/PM CLV/PM EZOLV</p> <p>Sets the bias added to or subtracted from the frequency reference by the Up/Down 2 function.</p>	0.00 Hz (0.00 - 99.99 Hz)	679
d4-04 (02AB) RUN	Up/Down 2 Ramp Selection	<p>V/f CL-V/f OLV CLV AOLV OLV/PM AOLV/PM CLV/PM EZOLV</p> <p>Selects the acceleration and deceleration times to use when adding or subtracting the bias to/from the frequency reference when using the Up/Down 2 function.</p> <p>0 : Use selected Accel/Decel time 1 : Use Accel/Decel Time 4</p>	0 (0, 1)	679
d4-05 (02AC) RUN	Up/Down 2 Bias Mode Selection	<p>V/f CL-V/f OLV CLV AOLV OLV/PM AOLV/PM CLV/PM EZOLV</p> <p>Determines if the bias value is saved to the drive when <i>Up/Down 2 Command</i> [<i>H1-xx</i> = 75, 76] are both released or both enabled. This parameter is effective only when <i>d4-03</i> [<i>Up/Down 2 Bias Level</i>] = 0.00.</p> <p>0 : Hold bias @ no Up/Down selected 1 : 0 bias @ neither/both selected</p>	0 (0, 1)	680
d4-06 (02AD)	Frequency Ref Bias (Up/Down 2)	<p>V/f CL-V/f OLV CLV AOLV OLV/PM AOLV/PM CLV/PM EZOLV</p> <p>Saves the bias value from the Up/Down 2 Command assuming that <i>E1-04</i> [<i>Maximum Output Frequency</i>] is 100%.</p>	0.0% (-99.9 - +100.0%)	680
d4-07 (02AE) RUN	Analog Freq Ref Fluctuate Limit	<p>V/f CL-V/f OLV CLV AOLV OLV/PM AOLV/PM CLV/PM EZOLV</p> <p>If the frequency reference changes for more than the level set to this parameter, then the bias value will be held. Parameter <i>E1-04</i> [<i>Maximum Output Frequency</i>] is 100%.</p>	1.0% (0.1 - 100.0%)	680
d4-08 (02AF) RUN	Up/Down 2 Bias Upper Limit	<p>V/f CL-V/f OLV CLV AOLV OLV/PM AOLV/PM CLV/PM EZOLV</p> <p>Sets the upper limit of the Up/Down 2 bias as a percentage of <i>E1-04</i> [<i>Maximum Output Frequency</i>].</p>	100.0% (0.0 - 100.0%)	681
d4-09 (02B0) RUN	Up/Down 2 Bias Lower limit	<p>V/f CL-V/f OLV CLV AOLV OLV/PM AOLV/PM CLV/PM EZOLV</p> <p>Sets the lower limit of the Up/Down 2 bias as a percentage of <i>E1-04</i> [<i>Maximum Output Frequency</i>].</p>	0.0% (-99.9 - 0.0%)	681
d4-10 (02B6)	Up/Down Freq Lower Limit Select	<p>V/f CL-V/f OLV CLV AOLV OLV/PM AOLV/PM CLV/PM EZOLV</p> <p>Selects how the lower frequency limit is set when using the Up/Down function.</p> <p>0 : d2-02 or Analog (larger level) 1 : d2-02</p>	0 (0, 1)	681

◆ d5: Torque Control

No. (Hex.)	Name	Description	Default (Range)	Ref.
d5-01 (029A)	Torque Control Selection	<input type="checkbox"/> V/f <input type="checkbox"/> CL-V/f <input type="checkbox"/> OLV <input checked="" type="checkbox"/> CLV <input type="checkbox"/> AOLV <input type="checkbox"/> OLV/PM <input type="checkbox"/> AOLV/PM <input type="checkbox"/> CLV/PM <input type="checkbox"/> EZOLV Enables/disables Torque Control. 0 : Speed Control 1 : Torque Control	0 (0, 1)	685
d5-02 (029B)	Torque Reference Delay Time	<input type="checkbox"/> V/f <input type="checkbox"/> CL-V/f <input type="checkbox"/> OLV <input checked="" type="checkbox"/> CLV <input type="checkbox"/> AOLV <input type="checkbox"/> OLV/PM <input type="checkbox"/> AOLV/PM <input type="checkbox"/> CLV/PM <input type="checkbox"/> EZOLV Sets the primary delay time constant for the torque reference filter.	Determined by A1-02 (0 - 1000 ms)	685
d5-03 (029C)	Speed Limit Selection	<input type="checkbox"/> V/f <input type="checkbox"/> CL-V/f <input type="checkbox"/> OLV <input checked="" type="checkbox"/> CLV <input type="checkbox"/> AOLV <input type="checkbox"/> OLV/PM <input type="checkbox"/> AOLV/PM <input type="checkbox"/> CLV/PM <input type="checkbox"/> EZOLV Selects the speed limit method associated with torque control. 1 : Active frequency reference 2 : d5-04 setting	1 (1, 2)	686
d5-04 (029D)	Speed Limit	<input type="checkbox"/> V/f <input type="checkbox"/> CL-V/f <input type="checkbox"/> OLV <input checked="" type="checkbox"/> CLV <input type="checkbox"/> AOLV <input type="checkbox"/> OLV/PM <input type="checkbox"/> AOLV/PM <input type="checkbox"/> CLV/PM <input type="checkbox"/> EZOLV Sets the speed limit during Torque Control as a percentage of the Maximum Output Frequency. This parameter is effective when $d5-03 = 2$ [<i>Speed Limit Selection = d5-04 setting</i>].	0% (-120 - +120%)	686
d5-05 (029E)	Speed Limit Bias	<input type="checkbox"/> V/f <input type="checkbox"/> CL-V/f <input type="checkbox"/> OLV <input checked="" type="checkbox"/> CLV <input type="checkbox"/> AOLV <input type="checkbox"/> OLV/PM <input type="checkbox"/> AOLV/PM <input type="checkbox"/> CLV/PM <input type="checkbox"/> EZOLV Sets a bias to the speed limit value as a percentage of E1-04 [Maximum Output Frequency].	10% (0 - 120%)	686
d5-06 (029F)	Speed/Torque Changeover Time	<input type="checkbox"/> V/f <input type="checkbox"/> CL-V/f <input type="checkbox"/> OLV <input checked="" type="checkbox"/> CLV <input type="checkbox"/> AOLV <input type="checkbox"/> OLV/PM <input type="checkbox"/> AOLV/PM <input type="checkbox"/> CLV/PM <input type="checkbox"/> EZOLV Sets the delay time for switching between Speed Control and Torque Control using the multi-function digital input terminal. This parameter is effective when $H1-xx = 71$ [<i>MFDI Function Select = Speed/Torque Control Switch</i>] has been set.	0 ms (0 - 1000 ms)	686
d5-08 (02B5)	Unidirectional Speed Limit Bias	<input type="checkbox"/> V/f <input type="checkbox"/> CL-V/f <input type="checkbox"/> OLV <input checked="" type="checkbox"/> CLV <input type="checkbox"/> AOLV <input type="checkbox"/> OLV/PM <input type="checkbox"/> AOLV/PM <input type="checkbox"/> CLV/PM <input type="checkbox"/> EZOLV Selects the direction of the speed limit reference to which <i>Speed Limit Bias [d5-05]</i> applies. 0 : Disabled 1 : Enabled	1 (0, 1)	686

◆ d6: Field Weak & Field Force

No. (Hex.)	Name	Description	Default (Range)	Ref.
d6-01 (02A0)	Field Weakening Level	<input type="checkbox"/> V/f <input checked="" type="checkbox"/> CL-V/f <input type="checkbox"/> OLV <input type="checkbox"/> CLV <input type="checkbox"/> AOLV <input type="checkbox"/> OLV/PM <input type="checkbox"/> AOLV/PM <input type="checkbox"/> CLV/PM <input type="checkbox"/> EZOLV Sets the output voltage of the drive when the <i>Field weakening [H1-xx = 63]</i> is input as a percentage of the maximum output voltage.	80% (0 - 100%)	687
d6-02 (02A1)	Field Weakening Frequency Limit	<input type="checkbox"/> V/f <input checked="" type="checkbox"/> CL-V/f <input type="checkbox"/> OLV <input type="checkbox"/> CLV <input type="checkbox"/> AOLV <input type="checkbox"/> OLV/PM <input type="checkbox"/> AOLV/PM <input type="checkbox"/> CLV/PM <input type="checkbox"/> EZOLV Sets the minimum output frequency at which field weakening can be activated.	0.0 Hz (0.0 - 590.0 Hz)	687
d6-03 (02A2)	Field Forcing Selection	<input type="checkbox"/> V/f <input type="checkbox"/> CL-V/f <input type="checkbox"/> OLV <input checked="" type="checkbox"/> CLV <input type="checkbox"/> AOLV <input type="checkbox"/> OLV/PM <input type="checkbox"/> AOLV/PM <input type="checkbox"/> CLV/PM <input type="checkbox"/> EZOLV Enables or disables the field forcing function. 0 : Disabled 1 : Enabled	0 (0, 1)	687
d6-06 (02A5)	Field Forcing Limit	<input type="checkbox"/> V/f <input type="checkbox"/> CL-V/f <input type="checkbox"/> OLV <input checked="" type="checkbox"/> CLV <input type="checkbox"/> AOLV <input type="checkbox"/> OLV/PM <input type="checkbox"/> AOLV/PM <input type="checkbox"/> CLV/PM <input type="checkbox"/> EZOLV Sets the maximum level at which the Field Forcing function can boost the excitation current reference as a percentage of the motor no load current. Normally there is no need to change this setting.	400% (100 - 400%)	687

◆ d7: Offset Frequency

No. (Hex.)	Name	Description	Default (Range)	Ref.
d7-01 (02B2) RUN	Offset Frequency 1	<div style="display: flex; justify-content: space-between; font-size: 0.8em; font-weight: bold; background-color: #333; color: white; padding: 2px;"> V/f CL-V/f OLV CLV AOLV OLV/PM AOLV/PM CLV/PM EZOLV </div> <p>Adds or subtracts the set frequency to/from the frequency reference using $H1-xx = 44$ [MFDI Function Select = Offset frequency 1] as a percentage of the maximum output frequency.</p>	0.0% (-100.0 - +100.0%)	688
d7-02 (02B3) RUN	Offset Frequency 2	<div style="display: flex; justify-content: space-between; font-size: 0.8em; font-weight: bold; background-color: #333; color: white; padding: 2px;"> V/f CL-V/f OLV CLV AOLV OLV/PM AOLV/PM CLV/PM EZOLV </div> <p>Adds or subtracts the set frequency to/from the frequency reference using $H1-xx = 45$ [MFDI Function Select = Offset frequency 2] as a percentage of the maximum output frequency.</p>	0.0% (-100.0 - +100.0%)	688
d7-03 (02B4) RUN	Offset Frequency 3	<div style="display: flex; justify-content: space-between; font-size: 0.8em; font-weight: bold; background-color: #333; color: white; padding: 2px;"> V/f CL-V/f OLV CLV AOLV OLV/PM AOLV/PM CLV/PM EZOLV </div> <p>Adds or subtracts the set frequency to/from the frequency reference using $H1-xx = 46$ [MFDI Function Select = Offset frequency 3] as a percentage of the maximum output frequency.</p>	0.0% (-100.0 - +100.0%)	688

10.8 E: Motor Parameters

◆ E1: V/f Pattern for Motor 1

No. (Hex.)	Name	Description	Default (Range)	Ref.
E1-01 (0300)	Input AC Supply Voltage	<p>V/f CL-V/f OLV CLV AOLV OLV/PM AOLV/PM CLV/PM EZOLV</p> <p>Sets the drive input voltage. Set this parameter to the nominal voltage of the AC power supply.</p> <p>NOTICE: Set parameter E1-01 [Input AC Supply Voltage] to match the input voltage of the drive. Drive input voltage (not motor voltage) must be set in E1-01 for the protective features to function properly. Failure to set the correct drive input voltage will result in improper drive operation.</p>	200 V Class: 200 V, 400 V: 400 V (200 V Class: 155 to 255 V, 400 V Class: 310 to 510 V)	690
E1-03 (0302)	V/f Pattern Selection	<p>V/f CL-V/f OLV CLV AOLV OLV/PM AOLV/PM CLV/PM EZOLV</p> <p>Selects the V/f pattern for the drive and motor from 15 predefined patterns (settings: 0 through E) or creates a custom V/f pattern (setting: F).</p> <p>0 : Constant Trq_50Hz base_50Hz max 1 : Constant Trq_60Hz base_60Hz max 2 : Constant Trq_50Hz base_60Hz max 3 : Constant Trq_60Hz base_72Hz max 4 : Variable Trq_50Hz base_35% mid V 5 : Variable Trq_50Hz base_50% mid V 6 : Variable Trq_60Hz base_35% mid V 7 : Variable Trq_60Hz base_50% mid V 8 : High Start Trq_50Hz base_125% V 9 : High Start Trq_50Hz base_165% V A : High Start Trq_60Hz base_125% V B : High Start Trq_60Hz base_165% V C : High Freq_60Hz base_90Hz max D : High Freq_60Hz base_120Hz max E : High Freq_60Hz base_180Hz max F : Custom</p> <p>Note:</p> <ul style="list-style-type: none"> Setting 0 through E cannot be selected when A1-02 = 2 [Control Method Selection = Open Loop Vector Control]. Select the appropriate V/f pattern in accordance with the application and usage environment. Setting an improper V/f pattern may result in low motor torque or increased current due to overexcitation. 	F (Determined by A1-02)	690
E1-04 (0303)	Maximum Output Frequency	<p>V/f CL-V/f OLV CLV AOLV OLV/PM AOLV/PM CLV/PM EZOLV</p> <p>Sets the maximum output frequency for the V/f pattern.</p>	Determined by A1-02 and E5-01 (Determined by A1-02 and E5-01)	695
E1-05 (0304)	Maximum Output Voltage	<p>V/f CL-V/f OLV CLV AOLV OLV/PM AOLV/PM CLV/PM EZOLV</p> <p>Sets the maximum voltage for the V/f pattern.</p>	Determined by A1-02 (200 V Class: 0.0 - 255.0 V, 400 V Class: 0.0 - 510.0 V)	696
E1-06 (0305)	Base Frequency	<p>V/f CL-V/f OLV CLV AOLV OLV/PM AOLV/PM CLV/PM EZOLV</p> <p>Sets the base frequency for the V/f pattern.</p>	Determined by A1-02 and E5-01 (0.0 to E1-04)	696
E1-07 (0306)	Mid Point A Frequency	<p>V/f CL-V/f OLV CLV AOLV OLV/PM AOLV/PM CLV/PM EZOLV</p> <p>Sets the middle output frequency.</p>	Determined by A1-02 (0.0 to E-04)	696
E1-08 (0307)	Mid Point A Voltage	<p>V/f CL-V/f OLV CLV AOLV OLV/PM AOLV/PM CLV/PM EZOLV</p> <p>Sets the middle output frequency.</p>	Determined by A1-02 (200 V Class: 0.0 to 255.0 V, 400 V Class: 0.0 to 510.0 V)	696

10.8 E: Motor Parameters

No. (Hex.)	Name	Description	Default (Range)	Ref.
E1-09 (0308)	Minimum Output Frequency	<input checked="" type="checkbox"/> V/f <input type="checkbox"/> CL-V/f <input type="checkbox"/> OLV <input type="checkbox"/> CLV <input type="checkbox"/> AOLV <input type="checkbox"/> OLV/PM <input type="checkbox"/> AOLV/PM <input type="checkbox"/> CLV/PM <input type="checkbox"/> EZOLV Sets the minimum output frequency for the V/f pattern.	Determined by A1-02 and E5-01 (Determined by A1-02, E1-04, and E5-01)	696
E1-10 (0309)	Minimum Output Voltage	<input checked="" type="checkbox"/> V/f <input type="checkbox"/> CL-V/f <input type="checkbox"/> OLV <input type="checkbox"/> CLV <input type="checkbox"/> AOLV <input type="checkbox"/> OLV/PM <input type="checkbox"/> AOLV/PM <input type="checkbox"/> CLV/PM <input type="checkbox"/> EZOLV Sets the minimum output voltage.	Determined by A1-02 (200 V Class: 0.0 - 255.0 V, 400 V Class: 0.0 - 510.0 V)	696
E1-11 (030A)	Mid Point B Frequency	<input checked="" type="checkbox"/> V/f <input type="checkbox"/> CL-V/f <input type="checkbox"/> OLV <input type="checkbox"/> CLV <input type="checkbox"/> AOLV <input type="checkbox"/> OLV/PM <input type="checkbox"/> AOLV/PM <input type="checkbox"/> CLV/PM <input type="checkbox"/> EZOLV Configures the mid point B frequency.	0.0 Hz (0.0 to E-04)	696
E1-12 (030B)	Mid Point B Voltage	<input checked="" type="checkbox"/> V/f <input type="checkbox"/> CL-V/f <input type="checkbox"/> OLV <input type="checkbox"/> CLV <input type="checkbox"/> AOLV <input type="checkbox"/> OLV/PM <input type="checkbox"/> AOLV/PM <input type="checkbox"/> CLV/PM <input type="checkbox"/> EZOLV Sets the mid point B voltage.	0.0 V (200 V Class: 0.0 - 255.0 V, 400 V Class: 0.0 - 510.0 V)	697
E1-13 (030C)	Base Voltage	<input checked="" type="checkbox"/> V/f <input type="checkbox"/> CL-V/f <input type="checkbox"/> OLV <input type="checkbox"/> CLV <input type="checkbox"/> AOLV <input type="checkbox"/> OLV/PM <input type="checkbox"/> AOLV/PM <input type="checkbox"/> CLV/PM <input type="checkbox"/> EZOLV Sets the base voltage.	0.0 V (200 V Class: 0.0 - 255.0 V, 400 V Class: 0.0 - 510.0 V)	697

◆ E2: Motor Parameters

No. (Hex.)	Name	Description	Default Setting (Range)	Ref.
E2-01 (030E)	Motor Rated Current	<input checked="" type="checkbox"/> V/f <input type="checkbox"/> CL-V/f <input type="checkbox"/> OLV <input type="checkbox"/> CLV <input type="checkbox"/> AOLV <input type="checkbox"/> OLV/PM <input type="checkbox"/> AOLV/PM <input type="checkbox"/> CLV/PM <input type="checkbox"/> EZOLV Sets the motor rated current in amps.	Determined by o2-04 and C6-01 (10% to 200% of the drive rated current)	218
E2-02 (030F) RUN	Motor Rated Slip	<input checked="" type="checkbox"/> V/f <input type="checkbox"/> CL-V/f <input type="checkbox"/> OLV <input type="checkbox"/> CLV <input type="checkbox"/> AOLV <input type="checkbox"/> OLV/PM <input type="checkbox"/> AOLV/PM <input type="checkbox"/> CLV/PM <input type="checkbox"/> EZOLV Sets the amount of motor rated slip.	Determined by o2-04 and C6-01 (0.000 - 20.000 Hz)	698
E2-03 (0310)	Motor No-Load Current	<input checked="" type="checkbox"/> V/f <input type="checkbox"/> CL-V/f <input type="checkbox"/> OLV <input type="checkbox"/> CLV <input type="checkbox"/> AOLV <input type="checkbox"/> OLV/PM <input type="checkbox"/> AOLV/PM <input type="checkbox"/> CLV/PM <input type="checkbox"/> EZOLV Set the no-load current for the motor in amperes when operating at the rated frequency and the no-load voltage.	Determined by o2-04 and C6-01 (0 to E2-01)	698
E2-04 (0311)	Motor Pole Count	<input checked="" type="checkbox"/> V/f <input type="checkbox"/> CL-V/f <input type="checkbox"/> OLV <input type="checkbox"/> CLV <input type="checkbox"/> AOLV <input type="checkbox"/> OLV/PM <input type="checkbox"/> AOLV/PM <input type="checkbox"/> CLV/PM <input type="checkbox"/> EZOLV Sets the number of motor poles.	4 (2 - 48)	698
E2-05 (0312)	Motor Line-to-Line Resistance	<input checked="" type="checkbox"/> V/f <input type="checkbox"/> CL-V/f <input type="checkbox"/> OLV <input type="checkbox"/> CLV <input type="checkbox"/> AOLV <input type="checkbox"/> OLV/PM <input type="checkbox"/> AOLV/PM <input type="checkbox"/> CLV/PM <input type="checkbox"/> EZOLV Sets the line-to-line resistance for motor stator windings.	Determined by o2-04 and C6-01 (0.000 - 65.000 Ω)	698
E2-06 (0313)	Motor Leakage Inductance	<input checked="" type="checkbox"/> V/f <input type="checkbox"/> CL-V/f <input type="checkbox"/> OLV <input type="checkbox"/> CLV <input type="checkbox"/> AOLV <input type="checkbox"/> OLV/PM <input type="checkbox"/> AOLV/PM <input type="checkbox"/> CLV/PM <input type="checkbox"/> EZOLV Sets the voltage drop due to motor leakage inductance as a percentage of motor rated voltage while the motor is operating at the rated frequency and rated current.	Determined by o2-04 and C6-01 (0.0 - 40.0%)	699
E2-07 (0314)	Motor Saturation Coefficient 1	<input type="checkbox"/> V/f <input type="checkbox"/> CL-V/f <input type="checkbox"/> OLV <input checked="" type="checkbox"/> CLV <input type="checkbox"/> AOLV <input type="checkbox"/> OLV/PM <input type="checkbox"/> AOLV/PM <input type="checkbox"/> CLV/PM <input type="checkbox"/> EZOLV Sets the motor iron-core saturation coefficient at 50% of the magnetic flux.	0.50 (0.00 - 0.50)	699
E2-08 (0315)	Motor Saturation Coefficient 2	<input type="checkbox"/> V/f <input type="checkbox"/> CL-V/f <input type="checkbox"/> OLV <input checked="" type="checkbox"/> CLV <input type="checkbox"/> AOLV <input type="checkbox"/> OLV/PM <input type="checkbox"/> AOLV/PM <input type="checkbox"/> CLV/PM <input type="checkbox"/> EZOLV Sets the motor iron-core saturation coefficient at 75% of the magnetic flux.	0.75 (E2-07 to 0.75)	699
E2-09 (0316)	Motor Mechanical Loss	<input type="checkbox"/> V/f <input type="checkbox"/> CL-V/f <input type="checkbox"/> OLV <input checked="" type="checkbox"/> CLV <input type="checkbox"/> AOLV <input type="checkbox"/> OLV/PM <input type="checkbox"/> AOLV/PM <input type="checkbox"/> CLV/PM <input type="checkbox"/> EZOLV Configures the mechanical loss of the motor. The motor rated power (kW) is 100%. Normally there is no need to change this setting.	0.0% (0.0 - 10.0%)	699

No. (Hex.)	Name	Description	Default Setting (Range)	Ref.
E2-10 (0317)	Motor Iron Loss	<input checked="" type="checkbox"/> V/f <input checked="" type="checkbox"/> CL-V/f <input type="checkbox"/> OLV <input type="checkbox"/> CLV <input type="checkbox"/> AOLV <input type="checkbox"/> OLV/PM <input type="checkbox"/> AOLV/PM <input type="checkbox"/> CLV/PM <input type="checkbox"/> EZOLV Sets the motor iron loss in watts.	Determined by o2-04 and C6-01 (0 - 65535 W)	699
E2-11 (0318)	Motor Rated Power (kW)	<input checked="" type="checkbox"/> V/f <input checked="" type="checkbox"/> CL-V/f <input type="checkbox"/> OLV <input type="checkbox"/> CLV <input type="checkbox"/> AOLV <input type="checkbox"/> OLV/PM <input type="checkbox"/> AOLV/PM <input type="checkbox"/> CLV/PM <input type="checkbox"/> EZOLV Sets the motor rated power in 0.01 kW units. (1 HP = 0.746 kW)	Determined by o2-04 and C6-01 (0.00 - 650.00 kW)	699

◆ E3: V/f Pattern for Motor 2

No. (Hex.)	Name	Description	Default (Range)	Ref.
E3-01 (0319)	Motor 2 Control Mode Selection	<input checked="" type="checkbox"/> V/f <input checked="" type="checkbox"/> CL-V/f <input type="checkbox"/> OLV <input type="checkbox"/> CLV <input type="checkbox"/> AOLV <input type="checkbox"/> OLV/PM <input type="checkbox"/> AOLV/PM <input type="checkbox"/> CLV/PM <input type="checkbox"/> EZOLV Selects the control method for motor 2. Note: Changing the motor 2 control mode selection changes the settings value of parameters dependent on E3-01 to the default settings. 0 : V/f Control 1 : Closed Loop V/f Control 2 : Open Loop Vector Control 3 : Closed Loop Vector Control	0 (0 - 3)	700
E3-04 (031A)	Motor 2 Maximum Output Frequency	<input checked="" type="checkbox"/> V/f <input checked="" type="checkbox"/> CL-V/f <input type="checkbox"/> OLV <input type="checkbox"/> CLV <input type="checkbox"/> AOLV <input type="checkbox"/> OLV/PM <input type="checkbox"/> AOLV/PM <input type="checkbox"/> CLV/PM <input type="checkbox"/> EZOLV Sets the maximum output frequency used for motor 2.	Determined by E3-01 (40.0 - 590.0 Hz)	700
E3-05 (031B)	Motor 2 Maximum Output Voltage	<input checked="" type="checkbox"/> V/f <input checked="" type="checkbox"/> CL-V/f <input type="checkbox"/> OLV <input type="checkbox"/> CLV <input type="checkbox"/> AOLV <input type="checkbox"/> OLV/PM <input type="checkbox"/> AOLV/PM <input type="checkbox"/> CLV/PM <input type="checkbox"/> EZOLV Sets the maximum output voltage used for motor 2.	Determined by E3-01 (200 V Class: 0.0 to 255.0 V, 400 V Class: 0.0 to 510.0 V)	701
E3-06 (031C)	Motor 2 Base Frequency	<input checked="" type="checkbox"/> V/f <input checked="" type="checkbox"/> CL-V/f <input type="checkbox"/> OLV <input type="checkbox"/> CLV <input type="checkbox"/> AOLV <input type="checkbox"/> OLV/PM <input type="checkbox"/> AOLV/PM <input type="checkbox"/> CLV/PM <input type="checkbox"/> EZOLV Sets the base frequency used for motor 2.	Determined by E3-01 (0.0 to E3-04)	701
E3-07 (031D)	Motor 2 Mid Point A Frequency	<input checked="" type="checkbox"/> V/f <input checked="" type="checkbox"/> CL-V/f <input type="checkbox"/> OLV <input type="checkbox"/> CLV <input type="checkbox"/> AOLV <input type="checkbox"/> OLV/PM <input type="checkbox"/> AOLV/PM <input type="checkbox"/> CLV/PM <input type="checkbox"/> EZOLV Sets the middle output frequency used for motor 2.	Determined by E3-01 (0.0 to E3-04)	701
E3-08 (031E)	Motor 2 Mid Point A Voltage	<input checked="" type="checkbox"/> V/f <input checked="" type="checkbox"/> CL-V/f <input type="checkbox"/> OLV <input type="checkbox"/> CLV <input type="checkbox"/> AOLV <input type="checkbox"/> OLV/PM <input type="checkbox"/> AOLV/PM <input type="checkbox"/> CLV/PM <input type="checkbox"/> EZOLV Sets the middle output frequency voltage used for motor 2.	Determined by E3-01 (200 V Class: 0.0 to 255.0 V, 400 V Class: 0.0 to 510.0 V)	701
E3-09 (031F)	Motor 2 Minimum Output Frequency	<input checked="" type="checkbox"/> V/f <input checked="" type="checkbox"/> CL-V/f <input type="checkbox"/> OLV <input type="checkbox"/> CLV <input type="checkbox"/> AOLV <input type="checkbox"/> OLV/PM <input type="checkbox"/> AOLV/PM <input type="checkbox"/> CLV/PM <input type="checkbox"/> EZOLV Sets the minimum output frequency used for motor 2.	Determined by E3-01 (0.0 to E3-04)	701
E3-10 (0320)	Motor 2 Minimum Output Voltage	<input checked="" type="checkbox"/> V/f <input checked="" type="checkbox"/> CL-V/f <input type="checkbox"/> OLV <input type="checkbox"/> CLV <input type="checkbox"/> AOLV <input type="checkbox"/> OLV/PM <input type="checkbox"/> AOLV/PM <input type="checkbox"/> CLV/PM <input type="checkbox"/> EZOLV Sets the minimum output voltage used for motor 2.	Determined by E3-01 (200 V Class: 0.0 to 255.0 V, 400 V Class: 0.0 to 510.0 V)	701
E3-11 (0345)	Motor 2 Mid Point B Frequency	<input checked="" type="checkbox"/> V/f <input checked="" type="checkbox"/> CL-V/f <input type="checkbox"/> OLV <input type="checkbox"/> CLV <input type="checkbox"/> AOLV <input type="checkbox"/> OLV/PM <input type="checkbox"/> AOLV/PM <input type="checkbox"/> CLV/PM <input type="checkbox"/> EZOLV Sets the mid point B frequency used for motor 2. Configure this parameter only when the V/f pattern for the constant output range needs to be adjusted. Normally there is no need to configure this setting.	0.0 Hz (0.0 to E3-04)	701

10.8 E: Motor Parameters

No. (Hex.)	Name	Description	Default (Range)	Ref.
E3-12 (0346)	Motor 2 Mid Point B Voltage	<input type="checkbox"/> V/f <input type="checkbox"/> CL-V/f <input type="checkbox"/> OLV <input type="checkbox"/> CLV <input type="checkbox"/> AOLV <input type="checkbox"/> OLV/PM <input type="checkbox"/> AOLV/PM <input type="checkbox"/> CLV/PM <input type="checkbox"/> EZOLV Sets the mid point B voltage used for motor 2. Configure this parameter only when the V/f pattern for the constant output range needs to be adjusted. Normally there is no need to configure this setting.	0.0 V (200 V Class: 0.0 - 255.0 V, 400 V Class: 0.0 - 510.0 V)	702
E3-13 (0347)	Motor 2 Base Voltage	<input type="checkbox"/> V/f <input type="checkbox"/> CL-V/f <input type="checkbox"/> OLV <input type="checkbox"/> CLV <input type="checkbox"/> AOLV <input type="checkbox"/> OLV/PM <input type="checkbox"/> AOLV/PM <input type="checkbox"/> CLV/PM <input type="checkbox"/> EZOLV Configures the base voltage used for motor 2. Configure this parameter only when the V/f pattern for the constant output range needs to be adjusted. Normally there is no need to configure this setting.	0.0 V (200 V Class: 0.0 - 255.0 V, 400 V Class: 0.0 - 510.0 V)	702

◆ E4: Motor 2 Parameters

No. (Hex.)	Name	Description	Default (Range)	Ref.
E4-01 (0321)	Motor 2 Rated Current	<input type="checkbox"/> V/f <input type="checkbox"/> CL-V/f <input type="checkbox"/> OLV <input type="checkbox"/> CLV <input type="checkbox"/> AOLV <input type="checkbox"/> OLV/PM <input type="checkbox"/> AOLV/PM <input type="checkbox"/> CLV/PM <input type="checkbox"/> EZOLV Sets the motor rated current for motor 2 in amperes.	Determined by o2-04 and C6-01 (10% to 200% of the drive rated current)	702
E4-02 (0322) RUN	Motor 2 Rated Slip	<input type="checkbox"/> V/f <input type="checkbox"/> CL-V/f <input type="checkbox"/> OLV <input type="checkbox"/> CLV <input type="checkbox"/> AOLV <input type="checkbox"/> OLV/PM <input type="checkbox"/> AOLV/PM <input type="checkbox"/> CLV/PM <input type="checkbox"/> EZOLV Sets the amount of motor 2 rated slip.	Determined by o2-04 and C6-01 (0.000 - 20.000 Hz)	702
E4-03 (0323)	Motor 2 Rated No-Load Current	<input type="checkbox"/> V/f <input type="checkbox"/> CL-V/f <input type="checkbox"/> OLV <input type="checkbox"/> CLV <input type="checkbox"/> AOLV <input type="checkbox"/> OLV/PM <input type="checkbox"/> AOLV/PM <input type="checkbox"/> CLV/PM <input type="checkbox"/> EZOLV Sets the no-load current for motor 2 in amperes when operating at the rated frequency and the no-load voltage.	Determined by o2-04 and C6-01 (0 to E4-01)	703
E4-04 (0324)	Motor 2 Motor Poles	<input type="checkbox"/> V/f <input type="checkbox"/> CL-V/f <input type="checkbox"/> OLV <input type="checkbox"/> CLV <input type="checkbox"/> AOLV <input type="checkbox"/> OLV/PM <input type="checkbox"/> AOLV/PM <input type="checkbox"/> CLV/PM <input type="checkbox"/> EZOLV Sets the number of poles for motor 2.	4 (2 - 48)	703
E4-05 (0325)	Motor 2 Line-to-Line Resistance	<input type="checkbox"/> V/f <input type="checkbox"/> CL-V/f <input type="checkbox"/> OLV <input type="checkbox"/> CLV <input type="checkbox"/> AOLV <input type="checkbox"/> OLV/PM <input type="checkbox"/> AOLV/PM <input type="checkbox"/> CLV/PM <input type="checkbox"/> EZOLV Sets the line-to-line resistance for motor 2 stator windings.	Determined by o2-04 and C6-01 (0.000 - 65.000 Ω)	703
E4-06 (0326)	Motor 2 Leakage Inductance	<input type="checkbox"/> V/f <input type="checkbox"/> CL-V/f <input type="checkbox"/> OLV <input type="checkbox"/> CLV <input type="checkbox"/> AOLV <input type="checkbox"/> OLV/PM <input type="checkbox"/> AOLV/PM <input type="checkbox"/> CLV/PM <input type="checkbox"/> EZOLV Sets the voltage drop due to motor 2 leakage inductance as a percentage of motor 2 rated voltage while the motor 2 is operating at the rated frequency and rated current.	Determined by o2-04 and C6-01 (0.0 - 40.0%)	703
E4-07 (0343)	Motor2 Saturation Coefficient 1	<input type="checkbox"/> V/f <input type="checkbox"/> CL-V/f <input type="checkbox"/> OLV <input type="checkbox"/> CLV <input type="checkbox"/> AOLV <input type="checkbox"/> OLV/PM <input type="checkbox"/> AOLV/PM <input type="checkbox"/> CLV/PM <input type="checkbox"/> EZOLV Sets the motor 2 iron-core saturation coefficient at 50% of the magnetic flux.	0.50 (0.00 - 0.50)	704
E4-08 (0344)	Motor 2 Saturation Coefficient 2	<input type="checkbox"/> V/f <input type="checkbox"/> CL-V/f <input type="checkbox"/> OLV <input type="checkbox"/> CLV <input type="checkbox"/> AOLV <input type="checkbox"/> OLV/PM <input type="checkbox"/> AOLV/PM <input type="checkbox"/> CLV/PM <input type="checkbox"/> EZOLV Sets the motor 2 iron-core saturation coefficient at 75% of the magnetic flux.	0.75 (E4-07 to 0.75)	704
E4-09 (033F)	Motor 2 Mechanical Loss	<input type="checkbox"/> V/f <input type="checkbox"/> CL-V/f <input type="checkbox"/> OLV <input type="checkbox"/> CLV <input type="checkbox"/> AOLV <input type="checkbox"/> OLV/PM <input type="checkbox"/> AOLV/PM <input type="checkbox"/> CLV/PM <input type="checkbox"/> EZOLV Configures the mechanical loss of motor 2. The motor rated power (kW) is 100%. Normally there is no need to change this setting.	0.0% (0.0 - 10.0%)	704
E4-10 (0340)	Motor 2 Iron Loss	<input type="checkbox"/> V/f <input type="checkbox"/> CL-V/f <input type="checkbox"/> OLV <input type="checkbox"/> CLV <input type="checkbox"/> AOLV <input type="checkbox"/> OLV/PM <input type="checkbox"/> AOLV/PM <input type="checkbox"/> CLV/PM <input type="checkbox"/> EZOLV Sets the motor iron loss for motor 2 in watts.	Determined by o2-04 and C6-01 (0 - 65535 W)	704
E4-11 (0327)	Motor 2 Rated Power	<input type="checkbox"/> V/f <input type="checkbox"/> CL-V/f <input type="checkbox"/> OLV <input type="checkbox"/> CLV <input type="checkbox"/> AOLV <input type="checkbox"/> OLV/PM <input type="checkbox"/> AOLV/PM <input type="checkbox"/> CLV/PM <input type="checkbox"/> EZOLV Sets the motor 2 rated power in 0.01 kW. (1 HP = 0.746 kW)	Determined by o2-04 and C6-01 (0.00 - 650.00 kW)	704

◆ E5: PM Motor Settings

No. (Hex.)	Name	Description	Default (Range)	Ref.
E5-01 (0329)	PM Motor Code Selection	<input type="checkbox"/> V/f <input type="checkbox"/> CL-V/f <input type="checkbox"/> OLV <input type="checkbox"/> CLV <input type="checkbox"/> AOLV <input checked="" type="checkbox"/> OLV/PM <input checked="" type="checkbox"/> AOLV/PM <input checked="" type="checkbox"/> CLV/PM <input type="checkbox"/> EZOLV When using Yaskawa motors, set the motor code for the PM motor being used. The drive automatically sets several parameters to appropriate values depending on the motor code.	Determined by A1-02, o2-04, and C6-01 (0000 - FFFF)	705
E5-02 (032A)	Motor Rated Capacity	<input type="checkbox"/> V/f <input type="checkbox"/> CL-V/f <input type="checkbox"/> OLV <input type="checkbox"/> CLV <input type="checkbox"/> AOLV <input checked="" type="checkbox"/> OLV/PM <input checked="" type="checkbox"/> AOLV/PM <input checked="" type="checkbox"/> CLV/PM <input type="checkbox"/> EZOLV Sets the rated power of PM motors.	Determined by E5-01 (0.10 - 650.00 kW)	705
E5-03 (032B)	PM Motor Rated Current (FLA)	<input type="checkbox"/> V/f <input type="checkbox"/> CL-V/f <input type="checkbox"/> OLV <input type="checkbox"/> CLV <input type="checkbox"/> AOLV <input checked="" type="checkbox"/> OLV/PM <input checked="" type="checkbox"/> AOLV/PM <input checked="" type="checkbox"/> CLV/PM <input type="checkbox"/> EZOLV Sets the motor rated current (FLA) for PM motors.	Determined by E5-01 (10 to 200% of the drive rated current)	218
E5-04 (032C)	PM Motor Pole Count	<input type="checkbox"/> V/f <input type="checkbox"/> CL-V/f <input type="checkbox"/> OLV <input type="checkbox"/> CLV <input type="checkbox"/> AOLV <input checked="" type="checkbox"/> OLV/PM <input checked="" type="checkbox"/> AOLV/PM <input checked="" type="checkbox"/> CLV/PM <input type="checkbox"/> EZOLV Sets the number of PM motor poles.	Determined by E5-01 (2 - 48)	706
E5-05 (032D)	PM Motor Resistance (ohms/phase)	<input type="checkbox"/> V/f <input type="checkbox"/> CL-V/f <input type="checkbox"/> OLV <input type="checkbox"/> CLV <input type="checkbox"/> AOLV <input checked="" type="checkbox"/> OLV/PM <input checked="" type="checkbox"/> AOLV/PM <input checked="" type="checkbox"/> CLV/PM <input type="checkbox"/> EZOLV Sets the resistance per phase of the PM motors. Do not enter the line-to-line resistance into E5-05 when measuring the resistance manually.	Determined by E5-01 (0.000 - 65.000 Ω)	706
E5-06 (032E)	PM d-axis Inductance (mH/phase)	<input type="checkbox"/> V/f <input type="checkbox"/> CL-V/f <input type="checkbox"/> OLV <input type="checkbox"/> CLV <input type="checkbox"/> AOLV <input checked="" type="checkbox"/> OLV/PM <input checked="" type="checkbox"/> AOLV/PM <input checked="" type="checkbox"/> CLV/PM <input type="checkbox"/> EZOLV Sets the PM motor d-Axis inductance.	Determined by E5-01 (0.00 - 300.00 mH)	706
E5-07 (032F)	PM q-axis Inductance (mH/phase)	<input type="checkbox"/> V/f <input type="checkbox"/> CL-V/f <input type="checkbox"/> OLV <input type="checkbox"/> CLV <input type="checkbox"/> AOLV <input checked="" type="checkbox"/> OLV/PM <input checked="" type="checkbox"/> AOLV/PM <input checked="" type="checkbox"/> CLV/PM <input type="checkbox"/> EZOLV Sets the PM motor q-Axis inductance.	Determined by E5-01 (0.00 - 600.00 mH)	706
E5-09 (0331)	PM Back-EMF V _{peak} (mV/(rad/s))	<input type="checkbox"/> V/f <input type="checkbox"/> CL-V/f <input type="checkbox"/> OLV <input type="checkbox"/> CLV <input type="checkbox"/> AOLV <input checked="" type="checkbox"/> OLV/PM <input checked="" type="checkbox"/> AOLV/PM <input checked="" type="checkbox"/> CLV/PM <input type="checkbox"/> EZOLV Sets the peak value of PM motor induced voltage in units of electrical angles.	Determined by E5-01 (0.0 - 2000.0 mV/(rad/s))	707
E5-11 (0333)	Encoder Z-Pulse Offset	<input type="checkbox"/> V/f <input type="checkbox"/> CL-V/f <input type="checkbox"/> OLV <input type="checkbox"/> CLV <input type="checkbox"/> AOLV <input type="checkbox"/> OLV/PM <input type="checkbox"/> AOLV/PM <input checked="" type="checkbox"/> CLV/PM <input type="checkbox"/> EZOLV Sets the encoder Z-pulse offset.	0.0 degrees (-180.0 - +180.0 degrees)	707
E5-24 (0353)	PM Back-EMF L-L Vrms (mV/rpm)	<input type="checkbox"/> V/f <input type="checkbox"/> CL-V/f <input type="checkbox"/> OLV <input type="checkbox"/> CLV <input type="checkbox"/> AOLV <input checked="" type="checkbox"/> OLV/PM <input checked="" type="checkbox"/> AOLV/PM <input checked="" type="checkbox"/> CLV/PM <input type="checkbox"/> EZOLV Sets the rms value for PM motor line voltage in units of mechanical angles.	Determined by E5-01 (0.0 - 6500.0 mV/min ⁻¹)	707
E5-25 (035E)	Polarity Estimation Reversal	<input type="checkbox"/> V/f <input type="checkbox"/> CL-V/f <input type="checkbox"/> OLV <input type="checkbox"/> CLV <input type="checkbox"/> AOLV <input checked="" type="checkbox"/> OLV/PM <input checked="" type="checkbox"/> AOLV/PM <input checked="" type="checkbox"/> CLV/PM <input type="checkbox"/> EZOLV Changes the polarity estimate used when estimating initial polarity. Normally there is no need to change this setting. 0 : Disabled 1 : Enabled	0 (0, 1)	707

◆ E9: Motor Setting

No. (Hex.)	Name	Description	Default (Range)	Ref.
E9-01 (11E4)	Motor Type Selection	<input type="checkbox"/> V/f <input type="checkbox"/> CL-V/f <input type="checkbox"/> OLV <input type="checkbox"/> CLV <input type="checkbox"/> AOLV <input type="checkbox"/> OLV/PM <input type="checkbox"/> AOLV/PM <input type="checkbox"/> CLV/PM <input checked="" type="checkbox"/> EZOLV Configures the motor type. 0 : IM 1 : PM 2 : SynRM	0 (0 to 2)	708
E9-02 (11E5)	Motor Max Revolutions	<input type="checkbox"/> V/f <input type="checkbox"/> CL-V/f <input type="checkbox"/> OLV <input type="checkbox"/> CLV <input type="checkbox"/> AOLV <input type="checkbox"/> OLV/PM <input type="checkbox"/> AOLV/PM <input type="checkbox"/> CLV/PM <input checked="" type="checkbox"/> EZOLV Configures the max revolutions of the motor.	Determined by E9-01 (40.0 - 120.0 Hz)	708
E9-03 (11E6)	Rated Speed	<input type="checkbox"/> V/f <input type="checkbox"/> CL-V/f <input type="checkbox"/> OLV <input type="checkbox"/> CLV <input type="checkbox"/> AOLV <input type="checkbox"/> OLV/PM <input type="checkbox"/> AOLV/PM <input type="checkbox"/> CLV/PM <input checked="" type="checkbox"/> EZOLV Configures the rated rotation speed of the motor.	Determined by E9-01 (100 - 7200 min ⁻¹)	708

10.8 E: Motor Parameters

No. (Hex.)	Name	Description	Default (Range)	Ref.
E9-04 (11E7)	Base Frequency	<input type="checkbox"/> V/f <input type="checkbox"/> CL-V/f <input type="checkbox"/> OLV <input type="checkbox"/> CLV <input type="checkbox"/> AOLV <input type="checkbox"/> OLV/PM <input type="checkbox"/> AOLV/PM <input type="checkbox"/> CLV/PM <input checked="" type="checkbox"/> EZOLV Configures the rated frequency of the motor.	Determined by E9-01 (40.0 - 120.0 Hz)	708
E9-05 (11E8)	Base Voltage	<input type="checkbox"/> V/f <input type="checkbox"/> CL-V/f <input type="checkbox"/> OLV <input type="checkbox"/> CLV <input type="checkbox"/> AOLV <input type="checkbox"/> OLV/PM <input type="checkbox"/> AOLV/PM <input type="checkbox"/> CLV/PM <input checked="" type="checkbox"/> EZOLV Configures the rated voltage of the motor.	Determined by E9-01 (200 V Class: 0.0 to 255.0 V, 400 V Class: 0.0 to 510.0 V)	709
E9-06 (11E9)	Motor Rated Current	<input type="checkbox"/> V/f <input type="checkbox"/> CL-V/f <input type="checkbox"/> OLV <input type="checkbox"/> CLV <input type="checkbox"/> AOLV <input type="checkbox"/> OLV/PM <input type="checkbox"/> AOLV/PM <input type="checkbox"/> CLV/PM <input checked="" type="checkbox"/> EZOLV Sets the motor rated current in amperes.	Determined by E9-01 and o2-04 (10% to 200% of the drive rated current)	219
E9-07 (11EA)	Motor Rated Power (kW)	<input type="checkbox"/> V/f <input type="checkbox"/> CL-V/f <input type="checkbox"/> OLV <input type="checkbox"/> CLV <input type="checkbox"/> AOLV <input type="checkbox"/> OLV/PM <input type="checkbox"/> AOLV/PM <input type="checkbox"/> CLV/PM <input checked="" type="checkbox"/> EZOLV Sets the motor rated power in 0.01 kW. (1 HP = 0.746 kW)	Determined by E9-02 and o2-04 (0.00 - 650.00 kW)	709
E9-08 (11EB)	Motor Pole Count	<input type="checkbox"/> V/f <input type="checkbox"/> CL-V/f <input type="checkbox"/> OLV <input type="checkbox"/> CLV <input type="checkbox"/> AOLV <input type="checkbox"/> OLV/PM <input type="checkbox"/> AOLV/PM <input type="checkbox"/> CLV/PM <input checked="" type="checkbox"/> EZOLV Sets the number of motor poles.	4 (2 to 48)	709
E9-09 (11EC)	Motor Rated Slip	<input type="checkbox"/> V/f <input type="checkbox"/> CL-V/f <input type="checkbox"/> OLV <input type="checkbox"/> CLV <input type="checkbox"/> AOLV <input type="checkbox"/> OLV/PM <input type="checkbox"/> AOLV/PM <input type="checkbox"/> CLV/PM <input checked="" type="checkbox"/> EZOLV Configures the motor rated slip.	0.0 Hz (0.0 - 20.0 Hz)	709
E9-10 (11ED)	Motor Line-to-Line Resistance	<input type="checkbox"/> V/f <input type="checkbox"/> CL-V/f <input type="checkbox"/> OLV <input type="checkbox"/> CLV <input type="checkbox"/> AOLV <input type="checkbox"/> OLV/PM <input type="checkbox"/> AOLV/PM <input type="checkbox"/> CLV/PM <input checked="" type="checkbox"/> EZOLV Sets the line-to-line resistance for motor stator windings.	Determined by o2-04 (0.000 - 65.000 Ω)	710

10.9 F: Options

◆ F1: PG Speed Control Card (Encoder)

No. (Hex.)	Name	Description	Default (Range)	Ref.
F1-01 (0380)	PG 1 Pulses Per Revolution	<input type="checkbox"/> V/f <input checked="" type="checkbox"/> CL-V/f <input type="checkbox"/> OLV <input checked="" type="checkbox"/> CLV <input type="checkbox"/> AOLV <input type="checkbox"/> OLV/PM <input type="checkbox"/> AOLV/PM <input type="checkbox"/> CLV/PM <input type="checkbox"/> EZOLV Sets the number of output pulses per revolution of the encoder.	600 ppr (1 - 60000 ppr)	712
F1-02 (0381)	PG Feedback Loss Selection	<input type="checkbox"/> V/f <input checked="" type="checkbox"/> CL-V/f <input type="checkbox"/> OLV <input checked="" type="checkbox"/> CLV <input type="checkbox"/> AOLV <input type="checkbox"/> OLV/PM <input type="checkbox"/> AOLV/PM <input type="checkbox"/> CLV/PM <input type="checkbox"/> EZOLV Selects the motor operation when <i>PGo</i> [PG Disconnect] is detected. 0 : Ramp to stop 1 : Coast to stop 2 : Fast Stop (use C1-09) 3 : Alarm only 4 : No alarm display	1 (0 - 4)	712
F1-03 (0382)	Operation Select at Overspeed	<input type="checkbox"/> V/f <input checked="" type="checkbox"/> CL-V/f <input type="checkbox"/> OLV <input checked="" type="checkbox"/> CLV <input type="checkbox"/> AOLV <input type="checkbox"/> OLV/PM <input type="checkbox"/> AOLV/PM <input type="checkbox"/> CLV/PM <input type="checkbox"/> EZOLV Selects the motor operation when <i>oS</i> [Overspeed] is detected. 0 : Ramp to stop 1 : Coast to stop 2 : Fast Stop (use C1-09) 3 : Alarm only 4 : No alarm display	1 (0 - 3)	712
F1-04 (0383)	Operation Selection at Deviation	<input type="checkbox"/> V/f <input checked="" type="checkbox"/> CL-V/f <input type="checkbox"/> OLV <input checked="" type="checkbox"/> CLV <input type="checkbox"/> AOLV <input type="checkbox"/> OLV/PM <input type="checkbox"/> AOLV/PM <input type="checkbox"/> CLV/PM <input type="checkbox"/> EZOLV Selects the motor operation when <i>dEv</i> [Speed Deviation] is detected. 0 : Ramp to stop 1 : Coast to stop 2 : Fast Stop (use C1-09) 3 : Alarm only	3 (0 - 3)	713
F1-05 (0384)	PG 1 Rotation Selection	<input type="checkbox"/> V/f <input checked="" type="checkbox"/> CL-V/f <input type="checkbox"/> OLV <input checked="" type="checkbox"/> CLV <input type="checkbox"/> AOLV <input type="checkbox"/> OLV/PM <input type="checkbox"/> AOLV/PM <input type="checkbox"/> CLV/PM <input type="checkbox"/> EZOLV Selects the output sequence for phases A and B of the pulses output from the encoder, given that the motor is running forward. 0 : Pulse A leads 1 : Pulse B leads	Determined by A1-02 (0, 1)	713
F1-06 (0385)	PG1 Division Rate for Pulse Mon	<input type="checkbox"/> V/f <input checked="" type="checkbox"/> CL-V/f <input type="checkbox"/> OLV <input checked="" type="checkbox"/> CLV <input type="checkbox"/> AOLV <input type="checkbox"/> OLV/PM <input type="checkbox"/> AOLV/PM <input type="checkbox"/> CLV/PM <input type="checkbox"/> EZOLV Sets the dividing ratio for monitor signals output from the encoder option card.	001 (001 - 032, 102 - 132 (1 - 1/32))	713
F1-08 (0387)	Overspeed Detection Level	<input type="checkbox"/> V/f <input checked="" type="checkbox"/> CL-V/f <input type="checkbox"/> OLV <input checked="" type="checkbox"/> CLV <input type="checkbox"/> AOLV <input type="checkbox"/> OLV/PM <input type="checkbox"/> AOLV/PM <input type="checkbox"/> CLV/PM <input type="checkbox"/> EZOLV Sets the detection level of <i>oS</i> [Overspeed] as a percentage when the maximum output frequency is 100%.	115% (0 - 120%)	714
F1-09 (0388)	Overspeed Detection Delay Time	<input type="checkbox"/> V/f <input checked="" type="checkbox"/> CL-V/f <input type="checkbox"/> OLV <input checked="" type="checkbox"/> CLV <input type="checkbox"/> AOLV <input type="checkbox"/> OLV/PM <input type="checkbox"/> AOLV/PM <input type="checkbox"/> CLV/PM <input type="checkbox"/> EZOLV Sets the detection time for <i>oS</i> [Overspeed].	Determined by A1-02 (0.0 - 2.0 s)	714
F1-10 (0389)	Speed Deviation Detection Level	<input type="checkbox"/> V/f <input checked="" type="checkbox"/> CL-V/f <input type="checkbox"/> OLV <input checked="" type="checkbox"/> CLV <input type="checkbox"/> AOLV <input type="checkbox"/> OLV/PM <input type="checkbox"/> AOLV/PM <input type="checkbox"/> CLV/PM <input type="checkbox"/> EZOLV Sets the detection level of <i>dEv</i> [Speed Deviation] as a percentage when the maximum output frequency is 100%.	10% (0 - 50%)	714
F1-11 (038A)	Speed Deviation Detect Delay Time	<input type="checkbox"/> V/f <input checked="" type="checkbox"/> CL-V/f <input type="checkbox"/> OLV <input checked="" type="checkbox"/> CLV <input type="checkbox"/> AOLV <input type="checkbox"/> OLV/PM <input type="checkbox"/> AOLV/PM <input type="checkbox"/> CLV/PM <input type="checkbox"/> EZOLV Sets the detection time for <i>dEv</i> [Speed Deviation].	0.5 s (0.0 - 10.0 s)	714
F1-12 (038B)	PG 1 Gear Teeth 1	<input type="checkbox"/> V/f <input checked="" type="checkbox"/> CL-V/f <input type="checkbox"/> OLV <input checked="" type="checkbox"/> CLV <input type="checkbox"/> AOLV <input type="checkbox"/> OLV/PM <input type="checkbox"/> AOLV/PM <input type="checkbox"/> CLV/PM <input type="checkbox"/> EZOLV Sets the number of gear teeth (gear ratio) between the motor and encoder, in combination with <i>F1-13</i> [PG 1 Gear Teeth 2]. <i>F1-12</i> is set with the number of gear teeth for the motor side.	0 (0 - 1000)	714
F1-13 (038C)	PG 1 Gear Teeth 2	<input type="checkbox"/> V/f <input checked="" type="checkbox"/> CL-V/f <input type="checkbox"/> OLV <input checked="" type="checkbox"/> CLV <input type="checkbox"/> AOLV <input type="checkbox"/> OLV/PM <input type="checkbox"/> AOLV/PM <input type="checkbox"/> CLV/PM <input type="checkbox"/> EZOLV Sets the number of gear teeth (gear ratio) between the motor and encoder, in combination with <i>F1-12</i> [PG 1 Gear Teeth 1]. Parameter <i>F1-13</i> is set with the number of gear teeth for the load side.	0 (0 - 1000)	715

10.9 F: Options

No. (Hex.)	Name	Description	Default (Range)	Ref.
F1-14 (038D)	PG Open-Circuit Detection Time	<p>V/f <input type="checkbox"/> CL-V/f <input type="checkbox"/> OLV <input type="checkbox"/> CLV <input type="checkbox"/> AOLV <input type="checkbox"/> OLV/PM <input type="checkbox"/> AOLV/PM <input checked="" type="checkbox"/> CLV/PM <input type="checkbox"/> EZOLV</p> <p>Sets the detection time for <i>PGo</i> [<i>PG Disconnect</i>].</p> <p>Note: Faults such as <i>ov</i> [<i>DB Bus Overvoltage</i>] and <i>oC</i> [<i>Overcurrent</i>] may occur depending on the motor speed and load conditions.</p>	2.0 s (0.0 - 10.0 s)	715
F1-18 (03AD)	Deviation 3 Detection Selection	<p>V/f <input type="checkbox"/> CL-V/f <input type="checkbox"/> OLV <input type="checkbox"/> CLV <input type="checkbox"/> AOLV <input type="checkbox"/> OLV/PM <input type="checkbox"/> AOLV/PM <input checked="" type="checkbox"/> CLV/PM <input type="checkbox"/> EZOLV</p> <p>Sets the number of rotations to detect scenarios in which the torque reference and rate of acceleration are inverted, which function as the detection conditions for <i>dv3</i> [<i>Inversion Detection</i>].</p>	10 (0 - 10)	715
F1-19 (03AE)	Deviation 4 Detection Selection	<p>V/f <input type="checkbox"/> CL-V/f <input type="checkbox"/> OLV <input type="checkbox"/> CLV <input type="checkbox"/> AOLV <input type="checkbox"/> OLV/PM <input type="checkbox"/> AOLV/PM <input checked="" type="checkbox"/> CLV/PM <input type="checkbox"/> EZOLV</p> <p>Sets the number of pulses used to detect <i>dv4</i> [<i>Inversion Prevention Detection</i>].</p>	128 (0 - 5000)	715
F1-20 (03B4)	PG Option PCB Disconnect Detect1	<p>V/f <input type="checkbox"/> CL-V/f <input type="checkbox"/> OLV <input type="checkbox"/> CLV <input type="checkbox"/> AOLV <input type="checkbox"/> OLV/PM <input type="checkbox"/> AOLV/PM <input checked="" type="checkbox"/> CLV/PM <input type="checkbox"/> EZOLV</p> <p>Selects whether to enable or disable the disconnection detection function for the encoder connection cable regarding the PG-X3 and PG-F3. Detects <i>PGoH</i> [<i>PG Hardware Fault</i>] when <i>F1-20</i> = 1.</p> <p>0 : Disabled 1 : Enabled</p>	1 (0, 1)	716
F1-21 (03BC)	PG 1 Signal Selection	<p>V/f <input type="checkbox"/> CL-V/f <input type="checkbox"/> OLV <input type="checkbox"/> CLV <input type="checkbox"/> AOLV <input type="checkbox"/> OLV/PM <input type="checkbox"/> AOLV/PM <input checked="" type="checkbox"/> CLV/PM <input type="checkbox"/> EZOLV</p> <p>Selects the type of pulse signal (channel) used for the encoder option card.</p> <p>0 : A pulse detection 1 : AB pulse detection</p>	0 (0, 1)	716
F1-30 (03AA)	Motor 2 PG Option Port Selection	<p>V/f <input type="checkbox"/> CL-V/f <input type="checkbox"/> OLV <input type="checkbox"/> CLV <input type="checkbox"/> AOLV <input type="checkbox"/> OLV/PM <input type="checkbox"/> AOLV/PM <input checked="" type="checkbox"/> CLV/PM <input type="checkbox"/> EZOLV</p> <p>Selects the connector used when the motor 2 encoder option card is mounted in the drive.</p> <p>0 : CN5-C 1 : CN5-B</p>	1 (0, 1)	716
F1-31 (03B0)	PG 2 Pulses Per Revolution	<p>V/f <input type="checkbox"/> CL-V/f <input type="checkbox"/> OLV <input type="checkbox"/> CLV <input type="checkbox"/> AOLV <input type="checkbox"/> OLV/PM <input type="checkbox"/> AOLV/PM <input checked="" type="checkbox"/> CLV/PM <input type="checkbox"/> EZOLV</p> <p>Sets the number of output pulses per revolution of the encoder. This parameter is for motor 2.</p>	600 ppr (1 - 60000 ppr)	716
F1-32 (03B1)	PG 2 Rotation Selection	<p>V/f <input type="checkbox"/> CL-V/f <input type="checkbox"/> OLV <input type="checkbox"/> CLV <input type="checkbox"/> AOLV <input type="checkbox"/> OLV/PM <input type="checkbox"/> AOLV/PM <input checked="" type="checkbox"/> CLV/PM <input type="checkbox"/> EZOLV</p> <p>Selects the output sequence for phases A and B of the pulses output from the encoder, given that the motor is running forward. This parameter is for motor 2.</p> <p>0 : Pulse A leads 1 : Pulse B leads</p>	0 (0, 1)	716
F1-33 (03B2)	PG 2 Gear Teeth 1	<p>V/f <input type="checkbox"/> CL-V/f <input type="checkbox"/> OLV <input type="checkbox"/> CLV <input type="checkbox"/> AOLV <input type="checkbox"/> OLV/PM <input type="checkbox"/> AOLV/PM <input checked="" type="checkbox"/> CLV/PM <input type="checkbox"/> EZOLV</p> <p>Set the number of gear teeth (gear ratio) between the motor and encoder, in combination with <i>F1-34</i> [<i>PG 2 Gear Teeth 2</i>]. <i>F1-33</i> is set with the number of gear teeth for the motor side. This parameter is for motor 2.</p>	0 (0 - 1000)	717
F1-34 (03B3)	PG 2 Gear Teeth 2	<p>V/f <input type="checkbox"/> CL-V/f <input type="checkbox"/> OLV <input type="checkbox"/> CLV <input type="checkbox"/> AOLV <input type="checkbox"/> OLV/PM <input type="checkbox"/> AOLV/PM <input checked="" type="checkbox"/> CLV/PM <input type="checkbox"/> EZOLV</p> <p>Sets the number of gear teeth (gear ratio) between the motor and encoder, in combination with <i>F1-33</i> [<i>PG 2 Gear Teeth 1</i>]. <i>F1-34</i> is set with the number of gear teeth for the load side. This parameter is for motor 2.</p>	0 (0 - 1000)	717
F1-35 (03BE)	PG2 Division Rate for Pulse Mon	<p>V/f <input type="checkbox"/> CL-V/f <input type="checkbox"/> OLV <input type="checkbox"/> CLV <input type="checkbox"/> AOLV <input type="checkbox"/> OLV/PM <input type="checkbox"/> AOLV/PM <input checked="" type="checkbox"/> CLV/PM <input type="checkbox"/> EZOLV</p> <p>Sets the dividing ratio for monitor signals output from the encoder option card. This parameter is for motor 2.</p>	001 (001 - 032, 102 - 132 (1 - 1/32))	717
F1-36 (03B5)	PG Option PCB Disconnect Detect2	<p>V/f <input type="checkbox"/> CL-V/f <input type="checkbox"/> OLV <input type="checkbox"/> CLV <input type="checkbox"/> AOLV <input type="checkbox"/> OLV/PM <input type="checkbox"/> AOLV/PM <input checked="" type="checkbox"/> CLV/PM <input type="checkbox"/> EZOLV</p> <p>Selects whether to enable or disable the disconnection detection function for the encoder connection cable regarding the PG-X3. <i>PGoH</i> [<i>PG Hardware Fault</i>] is detected when this parameter is enabled. This parameter is for motor 2.</p> <p>0 : Disabled 1 : Enabled</p>	1 (0, 1)	717

No. (Hex.)	Name	Description	Default (Range)	Ref.
F1-37 (03BD)	PG 2 Signal Selection	<p>V/f <input type="checkbox"/> CL-V/f <input type="checkbox"/> OLV <input type="checkbox"/> CLV <input type="checkbox"/> AOLV <input type="checkbox"/> OLV/PM <input type="checkbox"/> AOLV/PM <input type="checkbox"/> CLV/PM <input type="checkbox"/> EZOLV <input type="checkbox"/></p> <p>Selects the type of pulse signal (channel) used for the encoder option card. This parameter is for motor 2.</p> <p>0 : A pulse detection 1 : AB pulse detection</p>	0 (0, 1)	717
F1-50 (03D2)	Encoder Selection	<p>V/f <input type="checkbox"/> CL-V/f <input type="checkbox"/> OLV <input type="checkbox"/> CLV <input type="checkbox"/> AOLV <input type="checkbox"/> OLV/PM <input type="checkbox"/> AOLV/PM <input checked="" type="checkbox"/> CLV/PM <input type="checkbox"/> EZOLV <input type="checkbox"/></p> <p>Selects the encoder connected to PG-F3.</p> <p>0 : EnDat Sin/Cos 1 : EnDat Serial Only 2 : Hiperface</p>	0 (0 - 2)	718
F1-51 (03D3)	PGoH Detection Level	<p>V/f <input type="checkbox"/> CL-V/f <input type="checkbox"/> OLV <input type="checkbox"/> CLV <input type="checkbox"/> AOLV <input type="checkbox"/> OLV/PM <input type="checkbox"/> AOLV/PM <input checked="" type="checkbox"/> CLV/PM <input type="checkbox"/> EZOLV <input type="checkbox"/></p> <p>$\sqrt{\sin^2\theta + \cos^2\theta}$ Sets the detection level for PGoH [PG Hardware Fault] of PG-F3 as a percentage when XXX is 100%.</p> <p>Note: This function is enabled when $F1-20 = 1$ [PG Hardware Disconnection Detection Selection = Enabled].</p>	80% (1 - 100%)	718
F1-52 (03D4)	Serial Encoder Communication bps	<p>V/f <input type="checkbox"/> CL-V/f <input type="checkbox"/> OLV <input type="checkbox"/> CLV <input type="checkbox"/> AOLV <input type="checkbox"/> OLV/PM <input type="checkbox"/> AOLV/PM <input checked="" type="checkbox"/> CLV/PM <input type="checkbox"/> EZOLV <input type="checkbox"/></p> <p>Selects the speed of communication between the PG-F3 and serial encoder.</p> <p>0 : 1M/9600bps 1 : 500k/19200bps 2 : 1M/38400bps</p>	0 (0 - 2)	718

◆ F2: Analog Input Option

No. (Hex.)	Name	Description	Default (Range)	Ref.
F2-01 (038F)	Analog Input Function Selection	<p>V/f <input type="checkbox"/> CL-V/f <input type="checkbox"/> OLV <input type="checkbox"/> CLV <input type="checkbox"/> AOLV <input type="checkbox"/> OLV/PM <input type="checkbox"/> AOLV/PM <input type="checkbox"/> CLV/PM <input type="checkbox"/> EZOLV <input type="checkbox"/></p> <p>Selects the input method for the analog reference used with AI-A3.</p> <p>0 : 3 channel individual 1 : 3 channel addition</p>	0 (0, 1)	718
F2-02 (0368) RUN	Analog Input Option Card Gain	<p>V/f <input type="checkbox"/> CL-V/f <input type="checkbox"/> OLV <input type="checkbox"/> CLV <input type="checkbox"/> AOLV <input type="checkbox"/> OLV/PM <input type="checkbox"/> AOLV/PM <input type="checkbox"/> CLV/PM <input type="checkbox"/> EZOLV <input type="checkbox"/></p> <p>Sets the analog reference gain as a percentage when the maximum output frequency is 100%.</p> <p>Note: This parameter is only enabled when $F2-01 = 1$ [Analog Input Function Selection = 3 channel addition].</p>	100.0% (-999.9 - +999.9%)	720
F2-03 (0369) RUN	Analog Input Option Card Bias	<p>V/f <input type="checkbox"/> CL-V/f <input type="checkbox"/> OLV <input type="checkbox"/> CLV <input type="checkbox"/> AOLV <input type="checkbox"/> OLV/PM <input type="checkbox"/> AOLV/PM <input type="checkbox"/> CLV/PM <input type="checkbox"/> EZOLV <input type="checkbox"/></p> <p>Sets the analog reference bias as a percentage when the maximum output frequency is 100%.</p> <p>Note: This parameter is only enabled when $F2-01 = 1$ [Analog Input Function Selection = 3 channel addition].</p>	0.0% (-999.9 - +999.9%)	720

◆ F3: Digital Input Option

No. (Hex.)	Name	Description	Default (Range)	Ref.
F3-01 (0390)	Digital Input Function Selection	<p>V/f CL-V/f OLV CLV AOLV OLV/PM AOLV/PM CLV/PM EZOLV</p> <p>Selects the data format of digital input signals. This parameter is enabled when $o1-03 = 0$ or 1 [Keypad Display Selection = 0.01 Hz or 0.01% (100% = E1-04)].</p> <p>Note: The DI-A3 input method is set to the BCD input method regardless of the setting of F3-01 when $o1-03 = 2$ or 3 [r/min or User-selected units]. In this scenario, the value set in $o1-03$ is used as the setting unit.</p> <p>0 : BCD, 1% units 1 : BCD, 0.1% units 2 : BCD, 0.01% units 3 : BCD, 1 Hz units 4 : BCD, 0.1 Hz units 5 : BCD, 0.01 Hz units 6 : BCD (5-digit), 0.01 Hz 7 : Binary input 8 : Multi-function Digital input</p>	0 (0 - 8)	721
F3-03 (03B9)	DI Data Length Selection	<p>V/f CL-V/f OLV CLV AOLV OLV/PM AOLV/PM CLV/PM EZOLV</p> <p>Selects the number of bits used to set the frequency reference with DI-A3.</p> <p>0 : 8bit 1 : 12bit 2 : 16bit</p>	2 (0 to 2)	721
F3-10 (0BE3)	Terminal D0 Function Selection	<p>V/f CL-V/f OLV CLV AOLV OLV/PM AOLV/PM CLV/PM EZOLV</p> <p>Selects the function for terminal D0 of the DI-A3 when $F3-01 = 8$ [Digital Input Function Selection = Multi-function Digital input].</p>	F (1 - 19F)	722
F3-11 (0BE4)	Terminal D1 Function Selection	<p>V/f CL-V/f OLV CLV AOLV OLV/PM AOLV/PM CLV/PM EZOLV</p> <p>Selects the function for terminal D1 of the DI-A3 when $F3-01 = 8$ [Digital Input Function Selection = Multi-function Digital input].</p>	F (1 - 19F)	723
F3-12 (0BE5)	Terminal D2 Function Selection	<p>V/f CL-V/f OLV CLV AOLV OLV/PM AOLV/PM CLV/PM EZOLV</p> <p>Selects the function for terminal D2 of the DI-A3 when $F3-01 = 8$ [Digital Input Function Selection = Multi-function Digital input].</p>	F (1 - 19F)	723
F3-13 (0BE6)	Terminal D3 Function Selection	<p>V/f CL-V/f OLV CLV AOLV OLV/PM AOLV/PM CLV/PM EZOLV</p> <p>Selects the function for terminal D3 of the DI-A3 when $F3-01 = 8$ [Digital Input Function Selection = Multi-function Digital input].</p>	F (1 - 19F)	723
F3-14 (0BE7)	Terminal D4 Function Selection	<p>V/f CL-V/f OLV CLV AOLV OLV/PM AOLV/PM CLV/PM EZOLV</p> <p>Selects the function for terminal D4 of the DI-A3 when $F3-01 = 8$ [Digital Input Function Selection = Multi-function Digital input].</p>	F (1 - 19F)	723
F3-15 (0BE8)	Terminal D5 Function Selection	<p>V/f CL-V/f OLV CLV AOLV OLV/PM AOLV/PM CLV/PM EZOLV</p> <p>Selects the function for terminal D5 of the DI-A3 when $F3-01 = 8$ [Digital Input Function Selection = Multi-function Digital input].</p>	F (1 - 19F)	723
F3-16 (0BE9)	Terminal D6 Function Selection	<p>V/f CL-V/f OLV CLV AOLV OLV/PM AOLV/PM CLV/PM EZOLV</p> <p>Selects the function for terminal D6 of the DI-A3 when $F3-01 = 8$ [Digital Input Function Selection = Multi-function Digital input].</p>	F (1 - 19F)	723
F3-17 (0BEA)	Terminal D7 Function Selection	<p>V/f CL-V/f OLV CLV AOLV OLV/PM AOLV/PM CLV/PM EZOLV</p> <p>Selects the function for terminal D7 of the DI-A3 when $F3-01 = 8$ [Digital Input Function Selection = Multi-function Digital input].</p>	F (1 - 19F)	723
F3-18 (0BEB)	Terminal D8 Function Selection	<p>V/f CL-V/f OLV CLV AOLV OLV/PM AOLV/PM CLV/PM EZOLV</p> <p>Selects the function for terminal D8 of the DI-A3 when $F3-01 = 8$ [Digital Input Function Selection = Multi-function Digital input].</p>	F (1 - 19F)	723
F3-19 (0BEC)	Terminal D9 Function Selection	<p>V/f CL-V/f OLV CLV AOLV OLV/PM AOLV/PM CLV/PM EZOLV</p> <p>Selects the function for terminal D9 of the DI-A3 when $F3-01 = 8$ [Digital Input Function Selection = Multi-function Digital input].</p>	F (1 - 19F)	724
F3-20 (0BED)	Terminal DA Function Selection	<p>V/f CL-V/f OLV CLV AOLV OLV/PM AOLV/PM CLV/PM EZOLV</p> <p>Selects the function for terminal DA of the DI-A3 when $F3-01 = 8$ [Digital Input Function Selection = Multi-function Digital input].</p>	F (1 - 19F)	724

No. (Hex.)	Name	Description	Default (Range)	Ref.
F3-21 (0BEE)	Terminal DB Function Selection	V/f CL-V/f OLV CLV AOLV OLV/PM AOLV/PM CLV/PM EZOLV Selects the function for terminal DB of the DI-A3 when $F3-01 = 8$ [Digital Input Function Selection = Multi-function Digital input].	F (1 - 19F)	724
F3-22 (0BEF)	Terminal DC Function Selection	V/f CL-V/f OLV CLV AOLV OLV/PM AOLV/PM CLV/PM EZOLV Selects the function for terminal DC of the DI-A3 by when $F3-01 = 8$ [Digital Input Function Selection = Multi-function Digital input].	F (1 - 19F)	724
F3-23 (0BF0)	Terminal DD Function Selection	V/f CL-V/f OLV CLV AOLV OLV/PM AOLV/PM CLV/PM EZOLV Selects the function for terminal DD of the DI-A3 when $F3-01 = 8$ [Digital Input Function Selection = Multi-function Digital input].	F (1 - 19F)	724
F3-24 (0BF1)	Terminal DE Function Selection	V/f CL-V/f OLV CLV AOLV OLV/PM AOLV/PM CLV/PM EZOLV Selects the function for terminal DE of the DI-A3 when $F3-01 = 8$ [Digital Input Function Selection = Multi-function Digital input].	F (1 - 19F)	724
F3-25 (0BF2)	Terminal DF Function Selection	V/f CL-V/f OLV CLV AOLV OLV/PM AOLV/PM CLV/PM EZOLV Selects the function for terminal DF of the DI-A3 when $F3-01 = 8$ [Digital Input Function Selection = Multi-function Digital input].	F (1 - 19F)	724

◆ F4: Analog Monitor Option

No. (Hex.)	Name	Description	Default (Range)	Ref.
F4-01 (0391)	Terminal V1 Monitor Selection	V/f CL-V/f OLV CLV AOLV OLV/PM AOLV/PM CLV/PM EZOLV Sets the number for monitor item of output from terminal V1.	102 (000 - 999)	725
F4-02 (0392) RUN	Terminal V1 Monitor Gain	V/f CL-V/f OLV CLV AOLV OLV/PM AOLV/PM CLV/PM EZOLV Sets the gain of monitor signal output from terminal V1 as a percentage. Sets the voltage level output from terminal V1 to a 100% value of 10 V when a monitoring item is at 100% while an output of 0% for monitoring items is 0 V.	100.0% (-999.9 - +999.9%)	725
F4-03 (0393)	Terminal V2 Monitor Selection	V/f CL-V/f OLV CLV AOLV OLV/PM AOLV/PM CLV/PM EZOLV Sets the number for monitor item of output from terminal V2.	103 (000 - 999)	726
F4-04 (0394) RUN	Terminal V2 Monitor Gain	V/f CL-V/f OLV CLV AOLV OLV/PM AOLV/PM CLV/PM EZOLV Sets the gain of monitor signal output from terminal V2 as a percentage. Sets the voltage level output from terminal V2 to a 100% value of 10 V when a monitoring item is at 100% while an output of 0% for monitoring items is 0 V.	50.0% (-999.9 - +999.9%)	726
F4-05 (0395) RUN	Terminal V1 Monitor Bias	V/f CL-V/f OLV CLV AOLV OLV/PM AOLV/PM CLV/PM EZOLV Sets the bias of monitor signal output from terminal V1 as a percentage. Sets the voltage level output from terminal V1 to a 100% value of 10 V when the output for monitoring items is 0%.	0.0% (-999.9 - +999.9%)	726
F4-06 (0396) RUN	Terminal V2 Monitor Bias	V/f CL-V/f OLV CLV AOLV OLV/PM AOLV/PM CLV/PM EZOLV Sets the bias of monitor signal output from terminal V2 as a percentage. Sets the voltage level output from terminal V2 to a 100% value of 10 V when the output for monitoring items is 0%.	0.0% (-999.9 - +999.9%)	726
F4-07 (0397)	Terminal V1 Signal Level	V/f CL-V/f OLV CLV AOLV OLV/PM AOLV/PM CLV/PM EZOLV Selects the level of signals output from the MFAO terminal V1. 0 : 0 to 10 V 1 : -10 to 10 V	0 (0, 1)	727
F4-08 (0398)	Terminal V2 Signal Level	V/f CL-V/f OLV CLV AOLV OLV/PM AOLV/PM CLV/PM EZOLV Selects the level of signals output from the MFAO terminal V2. 0 : 0 to 10 V 1 : -10 to 10 V	0 (0, 1)	727

◆ F5: Digital Output Option

No. (Hex.)	Name	Description	Default (Range)	Ref.
F5-01 (0399)	Terminal P1-PC Output Selection	<p>V/f CL-V/f OLV CLV AOLV OLV/PM AOLV/PM CLV/PM EZOLV</p> <p>The function output from terminal P1-PC on the DO-A3 card is selected by the MFDO setting value. This parameter is enabled when $F5-09 = 2$ [DO-A3 Output Mode Selection = 8 channel select (F5-01 to F5-08)].</p>	0 (0 - 1A7)	729
F5-02 (039A)	Terminal P2-PC Output Selection	<p>V/f CL-V/f OLV CLV AOLV OLV/PM AOLV/PM CLV/PM EZOLV</p> <p>The function output from terminal P2-PC on the DO-A3 card is selected by the MFDO setting value. This parameter is enabled when $F5-09 = 2$ [DO-A3 Output Mode Selection = 8 channel select (F5-01 to F5-08)].</p>	1 (0 - 1A7)	729
F5-03 (039B)	Terminal P3-PC Output Selection	<p>V/f CL-V/f OLV CLV AOLV OLV/PM AOLV/PM CLV/PM EZOLV</p> <p>The function output from terminal P3-PC on the DO-A3 card is selected by the MFDO setting value. This parameter is enabled when $F5-09 = 2$ [DO-A3 Output Mode Selection = 8 channel select (F5-01 to F5-08)].</p>	2 (0 - 1A7)	729
F5-04 (039C)	Terminal P4-PC Output Selection	<p>V/f CL-V/f OLV CLV AOLV OLV/PM AOLV/PM CLV/PM EZOLV</p> <p>The function output from terminal P4-PC on the DO-A3 card is selected by the MFDO setting value. This parameter is enabled when $F5-09 = 2$ [DO-A3 Output Mode Selection = 8 channel select (F5-01 to F5-08)].</p>	4 (0 - 1A7)	729
F5-05 (039D)	Terminal P5-PC Output Selection	<p>V/f CL-V/f OLV CLV AOLV OLV/PM AOLV/PM CLV/PM EZOLV</p> <p>The function output from terminal P5-PC on the DO-A3 card is selected by the MFDO setting value. This parameter is enabled when $F5-09 = 2$ [DO-A3 Output Mode Selection = 8 channel select (F5-01 to F5-08)].</p>	6 (0 - 1A7)	730
F5-06 (039E)	Terminal P6-PC Output Selection	<p>V/f CL-V/f OLV CLV AOLV OLV/PM AOLV/PM CLV/PM EZOLV</p> <p>The function output from terminal P6-PC on the DO-A3 card is selected by the MFDO setting value. This parameter is enabled when $F5-09 = 2$ [DO-A3 Output Mode Selection = 8 channel select (F5-01 to F5-08)].</p>	37 (0 - 1A7)	730
F5-07 (039F)	Terminal M1-M2 Output Selection	<p>V/f CL-V/f OLV CLV AOLV OLV/PM AOLV/PM CLV/PM EZOLV</p> <p>Selects the function output from terminal M3-M2 on the DO-A3 card by the setting value for the multi-function digital output. This parameter is enabled when $F5-09 = 2$ [DO-A3 Output Mode Selection = 8 channel select(F5-01 to F5-08)].</p>	F (0 - 1A7)	730
F5-08 (03A0)	Terminal M3-M4 Output Selection	<p>V/f CL-V/f OLV CLV AOLV OLV/PM AOLV/PM CLV/PM EZOLV</p> <p>Selects the function output from terminal M3-M4 on the DO-A3 card by the setting value for the multi-function digital output. This parameter is enabled when $F5-09 = 2$ [DO-A3 Output Mode Selection = 8 channel select(F5-01 to F5-08)].</p>	F (0 - 1A7)	730
F5-09 (03A1)	DO-A3 Output Mode Selection	<p>V/f CL-V/f OLV CLV AOLV OLV/PM AOLV/PM CLV/PM EZOLV</p> <p>Selects the output mode of signals output from the DO-A3 card.</p> <p>0 : 8 channel individual 1 : Binary code output 2 : 8 channel select(F5-01 to F5-08)</p>	0 (0 - 2)	730

◆ F6: Communication Option and Ethernet Option

No. (Hex.)	Name	Description	Default (Range)	Ref.
F6-01 (03A2)	Communication Error Selection	<p>V/f CL-V/f OLV CLV AOLV OLV/PM AOLV/PM CLV/PM EZOLV</p> <p>Selects the operation of the drive when <i>bUS [Option Communication Error]</i> is detected.</p> <p>0 : Ramp to stop 1 : Coast to stop 2 : Fast Stop (use C1-09) 3 : Alarm only 4 : Alarm - run at <i>d1-04</i> 5 : Alarm - Ramp Stop</p>	1 (0 - 5)	732
F6-02 (03A3)	Comm External Fault (EF0) Detect	<p>V/f CL-V/f OLV CLV AOLV OLV/PM AOLV/PM CLV/PM EZOLV</p> <p>Selects the conditions at which <i>EF0 [Option Card External Fault]</i> is detected.</p> <p>0 : Always detected 1 : Detection during run only</p>	0 (0, 1)	732
F6-03 (03A4)	Comm External Fault (EF0) Select	<p>V/f CL-V/f OLV CLV AOLV OLV/PM AOLV/PM CLV/PM EZOLV</p> <p>Selects the operation of the drive when <i>EF0 [Option Card External Fault]</i> is detected.</p> <p>0 : Ramp to stop 1 : Coast to stop 2 : Fast Stop (use C1-09) 3 : Alarm only</p>	1 (0 - 3)	732
F6-04 (03A5)	bUS Error Detection Time	<p>V/f CL-V/f OLV CLV AOLV OLV/PM AOLV/PM CLV/PM EZOLV</p> <p>Sets the delay time until <i>bUS [Option Communication Error]</i> issues are detected.</p> <p>Note: The setting value changes to 0.0 s when the option card is mounted in the drive.</p>	2.0 s (0.0 - 5.0 s)	733
F6-06 (03A7)	Torque Reference/Limit by Comm	<p>V/f CL-V/f OLV CLV AOLV OLV/PM AOLV/PM CLV/PM EZOLV</p> <p>Selects whether to enable or disable the torque reference and torque limit received from the communication option card.</p> <p>0 : Disabled 1 : Enabled</p>	0 (0, 1)	733
F6-07 (03A8)	MultiStep Ref Priority Select	<p>V/f CL-V/f OLV CLV AOLV OLV/PM AOLV/PM CLV/PM EZOLV</p> <p>Selects whether to enable/disable the multi-step speed reference when NetRef (communication option card) or ComRef (MEMOBUS/Modbus communications) is selected as the frequency reference source.</p> <p>0 : MultiStep References Disabled 1 : MultiStep References Enabled</p>	0 (0, 1)	733
F6-08 (036A)	Comm Parameter Reset @Initialize	<p>V/f CL-V/f OLV CLV AOLV OLV/PM AOLV/PM CLV/PM EZOLV</p> <p>Selects whether or not to initialize <i>communication parameters [F6-xx and F7-xx]</i> when the drive is initialized by <i>A1-03 [Initialize Parameters]</i>.</p> <p>0 : No Reset - parameters retained 1 : Reset - back to factory default</p>	0 (0, 1)	733
F6-10 (03B6)	CC-Link Node Address	<p>V/f CL-V/f OLV CLV AOLV OLV/PM AOLV/PM CLV/PM EZOLV</p> <p>Sets the node address for CC-Link communication. The drive must be restarted when the setting is changed.</p> <p>Note: Set a node address that does overlap with other nodes. Do not set this parameter to a value of 0. If the parameter is set incorrectly, the L.ERR LED on the option is lit, and the drive will detect the <i>AEr [Node Address Setting Error]</i> error.</p>	0 (0 - 64)	733

No. (Hex.)	Name	Description	Default (Range)	Ref.
F6-11 (03B7)	CC-Link Communication Speed	<p>V/f CL-V/f OLV CLV AOLV OLV/PM AOLV/PM CLV/PM EZOLV</p> <p>Selects the communication speed for CC-Link communication. The drive must be restarted when the setting is changed.</p> <p>0 : 156 kbps 1 : 625 kbps 2 : 2.5 Mbps 3 : 5 Mbps 4 : 10 Mbps</p>	0 (0 - 4)	734
F6-14 (03BB)	CC-Link bUS Error Auto Reset	<p>V/f CL-V/f OLV CLV AOLV OLV/PM AOLV/PM CLV/PM EZOLV</p> <p>Selects whether to enable or disable the automatic reset of <i>bUS</i> [Option Communication Error] issues.</p> <p>0 : Disabled 1 : Enabled</p>	0 (0, 1)	734
F6-16 (0B8A)	Gateway Mode	<p>V/f CL-V/f OLV CLV AOLV OLV/PM AOLV/PM CLV/PM EZOLV</p> <p>Sets the operation mode of the gateway mode and the number of connected slave drives.</p> <p>0 : Uses the drive as a slave drive or disables the gateway function. 1 : Uses the drive as a master drive (slave drives: 1). 2 : Uses the drive as a master drive (slave drives: 2). 3 : Uses the drive as a master drive (slave drives: 3). 4 : Uses the drive as a master drive (slave drives: 4).</p>	0 (0 to 4)	435
F6-20 (036B)	MECHATROLINK Station Address	<p>V/f CL-V/f OLV CLV AOLV OLV/PM AOLV/PM CLV/PM EZOLV</p> <p>Sets the station address for MECHATROLINK communication. The drive must be restarted when the setting is changed.</p> <p>Note:</p> <ul style="list-style-type: none"> The setting range varies depending on the type of MECHATROLINK communication. <ul style="list-style-type: none"> –MECHATROLINK-II (SI-T3): 20 - 3F –MECHATROLINK-III (SI-ET3): 03 - EF Set an address that does overlap with other nodes. If the parameter is set incorrectly, the ERR on the option card flashes, and the drive will detect the <i>AEr</i> [Node Address Setting Error] error. <i>AEr</i> issues are detected when the station address is set to either 20 or 3F. 	0021h (MECHATRO LINK-II : 0020h - 003Fh , MECHATRO LINK-III : 0003h - 00EFh)	738
F6-21 (036C)	MECHATROLINK Frame Size	<p>V/f CL-V/f OLV CLV AOLV OLV/PM AOLV/PM CLV/PM EZOLV</p> <p>Sets the frame size for MECHATROLINK communication. The drive must be restarted when the setting is changed.</p> <p>0 : 32-byte 1 : 17-byte</p>	0 (0, 1)	738
F6-22 (036D)	MECHATROLINK Link Speed	<p>V/f CL-V/f OLV CLV AOLV OLV/PM AOLV/PM CLV/PM EZOLV</p> <p>Sets the communications speed for MECHATROLINK-II. The drive must be restarted when the setting is changed.</p> <p>Note:</p> <p>This parameter can only be used when the MECHATROLINK-II option is connected.</p> <p>0 : 10 Mbps 1 : 4 Mbps</p>	0 (0, 1)	738
F6-23 (036E)	MECHATROLINK Monitor Select (E)	<p>V/f CL-V/f OLV CLV AOLV OLV/PM AOLV/PM CLV/PM EZOLV</p> <p>Sets the MEMOBUS register used for the monitor functions of INV_CTL (drive operation control command) and INV_I/O (drive I/O control command). The drive must be restarted when the setting is changed.</p>	0000h (0000h - FFFFh)	739
F6-24 (036F)	MECHATROLINK Monitor Select (F)	<p>V/f CL-V/f OLV CLV AOLV OLV/PM AOLV/PM CLV/PM EZOLV</p> <p>Sets the MEMOBUS register used for the monitor functions of INV_CTL (drive operation control command) and INV_I/O (drive I/O control command). The drive must be restarted when the setting is changed.</p>	0000h (0000h - FFFFh)	739

No. (Hex.)	Name	Description	Default (Range)	Ref.
F6-25 (03C9)	MECHATROLINK Watchdog Error Sel	<p>V/f CL-V/f OLV CLV AOLV OLV/PM AOLV/PM CLV/PM EZOLV</p> <p>Selects the motor operation when <i>E5 [MECHATROLINK Watchdog Timer Err]</i> is detected.</p> <p>0 : Ramp to stop 1 : Coast to stop 2 : Fast stop (use C1-09) 3 : Alarm Only</p>	1 (0 - 3)	739
F6-26 (03CA)	MECHATROLINK bUS Errors Detected	<p>V/f CL-V/f OLV CLV AOLV OLV/PM AOLV/PM CLV/PM EZOLV</p> <p><i>bUS [Option Communication Error]</i> is detected when the option card detects the <i>bUS</i> alarm for a number of times that exceeds the number set in <i>F6-26</i>.</p>	2 times (2 to 10 times)	739
F6-30 (03CB)	PROFIBUS-DP Node Address	<p>V/f CL-V/f OLV CLV AOLV OLV/PM AOLV/PM CLV/PM EZOLV</p> <p>Sets the node address for PROFIBUS-DP communication. The drive must be restarted when the setting is changed.</p>	0 (0 - 125)	739
F6-31 (03CC)	PROFIBUS-DP Clear Mode selection	<p>V/f CL-V/f OLV CLV AOLV OLV/PM AOLV/PM CLV/PM EZOLV</p> <p>Selects the operation of the drive after the Clear mode command is received.</p> <p>0 : Reset 1 : Hold previous state</p>	0 (0, 1)	740
F6-32 (03CD)	PROFIBUS-DP Data Format Select	<p>V/f CL-V/f OLV CLV AOLV OLV/PM AOLV/PM CLV/PM EZOLV</p> <p>Selects the data format of PROFIBUS-DP communication. The drive must be restarted when the setting is changed.</p> <p>0 : PPO Type 1 : Conventional 2 : PPO (bit0) 3 : PPO (Enter) 4 : Conv (Enter) 5 : PPO (bit0,Enter)</p>	0 (0 - 5)	740
F6-35 (03D0)	CANopen Node ID Selection	<p>V/f CL-V/f OLV CLV AOLV OLV/PM AOLV/PM CLV/PM EZOLV</p> <p>Sets the node address for CANopen communication. The drive must be restarted when the setting is changed.</p> <p>Note: Select an address that does not overlap with other nodes. Do not set this parameter to a value of 0. If the parameter is set incorrectly, the ERR on the option card flashes, and the drive will detect the <i>AER [Node Address Setting Error]</i> error.</p>	0 (0 - 126)	740
F6-36 (03D1)	CANopen Communication Speed	<p>V/f CL-V/f OLV CLV AOLV OLV/PM AOLV/PM CLV/PM EZOLV</p> <p>Selects the communications speed for CANopen communication. The drive must be restarted when the setting is changed.</p> <p>0 : Auto-detection 1 : 10 kbps 2 : 20 kbps 3 : 50 kbps 4 : 125 kbps 5 : 250 kbps 6 : 500 kbps 7 : 800 kbps 8 : 1 Mbps</p>	6 (0 - 8)	740
F6-45 (02FB)	BACnet Node Address	<p>V/f CL-V/f OLV CLV AOLV OLV/PM AOLV/PM CLV/PM EZOLV</p> <p>Sets the node address for BACnet communication.</p>	1 (0 - 127)	741

No. (Hex.)	Name	Description	Default (Range)	Ref.
F6-46 (02FC)	BACnet Baud Rate	V/f CL-V/f OLV CLV AOLV OLV/PM AOLV/PM CLV/PM EZOLV Sets the BACnet communications speed. 0 : 1200 bps 1 : 2400 bps 2 : 4800 bps 3 : 9600 bps 4 : 19.2 kbps 5 : 38.4 kbps 6 : 57.6 kbps 7 : 76.8 kbps 8 : 115.2 kbps	3 (0 - 8)	741
F6-47 (02FD)	Rx to Tx Wait Time	V/f CL-V/f OLV CLV AOLV OLV/PM AOLV/PM CLV/PM EZOLV Sets the wait time for reception and transmission of BACnet communication.	5 ms (5 - 65 ms)	741
F6-48 (02FE)	BACnet Device Object Identifier0	V/f CL-V/f OLV CLV AOLV OLV/PM AOLV/PM CLV/PM EZOLV Sets the last word of addresses for BACnet communication.	0 (0 - FFFF)	741
F6-49 (02FF)	BACnet Device Object Identifier1	V/f CL-V/f OLV CLV AOLV OLV/PM AOLV/PM CLV/PM EZOLV Sets the last word of addresses for BACnet communication.	0 (0 - 3F)	741
F6-50 (03C1)	DN MAC Address	V/f CL-V/f OLV CLV AOLV OLV/PM AOLV/PM CLV/PM EZOLV Sets the MAC address for DeviceNet communication. The drive must be restarted when the setting is changed. Note: Select a MAC address that does not overlap with other nodes. Do not set this parameter to a value of 0. If the parameter is set incorrectly, the ERR on the option card flashes, and the drive will detect the <i>AEr [Node Address Setting Error]</i> error.	0 (0 - 64)	742
F6-51 (03C2)	DN Baud Rate	V/f CL-V/f OLV CLV AOLV OLV/PM AOLV/PM CLV/PM EZOLV Selects the communications speed for DeviceNet communication. The drive must be restarted when the setting is changed. 0 : 125 kbps 1 : 250 kbps 2 : 500 kbps 3 : Adjustable from network 4 : Detect automatically	0 (0 - 4)	742
F6-52 (03C3)	DeviceNet PCA Setting	V/f CL-V/f OLV CLV AOLV OLV/PM AOLV/PM CLV/PM EZOLV Sets the format of data sent from the DeviceNet communication master to the drive.	21 (0 - 255)	742
F6-53 (03C4)	DeviceNet PPA Setting	V/f CL-V/f OLV CLV AOLV OLV/PM AOLV/PM CLV/PM EZOLV Sets the format of data sent from the drive to the DeviceNet communication master.	71 (0 - 255)	742
F6-54 (03C5)	DN Idle Flt Det	V/f CL-V/f OLV CLV AOLV OLV/PM AOLV/PM CLV/PM EZOLV Selects whether or not to detect issues of <i>EF0 [Option Card External Fault]</i> when data is not received from the DeviceNet master. 0 : Enabled 1 : Disabled, no fault detection	0 (0 - 4)	742
F6-55 (03C6)	DN BAUD RATE MEM	V/f CL-V/f OLV CLV AOLV OLV/PM AOLV/PM CLV/PM EZOLV This parameter is used to enable confirmation of the currently valid communications speed for DeviceNet communication via the keypad. This parameter is used for monitoring only. 0 : 125 kbps 1 : 250 kbps 2 : 500 kbps	0 (0 - 2)	743
F6-56 (03D7)	DeviceNet Speed Scaling	V/f CL-V/f OLV CLV AOLV OLV/PM AOLV/PM CLV/PM EZOLV Sets the speed scale for DeviceNet communication.	0 (-15 - +15)	743
F6-57 (03D8)	DeviceNet Current Scaling	V/f CL-V/f OLV CLV AOLV OLV/PM AOLV/PM CLV/PM EZOLV Sets the current scale of the DeviceNet communication master.	0 (-15 - +15)	743

No. (Hex.)	Name	Description	Default (Range)	Ref.
F6-58 (03D9)	DeviceNet Torque Scaling	V/f CL-V/f OLV CLV AOLV OLV/PM AOLV/PM CLV/PM EZOLV Sets the torque scale of the DeviceNet communication master.	0 (-15 - +15)	743
F6-59 (03DA)	DeviceNet Power Scaling	V/f CL-V/f OLV CLV AOLV OLV/PM AOLV/PM CLV/PM EZOLV Sets the power scale of the DeviceNet communication master.	0 (-15 - +15)	743
F6-60 (03DB)	DeviceNet Voltage Scaling	V/f CL-V/f OLV CLV AOLV OLV/PM AOLV/PM CLV/PM EZOLV Sets the voltage scale of the DeviceNet communication master.	0 (-15 - +15)	743
F6-61 (03DC)	DeviceNet Time Scaling	V/f CL-V/f OLV CLV AOLV OLV/PM AOLV/PM CLV/PM EZOLV Sets the time scale of the DeviceNet communication master.	0 (-15 - +15)	743
F6-62 (03DD)	DeviceNet Heartbeat Interval	V/f CL-V/f OLV CLV AOLV OLV/PM AOLV/PM CLV/PM EZOLV Sets the Heart Beat for DeviceNet communication. A setting of 0 disables the Heart Beat function.	0 (0 - 10)	744
F6-63 (03DE)	DeviceNet Network MAC ID	V/f CL-V/f OLV CLV AOLV OLV/PM AOLV/PM CLV/PM EZOLV This parameter is used to enable confirmation of the currently valid MAC address for DeviceNet communication via the keypad. This parameter is used for monitoring only.	0 (0 - 63)	744
F6-64 through F6-67 (03DF to 03E2)	Dynamic Output Assembly 109 Programmable Output 1 through 4	V/f CL-V/f OLV CLV AOLV OLV/PM AOLV/PM CLV/PM EZOLV Sets the Configurable Output 1 through 4 written to the MEMOBUS register.	0000h (0000h - FFFFh)	744
F6-68 through F6-71 (03E3, 03E4, 03C7, and 03C8)	Dynamic Input Assembly 159 Programmable Input 1 to 4	V/f CL-V/f OLV CLV AOLV OLV/PM AOLV/PM CLV/PM EZOLV Sets the Configurable Input 1 through 4 loaded from the MEMOBUS register.	0000h (0000h - FFFFh)	744
F6-72 (081B)	PowerLink Node Address	V/f CL-V/f OLV CLV AOLV OLV/PM AOLV/PM CLV/PM EZOLV Sets the node ID for PowerLink communication.	0 (0 - 255)	744

◆ F7: Communication Option and Ethernet Option

No. (Hex.)	Name	Description	Default (Range)	Ref.
F7-01 (03E5)	IP Address 1	V/f CL-V/f OLV CLV AOLV OLV/PM AOLV/PM CLV/PM EZOLV Sets the IP Address of the device used to connect to the network. Sets the first octet. The drive must be restarted when the setting is changed. Note: • Set the IP Address using <i>F7-01 through F7-04 [IP Address 4]</i> when <i>F7-13 = 0 [Address Mode at Startup = Static]</i> . Set IP Addresses so that they do not overlap on the same network. • Set <i>F7-01 through F7-12</i> when <i>F7-13 = 0</i> .	192 (0 to 255)	744
F7-02 (03E6)	IP Address 2	V/f CL-V/f OLV CLV AOLV OLV/PM AOLV/PM CLV/PM EZOLV Sets the IP Address of the device used to connect to the network. Sets the second octet. The drive must be restarted when the setting is changed. Note: • Set the IP Address using <i>F7-01 through F7-04 [IP Address 1 through IP Address 4]</i> when <i>F7-13 = 0 [Address Mode at Startup = Static]</i> . Set the IP Addresses so that they do not overlap on the same network. • Set <i>F7-01 through F7-12</i> when <i>F7-13 = 0</i> .	168 (0 to 255)	744

No. (Hex.)	Name	Description	Default (Range)	Ref.
F7-03 (03E7)	IP Address 3	<p>V/f CL-V/f OLV CLV AOLV OLV/PM AOLV/PM CLV/PM EZOLV</p> <p>Sets the IP Address of the device used to connect to the network. Sets the third octet. The drive must be restarted when the setting is changed.</p> <p>Note:</p> <ul style="list-style-type: none"> •Set the IP Address using <i>F7-01 through F7-04 [IP Address 1 through IP Address 4]</i> when <i>F7-13 = 0 [Address Mode at Startup = Static]</i>. Set the IP Addresses so that they do not overlap on the same network. •Set <i>F7-01 through F7-12</i> when <i>F7-13 = 0</i>. 	1 (0 to 255)	745
F7-04 (03E8)	IP Address 4	<p>V/f CL-V/f OLV CLV AOLV OLV/PM AOLV/PM CLV/PM EZOLV</p> <p>Sets the IP Address of the device used to connect to the network. Sets the fourth octet. The drive must be restarted when the setting is changed.</p> <p>Note:</p> <ul style="list-style-type: none"> •Set the IP Address using <i>F7-01 through F7-04 [IP Address 1 through IP Address 4]</i> when <i>F7-13 = 0 [Address Mode at Startup = Static]</i>. Set the IP Addresses so that they do not overlap on the same network. •Set <i>F7-01 through F7-12</i> when <i>F7-13 = 0</i>. 	20 (0 to 255)	745
F7-05 (03E9)	Subnet Mask 1	<p>V/f CL-V/f OLV CLV AOLV OLV/PM AOLV/PM CLV/PM EZOLV</p> <p>Sets the subnet mask of the connected network. Sets the first octet.</p> <p>Note:</p> <p>Set this parameter when <i>F7-13 = 0 [Address Mode at Startup = Static]</i>.</p>	255 (0 to 255)	745
F7-06 (03EA)	Subnet Mask 2	<p>V/f CL-V/f OLV CLV AOLV OLV/PM AOLV/PM CLV/PM EZOLV</p> <p>Sets the subnet mask of the connected network. Sets the second octet.</p> <p>Note:</p> <p>Set this parameter when <i>F7-13 = 0 [Address Mode at Startup = Static]</i>.</p>	255 (0 to 255)	745
F7-07 (03EB)	Subnet Mask 3	<p>V/f CL-V/f OLV CLV AOLV OLV/PM AOLV/PM CLV/PM EZOLV</p> <p>Sets the subnet mask of the connected network. Sets the third octet.</p> <p>Note:</p> <p>Set this parameter when <i>F7-13 = 0 [Address Mode at Startup = Static]</i>.</p>	255 (0 to 255)	745
F7-08 (03EC)	Subnet Mask 4	<p>V/f CL-V/f OLV CLV AOLV OLV/PM AOLV/PM CLV/PM EZOLV</p> <p>Sets the subnet mask of the connected network. Sets the fourth octet.</p> <p>Note:</p> <p>Set this parameter when <i>F7-13 = 0 [Address Mode at Startup = Static]</i>.</p>	0 (0 to 255)	746
F7-09 (03ED)	Gateway Address 1	<p>V/f CL-V/f OLV CLV AOLV OLV/PM AOLV/PM CLV/PM EZOLV</p> <p>Sets the Gateway address for the connected network. Sets the first octet.</p> <p>Note:</p> <p>Set this parameter when <i>F7-13 = 0 [Address Mode at Startup = Static]</i>.</p>	192 (0 to 255)	746
F7-10 (03EE)	Gateway Address 2	<p>V/f CL-V/f OLV CLV AOLV OLV/PM AOLV/PM CLV/PM EZOLV</p> <p>Sets the Gateway address for the connected network. Sets the second octet.</p> <p>Note:</p> <p>Set this parameter when <i>F7-13 = 0 [Address Mode at Startup = Static]</i>.</p>	168 (0 to 255)	746
F7-11 (03EF)	Gateway Address 3	<p>V/f CL-V/f OLV CLV AOLV OLV/PM AOLV/PM CLV/PM EZOLV</p> <p>Sets the Gateway address for the connected network. Sets the third octet.</p> <p>Note:</p> <p>Set this parameter when <i>F7-13 = 0 [Address Mode at Startup = Static]</i>.</p>	1 (0 to 255)	746

No. (Hex.)	Name	Description	Default (Range)	Ref.
F7-12 (03F0)	Gateway Address 4	<p>V/f CL-V/f OLV CLV AOLV OLV/PM AOLV/PM CLV/PM EZOLV</p> <p>Sets the Gateway address for the connected network. Sets the fourth octet.</p> <p>Note: Set this parameter when <i>F7-13 = 0</i> [<i>Address Mode at Startup = Static</i>].</p>	1 (0 to 255)	746
F7-13 (03F1)	Address Mode at Startup	<p>V/f CL-V/f OLV CLV AOLV OLV/PM AOLV/PM CLV/PM EZOLV</p> <p>Selects the method to set addresses for option cards.</p> <p>0 : Static 1 : BOOTP 2 : DHCP</p> <p>Note:</p> <ul style="list-style-type: none"> The following setting values are available when using the PROFINET communication option card (SI-EP3). 0: Static 2: DCP Set <i>F7-01 through F7-12</i> [<i>IP Address 1 = Gateway Address 4</i>] when <i>F7-13 = 0</i>. Set the IP Addresses so that they do not overlap on the same network. 	2 (0 - 2)	746
F7-14 (03F2)	Duplex Mode Selection	<p>V/f CL-V/f OLV CLV AOLV OLV/PM AOLV/PM CLV/PM EZOLV</p> <p>Selects the setting method for the duplex mode.</p> <p>0 : Auto/Auto 1 : Half/Half 2 : Full/Full</p>	1 (0 - 8)	747
F7-15 (03F3)	Communication Speed Selection	<p>V/f CL-V/f OLV CLV AOLV OLV/PM AOLV/PM CLV/PM EZOLV</p> <p>Sets the communications speed.</p> <p>10 : 10/10 Mbps 102 : 100/100 Mbps</p>	10 (10, 102)	747
F7-16 (03F4)	Timeout Value	<p>V/f CL-V/f OLV CLV AOLV OLV/PM AOLV/PM CLV/PM EZOLV</p> <p>Sets the detection time of the timeout value for communications in increments of 0.1 s.</p> <p>Note: Setting this parameter to 0 disables the connection timeout function.</p>	0.0 s (0.0 to 30.0 s)	747
F7-17 (03F5)	EtherNet/IP Speed Scaling Factor	<p>V/f CL-V/f OLV CLV AOLV OLV/PM AOLV/PM CLV/PM EZOLV</p> <p>Sets the scaling factor for the speed monitor for the EtherNet/IP object with the Class ID 2AH.</p>	0 (-15 to 15)	747
F7-18 (03F6)	EtherNet/IP Current Scale Factor	<p>V/f CL-V/f OLV CLV AOLV OLV/PM AOLV/PM CLV/PM EZOLV</p> <p>Sets the scaling factor for the output current monitor for the EtherNet/IP object with the Class ID 2AH.</p>	0 (-15 to 15)	747
F7-19 (03F7)	EtherNet/IP Torque Scale Factor	<p>V/f CL-V/f OLV CLV AOLV OLV/PM AOLV/PM CLV/PM EZOLV</p> <p>Sets the scaling factor for the torque monitor for the EtherNet/IP object with the Class ID 2AH.</p>	0 (-15 to 15)	748
F7-20 (03F8)	EtherNet/IP Power Scaling Factor	<p>V/f CL-V/f OLV CLV AOLV OLV/PM AOLV/PM CLV/PM EZOLV</p> <p>Sets the scaling factor for the power monitor for the EtherNet/IP object with the Class ID 2AH.</p>	0 (-15 to 15)	748
F7-21 (03F9)	EtherNet/IP Voltage Scale Factor	<p>V/f CL-V/f OLV CLV AOLV OLV/PM AOLV/PM CLV/PM EZOLV</p> <p>Sets the scaling factor for the voltage monitor for the EtherNet/IP object with the Class ID 2AH.</p>	0 (-15 to 15)	748
F7-22 (03FA)	EtherNet/IP Time Scaling	<p>V/f CL-V/f OLV CLV AOLV OLV/PM AOLV/PM CLV/PM EZOLV</p> <p>Sets the scaling factor for the time monitor for the EtherNet/IP object with the Class ID 2AH.</p>	0 (-15 to 15)	748

No. (Hex.)	Name	Description	Default (Range)	Ref.
F7-23 through F7-27 (03FB - 03FF) F7-28 through F7-32 (0370 - 0374)	Dynamic Out Assembly 115 Param 1 through 10	V/f CL-V/f OLV CLV AOLV OLV/PM AOLV/PM CLV/PM EZOLV Used for setting the Output Assembly 116. The values received from the Output Assembly 116 are written to the MEMOBUS/Modbus address register stored for each parameter. When the MEMOBUS/Modbus address is 0, the values received from the Output Assembly 116 are not written to the registers.	0	748
F7-33 through F7-42 (0375 - 037E)	Dynamic In Assembly 165 Param 1 through 10	V/f CL-V/f OLV CLV AOLV OLV/PM AOLV/PM CLV/PM EZOLV Used for setting the input assembly 166. The values sent to the input assembly 166 are loaded from the MEMOBUS/Modbus address register stored for each parameter. When the MEMOBUS/Modbus address is 0, the value sent to the input assembly 166 is not defined, and so the default register value for the option card is returned.	0	748
F7-60 (0780)	PZD1 Write	V/f CL-V/f OLV CLV AOLV OLV/PM AOLV/PM CLV/PM EZOLV Sets the MEMOBUS/Modbus address for PZD1 (PPO output). PZD1 (PPO output) functions as the STW when <i>F7-60 = 0, 1, or 2</i> .	0	748
F7-61 (0781)	PZD2 Write	V/f CL-V/f OLV CLV AOLV OLV/PM AOLV/PM CLV/PM EZOLV Sets the MEMOBUS/Modbus address for PZD2 (PPO output). PZD2 (PPO output) functions as the HSW when <i>F7-61 = 0, 1, or 2</i> .	0	749
F7-62 (0782)	PZD3 Write	V/f CL-V/f OLV CLV AOLV OLV/PM AOLV/PM CLV/PM EZOLV Sets the MEMOBUS/Modbus address for PZD3 (PPO output). When <i>F7-62 = 0, 1, or 2</i> , the write operation to the MEMOBUS/Modbus register performed by the PZD3 (PPO output) is disabled.	0	749
F7-63 (0783)	PZD4 Write	V/f CL-V/f OLV CLV AOLV OLV/PM AOLV/PM CLV/PM EZOLV Sets the MEMOBUS/Modbus address for PZD4 (PPO output). When <i>F7-63 = 0, 1, or 2</i> , the write operation to the MEMOBUS/Modbus register performed by the PZD4 (PPO output) is disabled.	0	749
F7-64 (0784)	PZD5 Write	V/f CL-V/f OLV CLV AOLV OLV/PM AOLV/PM CLV/PM EZOLV Sets the MEMOBUS/Modbus address for PZD5 (PPO output). When <i>F7-64 = 0, 1, or 2</i> , the write operation to the MEMOBUS/Modbus register performed by the PZD5 (PPO output) is disabled.	0	749
F7-65 (0785)	PZD6 Write	V/f CL-V/f OLV CLV AOLV OLV/PM AOLV/PM CLV/PM EZOLV Sets the MEMOBUS/Modbus address for PZD6 (PPO output). When <i>F7-65 = 0, 1, or 2</i> , the write operation to the MEMOBUS/Modbus register performed by the PZD6 (PPO output) is disabled.	0	749
F7-66 (0786)	PZD7 Write	V/f CL-V/f OLV CLV AOLV OLV/PM AOLV/PM CLV/PM EZOLV Sets the MEMOBUS/Modbus address for PZD7 (PPO output). When <i>F7-66 = 0, 1, or 2</i> , the write operation to the MEMOBUS register performed by the PZD7 (PPO output) is disabled.	0	749
F7-67 (0787)	PZD8 Write	V/f CL-V/f OLV CLV AOLV OLV/PM AOLV/PM CLV/PM EZOLV Sets the MEMOBUS/Modbus address for PZD8 (PPO output). Setting <i>F7-67 = 0, 1, or 2</i> disables the PZD8 Write.	0	749
F7-68 (0788)	PZD9 Write	V/f CL-V/f OLV CLV AOLV OLV/PM AOLV/PM CLV/PM EZOLV Sets the MEMOBUS/Modbus address for PZD9 (PPO output). When <i>F7-68 = 0, 1, or 2</i> , the write operation to the MEMOBUS/Modbus register performed by the PZD9 (PPO output) is disabled.	0	750
F7-69 (0789)	PZD10 Write	V/f CL-V/f OLV CLV AOLV OLV/PM AOLV/PM CLV/PM EZOLV Sets the MEMOBUS/Modbus address for PZD10 (PPO output). When <i>F7-69 = 0, 1, or 2</i> , the write operation to the MEMOBUS/Modbus register performed by the PZD10 (PPO output) is disabled.	0	750
F7-70 (078A)	PZD1 Read	V/f CL-V/f OLV CLV AOLV OLV/PM AOLV/PM CLV/PM EZOLV Sets the MEMOBUS/Modbus address for PZD1 (PPO Read). PZD1 (PPO input) functions as the ZSW when <i>F7-70 = 0</i> .	0	750
F7-71 (078B)	PZD2 Read	V/f CL-V/f OLV CLV AOLV OLV/PM AOLV/PM CLV/PM EZOLV Sets the MEMOBUS/Modbus address for PZD2 (PPO Read). PZD2 (PPO input) functions as the HIW when <i>F7-71 = 0</i> .	0	750
F7-72 (078C)	PZD3 Read	V/f CL-V/f OLV CLV AOLV OLV/PM AOLV/PM CLV/PM EZOLV Sets the MEMOBUS/Modbus address for PZD3 (PPO Read). When <i>F7-72 = 0</i> , the load operation from the MEMOBUS/Modbus register performed by the PZD3 (PPO input) is disabled.	0	750

No. (Hex.)	Name	Description	Default (Range)	Ref.
F7-73 (078D)	PZD4 Read	<p>V/f CL-V/f OLV CLV AOLV OLV/PM AOLV/PM CLV/PM EZOLV</p> <p>Sets the MEMOBUS/Modbus address for PZD4 (PPO Read). When $F7-73 = 0$, the load operation from the MEMOBUS register performed by the PZD4 (PPO input) is disabled.</p>	0	750
F7-74 (078E)	PZD5 Read	<p>V/f CL-V/f OLV CLV AOLV OLV/PM AOLV/PM CLV/PM EZOLV</p> <p>Sets the MEMOBUS/Modbus address for PZD5 (PPO Read). When $F7-74 = 0$, the load operation from the MEMOBUS/Modbus register performed by the PZD5 (PPO input) is disabled.</p>	0	750
F7-75 (078F)	PZD6 Read	<p>V/f CL-V/f OLV CLV AOLV OLV/PM AOLV/PM CLV/PM EZOLV</p> <p>Sets the MEMOBUS/Modbus address for PZD6 (PPO Read). When $F7-75 = 0$, the load operation from the MEMOBUS/Modbus register performed by the PZD6 (PPO input) is disabled.</p>	0	751
F7-76 (0790)	PZD7 Read	<p>V/f CL-V/f OLV CLV AOLV OLV/PM AOLV/PM CLV/PM EZOLV</p> <p>Sets the MEMOBUS/Modbus address for PZD7 (PPO Read). When $F7-76 = 0$, the load operation from the MEMOBUS register performed by the PZD7 (PPO input) is disabled.</p>	0	751
F7-77 (0791)	PZD8 Read	<p>V/f CL-V/f OLV CLV AOLV OLV/PM AOLV/PM CLV/PM EZOLV</p> <p>Sets the MEMOBUS/Modbus address for PZD8 (PPO Read). When $F7-77 = 0$, the load operation from the MEMOBUS/Modbus register performed by the PZD8 (PPO input) is disabled.</p>	0	751
F7-78 (0792)	PZD9 Read	<p>V/f CL-V/f OLV CLV AOLV OLV/PM AOLV/PM CLV/PM EZOLV</p> <p>Sets the MEMOBUS/Modbus address for PZD9 (PPO Read). When $F7-78 = 0$, the load operation from the MEMOBUS/Modbus register performed by the PZD9 (PPO input) is disabled.</p>	0	751
F7-79 (0793)	PZD10 Read	<p>V/f CL-V/f OLV CLV AOLV OLV/PM AOLV/PM CLV/PM EZOLV</p> <p>Sets the MEMOBUS/Modbus address for PZD10 (PPO Read). When $F7-79 = 0$, the load operation from the MEMOBUS/Modbus register performed by the PZD10 (PPO input) is disabled.</p>	0	751

10.10 H: Terminal Functions

◆ H1: Multi-Function Digital Inputs

No. (Hex.)	Name	Description	Default (Range)	Ref.
H1-01 (0438)	Terminal S1 Function Select	<p>V/f CL-V/f OLV CLV AOLV OLV/PM AOLV/PM CLV/PM EZOLV</p> <p>Selects a function assigned to the MFDI terminal S1.</p> <p>Note: When <i>Initialization [A1-03 = 3330]</i> has been performed for a 3-wire sequence, the default setting is <i>F</i>.</p>	40 (1-19F)	753
H1-02 (0439)	Terminal S2 Function Select	<p>V/f CL-V/f OLV CLV AOLV OLV/PM AOLV/PM CLV/PM EZOLV</p> <p>Selects a function assigned to the MFDI terminal S2.</p> <p>Note: When <i>Initialization [A1-03 = 3330]</i> has been performed for a 3-wire sequence, the default setting is <i>F</i>.</p>	41 (1 - 19F)	753
H1-03 (0400)	Terminal S3 Function Select	<p>V/f CL-V/f OLV CLV AOLV OLV/PM AOLV/PM CLV/PM EZOLV</p> <p>Selects a function assigned to the MFDI terminal S3.</p>	24 (0 - 19F)	753
H1-04 (0401)	Terminal S4 Function Select	<p>V/f CL-V/f OLV CLV AOLV OLV/PM AOLV/PM CLV/PM EZOLV</p> <p>Selects a function assigned to the MFDI terminal S4.</p>	14 (0 - 19F)	753
H1-05 (0402)	Terminal S5 Function Select	<p>V/f CL-V/f OLV CLV AOLV OLV/PM AOLV/PM CLV/PM EZOLV</p> <p>Selects a function assigned to the MFDI terminal S5.</p> <p>Note: When <i>Initialization [A1-03 = 3330]</i> has been performed for a 3-wire sequence, the default setting is <i>0</i>.</p>	3 (0 - 19F)	754
H1-06 (0403)	Terminal S6 Function Select	<p>V/f CL-V/f OLV CLV AOLV OLV/PM AOLV/PM CLV/PM EZOLV</p> <p>Selects a function assigned to the MFDI terminal S6.</p> <p>Note: When <i>Initialization [A1-03 = 3330]</i> has been performed for a 3-wire sequence, the default setting is <i>3</i>.</p>	4 (0 - 19F)	754
H1-07 (0404)	Terminal S7 Function Select	<p>V/f CL-V/f OLV CLV AOLV OLV/PM AOLV/PM CLV/PM EZOLV</p> <p>Selects a function assigned to the MFDI terminal S7.</p> <p>Note: When <i>Initialization [A1-03 = 3330]</i> has been performed for a 3-wire sequence, the default setting is <i>4</i>.</p>	6 (0 - 19F)	754
H1-08 (0405)	Terminal S8 Function Select	<p>V/f CL-V/f OLV CLV AOLV OLV/PM AOLV/PM CLV/PM EZOLV</p> <p>Selects a function assigned to the MFDI terminal S8.</p>	8 (0 - 19F)	754
H1-21 (0B70)	Terminal S1 Function Select 2	<p>V/f CL-V/f OLV CLV AOLV OLV/PM AOLV/PM CLV/PM EZOLV</p> <p>Selects the 2nd function for the MFDI terminal S1.</p>	F (1 - 19F)	754
H1-22 (0B71)	Terminal S2 Function Select 2	<p>V/f CL-V/f OLV CLV AOLV OLV/PM AOLV/PM CLV/PM EZOLV</p> <p>Selects the 2nd function for the MFDI terminal S2.</p>	F (1 - 19F)	754
H1-23 (0B72)	Terminal S3 Function Select 2	<p>V/f CL-V/f OLV CLV AOLV OLV/PM AOLV/PM CLV/PM EZOLV</p> <p>Selects the 2nd function for the MFDI terminal S3.</p>	F (1 - 19F)	755
H1-24 (0B73)	Terminal S4 Function Select 2	<p>V/f CL-V/f OLV CLV AOLV OLV/PM AOLV/PM CLV/PM EZOLV</p> <p>Selects the 2nd function for the MFDI terminal S4.</p>	F (1 - 19F)	755
H1-25 (0B74)	Terminal S5 Function Select 2	<p>V/f CL-V/f OLV CLV AOLV OLV/PM AOLV/PM CLV/PM EZOLV</p> <p>Selects the 2nd function for the MFDI terminal S5.</p>	F (1 - 19F)	755
H1-26 (0B75)	Terminal S6 Function Select 2	<p>V/f CL-V/f OLV CLV AOLV OLV/PM AOLV/PM CLV/PM EZOLV</p> <p>Selects the 2nd function for the MFDI terminal S6.</p>	F (1 - 19F)	755
H1-27 (0B76)	Terminal S7 Function Select 2	<p>V/f CL-V/f OLV CLV AOLV OLV/PM AOLV/PM CLV/PM EZOLV</p> <p>Selects the 2nd function for the MFDI terminal S7.</p>	F (1 - 19F)	755
H1-28 (0B77)	Terminal S8 Function Select 2	<p>V/f CL-V/f OLV CLV AOLV OLV/PM AOLV/PM CLV/PM EZOLV</p> <p>Selects the 2nd function for the MFDI terminal S8.</p>	F (1 - 19F)	755
H1-40 (0B54)	Extend MFDI1 Function Selection	<p>V/f CL-V/f OLV CLV AOLV OLV/PM AOLV/PM CLV/PM EZOLV</p> <p>Selects MFDI function assigned to <i>bit 0</i> of the MEMOBUS register <i>15C0(Hex.)</i>.</p>	F (1 - 19F)	756

No. (Hex.)	Name	Description	Default (Range)	Ref.
H1-41 (0B55)	Extend MFDI2 Function Selection	V/f CL-V/f OLV CLV AOLV OLV/PM AOLV/PM CLV/PM EZOLV Selects MFDI function assigned to <i>bit 1</i> of the MEMOBUS register <i>15C0(Hex.)</i> .	F (1 - 19F)	756
H1-42 (0B56)	Extend MFDI3 Function Selection	V/f CL-V/f OLV CLV AOLV OLV/PM AOLV/PM CLV/PM EZOLV Selects MFDI function assigned to <i>bit 2</i> of the MEMOBUS register <i>15C0(Hex.)</i> .	F (1 - 19F)	756

■ H1-xx: Multi-Function Digital Input Setting Values

Setting	Function	Description	Ref.
0	3-Wire Sequence	V/f CL-V/f OLV CLV AOLV OLV/PM AOLV/PM CLV/PM EZOLV Selects the direction of motor rotation for 3-wire sequence.	756
1	LOCAL/REMOTE Selection	V/f CL-V/f OLV CLV AOLV OLV/PM AOLV/PM CLV/PM EZOLV Switches drive control between the keypad (LOCAL) and an external source (REMOTE). ON : LOCAL OFF : REMOTE	757
2	External Reference 1/2 Selection	V/f CL-V/f OLV CLV AOLV OLV/PM AOLV/PM CLV/PM EZOLV Switches between the Run command source 1/2 and Reference command source 1/2 when in REMOTE mode. ON : <i>b1-15</i> = [Frequency Reference Selection 2], <i>b1-16</i> [Run Command Selection 2] OFF : <i>b1-01</i> = [Frequency Reference Selection 1], <i>b1-02</i> [Run Command Selection 1]	757
3	Multi-Step Speed Reference 1	V/f CL-V/f OLV CLV AOLV OLV/PM AOLV/PM CLV/PM EZOLV Switches <i>d1-01</i> to <i>d1-08</i> [Multi-Step Speed Reference] using a combination of multi-step speed references 1, 2 and 3.	758
4	Multi-Step Speed Reference 2	V/f CL-V/f OLV CLV AOLV OLV/PM AOLV/PM CLV/PM EZOLV Switches <i>d1-01</i> to <i>d1-08</i> [Multi-Step Speed Reference] using a combination of multi-step speed references 1, 2 and 3.	758
5	Multi-Step Speed Reference 3	V/f CL-V/f OLV CLV AOLV OLV/PM AOLV/PM CLV/PM EZOLV Switches <i>d1-01</i> to <i>d1-08</i> [Multi-Step Speed Reference] using a combination of multi-step speed references 1, 2 and 3.	758
6	Jog Reference Selection	V/f CL-V/f OLV CLV AOLV OLV/PM AOLV/PM CLV/PM EZOLV Enables the Jog Reference (JOG command) that was set <i>ind1-17</i> . The Jog Reference (JOG command) overrides even References 1 to 16 (<i>d1-01</i> to <i>d1-16</i>).	758
7	Accel/decel Time Selection 1	V/f CL-V/f OLV CLV AOLV OLV/PM AOLV/PM CLV/PM EZOLV Switches between <i>C1-01</i> , <i>C1-02</i> [Acceleration/Deceleration Time 1] and <i>C1-03</i> , <i>C1-04</i> [Acceleration/Deceleration Time 2].	758
8	Baseblock Command (N.O.)	V/f CL-V/f OLV CLV AOLV OLV/PM AOLV/PM CLV/PM EZOLV If a baseblock command (N.O.) is input, the drive output will stop and the motor will coast to stop. ON : Baseblock (drive output stop) OFF : Normal operation	758
9	Baseblock Command (N.C.)	V/f CL-V/f OLV CLV AOLV OLV/PM AOLV/PM CLV/PM EZOLV If a baseblock command (N.C.) is input (turned OFF), the drive output will stop and the motor will coast to stop. ON : Normal operation OFF : Baseblock (drive output stop)	759
A	Accel/Decel Ramp Hold	V/f CL-V/f OLV CLV AOLV OLV/PM AOLV/PM CLV/PM EZOLV Momentarily pauses motor acceleration and deceleration when the terminal is turned ON, retains the output frequency that was stored in the drive at the time of the pause, and restarts motor operation.	759
B	Drive Overheat Alarm (oH2)	V/f CL-V/f OLV CLV AOLV OLV/PM AOLV/PM CLV/PM EZOLV If the terminal is turned ON, the keypad flashes an <i>oH2</i> [Drive Overheat Warning] minor fault message. The fault does not affect drive operation.	759
C	Analog Terminal Input Selection	V/f CL-V/f OLV CLV AOLV OLV/PM AOLV/PM CLV/PM EZOLV Enables and disables the terminal selected with the <i>H3-14</i> [Analog Input Term Enable Select] function. ON : Input to the terminal selected with <i>H3-14</i> is enabled OFF : Input to the terminal selected with <i>H3-14</i> is disabled	759

10.10 H: Terminal Functions

Setting	Function	Description	Ref.
D	PG Encoder Disable	<p>V/f CL-V/f OLV CLV AOLV OLV/PM AOLV/PM CLV/PM EZOLV</p> <p>Disregards feedback control from the encoder and runs V/f Control run if the terminal is turned ON. Controls the motor speed using feedback from the encoder if the terminal is turned OFF.</p> <p>ON : Speed feedback control disable (V/f Control) OFF : Speed feedback control enable (Closed Loop V/f Control)</p>	760
E	ASR Integral Reset	<p>V/f CL-V/f OLV CLV AOLV OLV/PM AOLV/PM CLV/PM EZOLV</p> <p>Resets the integral value and switches the speed control loop between PI control and P control.</p> <p>ON : P control OFF : PI control</p>	760
F	Through Mode	<p>V/f CL-V/f OLV CLV AOLV OLV/PM AOLV/PM CLV/PM EZOLV</p> <p>Set when a terminal is not used or when using a terminal in through mode.</p>	760
10	Up Command	<p>V/f CL-V/f OLV CLV AOLV OLV/PM AOLV/PM CLV/PM EZOLV</p> <p>It is paired with setting value 11 (Down command). When using the Up command and Down command, the user can raise and lower the frequency reference of the drive using two push buttons.</p> <p>ON : Raises the frequency reference. OFF : Holds the current frequency reference.</p>	760
11	Down Command	<p>V/f CL-V/f OLV CLV AOLV OLV/PM AOLV/PM CLV/PM EZOLV</p> <p>It is paired with setting value 10 (Up command). When using the Up command and Down command, the user can raise and lower the frequency reference of the drive using two push buttons.</p> <p>ON : Lowers the frequency reference. OFF : Holds the current frequency reference.</p>	762
12	Forward Jog	<p>V/f CL-V/f OLV CLV AOLV OLV/PM AOLV/PM CLV/PM EZOLV</p> <p>Inputting the Forward JOG command runs the motor in the forward direction at the jog frequency set in <i>d1-17 [Jog Reference]</i>.</p>	762
13	Reverse Jog	<p>V/f CL-V/f OLV CLV AOLV OLV/PM AOLV/PM CLV/PM EZOLV</p> <p>Inputting the Reverse JOG command reverses the motor at the jog frequency set in <i>d1-17 [Jog Reference]</i>.</p>	762
14	Fault Reset	<p>V/f CL-V/f OLV CLV AOLV OLV/PM AOLV/PM CLV/PM EZOLV</p> <p>When the terminal is ON while the Run command is inactive, the fault currently detected by the drive will be reset.</p> <p>Note: The fault reset signal is disregarded when the Run command is enabled. Remove the Run command before attempting to clear a fault situation.</p>	763
15	Fast Stop (N.O.)	<p>V/f CL-V/f OLV CLV AOLV OLV/PM AOLV/PM CLV/PM EZOLV</p> <p>When Fast Stop (N.O.) is input while the drive is running, the drive performs ramp to stop in a deceleration time configured with <i>C1-09 [Fast Stop Time]</i>.</p>	763
16	Motor 2 Selection	<p>V/f CL-V/f OLV CLV AOLV OLV/PM AOLV/PM CLV/PM EZOLV</p> <p>Switches between motors 1 and 2. Switch between motors when they are stopped.</p> <p>ON : Selects motor 2 OFF : Selects motor 1</p>	763
17	Fast Stop (N.C.)	<p>V/f CL-V/f OLV CLV AOLV OLV/PM AOLV/PM CLV/PM EZOLV</p> <p>When Fast Stop (N.C.) is input while the drive is running, the drive performs ramp to stop in a deceleration time configured with <i>C1-09 [Fast Stop Time]</i>.</p>	764
18	Timer Function Input	<p>V/f CL-V/f OLV CLV AOLV OLV/PM AOLV/PM CLV/PM EZOLV</p> <p>Used as the input terminal for the timer function. It is paired with <i>Timer Output [H2-xx = 12]</i>.</p>	764
19	PID Disable	<p>V/f CL-V/f OLV CLV AOLV OLV/PM AOLV/PM CLV/PM EZOLV</p> <p>Disables PID control using an external input when <i>b5-01 = 1 to 8 [PID Function Setting = Enabled]</i>.</p> <p>ON : PID control disabled OFF : PID control enabled</p>	765
1A	Accel/Decel Time Selection 2	<p>V/f CL-V/f OLV CLV AOLV OLV/PM AOLV/PM CLV/PM EZOLV</p> <p>It is used in combination with the <i>Accel/dec el Time Selection 1 [H1-xx = 7]</i>. Switches between <i>C1-01 to C1-08 [Acceleration and Deceleration Times 1 to 4]</i>.</p>	765

Setting	Function	Description	Ref.
1B	Program Lockout	<p>V/f CL-V/f OLV CLV AOLV OLV/PM AOLV/PM CLV/PM EZOLV</p> <p>The following parameter setting values can be changed when the terminal set for program lockout is ON. When the terminal is OFF, the setting values of parameters cannot be changed.</p> <p>ON : Program Lockout OFF : Parameter Write Prohibit</p>	765
1E	Reference sample hold	<p>V/f CL-V/f OLV CLV AOLV OLV/PM AOLV/PM CLV/PM EZOLV</p> <p>The analog frequency reference input via terminal A1, A2 or A3 will be sampled and operation will continue at that frequency.</p>	765
20 to 2F	External fault	<p>V/f CL-V/f OLV CLV AOLV OLV/PM AOLV/PM CLV/PM EZOLV</p> <p>Selects the drive operation that was active at the time the failure or fault was detected in the external device connected to the drive from any of the patterns between 20 to 2F.</p>	766
30	PID integral reset	<p>V/f CL-V/f OLV CLV AOLV OLV/PM AOLV/PM CLV/PM EZOLV</p> <p>Resets the value of the PID control integral to 0 while the terminal is ON, and holds the value.</p>	766
31	PID integral hold	<p>V/f CL-V/f OLV CLV AOLV OLV/PM AOLV/PM CLV/PM EZOLV</p> <p>This function force holds the integral value of the PID control as long as the terminal is ON.</p>	767
32	Multi-Step Speed Reference 4	<p>V/f CL-V/f OLV CLV AOLV OLV/PM AOLV/PM CLV/PM EZOLV</p> <p>Switches <i>d1-09</i> to <i>d1-16</i> [Reference 9 to 16] using a combination of multi-step speed references 1, 2 and 3.</p>	767
34	PID soft starter cancel	<p>V/f CL-V/f OLV CLV AOLV OLV/PM AOLV/PM CLV/PM EZOLV</p> <p>Enables or disables the PID soft starter.</p> <p>ON : Disabled OFF : Enabled</p>	767
35	PID input level selection	<p>V/f CL-V/f OLV CLV AOLV OLV/PM AOLV/PM CLV/PM EZOLV</p> <p>Switches the PID input level (polarity) by turning the terminal on and off.</p>	767
3E	PID Setpoint Selection 1	<p>V/f CL-V/f OLV CLV AOLV OLV/PM AOLV/PM CLV/PM EZOLV</p> <p>It is used in combination with <i>PID Setpoint Selection 2</i> [<i>H1-xx = 3F</i>]. Switches the PID setpoint to <i>b5-58</i> to <i>b5-60</i> [<i>PID setpoint2</i> to 4].</p>	767
3F	PID Setpoint Selection 2	<p>V/f CL-V/f OLV CLV AOLV OLV/PM AOLV/PM CLV/PM EZOLV</p> <p>It is used in combination with <i>PID Setpoint Selection 1</i> [<i>H1-xx = 3E</i>]. Switches the PID setpoint to <i>b5-58</i> to <i>b5-60</i> [<i>PID setpoint2</i> to 4].</p>	767
40	Forward Run Command (2-Wire Seq)	<p>V/f CL-V/f OLV CLV AOLV OLV/PM AOLV/PM CLV/PM EZOLV</p> <p>Inputs the Forward run command for 2-wire sequence 1. Use it paired with the <i>Reverse Run Command (2-Wire Seq)</i> [<i>H1-xx = 41</i>].</p> <p>ON : Forward Run OFF : Run Stop</p> <p>Note:</p> <ul style="list-style-type: none"> • When the both Forward run command and Reverse run command terminals have been turned ON, the drive detects <i>EF</i> [<i>FWD/REV Run Command Input Error</i>] (minor fault), and the motor ramps to stop. • The Forward run/Reverse run command is set to terminals S1 and S2 when the drive is initialized using a 2-wire sequence. • Simultaneous use with <i>H1-xx = 42, 43</i> [<i>Run Command/FWD/REV Command (2-Wire Seq 2)</i>] is not possible. 	768
41	Reverse Run Command (2-Wire Seq)	<p>V/f CL-V/f OLV CLV AOLV OLV/PM AOLV/PM CLV/PM EZOLV</p> <p>Inputs the Reverse run command for 2-wire sequence 1. Use it paired with the <i>Forward Run Command (2-Wire Seq)</i> [<i>H1-xx = 40</i>].</p> <p>ON : Reverse Run OFF : Run Stop</p> <p>Note:</p> <ul style="list-style-type: none"> • When the both Forward run command and Reverse run command terminals have been turned ON, the drive detects <i>EF</i> [<i>FWD/REV Run Command Input Error</i>] (minor fault), and the motor ramps to stop. • The Reverse run command is set to terminal S2 when the drive is initialized using a 2-wire sequence. • Simultaneous use with <i>H1-xx = 42, 43</i> [<i>Run Command/FWD/REV Command (2-Wire Seq 2)</i>] is not possible. 	768

Setting	Function	Description	Ref.
42	Run Command (2-Wire Sequence 2)	<p>V/f CL-V/f OLV CLV AOLV OLV/PM AOLV/PM CLV/PM EZOLV</p> <p>Inputs the Run command for 2-wire sequence 2. Use it paired with the <i>FWD/REV Command (2-Wire Seq 2)</i> [H1-xx = 43].</p> <p>ON : Run OFF : Stop</p> <p>Note: Run Command (2-Wire Sequence 2) cannot be used at the same time as <i>Forward/Reverse Run Command (2-Wire Seq)</i> [H1-xx = 40, 41].</p>	768
43	FWD/REV Command (2-Wire Seq 2)	<p>V/f CL-V/f OLV CLV AOLV OLV/PM AOLV/PM CLV/PM EZOLV</p> <p>Selects the direction of motor rotation for 2-wire sequence 2. Use it paired with the <i>Run Command (2-Wire Sequence 2)</i> [H1-xx = 42].</p> <p>ON : Reverse OFF : Forward</p> <p>Note: FWD/REV Command (2-Wire Seq 2) cannot be used at the same time as <i>Forward/Reverse Run Command (2-Wire Seq)</i> [H1-xx = 40, 41].</p>	768
44	Offset frequency 1	<p>V/f CL-V/f OLV CLV AOLV OLV/PM AOLV/PM CLV/PM EZOLV</p> <p>Adds the offset frequency set in <i>d7-01</i> to the frequency reference. when the terminal is turned ON.</p>	769
45	Offset frequency 2	<p>V/f CL-V/f OLV CLV AOLV OLV/PM AOLV/PM CLV/PM EZOLV</p> <p>Adds the offset frequency set in <i>d7-02</i> to the frequency reference. when the terminal is turned ON.</p>	769
46	Offset frequency 3	<p>V/f CL-V/f OLV CLV AOLV OLV/PM AOLV/PM CLV/PM EZOLV</p> <p>Adds the offset frequency set in <i>d7-03</i> to the frequency reference. when the terminal is turned ON.</p>	769
47	Node Setup	<p>V/f CL-V/f OLV CLV AOLV OLV/PM AOLV/PM CLV/PM EZOLV</p> <p>When the CANopen communication option is utilized, the Node Setup function (a function for setting the drive node address from the host controller) is enabled.</p>	769
60	DC Injection Braking command	<p>V/f CL-V/f OLV CLV AOLV OLV/PM AOLV/PM CLV/PM EZOLV</p> <p>If the DC Injection Braking command is input when the drive is performing stopping operation, DC Injection Braking is applied to stop the motor.</p> <p>Note: This function enables only when the induction motor is used for <i>A1-02 = 8</i> [Control Method Selection = EZ Open Loop Vector Control].</p>	769
61	External Speed Search command 1	<p>V/f CL-V/f OLV CLV AOLV OLV/PM AOLV/PM CLV/PM EZOLV</p> <p>Executes speed search using an external reference even when <i>b3-01 = 0</i> [Speed Search Selection at Start = Disabled].</p> <p>Note: If both <i>H1-xx = 61 and 62</i> are set simultaneously, <i>oPE03</i> [Multi-Function Input Setting Err] is detected. Set the external speed search command for only 1 or 2.</p>	770
62	External Speed Search command 2	<p>V/f CL-V/f OLV CLV AOLV OLV/PM AOLV/PM CLV/PM EZOLV</p> <p>Executes speed search using an external reference even when <i>b3-01 = 0</i> [Speed Search Selection at Start = Disabled].</p> <p>Note: If both <i>H1-xx = 61 and 62</i> are set simultaneously, <i>oPE03</i> [Multi-Function Input Setting Err] is detected. Set the external speed search command for only 1 or 2.</p>	770
63	Field weakening	<p>V/f CL-V/f OLV CLV AOLV OLV/PM AOLV/PM CLV/PM EZOLV</p> <p>This function issues the commands of Field Weakening Level and Field Weakening Frequency Limit set in <i>d6-01 and d6-02</i> when the input terminal is turned ON</p>	770
65	KEB Ride-Thru 1 (N.C.)	<p>V/f CL-V/f OLV CLV AOLV OLV/PM AOLV/PM CLV/PM EZOLV</p> <p>Switches the KEB1 function between enable and disable via the KEB Ride-Thru 1 (N.C.).</p> <p>ON : Normal operation OFF : Deceleration during momentary power loss</p>	770
66	KEB Ride-Thru 1 (N.O.)	<p>V/f CL-V/f OLV CLV AOLV OLV/PM AOLV/PM CLV/PM EZOLV</p> <p>Switches the KEB1 function between enable and disable via the KEB Ride-Thru 1 (N.O.).</p> <p>ON : Deceleration during momentary power loss OFF : Normal operation</p>	770
67	Communications test mode	<p>V/f CL-V/f OLV CLV AOLV OLV/PM AOLV/PM CLV/PM EZOLV</p> <p>Performs self-diagnosis on the RS-485 serial communications operation.</p>	771

Setting	Function	Description	Ref.
68	High Slip Braking (HSB)	<input type="checkbox"/> V/f <input type="checkbox"/> CL-V/f <input type="checkbox"/> OLV <input type="checkbox"/> CLV <input type="checkbox"/> AOLV <input type="checkbox"/> OLV/PM <input type="checkbox"/> AOLV/PM <input type="checkbox"/> CLV/PM <input type="checkbox"/> EZOLV Stops the motor using high-slip braking.	771
6A	Drive Enable	<input type="checkbox"/> V/f <input type="checkbox"/> CL-V/f <input type="checkbox"/> OLV <input type="checkbox"/> CLV <input type="checkbox"/> AOLV <input type="checkbox"/> OLV/PM <input type="checkbox"/> AOLV/PM <input type="checkbox"/> CLV/PM <input type="checkbox"/> EZOLV The keypad displays <i>dnE</i> [Drive Enabled] when the terminal is turned OFF and the Run command will not be accepted.	771
71	Speed/Torque Control Switch	<input type="checkbox"/> V/f <input type="checkbox"/> CL-V/f <input type="checkbox"/> OLV <input checked="" type="checkbox"/> CLV <input type="checkbox"/> AOLV <input type="checkbox"/> OLV/PM <input type="checkbox"/> AOLV/PM <input type="checkbox"/> CLV/PM <input type="checkbox"/> EZOLV Switches between torque and speed control. ON : Torque control OFF : Speed control	771
72	Zero Servo	<input type="checkbox"/> V/f <input type="checkbox"/> CL-V/f <input type="checkbox"/> OLV <input checked="" type="checkbox"/> CLV <input type="checkbox"/> AOLV <input type="checkbox"/> OLV/PM <input type="checkbox"/> AOLV/PM <input type="checkbox"/> CLV/PM <input type="checkbox"/> EZOLV Holds the motor when it is stopped.	772
75	Up 2 Command	<input type="checkbox"/> V/f <input type="checkbox"/> CL-V/f <input type="checkbox"/> OLV <input type="checkbox"/> CLV <input type="checkbox"/> AOLV <input type="checkbox"/> OLV/PM <input type="checkbox"/> AOLV/PM <input type="checkbox"/> CLV/PM <input type="checkbox"/> EZOLV Accelerates the motor by increasing the frequency reference bias value when the terminal is turned ON. Always set the Up2 command and Down 2 command as a pair. Note: When the Up2/Down2 function is used, set the optimal bias limit value using <i>d4-08</i> and <i>d4-09</i> [Up/Down 2 Bias Upper Limit/Lower Limit (Up/Down 2)].	772
76	Down 2 Command	<input type="checkbox"/> V/f <input type="checkbox"/> CL-V/f <input type="checkbox"/> OLV <input type="checkbox"/> CLV <input type="checkbox"/> AOLV <input type="checkbox"/> OLV/PM <input type="checkbox"/> AOLV/PM <input type="checkbox"/> CLV/PM <input type="checkbox"/> EZOLV Decelerates the motor by reducing the frequency reference bias value when the terminal is turned ON. Always set the Up2 command and Down 2 command as a pair. Note: When the Up2/Down2 function is used, set the optimal bias limit value using <i>d4-08</i> and <i>d4-09</i> [Up/Down 2 Bias Upper Limit/Lower Limit (Up/Down 2)].	774
77	ASR Gain Switch	<input type="checkbox"/> V/f <input type="checkbox"/> CL-V/f <input type="checkbox"/> OLV <input checked="" type="checkbox"/> CLV <input type="checkbox"/> AOLV <input type="checkbox"/> OLV/PM <input type="checkbox"/> AOLV/PM <input type="checkbox"/> CLV/PM <input type="checkbox"/> EZOLV Switches the ASR proportional gain set in <i>C5-01</i> [ASR Proportional Gain 1] and <i>C5-03</i> [ASR Proportional Gain 1/2]. ON : C5-03 OFF : C5-01	774
78	Ex. Torque Ref Polarity Inversion	<input type="checkbox"/> V/f <input type="checkbox"/> CL-V/f <input type="checkbox"/> OLV <input checked="" type="checkbox"/> CLV <input type="checkbox"/> AOLV <input type="checkbox"/> OLV/PM <input type="checkbox"/> AOLV/PM <input type="checkbox"/> CLV/PM <input type="checkbox"/> EZOLV Switches the rotation direction of the external torque reference. ON : External torque reference reverse direction OFF : External torque reference forward direction	774
7A	KEB Ride-Thru 2 (N.C.)	<input type="checkbox"/> V/f <input type="checkbox"/> CL-V/f <input type="checkbox"/> OLV <input checked="" type="checkbox"/> CLV <input type="checkbox"/> AOLV <input type="checkbox"/> OLV/PM <input type="checkbox"/> AOLV/PM <input type="checkbox"/> CLV/PM <input type="checkbox"/> EZOLV Switches the KEB 2 Ride-Thru function between enable and disable via the KEB Ride-Thru 2 (N.C.). ON : Normal operation OFF : Deceleration during momentary power loss	775
7B	KEB Ride-Thru 2 (N.O.)	<input type="checkbox"/> V/f <input type="checkbox"/> CL-V/f <input type="checkbox"/> OLV <input checked="" type="checkbox"/> CLV <input type="checkbox"/> AOLV <input type="checkbox"/> OLV/PM <input type="checkbox"/> AOLV/PM <input type="checkbox"/> CLV/PM <input type="checkbox"/> EZOLV Switches the KEB 2 Ride-Thru function between enable and disable via the KEB Ride-Thru 2 (N.O.). ON : Deceleration during momentary power loss OFF : Normal operation	775
7C	Short Circuit Braking (N.O.)	<input type="checkbox"/> V/f <input type="checkbox"/> CL-V/f <input type="checkbox"/> OLV <input type="checkbox"/> CLV <input type="checkbox"/> AOLV <input type="checkbox"/> OLV/PM <input type="checkbox"/> AOLV/PM <input type="checkbox"/> CLV/PM <input type="checkbox"/> EZOLV Enables and disables Short Circuit Braking. (N.O.) ON : Short Circuit Braking is enabled. OFF : Normal operation Note: This function enables only when the PM motor is used for <i>A1-02 = 8</i> [Control Method Selection = EZ Open Loop Vector Control].	775
7D	Short Circuit Braking (N.C.)	<input type="checkbox"/> V/f <input type="checkbox"/> CL-V/f <input type="checkbox"/> OLV <input type="checkbox"/> CLV <input type="checkbox"/> AOLV <input type="checkbox"/> OLV/PM <input type="checkbox"/> AOLV/PM <input type="checkbox"/> CLV/PM <input type="checkbox"/> EZOLV Enables and disables Short Circuit Braking. (N.C.) ON : Normal operation OFF : Short Circuit Braking is enabled. Note: This function enables only when the PM motor is used for <i>A1-02 = 8</i> [Control Method Selection = EZ Open Loop Vector Control].	775

Setting	Function	Description	Ref.
7E	FWD/REV Detect (V/f w/ simplePG)	V/f CL-V/f OLV CLV AOLV OLV/PM AOLV/PM CLV/PM EZOLV Allows the rotation direction of the motor to be set when $F1-21, F1-37 = 0$ [Encoder Option Function Selection = A pulse detection] for Simple Closed Loop V/f Control method and Closed Loop V/f Control method. ON : Reverse OFF : Forward	776
90 to 97	DriveWorksEZ Digital Inputs 1 to 8	V/f CL-V/f OLV CLV AOLV OLV/PM AOLV/PM CLV/PM EZOLV A setting parameter for digital inputs used with DriveWorksEZ. Refer to the DriveWorksEZ Online Manual for more details.	776
9F	DriveWorksEZ Disable	V/f CL-V/f OLV CLV AOLV OLV/PM AOLV/PM CLV/PM EZOLV Enables and disables the DriveWorksEZ program that is saved in the drive. ON : Disabled OFF : Enabled Note: This function can only be used when $A1-07 = 2$ [DriveWorksEZ Function Selection = Digital input].	776

◆ H2: Multi-function digital output

No. (Hex.)	Name	Description	Default (Range)	Ref.
H2-01 (040B)	Term M1-M2 Function Selection	V/f CL-V/f OLV CLV AOLV OLV/PM AOLV/PM CLV/PM EZOLV Selects the function assigned to MFDO terminal M1-M2. Note: Set this parameter to <i>F</i> when not using the terminal or to use the terminal in through mode.	0 (0 - 1A7)	779
H2-02 (040C)	Term M3-M4 Function Selection	V/f CL-V/f OLV CLV AOLV OLV/PM AOLV/PM CLV/PM EZOLV Selects the function assigned to MFDO terminal M3-M4. Note: Set this parameter to <i>F</i> when not using the terminal or to use the terminal in through mode.	1 (0 - 1A7)	779
H2-03 (040D)	Terminal P1-PC Function Select	V/f CL-V/f OLV CLV AOLV OLV/PM AOLV/PM CLV/PM EZOLV Selects the function assigned to MFDO terminal P1-C1. Note: Set this parameter to <i>F</i> when not using the terminal or to use the terminal in through mode.	2 (0 - 1A7)	779
H2-04 (040E)	Terminal P2-PC Function Select	V/f CL-V/f OLV CLV AOLV OLV/PM AOLV/PM CLV/PM EZOLV Selects the function assigned to MFDO terminal P2-C2. Note: Set this parameter to <i>F</i> when not using the terminal or to use the terminal in through mode.	F (0 - 1A7)	779
H2-06 (0437)	Watt Hour Output Unit Selection	V/f CL-V/f OLV CLV AOLV OLV/PM AOLV/PM CLV/PM EZOLV Configures the output signal unit when $H2-01$ through $H2-04 = 39$ [MFDO Function Select = Watt Hour Pulse Output] is selected. 0 : 0.1 kWh units 1 : 1 kWh units 2 : 10 kWh units 3 : 100 kWh units 4 : 1000 kWh units	0 (0 - 4)	779
H2-07 (0B3A)	MEMOBUS Register1 Address Select	V/f CL-V/f OLV CLV AOLV OLV/PM AOLV/PM CLV/PM EZOLV Configures the address of the MEMOBUS/Modbus register output to the MFDO terminal.	0001 (0001 - 1FFF)	780
H2-08 (0B3B)	MEMOBUS Register 1 Bit Select	V/f CL-V/f OLV CLV AOLV OLV/PM AOLV/PM CLV/PM EZOLV Configures the bit of the MEMOBUS/Modbus register output to the MFDO terminal.	0000 (0000 - FFFF)	780
H2-09 (0B3C)	MEMOBUS Register2 Address Select	V/f CL-V/f OLV CLV AOLV OLV/PM AOLV/PM CLV/PM EZOLV Configures the address of the MEMOBUS/Modbus register output to the MFDO terminal.	0001 (0001 - 1FFF)	780

No. (Hex.)	Name	Description	Default (Range)	Ref.
H2-10 (0B3D)	MEMOBUS Register 2 Bit Select	<input type="checkbox"/> V/f <input type="checkbox"/> CL-V/f <input type="checkbox"/> OLV <input type="checkbox"/> CLV <input type="checkbox"/> AOLV <input type="checkbox"/> OLV/PM <input type="checkbox"/> AOLV/PM <input type="checkbox"/> CLV/PM <input type="checkbox"/> EZOLV Configures the bit of the MEMOBUS/Modbus register output to the MFDO terminal.	0000 (0000 - FFFF)	780
H2-20 (1540)	Comparator 1 Monitor Selection	<input type="checkbox"/> V/f <input type="checkbox"/> CL-V/f <input type="checkbox"/> OLV <input type="checkbox"/> CLV <input type="checkbox"/> AOLV <input type="checkbox"/> OLV/PM <input type="checkbox"/> AOLV/PM <input type="checkbox"/> CLV/PM <input type="checkbox"/> EZOLV Configures the monitor number for comparator 1. Configure the <i>x-xx</i> portion of <i>Ux-xx</i> [Monitor]. For example, set <i>x-xx</i> to 102 to monitor <i>U1-02</i> [Output Frequency].	102 (000 - 999)	780
H2-21 (1541)	Comparator 1 Lower Limit	<input type="checkbox"/> V/f <input type="checkbox"/> CL-V/f <input type="checkbox"/> OLV <input type="checkbox"/> CLV <input type="checkbox"/> AOLV <input type="checkbox"/> OLV/PM <input type="checkbox"/> AOLV/PM <input type="checkbox"/> CLV/PM <input type="checkbox"/> EZOLV Configures the lower limit detection level for comparator 1 on the basis that the full scale analog output for the monitor number selected with <i>H2-20</i> [Comparator 1 Monitor Selection] is the 100% value.	0.0% (0.0 - 300.0%)	781
H2-22 (1542)	Comparator 1 Upper Limit	<input type="checkbox"/> V/f <input type="checkbox"/> CL-V/f <input type="checkbox"/> OLV <input type="checkbox"/> CLV <input type="checkbox"/> AOLV <input type="checkbox"/> OLV/PM <input type="checkbox"/> AOLV/PM <input type="checkbox"/> CLV/PM <input type="checkbox"/> EZOLV Configures the upper limit detection level for comparator 1 on the basis that the full scale analog output for the monitor number selected with <i>H2-20</i> [Comparator 1 Monitor Selection] is the 100% value.	0.0% (0.0 - 300.0%)	781
H2-23 (1543)	Comparator 1 Hysteresis	<input type="checkbox"/> V/f <input type="checkbox"/> CL-V/f <input type="checkbox"/> OLV <input type="checkbox"/> CLV <input type="checkbox"/> AOLV <input type="checkbox"/> OLV/PM <input type="checkbox"/> AOLV/PM <input type="checkbox"/> CLV/PM <input type="checkbox"/> EZOLV Configures the hysteresis level for comparator 1 on the basis that the full scale analog output for the monitor number selected with <i>H2-20</i> [Comparator 1 Monitor Selection] is the 100% value.	0.0% (0.0 - 10.0%)	781
H2-24 (1544)	Comparator 1 On-Delay Time	<input type="checkbox"/> V/f <input type="checkbox"/> CL-V/f <input type="checkbox"/> OLV <input type="checkbox"/> CLV <input type="checkbox"/> AOLV <input type="checkbox"/> OLV/PM <input type="checkbox"/> AOLV/PM <input type="checkbox"/> CLV/PM <input type="checkbox"/> EZOLV Configures the comparator 1 on delay time.	0.0 s (0.0 - 600.0 s)	781
H2-25 (1545)	Comparator 1 Off-Delay Time	<input type="checkbox"/> V/f <input type="checkbox"/> CL-V/f <input type="checkbox"/> OLV <input type="checkbox"/> CLV <input type="checkbox"/> AOLV <input type="checkbox"/> OLV/PM <input type="checkbox"/> AOLV/PM <input type="checkbox"/> CLV/PM <input type="checkbox"/> EZOLV Configures the comparator 1 off delay time.	0.0 s (0.0 - 600.0 s)	781
H2-26 (1546)	Comparator 2 Monitor Selection	<input type="checkbox"/> V/f <input type="checkbox"/> CL-V/f <input type="checkbox"/> OLV <input type="checkbox"/> CLV <input type="checkbox"/> AOLV <input type="checkbox"/> OLV/PM <input type="checkbox"/> AOLV/PM <input type="checkbox"/> CLV/PM <input type="checkbox"/> EZOLV Configures the monitor number for comparator 2. Configure the <i>x-xx</i> portion of <i>Ux-xx</i> [Monitor]. For example, to monitor <i>U1-03</i> [Output Current], set a value of 103.	103 (000 - 999)	782
H2-27 (1547)	Comparator 2 Lower Limit	<input type="checkbox"/> V/f <input type="checkbox"/> CL-V/f <input type="checkbox"/> OLV <input type="checkbox"/> CLV <input type="checkbox"/> AOLV <input type="checkbox"/> OLV/PM <input type="checkbox"/> AOLV/PM <input type="checkbox"/> CLV/PM <input type="checkbox"/> EZOLV Configures the lower limit detection level for comparator 2 on the basis that the full scale analog output for the monitor number selected with <i>H2-26</i> [Comparator 2 Monitor Selection] is the 100% value.	0.0% (0.0 - 300.0%)	782
H2-28 (1548)	Comparator 2 Upper Limit	<input type="checkbox"/> V/f <input type="checkbox"/> CL-V/f <input type="checkbox"/> OLV <input type="checkbox"/> CLV <input type="checkbox"/> AOLV <input type="checkbox"/> OLV/PM <input type="checkbox"/> AOLV/PM <input type="checkbox"/> CLV/PM <input type="checkbox"/> EZOLV Configures the upper limit detection level for comparator 2 on the basis that the full scale analog output for the monitor number selected with <i>H2-26</i> [Comparator 2 Monitor Selection] is the 100% value.	0.0% (0.0 - 300.0%)	782
H2-29 (1549)	Comparator 2 Hysteresis	<input type="checkbox"/> V/f <input type="checkbox"/> CL-V/f <input type="checkbox"/> OLV <input type="checkbox"/> CLV <input type="checkbox"/> AOLV <input type="checkbox"/> OLV/PM <input type="checkbox"/> AOLV/PM <input type="checkbox"/> CLV/PM <input type="checkbox"/> EZOLV Configures the hysteresis level for comparator 2 on the basis that the full scale analog output for the monitor number selected with <i>H2-26</i> [Comparator 2 Monitor Selection] is the 100% value.	0.0% (0.0 - 10.0%)	782
H2-30 (154A)	Comparator 2 On-Delay Time	<input type="checkbox"/> V/f <input type="checkbox"/> CL-V/f <input type="checkbox"/> OLV <input type="checkbox"/> CLV <input type="checkbox"/> AOLV <input type="checkbox"/> OLV/PM <input type="checkbox"/> AOLV/PM <input type="checkbox"/> CLV/PM <input type="checkbox"/> EZOLV Configures the time for the monitor number configured with <i>H2-26</i> [Comparator 2 Monitor Selection].	0.0 s (0.0 - 6000.0 s)	782
H2-31 (154B)	Comparator 2 Off-Delay Time	<input type="checkbox"/> V/f <input type="checkbox"/> CL-V/f <input type="checkbox"/> OLV <input type="checkbox"/> CLV <input type="checkbox"/> AOLV <input type="checkbox"/> OLV/PM <input type="checkbox"/> AOLV/PM <input type="checkbox"/> CLV/PM <input type="checkbox"/> EZOLV Configures the time for the monitor number configured with <i>H2-26</i> [Comparator 2 Monitor Selection].	0.0 s (0.0 - 600.0 s)	783
H2-40 (0B58)	Extend MFDI1 Function Selection	<input type="checkbox"/> V/f <input type="checkbox"/> CL-V/f <input type="checkbox"/> OLV <input type="checkbox"/> CLV <input type="checkbox"/> AOLV <input type="checkbox"/> OLV/PM <input type="checkbox"/> AOLV/PM <input type="checkbox"/> CLV/PM <input type="checkbox"/> EZOLV Configures the MFDO assigned to bit 0 of MEMOBUS register 15E0 (Hex.).	F (0 - 1A7)	783
H2-41 (0B59)	Extend MFDI2 Function Selection	<input type="checkbox"/> V/f <input type="checkbox"/> CL-V/f <input type="checkbox"/> OLV <input type="checkbox"/> CLV <input type="checkbox"/> AOLV <input type="checkbox"/> OLV/PM <input type="checkbox"/> AOLV/PM <input type="checkbox"/> CLV/PM <input type="checkbox"/> EZOLV Configures the MFDO assigned to bit 1 of MEMOBUS register 15E0 (Hex.).	F (0 - 1A7)	783
H2-42 (0B5A)	Extend MFDI3 Function Selection	<input type="checkbox"/> V/f <input type="checkbox"/> CL-V/f <input type="checkbox"/> OLV <input type="checkbox"/> CLV <input type="checkbox"/> AOLV <input type="checkbox"/> OLV/PM <input type="checkbox"/> AOLV/PM <input type="checkbox"/> CLV/PM <input type="checkbox"/> EZOLV Configures the MFDO assigned to bit 2 of MEMOBUS register 15E0 (Hex.).	F (0 - 1A7)	783

10.10 H: Terminal Functions

No. (Hex.)	Name	Description	Default (Range)	Ref.
H2-60 (1B46)	Terminal M1-M2 Function B Select	V/f CL-V/f OLV CLV AOLV OLV/PM AOLV/PM CLV/PM EZOLV Selects the second function for terminal M1-M2. The logical calculation results of the terminals assigned to functions by H2-01 [Terminal M1-M2 Function Select] is output.	F (0 - A7)	783
H2-61 (1B47)	Terminal M1-M2 Logical Operation	V/f CL-V/f OLV CLV AOLV OLV/PM AOLV/PM CLV/PM EZOLV Selects the logical operation for the two functions selected by H2-01 [Terminal M1-M2 Function Select] and H2-60 [Terminal M1-M2 Function B Select].	0 (0 - 8)	783
H2-62 (1B48)	Terminal M1-M2 Delay Time	V/f CL-V/f OLV CLV AOLV OLV/PM AOLV/PM CLV/PM EZOLV Configures the minimum on time used to output the logical calculation results from terminal M1-M2.	0.1 s (0.0 - 25.0 s)	783
H2-63 (1B49)	Terminal M3-M4 Function B Select	V/f CL-V/f OLV CLV AOLV OLV/PM AOLV/PM CLV/PM EZOLV Selects the second function for terminal M3-M4. The logical calculation results of the terminals assigned to functions by H2-02 [Terminal M3-M4 Function Select] is output.	F (0 - A7)	784
H2-64 (1B4A)	Terminal M3-M4 Logical Operation	V/f CL-V/f OLV CLV AOLV OLV/PM AOLV/PM CLV/PM EZOLV Selects the logical operation for the two functions selected by H2-02 [Terminal M3-M4 Function Select] and H2-63 [Terminal M3-M4 Function B Select].	0 (0 - 8)	784
H2-65 (1B4B)	Terminal M3-M4 Delay Time	V/f CL-V/f OLV CLV AOLV OLV/PM AOLV/PM CLV/PM EZOLV Configures the minimum on time used to output the logical calculation results from terminal M3-M4.	0.1 s (0.0 - 25.0 s)	784
H2-66 (1B4C)	Terminal M5-M6 Function B Select	V/f CL-V/f OLV CLV AOLV OLV/PM AOLV/PM CLV/PM EZOLV Selects the second function for terminal P1-C1. The logical calculation results of the terminals assigned to functions by H2-03 [Terminal P1-PC Function Select] is output.	F (0 - A7)	784
H2-67 (1B4D)	Terminal M5-M6 Logical Operation	V/f CL-V/f OLV CLV AOLV OLV/PM AOLV/PM CLV/PM EZOLV Selects the logical operation for the two functions selected by H2-03 [Terminal P1-PC Function Select] and H2-66 [Terminal M5-M6 Function B Select].	0 (0 - 8)	784
H2-68 (1B4E)	Terminal M5-M6 Delay Time	V/f CL-V/f OLV CLV AOLV OLV/PM AOLV/PM CLV/PM EZOLV Configures the minimum on time used to output the logical calculation results from terminal P1-C1.	0.1 s (0.0 - 25.0 s)	784
H2-69 (1B4F)	Digital Output4 Secondary Func	V/f CL-V/f OLV CLV AOLV OLV/PM AOLV/PM CLV/PM EZOLV Selects the second function for terminal P2-C2. The logical calculation results of the terminals assigned to functions by H2-04 [Terminal P2-PC Function Select] is output.	F (0 - A7)	785
H2-70 (11F9)	DigitalOutput4 Logical Operation	V/f CL-V/f OLV CLV AOLV OLV/PM AOLV/PM CLV/PM EZOLV Selects the logical operation for the two functions selected by H2-04 [Terminal P2-PC Function Select] and H2-69 [Digital Output4 Secondary Func].	0 (0 - 8)	785
H2-71 (11FA)	Digital Output 4 Delay Time	V/f CL-V/f OLV CLV AOLV OLV/PM AOLV/PM CLV/PM EZOLV Configures the minimum on time used to output the logical calculation results from terminal P2-C2.	0.1 s (0.0 - 25.0 s)	785

■ H2-xx: MFDO setting value

Setting	Function	Description	Ref.																														
0	During Run	<p>V/f CL-V/f OLV CLV AOLV OLV/PM AOLV/PM CLV/PM EZOLV</p> <p>The terminal turns on when the Run command is input or the drive is outputting voltage. ON : Drive is running OFF : Drive is stopping</p>	786																														
1	Zero Speed	<p>V/f CL-V/f OLV CLV AOLV OLV/PM AOLV/PM CLV/PM EZOLV</p> <p>The terminal turns on when the output frequency drops below the value of <i>E1-09</i> [Minimum Output Frequency] or <i>b2-01</i> [DC Injection/Zero SpeedThreshold].</p> <p>Note: The parameter used as the reference is determined by the setting of <i>A1-02</i> [Control Method Selection].</p> <table border="1"> <thead> <tr> <th>A1-02 Settings</th> <th>Description</th> <th>Parameter used as the reference</th> </tr> </thead> <tbody> <tr> <td>0</td> <td>V/f Control</td> <td><i>E1-09</i></td> </tr> <tr> <td>1</td> <td>Closed Loop V/f Control</td> <td><i>E1-09</i></td> </tr> <tr> <td>2</td> <td>Open Loop Vector Control</td> <td><i>b2-01</i></td> </tr> <tr> <td>3</td> <td>Closed Loop Vector Control</td> <td><i>E1-09</i></td> </tr> <tr> <td>4</td> <td>Advanced OpenLoop Vector Control</td> <td><i>E1-09</i></td> </tr> <tr> <td>5</td> <td>PM Open Loop Vector Control</td> <td><i>E1-09</i></td> </tr> <tr> <td>6</td> <td>PM Advanced Open Loop Vector</td> <td><i>E1-09</i></td> </tr> <tr> <td>7</td> <td>PM Closed Loop Vector Control</td> <td><i>b2-01</i></td> </tr> <tr> <td>8</td> <td>EZ Open Loop Vector Control</td> <td><i>E1-09</i></td> </tr> </tbody> </table> <p>ON : The output frequency is less than the value of <i>E1-09</i> or <i>b2-01</i>. OFF : The output frequency is the value of <i>E1-09</i> or more, or <i>b2-01</i> or more.</p>	A1-02 Settings	Description	Parameter used as the reference	0	V/f Control	<i>E1-09</i>	1	Closed Loop V/f Control	<i>E1-09</i>	2	Open Loop Vector Control	<i>b2-01</i>	3	Closed Loop Vector Control	<i>E1-09</i>	4	Advanced OpenLoop Vector Control	<i>E1-09</i>	5	PM Open Loop Vector Control	<i>E1-09</i>	6	PM Advanced Open Loop Vector	<i>E1-09</i>	7	PM Closed Loop Vector Control	<i>b2-01</i>	8	EZ Open Loop Vector Control	<i>E1-09</i>	786
A1-02 Settings	Description	Parameter used as the reference																															
0	V/f Control	<i>E1-09</i>																															
1	Closed Loop V/f Control	<i>E1-09</i>																															
2	Open Loop Vector Control	<i>b2-01</i>																															
3	Closed Loop Vector Control	<i>E1-09</i>																															
4	Advanced OpenLoop Vector Control	<i>E1-09</i>																															
5	PM Open Loop Vector Control	<i>E1-09</i>																															
6	PM Advanced Open Loop Vector	<i>E1-09</i>																															
7	PM Closed Loop Vector Control	<i>b2-01</i>																															
8	EZ Open Loop Vector Control	<i>E1-09</i>																															
2	Speed Agree 1	<p>V/f CL-V/f OLV CLV AOLV OLV/PM AOLV/PM CLV/PM EZOLV</p> <p>The terminal turns on when the output frequency is within the range of the frequency reference $\pm L4-02$ [Speed Agree Detection Width].</p> <p>Note: When using Closed Loop Vector Control, the motor speed is used as the reference. ON : The output frequency is within the range of "frequency reference $\pm L4-02$." OFF : The output frequency does not match the frequency reference even though the drive is running.</p>	787																														
3	User-set Speed Agree 1	<p>V/f CL-V/f OLV CLV AOLV OLV/PM AOLV/PM CLV/PM EZOLV</p> <p>The terminal turns on when the output frequency is within the range of <i>L4-01</i> [Speed Agree Detection Level] $\pm L4-02$ [Speed Agree Detection Width] and within the range of the frequency reference $\pm L4-02$.</p> <p>Note:</p> <ul style="list-style-type: none"> The detection function operates regardless of the direction of motor rotation. The value of <i>L4-01</i> is used as the forward/reverse detection level. When using Closed Loop Vector Control, this is the value of "Motor Speed $\pm L4-02$." <p>ON : The output frequency is within the range of "<i>L4-01</i> $\pm L4-02$" and the range of frequency reference $\pm L4-02$. OFF : The output frequency is not within the range of "<i>L4-01</i> $\pm L4-02$" or the range of frequency reference $\pm L4-02$.</p>	787																														
4	Frequency Detection 1	<p>V/f CL-V/f OLV CLV AOLV OLV/PM AOLV/PM CLV/PM EZOLV</p> <p>The terminal turns on when the output frequency is higher than the value of <i>L4-01</i> [Speed Agree Detection Level] + <i>L4-02</i> [Speed Agree Detection Width]. After the terminal turns off, the terminal continues to remain off until the output frequency reaches the level set with <i>L4-01</i>.</p> <p>Note:</p> <ul style="list-style-type: none"> The detection function operates regardless of the direction of motor rotation. The value of <i>L4-01</i> is used as the forward/reverse detection level. When using Closed Loop Vector Control, the motor speed is used as the reference. <p>ON : The output frequency is less than the value of <i>L4-01</i> or does not exceed the value of <i>L4-01</i> + <i>L4-02</i>. OFF : The output frequency exceeds the value of <i>L4-01</i> + <i>L4-02</i>.</p>	788																														

10.10 H: Terminal Functions

Setting	Function	Description	Ref.
5	Frequency Detection 2	<p>V/f CL-V/f OLV CLV AOLV OLV/PM AOLV/PM CLV/PM EZOLV</p> <p>The terminal turns on when the output frequency is higher than the setting value of <i>L4-01</i> [<i>Speed Agree Detection Level</i>]. After the terminal turns on, the terminal continues to stay on until the output frequency reaches the value of <i>L4-01</i> - <i>L4-02</i>. ON : The output frequency exceeds the value of <i>L4-01</i>. OFF : The output frequency is less than the value of “<i>L4-01</i> - <i>L4-02</i>,” or it does not exceed the value of <i>L4-01</i>.</p>	788
6	Drive Ready	<p>V/f CL-V/f OLV CLV AOLV OLV/PM AOLV/PM CLV/PM EZOLV</p> <p>The terminal turns on when the drive is in the ready state and the drive is running.</p>	788
7	DC Bus Undervoltage	<p>V/f CL-V/f OLV CLV AOLV OLV/PM AOLV/PM CLV/PM EZOLV</p> <p>The terminal turns on when the DC bus voltage or control circuit power supply drops below the voltage set with <i>L2-05</i> [<i>Undervoltage Detect Level (Uv1)</i>]. The terminal also turns on when the DC bus voltage experiences a fault. ON : The DC bus voltage has dropped below the setting value of <i>L2-05</i>. OFF : The DC bus voltage exceeds the setting value of <i>L2-05</i>.</p>	789
8	During Baseblock (N.O.)	<p>V/f CL-V/f OLV CLV AOLV OLV/PM AOLV/PM CLV/PM EZOLV</p> <p>The terminal turns on during baseblock. When the drive is in the baseblock state, the drive output transistor stops switching, and the DC bus voltage is not output. ON : During baseblock OFF : The drive is not in the baseblock state.</p>	789
9	Frequency Reference Source	<p>V/f CL-V/f OLV CLV AOLV OLV/PM AOLV/PM CLV/PM EZOLV</p> <p>Displays the frequency reference source that is currently selected. ON : The keypad is the frequency reference source. OFF : Either <i>b1-01</i> or <i>b1-15</i> [<i>Frequency Reference Selection 1 or 2</i>] is the frequency reference source.</p>	789
A	Run Command Source	<p>V/f CL-V/f OLV CLV AOLV OLV/PM AOLV/PM CLV/PM EZOLV</p> <p>Displays the Run command source that is currently selected. ON : The keypad is the Run command source. OFF : Either <i>b1-02</i> or <i>b1-16</i> [<i>Run Command Selection 1 or 2</i>] is the Run command source.</p>	789
B	Torque Detection 1 (N.O.)	<p>V/f CL-V/f OLV CLV AOLV OLV/PM AOLV/PM CLV/PM EZOLV</p> <p>The terminal turns on when an overtorque/undertorque situation is detected. ON : The output current/torque exceeds the torque value set with <i>L6-02</i> [<i>Torque Detection Level 1</i>], or the level has dropped and remained in this state longer than the time set with <i>L6-03</i> [<i>Torque Detection Time 1</i>].</p>	789
C	Frequency Reference Loss	<p>V/f CL-V/f OLV CLV AOLV OLV/PM AOLV/PM CLV/PM EZOLV</p> <p>The terminal turns on when a loss of frequency reference is detected.</p>	790
D	Braking Resistor Fault	<p>V/f CL-V/f OLV CLV AOLV OLV/PM AOLV/PM CLV/PM EZOLV</p> <p>The terminal turns on when the mounting type braking resistor is overheating or the braking transistor is experiencing a fault.</p>	790
E	Fault	<p>V/f CL-V/f OLV CLV AOLV OLV/PM AOLV/PM CLV/PM EZOLV</p> <p>The terminal turns on when the drive experiences a fault. Note: Parameters <i>CPF00</i> and <i>CPF01</i> [<i>Control Circuit Error</i>] are excluded.</p>	790
F	Through Mode	<p>V/f CL-V/f OLV CLV AOLV OLV/PM AOLV/PM CLV/PM EZOLV</p> <p>Use this setting when terminals are not used or to use terminals in through mode. This can be used as the PLC contact output via MEMOBUS/Modbus or the communication option. This signal does not function as long as signals from the PLC are not configured.</p>	790
10	Minor Fault	<p>V/f CL-V/f OLV CLV AOLV OLV/PM AOLV/PM CLV/PM EZOLV</p> <p>The terminal turns on when the drive experiences a minor fault.</p>	790
11	Fault Reset Command Active	<p>V/f CL-V/f OLV CLV AOLV OLV/PM AOLV/PM CLV/PM EZOLV</p> <p>The terminal turns on when the drive receives the reset command from the control circuit terminal, serial communications, or the communication option.</p>	790
12	Timer Output	<p>V/f CL-V/f OLV CLV AOLV OLV/PM AOLV/PM CLV/PM EZOLV</p> <p>This is configured when the timer function is used as an output terminal.</p>	790

Setting	Function	Description	Ref.
13	Speed Agree 2	<p>V/f CL-V/f OLV CLV AOLV OLV/PM AOLV/PM CLV/PM EZOLV</p> <p>The terminal turns on when the output frequency is within the range of the frequency reference $\pm L4-04$ [Speed Agree Detect Width (+/-)].</p> <p>Note:</p> <p>The motor speed is used as the reference when using Closed Loop Vector Control or Closed Loop Vector Control for PM.</p> <p>ON : The output frequency is within the range of "frequency reference $\pm L4-04$."</p> <p>OFF : The output frequency is not within the range of "frequency reference $\pm L4-04$."</p>	790
14	User-set Speed Agree 2	<p>V/f CL-V/f OLV CLV AOLV OLV/PM AOLV/PM CLV/PM EZOLV</p> <p>The terminal turns on when the output frequency is within the range of $L4-03$ [Speed Agree Detect Level (+/-)] \pm [$L4-04$ [Speed Agree Detect Width (+/-)]] and within the range of the frequency reference $\pm L4-04$.</p> <p>ON : The output frequency is within the range of "$L4-03 \pm L4-04$" and the range of the frequency reference $\pm L4-04$.</p> <p>OFF : The output frequency is not within the range of "$L4-03 \pm L4-04$" or the range of frequency reference $\pm L4-04$.</p>	791
15	Frequency Detection 3	<p>V/f CL-V/f OLV CLV AOLV OLV/PM AOLV/PM CLV/PM EZOLV</p> <p>The terminal turns off when the output frequency is higher than the value of "$L4-03$ [Speed Agree Detect Level (+/-)] + $L4-04$ [Speed Agree Detect Width (+/-)]." After the terminal turns off, the terminal continues to remain off until the output frequency reaches the level set with $L4-03$.</p> <p>Note:</p> <ul style="list-style-type: none"> The detection level configured with $L4-03$ is a signed value. Detections only occur one specific orientation. The motor speed is used as the reference when using Closed Loop Vector Control or Closed Loop Vector Control for PM. <p>ON : The output frequency is less than the value of $L4-03$ or does not exceed the value of $L4-03 + L4-04$.</p> <p>OFF : The output frequency exceeds the value of $L4-03 + L4-04$.</p>	791
16	Frequency Detection 4	<p>V/f CL-V/f OLV CLV AOLV OLV/PM AOLV/PM CLV/PM EZOLV</p> <p>The terminal turns on when the output frequency is higher than the value of $L4-03$ [Speed Agree Detect Level (+/-)]. After the terminal turns on, the terminal continues to stay on until the output frequency reaches the value of $L4-03 - L4-04$.</p> <p>ON : The output frequency exceeds the value of $L4-03$.</p> <p>OFF : The output frequency is less than the value of "$L4-03 - L4-04$," or it does not exceed the value of $L4-03$.</p>	792
17	Torque Detection 1 (N.C.)	<p>V/f CL-V/f OLV CLV AOLV OLV/PM AOLV/PM CLV/PM EZOLV</p> <p>The terminal turns off when an overtorque/undertorque situation is detected.</p> <p>OFF : The output current/torque exceeds the torque value set with $L6-02$ [Torque Detection Level 1], or the level has dropped and remained in this state longer than the time set with $L6-03$ [Torque Detection Time 1].</p>	792
18	Torque Detection 2 (N.O.)	<p>V/f CL-V/f OLV CLV AOLV OLV/PM AOLV/PM CLV/PM EZOLV</p> <p>The terminal turns on when an overtorque/undertorque situation is detected.</p> <p>ON : The output current/torque exceeds the torque value set with $L6-05$ [Torque Detection Level 2], or the level has dropped and remained in this state longer than the time set with $L6-06$ [Torque Detection Time 2].</p>	793
19	Torque Detection 2 (N.C.)	<p>V/f CL-V/f OLV CLV AOLV OLV/PM AOLV/PM CLV/PM EZOLV</p> <p>The terminal turns off when an overtorque/undertorque situation is detected.</p> <p>OFF : The output current/torque exceeds the torque value set with $L6-05$ [Torque Detection Level 2], or the level has dropped and remained in this state longer than the time set with $L6-06$ [Torque Detection Time 2].</p>	793
1A	During Reverse	<p>V/f CL-V/f OLV CLV AOLV OLV/PM AOLV/PM CLV/PM EZOLV</p> <p>The terminal turns on when the motor runs in reverse.</p> <p>ON : The motor is running in reverse.</p> <p>OFF : The motor is running forward or is stopped.</p>	793
1B	During Baseblock (N.C.)	<p>V/f CL-V/f OLV CLV AOLV OLV/PM AOLV/PM CLV/PM EZOLV</p> <p>The terminal turns off during baseblock. When the drive is in the baseblock state, the drive output transistor stops switching, and the DC bus voltage is not output.</p> <p>ON : The drive is not in the baseblock state.</p> <p>OFF : During baseblock</p>	793

10.10 H: Terminal Functions

Setting	Function	Description	Ref.
1C	Motor 2 Selection	<p>V/f CL-V/f OLV CLV AOLV OLV/PM AOLV/PM CLV/PM EZOLV</p> <p>The terminal turns on when motor 2 is selected. ON : Motor 2 Selection OFF : Motor 1 Selection</p>	794
1D	During Regeneration	<p>V/f CL-V/f OLV CLV AOLV OLV/PM AOLV/PM CLV/PM EZOLV</p> <p>The terminal turns on when the motor is regenerating. ON : Motor is regenerating. OFF : Motor is operating or stopped.</p>	794
1E	Restart Enabled	<p>V/f CL-V/f OLV CLV AOLV OLV/PM AOLV/PM CLV/PM EZOLV</p> <p>The terminal turns on when a fault that can be restarted occurs and the Auto Restart function is attempting to operate.</p>	794
1F	Motor Overload Alarm (oL1)	<p>V/f CL-V/f OLV CLV AOLV OLV/PM AOLV/PM CLV/PM EZOLV</p> <p>The terminal turns on when the electronic thermal protector value of the motor overload protective function reaches at least 90% of the detection level.</p>	794
20	Drive Overheat Pre-Alarm (oH)	<p>V/f CL-V/f OLV CLV AOLV OLV/PM AOLV/PM CLV/PM EZOLV</p> <p>The terminal turns on when the drive heatsink temperature reaches the level set with <i>L8-02 [Overheat Alarm Level]</i>.</p>	794
21	EDM	<p>V/f CL-V/f OLV CLV AOLV OLV/PM AOLV/PM CLV/PM EZOLV</p> <p>The terminal turns on (safety stop state) when the safety circuit and safety diagnosis circuit is not experiencing a failure and when both terminals H1-HC and H2-HC are off (released). ON : Safety stop state OFF : Safety circuit fault or RUN/READY</p>	794
22	Mechanical Weakening Detection	<p>V/f CL-V/f OLV CLV AOLV OLV/PM AOLV/PM CLV/PM EZOLV</p> <p>The terminal turns on when mechanical weakening is detected.</p>	795
2F	Maintenance Period	<p>V/f CL-V/f OLV CLV AOLV OLV/PM AOLV/PM CLV/PM EZOLV</p> <p>The terminal turns on when consumables reach the estimated maintenance period. Provides notification of the maintenance period for the following items.</p> <ul style="list-style-type: none"> • IGBT • Cooling fan • Capacitor • Soft charge bypass relay 	795
30	During Torque Limit	<p>V/f CL-V/f OLV CLV AOLV OLV/PM AOLV/PM CLV/PM EZOLV</p> <p>The terminal turns on when the torque reference reaches the torque limit configured with <i>L7 parameters, H3-02, H3-06, or H3-10 [Multi-Function Analog In]</i>.</p>	795
31	During speed limit	<p>V/f CL-V/f OLV CLV AOLV OLV/PM AOLV/PM CLV/PM EZOLV</p> <p>The terminal turns on when the speed limit is active.</p>	795
32	During Spd Limit inTorqueControl	<p>V/f CL-V/f OLV CLV AOLV OLV/PM AOLV/PM CLV/PM EZOLV</p> <p>The motor accelerates in forward or reverse when torque control is enabled and the torque reference externally input is disproportionate to the load. The output terminal turns on when this speed is restricted to no higher than a constant speed and the motor speed is at the speed limit. Stopped operation is excluded.</p>	795
33	Zero Servo Complete	<p>V/f CL-V/f OLV CLV AOLV OLV/PM AOLV/PM CLV/PM EZOLV</p> <p>The terminal turns on when positioning within the range defined by <i>b9-02 [Zero Servo Completion Width]</i> completes after the input of the Zero-Servo command.</p>	796
37	During Frequency Output	<p>V/f CL-V/f OLV CLV AOLV OLV/PM AOLV/PM CLV/PM EZOLV</p> <p>The terminal turns on when the drive outputs frequency. ON : The drive outputs frequency. OFF : The drive does not output frequency.</p>	796
38	Drive Enabled	<p>V/f CL-V/f OLV CLV AOLV OLV/PM AOLV/PM CLV/PM EZOLV</p> <p>This terminal turns on when the terminal allocated to <i>H1-xx = 6A [Drive Enable]</i> is turned on.</p>	796
39	Watt Hour Pulse Output	<p>V/f CL-V/f OLV CLV AOLV OLV/PM AOLV/PM CLV/PM EZOLV</p> <p>Outputs the pulse that represents the watt hours.</p>	796

Setting	Function	Description	Ref.
3C	LOCAL/REMOTE Status	V/f CL-V/f OLV CLV AOLV OLV/PM AOLV/PM CLV/PM EZOLV The terminal turns on when the Run command source or frequency reference source is LOCAL. ON : LOCAL OFF : REMOTE	796
3D	During Speed Search	V/f CL-V/f OLV CLV AOLV OLV/PM AOLV/PM CLV/PM EZOLV The terminal turns on when speed search is executing.	797
3E	PID Feedback Low	V/f CL-V/f OLV CLV AOLV OLV/PM AOLV/PM CLV/PM EZOLV The terminal turns on when <i>FbL</i> [<i>PID Feedback Loss</i>] is detected.	797
3F	PID Feedback High	V/f CL-V/f OLV CLV AOLV OLV/PM AOLV/PM CLV/PM EZOLV The terminal turns on when <i>FbH</i> [<i>Excessive PID Feedback</i>] is detected.	797
4A	During KEB Ride-Thru	V/f CL-V/f OLV CLV AOLV OLV/PM AOLV/PM CLV/PM EZOLV The terminal turns on while the KEB Ride-Thru function is being executed.	797
4B	During Short Circuit Braking	V/f CL-V/f OLV CLV AOLV OLV/PM AOLV/PM CLV/PM EZOLV The terminal turns on during Short Circuit Braking. Note: This function is enabled only when using PM motors while <i>A1-02</i> = 8 [<i>Control Method Selection = EZ Open Loop Vector Control</i>].	797
4C	During Fast Stop	V/f CL-V/f OLV CLV AOLV OLV/PM AOLV/PM CLV/PM EZOLV The terminal turns on when the fast stop is active.	797
4D	oH Pre-Alarm Time Limit	V/f CL-V/f OLV CLV AOLV OLV/PM AOLV/PM CLV/PM EZOLV The terminal turns on when <i>L8-03</i> = 4 [<i>Overheat Pre-Alarm Ope Selection = Run@L8-19 Rate</i>] and <i>oH</i> [<i>Heatsink Overheat</i>] does not clear even after the drive diminishes the frequency for 10 cycles.	798
4E	Braking Transistor Fault (rr)	V/f CL-V/f OLV CLV AOLV OLV/PM AOLV/PM CLV/PM EZOLV The terminal turns on when the braking transistor integrated into the drive overheats and <i>rr</i> [<i>Dynamic Braking Transistor</i>] is detected.	798
4F	Braking Resistor Overheat (oH)	V/f CL-V/f OLV CLV AOLV OLV/PM AOLV/PM CLV/PM EZOLV The terminal turns on when the braking resistor overheats and <i>rH</i> [<i>Braking Resistor Overheat</i>] is detected.	798
60	Internal Cooling Fan Alarm	V/f CL-V/f OLV CLV AOLV OLV/PM AOLV/PM CLV/PM EZOLV The terminal turns on when a failure is detected in the cooling fan inside the drive.	798
61	RotorPosition Detection Complete	V/f CL-V/f OLV CLV AOLV OLV/PM AOLV/PM CLV/PM EZOLV The terminal turns on when the Run command is input into the drive and the drive detects the motor magnetic pole position of the PM motor.	798
62	MEMOBUS Register 1 (H2-07&H2-08)	V/f CL-V/f OLV CLV AOLV OLV/PM AOLV/PM CLV/PM EZOLV The terminal turns on when the bit specified by <i>H2-07</i> turns on regarding the MEMOBUS register address configured with <i>H2-08</i> .	798
63	MEMOBUS Register 2 (H2-09&H2-10)	V/f CL-V/f OLV CLV AOLV OLV/PM AOLV/PM CLV/PM EZOLV The terminal turns on when the bit specified by <i>H2-10</i> turns on regarding the MEMOBUS register address configured with <i>H2-09</i> .	798
65	Standby output	V/f CL-V/f OLV CLV AOLV OLV/PM AOLV/PM CLV/PM EZOLV The terminal turns off after the drive stops operating and the time set with <i>b8-51</i> [<i>Standby Mode Wait Time</i>] elapses. ON : The Run command turns on and the magnetic contactor on the input side turns off. OFF : The Run command turns off and the drive stops operating. Then, the magnetic contactor on the input side turns off after the time set with <i>b8-51</i> [<i>Standby Mode Wait Time</i>] elapses.	798
66	Comparator1	V/f CL-V/f OLV CLV AOLV OLV/PM AOLV/PM CLV/PM EZOLV The monitor value configured with <i>H2-20</i> is on while within range of the time configured with <i>H2-24</i> and the values of <i>H2-21</i> and <i>H2-22</i> are within range.	799
67	Comparator2	V/f CL-V/f OLV CLV AOLV OLV/PM AOLV/PM CLV/PM EZOLV The monitor value configured with <i>H2-26</i> is on while within range of the time configured with <i>H2-30</i> and the values of <i>H2-27</i> and <i>H2-28</i> are within range.	799
69	External Power 24V Supply	V/f CL-V/f OLV CLV AOLV OLV/PM AOLV/PM CLV/PM EZOLV The terminal turns on when an external 24V power supply is provided between terminal PS-AC. ON : Power is supplied by an external 24V power supply. OFF : Power is not supplied by an external 24V power supply.	800

Setting	Function	Description	Ref.
90 - 92	DriveWorksEZ Digital Outputs 1 through 3	V/f CL-V/f OLV CLV AOLV OLV/PM AOLV/PM CLV/PM EZOLV Configures the digital output used by DriveWorksEZ. Refer to the DriveWorksEZ online manual for more information.	800
100 through 1A7	Inverse output of 0 through A7	V/f CL-V/f OLV CLV AOLV OLV/PM AOLV/PM CLV/PM EZOLV Generates inverse output of the function for the selected MFDO. Selects the function for which to generate inverse output with the last two digits of 1xx.	800

◆ H3: Multi-Function Analog Inputs

No. (Hex.)	Name	Description	Default (Range)	Ref.
H3-01 (0410)	Terminal A1 Signal Level Select	V/f CL-V/f OLV CLV AOLV OLV/PM AOLV/PM CLV/PM EZOLV Selects the input signal level for MFAI terminal A1. 0 : 0 to 10V (Lower Limit at 0) 1 : -10 to +10V (Bi-polar Reference) 2 : 4 to 20 mA 3 : 0 to 20 mA	0 (0 - 3)	802
H3-02 (0434)	Terminal A1 Function Selection	V/f CL-V/f OLV CLV AOLV OLV/PM AOLV/PM CLV/PM EZOLV Selects a function assigned to the MFAI terminal A1.	0 (0 - 32)	803
H3-03 (0411) RUN	Terminal A1 Gain Setting	V/f CL-V/f OLV CLV AOLV OLV/PM AOLV/PM CLV/PM EZOLV Sets the gain for the analog signal input to the MFAI terminal A1.	100.0% (-999.9 - +999.9%)	803
H3-04 (0412) RUN	Terminal A1 Bias Setting	V/f CL-V/f OLV CLV AOLV OLV/PM AOLV/PM CLV/PM EZOLV Sets the bias of the analog signal to be input to the MFAI terminal A1.	0.0% (-999.9 - +999.9%)	803
H3-05 (0413)	Terminal A3 Signal Level Select	V/f CL-V/f OLV CLV AOLV OLV/PM AOLV/PM CLV/PM EZOLV Selects the input signal level for MFAI terminal A3. 0 : 0 to 10V (Lower Limit at 0) 1 : -10 to +10V (Bi-polar Reference) 2 : 4 to 20 mA 3 : 0 to 20 mA	0 (0 - 3)	803
H3-06 (0414)	Terminal A3 Function Selection	V/f CL-V/f OLV CLV AOLV OLV/PM AOLV/PM CLV/PM EZOLV Selects the function to be set for the MFAI terminal A3.	2 (0 - 32)	804
H3-07 (0415) RUN	Terminal A3 Gain Setting	V/f CL-V/f OLV CLV AOLV OLV/PM AOLV/PM CLV/PM EZOLV Sets the gain of the analog signal to be input to the MFAI terminal A3.	100.0% (-999.9 - +999.9%)	804
H3-08 (0416) RUN	Terminal A3 Bias Setting	V/f CL-V/f OLV CLV AOLV OLV/PM AOLV/PM CLV/PM EZOLV Sets the bias of the analog signal to be input to the MFAI terminal A3.	0.0% (-999.9 - +999.9%)	804
H3-09 (0417)	Terminal A2 Signal Level Select	V/f CL-V/f OLV CLV AOLV OLV/PM AOLV/PM CLV/PM EZOLV Selects the input signal level for MFAI terminal A2. 0 : 0 to 10V (Lower Limit at 0) 1 : -10 to +10V (Bi-polar Reference) 2 : 4 to 20 mA 3 : 0 to 20 mA	2 (0 - 3)	804
H3-10 (0418)	Terminal A2 Function Selection	V/f CL-V/f OLV CLV AOLV OLV/PM AOLV/PM CLV/PM EZOLV Selects a function set to the MFAI terminal A2.	0 (0 - 32)	805
H3-11 (0419) RUN	Terminal A2 Gain Setting	V/f CL-V/f OLV CLV AOLV OLV/PM AOLV/PM CLV/PM EZOLV Sets the gain of the analog signal to be input to the MFAI terminal A2.	100.0% (-999.9 - +999.9%)	805
H3-12 (041A) RUN	Terminal A2 Bias Setting	V/f CL-V/f OLV CLV AOLV OLV/PM AOLV/PM CLV/PM EZOLV Sets the bias of the analog signal to be input to the MFAI terminal A2.	0.0% (-999.9 - +999.9%)	805

No. (Hex.)	Name	Description	Default (Range)	Ref.
H3-13 (041B)	Analog Input FilterTime Constant	V/f CL-V/f OLV CLV AOLV OLV/PM AOLV/PM CLV/PM EZOLV Sets the time constant when applying a primary delay filter to the MFAI terminal.	0.03 s (0.00 - 2.00 s)	805
H3-14 (041C)	Analog Input Terminal Enable Sel	V/f CL-V/f OLV CLV AOLV OLV/PM AOLV/PM CLV/PM EZOLV Selects the enabled terminal Sx when $H1-xx = C$ [Terminal Sx Function Selection = Analog Terminal Enable Selection] is ON. Also selects the disabled terminal Sx when the input is OFF. 1 : Terminal A1 only 2 : Terminal A2 only 3 : Terminals A1 and A2 4 : Terminal A3 only 5 : Terminals A1 and A3 6 : Terminals A2 and A3 7 : Terminals A1, A2, and A3	7 (1 - 7)	805
H3-16 (02F0)	Terminal A1 Offset	V/f CL-V/f OLV CLV AOLV OLV/PM AOLV/PM CLV/PM EZOLV Sets the offset level for the analog signal input to terminal A1. Normally there is no need to change this setting.	0 (-500 - +500)	806
H3-17 (02F1)	Terminal A2 Offset	V/f CL-V/f OLV CLV AOLV OLV/PM AOLV/PM CLV/PM EZOLV Sets the offset level for analog signals input to terminal A2. Normally there is no need to change this setting.	0 (-500 - +500)	806
H3-18 (02F2)	Terminal A3 Offset	V/f CL-V/f OLV CLV AOLV OLV/PM AOLV/PM CLV/PM EZOLV Sets the offset level for analog signals input to terminal A3. Normally there is no need to change this setting.	0 (-500 - +500)	806
H3-40 (0B5C)	Extend MFAI1 Function Selection	V/f CL-V/f OLV CLV AOLV OLV/PM AOLV/PM CLV/PM EZOLV Selects the MEMOBUS AI1 function.	F (4 - 2F)	806
H3-41 (0B5F)	Extend MFAI2 Function Selection	V/f CL-V/f OLV CLV AOLV OLV/PM AOLV/PM CLV/PM EZOLV Selects the MEMOBUS AI2 function.	F (4 - 2F)	806
H3-42 (0B62)	Extend MFAI3 Function Selection	V/f CL-V/f OLV CLV AOLV OLV/PM AOLV/PM CLV/PM EZOLV Selects the MEMOBUS AI3 function.	F (4 - 2F)	807
H3-43 (117F)	Filter Time for MFAI	V/f CL-V/f OLV CLV AOLV OLV/PM AOLV/PM CLV/PM EZOLV Sets the time constant when applying a primary delay filter to the MEMOBUS analog input terminal.	0.00 s (0.00 to 2.00 s)	807

■ H3-xx: Multi-Function Analog In Setting Value

Setting	Function	Description	Ref.
0	Frequency BiasMaster frequency reference	V/f CL-V/f OLV CLV AOLV OLV/PM AOLV/PM CLV/PM EZOLV The input value from the analog input terminal set with this function becomes the master frequency reference.	807
1	Frequency Gain	V/f CL-V/f OLV CLV AOLV OLV/PM AOLV/PM CLV/PM EZOLV The input value from the analog input terminal set with this function is multiplied by the analog frequency reference.	807
2	Auxiliary Frequency Reference 1	V/f CL-V/f OLV CLV AOLV OLV/PM AOLV/PM CLV/PM EZOLV When Reference 2 is selected via multi-step speed reference, the command reference (Auxiliary Frequency Reference 1) from the analog input terminal set with this setting is enabled. Set E1-04 [Maximum Output Frequency] as 100%.	807
3	Auxiliary Frequency Reference 2	V/f CL-V/f OLV CLV AOLV OLV/PM AOLV/PM CLV/PM EZOLV When Reference 3 is selected via multi-step speed reference, the command reference (Auxiliary Frequency Reference 2) from the analog input terminal set with this setting is enabled. Set E1-04 [Maximum Output Frequency] as 100%.	807
4	Output Voltage Bias	V/f CL-V/f OLV CLV AOLV OLV/PM AOLV/PM CLV/PM EZOLV Set this parameter to input a bias signal that amplifies the output voltage.	808
5	Accel/Decel Time Gain	V/f CL-V/f OLV CLV AOLV OLV/PM AOLV/PM CLV/PM EZOLV Inputs the signal that adjusts the gain used for C1-01 through C1-08 [Accel & Decel Time 1 through 4] assuming that the full scale analog signal (10 V or 20 mA) is 100%.	808
6	DC Injection Braking Current	V/f CL-V/f OLV CLV AOLV OLV/PM AOLV/PM CLV/PM EZOLV Inputs the signal that adjusts the current level used for DC Injection Braking assuming that the drive rated output current is 100%.	808

10.10 H: Terminal Functions

Setting	Function	Description	Ref.
7	Overtorque/ Undertorque DetectLvl	V/f CL-V/f OLV CLV AOLV OLV/PM AOLV/PM CLV/PM EZOLV Inputs the signal that adjusts the overtorque/undertorque detection level. Note: Use this function in conjunction with L6-01 [Torque Detection Selection 1]. This parameter functions in place of L6-02 [Torque Detection Level 1].	809
8	Stall Prevention Level DuringRun	V/f CL-V/f OLV CLV AOLV OLV/PM AOLV/PM CLV/PM EZOLV Inputs the signal that adjusts the stall prevention level during run assuming that the drive rated current is 100%.	809
9	Output Freq Lower Limit Level	V/f CL-V/f OLV CLV AOLV OLV/PM AOLV/PM CLV/PM EZOLV Inputs the signal that adjusts the output frequency lower limit level assuming that E1-04 [Maximum Output Frequency] is 100%.	809
B	PID Feedback	V/f CL-V/f OLV CLV AOLV OLV/PM AOLV/PM CLV/PM EZOLV Inputs the PID feedback value.	809
C	PID Setpoint	V/f CL-V/f OLV CLV AOLV OLV/PM AOLV/PM CLV/PM EZOLV Inputs the PID setpoint.	810
D	Frequency Bias	V/f CL-V/f OLV CLV AOLV OLV/PM AOLV/PM CLV/PM EZOLV Inputs the bias value added to the frequency reference assuming that E1-04 [Maximum Output Frequency] is 100%.	810
E	Motor Temperature (PTC input)	V/f CL-V/f OLV CLV AOLV OLV/PM AOLV/PM CLV/PM EZOLV Uses the motor Positive Temperature Coefficient (PLC) thermistor to protect the motor from heat on the basis that the current value at the time the 10 V (or 20 mA) analog signal is input is 100%.	810
F	Through Mode	V/f CL-V/f OLV CLV AOLV OLV/PM AOLV/PM CLV/PM EZOLV Use this setting when terminals are not used or to use terminals in through mode.	810
10	Forward Torque Limit	V/f CL-V/f OLV CLV AOLV OLV/PM AOLV/PM CLV/PM EZOLV Inputs the forward torque limit assuming that the motor rated torque is 100%.	810
11	Reverse Torque Limit	V/f CL-V/f OLV CLV AOLV OLV/PM AOLV/PM CLV/PM EZOLV Inputs the load torque limit assuming that the motor rated torque is 100%.	811
12	Regenerative Torque Limit	V/f CL-V/f OLV CLV AOLV OLV/PM AOLV/PM CLV/PM EZOLV Inputs the regenerative torque limit assuming that the motor rated torque is 100%.	812
13	Torque Reference / Torque Limit	V/f CL-V/f OLV CLV AOLV OLV/PM AOLV/PM CLV/PM EZOLV Inputs the torque reference assuming that the motor rated torque is 100%. This parameter operates as the torque limit for speed control.	812
14	Torque Compensation	V/f CL-V/f OLV CLV AOLV OLV/PM AOLV/PM CLV/PM EZOLV Inputs the torque compensation value assuming that the motor rated torque is 100%.	812
15	General Torque Limit	V/f CL-V/f OLV CLV AOLV OLV/PM AOLV/PM CLV/PM EZOLV Inputs the torque limit common to all quadrants for forward, reverse, and regenerative operation assuming that the motor rated torque is 100%.	812
16	Differential PID Feedback	V/f CL-V/f OLV CLV AOLV OLV/PM AOLV/PM CLV/PM EZOLV Inputs the PID differential feedback value assuming that the full scale analog signal (10 V or 20 mA) is 100%.	812
1F	Through Mode	V/f CL-V/f OLV CLV AOLV OLV/PM AOLV/PM CLV/PM EZOLV Use this setting when terminals are not used or to use terminals in through mode.	812
30	DriveWorksEZ analog input 1	V/f CL-V/f OLV CLV AOLV OLV/PM AOLV/PM CLV/PM EZOLV Used with DriveWorksEZ. Refer to the DriveWorksEZ Online Manual for more information.	812
31	DriveWorksEZ analog input 2	V/f CL-V/f OLV CLV AOLV OLV/PM AOLV/PM CLV/PM EZOLV Used with DriveWorksEZ. Refer to the DriveWorksEZ Online Manual for more information.	812
32	DriveWorksEZ analog input 3	V/f CL-V/f OLV CLV AOLV OLV/PM AOLV/PM CLV/PM EZOLV Used with DriveWorksEZ. Refer to the DriveWorksEZ Online Manual for more information.	813

◆ H4: Analog Outputs

No. (Hex.)	Name	Description	Default (Range)	Ref.
H4-01 (041D)	Terminal FM Analog Output Select	<p>V/f CL-V/f OLV CLV AOLV OLV/PM AOLV/PM CLV/PM EZOLV</p> <p>Sets the monitoring number to be output from multi-function analog output terminal FM.</p> <p>Set the x-xx portion of the monitoring parameter <i>Ux-xx</i>. For example, set x-xx to 102 to monitor <i>U1-02 [Output Frequency]</i>.</p>	102 (000 - 999)	814
H4-02 (041E) RUN	Terminal FM Analog Output Gain	<p>V/f CL-V/f OLV CLV AOLV OLV/PM AOLV/PM CLV/PM EZOLV</p> <p>Sets the gain of the monitoring signal that is output from the MFAO terminal FM as a percentage. Set the terminal FM output signal level when an output of 0% for monitoring items is 0 V (or 4 mA) and when an output for monitoring items is 100%, and sets 10 V (or 20 mA) as 100%.</p>	100.0% (-999.9 - 999.9%)	814
H4-03 (041F) RUN	Terminal FM Analog Output Bias	<p>V/f CL-V/f OLV CLV AOLV OLV/PM AOLV/PM CLV/PM EZOLV</p> <p>Sets the bias of the monitoring signal that is output from the MFAO terminal FM as a percentage. Set the level of the analog signal output from the FM terminal at 10 V (or 20 mA) as 100% when an output for monitoring items is 0%.</p>	0.0% (-999.9 - 999.9%)	815
H4-04 (0420)	Terminal AM Analog Output Select	<p>V/f CL-V/f OLV CLV AOLV OLV/PM AOLV/PM CLV/PM EZOLV</p> <p>Sets the monitoring number to be output from the MFAO terminal AM.</p> <p>Set the x-xx portion of the monitoring parameter <i>Ux-xx</i>. For example, set x-xx to 102 to monitor <i>U1-02 [Output Frequency]</i>.</p>	103 (000 - 999)	815
H4-05 (0421) RUN	Terminal AM Analog Output Gain	<p>V/f CL-V/f OLV CLV AOLV OLV/PM AOLV/PM CLV/PM EZOLV</p> <p>Sets the gain of the monitor signal that is output from the MFAO terminal AM as a percentage. Sets the level of the analog signal output from the AM terminal when an output of 0% for monitoring items is 0 V (or 4 mA) and when an output for monitoring items is 100%, and sets 10 V (or 20 mA) as 100%.</p>	50.0% (-999.9 - 999.9%)	815
H4-06 (0422) RUN	Terminal AM Analog Output Bias	<p>V/f CL-V/f OLV CLV AOLV OLV/PM AOLV/PM CLV/PM EZOLV</p> <p>Sets the bias of the monitoring signal that is output from the MFAO terminal AM as a percentage. Set the level of the analog signal output from the AM terminal at 10 V (or 20 mA) as 100% when an output for monitoring items is 0%.</p>	0.0% (-999.9 - 999.9%)	815
H4-07 (0423)	Terminal FM Signal Level Select	<p>V/f CL-V/f OLV CLV AOLV OLV/PM AOLV/PM CLV/PM EZOLV</p> <p>Selects the output signal level from the MFAO terminal FM.</p> <p>Note: Set jumper S5 on the terminal board accordingly when changing these parameters. 0 : 0 to 10 Vdc 1 : -10 to +10 Vdc 2 : 4 to 20 mA</p>	0 (0 - 2)	816
H4-08 (0424)	Terminal AM Signal Level Select	<p>V/f CL-V/f OLV CLV AOLV OLV/PM AOLV/PM CLV/PM EZOLV</p> <p>Selects the signal level output from the MFAO terminal AM.</p> <p>Note: Set jumper S5 on the terminal board accordingly when changing these parameters. 0 : 0 to 10 Vdc 1 : -10 to +10 Vdc 2 : 4 to 20 mA</p>	0 (0 - 2)	816
H4-20 (0B53)	Output power monitor level	<p>V/f CL-V/f OLV CLV AOLV OLV/PM AOLV/PM CLV/PM EZOLV</p> <p>Sets the level at 10 V when <i>U1-08 [Output Power]</i> executes analog output.</p>	0.00 kW (0.00 - 650.00 kW)	816

◆ H5: MEMOBUS/Modbus Communication

No. (Hex.)	Name	Description	Default (Range)	Ref.
H5-01 (0425)	Drive Node Address	<p>V/f CL-V/f OLV CLV AOLV OLV/PM AOLV/PM CLV/PM EZOLV</p> <p>Sets the communication slave address for drives.</p> <p>Note:</p> <ul style="list-style-type: none"> Restart the drive to enable the settings. Setting the parameter to 0 will cause the drive to stop responding to MEMOBUS/Modbus communications. 	1FH (0 - FFH)	816
H5-02 (0426)	Communication Speed Selection	<p>V/f CL-V/f OLV CLV AOLV OLV/PM AOLV/PM CLV/PM EZOLV</p> <p>Selects the communications speed for MEMOBUS/Modbus communications.</p> <p>Note:</p> <p>Restart the drive to enable the settings.</p> <p>0 : 1200 bps 1 : 2400 bps 2 : 4800 bps 3 : 9600 bps 4 : 19.2 kbps 5 : 38.4 kbps 6 : 57.6 kbps 7 : 76.8 kbps 8 : 115.2 kbps</p>	3 (0 - 8)	817
H5-03 (0427)	Communication Parity Selection	<p>V/f CL-V/f OLV CLV AOLV OLV/PM AOLV/PM CLV/PM EZOLV</p> <p>Selects the communications parity used for MEMOBUS/Modbus communications.</p> <p>Note:</p> <p>Restart the drive to enable the settings.</p> <p>0 : No parity 1 : Even parity 2 : Odd parity</p>	0 (0 - 2)	817
H5-04 (0428)	Stopping Method after Com Error	<p>V/f CL-V/f OLV CLV AOLV OLV/PM AOLV/PM CLV/PM EZOLV</p> <p>Selects the motor Stopping Method when <i>CE [MEMOBUS/Modbus Communication Err]</i> issues are detected.</p> <p>0 : Ramp to stop 1 : Coast to stop 2 : Fast Stop (use C1-09) 3 : Alarm only</p>	3 (0 - 3)	817
H5-05 (0429)	Comm Fault Detection Select	<p>V/f CL-V/f OLV CLV AOLV OLV/PM AOLV/PM CLV/PM EZOLV</p> <p>Selects whether to detect <i>CE [MEMOBUS/Modbus Communication Err]</i> issues during MEMOBUS/Modbus communications.</p> <p>0 : Disabled 1 : Enabled</p>	1 (0, 1)	818
H5-06 (042A)	Drive Transmit Wait Time	<p>V/f CL-V/f OLV CLV AOLV OLV/PM AOLV/PM CLV/PM EZOLV</p> <p>Sets the time to wait to send a response message after the drive receives a command message from the master.</p> <p>Note:</p> <p>Restart the drive to enable the settings.</p>	5 ms (0 - 65 ms)	818
H5-09 (0435)	CE Detection Time	<p>V/f CL-V/f OLV CLV AOLV OLV/PM AOLV/PM CLV/PM EZOLV</p> <p>Sets the detection time for <i>CE [MEMOBUS/Modbus Communication Err]</i> issues when communication is disrupted.</p>	2.0 s (0.0 - 10.0 s)	818
H5-10 (0436)	Unit Sel for MEMOBUS/Modbus 0025H	<p>V/f CL-V/f OLV CLV AOLV OLV/PM AOLV/PM CLV/PM EZOLV</p> <p>Selects the unit of measure used for the MEMOBUS/Modbus communications monitor register 0025H (output voltage reference monitor).</p> <p>0 : 0.1 V units 1 : 1 V units</p>	0 (0, 1)	818

No. (Hex.)	Name	Description	Default (Range)	Ref.
H5-11 (043C)	Communications ENTER Func Select	V/f CL-V/f OLV CLV AOLV OLV/PM AOLV/PM CLV/PM EZOLV Selects whether or not the Enter command is required to change parameters via MEMOBUS/Modbus communications. 0 : Enter Required 1 : No EnterRequired	0 (0, 1)	818
H5-12 (043D)	Run Command Method Selection	V/f CL-V/f OLV CLV AOLV OLV/PM AOLV/PM CLV/PM EZOLV Selects the input method for the Run command when <i>b1-02</i> or <i>b1-16</i> [<i>Run Command Selection</i>] are set to 2 [<i>MEMOBUS/Modbus Communications</i>]. 0 : FWD/Stop, REV/Stop 1 : Run/Stop, FWD/REV	0 (0, 1)	819
H5-17 (11A1)	Busy Enter Selection	V/f CL-V/f OLV CLV AOLV OLV/PM AOLV/PM CLV/PM EZOLV Selects the operation when the EEPROM write command is output without EEPROM write available. Normally there is no need to change this setting. 0 : Cannot write into EEPROM 1 : Write in RAM only	0 (0, 1)	819
H5-18 (11A2)	MtrSpd Monitor T	V/f CL-V/f OLV CLV AOLV OLV/PM AOLV/PM CLV/PM EZOLV Sets the filter time constant used when monitoring the motor speed during MEMOBUS/Modbus communications or use of the communication option.	0 ms (0 - 100 ms)	819
H5-20 (0B57)	Comm. Parameters Activation Sel	V/f CL-V/f OLV CLV AOLV OLV/PM AOLV/PM CLV/PM EZOLV Updated MEMOBUS/Modbus communications parameters can take effect immediately after the update. 0 : Enabled when the drive is restarted. 1 : Enabled as soon as the setting value is changed.	0 (0, 1)	819

◆ H6: Pulse Train Input/Output

No. (Hex.)	Name	Description	Default (Range)	Ref.
H6-01 (042C)	PulseTrain InTerm RP Func Select	V/f CL-V/f OLV CLV AOLV OLV/PM AOLV/PM CLV/PM EZOLV Selects a function of the pulse train input terminal RP. 0 : Frequency reference 1 : PID feedback value 2 : PID setpoint value 3 : PG Feedback	0 (0 - 3)	820
H6-02 (042D) RUN	Pulse Train Input Scaling	V/f CL-V/f OLV CLV AOLV OLV/PM AOLV/PM CLV/PM EZOLV Sets the frequency of the pulse train input signal used when the item selected with <i>H6-01</i> [<i>PulseTrain InTerm RP Func Select</i>] is input at 100%.	1440 Hz (100 - 32000 Hz)	821
H6-03 (042E) RUN	Pulse Train Input Gain	V/f CL-V/f OLV CLV AOLV OLV/PM AOLV/PM CLV/PM EZOLV Sets the gain used when the item configured with <i>H6-01</i> [<i>PulseTrain InTerm RP Func Select</i>] is input to terminal RP.	100.0% (0.0 - 1000.0%)	821
H6-04 (042F) RUN	Pulse Train Input Bias	V/f CL-V/f OLV CLV AOLV OLV/PM AOLV/PM CLV/PM EZOLV Sets the bias used when the item configured with <i>H6-01</i> [<i>PulseTrain InTerm RP Func Select</i>] is input to terminal RP. Sets a value at the time when the pulse train is 0 Hz.	0.0% (-100.0 - 100.0%)	821
H6-05 (0430) RUN	Pulse Train Input Filter Time	V/f CL-V/f OLV CLV AOLV OLV/PM AOLV/PM CLV/PM EZOLV Sets the primary delay filter time constant for the pulse train input.	0.10 s (0.00 – 2.00 s)	822
H6-06 (0431) RUN	Pulse Train Monitor Selection	V/f CL-V/f OLV CLV AOLV OLV/PM AOLV/PM CLV/PM EZOLV Selects a function for the pulse train monitor output terminal MP. Inputs the "x-xx" portion of the <i>Ux-xx</i> parameter to be monitored.	102 (000, 031, 101, 102, 105, 116, 501, 502, and 801 through 809)	822

No. (Hex.)	Name	Description	Default (Range)	Ref.
H6-07 (0432) RUN	Pulse Train Monitor Scaling	V/f CL-V/f OLV CLV AOLV OLV/PM AOLV/PM CLV/PM EZOLV Sets the frequency of the pulse train output signal used when the item selected with H6-06 [Pulse Train Monitor Selection] is output at 100%.	1440 Hz (0 - 32000 Hz)	822
H6-08 (043F)	Pulse Train Input Min Frequency	V/f CL-V/f OLV CLV AOLV OLV/PM AOLV/PM CLV/PM EZOLV Sets the minimum frequency of the pulse train signal detectable by terminal RP in units of 0.1 Hz.	0.5 Hz (0.1 - 1000.0 Hz)	823

◆ H7: Virtual Multi-Function I/O

No. (Hex.)	Name	Description	Default (Range)	Ref.
H7-00 (116F)	Virtual MFIO selection	V/f CL-V/f OLV CLV AOLV OLV/PM AOLV/PM CLV/PM EZOLV Enables or disables the virtual I/O function. If enable is not set, the virtual I/O function will not operate. 0 : Disabled 1 : Enabled	0 (0, 1)	823
H7-01 (1185)	Virtual Multi-Function Input 1	V/f CL-V/f OLV CLV AOLV OLV/PM AOLV/PM CLV/PM EZOLV Selects the function that enters the virtual input selected with the H7-10 [Virtual Multi-Function Output 1].	F (0 - 19F)	824
H7-02 (1186)	Virtual Multi-Function Input 2	V/f CL-V/f OLV CLV AOLV OLV/PM AOLV/PM CLV/PM EZOLV Selects the function that enters the virtual input selected with the H7-12 [Virtual Multi-Function Output 2].	F (0 - 19F)	824
H7-03 (1187)	Virtual Multi-Function Input 3	V/f CL-V/f OLV CLV AOLV OLV/PM AOLV/PM CLV/PM EZOLV Selects the function that enters the virtual input selected with H7-14 [Virtual Multi-Function Output 3].	F (0 - 19F)	824
H7-04 (1188)	Virtual Multi-Function Input 4	V/f CL-V/f OLV CLV AOLV OLV/PM AOLV/PM CLV/PM EZOLV Selects the function that enters the virtual input selected with the H7-16 [Virtual Multi-Function Output 4].	F (0 - 19F)	824
H7-10 (11A4)	Virtual Multi-Function Output 1	V/f CL-V/f OLV CLV AOLV OLV/PM AOLV/PM CLV/PM EZOLV Selects the function for virtual digital output 1.	F (0 - 1A7)	824
H7-11 (11A5)	Virtual Output 1 Delay Time	V/f CL-V/f OLV CLV AOLV OLV/PM AOLV/PM CLV/PM EZOLV Sets the minimum ON time for virtual digital output 1.	0.1 s (0.0 - 25.0 s)	824
H7-12 (11A6)	Virtual Multi-Function Output 2	V/f CL-V/f OLV CLV AOLV OLV/PM AOLV/PM CLV/PM EZOLV Selects the function for virtual digital output 2.	F (0 - 1A7)	824
H7-13 (11A7)	Virtual Output 2 Delay Time	V/f CL-V/f OLV CLV AOLV OLV/PM AOLV/PM CLV/PM EZOLV Sets the minimum ON time for virtual digital output 2.	0.1 s (0.0 - 25.0 s)	825
H7-14 (11A8)	Virtual Multi-Function Output 3	V/f CL-V/f OLV CLV AOLV OLV/PM AOLV/PM CLV/PM EZOLV Selects the function for virtual digital output 3.	F (0 - 1A7)	825
H7-15 (11A9)	Virtual Output 3 Delay Time	V/f CL-V/f OLV CLV AOLV OLV/PM AOLV/PM CLV/PM EZOLV Sets the minimum ON time for virtual digital output 3.	0.1 s (0.0 - 25.0 s)	825
H7-16 (11AA)	Virtual Multi-Function Output 4	V/f CL-V/f OLV CLV AOLV OLV/PM AOLV/PM CLV/PM EZOLV Selects the function for virtual digital output 4.	F (0 - 1A7)	825
H7-17 (11AB)	Virtual Output 4 Delay Time	V/f CL-V/f OLV CLV AOLV OLV/PM AOLV/PM CLV/PM EZOLV Sets the minimum ON time for virtual digital output 4.	0.1 s (0.0 - 25.0 s)	825
H7-30 (1177)	Virtual Analog Input Selection	V/f CL-V/f OLV CLV AOLV OLV/PM AOLV/PM CLV/PM EZOLV Sets the virtual analog input function.	F (0 - 41)	825
H7-31 (1178) RUN	Virtual Analog Input Gain	V/f CL-V/f OLV CLV AOLV OLV/PM AOLV/PM CLV/PM EZOLV Sets the virtual analog input gain.	100.0% (-999.9 - 999.9%)	825
H7-32 (1179) RUN	Virtual Analog Input Bias	V/f CL-V/f OLV CLV AOLV OLV/PM AOLV/PM CLV/PM EZOLV Sets the virtual analog input bias.	0.0% (-999.9 - 999.9%)	825

No. (Hex.)	Name	Description	Default (Range)	Ref.
H7-40 (1163)	Virtual Analog Out Signal Select	<p>V/f CL-V/f OLV CLV AOLV OLV/PM AOLV/PM CLV/PM EZOLV</p> <p>Selects the signal level of the virtual analog output. 0 : 0 ~ 100%(Absolute value) 1 : -10 +10 VDC 2 : 0-10 VDC</p>	0 (0 - 2)	826
H7-41 (1164)	Virtual Analog Output Function	<p>V/f CL-V/f OLV CLV AOLV OLV/PM AOLV/PM CLV/PM EZOLV</p> <p>Sets the monitoring number to be output from the virtual analog output. Set the x-xx portion of the monitoring parameter Ux-xx. For example, set x-xx to 102 to monitor U1-02 [Output Frequency].</p>	102 (0 - 999)	826
H7-42 (1165)	Virtual Analog Output FilterTime	<p>V/f CL-V/f OLV CLV AOLV OLV/PM AOLV/PM CLV/PM EZOLV</p> <p>Sets the time constant for a primary filter of the virtual analog output.</p>	0.00 s (0.00 to 2.00 s)	826

10.11 L: Protection Function

◆ L1: Motor Protection

No. (Hex.)	Name	Description	Default Setting (Range)	Ref.
L1-01 (0480)	Motor Overload (oL1) Protection	<p><input type="checkbox"/> V/f <input type="checkbox"/> CL-V/f <input type="checkbox"/> OLV <input type="checkbox"/> CLV <input type="checkbox"/> AOLV <input type="checkbox"/> OLV/PM <input type="checkbox"/> AOLV/PM <input type="checkbox"/> CLV/PM <input type="checkbox"/> EZOLV</p> <p>Enables or disables the motor overload protection using electronic thermal protectors.</p> <p>0 : Disabled 1 : Variable Torque 2 : Constant Torque 10:1 Speed Range 3 : Constant Torque 100:1 SpeedRange 4 : PM Variable Torque 5 : PM Constant Torque 6 : Variable Torque (50Hz)</p> <p>Note: Set L1-01 = 1 to 6 [Enabled] when only one motor is connected to a drive. External thermal relays are not necessary in such cases.</p>	Determined by A1-02 (0 - 6)	219
L1-02 (0481)	Motor Overload (oL1) Protection	<p><input type="checkbox"/> V/f <input type="checkbox"/> CL-V/f <input type="checkbox"/> OLV <input type="checkbox"/> CLV <input type="checkbox"/> AOLV <input type="checkbox"/> OLV/PM <input type="checkbox"/> AOLV/PM <input type="checkbox"/> CLV/PM <input type="checkbox"/> EZOLV</p> <p>Sets the operation time for the electronic thermal protector of the drive to protect the motor. Normally there is no need to change this setting.</p>	1.0 min (0.1 - 5.0 min)	222
L1-03 (0482)	Motor OH Alarm Operation Select	<p><input type="checkbox"/> V/f <input type="checkbox"/> CL-V/f <input type="checkbox"/> OLV <input type="checkbox"/> CLV <input type="checkbox"/> AOLV <input type="checkbox"/> OLV/PM <input type="checkbox"/> AOLV/PM <input type="checkbox"/> CLV/PM <input type="checkbox"/> EZOLV</p> <p>Selects the drive operation when the PTC input signal input into the drive reaches the detection level of oH3 [Motor Overheat Alarm].</p> <p>0 : Ramp to stop 1 : Coast to stop 2 : Fast Stop (use C1-09) 3 : Alarm only</p>	3 (0 - 3)	222
L1-04 (0483)	Motor OH Fault Operation Select	<p><input type="checkbox"/> V/f <input type="checkbox"/> CL-V/f <input type="checkbox"/> OLV <input type="checkbox"/> CLV <input type="checkbox"/> AOLV <input type="checkbox"/> OLV/PM <input type="checkbox"/> AOLV/PM <input type="checkbox"/> CLV/PM <input type="checkbox"/> EZOLV</p> <p>Selects the drive operation when the PTC input signal input into the drive reaches the detection level of oH4 [Motor Overheat Failure].</p> <p>0 : Ramp to stop 1 : Coast to stop 2 : Fast Stop</p>	1 (0 - 2)	223
L1-05 (0484)	Motor Temp Input Filter Time	<p><input type="checkbox"/> V/f <input type="checkbox"/> CL-V/f <input type="checkbox"/> OLV <input type="checkbox"/> CLV <input type="checkbox"/> AOLV <input type="checkbox"/> OLV/PM <input type="checkbox"/> AOLV/PM <input type="checkbox"/> CLV/PM <input type="checkbox"/> EZOLV</p> <p>Sets the primary delay time constant for the PTC input signal input to the drive. This parameter is used to prevent accidental detections of motor overheat fault.</p>	0.20 s (0.00 - 10.00 s)	832
L1-08 (1103)	oL1 Current Level	<p><input type="checkbox"/> V/f <input type="checkbox"/> CL-V/f <input type="checkbox"/> OLV <input type="checkbox"/> CLV <input type="checkbox"/> AOLV <input type="checkbox"/> OLV/PM <input type="checkbox"/> AOLV/PM <input type="checkbox"/> CLV/PM <input type="checkbox"/> EZOLV</p> <p>Sets the reference current for motor thermal overload detection for motor 1 in amperes.</p> <p>Note: Cannot be set to a value smaller than 10% of drive rated current when the current level is set to a value greater than 0.0 A.</p>	0.0 A (0.0 A or 10% to 150% of the drive rated current)	832
L1-09 (1104)	oL1 Current Level for Motor 2	<p><input type="checkbox"/> V/f <input type="checkbox"/> CL-V/f <input type="checkbox"/> OLV <input type="checkbox"/> CLV <input type="checkbox"/> AOLV <input type="checkbox"/> OLV/PM <input type="checkbox"/> AOLV/PM <input type="checkbox"/> CLV/PM <input type="checkbox"/> EZOLV</p> <p>Sets the current value used as the reference for detecting the motor overload state regarding the motor 2 electronic thermal protector.</p> <p>Note: Values greater than 0.0 A and less than 10% of the drive rated current cannot be set.</p>	0.0 A (0.0 A or 10 to 150% of the drive rated current)	833
L1-13 (046D)	Cont Electrothermal Ope Select	<p><input type="checkbox"/> V/f <input type="checkbox"/> CL-V/f <input type="checkbox"/> OLV <input type="checkbox"/> CLV <input type="checkbox"/> AOLV <input type="checkbox"/> OLV/PM <input type="checkbox"/> AOLV/PM <input type="checkbox"/> CLV/PM <input type="checkbox"/> EZOLV</p> <p>Selects whether to retain the current electronic thermal protector value when the power supply is interrupted.</p> <p>0 : Disabled 1 : Enabled</p>	1 (0, 1)	833

◆ L2: Momentary Power Loss Ride-Thru

No. (Hex.)	Name	Description	Default (Range)	Ref.
L2-01 (0485)	Momentary Power Loss Ope Select	<p>V/f CL-V/f OLV CLV AOLV OLV/PM AOLV/PM CLV/PM EZOLV</p> <p>Selects the drive operation performed when a momentary power loss occurs.</p> <p>0 : Disabled 1 : Enbl with Timer 2 : Enbl whl CPU act 3 : KEB Mode 4 : KEB Stop Mode 5 : KEB Decel to Stp</p>	0 (0 - 5)	838
L2-02 (0486)	Momentary Power Loss Ride-Thru Time	<p>V/f CL-V/f OLV CLV AOLV OLV/PM AOLV/PM CLV/PM EZOLV</p> <p>Sets the maximum time allowed to ride through a power loss until the drive restart is compensated.</p>	Determined by o2-04 and C6-01 (0.0 - 25.5 s)	840
L2-03 (0487)	Momentary Power Loss Min BB Time	<p>V/f CL-V/f OLV CLV AOLV OLV/PM AOLV/PM CLV/PM EZOLV</p> <p>Sets the minimum baseblock time when power is restored following a momentary power loss.</p>	Determined by o2-04 and C6-01 (0.1 - 5.0 s)	840
L2-04 (0488)	Momentary Power Loss Vol Recovery Ramp Time	<p>V/f CL-V/f OLV CLV AOLV OLV/PM AOLV/PM CLV/PM EZOLV</p> <p>Sets the time for the drive output voltage to return to normal voltage after completion of speed searches.</p>	Determined by o2-04 and C6-01 (0.0 - 5.0 s)	840
L2-05 (0489)	Undervoltage Detect Level (Uv1)	<p>V/f CL-V/f OLV CLV AOLV OLV/PM AOLV/PM CLV/PM EZOLV</p> <p>Determines the voltage at which a <i>Uv1 [DC Bus Undervoltage]</i> fault is triggered or at which the KEB function is activated. Normally there is no need to change this setting.</p> <p>Note: Install an AC reactor option on the input side of the power supply when setting undervoltage detection level below the default value to prevent damage to drive circuitry.</p>	Determined by E1-01 (Determined by E1-01)	840
L2-06 (048A)	KEB Deceleration Time	<p>V/f CL-V/f OLV CLV AOLV OLV/PM AOLV/PM CLV/PM EZOLV</p> <p>Sets the deceleration time during KEB operation used to reduce the maximum output frequency to 0.</p>	0.0 s (0.0 to 6,000.0 s)	840
L2-07 (048B)	KEB Acceleration Time	<p>V/f CL-V/f OLV CLV AOLV OLV/PM AOLV/PM CLV/PM EZOLV</p> <p>Sets the acceleration time used for the frequency to return to the frequency reference in effect before a power loss after the KEB operation is canceled.</p>	0.0 s (0.0 to 6000.0 s)	841
L2-08 (048C)	Frequency Gain at KEB Start	<p>V/f CL-V/f OLV CLV AOLV OLV/PM AOLV/PM CLV/PM EZOLV</p> <p>Sets the amount of output frequency reduction used when KEB operation starts, as a percentage of the motor rated slip before KEB operation startup.</p>	100% (0 - 300%)	841
L2-09 (048D)	KEB Minimum Frequency Level	<p>V/f CL-V/f OLV CLV AOLV OLV/PM AOLV/PM CLV/PM EZOLV</p> <p>Sets the amount of output frequency reduction used when KEB operation starts, as a percentage of the motor rated slip.</p>	20% (0 - 100%)	841
L2-10 (048E)	KEB Detect Time (Min KEB Time)	<p>V/f CL-V/f OLV CLV AOLV OLV/PM AOLV/PM CLV/PM EZOLV</p> <p>Sets the minimum duration to operate the KEB after a momentary power loss is detected.</p>	50 ms (0 - 25500 ms)	842
L2-11 (0461)	DC Bus Vol Setpoint during KEB	<p>V/f CL-V/f OLV CLV AOLV OLV/PM AOLV/PM CLV/PM EZOLV</p> <p>Sets the target value used to control the DC bus voltage to a constant level in Single Drive KEB Ride-Thru 2. Sets the DC bus voltage level used to complete the KEB operation for all other KEB methods.</p>	Determined by E1-01 (Determined by E1-01)	842
L2-29 (0475)	KEB Method Selection	<p>V/f CL-V/f OLV CLV AOLV OLV/PM AOLV/PM CLV/PM EZOLV</p> <p>Selects the operation mode of the KEB function.</p> <p>0 : Single Drive KEB Ride-Thru 1 1 : Single Drive KEB Ride-Thru 2 2 : System KEB Ride-Thru 1 3 : System KEB Ride-Thru 2</p>	0 (0 - 3)	842

No. (Hex.)	Name	Description	Default (Range)	Ref.
L2-30 (045E)	KEB Zero Speed Operation	<p>V/f CL-V/f OLV CLV AOLV OLV/PM AOLV/PM CLV/PM EZOLV</p> <p>Selects the operation when the output frequency drops below the zero level (DC braking injection starting frequency) during <i>KEB deceleration when L2-01 = 3 to 5 [Momentary Power Loss Oper Select = KEB Mode, KEB Stop Mode, or KEB Decel to Stp]</i>.</p> <p>0 : Baseblock 1 : DC/SC Braking</p>	0 (0, 1)	843
L2-31 (045D)	KEB Start Voltage Offset Level	<p>V/f CL-V/f OLV CLV AOLV OLV/PM AOLV/PM CLV/PM EZOLV</p> <p>Configures the KEB start voltage offset.</p>	Determined by A1-02 (200 V Class: 0 - 100 V, 400 V Class: 0 - 200 V)	843

◆ L3: Stall Prevention

No. (Hex.)	Name	Description	Default (Range)	Ref.
L3-01 (048F)	Stall Prevent Select during Accel	<p>V/f CL-V/f OLV CLV AOLV OLV/PM AOLV/PM CLV/PM EZOLV</p> <p>Selects the method of the Stall Prevention During Acceleration function.</p> <p>0 : Disabled 1 : General Purpose 2 : Automatic Decel Reduction 3 : ILim Mode</p>	1 (0 to 3)	844
L3-02 (0490)	Stall Prevent Level during Accel	<p>V/f CL-V/f OLV CLV AOLV OLV/PM AOLV/PM CLV/PM EZOLV</p> <p>Sets the output current level used when the Stall Prevention function is enabled during acceleration, as a percentage of the drive rated output current.</p> <p>Note: The upper limit and default for this setting is determined by C6-01 [Normal / Heavy Duty Selection] and L8-38 [Carrier Frequency Reduction].</p>	Determined by C6-01 and L8-38 (0 - 150%)	845
L3-03 (0491)	Stall Prevent Limit during Accel	<p>V/f CL-V/f OLV CLV AOLV OLV/PM AOLV/PM CLV/PM EZOLV</p> <p>Sets the lower limit for the stall prevention level during acceleration used for constant output ranges, as a percentage of the drive rated output current.</p>	50% (0 - 100%)	846
L3-04 (0492)	Stall Prevention during Decel	<p>V/f CL-V/f OLV CLV AOLV OLV/PM AOLV/PM CLV/PM EZOLV</p> <p>Selects the type of Stall Prevention during deceleration.</p> <p>Note: Set L3-04 = 0, 3 [Disabled, General Purpose w/ DB resistor] when using a dynamic braking option. Using a dynamic braking option with another setting will give priority to the Stall Prevention Function and the dynamic braking option will not function.</p> <p>0 : Disabled 1 : General Purpose 2 : Intelligent (Ignore Decel Ramp) 3 : General Purpose w/ DB resistor 4 : Overexcitation/High Flux 5 : Overexcitation/High Flux 2</p>	1 (0 to Determined by A1-05)	846
L3-05 (0493)	Stall Prevent Select during Run	<p>V/f CL-V/f OLV CLV AOLV OLV/PM AOLV/PM CLV/PM EZOLV</p> <p>Enables or disables the Stall Prevention During Run function.</p> <p>Note: The Stall Prevention during Run function is disabled regardless of the setting of L3-05 and L3-06 [Stall Prevent Level during Run] if the output frequency falls below 6 Hz.</p> <p>0 : Disabled 1 : Decel Time 1 2 : Decel Time 2</p>	Determined by A1-02 (0 to Determined by A1-02)	848

No. (Hex.)	Name	Description	Default (Range)	Ref.
L3-06 (0494)	Stall Prevent Level during Run	<p>V/f CL-V/f OLV CLV AOLV OLV/PM AOLV/PM CLV/PM EZOLV</p> <p>Sets the current level to trigger Stall Prevention during run. A setting of 100% is equal to the drive rated current.</p> <p>Note:</p> <ul style="list-style-type: none"> This parameter is valid if $L3-05 = 1, 2$ [Stall Prevent Select during Run = Decel time 1, Decel time 2]. The upper limit and default for this setting is determined by C6-01 [Normal / Heavy Duty Selection] and L8-38 [Carrier Frequency Reduction]. 	Determined by C6-01 and L8-38 (30 - 150%)	848
L3-11 (04C7)	OV Suppression Function Select	<p>V/f CL-V/f OLV CLV AOLV OLV/PM AOLV/PM CLV/PM EZOLV</p> <p>Enables or disables the overvoltage suppression function.</p> <p>0 : Disabled 1 : Enabled</p>	0 (0, 1)	848
L3-17 (0462)	DC Bus Reg Level	<p>V/f CL-V/f OLV CLV AOLV OLV/PM AOLV/PM CLV/PM EZOLV</p> <p>Set the target value for the DC bus voltage used when the overvoltage suppression function and the Decel Stall Prevention function (Intelligent Stall Prevention) are running.</p>	200 V Class: 375 V, 400 V Class: 750 V (200 V Class: 150 - 400 V, 400 V Class: 300 - 800 V)	849
L3-20 (0465)	DC Bus Voltage Adjustment Gain	<p>V/f CL-V/f OLV CLV AOLV OLV/PM AOLV/PM CLV/PM EZOLV</p> <p>Sets the proportional gain used to control the DC bus voltage.</p>	Determined by A1-02 (0.00 - 5.00)	849
L3-21 (0466)	Accel/Decel Rate Calculate Gain	<p>V/f CL-V/f OLV CLV AOLV OLV/PM AOLV/PM CLV/PM EZOLV</p> <p>Sets the proportional gain used to calculate acceleration and deceleration rates.</p>	Determined by A1-02 (0.10 - 10.00)	849
L3-22 (04F9)	DecTime atStallPrevent duringAcc	<p>V/f CL-V/f OLV CLV AOLV OLV/PM AOLV/PM CLV/PM EZOLV</p> <p>Sets the brief deceleration time used when stalling occurs while accelerating a PM motor. This function is valid when $L3-01 = 1$ [Stall Prevent Select duringAccel = General Purpose].</p>	0.0 s (0.0 - 6000.0 s)	850
L3-23 (04FD)	CHP Stall P Selection	<p>V/f CL-V/f OLV CLV AOLV OLV/PM AOLV/PM CLV/PM EZOLV</p> <p>Selects whether to automatically diminish the Stall Prevent Level during Run for constant output ranges.</p> <p>0 : Level set in L3-06 1 : Automatic Reduction</p>	0 (0, 1)	850
L3-24 (046E)	Motor Accel Time for Inertia Cal	<p>V/f CL-V/f OLV CLV AOLV OLV/PM AOLV/PM CLV/PM EZOLV</p> <p>Sets the motor acceleration time taken to reach the maximum frequency at the motor rated torque for single drive motors that are stopped.</p>	Determined by o2-04, C6-01, E2-11, and E5-01 (0.001 - 10.000 s)	850
L3-25 (046F)	Load Inertia Ratio	<p>V/f CL-V/f OLV CLV AOLV OLV/PM AOLV/PM CLV/PM EZOLV</p> <p>Sets the ratio between motor inertia and machine inertia.</p>	1.0 (1.0 - 1000.0)	851
L3-26 (0455)	Additional DC Bus Capacitors	<p>V/f CL-V/f OLV CLV AOLV OLV/PM AOLV/PM CLV/PM EZOLV</p> <p>Sets the capacity for external main circuit capacitors. Normally there is no need to change this setting. Set this parameter when using the KEB Ride-Thru function.</p>	0 μ F (0 to 65000 μ F)	851
L3-27 (0456)	Stall Prevention Detection Time	<p>V/f CL-V/f OLV CLV AOLV OLV/PM AOLV/PM CLV/PM EZOLV</p> <p>Sets a delay time from when the Stall Prevention level is reached and the actual Stall Prevention function is activated.</p>	50 ms (0 - 5000 ms)	851
L3-34 (016F)	Torque Limit Delay Time	<p>V/f CL-V/f OLV CLV AOLV OLV/PM AOLV/PM CLV/PM EZOLV</p> <p>Sets the filter time constant in units of seconds used to return the torque limit to its original value while the KEB operation is executing under Single Drive KEB Ride-Thru mode.</p>	Determined by A1-02 (0.000 - 1.000 s)	851
L3-35 (0747)	IntDecSp dAgrWdth	<p>V/f CL-V/f OLV CLV AOLV OLV/PM AOLV/PM CLV/PM EZOLV</p> <p>Sets the width for speed agreement when $L3-04 = 2$ [Decel Stall Prevention Selection = Automatic Decel Reduction]. Normally there is no need to change this setting.</p>	0.00 Hz (0.00 - 1.00 Hz)	852
L3-36 (11D0)	VibraSuppression Gain duringAccel	<p>V/f CL-V/f OLV CLV AOLV OLV/PM AOLV/PM CLV/PM EZOLV</p> <p>Sets the gain used to suppress current or motor speed hunting during operation when $L3-01 = 3$ [Stall Prevent Select during Accel = ILim Mode]. Normally there is no need to change this setting.</p>	Determined by A1-02 (0.0 - 100.0)	852

No. (Hex.)	Name	Description	Default (Range)	Ref.
L3-37 (11D1)	Current Limit P Gain duringAccel	V/f CL-V/f OLV CLV AOLV OLV/PM AOLV/PM CLV/PM EZOLV Suppresses current hunting during acceleration. Normally there is no need to change this setting.	5 ms (0 - 100 ms)	852
L3-38 (11D2)	Current Limit I Time duringAccel	V/f CL-V/f OLV CLV AOLV OLV/PM AOLV/PM CLV/PM EZOLV Suppresses the hunting and overshooting of current that occurs when stalling occurs during acceleration. Normally there is no need to change this setting.	10.0 (0.0 - 100.0)	852
L3-39 (11D3)	CurlimIntegTime Con duringAcc/Dec	V/f CL-V/f OLV CLV AOLV OLV/PM AOLV/PM CLV/PM EZOLV Sets the time constant used to adjust the acceleration rate when <i>L3-01 = 3</i> [<i>Stall Prevent Limit during Accel = ILim Mode</i>]. Normally there is no need to change this setting.	100.0 ms (1.0 - 1000.0 ms)	852
L3-40 (11D4)	CurlimMaxScurve Sel duringAcc/Dec	V/f CL-V/f OLV CLV AOLV OLV/PM AOLV/PM CLV/PM EZOLV Selects whether to enable or disable the optimal S-curve characteristic used for current -limited acceleration. 0 : Disabled 1 : Enabled	0 (0, 1)	853

◆ L4: Speed Detection

No. (Hex.)	Name	Description	Default (Range)	Ref.
L4-01 (0499)	Speed Agree Detection Level	V/f CL-V/f OLV CLV AOLV OLV/PM AOLV/PM CLV/PM EZOLV Sets the speed agree detection level or the motor speed detection level. Sets the speed detection level or motor speed detection level when <i>H2-01 to H2-04 = 2, 3, 4, 5</i> [<i>MFDO Function Select = Speed Agree 1, User-set Speed Agree 1, Frequency Detection 1, Frequency Detection 2</i>].	Determined by A1-02 (Determined by A1-02)	853
L4-02 (049A)	Speed Agree Detection Width	V/f CL-V/f OLV CLV AOLV OLV/PM AOLV/PM CLV/PM EZOLV Sets the speed agree detection width or motor speed detection width. Sets the speed detection width or motor speed detection width when <i>H2-01 to H2-04 = 2, 3, 4, 5</i> [<i>MFDO Function Select = Speed Agree 1, User-set Speed Agree 1, Frequency Detection 1, Frequency Detection 2</i>].	Determined by A1-02 (Determined by A1-02)	853
L4-03 (049B)	Speed Agree Detect Level (+/-)	V/f CL-V/f OLV CLV AOLV OLV/PM AOLV/PM CLV/PM EZOLV Sets the speed agree detection level or the motor speed detection level. Sets the speed detection level or motor speed detection level when <i>H2-01 to H2-04 = 13, 14, 15, 16</i> [<i>MFDO Function Select = Speed Agree 2, User-set Speed Agree 2, Frequency Detection 3, Frequency Detection 4</i>].	Determined by A1-02 (Determined by A1-02)	853
L4-04 (049C)	Speed Agree Detect Width (+/-)	V/f CL-V/f OLV CLV AOLV OLV/PM AOLV/PM CLV/PM EZOLV Sets the speed agree detection width or motor speed detection width. Sets the speed detection width or motor speed detection width when <i>H2-01 to H2-04 = 13, 14, 15, 16</i> [<i>MFDO Function Select = Speed Agree 2, User-set Speed Agree 2, Frequency Detection 3, Frequency Detection 4</i>].	Determined by A1-02 (Determined by A1-02)	853
L4-05 (049D)	FreqReference Loss Detect Select	V/f CL-V/f OLV CLV AOLV OLV/PM AOLV/PM CLV/PM EZOLV Selects the operation when a loss of the frequency reference is detected. 0 : Stop 1 : Run@L4-06PrevRef	0 (0, 1)	854
L4-06 (04C2)	FreqReference at Reference Loss	V/f CL-V/f OLV CLV AOLV OLV/PM AOLV/PM CLV/PM EZOLV Sets the frequency reference as a percentage that is applicable when not stopping the drive so that it continues to operate after a loss of the frequency reference value is detected. The value is set as a percentage of the frequency reference before the loss was detected.	80.0% (0.0 - 100.0%)	854
L4-07 (0470)	Speed Agree Detection Selection	V/f CL-V/f OLV CLV AOLV OLV/PM AOLV/PM CLV/PM EZOLV Selects the condition for activating speed detection. 0 : No detection during baseblock 1 : Detection always enabled	0 (0, 1)	854

◆ L5: Fault Restart

No. (Hex.)	Name	Description	Default (Range)	Ref.
L5-01 (049E)	Number of Auto Restart Attempts	V/f CL-V/f OLV CLV AOLV OLV/PM AOLV/PM CLV/PM EZOLV Sets the number of that can be automatically performed by the drive. Sets the number of Auto Restart operations that the drive may attempt to restart itself.	0 (0 - 10 times)	855
L5-02 (049F)	AutoRestartFaultOutputOpeSelect	V/f CL-V/f OLV CLV AOLV OLV/PM AOLV/PM CLV/PM EZOLV Selects whether to output signals to the MFDO terminal set for <i>Fault [H2-xx = E]</i> while the drive is executing Auto restart. 0 : Fault output not active 1 : Fault output active	0 (0, 1)	855
L5-04 (046C)	Auto Restart Interval Time	V/f CL-V/f OLV CLV AOLV OLV/PM AOLV/PM CLV/PM EZOLV Sets the time interval between each Auto Restart process. This function is enabled when <i>L5-05 = 1 [Auto Restart Operation Selection = Use L5-04 Time]</i> .	10.0 s (0.5 - 600.0 s)	855
L5-05 (0467)	Auto Restart Operation Selection	V/f CL-V/f OLV CLV AOLV OLV/PM AOLV/PM CLV/PM EZOLV Selects the count method for the Auto Restart operation. 0 : Continuous 1 : Use L5-04 Time	0 (0, 1)	856

◆ L6: Torque Detection

No. (Hex.)	Name	Description	Default (Range)	Ref.
L6-01 (04A1)	Torque Detection Selection 1	V/f CL-V/f OLV CLV AOLV OLV/PM AOLV/PM CLV/PM EZOLV Selects the speed range at which overtorque/undertorque is detected and the operation of drives (operation status) after detection. 0 : Disabled 1 : OL Alm at SpdAgr 2 : OL Alm dur RUN 3 : OL Flt at SpdAgr 4 : OL Flt dur RUN 5 : UL Alm at SpdAgr 6 : UL Alm dur RUN 7 : UL Flt at SpdAgr 8 : UL Flt dur RUN	0 (0 - 8)	858
L6-02 (04A2)	Torque Detection Level 1	V/f CL-V/f OLV CLV AOLV OLV/PM AOLV/PM CLV/PM EZOLV Sets the detection level for Overtorque/Undertorque Detection 1. This parameter is set on the basis of the drive rated output current as the 100% value when using V/f Control. This parameter is set on the basis of the motor rated torque as the 100% value when using vector control.	150% (0 - 300%)	859
L6-03 (04A3)	Torque Detection Time 1	V/f CL-V/f OLV CLV AOLV OLV/PM AOLV/PM CLV/PM EZOLV Sets the detection time for Overtorque/Undertorque Detection 1.	0.1 s (0.0 - 10.0 s)	859
L6-04 (04A4)	Torque Detection Selection 2	V/f CL-V/f OLV CLV AOLV OLV/PM AOLV/PM CLV/PM EZOLV Selects the speed range at which overtorque/undertorque is detected and the operation of drives (operation status) after detection. 0 : Disabled 1 : OL Alm at SpdAgr 2 : OL Alm dur RUN 3 : OL Flt at SpdAgr 4 : OL Flt dur RUN 5 : UL Alm at SpdAgr 6 : UL Alm dur RUN 7 : UL Flt at SpdAgr 8 : UL Flt dur RUN	0 (0 - 8)	859

10.11 L: Protection Function

No. (Hex.)	Name	Description	Default (Range)	Ref.
L6-05 (04A5)	Torque Detection Level 2	<input type="checkbox"/> V/f <input type="checkbox"/> CL-V/f <input type="checkbox"/> OLV <input type="checkbox"/> CLV <input type="checkbox"/> AOLV <input type="checkbox"/> OLV/PM <input type="checkbox"/> AOLV/PM <input type="checkbox"/> CLV/PM <input type="checkbox"/> EZOLV Sets the detection level for Overtorque/Undertorque Detection 2. This parameter is set on the basis of the drive rated output current as the 100% value when using V/f Control. This parameter is set on the basis of the motor rated torque as the 100% value when using vector control.	150% (0 - 300%)	860
L6-06 (04A6)	Torque Detection Time 2	<input type="checkbox"/> V/f <input type="checkbox"/> CL-V/f <input type="checkbox"/> OLV <input type="checkbox"/> CLV <input type="checkbox"/> AOLV <input type="checkbox"/> OLV/PM <input type="checkbox"/> AOLV/PM <input type="checkbox"/> CLV/PM <input type="checkbox"/> EZOLV Sets the detection time for Overtorque/Undertorque Detection 2.	0.1 s (0.0 - 10.0 s)	860
L6-08 (0468)	Mechanical Weakening Detect Ope	<input type="checkbox"/> V/f <input type="checkbox"/> CL-V/f <input type="checkbox"/> OLV <input type="checkbox"/> CLV <input type="checkbox"/> AOLV <input type="checkbox"/> OLV/PM <input type="checkbox"/> AOLV/PM <input type="checkbox"/> CLV/PM <input type="checkbox"/> EZOLV Selects the speed range at which mechanical deterioration is detected and the operation of drives (operation status) after detection. 0 : Disabled 1 : Alm Spd>L6-09 2 : Alm [Spd]>L6-09 3 : Flt Spd>L6-09 4 : Flt [Spd]>L6-09 5 : Alm Spd<L6-09 6 : Alm [Spd]<L6-09 7 : Flt Spd<L6-09 8 : Flt [Spd]<L6-09	0 (0 - 8)	860
L6-09 (0469)	Mechanical Weakening Detect Spd Lvl	<input type="checkbox"/> V/f <input type="checkbox"/> CL-V/f <input type="checkbox"/> OLV <input type="checkbox"/> CLV <input type="checkbox"/> AOLV <input type="checkbox"/> OLV/PM <input type="checkbox"/> AOLV/PM <input type="checkbox"/> CLV/PM <input type="checkbox"/> EZOLV On the basis that <i>E1-04 [Maximum Output Frequency]</i> is the 100% value, this parameter sets the speed level at which the mechanical deterioration detection function operated as a percentage.	110.0% (-110.0 - 110.0%)	861
L6-10 (046A)	Mechanical Weakening Detect Time	<input type="checkbox"/> V/f <input type="checkbox"/> CL-V/f <input type="checkbox"/> OLV <input type="checkbox"/> CLV <input type="checkbox"/> AOLV <input type="checkbox"/> OLV/PM <input type="checkbox"/> AOLV/PM <input type="checkbox"/> CLV/PM <input type="checkbox"/> EZOLV Sets the time for mechanical deterioration detection.	0.1 s (0.0 - 10.0 s)	861
L6-11 (046B)	Mechanical Weakening Detect Srt Time	<input type="checkbox"/> V/f <input type="checkbox"/> CL-V/f <input type="checkbox"/> OLV <input type="checkbox"/> CLV <input type="checkbox"/> AOLV <input type="checkbox"/> OLV/PM <input type="checkbox"/> AOLV/PM <input type="checkbox"/> CLV/PM <input type="checkbox"/> EZOLV Sets the time at which mechanical deterioration detection is started using the cumulative operation time of the drive as a trigger.	0 h (0 - 65535 h)	861

◆ L7: Torque Limit

No. (Hex.)	Name	Description	Default (Range)	Ref.
L7-01 (04A7) RUN	Forward Torque Limit	<input type="checkbox"/> V/f <input type="checkbox"/> CL-V/f <input type="checkbox"/> OLV <input type="checkbox"/> CLV <input type="checkbox"/> AOLV <input type="checkbox"/> OLV/PM <input type="checkbox"/> AOLV/PM <input type="checkbox"/> CLV/PM <input type="checkbox"/> EZOLV On the basis that the motor rated torque is the 100% value, this parameter sets the torque limit value for forward motoring as a percentage.	200% (0 - 300%)	862
L7-02 (04A8) RUN	Reverse Torque Limit	<input type="checkbox"/> V/f <input type="checkbox"/> CL-V/f <input type="checkbox"/> OLV <input type="checkbox"/> CLV <input type="checkbox"/> AOLV <input type="checkbox"/> OLV/PM <input type="checkbox"/> AOLV/PM <input type="checkbox"/> CLV/PM <input type="checkbox"/> EZOLV Sets the torque limit value for reversed motoring as a percentage of the motor rated torque.	200% (0 - 300%)	862
L7-03 (04A9) RUN	Forward Regenerative Torque Limit	<input type="checkbox"/> V/f <input type="checkbox"/> CL-V/f <input type="checkbox"/> OLV <input type="checkbox"/> CLV <input type="checkbox"/> AOLV <input type="checkbox"/> OLV/PM <input type="checkbox"/> AOLV/PM <input type="checkbox"/> CLV/PM <input type="checkbox"/> EZOLV Sets the torque limit value for forward regenerative states as a percentage of the motor rated torque.	200% (0 - 300%)	863
L7-04 (04AA) RUN	Reverse Regenerative Torque Limit	<input type="checkbox"/> V/f <input type="checkbox"/> CL-V/f <input type="checkbox"/> OLV <input type="checkbox"/> CLV <input type="checkbox"/> AOLV <input type="checkbox"/> OLV/PM <input type="checkbox"/> AOLV/PM <input type="checkbox"/> CLV/PM <input type="checkbox"/> EZOLV Sets the torque limit value for reversed regenerative states as a percentage of the motor rated torque.	200% (0 - 300%)	863
L7-06 (04AC)	Torque Limit Integral Time Constant	<input type="checkbox"/> V/f <input type="checkbox"/> CL-V/f <input type="checkbox"/> OLV <input type="checkbox"/> CLV <input type="checkbox"/> AOLV <input type="checkbox"/> OLV/PM <input type="checkbox"/> AOLV/PM <input type="checkbox"/> CLV/PM <input type="checkbox"/> EZOLV Sets the integral time constant for the torque limit function.	200 ms (5 - 10000 ms)	863
L7-07 (04C9)	Torque Limit Control Method during Acc/Dec	<input type="checkbox"/> V/f <input type="checkbox"/> CL-V/f <input type="checkbox"/> OLV <input type="checkbox"/> CLV <input type="checkbox"/> AOLV <input type="checkbox"/> OLV/PM <input type="checkbox"/> AOLV/PM <input type="checkbox"/> CLV/PM <input type="checkbox"/> EZOLV Selects the function of torque limit during acceleration and deceleration. 0 : P-ctrl @ Acc/Dec 1 : I-ctrl @ Acc/Dec	0 (0, 1)	863

No. (Hex.)	Name	Description	Default (Range)	Ref.
L7-16 (044D)	Torque Limit Process at Start	<input type="checkbox"/> V/f <input type="checkbox"/> CL-V/f <input type="checkbox"/> OLV <input type="checkbox"/> CLV <input type="checkbox"/> AOLV <input type="checkbox"/> OLV/PM <input type="checkbox"/> AOLV/PM <input type="checkbox"/> CLV/PM <input type="checkbox"/> EZOLV Assigns a time filter to allow the torque limit to build at start. 0 : Disabled 1 : Enabled	1 (0, 1)	864
L7-35 (1B57)	DeratingTrqLim ForLowFreq&Regratn	<input type="checkbox"/> V/f <input type="checkbox"/> CL-V/f <input type="checkbox"/> OLV <input type="checkbox"/> CLV <input type="checkbox"/> AOLV <input type="checkbox"/> OLV/PM <input type="checkbox"/> AOLV/PM <input type="checkbox"/> CLV/PM <input type="checkbox"/> EZOLV Sets the torque limit used during low-speed regeneration. Normally there is no need to change this setting.	50.00% (0.00 - 200.00%)	864
L7-36 (1B58)	Ope Freq band for deratingTrqLim	<input type="checkbox"/> V/f <input type="checkbox"/> CL-V/f <input type="checkbox"/> OLV <input type="checkbox"/> CLV <input type="checkbox"/> AOLV <input type="checkbox"/> OLV/PM <input type="checkbox"/> AOLV/PM <input type="checkbox"/> CLV/PM <input type="checkbox"/> EZOLV Sets the frequency width at which L7-35 [Derating Trq Lim For Low Freq & Regeneration] operates.	6.00 Hz (0.00 - 30.00 Hz)	864

◆ L8: Hardware Protection

No. (Hex.)	Name	Description	Default (Range)	Ref.
L8-01 (04AD)	Internal DB Resistor Protect Sel	<input type="checkbox"/> V/f <input type="checkbox"/> CL-V/f <input type="checkbox"/> OLV <input type="checkbox"/> CLV <input type="checkbox"/> AOLV <input type="checkbox"/> OLV/PM <input type="checkbox"/> AOLV/PM <input type="checkbox"/> CLV/PM <input type="checkbox"/> EZOLV Enabled braking resistor protection of the when using an optional heatsink mounted braking resistor (ERF type, 3% ED). 0 : Not Provided 1 : Provided	0 (0, 1)	865
L8-02 (04AE)	Overheat Alarm Level	<input type="checkbox"/> V/f <input type="checkbox"/> CL-V/f <input type="checkbox"/> OLV <input type="checkbox"/> CLV <input type="checkbox"/> AOLV <input type="checkbox"/> OLV/PM <input type="checkbox"/> AOLV/PM <input type="checkbox"/> CLV/PM <input type="checkbox"/> EZOLV Sets the <i>oH</i> detection level in temperature.	Determined by o2-04 and C6-01 (50 - 150 °C)	865
L8-03 (04AF)	Overheat Pre-Alarm Ope Selection	<input type="checkbox"/> V/f <input type="checkbox"/> CL-V/f <input type="checkbox"/> OLV <input type="checkbox"/> CLV <input type="checkbox"/> AOLV <input type="checkbox"/> OLV/PM <input type="checkbox"/> AOLV/PM <input type="checkbox"/> CLV/PM <input type="checkbox"/> EZOLV Sets the operation of drives when an <i>oH</i> alarm is detected. 0 : Ramp to Stop 1 : Coast to Stop 2 : Fast-Stop 3 : Alarm Only 4 : Run@L8-19 Rate	3 (0 - 4)	865
L8-05 (04B1)	Input Phase Loss Protect Select	<input type="checkbox"/> V/f <input type="checkbox"/> CL-V/f <input type="checkbox"/> OLV <input type="checkbox"/> CLV <input type="checkbox"/> AOLV <input type="checkbox"/> OLV/PM <input type="checkbox"/> AOLV/PM <input type="checkbox"/> CLV/PM <input type="checkbox"/> EZOLV Enables or disables input phase loss detection. 0 : Disabled 1 : Enabled	0 (0, 1)	866
L8-07 (04B3)	Output Phase Loss Protect Select	<input type="checkbox"/> V/f <input type="checkbox"/> CL-V/f <input type="checkbox"/> OLV <input type="checkbox"/> CLV <input type="checkbox"/> AOLV <input type="checkbox"/> OLV/PM <input type="checkbox"/> AOLV/PM <input type="checkbox"/> CLV/PM <input type="checkbox"/> EZOLV Enables or disables the output phase loss detection. Output phase loss detection is triggered when the output current falls below 5% of the drive rated current. Note: Output phase loss detection can mistakenly be triggered in the following situations. Disable output phase loss protection. • The motor rated current is very small compared to the drive rating. • Operates PM motors with light loads. 0 : Disabled 1 : 1PH Loss Det 2 : 2/3PH Loss Det	0 (0 - 2)	866
L8-09 (04B5)	Output Ground Fault DetectSelect	<input type="checkbox"/> V/f <input type="checkbox"/> CL-V/f <input type="checkbox"/> OLV <input type="checkbox"/> CLV <input type="checkbox"/> AOLV <input type="checkbox"/> OLV/PM <input type="checkbox"/> AOLV/PM <input type="checkbox"/> CLV/PM <input type="checkbox"/> EZOLV Enables or disables ground fault protection. 0 : Disabled 1 : Enabled	Determined by o2-04 (0, 1)	867
L8-10 (04B6)	Heatsink Cooling Fan Ope Select	<input type="checkbox"/> V/f <input type="checkbox"/> CL-V/f <input type="checkbox"/> OLV <input type="checkbox"/> CLV <input type="checkbox"/> AOLV <input type="checkbox"/> OLV/PM <input type="checkbox"/> AOLV/PM <input type="checkbox"/> CLV/PM <input type="checkbox"/> EZOLV Selects the heatsink cooling fan operation. 0 : Dur Run (OffDly) 1 : Always On 2 : Fan ON in heating of Drive	0 (0 - 2)	867

10.11 L: Protection Function

No. (Hex.)	Name	Description	Default (Range)	Ref.
L8-11 (04B7)	HeatsinkCooling Fan Off DelayTime	V/f CL-V/f OLV CLV AOLV OLV/PM AOLV/PM CLV/PM EZOLV Sets the delay time that occurs before the cooling fan is stopped after the run command is canceled when $L8-10 = 0$ [<i>Heatsink Cooling Fan Ope Select = Dur Run (OffDly)</i>].	60 s (0 - 300 s)	867
L8-12 (04B8)	Ambient Temperature Setting	V/f CL-V/f OLV CLV AOLV OLV/PM AOLV/PM CLV/PM EZOLV Sets the ambient temperature of the area where the drive is installed.	40 °C (-10 to 50 °C)	867
L8-15 (04BB)	oL2 Characteristics Sel atLowSpd	V/f CL-V/f OLV CLV AOLV OLV/PM AOLV/PM CLV/PM EZOLV Selects whether the drive overload capability is reduced at low speeds to prevent <i>oL2 [Drive Overloaded]</i> to protect the main circuit transistor in the drive during low speed operation (at 6 Hz or less). Note: Contact Yaskawa or your nearest sales representative for consultation before disabling this function at low speeds. Frequent operation of drives under conditions of high output current in low speed ranges may shorten the service life of the drive IGBT due to heat stress. 0 : Disabled 1 : Enabled	1 (0, 1)	867
L8-18 (04BE)	Software Current Limit Selection	V/f CL-V/f OLV CLV AOLV OLV/PM AOLV/PM CLV/PM EZOLV Enables or disables the software current limit selection used to protect the main circuit transistor from significant current. 0 : Disabled 1 : Enabled	0 (0, 1)	868
L8-19 (04BF)	FreqReductRate DuringOH Pre-Alarm	V/f CL-V/f OLV CLV AOLV OLV/PM AOLV/PM CLV/PM EZOLV Sets the ratio at which the frequency reference is derated when the <i>oH</i> alarm is output.	0.8 (0.1 to 0.9)	868
L8-20 (04C0)	CF SELECT	V/f CL-V/f OLV CLV AOLV OLV/PM AOLV/PM CLV/PM EZOLV Selects the operation when <i>CF</i> faults are detected when $A1-02 = 4$ [<i>Control Method Selection = Advanced OpenLoop Vector Control</i>]. 0 : Disabled 1 : Coast to Stop 2 : Fast Stop	1 (0 - 2)	868
L8-27 (04DD)	Overcurrent Detection Gain	V/f CL-V/f OLV CLV AOLV OLV/PM AOLV/PM CLV/PM EZOLV Sets the PM motor overcurrent detection level as a percentage of the motor rated current value.	300.0% (0.0 - 400.0%)	869
L8-29 (04DF)	Current Unbalance Detect (LF2)	V/f CL-V/f OLV CLV AOLV OLV/PM AOLV/PM CLV/PM EZOLV Enables or disables the detection of <i>LF2</i> . 0 : Disabled 1 : Enabled	1 (0, 1)	869
L8-31 (04E1)	LF2 Detection Time	V/f CL-V/f OLV CLV AOLV OLV/PM AOLV/PM CLV/PM EZOLV Sets the LF2 [Output Current Imbalance] detection time.	3 (1 to 100)	869
L8-32 (04E2)	Cooling Fan Failure Selection	V/f CL-V/f OLV CLV AOLV OLV/PM AOLV/PM CLV/PM EZOLV Selects the drive operation when <i>FAn [Internal Agitating Fan Fault]</i> occurs. 0 : Ramp to Stop 1 : Coast to Stop 2 : Fast-Stop 3 : Alarm Only 4 : Run@L8-19 Rate	1 (0 to 4)	869
L8-35 (04EC)	Installation Method Selection	V/f CL-V/f OLV CLV AOLV OLV/PM AOLV/PM CLV/PM EZOLV Selects the type of drive installation. 0 : IP00/Open-Chassis enclosure 1 : Side-by-Side mounting 2 : IP20/UL Type 1/IP55 3 : Finless/Fin Ext	Determined by o2-04 (0 - 3)	870

No. (Hex.)	Name	Description	Default (Range)	Ref.
L8-38 (04EF)	Carrier Frequency Reduction	V/f CL-V/f OLV CLV AOLV OLV/PM AOLV/PM CLV/PM EZOLV Selects the operation of the carrier frequency reduction function. The carrier frequency is reduced when the output current exceeds a specific level. 0 : Disabled 1 : Enabled below 6 Hz 2 : Enabled for the EntireSpeedRange	Determined by A1-02, C6-01, and o2-04 (0 - 2)	870
L8-40 (04F1)	CarrierFreqReduct Off DelayTime	V/f CL-V/f OLV CLV AOLV OLV/PM AOLV/PM CLV/PM EZOLV Sets the time (off delay time) taken for the automatically reduced carrier frequency to return to the state before the reduction.	Determined by A1-02 (0.00 - 2.00 s)	871
L8-41 (04F2)	High Current Alarm Selection	V/f CL-V/f OLV CLV AOLV OLV/PM AOLV/PM CLV/PM EZOLV Triggers an <i>HCA</i> [Current Alarm] when the output current exceeds 150% of the drive rated current. 0 : Disabled 1 : Enabled	0 (0, 1)	871
L8-51 (0471)	STPo I Detection Level	V/f CL-V/f OLV CLV AOLV OLV/PM AOLV/PM CLV/PM EZOLV Sets the <i>STPo</i> [Desynchronization Error] on the basis of the output current.	0.0% (0.0 - 300.0%)	871
L8-52 (0472)	STPo Integration Level	V/f CL-V/f OLV CLV AOLV OLV/PM AOLV/PM CLV/PM EZOLV Sets the detection level for <i>STPo</i> [Desynchronization Error] on the basis of the ACR integral value.	1.0 (0.1 - 2.0)	871
L8-53 (0473)	STPo Integration Time	V/f CL-V/f OLV CLV AOLV OLV/PM AOLV/PM CLV/PM EZOLV Sets the time until <i>STPo</i> is detected after the value of L8-51 [STPo I Detection Level] is exceeded.	1.0 s (1.0 - 10.0 s)	871
L8-54 (0474)	STPo Id Diff Detection	V/f CL-V/f OLV CLV AOLV OLV/PM AOLV/PM CLV/PM EZOLV Enables or disables the Id deviation detection function for <i>STPo</i> [Desynchronization Error]. 0 : Disabled 1 : Enabled	1 (0, 1)	871
L8-55 (045F)	InternalBraking TransistorProtect	V/f CL-V/f OLV CLV AOLV OLV/PM AOLV/PM CLV/PM EZOLV Enables or disables protection for the internal braking transistor. 0 : Disable 1 : Protection enabled	1 (0, 1)	872
L8-56 (047D)	Stl Act Time	V/f CL-V/f OLV CLV AOLV OLV/PM AOLV/PM CLV/PM EZOLV Sets the time that the acceleration stall prevention function can continue to operate, after which the <i>STPo</i> [Desynchronization Error] is detected.	5000 ms (100 - 5000 ms)	872
L8-57 (047E)	Stl Retry Count	V/f CL-V/f OLV CLV AOLV OLV/PM AOLV/PM CLV/PM EZOLV Sets the number of times the acceleration stall prevention function can operate until speeds match, after which the <i>STPo</i> "Desynchronization Error" is detected.	10 times (1 to 10 times)	872
L8-90 (0175)	STPo Detection Level	V/f CL-V/f OLV CLV AOLV OLV/PM AOLV/PM CLV/PM EZOLV <i>STPo</i> [Desynchronization Error] is detected when the control fault reaches the detection level of L8-90.	Determined by A1-02 (0 to 5000 times)	872
L8-93 (073C)	LSo Detection Time at Low Speed	V/f CL-V/f OLV CLV AOLV OLV/PM AOLV/PM CLV/PM EZOLV Sets the time before baseblock is executed after <i>LSo</i> [LSo Fault] is detected.	1.0 s (0.0 - 10.0 s)	873
L8-94 (073D)	LSo Detection Level at Low Speed	V/f CL-V/f OLV CLV AOLV OLV/PM AOLV/PM CLV/PM EZOLV Sets the detection level for <i>LSo</i> [LSo Fault] as a percentage of E1-04 [Maximum Output Frequency].	3% (0 - 10%)	873
L8-95 (077F)	Average LSo Freq at Low Speed	V/f CL-V/f OLV CLV AOLV OLV/PM AOLV/PM CLV/PM EZOLV Sets the average count of <i>LSo</i> [LSo Fault] detections.	10 times (1 to 50 times)	873

◆ L9: Drive Protection 2

No. (Hex.)	Name	Description	Default (Range)	Ref.
L9-16 (11DC)	FAn1 Detection Time	V/f CL-V/f OLV CLV AOLV OLV/PM AOLV/PM CLV/PM EZOLV Sets the detection time for <i>FAn1 [Drive Cooling Fan Failure]</i> . Do not change the value of this parameter unless absolutely necessary.	4.0 s (0.0 to 30.0 s)	873

10.12 n: Special Adjustment

◆ n1: Hunting Prevention

No. (Hex.)	Name	Description	Default (Range)	Ref.
n1-01 (0580)	Hunting Prevention Selection	<input checked="" type="checkbox"/> V/f <input checked="" type="checkbox"/> CL-V/f <input type="checkbox"/> OLV <input type="checkbox"/> CLV <input type="checkbox"/> AOLV <input type="checkbox"/> OLV/PM <input type="checkbox"/> AOLV/PM <input type="checkbox"/> CLV/PM <input type="checkbox"/> EZOLV Enables or disables the hunting prevention function. 0 : Disabled 1 : Enabled 2 : Enable (High carry)	1 (0 - 2)	874
n1-02 (0581)	Hunting Prevention Gain Setting	<input checked="" type="checkbox"/> V/f <input checked="" type="checkbox"/> CL-V/f <input type="checkbox"/> OLV <input type="checkbox"/> CLV <input type="checkbox"/> AOLV <input type="checkbox"/> OLV/PM <input type="checkbox"/> AOLV/PM <input type="checkbox"/> CLV/PM <input type="checkbox"/> EZOLV Adjusts the behavior of the hunting prevention function. Normally there is no need to configure this setting.	1.00 (0.00 - 2.50)	874
n1-03 (0582)	Hunting Prevention Time Constant	<input checked="" type="checkbox"/> V/f <input checked="" type="checkbox"/> CL-V/f <input type="checkbox"/> OLV <input type="checkbox"/> CLV <input type="checkbox"/> AOLV <input type="checkbox"/> OLV/PM <input type="checkbox"/> AOLV/PM <input type="checkbox"/> CLV/PM <input type="checkbox"/> EZOLV Adjusts the responsiveness (primary delay time constant) of the hunting prevention function. Normally there is no need to configure this setting.	Determined by o2-04 (0 - 500 ms)	874
n1-05 (0530)	Hunting Prevention Gain while in Rev	<input checked="" type="checkbox"/> V/f <input checked="" type="checkbox"/> CL-V/f <input type="checkbox"/> OLV <input type="checkbox"/> CLV <input type="checkbox"/> AOLV <input type="checkbox"/> OLV/PM <input type="checkbox"/> AOLV/PM <input type="checkbox"/> CLV/PM <input type="checkbox"/> EZOLV Adjusts the behavior of the hunting prevention function. Used to adjust Reverse run. Normally there is no need to configure this setting.	0.00 (0.00 - 2.50)	874
n1-08 (1105)	Leak cur antivib	<input checked="" type="checkbox"/> V/f <input checked="" type="checkbox"/> CL-V/f <input type="checkbox"/> OLV <input type="checkbox"/> CLV <input type="checkbox"/> AOLV <input type="checkbox"/> OLV/PM <input type="checkbox"/> AOLV/PM <input type="checkbox"/> CLV/PM <input type="checkbox"/> EZOLV Selects the method of suppressing motor vibration caused by leakage current. Normally there is no need to configure this setting. 0 : Method1 1 : Method2	0 (0, 1)	875
n1-13 (1B59)	DC Bus Stabilization Control	<input checked="" type="checkbox"/> V/f <input checked="" type="checkbox"/> CL-V/f <input type="checkbox"/> OLV <input type="checkbox"/> CLV <input type="checkbox"/> AOLV <input type="checkbox"/> OLV/PM <input type="checkbox"/> AOLV/PM <input type="checkbox"/> CLV/PM <input type="checkbox"/> EZOLV Enables or disables the oscillation suppression function for the DC bus voltage. 0 : Disabled 1 : Enabled	0 (0, 1)	875
n1-14 (1B5A)	DC Bus Stabilization Time	<input checked="" type="checkbox"/> V/f <input checked="" type="checkbox"/> CL-V/f <input type="checkbox"/> OLV <input type="checkbox"/> CLV <input type="checkbox"/> AOLV <input type="checkbox"/> OLV/PM <input type="checkbox"/> AOLV/PM <input type="checkbox"/> CLV/PM <input type="checkbox"/> EZOLV With a setting of <i>n1-13 = 1 [DC Bus Stabilization Control = Enabled]</i> , adjustments that address a lack of oscillation suppression capability with respect to the DC bus voltage can be made.	100.0 ms (50.0 - 500.0 ms)	875
n1-15 (0BF8)	Voltage Calibration Select	<input checked="" type="checkbox"/> V/f <input checked="" type="checkbox"/> CL-V/f <input type="checkbox"/> OLV <input type="checkbox"/> CLV <input type="checkbox"/> AOLV <input type="checkbox"/> OLV/PM <input type="checkbox"/> AOLV/PM <input type="checkbox"/> CLV/PM <input type="checkbox"/> EZOLV Selects the calibration method to be used for the suppression of torque/current ripple. 0 : Calibration Invalid 1 : Calibrate only 1 time 2 : Calibrate every time	1 (0 - 2)	875
n1-16 (0BFB)	High carry Hunt Prev Gain	<input checked="" type="checkbox"/> V/f <input checked="" type="checkbox"/> CL-V/f <input type="checkbox"/> OLV <input type="checkbox"/> CLV <input type="checkbox"/> AOLV <input type="checkbox"/> OLV/PM <input type="checkbox"/> AOLV/PM <input type="checkbox"/> CLV/PM <input type="checkbox"/> EZOLV Adjusts the behavior of the hunting prevention function. This is most effective when a high carrier frequency has been set. Normally there is no need to configure this setting.	0.50 (0.00 - 2.50)	876
n1-17 (0BFC)	Hunt Prev Time	<input checked="" type="checkbox"/> V/f <input checked="" type="checkbox"/> CL-V/f <input type="checkbox"/> OLV <input type="checkbox"/> CLV <input type="checkbox"/> AOLV <input type="checkbox"/> OLV/PM <input type="checkbox"/> AOLV/PM <input type="checkbox"/> CLV/PM <input type="checkbox"/> EZOLV Adjusts the responsiveness of the hunting prevention function. Normally there is no need to configure this setting.	500 ms (0 - 1000 ms)	876

◆ n2: SpdFeedbackDetectControl(AFR)Tun

No. (Hex.)	Name	Description	Default (Range)	Ref.
n2-01 (0584)	SpdFeedbackDetectCtr (AFR) Gain	<input type="checkbox"/> V/f <input type="checkbox"/> CL-V/f <input checked="" type="checkbox"/> OLV <input type="checkbox"/> CLV <input type="checkbox"/> AOLV <input type="checkbox"/> OLV/PM <input type="checkbox"/> AOLV/PM <input type="checkbox"/> CLV/PM <input type="checkbox"/> EZOLV This parameter sets the gain of the AFR function as a magnification value. Normally there is no need to change this setting.	1.00 (0.00 - 10.00)	876
n2-02 (0585)	SpdFeedbackDetCtr(AFR) TimeConst1	<input type="checkbox"/> V/f <input type="checkbox"/> CL-V/f <input checked="" type="checkbox"/> OLV <input type="checkbox"/> CLV <input type="checkbox"/> AOLV <input type="checkbox"/> OLV/PM <input type="checkbox"/> AOLV/PM <input type="checkbox"/> CLV/PM <input type="checkbox"/> EZOLV This parameter sets the time constant that determines the rate of change for the AFR function. Normally there is no need to change this setting.	50 ms (0 - 2000 ms)	876
n2-03 (0586)	SpdFeedbackDetCtr(AFR) TimeConst2	<input type="checkbox"/> V/f <input type="checkbox"/> CL-V/f <input checked="" type="checkbox"/> OLV <input type="checkbox"/> CLV <input type="checkbox"/> AOLV <input type="checkbox"/> OLV/PM <input type="checkbox"/> AOLV/PM <input type="checkbox"/> CLV/PM <input type="checkbox"/> EZOLV This parameter sets the time constant that determines the variation in speed of the AFR function. Use this parameter when performing speed searches or regeneration. Normally there is no need to change this setting.	750 ms (0 - 2000 ms)	877

◆ n3: High Slip Braking (HSB)

No. (Hex.)	Name	Description	Default (Range)	Ref.
n3-01 (0588)	HSB Deceleration Frequency Width	<input type="checkbox"/> V/f <input type="checkbox"/> CL-V/f <input type="checkbox"/> OLV <input type="checkbox"/> CLV <input type="checkbox"/> AOLV <input type="checkbox"/> OLV/PM <input type="checkbox"/> AOLV/PM <input type="checkbox"/> CLV/PM <input type="checkbox"/> EZOLV Sets the amount by which the output frequency is to be lowered during high-slip braking, as a percentage of E1-04 [Maximum Output Frequency], which represents the 100% value.	5% (1 - 20%)	879
n3-02 (0589)	High-Slip Braking Current Limit	<input type="checkbox"/> V/f <input type="checkbox"/> CL-V/f <input type="checkbox"/> OLV <input type="checkbox"/> CLV <input type="checkbox"/> AOLV <input type="checkbox"/> OLV/PM <input type="checkbox"/> AOLV/PM <input type="checkbox"/> CLV/PM <input type="checkbox"/> EZOLV Sets the maximum current output during high-slip braking as a percentage of E2-01 [Motor Rated Current (FLA)], which represents the 100% value. Set the current suppression so that the drive's overload tolerance is not exceeded.	Determined by C6-01, L8-38 (0 - 200%)	879
n3-03 (058A)	HSB Dwell Time at Stop	<input type="checkbox"/> V/f <input type="checkbox"/> CL-V/f <input type="checkbox"/> OLV <input type="checkbox"/> CLV <input type="checkbox"/> AOLV <input type="checkbox"/> OLV/PM <input type="checkbox"/> AOLV/PM <input type="checkbox"/> CLV/PM <input type="checkbox"/> EZOLV This sets the dwell time, a period of time in which the motor has slowed down and runs at a steady speed, which occurs when the high-slip braking is nearing completion. For a predetermined amount of time only, the actual output frequency will be held at the minimum output frequency that was set for E1-09.	1.0 s (0.0 - 10.0 s)	879
n3-04 (058B)	High-Slip Braking Overload Time	<input type="checkbox"/> V/f <input type="checkbox"/> CL-V/f <input type="checkbox"/> OLV <input type="checkbox"/> CLV <input type="checkbox"/> AOLV <input type="checkbox"/> OLV/PM <input type="checkbox"/> AOLV/PM <input type="checkbox"/> CLV/PM <input type="checkbox"/> EZOLV Sets the time used for detection of oL7 [Motor Overload Protection During High Slip Braking], which is implemented at times when for some reason the output frequency did not change during high-slip braking. Normally there is no need to configure this setting.	40 s (30 - 1200 s)	879
n3-13 (0531)	Overexcitation Deceleration Gain	<input type="checkbox"/> V/f <input type="checkbox"/> CL-V/f <input type="checkbox"/> OLV <input type="checkbox"/> CLV <input type="checkbox"/> AOLV <input type="checkbox"/> OLV/PM <input type="checkbox"/> AOLV/PM <input type="checkbox"/> CLV/PM <input type="checkbox"/> EZOLV The overexcitation level is determined by multiplying the gain set by this parameter with the V/f pattern output value during overexcitation deceleration.	1.10 (1.00 - 1.40)	879
n3-14 (0532)	HarmInj@HiFlxBrk	<input type="checkbox"/> V/f <input type="checkbox"/> CL-V/f <input type="checkbox"/> OLV <input type="checkbox"/> CLV <input type="checkbox"/> AOLV <input type="checkbox"/> OLV/PM <input type="checkbox"/> AOLV/PM <input type="checkbox"/> CLV/PM <input type="checkbox"/> EZOLV Enables or disables the function that injects harmonic signals during overexcitation deceleration. 0 : Disabled 1 : Enabled	0 (0, 1)	880
n3-21 (0579)	High-SlipSuppression Current Lvl	<input type="checkbox"/> V/f <input type="checkbox"/> CL-V/f <input type="checkbox"/> OLV <input type="checkbox"/> CLV <input type="checkbox"/> AOLV <input type="checkbox"/> OLV/PM <input type="checkbox"/> AOLV/PM <input type="checkbox"/> CLV/PM <input type="checkbox"/> EZOLV This sets, as a percentage value, the upper limit of the current suppressed at the time of overexcitation deceleration, taking the drive rated current as a value of 100%.	100% (0 - 150%)	880
n3-23 (057B)	Overexcitation Operation Select	<input type="checkbox"/> V/f <input type="checkbox"/> CL-V/f <input type="checkbox"/> OLV <input type="checkbox"/> CLV <input type="checkbox"/> AOLV <input type="checkbox"/> OLV/PM <input type="checkbox"/> AOLV/PM <input type="checkbox"/> CLV/PM <input type="checkbox"/> EZOLV This parameter selects the direction of motor rotation of motors for which overexcitation operation is applied. 0 : Enabled in both directions 1 : Enabled only when rotating FWD 2 : Enabled only when in REV	0 (0 - 2)	880

◆ n4: Observer

No. (Hex.)	Name	Description	Default (Range)	Ref.
n4-60 (1B80)	Motoring Low Speed Comp Gain	<input type="checkbox"/> V/f <input type="checkbox"/> CL-V/f <input type="checkbox"/> OLV <input type="checkbox"/> CLV <input checked="" type="checkbox"/> AOLV <input type="checkbox"/> OLV/PM <input type="checkbox"/> AOLV/PM <input type="checkbox"/> CLV/PM <input type="checkbox"/> EZOLV This compensation gain improves the control characteristics for motoring loads in the low speed range.	100.0% (50.0 - 200.0%)	881
n4-61 (1B81)	Low Speed Comp Frequency Level	<input type="checkbox"/> V/f <input type="checkbox"/> CL-V/f <input type="checkbox"/> OLV <input type="checkbox"/> CLV <input checked="" type="checkbox"/> AOLV <input type="checkbox"/> OLV/PM <input type="checkbox"/> AOLV/PM <input type="checkbox"/> CLV/PM <input type="checkbox"/> EZOLV Set a frequency that enables the settings for n4-60 [Motoring Low Speed Comp Gain], n4-62 [Low Speed compensation Gain]. When the output frequency < n4-61, torque compensation is carried out in accordance with the settings for n4-60, n4-62. Normally there is no need to change this setting.	6.00 Hz (0.50 - 12.00 Hz)	881
n4-62 (1B82)	Regen Low Speed Comp Gain	<input type="checkbox"/> V/f <input type="checkbox"/> CL-V/f <input type="checkbox"/> OLV <input type="checkbox"/> CLV <input checked="" type="checkbox"/> AOLV <input type="checkbox"/> OLV/PM <input type="checkbox"/> AOLV/PM <input type="checkbox"/> CLV/PM <input type="checkbox"/> EZOLV This compensation gain improves the control characteristics for regenerative loads in the low speed range.	100.0% (50.0 - 200.0%)	881
n4-63 (1B83)	SpdEstimationResponseForHighFreq	<input type="checkbox"/> V/f <input type="checkbox"/> CL-V/f <input type="checkbox"/> OLV <input type="checkbox"/> CLV <input checked="" type="checkbox"/> AOLV <input type="checkbox"/> OLV/PM <input type="checkbox"/> AOLV/PM <input type="checkbox"/> CLV/PM <input type="checkbox"/> EZOLV In high speed ranges, where the output frequency is \geq n4-67 [SwitchingFreq for Estimation gain], this adjusts the responsiveness of the speed estimation.	60.0 (0.1 - 150.0)	881
n4-64 (1B84)	SpdEstimationResponse forLowFreq	<input type="checkbox"/> V/f <input type="checkbox"/> CL-V/f <input type="checkbox"/> OLV <input type="checkbox"/> CLV <input checked="" type="checkbox"/> AOLV <input type="checkbox"/> OLV/PM <input type="checkbox"/> AOLV/PM <input type="checkbox"/> CLV/PM <input type="checkbox"/> EZOLV In low speed ranges, where $0 \leq$ the output frequency, which is < n4-67 [SwitchingFreq for Estimation gain], this adjusts the responsiveness of the speed estimation.	60.0 (0.1 - 150.0)	882
n4-65 (1B85)	FluxEstimationResponseForHighFrq	<input type="checkbox"/> V/f <input type="checkbox"/> CL-V/f <input type="checkbox"/> OLV <input checked="" type="checkbox"/> CLV <input checked="" type="checkbox"/> AOLV <input type="checkbox"/> OLV/PM <input type="checkbox"/> AOLV/PM <input type="checkbox"/> CLV/PM <input type="checkbox"/> EZOLV In high speed ranges, where the output frequency is \geq n4-67 [SwitchingFreq for Estimation gain], this adjusts the responsiveness of the magnetic flux estimation. Normally there is no need to change this setting.	0.90 (0.50 - 1.50)	882
n4-66 (1B86)	FluxEstimationResponseForLowFreq	<input type="checkbox"/> V/f <input type="checkbox"/> CL-V/f <input type="checkbox"/> OLV <input checked="" type="checkbox"/> CLV <input checked="" type="checkbox"/> AOLV <input type="checkbox"/> OLV/PM <input type="checkbox"/> AOLV/PM <input type="checkbox"/> CLV/PM <input type="checkbox"/> EZOLV In low speed ranges, where $0 \leq$ the output frequency, which is < n4-67 [SwitchingFreq for Estimation gain], this adjusts the responsiveness of the magnetic flux estimation. Normally there is no need to change this setting.	0.90 (0.50 - 1.50)	882
n4-67 (1B87)	SwitchingFreq for Estimation gain	<input type="checkbox"/> V/f <input type="checkbox"/> CL-V/f <input type="checkbox"/> OLV <input checked="" type="checkbox"/> CLV <input checked="" type="checkbox"/> AOLV <input type="checkbox"/> OLV/PM <input type="checkbox"/> AOLV/PM <input type="checkbox"/> CLV/PM <input type="checkbox"/> EZOLV Set the switching frequency for estimation gain for each of the following: n4-63 [SpdEstimationResponseForHighFreq], n4-64 [SpdEstimationResponse forLowFreq], n4-65 [FluxEstimationResponseForHighFrq], and n4-66 [FluxEstimationResponseForLowFreq]. Normally there is no need to change this setting.	6.00 Hz (0.00 to E1-04)	882
n4-68 (1B88)	FilterTimeConst forSpdEstimation	<input type="checkbox"/> V/f <input type="checkbox"/> CL-V/f <input type="checkbox"/> OLV <input type="checkbox"/> CLV <input checked="" type="checkbox"/> AOLV <input type="checkbox"/> OLV/PM <input type="checkbox"/> AOLV/PM <input type="checkbox"/> CLV/PM <input type="checkbox"/> EZOLV Sets the primary delay time constant for the speed estimation value. Normally there is no need to change this setting.	0.001 s (0.001 - 0.010 s)	882
n4-69 (1B89)	Response of Flux loop	<input type="checkbox"/> V/f <input type="checkbox"/> CL-V/f <input type="checkbox"/> OLV <input type="checkbox"/> CLV <input checked="" type="checkbox"/> AOLV <input type="checkbox"/> OLV/PM <input type="checkbox"/> AOLV/PM <input type="checkbox"/> CLV/PM <input type="checkbox"/> EZOLV Stabilizes motor vibrations through unified control of magnetic flux.	1.00 (0.00 - 60.00)	883
n4-70 (1B8A)	Speed Command Comp @ Low Freq	<input type="checkbox"/> V/f <input type="checkbox"/> CL-V/f <input type="checkbox"/> OLV <input type="checkbox"/> CLV <input checked="" type="checkbox"/> AOLV <input type="checkbox"/> OLV/PM <input type="checkbox"/> AOLV/PM <input type="checkbox"/> CLV/PM <input type="checkbox"/> EZOLV Adjust this to improve stability when running at low speeds. Normally there is no need to change this setting.	0.60 Hz (0.00 - 1.50 Hz)	883
n4-72 (1B8C)	PG Mode	<input type="checkbox"/> V/f <input type="checkbox"/> CL-V/f <input type="checkbox"/> OLV <input type="checkbox"/> CLV <input checked="" type="checkbox"/> AOLV <input type="checkbox"/> OLV/PM <input type="checkbox"/> AOLV/PM <input type="checkbox"/> CLV/PM <input type="checkbox"/> EZOLV Select whether an encoder option is to be connected or not when set to A1-02 = 4 [Control Method Selection = Advanced OpenLoop Vector Control]. 0 : WithOut PG 1 : With PG	0 (0, 1)	883
n4-73 (1B8D)	PGO ret ope	<input type="checkbox"/> V/f <input type="checkbox"/> CL-V/f <input type="checkbox"/> OLV <input type="checkbox"/> CLV <input checked="" type="checkbox"/> AOLV <input type="checkbox"/> OLV/PM <input type="checkbox"/> AOLV/PM <input type="checkbox"/> CLV/PM <input type="checkbox"/> EZOLV If the encoder is disconnected, this determines whether the drive is to restart in the WithOut PG mode, or is to restart in the With PG mode. 0 : WithOut PG 1 : With PG	0 (0, 1)	883
n4-74 (1B8E)	Limit of Flux loop	<input type="checkbox"/> V/f <input type="checkbox"/> CL-V/f <input type="checkbox"/> OLV <input type="checkbox"/> CLV <input checked="" type="checkbox"/> AOLV <input type="checkbox"/> OLV/PM <input type="checkbox"/> AOLV/PM <input type="checkbox"/> CLV/PM <input type="checkbox"/> EZOLV Sets the control level for flux loop control output.	160% (100 to 500%)	884

◆ n5: Feed Forward Control

No. (Hex.)	Name	Description	Default (Range)	Ref.
n5-01 (05B0)	Feedforward Control Selection	<input type="checkbox"/> V/f <input type="checkbox"/> CL-V/f <input type="checkbox"/> OLV <input checked="" type="checkbox"/> CLV <input type="checkbox"/> AOLV <input type="checkbox"/> OLV/PM <input type="checkbox"/> AOLV/PM <input type="checkbox"/> CLV/PM <input type="checkbox"/> EZOLV Enables and disables the Feedforward function. 0 : Disabled 1 : Enabled	0 (0, 1)	885
n5-02 (05B1)	Motor Acceleration Time	<input type="checkbox"/> V/f <input type="checkbox"/> CL-V/f <input type="checkbox"/> OLV <input checked="" type="checkbox"/> CLV <input type="checkbox"/> AOLV <input type="checkbox"/> OLV/PM <input type="checkbox"/> AOLV/PM <input type="checkbox"/> CLV/PM <input type="checkbox"/> EZOLV Set the time required for the motor to accelerate from the stopped state to the maximum frequency when using a single motor at the rated torque. The motor acceleration time is automatically set by Inertia Tuning.	Determined by C6-01, E5-01, and o2-04 (0.001 - 10.000 s)	885
n5-03 (05B2)	Feedforward Control Gain	<input type="checkbox"/> V/f <input type="checkbox"/> CL-V/f <input type="checkbox"/> OLV <input checked="" type="checkbox"/> CLV <input type="checkbox"/> AOLV <input type="checkbox"/> OLV/PM <input type="checkbox"/> AOLV/PM <input type="checkbox"/> CLV/PM <input type="checkbox"/> EZOLV This parameter sets the ratio between load inertia and motor inertia. The Feedforward Control Gain value is automatically set by Inertia Tuning.	1.00 (0.00 - 100.00)	886
n5-04 (05B3) RUN	Spd Response F	<input type="checkbox"/> V/f <input type="checkbox"/> CL-V/f <input type="checkbox"/> OLV <input checked="" type="checkbox"/> CLV <input type="checkbox"/> AOLV <input type="checkbox"/> OLV/PM <input type="checkbox"/> AOLV/PM <input type="checkbox"/> CLV/PM <input type="checkbox"/> EZOLV Sets the response frequency for the speed reference in increments of 0.01 Hz. Normally there is no need to configure this setting.	Determined by A1-02 (0.00 - 500.00 Hz)	886

◆ n6: Online Tuning

No. (Hex.)	Name	Description	Default (Range)	Ref.
n6-01 (0570)	Online Tuning Selection	<input type="checkbox"/> V/f <input type="checkbox"/> CL-V/f <input checked="" type="checkbox"/> OLV <input type="checkbox"/> CLV <input type="checkbox"/> AOLV <input type="checkbox"/> OLV/PM <input type="checkbox"/> AOLV/PM <input type="checkbox"/> CLV/PM <input type="checkbox"/> EZOLV Selects the type of motor data Online Tuning uses for OLV control. 0 : Disabled 1 : Line-to-line resistance tuning 2 : VoltageAdjustm	0 (0 - 2)	887
n6-05 (05C7)	Online Tuning Gain	<input type="checkbox"/> V/f <input type="checkbox"/> CL-V/f <input checked="" type="checkbox"/> OLV <input type="checkbox"/> CLV <input type="checkbox"/> AOLV <input type="checkbox"/> OLV/PM <input type="checkbox"/> AOLV/PM <input type="checkbox"/> CLV/PM <input type="checkbox"/> EZOLV Sets the compensation gain when set to $n6-01 = 2$ [Online Tuning Selection = VoltageAdjustm]. Normally there is no need to configure this setting.	1.0 (0.1 - 50.0)	887
n6-11 (1B56)	online resister tuning	<input type="checkbox"/> V/f <input type="checkbox"/> CL-V/f <input type="checkbox"/> OLV <input checked="" type="checkbox"/> CLV <input type="checkbox"/> AOLV <input type="checkbox"/> OLV/PM <input type="checkbox"/> AOLV/PM <input type="checkbox"/> CLV/PM <input type="checkbox"/> EZOLV Adjusts the responsiveness for online resister tuning. To be enabled, the value should be set to approximately 1.000. This is disabled if the value is set to 0.	0.000 (0.000 - 1.000)	887

◆ n7: EZ Drive

No. (Hex.)	Name	Description	Default (Range)	Ref.
n7-01 (3111)	Flux Estimation Cut-off Freq	<input type="checkbox"/> V/f <input type="checkbox"/> CL-V/f <input type="checkbox"/> OLV <input type="checkbox"/> CLV <input type="checkbox"/> AOLV <input type="checkbox"/> OLV/PM <input type="checkbox"/> AOLV/PM <input type="checkbox"/> CLV/PM <input checked="" type="checkbox"/> EZOLV Sets the oscillation suppression gain for the low speed range.	1.0 (0.1 - 10.0)	887
n7-05 (3115)	Torque Control Response Gain	<input type="checkbox"/> V/f <input type="checkbox"/> CL-V/f <input type="checkbox"/> OLV <input type="checkbox"/> CLV <input type="checkbox"/> AOLV <input type="checkbox"/> OLV/PM <input type="checkbox"/> AOLV/PM <input type="checkbox"/> CLV/PM <input checked="" type="checkbox"/> EZOLV Sets the response gain relative to load changes.	100 (10 - 1000)	887
n7-07 (3117)	PLL response 1	<input type="checkbox"/> V/f <input type="checkbox"/> CL-V/f <input type="checkbox"/> OLV <input type="checkbox"/> CLV <input type="checkbox"/> AOLV <input type="checkbox"/> OLV/PM <input type="checkbox"/> AOLV/PM <input type="checkbox"/> CLV/PM <input checked="" type="checkbox"/> EZOLV Sets the speed calculation gain during normal operation. Normally there is no need to change this setting.	15.0 Hz (1.0 - 50.0 Hz)	888
n7-08 (3118)	PLL response 2	<input type="checkbox"/> V/f <input type="checkbox"/> CL-V/f <input type="checkbox"/> OLV <input type="checkbox"/> CLV <input type="checkbox"/> AOLV <input type="checkbox"/> OLV/PM <input type="checkbox"/> AOLV/PM <input type="checkbox"/> CLV/PM <input checked="" type="checkbox"/> EZOLV Sets the speed calculation gain during a speed search.	25.0 Hz (1.0 - 50.0 Hz)	888

No. (Hex.)	Name	Description	Default (Range)	Ref.
n7-10 (311A)	Sensorless Switchover StartSpeed	V/f CL-V/f OLV CLV AOLV OLV/PM AOLV/PM CLV/PM EZOLV The speed range within which pull-in current commands are enabled is set as a proportion relative to the rated frequency.	10.0% (0.0 - 100.0%)	888
n7-17 (3122)	Resistance Temperature Correction	V/f CL-V/f OLV CLV AOLV OLV/PM AOLV/PM CLV/PM EZOLV Selects the function for compensating for changes in the motor resistance value caused by temperature fluctuations. 0 : Invalid 1 : Valid (Only 1 time) 2 : Valid (Every time)	1 (0 - 2)	888

◆ n8: PM Motor Control Tuning

No. (Hex.)	Name	Description	Default (Range)	Ref.
n8-01 (0540)	Init Rotor Position Est Current	V/f CL-V/f OLV CLV AOLV OLV/PM AOLV/PM CLV/PM EZOLV Sets, as a percentage, the Initial Rotor Position Estimated Current, taking the E5-03 [Motor Rated Current (FLA)] as the 100% value. Normally there is no need to change this setting.	50% (0 - 100%)	888
n8-02 (0541)	Pole Attraction Current	V/f CL-V/f OLV CLV AOLV OLV/PM AOLV/PM CLV/PM EZOLV Sets the current at the time of polar attraction as a percentage of the motor rated current, which is deemed to be 100%. Normally there is no need to change this setting.	80% (0 - 150%)	889
n8-03 (0542)	Current Starting Time	V/f CL-V/f OLV CLV AOLV OLV/PM AOLV/PM CLV/PM EZOLV Sets the amount for the Current Starting Time, which is used when carrying out Z Pulse Offset Tuning. Normally there is no need to change this setting.	1.5 s (1.5 - 5.0 s)	889
n8-04 (0543)	Polar Attraction Time	V/f CL-V/f OLV CLV AOLV OLV/PM AOLV/PM CLV/PM EZOLV Sets the amount for the Polar Attraction Time, which is used when carrying out Z Pulse Offset Tuning. Normally there is no need to change this setting.	1.5 s (1.5 - 5.0 s)	889
n8-11 (054A)	Induction Volt Estimation Gain 2	V/f CL-V/f OLV CLV AOLV OLV/PM AOLV/PM CLV/PM EZOLV Sets the gain for speed estimation. Normally there is no need to change this setting.	Determined by n8-72 (0.0 - 1000.0)	889
n8-14 (054D)	Polarity Compensation Gain 3	V/f CL-V/f OLV CLV AOLV OLV/PM AOLV/PM CLV/PM EZOLV Sets the gain for speed estimation. Normally there is no need to change this setting.	1.000 (0.000 - 10.000)	890
n8-15 (054E)	Polarity Compensation Gain 4	V/f CL-V/f OLV CLV AOLV OLV/PM AOLV/PM CLV/PM EZOLV Sets the gain for speed estimation. Normally there is no need to change this setting.	0.500 (0.000 - 10.000)	890
n8-21 (0554)	Motor Ke Gain	V/f CL-V/f OLV CLV AOLV OLV/PM AOLV/PM CLV/PM EZOLV Sets the gain for speed estimation. Normally there is no need to change this setting.	0.90 (0.80 - 1.00)	890
n8-35 (0562)	InitRotorPosition Detect Select	V/f CL-V/f OLV CLV AOLV OLV/PM AOLV/PM CLV/PM EZOLV Selects how the rotor position is detected at start. Note: Select a value of 0 if using SPM motors. Values between 0 to 2 can be selected if using IPM motors. 0 : Pull-In 1 : High frequency injection 2 : Pulse injection	Determined by A1-02 (0 - 2)	890
n8-36 (0563)	InjectionSignal FreqForInductTurn	V/f CL-V/f OLV CLV AOLV OLV/PM AOLV/PM CLV/PM EZOLV Sets the injection frequency for high frequency injection.	500 Hz (200 - 5000 Hz)	890
n8-37 (0564)	High Freq Injection Amplitude	V/f CL-V/f OLV CLV AOLV OLV/PM AOLV/PM CLV/PM EZOLV Considering 200 V to be the 100% value with a 200 V class unit, and 400 V to be 100% with a 400 V class unit, set the high frequency injection amplitude as a percentage value. Normally there is no need to change this setting.	20.0% (0.0 - 50.0%)	891
n8-41 (0568)	HFI Overlap Pole Detection Pgain	V/f CL-V/f OLV CLV AOLV OLV/PM AOLV/PM CLV/PM EZOLV Sets the speed estimation response for high frequency injection. Normally there is no need to change this setting.	3.0 (1.0 - 100.0)	891

No. (Hex.)	Name	Description	Default (Range)	Ref.
n8-42 (0569)	HFI Overlap Pole Detection iTime	<input type="checkbox"/> V/f <input type="checkbox"/> CL-V/f <input type="checkbox"/> OLV <input type="checkbox"/> CLV <input type="checkbox"/> AOLV <input checked="" type="checkbox"/> OLV/PM <input type="checkbox"/> AOLV/PM <input type="checkbox"/> CLV/PM <input type="checkbox"/> EZOLV Sets the oscillation suppression gain of the speed estimation for high frequency injection. Normally there is no need to change this setting.	1.0 (0.1 - 5.0)	891
n8-45 (0538)	Spd Feedback Detect Control Gain	<input type="checkbox"/> V/f <input type="checkbox"/> CL-V/f <input type="checkbox"/> OLV <input type="checkbox"/> CLV <input type="checkbox"/> AOLV <input checked="" type="checkbox"/> OLV/PM <input type="checkbox"/> AOLV/PM <input type="checkbox"/> CLV/PM <input type="checkbox"/> EZOLV Sets the internal speed feedback detection reduction unit gain as a magnification value. Normally there is no need to change this setting.	0.80 (0.00 - 10.00)	891
n8-47 (053A)	Pull-InCurCompensationTime Const	<input type="checkbox"/> V/f <input type="checkbox"/> CL-V/f <input type="checkbox"/> OLV <input type="checkbox"/> CLV <input type="checkbox"/> AOLV <input checked="" type="checkbox"/> OLV/PM <input type="checkbox"/> AOLV/PM <input type="checkbox"/> CLV/PM <input type="checkbox"/> EZOLV Sets the time constant used to match the pull-in current reference value with the actual current value. Normally there is no need to change this setting.	5.0 s (0.0 - 100.0 s)	891
n8-48 (053B)	Pull-In Current (for PM Motors)	<input type="checkbox"/> V/f <input type="checkbox"/> CL-V/f <input type="checkbox"/> OLV <input type="checkbox"/> CLV <input type="checkbox"/> AOLV <input checked="" type="checkbox"/> OLV/PM <input type="checkbox"/> AOLV/PM <input type="checkbox"/> CLV/PM <input type="checkbox"/> EZOLV On the basis that parameter E5-03 [Motor Rated Current (FLA)] is the 100% value, this parameter sets the d-axis current that flows to the motor during run at constant speed as a percentage.	30% (20 - 200%)	892
n8-49 (053C)	d-Axis Cur forHighEfficiency Cont	<input type="checkbox"/> V/f <input type="checkbox"/> CL-V/f <input type="checkbox"/> OLV <input type="checkbox"/> CLV <input type="checkbox"/> AOLV <input checked="" type="checkbox"/> OLV/PM <input type="checkbox"/> AOLV/PM <input type="checkbox"/> CLV/PM <input type="checkbox"/> EZOLV Sets, in terms of a percentage, the d-axis current to be supplied to the motor to run it at a uniform speed with a heavy load. Considers E5-03 [Motor Rated Current] to be 100%. Normally there is no need to change this setting.	Determined by E5-01 (-200.0 - 0.0%)	892
n8-51 (053E)	Accel / Decel Pull-In Current	<input type="checkbox"/> V/f <input type="checkbox"/> CL-V/f <input type="checkbox"/> OLV <input type="checkbox"/> CLV <input type="checkbox"/> AOLV <input checked="" type="checkbox"/> OLV/PM <input type="checkbox"/> AOLV/PM <input type="checkbox"/> CLV/PM <input checked="" type="checkbox"/> EZOLV Sets, as a percentage, the pull-in current allowed to flow during acceleration/deceleration, taking the motor rated current as a value of 100%.	Determined by A1-02 (0 - 200%)	892
n8-54 (056D)	VoltErrorCompensationTime Const	<input type="checkbox"/> V/f <input type="checkbox"/> CL-V/f <input type="checkbox"/> OLV <input type="checkbox"/> CLV <input type="checkbox"/> AOLV <input checked="" type="checkbox"/> OLV/PM <input type="checkbox"/> AOLV/PM <input type="checkbox"/> CLV/PM <input type="checkbox"/> EZOLV Sets the time constant used when compensating for voltage errors.	1.00 s (0.00 - 10.00 s)	892
n8-55 (056E)	Load Inertia	<input type="checkbox"/> V/f <input type="checkbox"/> CL-V/f <input type="checkbox"/> OLV <input type="checkbox"/> CLV <input type="checkbox"/> AOLV <input checked="" type="checkbox"/> OLV/PM <input type="checkbox"/> AOLV/PM <input type="checkbox"/> CLV/PM <input type="checkbox"/> EZOLV This parameter sets the ratio between motor inertia and machine inertia. 0 : Below 1:10 1 : Between 1:10 and 1:30 2 : Between 1:30 and 1:50 3 : Beyond 1:50	0 (0 - 3)	893
n8-57 (0574)	High Frequency Injection	<input type="checkbox"/> V/f <input type="checkbox"/> CL-V/f <input type="checkbox"/> OLV <input type="checkbox"/> CLV <input type="checkbox"/> AOLV <input checked="" type="checkbox"/> OLV/PM <input type="checkbox"/> AOLV/PM <input type="checkbox"/> CLV/PM <input type="checkbox"/> EZOLV Selects whether to perform a high frequency injection to detect motor speed. 0 : Disabled 1 : Enabled	0 (0, 1)	893
n8-62 (057D)	Output Voltage Limit (for PM)	<input type="checkbox"/> V/f <input type="checkbox"/> CL-V/f <input type="checkbox"/> OLV <input type="checkbox"/> CLV <input type="checkbox"/> AOLV <input checked="" type="checkbox"/> OLV/PM <input type="checkbox"/> AOLV/PM <input type="checkbox"/> CLV/PM <input checked="" type="checkbox"/> EZOLV To prevent saturation of the output voltage, set the output voltage limit. Normally there is no need to configure this setting.	200 V Class: 200.0 V, 400 V Class: 400.0 V (200 V Class: 0.0 - 230.0 V, 400 V Class: 0.0 - 460.0 V)	894
n8-65 (065C)	SpdFdbkDetectCtrl GainduringOVSup	<input type="checkbox"/> V/f <input type="checkbox"/> CL-V/f <input type="checkbox"/> OLV <input type="checkbox"/> CLV <input type="checkbox"/> AOLV <input checked="" type="checkbox"/> OLV/PM <input type="checkbox"/> AOLV/PM <input type="checkbox"/> CLV/PM <input type="checkbox"/> EZOLV Sets the gain of internal speed feedback detection suppression while the overvoltage suppression function is working, as a magnification value. Normally there is no need to configure this setting.	1.50 (0.00 - 10.00)	894
n8-69 (065D)	Speed Calculation Gain	<input type="checkbox"/> V/f <input type="checkbox"/> CL-V/f <input type="checkbox"/> OLV <input type="checkbox"/> CLV <input type="checkbox"/> AOLV <input checked="" type="checkbox"/> OLV/PM <input type="checkbox"/> AOLV/PM <input type="checkbox"/> CLV/PM <input type="checkbox"/> EZOLV Sets the gain used for speed estimation. Normally there is no need to change this setting.	1.00 (0.00 - 20.00)	894
n8-72 (0655)	Speed Estimation Method Select	<input type="checkbox"/> V/f <input type="checkbox"/> CL-V/f <input type="checkbox"/> OLV <input type="checkbox"/> CLV <input type="checkbox"/> AOLV <input checked="" type="checkbox"/> OLV/PM <input type="checkbox"/> AOLV/PM <input type="checkbox"/> CLV/PM <input type="checkbox"/> EZOLV Selects the speed estimation method. Normally there is no need to change this setting. 0 : Conventional method 1 : A1000 method	1 (0, 1)	894
n8-74 (05C3)	LghtLoadCurLvl 1	<input type="checkbox"/> V/f <input type="checkbox"/> CL-V/f <input type="checkbox"/> OLV <input type="checkbox"/> CLV <input type="checkbox"/> AOLV <input checked="" type="checkbox"/> OLV/PM <input type="checkbox"/> AOLV/PM <input type="checkbox"/> CLV/PM <input type="checkbox"/> EZOLV Set n8-48 [Pull-In Current (for PM Motors)] to the level of the load current (q-axis current) to be applied.	30% (0 - 255%)	894

No. (Hex.)	Name	Description	Default (Range)	Ref.
n8-75 (05C4)	LghtLoadCurLvl 2	<input type="checkbox"/> V/f <input type="checkbox"/> CL-V/f <input type="checkbox"/> OLV <input type="checkbox"/> CLV <input type="checkbox"/> AOLV <input checked="" type="checkbox"/> OLV/PM <input type="checkbox"/> AOLV/PM <input type="checkbox"/> CLV/PM <input type="checkbox"/> EZOLV Set n8-78 [MedLoad Id Level] to the level of the load current (q-axis current) to be applied.	50% (0 - 255%)	894
n8-77 (05CE)	IPM HiEffCtrLev2	<input type="checkbox"/> V/f <input type="checkbox"/> CL-V/f <input type="checkbox"/> OLV <input type="checkbox"/> CLV <input type="checkbox"/> AOLV <input checked="" type="checkbox"/> OLV/PM <input type="checkbox"/> AOLV/PM <input type="checkbox"/> CLV/PM <input type="checkbox"/> EZOLV Set n8-49 [d-Axis Cur forHighEfficiencyCont] to the level of the load current (q-axis current) to be applied.	90% (0 - 255%)	895
n8-78 (05F4)	MedLoad Id Level	<input type="checkbox"/> V/f <input type="checkbox"/> CL-V/f <input type="checkbox"/> OLV <input type="checkbox"/> CLV <input type="checkbox"/> AOLV <input checked="" type="checkbox"/> OLV/PM <input type="checkbox"/> AOLV/PM <input type="checkbox"/> CLV/PM <input type="checkbox"/> EZOLV Sets the level of the pull-in current for midrange loads.	0% (0 - 255%)	895
n8-84 (02D3)	InitPolarityEstimationTimeoutCur	<input type="checkbox"/> V/f <input type="checkbox"/> CL-V/f <input type="checkbox"/> OLV <input type="checkbox"/> CLV <input type="checkbox"/> AOLV <input checked="" type="checkbox"/> OLV/PM <input type="checkbox"/> AOLV/PM <input type="checkbox"/> CLV/PM <input type="checkbox"/> EZOLV Sets, as a percentage, the current for processing an estimation of the initial motor magnetic pole, assuming that the E5-03 [PM Motor Rated Current (FLA)] is the 100% value.	100% (0 - 150%)	895
n8-94 (012D)	Selection of Recognition Criteria	<input type="checkbox"/> V/f <input type="checkbox"/> CL-V/f <input type="checkbox"/> OLV <input type="checkbox"/> CLV <input type="checkbox"/> AOLV <input type="checkbox"/> OLV/PM <input type="checkbox"/> AOLV/PM <input type="checkbox"/> CLV/PM <input type="checkbox"/> EZOLV Choose the criteria for recognizing changes in speed or load. Normally there is no need to change this setting. 0 : Softstarter 1 : Speed feedback	Determined by d5-01 (0, 1)	895
n8-95 (012E)	Observer Estimation TimeConstant	<input type="checkbox"/> V/f <input type="checkbox"/> CL-V/f <input type="checkbox"/> OLV <input type="checkbox"/> CLV <input type="checkbox"/> AOLV <input type="checkbox"/> OLV/PM <input checked="" type="checkbox"/> AOLV/PM <input type="checkbox"/> CLV/PM <input type="checkbox"/> EZOLV Sets the time constant of the filter used with respect to the recognition criteria value for speed and load changes. Normally there is no need to change this setting.	30 ms (0 - 100 ms)	896

10.13 o: Keypad-Related Settings

◆ o1: Keypad Display Selection

No. (Hex.)	Name	Description	Default Setting (Setting Range)	Ref.
o1-01 (0500) RUN	Drive Mode Unit Monitor Select	<p><input type="checkbox"/> V/f <input type="checkbox"/> CL-V/f <input type="checkbox"/> OLV <input type="checkbox"/> CLV <input type="checkbox"/> AOLV <input type="checkbox"/> OLV/PM <input type="checkbox"/> AOLV/PM <input type="checkbox"/> CLV/PM <input type="checkbox"/> EZOLV</p> <p>Configure the <i>U</i> monitor that appears for the Drive Mode. This parameter is only enabled for LED keypads.</p> <p>Note: <i>U2</i> monitor [Fault Trace] and <i>U3</i> Monitor [Fault History] cannot be selected.</p>	106 (104 - 855)	898
o1-02 (0501) RUN	User Monitor Select afterPowerUp	<p><input type="checkbox"/> V/f <input type="checkbox"/> CL-V/f <input type="checkbox"/> OLV <input type="checkbox"/> CLV <input type="checkbox"/> AOLV <input type="checkbox"/> OLV/PM <input type="checkbox"/> AOLV/PM <input type="checkbox"/> CLV/PM <input type="checkbox"/> EZOLV</p> <p>Selects the monitor item initially displayed when the drive is energized. Refer to "U: Monitors" for more information on monitor items that can be displayed. This parameter is only enabled for LED keypads.</p> <p>1 : Frequency reference (U1-01) 2 : Direction 3 : Output frequency (U1-02) 4 : Output current (U1-03) 5 : UserSelect Monitor(set by o1-01)</p>	1 (1 - 5)	898
o1-03 (0502)	Keypad Display Selection	<p><input type="checkbox"/> V/f <input type="checkbox"/> CL-V/f <input type="checkbox"/> OLV <input type="checkbox"/> CLV <input type="checkbox"/> AOLV <input type="checkbox"/> OLV/PM <input type="checkbox"/> AOLV/PM <input type="checkbox"/> CLV/PM <input type="checkbox"/> EZOLV</p> <p>Selects the display units for the frequency reference and output frequency.</p> <p>0 : 0.01 Hz 1 : 0.01% (100% = E1-04) 2 : r/min 3 : User-selected units</p>	Determined by A1-02 (0 - 3)	898
o1-04 (0503)	V/f Pattern Display Unit	<p><input type="checkbox"/> V/f <input type="checkbox"/> CL-V/f <input type="checkbox"/> OLV <input type="checkbox"/> CLV <input type="checkbox"/> AOLV <input type="checkbox"/> OLV/PM <input type="checkbox"/> AOLV/PM <input type="checkbox"/> CLV/PM <input type="checkbox"/> EZOLV</p> <p>Select the setting unit of parameters that configure the V/f pattern frequency.</p> <p>0 : Hz 1 : r/min</p>	Determined by A1-02 (0, 1)	899
o1-05 (0504) RUN	LCD Contrast adjustment	<p><input type="checkbox"/> V/f <input type="checkbox"/> CL-V/f <input type="checkbox"/> OLV <input type="checkbox"/> CLV <input type="checkbox"/> AOLV <input type="checkbox"/> OLV/PM <input type="checkbox"/> AOLV/PM <input type="checkbox"/> CLV/PM <input type="checkbox"/> EZOLV</p> <p>Configures the LCD display contrast.</p>	3 (0 - 5)	899
o1-10 (0520)	User-Set Display Units Max Value	<p><input type="checkbox"/> V/f <input type="checkbox"/> CL-V/f <input type="checkbox"/> OLV <input type="checkbox"/> CLV <input type="checkbox"/> AOLV <input type="checkbox"/> OLV/PM <input type="checkbox"/> AOLV/PM <input type="checkbox"/> CLV/PM <input type="checkbox"/> EZOLV</p> <p>Configures the value displayed for the maximum output frequency.</p>	Determined by o1-03 (1 - 60000)	899
o1-11 (0521)	User-SetDisplayUnits Dec Display	<p><input type="checkbox"/> V/f <input type="checkbox"/> CL-V/f <input type="checkbox"/> OLV <input type="checkbox"/> CLV <input type="checkbox"/> AOLV <input type="checkbox"/> OLV/PM <input type="checkbox"/> AOLV/PM <input type="checkbox"/> CLV/PM <input type="checkbox"/> EZOLV</p> <p>Configures the number of decimal places for frequency reference and monitor values.</p> <p>0 : No Dec (XXXXXX) 1 : 1 Dec (XXXX.X) 2 : 2 Dec (XXX.XX) 3 : 3 Dec (XX.XXX)</p>	Determined by o1-03 (0 - 3)	900
o1-24 to o1-35 (11AD to 11B8) RUN	1st to 12th Monitor Settings	<p><input type="checkbox"/> V/f <input type="checkbox"/> CL-V/f <input type="checkbox"/> OLV <input type="checkbox"/> CLV <input type="checkbox"/> AOLV <input type="checkbox"/> OLV/PM <input type="checkbox"/> AOLV/PM <input type="checkbox"/> CLV/PM <input type="checkbox"/> EZOLV</p> <p>Up to a maximum of 12 desired monitors can be selected as user monitors. This parameter is only enabled for LED keypads.</p>	o1-24: 101 o1-25: 102 o1-26: 103 o1-27 to o1-35: 000 (000, 101 - 825)	900
o1-36 (11B9) RUN	LCD backlight adjustment	<p><input type="checkbox"/> V/f <input type="checkbox"/> CL-V/f <input type="checkbox"/> OLV <input type="checkbox"/> CLV <input type="checkbox"/> AOLV <input type="checkbox"/> OLV/PM <input type="checkbox"/> AOLV/PM <input type="checkbox"/> CLV/PM <input type="checkbox"/> EZOLV</p> <p>Configures the brightness of the LCD keypad backlight.</p>	3 (1 - 5)	900

No. (Hex.)	Name	Description	Default Setting (Setting Range)	Ref.
o1-37 (11BA) RUN	LCD backlight ON/OFF Selection	V/f CL-V/f OLV CLV AOLV OLV/PM AOLV/PM CLV/PM EZOLV Selects the operation of the LCD backlight automatic shut off function. 0 : OFF 1 : ON	1 (0, 1)	900
o1-38 (11BB) RUN	Time to turn off LCD backlight	V/f CL-V/f OLV CLV AOLV OLV/PM AOLV/PM CLV/PM EZOLV Configures the time at which the LCD backlight automatically turns off.	60 s (10 - 300 s)	901
o1-39 (11BC)	Initial setup display selection	V/f CL-V/f OLV CLV AOLV OLV/PM AOLV/PM CLV/PM EZOLV Selects whether or not to display the LCD keypad initial setup screen every time the power is turned on. This parameter is only enabled for LED keypads. 0 : No 1 : Yes	1 (0, 1)	901
o1-40 (11BD) RUN	Home display selection	V/f CL-V/f OLV CLV AOLV OLV/PM AOLV/PM CLV/PM EZOLV Selects the monitor display mode used to display the Home screen. This parameter is only enabled for LED keypads. 0 : Custom Monitor 1 : Bar Graph 2 : Line Graph / XY Plot	0 (0 - 2)	901
o1-41 (11C1) RUN	1st Monitor Min Setting	V/f CL-V/f OLV CLV AOLV OLV/PM AOLV/PM CLV/PM EZOLV Selects the horizontal axis used to display the monitor configured with o1-24 as a bar graph. This parameter is only enabled for LED keypads. 0 : + - Area (- o1-42 ~ o1-42) 1 : + Area (0 ~ o1-42) 2 : - Area (- o1-42 ~ 0)	0 (0 - 2)	901
o1-42 (11C2) RUN	1st Monitor Max Setting	V/f CL-V/f OLV CLV AOLV OLV/PM AOLV/PM CLV/PM EZOLV Configures the setting value for the horizontal axis used to display the monitor configured with o1-24 as a bar graph. This parameter is only enabled for LED keypads.	100.0% (0.0 - 100.0%)	902
o1-43 (1131) RUN	2nd Monitor Min Setting	V/f CL-V/f OLV CLV AOLV OLV/PM AOLV/PM CLV/PM EZOLV Selects the horizontal axis used to display the monitor configured with o1-25 as a bar graph. This parameter is only enabled for LED keypads. 0 : + - Area (- o1-46 ~ o1-46) 1 : + Area (0 ~ o1-46) 2 : - Area (- o1-46 ~ 0)	0 (0 - 2)	902
o1-44 (11C4) RUN	2nd Monitor Max Setting	V/f CL-V/f OLV CLV AOLV OLV/PM AOLV/PM CLV/PM EZOLV Configures the setting value for the horizontal axis used to display the monitor configured with o1-25 as a bar graph. This parameter is only enabled for LED keypads.	100.0% (0.0 - 100.0%)	902
o1-45 (11C5) RUN	3rd Monitor Min Setting	V/f CL-V/f OLV CLV AOLV OLV/PM AOLV/PM CLV/PM EZOLV Selects the horizontal axis used to display the monitor configured with o1-26 as a bar graph. This parameter is only enabled for LED keypads. 0 : + - Area (- o1-46 ~ o1-46) 1 : + Area (0 ~ o1-46) 2 : - Area (- o1-46 ~ 0)	0 (0 - 2)	902
o1-46 (11C6) RUN	3rd Monitor Max Setting	V/f CL-V/f OLV CLV AOLV OLV/PM AOLV/PM CLV/PM EZOLV Configures the setting value for the horizontal axis used to display the monitor configured with o1-26 as a bar graph. This parameter is only enabled for LED keypads.	100.0% (0.0 - 100.0%)	902
o1-55 (11EE) RUN	Analog Gauge Min Setting	V/f CL-V/f OLV CLV AOLV OLV/PM AOLV/PM CLV/PM EZOLV Selects the region used to display the monitor configured with o1-24 [1st Monitor Setting] as an analog meter. This parameter is only enabled for LED keypads.	1 (1)	902
o1-56 (11EF) RUN	Analog Gauge Area Setting	V/f CL-V/f OLV CLV AOLV OLV/PM AOLV/PM CLV/PM EZOLV Configures the setting value used when displaying the monitor configured with o1-24 [1st Monitor Setting] as an analog meter. This parameter is only enabled for LED keypads.	100.0% (0.0 - 100.0%)	903

◆ o2: Keypad Operation

No. (Hex.)	Name	Description	Default (Range)	Ref.
o2-01 (0505)	LO/RE Key Function Selection	<p>V/f CL-V/f OLV CLV AOLV OLV/PM AOLV/PM CLV/PM EZOLV</p> <p>Selects whether to enable or disable switching between local and remote modes via LO/RE.</p> <p>0 : Disabled 1 : Enabled</p>	1 (0, 1)	903
o2-02 (0506)	STOP Key Function Selection	<p>V/f CL-V/f OLV CLV AOLV OLV/PM AOLV/PM CLV/PM EZOLV</p> <p>Selects whether or not to enable functionality of the STOP on the keypad when the Run command source for the drive is set to REMOTE (external) and not assigned to the keypad.</p> <p>0 : Disabled 1 : Enabled</p>	1 (0, 1)	903
o2-03 (0507)	User Parameter Default Value	<p>V/f CL-V/f OLV CLV AOLV OLV/PM AOLV/PM CLV/PM EZOLV</p> <p>Changed parameter setting values are stored as the user parameter default settings used when the drive is initialized.</p> <p>0 : No change 1 : Set defaults 2 : Clear all</p>	0 (0 - 2)	904
o2-04 (0508)	Drive Model Selection	<p>V/f CL-V/f OLV CLV AOLV OLV/PM AOLV/PM CLV/PM EZOLV</p> <p>Configures the Drive Model code for the corresponding Drive Model. This parameter must be configured when control boards are replaced.</p>	Determined by the drive (-)	904
o2-05 (0509)	Freq Ref Setting Method Select	<p>V/f CL-V/f OLV CLV AOLV OLV/PM AOLV/PM CLV/PM EZOLV</p> <p>Selects whether or not the  must be pressed to change the frequency reference value with the keypad when in Drive Mode.</p> <p>0 : Disabled 1 : Enabled</p>	0 (0, 1)	904
o2-06 (050A)	Ope Select @Keypad is Disconnect	<p>V/f CL-V/f OLV CLV AOLV OLV/PM AOLV/PM CLV/PM EZOLV</p> <p>Selects whether or not to stop the drive when the keypad connection cable is disconnected from the drive or damaged while the keypad is the Run command source.</p> <p>0 : Disabled 1 : Enabled</p>	0 (0, 1)	905
o2-07 (0527)	MotorDirect@PowUpWhenUsing Keypad	<p>V/f CL-V/f OLV CLV AOLV OLV/PM AOLV/PM CLV/PM EZOLV</p> <p>Selects the direction of motor rotation when the power is turned on when the keypad is the Run command source.</p> <p>0 : Forward 1 : Reverse</p>	0 (0, 1)	905
o2-09 (050D)	Factory use	-	-	-
o2-23 (11F8)	Lost Detection of Ext. Power 24V	<p>V/f CL-V/f OLV CLV AOLV OLV/PM AOLV/PM CLV/PM EZOLV</p> <p>Selects whether or not to provide warning when the backup external 24-V power supply turns off while the main circuit power supply is supplied.</p> <p>0 : Disabled 1 : Enabled</p>	0 (0, 1)	905
o2-24 (11FE)	LED Light Function Selection	<p>V/f CL-V/f OLV CLV AOLV OLV/PM AOLV/PM CLV/PM EZOLV</p> <p>Selects the option to enable or disable the LED status rings and LED lamps on the keypad.</p> <p>0 : Both Enable 1 : LED Status Ring Disable 2 : Keypad LED Light Disable</p>	0 (0 - 2)	906

◆ o3: Copy Function

No. (Hex.)	Name	Description	Default (Range)	Ref.
o3-01 (0515)	Copy Function Selection	<p>V/f CL-V/f OLV CLV AOLV OLV/PM AOLV/PM CLV/PM EZOLV</p> <p>Drive parameters can be saved and copied to another drive using the keypad.</p> <p>0 : Copy select 1 : Drive → Keypad Backup 2 : Keypad → Drive Restore 3 : Keypad ↔ Drive (compare)</p>	0 (0 - 3)	906
o3-02 (0516)	Copy Allowed Selection	<p>V/f CL-V/f OLV CLV AOLV OLV/PM AOLV/PM CLV/PM EZOLV</p> <p>Selects the enabled/disabled status of backup when <i>o3-01 = 1</i> [<i>Copy Function Selection = Drive → Keypad Backup</i>].</p> <p>0 : Disabled 1 : Enabled</p>	0 (0, 1)	906
o3-04 (0B3E)	Select Backup/Restore Location	<p>V/f CL-V/f OLV CLV AOLV OLV/PM AOLV/PM CLV/PM EZOLV</p> <p>Selects the storage region for drive parameters when backing up and restoring parameters. This parameter is only enabled for LED keypads.</p> <p>0 : Memory Location 0 1 : Memory Location 1 2 : Memory Location 2 3 : Memory Location 3</p>	0 (0 - 3)	906
o3-05 (0BDA)	Select items to Backup/Restore	<p>V/f CL-V/f OLV CLV AOLV OLV/PM AOLV/PM CLV/PM EZOLV</p> <p>Selects the parameters that are backed up, restored, and referenced. This parameter is only enabled for LED keypads.</p> <p>0 : Standard Parameters 1 : Standard + DWEZ Parameters</p>	0 (0, 1)	907
o3-06 (0BDE)	Auto Parameter Backup Selection	<p>V/f CL-V/f OLV CLV AOLV OLV/PM AOLV/PM CLV/PM EZOLV</p> <p>Selects whether to enable or disable the automatic parameter backup function. This parameter is only enabled for LED keypads.</p> <p>0 : Disabled 1 : Enabled</p>	1 (0, 1)	907
o3-07 (0BDF)	Period setting of auto backup	<p>V/f CL-V/f OLV CLV AOLV OLV/PM AOLV/PM CLV/PM EZOLV</p> <p>Configures the interval at which the automatic parameter backup function saves parameters from the drive to the keypad.</p> <p>Note: This parameter is only enabled for LED keypads.</p> <p>0 : every 10 minutes 1 : every 30 minutes 2 : every 60 minutes 3 : every 12 hours</p>	1 (0 - 3)	907

◆ o4: Maintenance Mon Settings

No. (Hex.)	Name	Description	Default (Range)	Ref.
o4-01 (050B)	Cumulative Operation TimeSetting	<p>V/f CL-V/f OLV CLV AOLV OLV/PM AOLV/PM CLV/PM EZOLV</p> <p>Configures the initial value of the cumulative drive operation time in units of 10 hours.</p>	0 h (0 - 9999 h)	908
o4-02 (050C)	Cumulative Operation Time Select	<p>V/f CL-V/f OLV CLV AOLV OLV/PM AOLV/PM CLV/PM EZOLV</p> <p>Selects the condition used to count the cumulative operation time.</p> <p>0 : Logs power-on time 1 : Running Time</p>	0 (0, 1)	908
o4-03 (050E)	CoolingFan OperationTime Setting	<p>V/f CL-V/f OLV CLV AOLV OLV/PM AOLV/PM CLV/PM EZOLV</p> <p>Sets the value from which to start the cumulative drive cooling fan operation time in 10-hour units.</p>	0 h (0 - 9999 h)	908
o4-05 (051D)	Capacitor Maintenance Setting	<p>V/f CL-V/f OLV CLV AOLV OLV/PM AOLV/PM CLV/PM EZOLV</p> <p>U4-05 [<i>CapacitorMaintenance</i>] monitor values can be overwritten.</p>	0% (0 - 150%)	908

10.13 o: Keypad-Related Settings

No. (Hex.)	Name	Description	Default (Range)	Ref.
o4-07 (0523)	DCBusPreChargeRelayMaintenanceSetting	V/f CL-V/f OLV CLV AOLV OLV/PM AOLV/PM CLV/PM EZOLV U4-06 [SChgBypassRelayMaint] monitor values can be overwritten.	0% (0 - 150%)	908
o4-09 (0525)	IGBT Maintenance Setting	V/f CL-V/f OLV CLV AOLV OLV/PM AOLV/PM CLV/PM EZOLV U4-07 [IGBT Maintenance] monitor values can be overwritten.	0% (0 - 150%)	909
o4-11 (0510)	U2, U3 Initialization	V/f CL-V/f OLV CLV AOLV OLV/PM AOLV/PM CLV/PM EZOLV Resets the records of Monitors U2-xx [Fault Trace] and U3-xx [Fault History]. 0 : No Reset 1 : Reset	0 (0, 1)	909
o4-12 (0512)	kWh Monitor Initialization	V/f CL-V/f OLV CLV AOLV OLV/PM AOLV/PM CLV/PM EZOLV Resets the monitor values for U4-10 [kWh, Lower 4 Digits] and U4-11 [kWh, Upper 5 Digits]. 0 : No Reset 1 : Reset	0 (0, 1)	909
o4-13 (0528)	NumOfRunCommands Counter Initial	V/f CL-V/f OLV CLV AOLV OLV/PM AOLV/PM CLV/PM EZOLV Resets the monitor values for U4-02 [Num of Run Commands], U4-24 [No of Travels(L)], and U4-25 [No of Travels(H)]. 0 : No Reset 1 : Reset	0 (0, 1)	909
o4-22 (154F)	Time Format	V/f CL-V/f OLV CLV AOLV OLV/PM AOLV/PM CLV/PM EZOLV Selects the time display format. This parameter is only enabled for LED keypads. 0 : 24 hour clock 1 : 12 hour EA clock 2 : 12 hour JP clock	0 (0 - 2)	910
o4-23 (1550)	Date Format	V/f CL-V/f OLV CLV AOLV OLV/PM AOLV/PM CLV/PM EZOLV Selects the date display format. This parameter is only enabled for LED keypads. 0 : YYYY/MM/DD(2016/01/31) 1 : DD/MM/YYYY(31/01/2016) 2 : MM/DD/YYYY(01/31/2016)	0 (0 - 2)	910
o4-24 (310F) RUN	bAT Detection Operation Selection	V/f CL-V/f OLV CLV AOLV OLV/PM AOLV/PM CLV/PM EZOLV Selects the operation performed when bAT (low keypad battery) faults are detected. 0 : Disabled 1 : Enabled	0 (0, 1)	910

◆ o5: Log Function

No. (Hex.)	Name	Description	Default (Range)	Ref.
o5-01 (1551) RUN	Log Start/Stop Selection	V/f CL-V/f OLV CLV AOLV OLV/PM AOLV/PM CLV/PM EZOLV Starts or stops the data log function. This parameter is only enabled for LED keypads. 0 : OFF 1 : ON	0 (0, 1)	913
o5-02 (1552) RUN	Log Sampling Interval	V/f CL-V/f OLV CLV AOLV OLV/PM AOLV/PM CLV/PM EZOLV Selects the data log sampling cycle. This parameter is only enabled for LED keypads.	1000 ms (100 - 60000 ms)	913
o5-03 (1553) RUN	Log Monitor Data 1	V/f CL-V/f OLV CLV AOLV OLV/PM AOLV/PM CLV/PM EZOLV Configures the data log monitor. This parameter is only enabled for LED keypads.	101 (000,101 - 855)	913
o5-04 (1554) RUN	Log Monitor Data 2	V/f CL-V/f OLV CLV AOLV OLV/PM AOLV/PM CLV/PM EZOLV Configures the data log monitor. This parameter is only enabled for LED keypads.	102 (000,101 - 855)	914

No. (Hex.)	Name	Description	Default (Range)	Ref.
o5-05 (1555) RUN	Log Monitor Data 3	V/f CL-V/f OLV CLV AOLV OLV/PM AOLV/PM CLV/PM EZOLV Configures the data log monitor. This parameter is only enabled for LED keypads.	103 (000,101 - 855)	914
o5-06 (1556) RUN	Log Monitor Data 4	V/f CL-V/f OLV CLV AOLV OLV/PM AOLV/PM CLV/PM EZOLV Configures the data log monitor. This parameter is only enabled for LED keypads.	107 (000,101 - 855)	914
o5-07 (1557) RUN	Log Monitor Data 5	V/f CL-V/f OLV CLV AOLV OLV/PM AOLV/PM CLV/PM EZOLV Configures the data log monitor. This parameter is only enabled for LED keypads.	108 (000,101 - 855)	914
o5-08 (1558) RUN	Log Monitor Data 6	V/f CL-V/f OLV CLV AOLV OLV/PM AOLV/PM CLV/PM EZOLV Configures the data log monitor. This parameter is only enabled for LED keypads.	000 (000,101 - 855)	914
o5-09 (1559) RUN	Log Monitor Data 7	V/f CL-V/f OLV CLV AOLV OLV/PM AOLV/PM CLV/PM EZOLV Configures the data log monitor. This parameter is only enabled for LED keypads.	000 (000,101 - 855)	915
o5-10 (155A) RUN	Log Monitor Data 8	V/f CL-V/f OLV CLV AOLV OLV/PM AOLV/PM CLV/PM EZOLV Configures the data log monitor. This parameter is only enabled for LED keypads.	000 (000,101 - 855)	915
o5-11 (155B) RUN	Log Monitor Data 9	V/f CL-V/f OLV CLV AOLV OLV/PM AOLV/PM CLV/PM EZOLV Configures the data log monitor. This parameter is only enabled for LED keypads.	000 (000,101 - 855)	915
o5-12 (155C) RUN	Log Monitor Data 10	V/f CL-V/f OLV CLV AOLV OLV/PM AOLV/PM CLV/PM EZOLV Configures the data log monitor. This parameter is only enabled for LED keypads.	000 (000,101 - 855)	915

10.14 q: DriveWorksEZ Parameters

◆ q1-01 to q8-40: Reserved for DriveWorksEZ

No. (Hex.)	Name	Description	Default (Range)
q1-01 to q8-40: (1600 to 17E7)	Reserved for DriveWorksEZ	<div style="display: flex; justify-content: space-between; font-size: 0.8em; font-weight: bold; margin-bottom: 5px;"> V/f CL-V/f OLV CLV AOLV OLV/PM AOLV/PM CLV/PM EZOLV </div> This parameters are reserved for use with DriveWorksEZ.	Refer to the DriveWorksEZ Online Manual.

Note:

qx-xx parameters are reserved for use with DriveWorksEZ. Refer to the DriveWorksEZ Online Manual for more information on these parameters.

10.15 r: DWEZ Connection 1-20

◆ r1-01 to r1-40: DriveWorksEZ Connection Parameters 1 to 20 (Upper / Lower)

No. (Hex.)	Name	Description	Default (Range)
r1-01 to r1-40: (1840 - 1867)	DriveWorksEZ Connection Parameters 1 to 20 (Upper / Lower)	<div style="display: flex; justify-content: space-between; font-size: 0.8em; font-weight: bold; margin-bottom: 5px;"> V/f CL-V/f OLV CLV AOLV OLV/PM AOLV/PM CLV/PM EZOLV </div> DriveWorksEZ Connection Parameters 1 to 20 (Upper / Lower)	0 (0 - FFFFH)

Note:

r1-xx parameters are reserved for use with DriveWorksEZ. Refer to the DriveWorksEZ Online Manual for more information on these parameters.

10.16 T: Motor Tuning

◆ T0: Tuning Mode Selection

No. (Hex.)	Name	Description	Default (Range)	Ref.
T0-00 (1197)	Tuning Mode Selection	<div style="display: flex; justify-content: space-between; font-size: 0.8em; font-weight: bold;"> V/f CL-V/f OLV CLV AOLV OLV/PM AOLV/PM CLV/PM EZOLV </div> <p>Selects the type of Auto-Tuning to be used. 0 : Motor Parameter Tuning 1 : Control Tuning</p>	0 (0, 1)	916

◆ T1: Induction Motor Auto-Tuning

No. (Hex.)	Name	Description	Default (Range)	Ref.
T1-00 (0700)	Motor 1/Motor 2 Selection	<div style="display: flex; justify-content: space-between; font-size: 0.8em; font-weight: bold;"> V/f CL-V/f OLV CLV AOLV OLV/PM AOLV/PM CLV/PM EZOLV </div> <p>Selects the motor to be tuned when motor 1/2 switching is enabled. This parameter can only be set via the keypad not via external input terminals. Note: This parameter can be set when $H1-xx = 16$ [Motor 2 Selection] is ON and is not displayed when $H1-xx = 16$ is OFF. 1 : Motor 1 (sets E3-xx, E4-xx) 2 : Motor 2 (sets E3-xx, E4-xx)</p>	1 (1, 2)	916
T1-01 (0701)	Auto-Tuning Mode Selection	<div style="display: flex; justify-content: space-between; font-size: 0.8em; font-weight: bold;"> V/f CL-V/f OLV CLV AOLV OLV/PM AOLV/PM CLV/PM EZOLV </div> <p>Selects the type of Auto-Tuning to be used. 0 : Rotational Auto-Tuning 1 : Stationary Auto-Tuning 1 2 : StaTun for LinetoLine Resistance</p>	Determined by A1-02 (Determined by A1-02)	917
T1-02 (0702)	Motor Rated Power	<div style="display: flex; justify-content: space-between; font-size: 0.8em; font-weight: bold;"> V/f CL-V/f OLV CLV AOLV OLV/PM AOLV/PM CLV/PM EZOLV </div> <p>Sets the rated output power (kW) of the motor.</p>	Determined by o2-04 and C6-01 (0.00 - 650.00 kW)	917
T1-03 (0703)	Motor Rated Voltage	<div style="display: flex; justify-content: space-between; font-size: 0.8em; font-weight: bold;"> V/f CL-V/f OLV CLV AOLV OLV/PM AOLV/PM CLV/PM EZOLV </div> <p>Sets the rated voltage (V) of the motor. Enter the base speed voltage here for constant output motors.</p>	Determined by o2-04 and C6-01 (200 V Class: 0.0 - 255.5 V, 400 V Class: 0.0 - 511.0 V)	917
T1-04 (0704)	Motor Rated Current	<div style="display: flex; justify-content: space-between; font-size: 0.8em; font-weight: bold;"> V/f CL-V/f OLV CLV AOLV OLV/PM AOLV/PM CLV/PM EZOLV </div> <p>Sets the rated current (A) of the motor.</p>	Determined by o2-04 (10% to 200% of the drive rated current)	917
T1-05 (0705)	Motor Base Frequency	<div style="display: flex; justify-content: space-between; font-size: 0.8em; font-weight: bold;"> V/f CL-V/f OLV CLV AOLV OLV/PM AOLV/PM CLV/PM EZOLV </div> <p>Sets the base frequency of the motor (Hz).</p>	60.0 Hz (0.0 - 590.0 Hz)	917
T1-06 (0706)	Number of Motor Poles	<div style="display: flex; justify-content: space-between; font-size: 0.8em; font-weight: bold;"> V/f CL-V/f OLV CLV AOLV OLV/PM AOLV/PM CLV/PM EZOLV </div> <p>Sets the number of motor poles.</p>	4 (2 - 48)	918
T1-07 (0707)	Motor Base Speed	<div style="display: flex; justify-content: space-between; font-size: 0.8em; font-weight: bold;"> V/f CL-V/f OLV CLV AOLV OLV/PM AOLV/PM CLV/PM EZOLV </div> <p>Sets the motor base speed for performing auto tuning (min^{-1} (r/min)).</p>	1750 min^{-1} (r/min) (0 - 24000 min^{-1} (r/min))	918
T1-08 (0708)	PG Number of PulsesPerRevolution	<div style="display: flex; justify-content: space-between; font-size: 0.8em; font-weight: bold;"> V/f CL-V/f OLV CLV AOLV OLV/PM AOLV/PM CLV/PM EZOLV </div> <p>Sets the number of PG (pulse generator, encoder) pulses.</p>	600 ppr (0 - 60,000 ppr)	918
T1-09 (0709)	Motor No-Load Current	<div style="display: flex; justify-content: space-between; font-size: 0.8em; font-weight: bold;"> V/f CL-V/f OLV CLV AOLV OLV/PM AOLV/PM CLV/PM EZOLV </div> <p>Sets the no-load current of the motor.</p>	- (0A to T1-04; max. of 2999.9)	918

No. (Hex.)	Name	Description	Default (Range)	Ref.
T1-10 (070A)	Motor Rated Slip	<input type="checkbox"/> V/f <input type="checkbox"/> CL-V/f <input checked="" type="checkbox"/> OLV <input checked="" type="checkbox"/> CLV <input type="checkbox"/> AOLV <input type="checkbox"/> OLV/PM <input type="checkbox"/> AOLV/PM <input type="checkbox"/> CLV/PM <input type="checkbox"/> EZOLV Sets the motor rated slip.	- (0.00 - 20.00 Hz)	918
T1-11 (070B)	Motor Iron Loss	<input checked="" type="checkbox"/> V/f <input checked="" type="checkbox"/> CL-V/f <input type="checkbox"/> OLV <input type="checkbox"/> CLV <input type="checkbox"/> AOLV <input type="checkbox"/> OLV/PM <input type="checkbox"/> AOLV/PM <input type="checkbox"/> CLV/PM <input type="checkbox"/> EZOLV Sets the iron loss information for determining the energy-saving coefficient.	Determined by E2-11 or E4-11 (0 - 65535 W)	918

◆ T2: PM Motor Auto-Tuning

No. (Hex.)	Name	Description	Default (Range)	Ref.
T2-01 (0750)	PM Motor Auto-Tuning Mode Select	<input type="checkbox"/> V/f <input type="checkbox"/> CL-V/f <input type="checkbox"/> OLV <input type="checkbox"/> CLV <input type="checkbox"/> AOLV <input checked="" type="checkbox"/> OLV/PM <input checked="" type="checkbox"/> AOLV/PM <input checked="" type="checkbox"/> CLV/PM <input type="checkbox"/> EZOLV Selects the type of Auto-Tuning for PM motors to be used. 0 : PM Motor Parameter Settings 1 : PM Stationary Auto-Tuning 2 : PM StaTun for Stator Resistance 3 : Z Pulse Offset Tuning 4 : PM Rotational Auto-Tuning	0 (Determined by A1-02)	919
T2-02 (0751)	PM Motor Code Selection	<input type="checkbox"/> V/f <input type="checkbox"/> CL-V/f <input type="checkbox"/> OLV <input type="checkbox"/> CLV <input type="checkbox"/> AOLV <input checked="" type="checkbox"/> OLV/PM <input checked="" type="checkbox"/> AOLV/PM <input checked="" type="checkbox"/> CLV/PM <input type="checkbox"/> EZOLV If the drive is operating a Yaskawa PM motor from the SMRA, SSR1, or SST4 series, enter the PM motor code in accordance with the rotation speed and motor output.	Determined by A1-02 and o2-04 (0000 - FFFF)	919
T2-03 (0752)	PM Motor Type	<input type="checkbox"/> V/f <input type="checkbox"/> CL-V/f <input type="checkbox"/> OLV <input type="checkbox"/> CLV <input type="checkbox"/> AOLV <input checked="" type="checkbox"/> OLV/PM <input checked="" type="checkbox"/> AOLV/PM <input checked="" type="checkbox"/> CLV/PM <input type="checkbox"/> EZOLV Selects the type of PM motor the drive will operate. 0 : IPM Motor 1 : SPM Motor	1 (0, 1)	919
T2-04 (0730)	PM Motor Rated Power	<input type="checkbox"/> V/f <input type="checkbox"/> CL-V/f <input type="checkbox"/> OLV <input type="checkbox"/> CLV <input type="checkbox"/> AOLV <input checked="" type="checkbox"/> OLV/PM <input checked="" type="checkbox"/> AOLV/PM <input checked="" type="checkbox"/> CLV/PM <input type="checkbox"/> EZOLV Sets the rated output power (kW) of a PM motor.	Determined by o2-04 and C6-01 (0.00 - 650.00 kW)	920
T2-05 (0732)	PM Motor Rated Voltage	<input type="checkbox"/> V/f <input type="checkbox"/> CL-V/f <input type="checkbox"/> OLV <input type="checkbox"/> CLV <input type="checkbox"/> AOLV <input checked="" type="checkbox"/> OLV/PM <input checked="" type="checkbox"/> AOLV/PM <input checked="" type="checkbox"/> CLV/PM <input type="checkbox"/> EZOLV Sets the rated voltage (V) of the motor.	200 V Class: 200.0 V, 400 V Class: 400.0 V (200 V Class: 0.0 - 255.0 V, 400 V Class: 0.0 - 510.0 V)	920
T2-06 (0733)	PM Motor Rated Current	<input type="checkbox"/> V/f <input type="checkbox"/> CL-V/f <input type="checkbox"/> OLV <input type="checkbox"/> CLV <input type="checkbox"/> AOLV <input checked="" type="checkbox"/> OLV/PM <input checked="" type="checkbox"/> AOLV/PM <input checked="" type="checkbox"/> CLV/PM <input type="checkbox"/> EZOLV Sets the rated current (A) of the motor.	Determined by o2-04 (10% to 200% of the drive rated current)	920
T2-07 (0753)	PM Motor Base Frequency	<input type="checkbox"/> V/f <input type="checkbox"/> CL-V/f <input type="checkbox"/> OLV <input type="checkbox"/> CLV <input type="checkbox"/> AOLV <input checked="" type="checkbox"/> OLV/PM <input checked="" type="checkbox"/> AOLV/PM <input checked="" type="checkbox"/> CLV/PM <input type="checkbox"/> EZOLV Sets the base frequency of the motor (Hz).	87.5 Hz (0.0 - 590.0 Hz)	920
T2-08 (0734)	Number of PM Motor Poles	<input type="checkbox"/> V/f <input type="checkbox"/> CL-V/f <input type="checkbox"/> OLV <input type="checkbox"/> CLV <input type="checkbox"/> AOLV <input checked="" type="checkbox"/> OLV/PM <input checked="" type="checkbox"/> AOLV/PM <input checked="" type="checkbox"/> CLV/PM <input type="checkbox"/> EZOLV Sets the number of motor poles.	6 (2 - 48)	920
T2-09 (0731)	PM Motor Base Speed	<input type="checkbox"/> V/f <input type="checkbox"/> CL-V/f <input type="checkbox"/> OLV <input type="checkbox"/> CLV <input type="checkbox"/> AOLV <input checked="" type="checkbox"/> OLV/PM <input checked="" type="checkbox"/> AOLV/PM <input checked="" type="checkbox"/> CLV/PM <input type="checkbox"/> EZOLV Sets the motor base speed (min ⁻¹ (r/min)).	1750 min ⁻¹ (r/min) (0 - 34500 min ⁻¹ (r/min))	920
T2-10 (0754)	PM Motor Stator Resistance	<input type="checkbox"/> V/f <input type="checkbox"/> CL-V/f <input type="checkbox"/> OLV <input type="checkbox"/> CLV <input type="checkbox"/> AOLV <input checked="" type="checkbox"/> OLV/PM <input checked="" type="checkbox"/> AOLV/PM <input checked="" type="checkbox"/> CLV/PM <input type="checkbox"/> EZOLV Sets the stator resistance per phase of the motor. Note: Do not confuse this parameter with line-to-line resistance.	Determined by T2-02 (0.000 - 65.000 Ω)	920
T2-11 (0735)	PM Motor d-Axis Inductance	<input type="checkbox"/> V/f <input type="checkbox"/> CL-V/f <input type="checkbox"/> OLV <input type="checkbox"/> CLV <input type="checkbox"/> AOLV <input checked="" type="checkbox"/> OLV/PM <input checked="" type="checkbox"/> AOLV/PM <input checked="" type="checkbox"/> CLV/PM <input type="checkbox"/> EZOLV Sets the d-Axis inductance of the motor on a per phase basis.	Determined by T2-02 (0.00 - 600.00 mH)	921
T2-12 (0736)	PM Motor q-Axis Inductance	<input type="checkbox"/> V/f <input type="checkbox"/> CL-V/f <input type="checkbox"/> OLV <input type="checkbox"/> CLV <input type="checkbox"/> AOLV <input checked="" type="checkbox"/> OLV/PM <input checked="" type="checkbox"/> AOLV/PM <input checked="" type="checkbox"/> CLV/PM <input type="checkbox"/> EZOLV Sets the q-Axis inductance of the motor on a per phase basis.	Determined by T2-02 (0.00 - 600.00 mH)	921

No. (Hex.)	Name	Description	Default (Range)	Ref.
T2-13 (0755)	InducedVoltage Const Unit Select	<input type="checkbox"/> V/f <input type="checkbox"/> CL-V/f <input type="checkbox"/> OLV <input type="checkbox"/> CLV <input type="checkbox"/> AOLV <input checked="" type="checkbox"/> OLV/PM <input type="checkbox"/> AOLV/PM <input type="checkbox"/> CLV/PM <input type="checkbox"/> EZOLV Selects the unit used for setting the induced voltage constant. 0 : mV/(r/min) 1 : mV/(rad/sec)	1 (0, 1)	921
T2-14 (0737)	PM Motor Induced Voltage Const	<input type="checkbox"/> V/f <input type="checkbox"/> CL-V/f <input type="checkbox"/> OLV <input type="checkbox"/> CLV <input type="checkbox"/> AOLV <input checked="" type="checkbox"/> OLV/PM <input type="checkbox"/> AOLV/PM <input type="checkbox"/> CLV/PM <input type="checkbox"/> EZOLV Sets the motor induced voltage constant (Ke).	Determined by T2-13 (0.0 - 2000.0)	921
T2-15 (0756)	Pull-InCurrentLv forPM Motor Tun	<input type="checkbox"/> V/f <input type="checkbox"/> CL-V/f <input type="checkbox"/> OLV <input type="checkbox"/> CLV <input type="checkbox"/> AOLV <input checked="" type="checkbox"/> OLV/PM <input type="checkbox"/> AOLV/PM <input type="checkbox"/> CLV/PM <input type="checkbox"/> EZOLV Sets the level of the pull-in current as a percentage, with 100% representing the motor rated current. Normally there is no need to configure this setting.	30% (0 - 120%)	921
T2-16 (0738)	PGNumOfPulses/Rev forPMMotor Tun	<input type="checkbox"/> V/f <input type="checkbox"/> CL-V/f <input type="checkbox"/> OLV <input type="checkbox"/> CLV <input type="checkbox"/> AOLV <input type="checkbox"/> OLV/PM <input type="checkbox"/> AOLV/PM <input checked="" type="checkbox"/> CLV/PM <input type="checkbox"/> EZOLV Sets the number of PG (pulse generator, encoder) pulses.	1024 ppr (1 - 15000 ppr)	921
T2-17 (0757)	Encoder Z-Pulse Offset	<input type="checkbox"/> V/f <input type="checkbox"/> CL-V/f <input type="checkbox"/> OLV <input type="checkbox"/> CLV <input type="checkbox"/> AOLV <input type="checkbox"/> OLV/PM <input type="checkbox"/> AOLV/PM <input checked="" type="checkbox"/> CLV/PM <input type="checkbox"/> EZOLV If the encoder Z-pulse offset ($\Delta\theta$) (pulse generator, encoder) is listed on the motor nameplate, set it in units of 0.1°.	0.0° (-180.0 - +180.0°)	921

◆ T3: ASR and Inertia Tuning

No. (Hex.)	Name	Description	Default (Range)	Ref.
T3-00 (1198)	Control Loop Tuning Selection	<input type="checkbox"/> V/f <input type="checkbox"/> CL-V/f <input type="checkbox"/> OLV <input checked="" type="checkbox"/> CLV <input type="checkbox"/> AOLV <input type="checkbox"/> OLV/PM <input type="checkbox"/> AOLV/PM <input type="checkbox"/> CLV/PM <input type="checkbox"/> EZOLV Selects the Control Auto-Tuning method to be used. 0 : Inertia Tuning 1 : ASR Tuning	0 (0 - 1)	922
T3-01 (0760)	Test Signal Frequency	<input type="checkbox"/> V/f <input type="checkbox"/> CL-V/f <input type="checkbox"/> OLV <input checked="" type="checkbox"/> CLV <input type="checkbox"/> AOLV <input type="checkbox"/> OLV/PM <input type="checkbox"/> AOLV/PM <input type="checkbox"/> CLV/PM <input type="checkbox"/> EZOLV Normally there is no need to change this setting. Sets the frequency of the test signal applied to the motor during Inertia Tuning.	3.0 Hz (0.1 - 20.0 Hz)	922
T3-02 (0761)	Test Signal Amplitude	<input type="checkbox"/> V/f <input type="checkbox"/> CL-V/f <input type="checkbox"/> OLV <input checked="" type="checkbox"/> CLV <input type="checkbox"/> AOLV <input type="checkbox"/> OLV/PM <input type="checkbox"/> AOLV/PM <input type="checkbox"/> CLV/PM <input type="checkbox"/> EZOLV Sets the amplitude of the test signal applied to the motor during Inertia Tuning. Normally there is no need to change this setting.	0.5 rad (0.1 - 10.0 rad)	922
T3-03 (0762)	Motor Inertia	<input type="checkbox"/> V/f <input type="checkbox"/> CL-V/f <input type="checkbox"/> OLV <input checked="" type="checkbox"/> CLV <input type="checkbox"/> AOLV <input type="checkbox"/> OLV/PM <input type="checkbox"/> AOLV/PM <input type="checkbox"/> CLV/PM <input type="checkbox"/> EZOLV Sets the inertia of the motor. This value is used to determine the load inertia using the test signal response.	Determined by o2-04, C6-01, and E5-01 (0.0001 - 6.0000 kgm ²)	922
T3-04 (0763)	System Response Frequency	<input type="checkbox"/> V/f <input type="checkbox"/> CL-V/f <input type="checkbox"/> OLV <input checked="" type="checkbox"/> CLV <input type="checkbox"/> AOLV <input type="checkbox"/> OLV/PM <input type="checkbox"/> AOLV/PM <input type="checkbox"/> CLV/PM <input type="checkbox"/> EZOLV C5-01 [ASR Proportional Gain 1] is automatically calculated and set using the load inertia value derived by the Inertia Tuning process.	10.0 Hz (0.1 - 50.0 Hz)	922

◆ T4: EZ Tuning

No. (Hex.)	Name	Description	Default (Range)	Ref.
T4-01 (3130)	EZ Tuning Mode Selection	<input type="checkbox"/> V/f <input type="checkbox"/> CL-V/f <input type="checkbox"/> OLV <input type="checkbox"/> CLV <input type="checkbox"/> AOLV <input type="checkbox"/> OLV/PM <input type="checkbox"/> AOLV/PM <input type="checkbox"/> CLV/PM <input checked="" type="checkbox"/> EZOLV Selects the Auto-Tuning method used for EZ Open Loop Vector Control. 0 : Motor constant setting Auto-Tuning 1 : Stationary Auto-Tuning for Line-to-Line Resistance	0 (0, 1)	923
T4-02 (3131)	Motor Type Selection	<input type="checkbox"/> V/f <input type="checkbox"/> CL-V/f <input type="checkbox"/> OLV <input type="checkbox"/> CLV <input type="checkbox"/> AOLV <input type="checkbox"/> OLV/PM <input type="checkbox"/> AOLV/PM <input type="checkbox"/> CLV/PM <input checked="" type="checkbox"/> EZOLV Selects the type of motor. 0 : IM 1 : PM 2 : SynRM	0 (0, 1, 2)	923

No. (Hex.)	Name	Description	Default (Range)	Ref.
T4-03 (3132)	Motor Max Revolutions	<input type="checkbox"/> V/f <input type="checkbox"/> CL-V/f <input type="checkbox"/> OLV <input type="checkbox"/> CLV <input type="checkbox"/> AOLV <input type="checkbox"/> OLV/PM <input type="checkbox"/> AOLV/PM <input type="checkbox"/> CLV/PM <input checked="" type="checkbox"/> EZOLV Sets the motor max revolutions (min ⁻¹).	- ((40 to 120 Hz) × 60 × 2 / E9-08)	923
T4-04 (3133)	Motor Rated Revolutions	<input type="checkbox"/> V/f <input type="checkbox"/> CL-V/f <input type="checkbox"/> OLV <input type="checkbox"/> CLV <input type="checkbox"/> AOLV <input type="checkbox"/> OLV/PM <input type="checkbox"/> AOLV/PM <input type="checkbox"/> CLV/PM <input checked="" type="checkbox"/> EZOLV Sets rated rotation speed of the motor (min ⁻¹).	- ((40 to 120 Hz) × 60 × 2 / E9-08)	923
T4-05 (3134)	Motor Rated Frequency	<input type="checkbox"/> V/f <input type="checkbox"/> CL-V/f <input type="checkbox"/> OLV <input type="checkbox"/> CLV <input type="checkbox"/> AOLV <input type="checkbox"/> OLV/PM <input type="checkbox"/> AOLV/PM <input type="checkbox"/> CLV/PM <input checked="" type="checkbox"/> EZOLV Sets the motor rated frequency (Hz).	Determined by E9-01 and o2-04 (40.0 - 120.0 Hz)	924
T4-06 (3135)	Motor Rated Voltage	<input type="checkbox"/> V/f <input type="checkbox"/> CL-V/f <input type="checkbox"/> OLV <input type="checkbox"/> CLV <input type="checkbox"/> AOLV <input type="checkbox"/> OLV/PM <input type="checkbox"/> AOLV/PM <input type="checkbox"/> CLV/PM <input checked="" type="checkbox"/> EZOLV Sets the rated voltage (V) of the motor.	200 V Class: 200.0 V, 400 V Class: 400.0 V (200 V Class: 0.0 - 255.0 V, 400 V Class: 0.0 - 510.0 V)	924
T4-07 (3136)	Motor Rated Current	<input type="checkbox"/> V/f <input type="checkbox"/> CL-V/f <input type="checkbox"/> OLV <input type="checkbox"/> CLV <input type="checkbox"/> AOLV <input type="checkbox"/> OLV/PM <input type="checkbox"/> AOLV/PM <input type="checkbox"/> CLV/PM <input checked="" type="checkbox"/> EZOLV Sets the rated current (A) of the motor.	Determined by o2-04 and C6-01 (10% to 200% of the drive rated current)	924
T4-08 (3137)	Motor Rated Capacity	<input type="checkbox"/> V/f <input type="checkbox"/> CL-V/f <input type="checkbox"/> OLV <input type="checkbox"/> CLV <input type="checkbox"/> AOLV <input type="checkbox"/> OLV/PM <input type="checkbox"/> AOLV/PM <input type="checkbox"/> CLV/PM <input checked="" type="checkbox"/> EZOLV Sets the motor rated capacity in 0.01 kW units.	Determined by E9-10 (0.10 - 650.00 kW)	924
T4-09 (3138)	Number of Motor Poles	<input type="checkbox"/> V/f <input type="checkbox"/> CL-V/f <input type="checkbox"/> OLV <input type="checkbox"/> CLV <input type="checkbox"/> AOLV <input type="checkbox"/> OLV/PM <input type="checkbox"/> AOLV/PM <input type="checkbox"/> CLV/PM <input checked="" type="checkbox"/> EZOLV Sets the number of motor poles.	Determined by E9-01 (2 - 48)	924
T4-10 (3139)	Motor Rated Slip	<input type="checkbox"/> V/f <input type="checkbox"/> CL-V/f <input type="checkbox"/> OLV <input type="checkbox"/> CLV <input type="checkbox"/> AOLV <input type="checkbox"/> OLV/PM <input type="checkbox"/> AOLV/PM <input type="checkbox"/> CLV/PM <input checked="" type="checkbox"/> EZOLV Sets the amount of motor rated slip in Hz units.	Determined by o2-04 (0.000 - 20.000 Hz)	924
T4-11 (313A)	Motor Line Resistance	<input type="checkbox"/> V/f <input type="checkbox"/> CL-V/f <input type="checkbox"/> OLV <input type="checkbox"/> CLV <input type="checkbox"/> AOLV <input type="checkbox"/> OLV/PM <input type="checkbox"/> AOLV/PM <input type="checkbox"/> CLV/PM <input checked="" type="checkbox"/> EZOLV Sets the line-to-line resistance for motor stator windings in Ω units.	Determined by E9-01, o2-04, and o2-09. (0.000 - 65.000 Ω)	925

10.17 U: Monitors

◆ U1: Operation Status Monitor

No. (Hex.)	Name	Description	MFAO Signal Level	Ref.
U1-01 (0040)	Frequency reference	<p>V/f CL-V/f OLV CLV AOLV OLV/PM AOLV/PM CLV/PM EZOLV</p> <p>Displays the frequency reference value. Display units are determined by <i>o1-03</i> [Keypad Display Selection]. Unit: 0.01 Hz</p>	10 V = Max. frequency (-10 V to +10 V)	-
U1-02 (0041)	Output frequency	<p>V/f CL-V/f OLV CLV AOLV OLV/PM AOLV/PM CLV/PM EZOLV</p> <p>Displays the current output frequency. Display units are determined by <i>o1-03</i> [Keypad Display Selection]. Unit: 0.01 Hz</p>	10 V = Max. frequency (-10 V to +10 V)	-
U1-03 (0042)	Output current	<p>V/f CL-V/f OLV CLV AOLV OLV/PM AOLV/PM CLV/PM EZOLV</p> <p>Displays the current output current. The value of <i>U1-03</i> is displayed in ampere (A) on the keypad. When viewing via MEMOBUS/Modbus communications, the current is "8192 = drive rated current (A)." Current can be calculated from the monitor value present at MEMOBUS/Modbus communications using "Numerals being displayed / 8192 × drive rated current (A)." Unit: Determined by the drive model. <ul style="list-style-type: none"> Models 2004 to 2042, 4002 to 4023: 0.01 A Models 2056 to 2415, 4031 to 4726: 0.1 A </p>	10 V = Drive rated current	-
U1-04 (0043)	Control method	<p>V/f CL-V/f OLV CLV AOLV OLV/PM AOLV/PM CLV/PM EZOLV</p> <p>Displays the control method assigned to the drive. 0 : V/f Control 1 : Closed Loop V/f Control 2 : Open Loop Vector Control 3 : Closed Loop Vector Control 4 : Advanced OpenLoop Vector Control 5 : PM Open Loop Vector Control 6 : PM Advanced Open Loop Vector 7 : PM Closed Loop Vector Control 8 : EZ Open Loop Vector Control</p>	No signal output available	-
U1-05 (0044)	Motor speed	<p>V/f CL-V/f OLV CLV AOLV OLV/PM AOLV/PM CLV/PM EZOLV</p> <p>Displays the motor speed that is currently detected. Display units are determined by <i>o1-03</i> [Keypad Display Selection]. Unit: 0.01 Hz</p>	10 V = Max. frequency (-10 V to +10 V)	-
U1-06 (0045)	OutVoltage Reference	<p>V/f CL-V/f OLV CLV AOLV OLV/PM AOLV/PM CLV/PM EZOLV</p> <p>Displays the output voltage reference. Unit: 0.1 V</p>	200 V class: 10 V = 200 Vrms 400 V class: 10 V = 400 Vrms	-
U1-07 (0046)	DC bus voltage	<p>V/f CL-V/f OLV CLV AOLV OLV/PM AOLV/PM CLV/PM EZOLV</p> <p>Displays the DC bus voltage. Unit: 1 V</p>	200 V class: 10 V = 200 V 400 V class: 10 V = 400 V	-
U1-08 (0047)	Output Power	<p>V/f CL-V/f OLV CLV AOLV OLV/PM AOLV/PM CLV/PM EZOLV</p> <p>Displays the output power (this value is calculated internally). The signal level of the analog output changes according to the <i>A1-02</i> [Control Method Selection] setting. <ul style="list-style-type: none"> <i>A1-02</i> = 0, 1 [V/f Control]: Drive capacity (kW) <i>A1-02</i> = 2 to 8 [Vector Control]: Motor Rated Power (kW) [E2-11] Unit: Determined by the maximum applicable motor output. The maximum applicable motor output is determined by the drive capacity and <i>C6-01</i> [Normal / Heavy Duty Selection]. <ul style="list-style-type: none"> Less than 11 kW (15 HP): 0.01 kW Less than 11 kW (15 HP): 0.1 kW </p>	10 V: Drive capacity (motor rated power) kW (-10 V to +10 V)	-

No. (Hex.)	Name	Description	MFAO Signal Level	Ref.
U1-09 (0048)	Torque Reference	 Displays the internal torque reference value. Unit: 0.1%	10 V = Motor rated torque (-10 V to +10 V)	-
U1-10 (0049)	Input Terminal Status	 Displays the status of the multi-function input terminal using 1 (ON) and 0 (OFF). For example, <i>U1-10 = 00000011</i> is displayed when terminals S1 and S2 are ON. bit 0 : Terminal S1 (MFDI 1) bit 1 : Terminal S2 (MFDI 2) bit 2 : Terminal S3 (MFDI 3) bit 3 : Terminal S4 (MFDI 4) bit 4 : Terminal S5 (MFDI 5) bit 5 : Terminal S6 (MFDI 6) bit 6 : Terminal S7 (MFDI 7) bit 7 : Terminal S8 (MFDI 8)	No signal output available	-
U1-11 (004A)	Output Terminal Status	 Displays the status of the multi-function output terminal using 1 (ON) and 0 (OFF). For example, <i>U1-11 = 00000011</i> is displayed when terminals M1 and M3 are ON. bit 0 : Terminals M1-M2 bit 1 : Terminals M3-M4 bit 2 : Terminals P1-C1 bit 3 : Terminals P2-C2 bit 4 : Not used (normal value of 0). bit 5 : Not used (normal value of 0). bit 6 : Not used (normal value of 0). bit 7 : Fault relay MA/MB-MC	No signal output available	-
U1-12 (004B)	Drive Status	 Displays the drive status using 1 (ON) and 0 (OFF). For example, <i>U1-12 = 00000101</i> is displayed during run with the Reverse run command. bit 0 : During run bit 1 : During zero-speed bit 2 : During reverse bit 3 : During fault reset signal input bit 4 : During speed agreement bit 5 : Drive ready bit 6 : During minor fault detection bit 7 : During fault detection	No signal output available	-
U1-13 (004E)	Terminal A1 Input Lv	 Displays the signal level of terminal A1. Unit: 0.1%	10 V = 100% (-10 V to +10 V)	-
U1-14 (004F)	Terminal A2 Input Lv	 Displays the signal level of terminal A2. Unit: 0.1%	10 V = 100% (-10 V to +10 V)	-
U1-15 (0050)	Terminal A3 Input Lv	 Displays the signal level of terminal A3. Unit: 0.1%	0 V = 100% (-10 V to +10 V)	-
U1-16 (0053)	Output Freq afterSFS	 Displays the output frequency after soft start. Displays the frequency with acceleration and deceleration times and S-curves. Display units are determined by <i>o1-03 [Keypad Display Selection]</i> . Unit: 0.01 Hz	10 V = Max. frequency (-10 V to +10 V)	-

No. (Hex.)	Name	Description	MFAO Signal Level	Ref.
U1-17 (0058)	DI-A3 Input Status	V/f CL-V/f OLV CLV AOLV OLV/PM AOLV/PM CLV/PM EZOLV Displays the reference value input from the DI-A3 option card. Displays in hexadecimal as determined by the F3-01 [Digital Input Function Selection] setting. 3FFFF: Set (1 bit) + Sign (1 bit) + 16 bit	No signal output available	-
U1-18 (0061)	oPE Fault Parameter	V/f CL-V/f OLV CLV AOLV OLV/PM AOLV/PM CLV/PM EZOLV Displays a parameter number that caused the oPE02 [Parameter Range Setting Error] or oPE08 [Parameter Selection Error].	No signal output available	-
U1-19 (0066)	MEMOBUS/Modbus Error Code	V/f CL-V/f OLV CLV AOLV OLV/PM AOLV/PM CLV/PM EZOLV Displays the contents of the MEMOBUS/Modbus communication error using 1 (error) and 0 (no error). For example, U1-19 = 00000001 is displayed when a CRC error occurs. bit 0 : CRC Error bit 1 : Data Length Error bit 2 : Not used (normal value of 0). bit 3 : Parity Error bit 4 : Overrun Error bit 5 : Framing Error bit 6 : Timed Out bit 7 : Not used (normal value of 0).	No signal output available	-
U1-21 (0077)	AI-A3 Term V1 Monitor	V/f CL-V/f OLV CLV AOLV OLV/PM AOLV/PM CLV/PM EZOLV Displays the input voltage to terminal V1 on analog input option card AI-A3. Unit: 0.1%	10 V = 100% (-10 V to +10 V)	-
U1-22 (072A)	AI-A3 Term V2 Monitor	V/f CL-V/f OLV CLV AOLV OLV/PM AOLV/PM CLV/PM EZOLV Displays the input voltage to terminal V2 on analog input option card AI-A3. Unit: 0.1%	10 V = 100% (-10 V to +10 V)	-
U1-23 (072B)	AI-A3 Term V3 Monitor	V/f CL-V/f OLV CLV AOLV OLV/PM AOLV/PM CLV/PM EZOLV Displays the input voltage to terminal V3 on analog input option card AI-A3. Unit: 0.1%	10 V = 100% (-10 V to +10 V)	-
U1-24 (007D)	Input Pulse Monitor	V/f CL-V/f OLV CLV AOLV OLV/PM AOLV/PM CLV/PM EZOLV Displays the frequency to pulse train input terminal RP. Unit: 1 Hz	Determined by H6-02	-
U1-25 (004D)	SoftwareNumber Flash	V/f CL-V/f OLV CLV AOLV OLV/PM AOLV/PM CLV/PM EZOLV Displays the FLASH ID.	No signal output available	-
U1-26 (005B)	SoftwareNumber ROM	V/f CL-V/f OLV CLV AOLV OLV/PM AOLV/PM CLV/PM EZOLV Displays the ROM ID.	No signal output available	-
U1-50 (1199)	Virtual Ai	V/f CL-V/f OLV CLV AOLV OLV/PM AOLV/PM CLV/PM EZOLV Displays the virtual analog input value.	Determined by H7-40	-
U1-91 (154E)	Output Voltage	V/f CL-V/f OLV CLV AOLV OLV/PM AOLV/PM CLV/PM EZOLV Displays the drive internal output voltage reference. Unit: 0.1 V	200 V class: 10 V = 200 Vrms 400 V class: 10 V = 400 Vrms	-

◆ U2: Fault Trace

No. (Hex.)	Name	Description	MFAO Signal Level	Ref.
U2-01 (0080)	Current Fault	V/f CL-V/f OLV CLV AOLV OLV/PM AOLV/PM CLV/PM EZOLV Displays the current fault.	No signal output available	-
U2-02 (0081)	Previous Fault	V/f CL-V/f OLV CLV AOLV OLV/PM AOLV/PM CLV/PM EZOLV Displays the latest fault.	No signal output available	-

No. (Hex.)	Name	Description	MFAO Signal Level	Ref.
U2-03 (0082)	FreqRef at Pre Fault	<p>V/f CL-V/f OLV CLV AOLV OLV/PM AOLV/PM CLV/PM EZOLV</p> <p>Displays the frequency reference at the latest fault. The current frequency reference can be monitored by <i>U1-01 [Freq Reference]</i>. Unit: 0.01 Hz</p>	No signal output available	-
U2-04 (0083)	OutFreq at Pre Fault	<p>V/f CL-V/f OLV CLV AOLV OLV/PM AOLV/PM CLV/PM EZOLV</p> <p>Displays the output frequency at the latest fault. The current output frequency can be monitored by <i>U1-02 [Output Frequency]</i>. Unit: 0.01 Hz</p>	No signal output available	-
U2-05 (0084)	OutCurr at Pre Fault	<p>V/f CL-V/f OLV CLV AOLV OLV/PM AOLV/PM CLV/PM EZOLV</p> <p>Displays the output current at the latest fault. The current output current can be monitored by <i>U1-03 [Output Current]</i>. The value of <i>U1-03</i> is displayed in ampere (A) on the keypad. When viewing via MEMOBUS/Modbus communications, the current is "8192 = drive rated current (A)." Current can be calculated from the monitor value present at MEMOBUS/Modbus communications using "Numerals being displayed / 8192 × drive rated current (A)." Unit: Determined by the drive model. • Models 2004 to 2042, 4002 to 4023: 0.01 A • Models 2056 to 2415, 4031 to 4726: 0.1 A</p>	No signal output available	-
U2-06 (0085)	MotorSpd at PreFault	<p>V/f CL-V/f OLV CLV AOLV OLV/PM AOLV/PM CLV/PM EZOLV</p> <p>Displays the motor speed at the latest fault. The current motor speed can be monitored by <i>U1-05 [Motor Speed]</i>. Unit: 0.01 Hz</p>	No signal output available	-
U2-07 (0086)	OutVolt at Pre Fault	<p>V/f CL-V/f OLV CLV AOLV OLV/PM AOLV/PM CLV/PM EZOLV</p> <p>Displays the output voltage reference at the latest fault. The current output voltage reference can be monitored by <i>U1-06 [OutVoltage Reference]</i>. Unit: 0.1 V</p>	No signal output available	-
U2-08 (0087)	DCBusVolt atPreFault	<p>V/f CL-V/f OLV CLV AOLV OLV/PM AOLV/PM CLV/PM EZOLV</p> <p>Displays the DC bus voltage at the latest fault. The current DC bus voltage can be monitored by <i>U1-07 [DC Bus Voltage]</i>. Unit: 1 V</p>	No signal output available	-
U2-09 (0088)	Out Pow at Pre Fault	<p>V/f CL-V/f OLV CLV AOLV OLV/PM AOLV/PM CLV/PM EZOLV</p> <p>Displays the output power at the latest fault. The current output power can be monitored by <i>U1-08 [Output Power]</i>. Unit: 0.1 kW</p>	No signal output available	-
U2-10 (0089)	Torque Ref at Previous Fault	<p>V/f CL-V/f OLV CLV AOLV OLV/PM AOLV/PM CLV/PM EZOLV</p> <p>Displays the torque reference at the latest fault as a percentage of the motor rated torque. The current torque reference can be monitored by <i>U1-09 [Torque Reference]</i>. Unit: 0.1%</p>	No signal output available	-

No. (Hex.)	Name	Description	MFAO Signal Level	Ref.
U2-11 (008A)	In Term Status at Previous Fault	<p>V/f CL-V/f OLV CLV AOLV OLV/PM AOLV/PM CLV/PM EZOLV</p> <p>Displays the status of the multi-function digital input terminals at the latest fault using 1 (ON) and 0 (OFF). The status of the current MFDI terminals can be monitored by <i>U1-10 [Input Terminal Status]</i>. For example, <i>U2-11 = 00000011</i> is displayed when terminals S1 and S2 are ON. bit 0 : Terminal S1 bit 1 : Terminal S2 bit 2 : Terminal S3 bit 3 : Terminal S4 bit 4 : Terminal S5 bit 5 : Terminal S6 bit 6 : Terminal S7 bit 7 : Terminal S8</p>	No signal output available	-
U2-12 (008B)	OutTerm Status at Previous Fault	<p>V/f CL-V/f OLV CLV AOLV OLV/PM AOLV/PM CLV/PM EZOLV</p> <p>Displays the status of the multi-function digital output terminal at the latest fault using 1 (ON) and 0 (OFF). The current status of the MFDO terminals can be monitored by <i>U1-11 [Output Terminal Status]</i>. For example, <i>U2-12 = 00000011</i> is displayed when terminals M1 and M3 are ON. bit 0 : Terminals M1-M2 bit 1 : Terminals M3-M4 bit 2 : Terminals P1-C1 bit 3 : Terminals P2-C2 bit 4 : Not used (normal value of 0). bit 5 : Not used (normal value of 0). bit 6 : Not used (normal value of 0). bit 7 : Fault relay MA/MB-MC</p>	No signal output available	-
U2-13 (008C)	DriveOpe Status at Previous Fault	<p>V/f CL-V/f OLV CLV AOLV OLV/PM AOLV/PM CLV/PM EZOLV</p> <p>Displays the operation status of the drive at the latest fault using 1 (ON) and 0 (OFF). The current drive status can be monitored by <i>U1-12 [Drive Status]</i>. For example, <i>U2-13 = 00000001</i> is displayed during run. bit 0 : During run bit 1 : During zero-speed bit 2 : During reverse bit 3 : During fault reset signal input bit 4 : During speed agreement bit 5 : Drive ready bit 6 : During minor fault detection bit 7 : During fault detection</p>	No signal output available	-
U2-14 (008D)	CumOpeTimeatPre Fault	<p>V/f CL-V/f OLV CLV AOLV OLV/PM AOLV/PM CLV/PM EZOLV</p> <p>Displays the cumulative operation time of the drive at the latest fault. The current cumulative operation time can be monitored by <i>U4-01 [Cumulative Ope Time]</i>. Unit: 1 h</p>	No signal output available	-
U2-15 (07E0)	RunSpd SFS atPreFault	<p>V/f CL-V/f OLV CLV AOLV OLV/PM AOLV/PM CLV/PM EZOLV</p> <p>Displays the output frequency after soft start at the latest fault. The current output frequency after soft start can be monitored by <i>U1-16 [Output Freq afterSFS]</i>. Unit: 0.01 Hz</p>	No signal output available	-
U2-16 (07E1)	Motor qCur atPreFault	<p>V/f CL-V/f OLV CLV AOLV OLV/PM AOLV/PM CLV/PM EZOLV</p> <p>Displays the q-axis current of the motor at the latest fault. The current q-axis current of the motor can be monitored by <i>U6-01 [MotorSecondary CurIq]</i>. Unit: 0.1 %</p>	No signal output available	-

No. (Hex.)	Name	Description	MFAO Signal Level	Ref.
U2-17 (07E2)	Motor dCur atPreFalt	<p>V/f CL-V/f OLV CLV AOLV OLV/PM AOLV/PM CLV/PM EZOLV</p> <p>Displays the d-axis current of the motor at the latest fault. The current d-axis current of the motor can be monitored by U6-02 [Motor Excit Cur Id]. Unit: 0.1 %</p>	No signal output available	-
U2-19 (07EC)	RotorDev at PreFault	<p>V/f CL-V/f OLV CLV AOLV OLV/PM AOLV/PM CLV/PM EZOLV</p> <p>Displays the amount of control axis deviation ($\Delta\theta$) at the latest fault. The current amount of control axis deviation ($\Delta\theta$) can be monitored by U6-10 [ContAxisDeviation $\Delta\theta$]. Unit: 0.1 °</p>	No signal output available	-
U2-20 (008E)	HeatsinkTmptatPreFalt	<p>V/f CL-V/f OLV CLV AOLV OLV/PM AOLV/PM CLV/PM EZOLV</p> <p>Displays the heatsink temperature at the latest fault. The current temperature of the heatsink can be monitored by U4-08 [Heatsink Temperature]. Unit: 1 °C</p>	No signal output available	-
U2-21 (1166)	STO Det Sts	<p>V/f CL-V/f OLV CLV AOLV OLV/PM AOLV/PM CLV/PM EZOLV</p> <p>Monitors conditions to detect STPo [Desynchronization Error] faults. The bit for each condition is displayed as ON or OFF.</p> <p>bit 0 : Excessive current bit 1 : Induced voltage deviation bit 2 : d-axis current deviation bit 3 : Motor lock at startup bit 4 : Acceleration stall continue bit 5 : Acceleration stall repeat bit 6 : Not used (normal value of 0). bit 7 : Not used (normal value of 0).</p>	No signal output available	-

◆ U3: Fault History

No. (Hex.)	Name	Description	MFAO Signal Level	Ref.
U3-01 to U3-10 (0090 - 0093) (0804 - 0809)	1st to 10th MostRecent Fault	<p>V/f CL-V/f OLV CLV AOLV OLV/PM AOLV/PM CLV/PM EZOLV</p> <p>Displays the fault history of the 1st to 10th most recent faults.</p> <p>Note: The fault history of U3-01 to U3-04 [1st to 4th MostRecent Fault] is saved to two kinds of registers simultaneously for the MEMOBUS/Modbus communications.</p>	No signal output available	-
U3-11 to U3-20 (0094 - 0097, 080E - 0813)	Elapsed Time 1 to 10	<p>V/f CL-V/f OLV CLV AOLV OLV/PM AOLV/PM CLV/PM EZOLV</p> <p>Displays the cumulative operation time at which the 1st to 10th most recent faults occurred.</p> <p>Unit: 1 h</p> <p>Note: The cumulative operation time of U3-11 to U3-14 [Elapsed Time 1 to 4] is saved to two kinds of registers simultaneously for the MEMOBUS/Modbus communications.</p>	No signal output available	-

◆ U4: Maintenance Monitors

No. (Hex.)	Name	Description	MFAO Signal Level	Ref.
U4-01 (004C)	Cumulative Ope Time	<p>V/f CL-V/f OLV CLV AOLV OLV/PM AOLV/PM CLV/PM EZOLV</p> <p>Displays the cumulative operation time of the drive.</p> <p>The value for the cumulative operation time counter can be reset in <i>o4-01 [Cumulative Operation TimeSetting]</i>. Select the cumulative operation times from the following with <i>o4-02 [Cumulative Operation Time Select]</i>.</p> <ul style="list-style-type: none"> The time when the power supply is energized up to when it is de-energized The time at which the Run command is turned ON <p>The maximum number displayed is 99999. This value will reset to 0 and start counting again after reaching 99999.</p> <p>Unit: 1 h</p> <p>Note: The MEMOBUS/Modbus communication data is displayed in 10 h units. If data in 1 h units are required, refer to register number 0099H.</p>	No signal output available	-
U4-02 (0075)	Num of Run Commands	<p>V/f CL-V/f OLV CLV AOLV OLV/PM AOLV/PM CLV/PM EZOLV</p> <p>Displays the number of times the Run command is entered.</p> <p>Parameter <i>o4-13 [NumOfRunCommands Counter Initial]</i> can be used to reset this monitor. The maximum number displayed is 65535. This value will reset to 0 and start counting again after reaching 65535.</p> <p>Unit: 1</p>	No signal output available	-
U4-03 (0067)	Cooling Fan Ope Time	<p>V/f CL-V/f OLV CLV AOLV OLV/PM AOLV/PM CLV/PM EZOLV</p> <p>Displays the cumulative operation time of the cooling fan.</p> <p>Parameter <i>o4-03 [CoolingFan OperationTime Setting]</i> can be used to reset this monitor. The maximum number displayed is 99999. This value will reset to 0 and start counting again after reaching 99999.</p> <p>Unit: 1 h</p> <p>Note: The MEMOBUS/Modbus communication data is displayed in 10 h units. If data in 1 h units are required, refer to register number 009BH.</p>	No signal output available	-
U4-04 (007E)	Cool Fan Maintenance	<p>V/f CL-V/f OLV CLV AOLV OLV/PM AOLV/PM CLV/PM EZOLV</p> <p>Displays the cumulative operation time of the cooling fan as a percentage of the replacement life of the cooling fan.</p> <p>Parameter <i>o4-03 [CoolingFan OperationTime Setting]</i> can be used to reset this monitor.</p> <p>Unit: 1%</p> <p>Note: Replace the cooling fan when this monitor reaches 90%.</p>	No signal output available	-
U4-05 (007C)	CapacitorMaintenance	<p>V/f CL-V/f OLV CLV AOLV OLV/PM AOLV/PM CLV/PM EZOLV</p> <p>Displays the usage time of the electrolytic capacitor for the main and control circuits as a percentage of the replacement life of the electrolytic capacitor.</p> <p>Parameter <i>o4-05 [Capacitor Maintenance Setting]</i> can be used to reset this monitor.</p> <p>Unit: 1%</p> <p>Note: Replace the electrolytic capacitor when this monitor reaches 90%.</p>	No signal output available	-
U4-06 (07D6)	SChgBypassRelay Maint	<p>V/f CL-V/f OLV CLV AOLV OLV/PM AOLV/PM CLV/PM EZOLV</p> <p>Displays the usage time of the soft charge bypass relay as a percentage of the replacement life of the soft charge bypass relay.</p> <p>Parameter <i>o4-07 [DCBusPreChargeRelayMaintSetting]</i> can be used to reset this monitor.</p> <p>Unit: 1%</p> <p>Note: Replace the drive when this monitor reaches 90%.</p>	No signal output available	-

No. (Hex.)	Name	Description	MFAO Signal Level	Ref.
U4-07 (07D7)	IGBT Maintenance	<p>V/f CL-V/f OLV CLV AOLV OLV/PM AOLV/PM CLV/PM EZOLV</p> <p>Displays the usage time of the IGBT as a percentage of the replacement life of the IGBT.</p> <p>Parameter <i>o4-09 [IGBT Maintenance Setting]</i> can be used to reset this monitor.</p> <p>Unit: 1%</p> <p>Note: Replace the drive when this monitor reaches 90%.</p>	No signal output available	-
U4-08 (0068)	Heatsink Temperature	<p>V/f CL-V/f OLV CLV AOLV OLV/PM AOLV/PM CLV/PM EZOLV</p> <p>Displays the heatsink temperature of the drive.</p> <p>Unit: 1 °C</p>	10 V: 100 °C	-
U4-09 (005E)	LED Check	<p>V/f CL-V/f OLV CLV AOLV OLV/PM AOLV/PM CLV/PM EZOLV</p> <p>Lights all segments of the LEDs on the keypad and LED Status Ring light to verify that the display is working properly.</p> <p>Note: The internal status of the drive cannot be determined when the board for the LED Status Ring is damaged. Do not rely on the LED Status Ring alone to determine the status of the drive and motors.</p> <ol style="list-style-type: none"> Set <i>o2-24 = 0 [LED Light Function Selection = Both Enable]</i>. With <i>U4-09</i> displayed, press . <p>All LEDs on the keypad and LED Status Ring will glow.</p> <p>Note: When Safety input 2 CH is open (STo), READY will flash.</p>	No signal output available	-
U4-10 (005C)	kWh, Lower 4 Digits	<p>V/f CL-V/f OLV CLV AOLV OLV/PM AOLV/PM CLV/PM EZOLV</p> <p>Displays the lower 4 digits of the watt hour value for the drive.</p> <p>Unit: 1 kWh</p> <p>Note: The watt hour is displayed in 9 digits. Parameter <i>U4-11 [kWh, Upper 5 Digits]</i> displays the upper 5 digits and <i>U4-10</i> displays the lower 4 digits.</p> <p>Example for 12345678.9 kWh: <i>U4-10</i>: 678.9 kWh <i>U4-11</i>: 12345 MWh</p>	No signal output available	-
U4-11 (005D)	kWh, Upper 5 Digits	<p>V/f CL-V/f OLV CLV AOLV OLV/PM AOLV/PM CLV/PM EZOLV</p> <p>Displays the upper 5 digits of the watt hour value for the drive.</p> <p>Unit: 1 MWh</p> <p>Note: The watt hour is displayed in 9 digits. Parameter <i>U4-11</i> displays the upper 5 digits and <i>U4-10 [kWh, Lower 4 Digits]</i> displays the lower 4 digits.</p> <p>Example for 12345678.9 kWh: <i>U4-10</i>: 678.9 kWh <i>U4-11</i>: 12345 MWh</p>	No signal output available	-
U4-13 (07CF)	Peak Hold Current	<p>V/f CL-V/f OLV CLV AOLV OLV/PM AOLV/PM CLV/PM EZOLV</p> <p>Displays the hold value of the peak value (rms) for the drive output current.</p> <p>The drive output frequency at the time the output current is held can be monitored by <i>U4-14 [PeakHold Output Freq]</i>.</p> <p>The peak hold current will be cleared at the next startup and restart of the power supply. The drive keeps the value that was under hold during baseblock (during stop).</p> <p>The value of <i>U4-13</i> appears in amperes (A) on the keypad. When viewing via MEMOBUS/Modbus communications, the current is "8192 = drive rated current (A)." Current can be calculated from the monitor value present at MEMOBUS/Modbus communications using "Numerals being displayed / 8192 × drive rated current (A)."</p> <p>Unit: Determined by the drive model.</p> <ul style="list-style-type: none"> Models 2004 to 2042, 4002 to 4023: 0.01 A Models 2056 to 2415, 4031 to 4726: 0.1 A 	No signal output available	-

No. (Hex.)	Name	Description	MFAO Signal Level	Ref.
U4-14 (07D0)	PeakHold Output Freq	<p>V/f CL-V/f OLV CLV AOLV OLV/PM AOLV/PM CLV/PM EZOLV</p> <p>Displays the output frequency at which the peak value (rms) of the drive output current is held.</p> <p>The peak hold current can be monitored by U4-13 [Peak Hold Current].</p> <p>The peak hold output frequency will be cleared at the next startup and restart of the power supply. The drive keeps the value that was under hold during baseblock (during stop).</p> <p>Unit: 0.01 Hz</p>	No signal output available	-
U4-16 (07D8)	MotorOLEstimate (oL1)	<p>V/f CL-V/f OLV CLV AOLV OLV/PM AOLV/PM CLV/PM EZOLV</p> <p>Displays the integrated value of oL1 [Motor Overload] as a percentage of oL1 detection level.</p> <p>Unit: 0.1%</p>	10 V: 100%	-
U4-18 (07DA)	Freq Ref Source Sel	<p>V/f CL-V/f OLV CLV AOLV OLV/PM AOLV/PM CLV/PM EZOLV</p> <p>Displays the frequency reference source that is currently selected.</p> <p>The frequency reference source is presented as XY-nn in the following manner.</p> <p>X: External Reference 1/2 Selection [H1-xx = 2] selection status</p> <ul style="list-style-type: none"> • 1: b1-01 [Frequency Reference Selection 1] • 2: b1-15 [Frequency Reference Selection 2] <p>Y-nn: Frequency reference source</p> <ul style="list-style-type: none"> • 0-01: Keypad (d1-01 [Reference 1]) • 1-00: Analog input (unassigned) • 1-01: MFAI terminal A1 • 1-02: MFAI terminal A2 • 1-03: MFAI terminal A3 • 2-02 to 2-17: Multi-step speed reference (d1-02 to d1-17 [Reference 2 to 16, Jog Reference]) • 3-01: MEMOBUS/Modbus communications • 4-01: Communication option card • 5-01: Pulse train input • 7-01: DriveWorksEZ • 9-01: Up/Down command 	No signal output available	-
U4-19 (07DB)	Freq Ref from Comm	<p>V/f CL-V/f OLV CLV AOLV OLV/PM AOLV/PM CLV/PM EZOLV</p> <p>Displays the frequency reference to the drive from the MEMOBUS/Modbus communications as a decimal number.</p> <p>Unit: 0.01%</p>	No signal output available	-
U4-20 (07DC)	Option FreqReference	<p>V/f CL-V/f OLV CLV AOLV OLV/PM AOLV/PM CLV/PM EZOLV</p> <p>Displays the frequency reference to the drive from the communication option as a decimal number.</p>	No signal output available	-

No. (Hex.)	Name	Description	MFAO Signal Level	Ref.
U4-21 (07DD)	RunCom Source Select	<p>V/f CL-V/f OLV CLV AOLV OLV/PM AOLV/PM CLV/PM EZOLV</p> <p>Displays the Run command source that is currently selected. The Run command source is presented as XY-nn in the following manner.</p> <p>X: <i>External Reference 1/2 Selection [H1-xx = 2]</i> selection status</p> <ul style="list-style-type: none"> • 1: <i>b1-02 [Run Command Selection 1]</i> • 2: <i>b1-16 [Run Command Selection 2]</i> <p>Y: Run command source</p> <ul style="list-style-type: none"> • 0: Keypad • 1: Control circuit terminal • 3: MEMOBUS/Modbus communications • 4: Communication option card • 7: DriveWorksEZ <p>nn: Run command limit status data</p> <ul style="list-style-type: none"> • 00: No limit status. • 01: The Run command was left ON when the drive stopped in the Programming Mode. • 02: The Run command was left ON when switching from LOCAL Mode to REMOTE Mode. • 03: The Run command is in standby after the drive was energized until the soft charge bypass contactor turns ON. <p>Note: When the soft charge bypass contactor does not turn ON after 10 s have passed, <i>Uv1 [DC Bus Undervoltage]</i> or <i>Uv [Undervoltage]</i> is detected.</p> <ul style="list-style-type: none"> • 04: Restart after run stop is prohibited. • 05: Fast stop has been executed using the MFDI terminal. Or, the motor has ramped to stop by pressing the STOP key on the keypad. • 06: <i>b1-17 = 0 [Run Command at Power Up = Disregard existing RUN command]</i> is set. • 07: During baseblock while coast to stop with timer. • 08: Frequency reference is below <i>E1-09 [Minimum Output Frequency]</i> during baseblock. • 09: Waiting for the Enter command from PLC. 	No signal output available	-
U4-22 (07DE)	MEMOBUS Comm Ref	<p>V/f CL-V/f OLV CLV AOLV OLV/PM AOLV/PM CLV/PM EZOLV</p> <p>Displays the operation signal (register No. 0001H) from MEMOBUS/Modbus communications to the drive as a four-digit hexadecimal number (zero suppress).</p> <p>The operation signal is displayed in the following way.</p> <p>bit 0 : Forward run/Stop bit 1 : Reverse run/Stop bit 2 : External fault bit 3 : Fault Reset bit 4 : Multi-function input 1 bit 5 : Multi-function input 2 bit 6 : Multi-function input 3 bit 7 : Multi-function input 4 bit 8 : Multi-function input 5 bit 9 : Multi-function input 6 bit A : Multi-function input 7 bit B : Multi-function input 8 bit C : Not used (normal value of 0). bit D : Not used (normal value of 0). bit E : Not used (normal value of 0). bit F : Not used (normal value of 0).</p>	No signal output available	-

No. (Hex.)	Name	Description	MFAO Signal Level	Ref.
U4-23 (07DF)	Comm Option Card Ref	<p>V/f CL-V/f OLV CLV AOLV OLV/PM AOLV/PM CLV/PM EZOLV</p> <p>Displays the operation signal (register No. 0001H) from communication option to the drive as a four-digit hexadecimal number.</p> <p>The operation signal is displayed in the following way.</p> <p>bit 0 : Forward run/Stop bit 1 : Reverse run/Stop bit 2 : External fault bit 3 : Fault Reset bit 4 : Multi-function input 1 bit 5 : Multi-function input 2 bit 6 : Multi-function input 3 bit 7 : Multi-function input 4 bit 8 : Multi-function input 5 bit 9 : Multi-function input 6 bit A : Multi-function input 7 bit B : Multi-function input 8 bit C : Not used (normal value of 0). bit D : Not used (normal value of 0). bit E : Not used (normal value of 0). bit F : Not used (normal value of 0).</p>	No signal output available	-
U4-24 (07E6)	No of Travels(L)	<p>V/f CL-V/f OLV CLV AOLV OLV/PM AOLV/PM CLV/PM EZOLV</p> <p>Displays the lower 4 digits of the drive run count.</p> <p>Note: The drive run count appears as an 8-digit number. The upper 4 digits of U4-25 [No of Travels(H)] and the lower 4 digits of U4-24 appears.</p>	No signal output available	-
U4-25 (07E7)	No of Travels(H)	<p>V/f CL-V/f OLV CLV AOLV OLV/PM AOLV/PM CLV/PM EZOLV</p> <p>Displays the upper 4 digits of the drive run count.</p> <p>Note: The drive run count appears as an 8-digit number. The upper 4 digits of U4-25 and the lower 4 digits of U4-24 [No of Travels(L)] appears.</p>	No signal output available	-

◆ U5: PID Monitors

No. (Hex.)	Name	Description	MFAO Signal Level	Ref.
U5-01 (0057)	PID Feedback	<p>V/f CL-V/f OLV CLV AOLV OLV/PM AOLV/PM CLV/PM EZOLV</p> <p>Displays the PID control feedback value. Display units are set by b5-20 [PID Setpoint Scaling]. Unit: 0.01%</p>	10 V: Maximum frequency (-10 V to +10 V)	-
U5-02 (0063)	PID Input	<p>V/f CL-V/f OLV CLV AOLV OLV/PM AOLV/PM CLV/PM EZOLV</p> <p>Displays the deviation between the PID setpoint and PID feedback (the amount of PID input) as a percentage of the maximum output frequency. Unit: 0.01%</p>	10 V: Maximum frequency (-10 V to +10 V)	-
U5-03 (0064)	PID Output	<p>V/f CL-V/f OLV CLV AOLV OLV/PM AOLV/PM CLV/PM EZOLV</p> <p>Displays the PID control output as a percentage of the maximum output frequency. Unit: 0.01%</p>	10 V: Maximum frequency (-10 V to +10 V)	-
U5-04 (0065)	PID Setpoint	<p>V/f CL-V/f OLV CLV AOLV OLV/PM AOLV/PM CLV/PM EZOLV</p> <p>Displays the PID setpoint. Display units are set by b5-20 [PID Setpoint Scaling]. Unit: 0.01%</p>	10 V: Maximum frequency (-10 V to +10 V)	-

No. (Hex.)	Name	Description	MFAO Signal Level	Ref.
U5-05 (07D2)	PID DifferentialFdbk	V/f CL-V/f OLV CLV AOLV OLV/PM AOLV/PM CLV/PM EZOLV Displays the PID differential feedback value as a percentage of the maximum output frequency. This parameter is available when <i>H3-02, H3-10, or H3-06 = 16 [MFAI Function Select = Differential PID Feedback]</i> is set. Unit: 0.01%	10 V: Maximum frequency (-10 V to +10 V)	-
U5-06 (07D3)	PID AdjustedFeedback	V/f CL-V/f OLV CLV AOLV OLV/PM AOLV/PM CLV/PM EZOLV Displays the final feedback value after subtracting <i>U5-05 [PID DifferentialFdbk]</i> from <i>U5-01 [PID Feedback]</i> . Unit: 0.01% Note: When <i>H3-02, H3-10, H3-16 = 16 [MFAI = Differential PID Feedback]</i> is not set, <i>U5-01 [PID Feedback]</i> and <i>U5-06</i> will be the same value.	10 V: Maximum frequency (-10 V to +10 V)	-
U5-21 (0872)	AutoCalEnSav Coef Ki	V/f CL-V/f OLV CLV AOLV OLV/PM AOLV/PM CLV/PM EZOLV Displays the energy-saving coefficient Ki value for PM. Unit: 0.01	No signal output available	-
U5-22 (0873)	AutoCalEnSav Coef Kt	V/f CL-V/f OLV CLV AOLV OLV/PM AOLV/PM CLV/PM EZOLV Displays the energy-saving coefficient Kt value for PM. Unit: 0.01	No signal output available	-
U5-99 (1599)	PID Setpoint Command	V/f CL-V/f OLV CLV AOLV OLV/PM AOLV/PM CLV/PM EZOLV Displays the PID setpoint command. Display units are set by <i>b5-20 [PID Setpoint Scaling]</i> . Unit: 0.01%	10 V: Maximum frequency (-10 V to +10 V)	-

◆ U6: Operation Status Monitors

No. (Hex.)	Name	Description	MFAO Signal Level	Ref.
U6-01 (0051)	MotorSecondary CurIq	V/f CL-V/f OLV CLV AOLV OLV/PM AOLV/PM CLV/PM EZOLV Displays the value calculated for the motor secondary current as a percentage of the motor rated secondary current. (q axis) Unit: 0.1%	10 V: Motor secondary rated current (-10 V to +10 V)	-
U6-02 (0052)	Motor Excit Cur Id	V/f CL-V/f OLV CLV AOLV OLV/PM AOLV/PM CLV/PM EZOLV Displays the value calculated for the motor excitation current as a percentage of the motor rated secondary current. (d axis) Unit: 0.1%	10 V: Motor secondary rated current (-10 V to +10 V)	-
U6-03 (0054)	ASR Input	V/f CL-V/f OLV CLV AOLV OLV/PM AOLV/PM CLV/PM EZOLV Displays the ASR input value as a percentage of the maximum frequency. Unit: 0.01%	10 V: Maximum frequency (-10 V to +10 V)	-
U6-04 (0055)	ASR Output	V/f CL-V/f OLV CLV AOLV OLV/PM AOLV/PM CLV/PM EZOLV Displays the ASR output value as a percentage of the motor rated secondary current. Unit: 0.01%	10 V: Motor secondary rated current (-10 V to +10 V)	-
U6-05 (0059)	OutVolt Reference Vq	V/f CL-V/f OLV CLV AOLV OLV/PM AOLV/PM CLV/PM EZOLV Displays the drive internal voltage reference for motor secondary current control. (q axis) Unit: 0.1 V	200 V class: 10 V = 200 Vrms 400 V class: 10 V = 400 Vrms (-10 V to +10 V)	-
U6-06 (005A)	OutVolt Reference Vd	V/f CL-V/f OLV CLV AOLV OLV/PM AOLV/PM CLV/PM EZOLV Displays the drive internal voltage reference for motor excitation current control. (d axis) Unit: 0.1 V	200 V class: 10 V = 200 Vrms 400 V class: 10 V = 400 Vrms (-10 V to +10 V)	-

No. (Hex.)	Name	Description	MFAO Signal Level	Ref.
U6-07 (005F)	q-Axis ACR Output	<input type="checkbox"/> V/f <input type="checkbox"/> CL-V/f <input checked="" type="checkbox"/> OLV <input checked="" type="checkbox"/> CLV <input type="checkbox"/> AOLV <input type="checkbox"/> OLV/PM <input type="checkbox"/> AOLV/PM <input type="checkbox"/> CLV/PM <input type="checkbox"/> EZOLV Displays the output value for current control relative to motor secondary current. (q axis) Unit: 0.1%	200 V class: 10 V = 200 Vrms 400 V class: 10 V = 400 Vrms (-10 V to +10 V)	-
U6-08 (0060)	d-Axis ACR Output	<input type="checkbox"/> V/f <input type="checkbox"/> CL-V/f <input checked="" type="checkbox"/> OLV <input checked="" type="checkbox"/> CLV <input type="checkbox"/> AOLV <input type="checkbox"/> OLV/PM <input type="checkbox"/> AOLV/PM <input type="checkbox"/> CLV/PM <input type="checkbox"/> EZOLV Displays the output value for current control relative to motor excitation current. (d axis) Unit: 0.1%	200 V class: 10 V = 200 Vrms 400 V class: 10 V = 400 Vrms (-10 V to +10 V)	-
U6-09 (07C0)	AdvPhase Compen Δθ	<input type="checkbox"/> V/f <input type="checkbox"/> CL-V/f <input type="checkbox"/> OLV <input type="checkbox"/> CLV <input type="checkbox"/> AOLV <input type="checkbox"/> OLV/PM <input checked="" type="checkbox"/> AOLV/PM <input type="checkbox"/> CLV/PM <input type="checkbox"/> EZOLV Displays the data on forward phase compensation for the calculation results of the amount of control axis deviation. Unit: 1 °	10 V: 180° (-10 V to +10 V)	-
U6-10 (07C1)	ContAxisDeviation Δθ	<input type="checkbox"/> V/f <input type="checkbox"/> CL-V/f <input type="checkbox"/> OLV <input type="checkbox"/> CLV <input type="checkbox"/> AOLV <input type="checkbox"/> OLV/PM <input checked="" type="checkbox"/> AOLV/PM <input type="checkbox"/> CLV/PM <input checked="" type="checkbox"/> EZOLV Displays the amount of deviation between the γδ-Axis used for motor control and the actual dq-Axis. Unit: 0.1 °	10 V: 180° (-10 V to +10 V)	-
U6-13 (07CA)	FluxPosDetect sensor	<input type="checkbox"/> V/f <input type="checkbox"/> CL-V/f <input type="checkbox"/> OLV <input type="checkbox"/> CLV <input type="checkbox"/> AOLV <input type="checkbox"/> OLV/PM <input type="checkbox"/> AOLV/PM <input checked="" type="checkbox"/> CLV/PM <input type="checkbox"/> EZOLV Displays the value of the flux position detection. Unit: 0.1 °	10 V: 180° (-10 V to +10 V)	-
U6-14 (07CB)	FluxPosEstimOb server	<input type="checkbox"/> V/f <input type="checkbox"/> CL-V/f <input type="checkbox"/> OLV <input type="checkbox"/> CLV <input type="checkbox"/> AOLV <input type="checkbox"/> OLV/PM <input checked="" type="checkbox"/> AOLV/PM <input type="checkbox"/> CLV/PM <input checked="" type="checkbox"/> EZOLV Displays the value of the flux position estimation. Unit: 0.1 °	10 V: 180° (-10 V to +10 V)	-
U6-17 (07D1)	Total Current Value for Detection of Direction of Motor Rotation	<input type="checkbox"/> V/f <input checked="" type="checkbox"/> CL-V/f <input checked="" type="checkbox"/> OLV <input type="checkbox"/> CLV <input type="checkbox"/> AOLV <input type="checkbox"/> OLV/PM <input type="checkbox"/> AOLV/PM <input type="checkbox"/> CLV/PM <input type="checkbox"/> EZOLV Displays the accumulated time of direction of motor rotation detections for Speed Estimation Speed Searches. This is used to adjust the value of <i>b3-26 [Direction Determining Level]</i> . Note: Upper and lower limits are set to values of ±32767.	No signal output available	-
U6-18 (07CD)	SpdDetectPG1 Counter	<input type="checkbox"/> V/f <input type="checkbox"/> CL-V/f <input checked="" type="checkbox"/> OLV <input type="checkbox"/> CLV <input type="checkbox"/> AOLV <input type="checkbox"/> OLV/PM <input type="checkbox"/> AOLV/PM <input type="checkbox"/> CLV/PM <input checked="" type="checkbox"/> EZOLV Displays the number of pulses for speed detection (PG1). Unit: 1 pulse	10 V: 65536	-
U6-19 (07E5)	SpdDetectPG2 Counter	<input type="checkbox"/> V/f <input type="checkbox"/> CL-V/f <input checked="" type="checkbox"/> OLV <input type="checkbox"/> CLV <input type="checkbox"/> AOLV <input type="checkbox"/> OLV/PM <input type="checkbox"/> AOLV/PM <input type="checkbox"/> CLV/PM <input checked="" type="checkbox"/> EZOLV Displays the number of pulses for speed detection (PG2). Unit: 1 pulse	10 V: 65536	-
U6-20 (07D4)	Frequency Ref Bias (Up/Down 2)	<input type="checkbox"/> V/f <input type="checkbox"/> CL-V/f <input checked="" type="checkbox"/> OLV <input type="checkbox"/> CLV <input type="checkbox"/> AOLV <input type="checkbox"/> OLV/PM <input type="checkbox"/> AOLV/PM <input type="checkbox"/> CLV/PM <input checked="" type="checkbox"/> EZOLV Displays the bias value used to adjust the frequency reference. Unit: 0.1%	10 V: Maximum Frequency	-
U6-21 (07D5)	Offset Frequency	<input type="checkbox"/> V/f <input type="checkbox"/> CL-V/f <input checked="" type="checkbox"/> OLV <input type="checkbox"/> CLV <input type="checkbox"/> AOLV <input type="checkbox"/> OLV/PM <input type="checkbox"/> AOLV/PM <input type="checkbox"/> CLV/PM <input checked="" type="checkbox"/> EZOLV Displays the total value of <i>d7-01 to d7-03 [Offset Frequency 1 to 3]</i> selected with <i>Offset frequency 1 to 3 [H1-xx = 44 to 46]</i> . Unit: 0.1%	10 V: Maximum Frequency	-
U6-22 (0062)	ZeroServoPulse Move	<input type="checkbox"/> V/f <input type="checkbox"/> CL-V/f <input type="checkbox"/> OLV <input checked="" type="checkbox"/> CLV <input type="checkbox"/> AOLV <input type="checkbox"/> OLV/PM <input type="checkbox"/> AOLV/PM <input checked="" type="checkbox"/> CLV/PM <input type="checkbox"/> EZOLV Displays how far the rotor has moved from its last position when Zero Servo is available. Displays a number that is 4 times the number of PG pulses. Unit: 1 pulse	10 V: Number of pulses per revolution (-10 V to +10 V)	-
U6-25 (006B)	Fdbk Control Output	<input type="checkbox"/> V/f <input type="checkbox"/> CL-V/f <input type="checkbox"/> OLV <input type="checkbox"/> CLV <input type="checkbox"/> AOLV <input type="checkbox"/> OLV/PM <input type="checkbox"/> AOLV/PM <input checked="" type="checkbox"/> CLV/PM <input type="checkbox"/> EZOLV Displays the primary delay filter input value of the ASR (speed control loop). Unit: 0.01%	10 V: Motor secondary rated current (-10 V to +10 V)	-
U6-26 (006C)	Feed Fwd Cont Output	<input type="checkbox"/> V/f <input type="checkbox"/> CL-V/f <input type="checkbox"/> OLV <input type="checkbox"/> CLV <input type="checkbox"/> AOLV <input type="checkbox"/> OLV/PM <input type="checkbox"/> AOLV/PM <input checked="" type="checkbox"/> CLV/PM <input type="checkbox"/> EZOLV Displays the Feed Forward control output. Unit: 0.01%	10 V: Motor secondary rated current (-10 V to +10 V)	-

No. (Hex.)	Name	Description	MFAO Signal Level	Ref.
U6-27 (006D)	FF Estimate SPD	<input type="checkbox"/> V/f <input type="checkbox"/> CL-V/f <input type="checkbox"/> OLV <input type="checkbox"/> CLV <input type="checkbox"/> AOLV <input type="checkbox"/> OLV/PM <input type="checkbox"/> AOLV/PM <input type="checkbox"/> CLV/PM <input type="checkbox"/> EZOLV Displays the feed forward estimated speed. Unit: 0.01%	10 V = Maximum frequency (-10 V to +10 V)	-
U6-36 (0720)	Comm Errors-HOST	<input type="checkbox"/> V/f <input type="checkbox"/> CL-V/f <input type="checkbox"/> OLV <input type="checkbox"/> CLV <input type="checkbox"/> AOLV <input type="checkbox"/> OLV/PM <input type="checkbox"/> AOLV/PM <input type="checkbox"/> CLV/PM <input type="checkbox"/> EZOLV Counts the number of inter-CPU communication errors. This count is reset to 0 when the power to the drive is turned off.	No signal output available	-
U6-37 (0721)	Comm Errors-Sensor	<input type="checkbox"/> V/f <input type="checkbox"/> CL-V/f <input type="checkbox"/> OLV <input type="checkbox"/> CLV <input type="checkbox"/> AOLV <input type="checkbox"/> OLV/PM <input type="checkbox"/> AOLV/PM <input type="checkbox"/> CLV/PM <input type="checkbox"/> EZOLV Counts the number of inter-CPU communication errors. This count is reset to 0 when the power to the drive is turned off.	No signal output available	-
U6-48 (072E)	ASIC Comm Errors	<input type="checkbox"/> V/f <input type="checkbox"/> CL-V/f <input type="checkbox"/> OLV <input type="checkbox"/> CLV <input type="checkbox"/> AOLV <input type="checkbox"/> OLV/PM <input type="checkbox"/> AOLV/PM <input type="checkbox"/> CLV/PM <input type="checkbox"/> EZOLV Counts the number of inter-ASIC communication errors detected by the ASIC. This count is reset to 0 when the power to the drive is turned off.	No signal output available	-
U6-57 (07C4)	PoleDis IdDifVal	<input type="checkbox"/> V/f <input type="checkbox"/> CL-V/f <input type="checkbox"/> OLV <input type="checkbox"/> CLV <input type="checkbox"/> AOLV <input type="checkbox"/> OLV/PM <input type="checkbox"/> AOLV/PM <input type="checkbox"/> CLV/PM <input type="checkbox"/> EZOLV Displays the deviation from the integrated current when determining the polarity. Unit: 1 Note: If the deviation from the integrated current is lower than 819, then increase the value set to $n8-84$ [InitPolarityEstimationTimeoutCur]. $U6-57 = 8192$ is equivalent to the motor rated current.	No signal output available	-
U6-80 to U6-83 (07B0 to 07B3)	OPT IP ADR1 to 4	<input type="checkbox"/> V/f <input type="checkbox"/> CL-V/f <input type="checkbox"/> OLV <input type="checkbox"/> CLV <input type="checkbox"/> AOLV <input type="checkbox"/> OLV/PM <input type="checkbox"/> AOLV/PM <input type="checkbox"/> CLV/PM <input type="checkbox"/> EZOLV Displays the currently available local IP Address. • U6-80: 1st octet • U6-81: 2nd octet • U6-82: 3rd octet • U6-83: 4th octet	No signal output available	-
U6-84 to U6-87 (07B4 to 07B7)	Online Subnets 1 to 4	<input type="checkbox"/> V/f <input type="checkbox"/> CL-V/f <input type="checkbox"/> OLV <input type="checkbox"/> CLV <input type="checkbox"/> AOLV <input type="checkbox"/> OLV/PM <input type="checkbox"/> AOLV/PM <input type="checkbox"/> CLV/PM <input type="checkbox"/> EZOLV Displays the currently available subnet mask. • U6-84: 1st octet • U6-85: 2nd octet • U6-86: 3rd octet • U6-87: 4th octet	No signal output available	-
U6-88 to U6-91 (07B8 to 07F1)	Online Gateways 1 to 4	<input type="checkbox"/> V/f <input type="checkbox"/> CL-V/f <input type="checkbox"/> OLV <input type="checkbox"/> CLV <input type="checkbox"/> AOLV <input type="checkbox"/> OLV/PM <input type="checkbox"/> AOLV/PM <input type="checkbox"/> CLV/PM <input type="checkbox"/> EZOLV Displays the currently available gateway address. • U6-88: 1st octet • U6-89: 2nd octet • U6-90: 3rd octet • U6-91: 4th octet	No signal output available	-
U6-92 (07F2)	Online Speed	<input type="checkbox"/> V/f <input type="checkbox"/> CL-V/f <input type="checkbox"/> OLV <input type="checkbox"/> CLV <input type="checkbox"/> AOLV <input type="checkbox"/> OLV/PM <input type="checkbox"/> AOLV/PM <input type="checkbox"/> CLV/PM <input type="checkbox"/> EZOLV Displays the currently available communications speed. 10: 10 Mbps 100: 100 Mbps	No signal output available	-
U6-93 (07F3)	Online Duplex	<input type="checkbox"/> V/f <input type="checkbox"/> CL-V/f <input type="checkbox"/> OLV <input type="checkbox"/> CLV <input type="checkbox"/> AOLV <input type="checkbox"/> OLV/PM <input type="checkbox"/> AOLV/PM <input type="checkbox"/> CLV/PM <input type="checkbox"/> EZOLV Displays the currently available Duplex setting.	No signal output available	-
U6-98 (07F8)	First Fault	<input type="checkbox"/> V/f <input type="checkbox"/> CL-V/f <input type="checkbox"/> OLV <input type="checkbox"/> CLV <input type="checkbox"/> AOLV <input type="checkbox"/> OLV/PM <input type="checkbox"/> AOLV/PM <input type="checkbox"/> CLV/PM <input type="checkbox"/> EZOLV Displays the contents of previous fault from communication options (DeviceNet, Modbus TCP/IP, EtherNet/IP).	No signal output available	-
U6-99 (07F9)	Current Fault	<input type="checkbox"/> V/f <input type="checkbox"/> CL-V/f <input type="checkbox"/> OLV <input type="checkbox"/> CLV <input type="checkbox"/> AOLV <input type="checkbox"/> OLV/PM <input type="checkbox"/> AOLV/PM <input type="checkbox"/> CLV/PM <input type="checkbox"/> EZOLV Displays the contents of current faults from communication options (DeviceNet, Modbus TCP/IP, EtherNet/IP).	No signal output available	-

◆ U8: DriveWorksEZ Monitors

No. (Hex.)	Name	Description	MFAO signal level	Ref.
U8-01 to U8-10 (1950 - 1959)	DriveWorksEZ User Monitors 1 to 10	V/f CL-V/f OLV CLV AOLV OLV/PM AOLV/PM CLV/PM EZOLV Displays DWEZ Monitors 1 to 10. Unit: 0.01%	10 V = 100%	-
U8-11 to U8-13 (195A - 195C)	DWEZ Versions 1 to 3	V/f CL-V/f OLV CLV AOLV OLV/PM AOLV/PM CLV/PM EZOLV Displays DriveWorks EZ Versions 1 to 3.	No signal output available	-
U8-18 (1961)	DriveWorksEZ Platform Ver	V/f CL-V/f OLV CLV AOLV OLV/PM AOLV/PM CLV/PM EZOLV Displays the DriveWorksEZ platform version.	No signal output available	-
U8-21 to U8-25 (1964 - 1968)	DriveWorksEZ User Monitors 21 to 25	V/f CL-V/f OLV CLV AOLV OLV/PM AOLV/PM CLV/PM EZOLV Displays DriveWorksEZ User Monitors 21 to 25. 0.01%	10 V = 100%	-
U8-31 to U8-40 (196E - 1977)	DriveWorksEZ User Monitors 31 to 40	V/f CL-V/f OLV CLV AOLV OLV/PM AOLV/PM CLV/PM EZOLV Displays DriveWorksEZ User Monitors 31 to 40. 0.01%	10 V = 100%	-
U8-51 to U8-55 (1982 - 1986)	DriveWorksEZ User Monitors 51 to 55	V/f CL-V/f OLV CLV AOLV OLV/PM AOLV/PM CLV/PM EZOLV Displays DriveWorksEZ User Monitors 51 to 55. 0.01%	10 V = 100%	-

10.18 A1-02 [Motor 1 Control Mode] Dependent Parameters

The parameters listed in the following table depend on the setting of *A1-02*. The default settings change as the setting of *A1-02* is changed.

◆ A1-02 = 0 to 4 [Induction Motor Control Method]

No.	Name	Setting Range	Unit	Control Method (Value set in A1-02)				
				V/f (0)	CL-V/f (1)	OLV (2)	CLV (3)	AOLV (4)
b2-01	DC Injection/Zero SpeedThreshold	0.0 to 10.0	0.1 Hz	0.5	0.5	0.5	0.5	0.5
b2-04	DC Inject Braking Time at Stop	0.00 to 10.00	0.01 s	0.50	0.50	0.50	0.50	0.50
b3-01	Speed Search Selection	0 to 1	1	0	1	0	1	0
b3-14	Bi-Direction Speed Search Select	0 to 1	1	1	0	1	1	1
b5-15	Sleep Function Operation Level	0.0 to 400.0	0.1 Hz	0.0	0.0	0.0	0.0	0.0
b6-01	Dwell Reference at Start	0.0 to 400.0	0.1 Hz	0.0	0.0	0.0	0.0	0.0
b6-03	Dwell Reference at Stop	0.0 to 400.0	0.1 Hz	0.0	0.0	0.0	0.0	0.0
b8-02	Energy Saving Gain	0.0 to 10.0	0.1	-	-	0.7	1.0	1.0
b8-03	Energy Saving Filter Time	0.00 to 10.00	0.01 s	-	-	0.50 *1	0.01 *1	0.01 *1
C1-11	Accel/Decel Time Switchover Freq	0.0 to 400.0	0.1 Hz	0.0	0.0	0.0	0.0	0.0
C2-01	S-Curve Time @ start of Accel	0.00 to 10.00	0.01 s	0.20	0.20	0.20	0.20	0.20
C3-01	Slip Compensation Gain	0.0 to 2.5	0.1	0.0	-	1.0	1.0	0.1
C3-02	Slip Compensation Delay Time	0 to 10000	1 ms	2000	-	200	-	-
C4-01	Torque Compensation Gain	0.00 to 2.50	0.01	1.00	1.00	1.00	-	-
C4-02	Torque Compensation Delay Time	0 to 10000	1 ms	200 *2	200 *2	20	-	-
C5-01	ASR Proportional Gain 1	0.00 to 300.00	0.01	-	0.20	-	20.00	10.00

10.18 A1-02 [Motor 1 Control Mode] Dependent Parameters

No.	Name	Setting Range	Unit	Control Method (Value set in A1-02)				
				V/f (0)	CL-V/f (1)	OLV (2)	CLV (3)	AOLV (4)
C5-02	ASR Integral Time 1	0.000 to 10.000	0.001 s	-	0.200	-	0.500	0.500
C5-03	ASR Proportional Gain 2	0.00 to 300.00	0.01	-	0.02	-	20.00	10.00
C5-04	ASR Integral Time 2	0.000 to 10.000	0.001 s	-	0.050	-	0.500	0.500
C5-06	ASR Delay Time	0.000 to 0.500	0.001 s	-	-	-	0.004	0.004
C5-07	ASR Gain Switchover Frequency	0.0 to 400.0	0.1 Hz	0.0	0.0	0.0	0.0	0.0
C6-02	Carrier Frequency Selection	1 - F	1	1 *3	1 *3	1 *3	1	1
d3-01	Jump Frequency 1	0.0 to 400.0	0.1 Hz	0.0	0.0	0.0	0.0	0.0
d3-02	Jump Frequency 2	0.0 to 400.0	0.1 Hz	0.0	0.0	0.0	0.0	0.0
d3-03	Jump Frequency 3	0.0 to 400.0	0.1 Hz	0.0	0.0	0.0	0.0	0.0
d3-04	Jump Frequency Width	0.0 to 20.0	0.1 Hz	1.0	1.0	1.0	1.0	1.0
d5-02	Torque Reference Delay Time	0 to 1000	1 ms	-	-	-	0	0
E1-04	Maximum Output Frequency	40.0 to 400.0 *3	0.1 Hz	60.0 *4	60.0 *4	60.0	60.0	60.0
E1-05	Maximum Output Voltage	0.0 to 255.0 *5	0.1 V	200.0 *4	200.0 *4	200.0	200.0	200.0
E1-06	Base Frequency	0.0 to 400.0	0.1 Hz	60.0 *4	60.0 *4	60.0	60.0	60.0
E1-07	Mid Point A Frequency	0.0 to 400.0	0.1 Hz	3.0 *4	3.0 *4	3.0	0.0	3.0
E1-08	Mid Point A Voltage	0.0 to 255.0 *5	0.1 V	15.0 *4	15.0 *4	11.0	0.0	10.0
E1-09	Minimum Output Frequency	0.0 to 400.0	0.1 Hz	1.5 *4	1.5 *4	0.5	0.0	0.6
E1-10	Minimum Output Voltage	0.0 to 255.0 *5	0.1 V	9.0 *4	9.0 *4	2.0	0.0	2.0
F1-01	Encoder 1 Pulse Count (PPR)	0 to 60000	1 ppr	600	600	600	600	600
F1-05	Encoder 1 Rotation Selection	0 to 1	1	0	0	0	0	0
F1-09	Overspeed Detection Delay Time	0.0 to 2.0	0.1 s	-	1.0	-	0.0	0.1
H4-20	Output power monitor level	0.00 to 650.00	0.01	Initial value of E2-11	Initial value of E2-11	Determined by E2-11	Determined by E2-11	Determined by E2-11

No.	Name	Setting Range	Unit	Control Method (Value set in A1-02)				
				V/f (0)	CL-V/f (1)	OLV (2)	CLV (3)	AOLV (4)
L1-01	Motor Overload Protection Select	0 to 4	1	1	1	1	1	1
L3-20	DC Bus Voltage Alignment Gain	0.00 to 5.00	0.01	1.00	1.00	0.30	0.30	0.30
L3-21	Deceleration Rate Calculation Gain	0.10 to 10.00	0.01	1.00	1.00	1.00	1.00	1.00
L3-36	VibraSuppressionGain duringAccel	0.0 to 100.0	0.1	10.0	10.0	20.0	-	-
L4-01	Speed Agree Detection Level	0.0 to 400.0	0.1	0.0 Hz	0.0 Hz	0.0 Hz	0.0 Hz	0.0 Hz
L4-02	Speed Agree Detection Width	0.0 to 20.0	0.1	2.0 Hz	2.0 Hz	2.0 Hz	2.0 Hz	2.0 Hz
L4-03	Speed Agree Detection Level (Positive / Negative)	-400.0 to 400.0	0.1	0.0 Hz	0.0 Hz	0.0 Hz	0.0 Hz	0.0 Hz
L4-04	Speed Agree Detection Width (Positive / Negative Side Detection)	0.0 to 20.0	0.1	2.0 Hz	2.0 Hz	2.0 Hz	2.0 Hz	2.0 Hz
L8-38	Carrier Frequency Reduction	0 to 2	1	*3	*3	*3	*3	*3
L8-40	Carrier Frequency Reduction Off Delay Time	0.00 to 2.00	0.01 s	0.50	0.50	0.50	0.50	0.50
o1-03	Keypad Display Selection	0 to 3	1	0	0	0	0	0
o1-04	Setting Units for Constants Related to V/f Pattern Frequency	0 to 1	1	-	-	-	0	0

*1 The following default settings are used depending on the control mode for drive models 2211 to 2415 and 4103 to 4675.

- Closed Loop Vector Control Method: 0.05
- Open Loop Vector Control Method: 2.00

*2 The default setting is 1000 ms for drive models 2110 to 2415 and 4103 to 4675.

*3 The default setting varies depending on the setting of C6-01 [Normal / Heavy Duty Selection].

*4 The default setting varies depending on drive model and the setting of E1-03 [V/f Pattern Selection].

*5 This is the value for 200 V class drives. Double the value for 400 V class drives.

◆ A1-02 = 5 to 8 [PM Open Loop Vector Control/EZ Open Loop Vector Control]

No.	Name	Setting Range	Unit	Control Method (Value set in A1-02)			
				OLV/PM (5)	AOLV/PM (6)	CLV/PM (7)	EZOLV (8)
b2-01	DC Injection/Zero SpeedThreshold	0.0 to 10.0	0.1	0.5 Hz	1.0%	0.5%	1.0%
b2-04	DC Inject Braking Time at Stop	0.00 to 10.00	0.01 s	0.00	0.00	0.00	0.00
b3-01	Speed Search Selection	0 to 1	1	0	0	1	0
b3-14	Bi-Direction Speed Search Select	0 to 1	1	1	1	1	1
b5-15	Sleep Function Operation Level	0.0 to 400.0 *I	0.1	0.0 Hz	0.0 %	0.0 %	0.0 %
b6-01	Dwell Reference at Start	0.0 to 400.0 *I	0.1	0.0 Hz	0.0 %	0.0 %	0.0 %
b6-03	Dwell Reference at Stop	0.0 to 400.0 *I	0.1	0.0 Hz	0.0 %	0.0 %	0.0 %
b8-02	Energy Saving Gain	0.0 to 10.0	0.1	-	-	-	-
b8-03	Energy Saving Filter Time	0.00 to 10.00	0.01 s	-	-	-	-
C1-11	Accel/Decel Time Switchover Freq	0.0 to 400.0 *I	0.1	0.0 Hz	0.0 %	0.0 %	0.0 %
C2-01	S-Curve Time @ start of Accel	0.00 to 10.00	0.01 s	1.00	0.20	0.20	1.00
C3-01	Slip Compensation Gain	0.0 to 2.5	0.1	-	-	-	Determined by E9-01
C3-02	Slip Compensation Delay Time	0 to 10000	1 ms	-	-	-	200
C4-01	Torque Compensation Gain	0.00 to 2.50	0.01	0.00	-	-	0.00
C4-02	Torque Compensation Delay Time	0 to 10000	1 ms	100	-	-	100
C5-01	ASR Proportional Gain 1	0.00 to 300.00	0.01	10.00	10.00	20.00	10.00
C5-02	ASR Integral Time 1	0.000 to 10.000	0.001 s	0.500	0.500	0.500	0.500
C5-03	ASR Proportional Gain 2	0.00 to 300.00	0.01	-	10.00	20.00	10.00
C5-04	ASR Integral Time 2	0.000 to 10.000	0.001 s	-	0.500	0.500	0.500
C5-06	ASR Delay Time	0.000 to 0.500	0.001 s	-	0.016	0.004	0.004
C5-07	ASR Gain Switchover Frequency	0.0 to 400.0 *I	0.1	0.0 Hz	0.0 %	0.0 %	0.0 %
C6-02	Carrier Frequency Selection	1 - F	1	2	2	2	2
d3-01	Jump Frequency 1	0.0 to 400.0 *I	0.1	0.0 Hz	0.0 %	0.0 %	0.0 %
d3-02	Jump Frequency 2	0.0 to 400.0 *I	0.1	0.0 Hz	0.0 %	0.0 %	0.0 %
d3-03	Jump Frequency 3	0.0 to 400.0 *I	0.1	0.0 Hz	0.0 %	0.0 %	0.0 %

No.	Name	Setting Range	Unit	Control Method (Value set in A1-02)			
				OLV/PM (5)	AOLV/PM (6)	CLV/PM (7)	EZOLV (8)
d3-04	Jump Frequency Width	0.0 to 20.0 *2	0.1	1.0 Hz	1.0 %	1.0 %	1.0 %
d5-02	Torque Reference Delay Time	0 to 1000	1 ms	-	-	0	-
E1-04	Maximum Output Frequency	40.0 to 400.0 *3	0.1 Hz	Determined by E5-01	Determined by E5-01	Determined by E5-01	-
E1-05	Maximum Output Voltage	0.0 to 255.0 *4	0.1 V	Determined by E5-01	Determined by E5-01	Determined by E5-01	-
E1-06	Base Frequency	0.0 to 400.0	0.1 Hz	Determined by E5-01	Determined by E5-01	Determined by E5-01	-
E1-07	Mid Point A Frequency	0.0 to 400.0	0.1 Hz	-	-	-	-
E1-08	Mid Point A Voltage	0.0 to 255.0 *4	0.1 V	-	-	-	-
E1-09	Minimum Output Frequency	0.0 to 400.0	0.1 Hz	Determined by E5-01	Determined by E5-01	0.0	-
E1-10	Minimum Output Voltage	0.0 to 255.0 *4	0.1 V	-	-	-	-
F1-01	Encoder 1 Pulse Count (PPR)	0 to 60000	1 ppr	1024	1024	1024	600
F1-05	Encoder 1 Rotation Selection	0 to 1	1	1	1	1	0
F1-09	Overspeed Detection Delay Time	0.0 to 2.0	0.1 s	-	-	0.0	-
H4-20	Output power monitor level	0.00 to 650.00	0.01	Determined by E5-01	Determined by E5-01	Determined by E5-01	Determined by E9-07
L1-01	Motor Overload Protection Select	0 to 4	1	4	4	5	Determined by E9-01
L3-20	DC Bus Voltage Alignment Gain	0.00 to 5.00	0.01	0.65	0.65	0.65	0.65
L3-21	Deceleration Rate Calculation Gain	0.10 to 10.00	0.01	1.00	1.00	1.00	1.00
L3-36	VibraSuppression Gain duringAccel	0.0 to 100.0	0.1	-	-	-	-
L4-01	Speed Agree Detection Level	0.0 to 400.0 *1	0.1	0.0 Hz	0.0 %	0.0 %	0.0 %
L4-02	Speed Agree Detection Width	0.0 to 20.0 *2	0.1	2.0 Hz	4.0%	4.0%	4.0%
L4-03	Speed Agree Detection Level (Positive / Negative)	-400.0 to 400.0 *5	0.1	0.0 Hz	0.0 %	0.0 %	0.0 %
L4-04	Speed Agree Detection Width (Positive / Negative Side Detection)	0.0 to 20.0 *2	0.1	2.0 Hz	4.0%	4.0%	4.0%
L8-38	Carrier Frequency Reduction	0 to 2	1	0	0	0	0
L8-40	Carrier Frequency Reduction Off Delay Time	0.00 to 2.00	0.01 s	0.00	0.00	0.00	0.00

10.18 A1-02 [Motor 1 Control Mode] Dependent Parameters

No.	Name	Setting Range	Unit	Control Method (Value set in A1-02)			
				OLV/PM (5)	AOLV/PM (6)	CLV/PM (7)	EZOLV (8)
o1-03	Keypad Display Selection	0 to 3	1	0	1	1	1
o1-04	Setting Units for Constants Related to V/f Pattern Frequency	0 to 1	1	-	1	1	-

*1 The setting range is 0.0 to 100.0 when $A1-02 = 6$ or 7 [Control Method Selection = AOLV/PM or CLV/PM].

*2 The setting range is 0.0 to 40.0 when $A1-02 = 6$ or 7 [Control Method Selection = AOLV/PM or CLV/PM].

*3 The default setting varies depending on the setting of C6-01 [Normal / Heavy Duty Selection].

*4 This is the value for 200 V class drives. Double the value for 400 V class drives.

*5 The setting range is -100.0 to 100.0 when $A1-02 = 6$ or 7 [Control Method Selection = AOLV/PM or CLV/PM].

10.19 E3-01 [Motor 2 Control Mode] Dependent Parameters

The parameters listed in the following table have a dependent relationship with *E3-01*. The values of the default settings change as the setting of *E3-01* is changed.

No.	Name	Setting Range	Unit	Motor 2 Control Method (setting value of E3-01)			
				V/f (0)	CL-V/f (1)	OLV (2)	CLV (3)
C3-21	Motor 2 Slip Compensation Gain	0.0 to 2.50	0.1	0.0	-	1.0	1.0
C3-22	Motor 2 Slip Comp DelayTime	0 to 10000	1 ms	2000	-	200	-
C5-21	Motor 2 ASR Proportional Gain 1 (P)	0.00 to 300.00	0.01	-	0.20	-	20.00
C5-22	Motor 2 ASR Integral Time 1 (I)	0.000 to 10.000	0.001 s	-	0.200	-	0.500
C5-23	Motor 2 ASR Proportional Gain 2 (P)	0.00 to 300.00	0.01	-	0.02	-	20.00
C5-24	Motor 2 ASR Integral Time 2 (I)	0.000 to 10.000	0.001 s	-	0.050	-	0.500
C5-26	Motor 2 ASR Delay Time	0.000 to 0.500	0.001 s	-	-	-	0.004
E3-04	Motor 2 Maximum Output Frequency	40.0 to 590.0	0.1 Hz	60.0	60.0	60.0	60.0
E3-05	Motor 2 Maximum Output Voltage	0.0 to 255.0 <i>*1</i>	0.1 V	200.0	200.0	200.0	200.0
E3-06	Motor 2 Base Frequency	0.0 to 590.0	0.1 Hz	60.0	60.0	60.0	60.0
E3-07	Motor 2 Mid Point A Frequency	0.0 to 590.0	0.1 Hz	3.0	3.0	3.0	0.0
E3-08	Motor 2 Mid Point A Voltage	0.0 to 255.0 <i>*1</i>	0.1 V	15.0	15.0	11.0	0.0
E3-09	Motor 2 Minimum Output Frequency	0.0 to 590.0	0.1 Hz	1.5	1.5	0.5	0.0
E3-10	Motor 2 Minimum Output Voltage	0.0 to 255.0 <i>*1</i>	0.1 V	9.0	9.0	2.0	0.0
E3-11	Motor 2 Mid Point B Frequency	0.0 to 590.0	Determined by o1-04	0.0	0.0	0.0	0.0
E3-12	Motor 2 Mid Point B Voltage	0.0 to 255.0 <i>*1</i>	0.1 V	0.0	0.0	0.0	0.0
E3-13	Motor 2 Base Voltage	0.0 to 255.0 <i>*1</i>	0.1 V	0.0	0.0	0.0	0.0

*1 This is the value for 200 V class drives. Double the value for 400 V class drives.

10.20 Parameters Changed by E1-03 [V/f Pattern Selection]

The default settings of the parameters listed in the following table vary depending on the setting of A1-02 [Control Method Selection] and E1-03 [V/f Pattern Selection].

Table 10.2 Parameters Changed by E1-03 (2004 to 2021 and 4002 to 4012)

No.	Unit	Setting Value																Control Method (Value set in A1-02)				
		0	1	2	3	4	5	6	7	8	9	A	B	C	D	E	F	OL V (2)	CLV (3)	OL V/ PM (5)	AO LV/ PM (6)	CL V/ PM (7)
E1-04	Hz	50.0	60.0	60.0	72.0	50.0	50.0	60.0	60.0	50.0	50.0	60.0	60.0	90.0	120.0	180.0	60.0 ^{*1}	60.0	60.0	*2	*2	*2
E1-05 ^{*3}	V	200.0	200.0	200.0	200.0	200.0	200.0	200.0	200.0	200.0	200.0	200.0	200.0	200.0	200.0	200.0	200.0 ^{*1}	200.0	200.0	*2	*2	*2
E1-06	Hz	50.0	60.0	50.0	60.0	50.0	50.0	60.0	60.0	50.0	50.0	60.0	60.0	60.0	60.0	60.0	60.0 ^{*1}	60.0	60.0	*2	*2	*2
E1-07	Hz	2.5	3.0	3.0	3.0	25.0	25.0	30.0	30.0	2.5	2.5	3.0	3.0	3.0	3.0	3.0	3.0 ^{*1}	3.0	0.0	-	-	-
E1-08 ^{*3}	V	15.0	15.0	15.0	15.0	35.0	50.0	35.0	50.0	19.0	24.0	19.0	24.0	15.0	15.0	15.0	15.0 ^{*1}	11.0	0.0	-	-	-
E1-09	Hz	1.3	1.5	1.5	1.5	1.3	1.3	1.5	1.5	1.3	1.3	1.5	1.5	1.5	1.5	1.5	1.5 ^{*1}	0.5	0.0	*2	*2	0.0
E1-10 ^{*3}	V	9.0	9.0	9.0	9.0	8.0	9.0	8.0	9.0	11.0	13.0	11.0	15.0	9.0	9.0	9.0	9.0 ^{*1}	2.0	0.0	-	-	-

- *1 These values are the default settings for E1-04 through E1-10 and E3-04 through E3-10 [V/f Pattern for Motor 2]. These settings are the same as those for the V/f pattern when E1-03 = 1 [Constant Trq_60Hz base_60Hz max].
- *2 The default setting varies depending on the setting of E5-01 [Motor Code Selection].
- *3 This is the value for 200 V class drives. Double the value for 400 V class drives.

Table 10.3 Parameters Changed by E1-03 (2030 to 2211 and 4018 to 4103)

No.	Unit	Setting Value																Control Method (Value set in A1-02)				
		0	1	2	3	4	5	6	7	8	9	A	B	C	D	E	F	OL V (2)	CLV (3)	OL V/ PM (5)	AO LV/ PM (6)	CL V/ PM (7)
E1-04	Hz	50.0	60.0	60.0	72.0	50.0	50.0	60.0	60.0	50.0	50.0	60.0	60.0	90.0	120.0	180.0	60.0 ^{*1}	60.0	60.0	*2	*2	*2
E1-05 ^{*3}	V	200.0	200.0	200.0	200.0	200.0	200.0	200.0	200.0	200.0	200.0	200.0	200.0	200.0	200.0	200.0	200.0 ^{*1}	200.0	200.0	*2	*2	*2
E1-06	Hz	50.0	60.0	50.0	60.0	50.0	50.0	60.0	60.0	50.0	50.0	60.0	60.0	60.0	60.0	60.0	60.0 ^{*1}	60.0	60.0	*2	*2	*2
E1-07	Hz	2.5	3.0	3.0	3.0	25.0	25.0	30.0	30.0	2.5	2.5	3.0	3.0	3.0	3.0	3.0	3.0 ^{*1}	3.0	0.0	-	-	-
E1-08 ^{*3}	V	14.0	14.0	14.0	14.0	35.0	50.0	35.0	50.0	18.0	23.0	18.0	23.0	14.0	14.0	14.0	14.0 ^{*1}	11.0	0.0	-	-	-
E1-09	Hz	1.3	1.5	1.5	1.5	1.3	1.3	1.5	1.5	1.3	1.3	1.5	1.5	1.5	1.5	1.5	1.5 ^{*1}	0.5	0.0	*2	*2	0.0
E1-10 ^{*3}	V	7.0	7.0	7.0	7.0	6.0	7.0	6.0	7.0	9.0	11.0	9.0	13.0	7.0	7.0	7.0	7.0 ^{*1}	2.0	0.0	-	-	-

- *1 These values are the default settings for E1-04 through E1-10 and E3-04 through E3-10 [V/f Pattern for Motor 2]. These settings are the same as those for the V/f pattern when E1-03 = 1 [Constant Trq_60Hz base_60Hz max].

- *2 The default setting varies depending on the setting of E5-01 [Motor Code Selection].
- *3 This is the value for 200 V class drives. Double the value for 400 V class drives.

Table 10.4 Parameters Changed by E1-03 (2257 to 2415 and 4140 to 4675)

No.	Unit	Setting Value																Control Method (Value set in A1-02)				
		0	1	2	3	4	5	6	7	8	9	A	B	C	D	E	F	OL V (2)	CLV (3)	OL V/PM (5)	AO LV/PM (6)	CL V/PM (7)
E1-04	Hz	50.0	60.0	60.0	72.0	50.0	50.0	60.0	60.0	50.0	50.0	60.0	60.0	90.0	120.0	180.0	60.0 *1	60.0	60.0	*2	*2	*2
E1-05 *3	V	200.0	200.0	200.0	200.0	200.0	200.0	200.0	200.0	200.0	200.0	200.0	200.0	200.0	200.0	200.0	200.0 *1	200.0	200.0	*2	*2	*2
E1-06	Hz	50.0	60.0	50.0	60.0	50.0	50.0	60.0	60.0	50.0	50.0	60.0	60.0	60.0	60.0	60.0	60.0 *1	60.0	60.0	*2	*2	*2
E1-07	Hz	2.5	3.0	3.0	3.0	25.0	25.0	30.0	30.0	2.5	2.5	3.0	3.0	3.0	3.0	3.0	3.0 *1	3.0	0.0	-	-	-
E1-08 *3	V	12.0	12.0	12.0	12.0	35.0	50.0	35.0	50.0	15.0	20.0	15.0	20.0	12.0	12.0	12.0	12.0 *1	11.0	0.0	-	-	-
E1-09	Hz	1.3	1.5	1.5	1.5	1.3	1.3	1.5	1.5	1.3	1.3	1.5	1.5	1.5	1.5	1.5	1.5 *1	0.5	0.0	*2	*2	0.0
E1-10 *3	V	6.0	6.0	6.0	6.0	5.0	6.0	5.0	6.0	7.0	9.0	7.0	11.0	6.0	6.0	6.0	6.0 *1	2.0	0.0	-	-	-

- *1 These values are the default settings for E1-04 through E1-10 and E3-04 through E3-10 [V/f Pattern for Motor 2]. These settings are the same as those for the V/f pattern when E1-03 = 1 [Constant Trq_60Hz base_60Hz max].
- *2 The default setting varies depending on the setting of E5-01 [Motor Code Selection].
- *3 This is the value for 200 V class drives. Double the value for 400 V class drives.

10.21 Defaults by Drive Model and Duty Rating ND/HD

The parameters listed in the following table have a dependent relationship with *o2-04* and *C6-01*. The values of the default settings change as the settings of *o2-04* and *C6-01* are changed.

◆ 200 V class

No. */	Name	Unit	Default setting							
			2004		2006		2008		2010	
-	Drive Model	-								
C6-01	Normal / Heavy Duty Selection	-	HD	ND	HD	ND	HD	ND	HD	ND
			0	1	0	1	0	1	0	1
o2-04	Drive Model Selection	Hex.	62		63		64		65	
E2-11 (E4-11)	Motor Rated Power (kW)	kW	0.4	0.75	0.75	1.1	1.1	1.5	1.5	2.2
b3-06	Speed Estimation Current Level 1	-	1	1	0.5	0.5	0.5	0.5	0.5	0.5
b3-08	Speed Search ACR Gain	-	0.5	0.5	0.5	0.5	0.5	0.5	0.5	0.5
b3-26	Direction Determining Level	-	1000	1000	1000	1000	1000	1000	1000	1000
b8-03	Energy Saving Filter Time	s	0.50	0.50	0.50	0.50	0.50	0.50	0.50	0.50
b8-04	Energy Saving Coefficient Value	-	288.2	223.7	223.7	196.6	196.6	169.4	169.4	156.8
C5-17 (C5-37)	Motor Inertia	kgm ²	0.0015	0.0028	0.0028	0.0068	0.0068	0.0068	0.0068	0.0088
C6-02	Carrier Frequency Selection	-	1	7	1	7	1	7	1	7
E2-01 (E4-01)	Motor Rated Current	A	1.9	3.3	3.3	4.9	4.9	6.2	6.2	8.5
E2-02 (E4-02)	Motor Rated Slip	Hz	2.9	2.5	2.5	2.6	2.6	2.6	2.6	2.9
E2-03 (E4-03)	Motor No-Load Current	A	1.2	1.8	1.8	2.3	2.3	2.8	2.8	3
E2-05 (E4-05)	Motor Line-to-Line Resistance	Ω	9.842	5.156	5.156	3.577	3.577	1.997	1.997	1.601
E2-06 (E4-06)	Motor Leakage Inductance	%	18.2	13.8	13.8	18.5	18.5	18.5	18.5	18.4
E2-10 (E4-10)	Motor Iron Loss	W	14	26	26	38	38	53	53	77
E5-01	PM Motor Code Selection	-	1202	1202	1203	1203	FFFF	FFFF	1205	1205

No. */	Name	Unit	Default setting							
			2004		2006		2008		2010	
-	Drive Model	-								
C6-01	Normal / Heavy Duty Selection	-	HD	ND	HD	ND	HD	ND	HD	ND
			0	1	0	1	0	1	0	1
o2-04	Drive Model Selection	Hex.	62		63		64		65	
E2-11 (E4-11)	Motor Rated Power (kW)	kW	0.4	0.75	0.75	1.1	1.1	1.5	1.5	2.2
L2-02	Momentary Power Loss Ride-Thru Time	s	0.1	0.1	0.2	0.2	0.3	0.3	0.3	0.3
L2-03	Momentary Power Loss Min BB Time	s	0.2	0.3	0.3	0.4	0.4	0.4	0.4	0.5
L2-04	Momentary Power Loss Recovery Ramp Time	s	0.3	0.3	0.3	0.3	0.3	0.3	0.3	0.3
L2-05	Undervoltage Detect Level (Uv1)	-	190	190	190	190	190	190	190	190
L3-24	Motor Acceleration Time for Inertia Calc	s	0.178	0.142	0.142	0.142	0.142	0.166	0.166	0.145
L8-02	Overheat Alarm Level	°C	115	115	115	115	115	115	115	115
L8-09	Output Ground Fault Detect Select	-	1	1	1	1	1	1	1	1
L8-35	Installation Method Selection	-	2	2	2	2	2	2	2	2
L8-38	Carrier Frequency Reduction	-	2	2	2	2	2	2	2	2
n1-03	Hunting Prevention Time Constant	ms	10	10	10	10	10	10	10	10
n5-02	Motor Acceleration Time	s	0.178	0.142	0.142	0.142	0.142	0.166	0.166	0.145

*1 Parameters within parentheses are motor 2 parameters.

10.21 Defaults by Drive Model and Duty Rating ND/HD

No. *1	Name	Unit	Default setting							
			2012		2018		2021		2030	
-	Drive Model	-	HD	ND	HD1	ND1	HD1	ND1	HD	ND
C6-01	Normal / Heavy Duty Selection	-	0	1	0	1	0	1	0	1
o2-04	Drive Model Selection	Hex.	66		67		68		6A	
E2-11 (E4-11)	Motor Rated Power (kW)	kW	2.2	3.0	3.0	3.7	3.7	5.5	5.5	7.5
b3-06	Speed Estimation Current Level 1	-	0.5	0.5	0.5	0.5	0.5	0.5	0.5	0.5
b3-08	Speed Search ACR Gain	-	0.5	0.5	0.5	0.5	0.5	0.5	0.5	0.5
b3-26	Direction Determining Level	-	1000	1000	1000	1000	1000	1000	1000	1000
b8-03	Energy Saving Filter Time	s	0.50	0.50	0.50	0.50	0.50	0.50	0.50	0.50
b8-04	Energy Saving Coefficient Value	-	156.8	136.4	136.4	122.9	122.9	94.75	94.75	72.69
C5-17 (C5-37)	Motor Inertia	kgm ²	0.0088	0.0158	0.0158	0.0158	0.0158	0.0255	0.026	0.037
C6-02	Carrier Frequency Selection	-	1	7	1	7	1	7	1	7
E2-01 (E4-01)	Motor Rated Current	A	8.5	11.4	11.4	14	14	19.6	19.6	26.6
E2-02 (E4-02)	Motor Rated Slip	Hz	2.9	2.7	2.7	2.73	2.73	1.5	1.5	1.3
E2-03 (E4-03)	Motor No-Load Current	A	3	3.7	3.7	4.5	4.5	5.1	5.1	8
E2-05 (E4-05)	Motor Line-to-Line Resistance	Ω	1.601	1.034	1.034	0.771	0.771	0.399	0.399	0.288
E2-06 (E4-06)	Motor Leakage Inductance	%	18.4	19	19	19.6	19.6	18.2	18.2	15.5
E2-10 (E4-10)	Motor Iron Loss	W	77	91	91	112	112	172	172	262
E5-01	PM Motor Code Selection	-	1206	1206	FFFF	FFFF	1208	1208	120A	120A
L2-02	Momentary Power Loss Ride-Thru Time	s	0.5	0.5	1	1	1	1	1	1
L2-03	Momentary Power Loss Min BB Time	s	0.5	0.5	0.5	0.6	0.6	0.7	0.7	0.8

No. */	Name	Unit	Default setting							
			2012		2018		2021		2030	
-	Drive Model	-	HD	ND	HD1	ND1	HD1	ND1	HD	ND
C6-01	Normal / Heavy Duty Selection	-	0	1	0	1	0	1	0	1
o2-04	Drive Model Selection	Hex.	66		67		68		6A	
E2-11 (E4-11)	Motor Rated Power (kW)	kW	2.2	3.0	3.0	3.7	3.7	5.5	5.5	7.5
L2-04	Moment PowLoss VolRecoveryRamp Time	s	0.3	0.3	0.3	0.3	0.3	0.3	0.3	0.3
L2-05	Undervoltage Detect Level (Uv1)	-	190	190	190	190	190	190	190	190
L3-24	Motor Accel Time for Inertia Cal	s	0.145	0.145	0.145	0.154	0.154	0.168	0.168	0.175
L8-02	Overheat Alarm Level	°C	124	124	110	110	110	110	120	120
L8-09	Output Ground Fault DetectSelect	-	1	1	1	1	1	1	1	1
L8-35	Installation Method Selection	-	2	2	2	2	2	2	2	2
L8-38	Carrier Frequency Reduction	-	2	2	2	2	2	2	2	2
n1-03	Hunting Prevention Time Constant	ms	10	10	10	10	10	10	10	10
n5-02	Motor Acceleration Time	s	0.145	0.145	0.145	0.154	0.154	0.168	0.168	0.175

*1 Parameters within parentheses are motor 2 parameters.

10.21 Defaults by Drive Model and Duty Rating ND/HD

No. *1	Name	Unit	Default setting							
			2042		2056		2070		2082	
-	Drive Model	-	HD	ND	HD	ND	HD	ND	HD	ND
C6-01	Normal / Heavy Duty Selection	-	0	1	0	1	0	1	0	1
o2-04	Drive Model Selection	Hex.	6B		6D		6E		6F	
E2-11 (E4-11)	Motor Rated Power (kW)	kW	7.5	11	11	15	15	18.5	18.5	22
b3-06	Speed Estimation Current Level 1	-	0.5	0.5	0.5	0.5	0.5	0.5	0.5	0.5
b3-08	Speed Search ACR Gain	-	0.5	0.5	0.5	0.5	0.5	0.5	0.5	0.5
b3-26	Direction Determining Level	1000	1000	1000	1000	1000	1000	1000	1000	1000
b8-03	Energy Saving Filter Time	s	0.50	0.50	0.50	0.50	0.50	0.50	0.50	0.50
b8-04	Energy Saving Coefficient Value	-	72.69	70.44	70.44	63.13	63.13	57.87	57.87	51.79
C5-17 (C5-37)	Motor Inertia	kgm ²	0.037	0.053	0.053	0.076	0.076	0.138	0.138	0.165
C6-02	Carrier Frequency Selection	-	1	7	1	7	1	7	1	7
E2-01 (E4-01)	Motor Rated Current	A	26.6	39.7	39.7	53	53	65.8	65.8	77.2
E2-02 (E4-02)	Motor Rated Slip	Hz	1.3	1.7	1.7	1.6	1.6	1.67	1.67	1.7
E2-03 (E4-03)	Motor No-Load Current	A	8	11.2	11.2	15.2	15.2	15.7	15.7	18.5
E2-05 (E4-05)	Motor Line-to-Line Resistance	Ω	0.288	0.23	0.23	0.138	0.138	0.101	0.101	0.079
E2-06 (E4-06)	Motor Leakage Inductance	%	15.5	19.5	19.5	17.2	17.2	15.7	20.1	19.5
E2-10 (E4-10)	Motor Iron Loss	W	262	245	245	272	272	505	505	538
E5-01	PM Motor Code Selection	-	120B	120B	120D	120D	120E	120E	120F	120F
L2-02	Momentary Power Loss Ride-Thru Time	s	1	1	2	2	2	2	2	2
L2-03	Momentary Power Loss Min BB Time	s	0.8	0.9	0.9	1	1	1	1	1

No. */	Name	Unit	Default setting							
			2042		2056		2070		2082	
-	Drive Model	-	HD	ND	HD	ND	HD	ND	HD	ND
C6-01	Normal / Heavy Duty Selection	-	0	1	0	1	0	1	0	1
o2-04	Drive Model Selection	Hex.	6B		6D		6E		6F	
E2-11 (E4-11)	Motor Rated Power (kW)	kW	7.5	11	11	15	15	18.5	18.5	22
L2-04	Moment PowLoss VolRecoveryRamp Time	s	0.3	0.3	0.3	0.6	0.6	0.6	0.6	0.6
L2-05	Undervoltage Detect Level (Uv1)	-	190	190	190	190	190	190	190	190
L3-24	Motor Accel Time for Inertia Cal	s	0.175	0.265	0.265	0.244	0.244	0.317	0.317	0.355
L8-02	Overheat Alarm Level	°C	125	125	120	120	120	120	125	125
L8-09	Output Ground Fault DetectSelect	-	1	1	1	1	1	1	1	1
L8-35	Installation Method Selection	-	2	2	2	2	2	2	2	2
L8-38	Carrier Frequency Reduction	-	2	2	2	2	2	2	2	2
n1-03	Hunting Prevention Time Constant	ms	10	10	10	10	10	10	10	10
n5-02	Motor Acceleration Time	s	0.175	0.265	0.265	0.244	0.244	0.317	0.317	0.355

*1 Parameters within parentheses are motor 2 parameters.

10.21 Defaults by Drive Model and Duty Rating ND/HD

No. */	Name	Unit	Default setting							
			2110		2138		2169		2211	
-	Drive Model	-	HD	ND	HD	ND	HD	ND	HD	ND
C6-01	Normal / Heavy Duty Selection	-	0	1	0	1	0	1	0	1
o2-04	Drive Model Selection	Hex.	70		72		73		74	
E2-11 (E4-11)	Motor Rated Power (kW)	kW	22	30	30	37	37	45	45	55
b3-06	Speed Estimation Current Level 1	-	0.5	0.5	0.5	0.5	0.5	0.5	0.5	0.5
b3-08	Speed Search ACR Gain	-	0.5	0.5	0.5	0.5	0.5	0.5	0.5	0.5
b3-26	Direction Determining Level	-	1000	1000	1000	1000	1000	1000	1000	1000
b8-03	Energy Saving Filter Time	s	0.50	0.50	0.50	0.50	0.50	0.50	0.50	2.00
b8-04	Energy Saving Coefficient Value	-	51.79	46.27	46.27	38.16	38.16	35.78	35.78	31.35
C5-17 (C5-37)	Motor Inertia	kgm ²	0.165	0.220	0.220	0.273	0.273	0.333	0.333	0.490
C6-02	Carrier Frequency Selection	-	1	7	1	7	1	7	1	7
E2-01 (E4-01)	Motor Rated Current	A	77.2	105	105	131	131	160	160	190
E2-02 (E4-02)	Motor Rated Slip	Hz	1.7	1.8	1.8	1.33	1.33	1.6	1.6	1.43
E2-03 (E4-03)	Motor No-Load Current	A	18.5	21.9	21.9	38.2	38.2	44	44	45.6
E2-05 (E4-05)	Motor Line-to-Line Resistance	Ω	0.079	0.064	0.064	0.039	0.039	0.03	0.03	0.022
E2-06 (E4-06)	Motor Leakage Inductance	%	19.5	20.8	20.8	18.8	18.8	20.2	20.2	20.5
E2-10 (E4-10)	Motor Iron Loss	W	538	699	699	823	823	852	852	960
E5-01	PM Motor Code Selection	-	1210	1210	1212	1212	1213	1213	1214	1214
L2-02	Momentary Power Loss Ride-Thru Time	s	2	2	2	2	2	2	2	2
L2-03	Momentary Power Loss Min BB Time	s	1	1.1	1.1	1.1	1.1	1.2	1.2	1.3

No. */	Name	Unit	Default setting							
			2110		2138		2169		2211	
-	Drive Model	-	HD	ND	HD	ND	HD	ND	HD	ND
C6-01	Normal / Heavy Duty Selection	-	0	1	0	1	0	1	0	1
o2-04	Drive Model Selection	Hex.	70		72		73		74	
E2-11 (E4-11)	Motor Rated Power (kW)	kW	22	30	30	37	37	45	45	55
L2-04	Moment PowLoss VolRecoveryRamp Time	s	0.6	0.6	0.6	0.6	0.6	1	1	1
L2-05	Undervoltage Detect Level (Uv1)	-	190	190	190	190	190	190	190	190
L3-24	Motor Accel Time for Inertia Cal	s	0.355	0.323	0.323	0.32	0.32	0.387	0.387	0.317
L8-02	Overheat Alarm Level	°C	130	130	130	130	130	130	125	125
L8-09	Output Ground Fault DetectSelect	-	1	1	1	1	1	1	1	1
L8-35	Installation Method Selection	-	0	0	0	0	0	0	0	0
L8-38	Carrier Frequency Reduction	-	2	2	2	2	2	2	2	2
n1-03	Hunting Prevention Time Constant	ms	10	10	10	10	10	10	10	10
n5-02	Motor Acceleration Time	s	0.355	0.323	0.323	0.32	0.32	0.387	0.387	0.317

*1 Parameters within parentheses are motor 2 parameters.

10.21 Defaults by Drive Model and Duty Rating ND/HD

No. *1	Name	Unit	Default setting							
			2257		2313		2360		2415	
-	Drive Model	-	HD	ND	HD	ND	HD	ND	HD	ND
C6-01	Normal / Heavy Duty Selection	-	0	1	0	1	0	1	0	1
o2-04	Drive Model Selection	Hex.	75		76		77		78	
E2-11 (E4-11)	Motor Rated Power (kW)	kW	55	75	75	90	90	110	110	110
b3-06	Speed Estimation Current Level 1	-	0.5	0.7	0.7	0.7	0.7	0.7	0.7	0.7
b3-08	Speed Search ACR Gain	-	0.5	0.5	0.5	0.5	0.5	0.5	0.5	0.5
b3-26	Direction Determining Level	-	1000	1000	1000	1000	1000	1000	1000	1000
b8-03	Energy Saving Filter Time	s	2.00	2.00	2.00	2.00	2.00	2.00	2.00	2.00
b8-04	Energy Saving Coefficient Value	-	31.35	23.1	23.1	20.65	20.65	18.12	18.12	18.12
C5-17 (C5-37)	Motor Inertia	kgm ²	0.49	0.90	0.90	1.10	1.10	1.90	1.90	1.90
C6-02	Carrier Frequency Selection	-	1	7	1	7	1	7	1	7
E2-01 (E4-01)	Motor Rated Current	A	190	260	260	260	260	260	260	260
E2-02 (E4-02)	Motor Rated Slip	Hz	1.43	1.39	1.39	1.39	1.39	1.39	1.39	1.39
E2-03 (E4-03)	Motor No-Load Current	A	45.6	72	72	72	72	72	72	72
E2-05 (E4-05)	Motor Line-to-Line Resistance	Ω	0.022	0.023	0.023	0.023	0.023	0.023	0.023	0.023
E2-06 (E4-06)	Motor Leakage Inductance	%	20.5	20	20	20	20	20	20	20
E2-10 (E4-10)	Motor Iron Loss	W	960	1200	1200	1200	1200	1200	1200	1200
E5-01	PM Motor Code Selection	-	1215	1215	1216	1216	FFFF	FFFF	FFFF	FFFF
L2-02	Momentary Power Loss Ride-Thru Time	s	2	2	2	2	2	2	2	2
L2-03	Momentary Power Loss Min BB Time	s	1.3	1.5	1.5	1.5	1.5	1.7	1.7	1.7

No. */	Name	Unit	Default setting							
			2257		2313		2360		2415	
-	Drive Model	-								
C6-01	Normal / Heavy Duty Selection	-	HD	ND	HD	ND	HD	ND	HD	ND
			0	1	0	1	0	1	0	1
o2-04	Drive Model Selection	Hex.	75		76		77		78	
E2-11 (E4-11)	Motor Rated Power (kW)	kW	55	75	75	90	90	110	110	110
L2-04	Moment PowLoss VolRecoveryRamp Time	s	1	1	1	1	1	1	1	1
L2-05	Undervoltage Detect Level (Uv1)	-	190	190	190	190	190	190	190	190
L3-24	Motor Accel Time for Inertia Cal	s	0.317	0.533	0.533	0.592	0.592	0.646	0.646	0.646
L8-02	Overheat Alarm Level	°C	115	115	120	120	120	120	120	120
L8-09	Output Ground Fault DetectSelect	-	1	1	1	1	1	1	1	1
L8-35	Installation Method Selection	-	0	0	0	0	0	0	0	0
L8-38	Carrier Frequency Reduction	-	2	2	2	2	2	2	2	2
n1-03	Hunting Prevention Time Constant	ms	10	10	10	10	100	100	100	100
n5-02	Motor Acceleration Time	s	0.317	0.533	0.533	0.592	0.592	0.646	0.646	0.646

*1 Parameters within parentheses are motor 2 parameters.

◆ 400 V class

No. */	Name	Unit	Default setting							
			4002		4004		4005		4007	
-	Drive Model	-	HD1	ND1	HD1	ND1	HD1	ND1	HD1	ND1
C6-01	Normal / Heavy Duty Selection	-	0	1	0	1	0	1	0	1
o2-04	Drive Model Selection	Hex.	92		93		94		95	
E2-11 (E4-11)	Motor Rated Power (kW)	kW	0.55	0.75	1.1	1.5	1.5	2.2	2.2	3.0
b3-06	Speed Estimation Current Level 1	-	0.5	0.5	0.5	0.5	0.5	0.5	0.5	0.5
b3-08	Speed Search ACR Gain	-	0.5	0.5	0.5	0.5	0.5	0.5	0.5	0.5
b3-26	Direction Determining Level	-	1000	1000	1000	1000	1000	1000	1000	1000
b8-03	Energy Saving Filter Time	s	0.50	0.50	0.50	0.50	0.50	0.50	0.50	0.50
b8-04	Energy Saving Coefficient Value	-	576.4	447.4	447.4	338.8	338.8	313.6	313.6	265.7
C5-17 (C5-37)	Motor Inertia	kgm ²	0.0015	0.0028	0.0028	0.0068	0.0068	0.0088	0.0088	0.0158
C6-02	Carrier Frequency Selection	-	1	7	1	7	1	7	1	7
E2-01 (E4-01)	Motor Rated Current	A	1	1.6	1.6	3.1	3.1	4.2	4.2	5.7
E2-02 (E4-02)	Motor Rated Slip	Hz	2.9	2.6	2.6	2.5	2.5	3	3	2.7
E2-03 (E4-03)	Motor No-Load Current	A	0.6	0.8	0.8	1.4	1.4	1.5	1.5	1.9
E2-05 (E4-05)	Motor Line-to-Line Resistance	Ω	38.198	22.459	22.459	10.1	10.1	6.495	6.495	4.360
E2-06 (E4-06)	Motor Leakage Inductance	%	18.2	14.3	14.3	18.3	18.3	18.7	18.7	19
E2-10 (E4-10)	Motor Iron Loss	W	14	26	26	53	53	77	77	105
E5-01	PM Motor Code Selection	-	1232	1232	1233	1233	1235	1235	1236	1236
L2-02	Momentary Power Loss Ride-Thru Time	s	0.1	0.1	0.2	0.2	0.3	0.3	0.5	0.5

No. */	Name	Unit	Default setting							
			4002		4004		4005		4007	
-	Drive Model	-	HD1	ND1	HD1	ND1	HD1	ND1	HD1	ND1
C6-01	Normal / Heavy Duty Selection	-	0	1	0	1	0	1	0	1
o2-04	Drive Model Selection	Hex.	92		93		94		95	
E2-11 (E4-11)	Motor Rated Power (kW)	kW	0.55	0.75	1.1	1.5	1.5	2.2	2.2	3.0
L2-03	Momentary Power Loss Min BB Time	s	0.2	0.3	0.3	0.4	0.4	0.5	0.5	0.5
L2-04	Momentary Power Loss Vol Recovery Ramp Time	s	0.3	0.3	0.3	0.3	0.3	0.3	0.3	0.3
L2-05	Undervoltage Detect Level (Uv1)	-	380	380	380	380	380	380	380	380
L3-24	Motor Accel Time for Inertia Cal	s	0.178	0.142	0.142	0.166	0.166	0.145	0.145	0.145
L8-02	Overheat Alarm Level	°C	110	110	110	110	112	112	110	110
L8-09	Output Ground Fault Detect Select	-	1	1	1	1	1	1	1	1
L8-35	Installation Method Selection	-	2	2	2	2	2	2	2	2
L8-38	Carrier Frequency Reduction	-	2	2	2	2	2	2	2	2
n1-03	Hunting Prevention Time Constant	ms	10	10	10	10	10	10	10	10
n5-02	Motor Acceleration Time	s	0.178	0.142	0.142	0.166	0.166	0.145	0.145	0.145

*1 Parameters within parentheses are for motor 2.

10.21 Defaults by Drive Model and Duty Rating ND/HD

No. */	Name	Unit	Default setting							
			4009		4012		4018		4023	
-	Drive Model	-	HD1	ND1	HD1	ND1	HD1	ND1	HD1	ND1
C6-01	Normal / Heavy Duty Selection	-	0	1	0	1	0	1	0	1
o2-04	Drive Model Selection	Hex.	96		97		99		9A	
E2-11 (E4-11)	Motor Rated Power (kW)	kW	3.0	4.0	4.0	5.5	5.5	7.5	7.5	11
b3-06	Speed Estimation Current Level 1	-	0.5	0.5	0.5	0.5	0.5	0.5	0.5	0.5
b3-08	Speed Search ACR Gain	-	0.5	0.5	0.5	0.5	0.5	0.5	0.5	0.5
b3-26	Direction Determining Level	-	1000	1000	1000	1000	1000	1000	1000	1000
b8-03	Energy Saving Filter Time	s	0.50	0.50	0.50	0.50	0.50	0.50	0.50	0.50
b8-04	Energy Saving Coefficient Value	-	265.7	245.8	245.8	189.5	189.5	145.38	145.38	140.88
C5-17 (C5-37)	Motor Inertia	kgm ²	0.0158	0.0158	0.0158	0.0255	0.026	0.037	0.037	0.053
C6-02	Carrier Frequency Selection	-	1	7	1	7	1	7	1	7
E2-01 (E4-01)	Motor Rated Current	A	5.7	7	7	9.8	9.8	13.3	13.3	19.9
E2-02 (E4-02)	Motor Rated Slip	Hz	2.7	2.7	2.7	1.5	1.5	1.3	1.3	1.7
E2-03 (E4-03)	Motor No-Load Current	A	1.9	2.3	2.3	2.6	2.6	4	4	5.6
E2-05 (E4-05)	Motor Line-to-Line Resistance	Ω	4.360	3.333	3.333	1.595	1.595	1.152	1.152	0.922
E2-06 (E4-06)	Motor Leakage Inductance	%	19	19.3	19.3	18.2	18.2	15.5	15.5	19.6
E2-10 (E4-10)	Motor Iron Loss	W	105	130	130	193	193	263	263	385
E5-01	PM Motor Code Selection	-	FFFF	FFFF	1238	1238	123A	123A	123B	123B
L2-02	Momentary Power Loss Ride-Thru Time	s	0.5	0.5	0.5	0.5	0.8	0.8	1	1
L2-03	Momentary Power Loss Min BB Time	s	0.5	0.6	0.6	0.7	0.7	0.8	0.8	0.9

No. */	Name	Unit	Default setting							
			4009		4012		4018		4023	
-	Drive Model	-								
C6-01	Normal / Heavy Duty Selection	-	HD1	ND1	HD1	ND1	HD1	ND1	HD1	ND1
			0	1	0	1	0	1	0	1
o2-04	Drive Model Selection	Hex.	96		97		99		9A	
E2-11 (E4-11)	Motor Rated Power (kW)	kW	3.0	4.0	4.0	5.5	5.5	7.5	7.5	11
L2-04	Moment PowLoss VolRecovery Ramp Time	s	0.3	0.3	0.3	0.3	0.3	0.3	0.3	0.3
L2-05	Undervoltage Detect Level (Uv1)	-	380	380	380	380	380	380	380	380
L3-24	Motor Accel Time for Inertia Cal	s	0.145	0.154	0.154	0.168	0.168	0.175	0.175	0.265
L8-02	Overheat Alarm Level	°C	110	110	110	110	110	110	115	115
L8-09	Output Ground Fault Detect Select	-	1	1	1	1	1	1	1	1
L8-35	Installation Method Selection	-	2	2	2	2	2	2	2	2
L8-38	Carrier Frequency Reduction	-	2	2	2	2	2	2	2	2
n1-03	Hunting Prevention Time Constant	ms	10	10	10	10	10	10	10	10
n5-02	Motor Acceleration Time	s	0.145	0.154	0.154	0.168	0.168	0.175	0.175	0.265

*1 Parameters within parentheses are for motor 2.

10.21 Defaults by Drive Model and Duty Rating ND/HD

No. *1	Name	Unit	Default setting							
			4031		4038		4044		4060	
-	Drive Model	-	HD1	ND1	HD1	ND1	HD1	ND1	HD1	ND1
C6-01	Normal / Heavy Duty Selection	-	0	1	0	1	0	1	0	1
o2-04	Drive Model Selection	Hex.	9C		9D		9E		9F	
E2-11 (E4-11)	Motor Rated Power (kW)	kW	11	15	15	18.5	18.5	22	22	30
b3-06	Speed Estimation Current Level 1	-	0.5	0.5	0.5	0.5	0.5	0.5	0.5	0.5
b3-08	Speed Search ACR Gain	-	0.5	0.5	0.5	0.5	0.5	0.5	0.5	0.5
b3-26	Direction Determining Level	-	1000	1000	1000	1000	1000	1000	1000	1000
b8-03	Energy Saving Filter Time	s	0.50	0.50	0.50	0.50	0.50	0.50	0.50	0.50
b8-04	Energy Saving Coefficient Value	-	140.88	126.26	126.26	115.74	115.74	103.58	103.58	92.54
C5-17 (C5-37)	Motor Inertia	kgm ²	0.053	0.076	0.076	0.138	0.138	0.165	0.165	0.220
C6-02	Carrier Frequency Selection	-	1	7	1	7	1	7	1	7
E2-01 (E4-01)	Motor Rated Current	A	19.9	26.5	26.5	32.9	32.9	38.6	38.6	52.3
E2-02 (E4-02)	Motor Rated Slip	Hz	1.7	1.6	1.6	1.67	1.67	1.7	1.7	1.8
E2-03 (E4-03)	Motor No-Load Current	A	5.6	7.6	7.6	7.8	7.8	9.2	9.2	10.9
E2-05 (E4-05)	Motor Line-to-Line Resistance	Ω	0.922	0.55	0.55	0.403	0.403	0.316	0.316	0.269
E2-06 (E4-06)	Motor Leakage Inductance	%	19.6	17.2	17.2	20.1	20.1	23.5	23.5	20.7
E2-10 (E4-10)	Motor Iron Loss	W	385	440	440	508	508	586	586	750
E5-01	PM Motor Code Selection	-	123D	123D	123E	123E	123F	123F	1240	1240
L2-02	Momentary Power Loss Ride-Thru Time	s	2	2	2	2	2	2	2	2
L2-03	Momentary Power Loss Min BB Time	s	0.9	1	1	1	1	1	1	1.1

No. */	Name	Unit	Default setting							
			4031		4038		4044		4060	
-	Drive Model	-	HD1	ND1	HD1	ND1	HD1	ND1	HD1	ND1
C6-01	Normal / Heavy Duty Selection	-	0	1	0	1	0	1	0	1
o2-04	Drive Model Selection	Hex.	9C		9D		9E		9F	
E2-11 (E4-11)	Motor Rated Power (kW)	kW	11	15	15	18.5	18.5	22	22	30
L2-04	Moment PowLoss VolRecoveryRamp Time	s	0.3	0.6	0.6	0.6	0.6	0.6	0.6	0.6
L2-05	Undervoltage Detect Level (Uv1)	-	380	380	380	380	380	380	380	380
L3-24	Motor Accel Time for Inertia Cal	s	0.265	0.244	0.244	0.317	0.317	0.355	0.355	0.323
L8-02	Overheat Alarm Level	°C	120	120	120	120	115	115	120	120
L8-09	Output Ground Fault DetectSelect	-	1	1	1	1	1	1	1	1
L8-35	Installation Method Selection	-	2	2	2	2	2	2	0	0
L8-38	Carrier Frequency Reduction	-	2	2	2	2	2	2	2	2
n1-03	Hunting Prevention Time Constant	ms	10	10	10	10	10	10	10	10
n5-02	Motor Acceleration Time	s	0.265	0.244	0.244	0.317	0.317	0.355	0.355	0.323

*1 Parameters within parentheses are for motor 2.

10.21 Defaults by Drive Model and Duty Rating ND/HD

No. */	Name	Unit	Default setting							
			4075		4089		4103		4140	
-	Drive Model	-	HD1	ND1	HD1	ND1	HD1	ND1	HD1	ND1
C6-01	Normal / Heavy Duty Selection	-	0	1	0	1	0	1	0	1
o2-04	Drive Model Selection	Hex.	A1		A2		A3		A4	
E2-11 (E4-11)	Motor Rated Power (kW)	kW	30	37	37	45	45	55	55	75
b3-06	Speed Estimation Current Level 1	-	0.5	0.5	0.5	0.5	0.5	0.5	0.5	0.7
b3-08	Speed Search ACR Gain	-	0.5	0.5	0.5	0.5	0.5	0.5	0.5	0.8
b3-26	Direction Determining Level	-	1000	1000	1000	1000	1000	1000	1000	1000
b8-03	Energy Saving Filter Time	s	0.50	0.50	0.50	0.50	0.50	2.00	2.00	2.00
b8-04	Energy Saving Coefficient Value	-	92.54	76.32	76.32	71.56	71.56	67.2	67.2	46.2
C5-17 (C5-37)	Motor Inertia	kgm ²	0.220	0.273	0.273	0.333	0.333	0.490	0.49	0.90
C6-02	Carrier Frequency Selection	-	1	7	1	7	1	7	1	7
E2-01 (E4-01)	Motor Rated Current	A	52.3	65.6	65.6	79.7	79.7	95	95	130
E2-02 (E4-02)	Motor Rated Slip	Hz	1.8	1.33	1.33	1.6	1.6	1.46	1.46	1.39
E2-03 (E4-03)	Motor No-Load Current	A	10.9	19.1	19.1	22	22	24	24	36
E2-05 (E4-05)	Motor Line-to-Line Resistance	Ω	0.269	0.155	0.155	0.122	0.122	0.088	0.088	0.092
E2-06 (E4-06)	Motor Leakage Inductance	%	20.7	18.8	18.8	19.9	19.9	20	20	20
E2-10 (E4-10)	Motor Iron Loss	W	750	925	925	1125	1125	1260	1260	1600
E5-01	PM Motor Code Selection	-	1242	1242	1243	1243	1244	1244	1245	1245
L2-02	Momentary Power Loss Ride-Thru Time	s	2	2	2	2	2	2	2	2
L2-03	Momentary Power Loss Min BB Time	s	1.1	1.1	1.1	1.2	1.2	1.2	1.2	1.3

No. */	Name	Unit	Default setting							
			4075		4089		4103		4140	
-	Drive Model	-								
C6-01	Normal / Heavy Duty Selection	-	HD1	ND1	HD1	ND1	HD1	ND1	HD1	ND1
			0	1	0	1	0	1	0	1
o2-04	Drive Model Selection	Hex.	A1		A2		A3		A4	
E2-11 (E4-11)	Motor Rated Power (kW)	kW	30	37	37	45	45	55	55	75
L2-04	Moment PowLoss VolRecovery Ramp Time	s	0.6	0.6	0.6	0.6	0.6	1	1	1
L2-05	Undervoltage Detect Level (Uv1)	-	380	380	380	380	380	380	380	380
L3-24	Motor Accel Time for Inertia Cal	s	0.323	0.32	0.32	0.387	0.387	0.317	0.317	0.533
L8-02	Overheat Alarm Level	°C	120	120	110	110	120	120	130	130
L8-09	Output Ground Fault Detect Select	-	1	1	1	1	1	1	1	1
L8-35	Installation Method Selection	-	0	0	0	0	0	0	0	0
L8-38	Carrier Frequency Reduction	-	2	2	2	2	2	2	2	2
n1-03	Hunting Prevention Time Constant	ms	10	10	10	10	10	10	30	30
n5-02	Motor Acceleration Time	s	0.323	0.32	0.32	0.387	0.387	0.317	0.317	0.533

*1 Parameters within parentheses are for motor 2.

10.21 Defaults by Drive Model and Duty Rating ND/HD

No. *1	Name	Unit	Default setting							
			4168		4208		4250		4296	
-	Drive Model	-	HD1	ND1	HD1	ND1	HD1	ND1	HD1	ND1
C6-01	Normal / Heavy Duty Selection	-	0	1	0	1	0	1	0	1
o2-04	Drive Model Selection	Hex.	A5		A6		A7		A8	
E2-11 (E4-11)	Motor Rated Power (kW)	kW	75	90	90	110	110	132	132	160
b3-06	Speed Estimation Current Level 1	-	0.7	0.7	0.7	0.7	0.7	0.7	0.7	0.7
b3-08	Speed Search ACR Gain	-	0.8	0.8	0.8	0.8	0.8	0.8	0.8	0.8
b3-26	Direction Determining Level	-	1000	1000	1000	1000	1000	1000	1000	1000
b8-03	Energy Saving Filter Time	s	2.00	2.00	2.00	2.00	2.00	2.00	2.00	2.00
b8-04	Energy Saving Coefficient Value	-	46.2	38.91	38.91	36.23	36.23	32.79	32.79	30.13
C5-17 (C5-37)	Motor Inertia	kgm ²	0.90	1.10	1.10	1.90	1.90	2.10	2.10	3.30
C6-02	Carrier Frequency Selection	-	1	7	1	7	1	7	1	7
E2-01 (E4-01)	Motor Rated Current	A	130	156	156	190	190	223	223	270
E2-02 (E4-02)	Motor Rated Slip	Hz	1.39	1.4	1.4	1.4	1.4	1.38	1.38	1.35
E2-03 (E4-03)	Motor No-Load Current	A	36	40	40	49	49	58	58	70
E2-05 (E4-05)	Motor Line-to-Line Resistance	Ω	0.092	0.056	0.056	0.046	0.046	0.035	0.035	0.029
E2-06 (E4-06)	Motor Leakage Inductance	%	20	20	20	20	20	20	20	20
E2-10 (E4-10)	Motor Iron Loss	W	1600	1760	1760	2150	2150	2350	2350	2850
E5-01	PM Motor Code Selection	-	1246	1246	1247	1247	1248	1248	1249	1249
L2-02	Momentary Power Loss Ride-Thru Time	s	2	2	2	2	2	2	2	2
L2-03	Momentary Power Loss Min BB Time	s	1.3	1.5	1.5	1.7	1.7	1.7	1.7	1.8

No. */	Name	Unit	Default setting							
			4168		4208		4250		4296	
-	Drive Model	-								
C6-01	Normal / Heavy Duty Selection	-	HD1	ND1	HD1	ND1	HD1	ND1	HD1	ND1
			0	1	0	1	0	1	0	1
o2-04	Drive Model Selection	Hex.	A5		A6		A7		A8	
E2-11 (E4-11)	Motor Rated Power (kW)	kW	75	90	90	110	110	132	132	160
L2-04	Moment PowLoss VolRecoveryRamp Time	s	1	1	1	1	1	1	1	1
L2-05	Undervoltage Detect Level (Uv1)	-	380	380	380	380	380	380	380	380
L3-24	Motor Accel Time for Inertia Cal	s	0.533	0.592	0.592	0.646	0.646	0.673	0.673	0.777
L8-02	Overheat Alarm Level	°C	130	130	120	120	120	120	125	125
L8-09	Output Ground Fault DetectSelect	-	1	1	1	1	1	1	1	1
L8-35	Installation Method Selection	-	0	0	0	0	0	0	0	0
L8-38	Carrier Frequency Reduction	-	2	2	2	2	2	2	2	2
n1-03	Hunting Prevention Time Constant	ms	30	30	30	30	30	30	30	30
n5-02	Motor Acceleration Time	s	0.533	0.592	0.592	0.646	0.646	0.673	0.673	0.777

*1 Parameters within parentheses are for motor 2.

10.21 Defaults by Drive Model and Duty Rating ND/HD

No. *1	Name	Unit	Default setting							
			4371		4389		4453		4568	
-	Drive Model	-	HD1	ND1	HD1	ND1	HD1	ND1	HD1	ND1
C6-01	Normal / Heavy Duty Selection	-	0	1	0	1	0	1	0	1
o2-04	Drive Model Selection	Hex.	A9		AA		AC		AD	
E2-11 (E4-11)	Motor Rated Power (kW)	kW	160	200	200	220	220	250	250	315
b3-06	Speed Estimation Current Level 1	-	0.7	0.7	0.7	0.7	0.7	0.7	0.7	0.7
b3-08	Speed Search ACR Gain	-	0.8	0.8	0.8	0.8	0.8	0.8	0.8	0.8
b3-26	Direction Determining Level	-	1000	1000	1000	1000	1000	1000	1000	1000
b8-03	Energy Saving Filter Time	s	2.00	2.00	2.00	2.00	2.00	2.00	2.00	2.00
b8-04	Energy Saving Coefficient Value	-	30.13	30.57	30.57	27.13	27.13	21.76	21.76	21.76
C5-17 (C5-37)	Motor Inertia	kgm ²	3.30	3.60	3.60	4.10	4.10	6.50	6.50	11.00
C6-02	Carrier Frequency Selection	-	1	7	1	7	1	7	7	1
E2-01 (E4-01)	Motor Rated Current	A	270	310	310	370	370	500	500	500
E2-02 (E4-02)	Motor Rated Slip	Hz	1.35	1.3	1.3	1.3	1.3	1.25	1.25	1.25
E2-03 (E4-03)	Motor No-Load Current	A	70	81	81	96	96	130	130	130
E2-05 (E4-05)	Motor Line-to-Line Resistance	Ω	0.029	0.025	0.025	0.02	0.02	0.014	0.014	0.014
E2-06 (E4-06)	Motor Leakage Inductance	%	20	20	20	20	20	20	20	20
E2-10 (E4-10)	Motor Iron Loss	W	2850	3200	3200	3700	3700	4700	4700	4700
E5-01	PM Motor Code Selection	-	124A	124A	FFFF	FFFF	FFFF	FFFF	FFFF	FFFF
L2-02	Momentary Power Loss Ride-Thru Time	s	2	2	2	2	2	2	2	2
L2-03	Momentary Power Loss Min BB Time	s	1.8	1.9	1.9	2	2	2.1	2.1	2.1

No. */	Name	Unit	Default setting							
-	Drive Model	-	4371		4389		4453		4568	
C6-01	Normal / Heavy Duty Selection	-	HD1	ND1	HD1	ND1	HD1	ND1	HD1	ND1
			0	1	0	1	0	1	0	1
o2-04	Drive Model Selection	Hex.	A9		AA		AC		AD	
E2-11 (E4-11)	Motor Rated Power (kW)	kW	160	200	200	220	220	250	250	315
L2-04	Moment PowLoss VolRecoveryRamp Time	s	1	1	1.8	1.8	1.8	2	2	2
L2-05	Undervoltage Detect Level (Uv1)	-	380	380	380	380	380	380	380	380
L3-24	Motor Accel Time for Inertia Cal	s	0.777	0.864	0.864	0.91	0.91	1.392	1.392	1.392
L8-02	Overheat Alarm Level	°C	130	130	140	140	140	140	140	140
L8-09	Output Ground Fault DetectSelect	-	1	1	1	1	1	1	1	1
L8-35	Installation Method Selection	-	0	0	0	0	0	0	0	0
L8-38	Carrier Frequency Reduction	-	2	2	2	2	2	2	2	2
n1-03	Hunting Prevention Time Constant	ms	30	30	100	100	100	100	100	100
n5-02	Motor Acceleration Time	s	0.777	0.864	0.864	0.91	0.91	1.392	1.392	1.392

*1 Parameters within parentheses are for motor 2.

No. */	Name	Unit	Default setting	
-	Drive Model	-	4675	
C6-01	Normal / Heavy Duty Selection	-	HD1	ND1
			0	1
o2-04	Drive Model Selection	Hex.	AE	
E2-11 (E4-11)	Motor Rated Power (kW)	kW	315	355
b3-06	Speed Estimation Current Level 1	-	0.7	0.7
b3-08	Speed Search ACR Gain	-	0.8	0.8
b3-26	Direction Determining Level	-	1000	1000

Parameter List

10.21 Defaults by Drive Model and Duty Rating ND/HD

No. *	Name	Unit	Default setting	
-	Drive Model	-	4675	
C6-01	Normal / Heavy Duty Selection	-	HD1	ND1
			0	1
o2-04	Drive Model Selection	Hex.	AE	
E2-11 (E4-11)	Motor Rated Power (kW)	kW	315	355
b8-03	Energy Saving Filter Time	s	2.00	2.00
b8-04	Energy Saving Coefficient Value	-	21.76	23.84
C5-17 (C5-37)	Motor Inertia	kgm ²	11.00	12.00
C6-02	Carrier Frequency Selection	-	1	7
E2-01 (E4-01)	Motor Rated Current	A	500	650
E2-02 (E4-02)	Motor Rated Slip	Hz	1.25	1
E2-03 (E4-03)	Motor No-Load Current	A	130	130
E2-05 (E4-05)	Motor Line-to-Line Resistance	Ω	0.014	0.012
E2-06 (E4-06)	Motor Leakage Inductance	%	20	20
E2-10 (E4-10)	Motor Iron Loss	W	4700	5560
E5-01	PM Motor Code Selection	-	FFFF	FFFF
L2-02	MomentaryPowerLossRide-Thru Time	s	2	2
L2-03	Momentary Power Loss Min BB Time	s	2.1	2.3
L2-04	MomentPowLossVolRecoveryRampTime	s	2	2.2
L2-05	Undervoltage Detect Level (Uv1)	-	380	380
L3-24	Motor Accel Time for Inertia Cal	s	1.392	1.667
L8-02	Overheat Alarm Level	°C	140	140
L8-09	Output Ground Fault DetectSelect	-	1	1
L8-35	Installation Method Selection	-	0	0
L8-38	Carrier Frequency Reduction	-	2	2
n1-03	Hunting Prevention Time Constant	ms	100	100
n5-02	Motor Acceleration Time	s	1.392	1.667

*1 Parameters within parentheses are for motor 2.

10.22 Parameters Changed by PM Motor Code Selection

Note:

Only the motor codes listed here are valid setting values.

◆ Yaskawa SMRA Series SPM Motors

Table 10.5 SMRA series motor code setting for specification of 200 V at 1800 min⁻¹ (r/min)

No.	Name	Unit	Motor Code (setting value of E5-01)				
E5-01	PM Motor Code Selection	-	0002	0003	0005	0006	0008
	Voltage Class	V	200	200	200	200	200
	Capacity	kW	0.4	0.75	1.5	2.2	3.7
	Motor Rotation Speed	min ⁻¹	1800	1800	1800	1800	1800
E5-02	PM Motor Rated Power (kW)	kW	0.4	0.75	1.5	2.2	3.7
E5-03	PM Motor Rated Current (FLA)	A	2.1	4.0	6.9	10.8	17.4
E5-04	PM Motor Pole Count	-	8	8	8	8	8
E5-05	PM Motor Resistance (ohms/phase)	Ω	2.47	1.02	0.679	0.291	0.169
E5-06	PM d-axis Inductance (mH/phase)	mH	12.7	4.8	3.9	3.6	2.5
E5-07	PM q-axis Inductance (mH/phase)	mH	12.7	4.8	3.9	3.6	2.5
E5-09	PM Back-EMF Vpeak (mV/(rad/s))	mVs/rad	0	0	0	0	0
E5-24	PM Motor Induced Voltage Constant 2 (Ke)	mV/(r/min)	62.0	64.1	73.4	69.6	72.2
E1-04	Maximum Output Frequency	Hz	120	120	120	120	120
E1-05	Maximum Output Voltage	V	200.0	200.0	200.0	200.0	200.0
E1-06	Base Frequency	Hz	120	120	120	120	120
E1-09	Minimum Output Frequency	Hz	6	6	6	6	6
C5-17	Motor Inertia	kgm ²	0.0007	0.0014	0.0021	0.0032	0.0046
L3-24	Motor Accel Time for Inertia Cal	s	0.064	0.066	0.049	0.051	0.044
n5-02	Motor Acceleration Time	s	0.064	0.066	0.049	0.051	0.044
n8-49	d-Axis Cur for High Efficiency Cont	%	0	0	0	0	0

Table 10.6 SMRA series motor code setting for specification of 200 V at 3600 min⁻¹ (r/min)

No.	Name	Unit	Motor Code (setting value of E5-01)			
E5-01	PM Motor Code Selection	-	0103	0105	0106	0108
	Voltage Class	V	200	200	200	200
	Capacity	kW	0.75	1.5	2.2	3.7
	Motor Rotation Speed	min ⁻¹	3600	3600	3600	3600
E5-02	PM Motor Rated Power (kW)	kW	0.75	1.5	2.2	3.7

10.22 Parameters Changed by PM Motor Code Selection

No.	Name	Unit	Motor Code (setting value of E5-01)						
			1202	1203	1205	1206	1208	120A	120B
E5-03	PM Motor Rated Current (FLA)	A	4.1		8.0		10.5		16.5
E5-04	PM Motor Pole Count	-	8		8		8		8
E5-05	PM Motor Resistance (ohms/phase)	Ω	0.538		0.20		0.15		0.097
E5-06	PM d-axis Inductance (mH/phase)	mH	3.2		1.3		1.1		1.1
E5-07	PM q-axis Inductance (mH/phase)	mH	3.2		1.3		1.1		1.1
E5-09	PM Back-EMF Vpeak (mV/(rad/s))	mVs/rad	0		0		0		0
E5-24	PM Motor Induced Voltage Constant 2 (Ke)	mV/(r/min)	32.4		32.7		36.7		39.7
E1-04	Maximum Output Frequency	Hz	240		240		240		240
E1-05	Maximum Output Voltage	V	200.0		200.0		200.0		200.0
E1-06	Base Frequency	Hz	240		240		240		240
E1-09	Minimum Output Frequency	Hz	12		12		12		12
C5-17	Motor Inertia	kgm ²	0.0007		0.0014		0.0021		0.0032
L3-24	Motor Accel Time for Inertia Cal	s	0.137		0.132		0.132		0.122
n5-02	Motor Acceleration Time	s	0.137		0.132		0.132		0.122
n8-49	d-Axis Cur for High Efficiency Cont	%	0		0		0		0

◆ Yaskawa SSR1 Series IPM Motors (Derated Torque)

Table 10.7 SSR1 series motor code setting for specification of 200 V at 1750 min⁻¹ (r/min)

No.	Name	Unit	Motor Code (setting value of E5-01)							
			1202	1203	1205	1206	1208	120A	120B	120D
E5-01	PM Motor Code Selection	-	1202	1203	1205	1206	1208	120A	120B	120D
	Voltage Class	V	200	200	200	200	200	200	200	200
	Capacity	kW	0.4	0.75	1.5	2.2	3.7	5.5	7.5	11
	Motor Rotation Speed	min ⁻¹	1750	1750	1750	1750	1750	1750	1750	1750
E5-02	PM Motor Rated Power (kW)	kW	0.4	0.75	1.5	2.2	3.7	5.5	7.5	11.0
E5-03	PM Motor Rated Current (FLA)	A	1.77	3.13	5.73	8.44	13.96	20.63	28.13	41.4
E5-04	PM Motor Pole Count	-	6	6	6	6	6	6	6	6
E5-05	PM Motor Resistance (ohms/phase)	Ω	8.233	2.284	1.470	0.827	0.455	0.246	0.198	0.094
E5-06	PM d-axis Inductance (mH/phase)	mH	54.84	23.02	17.22	8.61	7.20	4.86	4.15	3.40
E5-07	PM q-axis Inductance (mH/phase)	mH	64.10	29.89	20.41	13.50	10.02	7.43	5.91	3.91

No.	Name	Unit	Motor Code (setting value of E5-01)							
E5-09	PM Back-EMF V _{peak} (mV/(rad/s))	mVs/rad	223.7	220.3	240.8	238.0	238.7	239.6	258.2	239.3
E5-24	PM Motor Induced Voltage Constant 2 (Ke)	mV/(r/min)	0.0	0.0	0.0	0.0	0.0	0.0	0.0	0.0
E1-04	Maximum Output Frequency	Hz	87.5	87.5	87.5	87.5	87.5	87.5	87.5	87.5
E1-05	Maximum Output Voltage	V	190.0	190.0	190.0	190.0	190.0	190.0	190.0	190.0
E1-06	Base Frequency	Hz	87.5	87.5	87.5	87.5	87.5	87.5	87.5	87.5
E1-09	Minimum Output Frequency	Hz	4.4	4.4	4.4	4.4	4.4	4.4	4.4	4.4
C5-17	Motor Inertia	kgm ²	0.0011	0.0017	0.0023	0.0043	0.0083	0.014	0.017	0.027
L3-24 *1	Motor Accel Time for Inertia Cal	s	0.092	0.076	0.051	0.066	0.075	0.083	0.077	0.084
n5-02	Motor Acceleration Time	s	0.092	0.076	0.051	0.066	0.075	0.083	0.077	0.084
n8-49	d-Axis Cur for High Efficiency Cont	%	-7.6	-11.5	-9.1	-19.0	-18.7	-23.4	-18.5	-10.9

*1 Default settings vary depending on the setting of o2-04 (Drive Model Selection).

Table 10.8 SSR1 series motor code setting for specification of 200 V at 1750 min⁻¹ (r/min)

No.	Name	Unit	Motor Code (setting value of E5-01)							
E5-01	PM Motor Code Selection	-	120E	120F	1210	1212	1213	1214	1215	1216
	Voltage Class	V	200	200	200	200	200	200	200	200
	Capacity	kW	15	18	22	30	37	45	55	75
	Motor Rotation Speed	min ⁻¹	1750	1750	1750	1750	1750	1750	1750	1750
E5-02	PM Motor Rated Power (kW)	kW	15.00	18.50	22.00	30.00	37.00	45.00	55.00	75.00
E5-03	PM Motor Rated Current (FLA)	A	55.4	68.2	80.6	105.2	131.3	153.1	185.4	257.3
E5-04	PM Motor Pole Count	-	6	6	6	6	6	6	6	6
E5-05	PM Motor Resistance (ohms/phase)	Ω	0.066	0.051	0.037	0.030	0.020	0.014	0.012	0.006
E5-06	PM d-axis Inductance (mH/phase)	mH	2.45	2.18	1.71	1.35	0.99	0.83	0.79	0.44
E5-07	PM q-axis Inductance (mH/phase)	mH	3.11	2.55	2.05	1.82	1.28	1.01	0.97	0.56
E5-09	PM Back-EMF V _{peak} (mV/(rad/s))	mVs/rad	248.1	253.6	250.0	280.9	264.2	280.4	311.9	268.0
E5-24	PM Motor Induced Voltage Constant 2 (Ke)	mV/(r/min)	0.0	0.0	0.0	0.0	0.0	0.0	0.0	0.0
E1-04	Maximum Output Frequency	Hz	87.5	87.5	87.5	87.5	87.5	87.5	87.5	87.5
E1-05	Maximum Output Voltage	V	190.0	190.0	190.0	190.0	190.0	190.0	190.0	190.0
E1-06	Base Frequency	Hz	87.5	87.5	87.5	87.5	87.5	87.5	87.5	87.5

10.22 Parameters Changed by PM Motor Code Selection

No.	Name	Unit	Motor Code (setting value of E5-01)							
E1-09	Minimum Output Frequency	Hz	4.4	4.4	4.4	4.4	4.4	4.4	4.4	4.4
C5-17	Motor Inertia	kgm ²	0.046	0.055	0.064	0.116	0.140	0.259	0.31	0.42
L3-24 */	Motor Accel Time for Inertia Cal	s	0.102	0.101	0.098	0.130	0.127	0.193	0.191	0.187
n5-02	Motor Acceleration Time	s	0.102	0.101	0.098	0.130	0.127	0.193	0.191	0.187
n8-49	d-Axis Cur forHighEfficiency Cont	%	-16.5	-11.3	-12.8	-16.8	-15.6	-10.7	-9.6	-13.3

*1 Default settings vary depending on the setting of o2-04 (Drive Model Selection).

Table 10.9 SSR1 series motor code setting for specification of 400 V at 1750 min⁻¹ (r/min)

No.	Name	Unit	Motor Code (setting value of E5-01)							
E5-01	PM Motor Code Selection	-	1232	1233	1235	1236	1238	123A	123B	123D
	Voltage Class	V	400	400	400	400	400	400	400	400
	Capacity	kW	0.4	0.75	1.5	2.2	3.7	5.5	7.5	11
	Motor Rotation Speed	min ⁻¹	1750	1750	1750	1750	1750	1750	1750	1750
E5-02	PM Motor Rated Power (kW)	kW	0.4	0.75	1.5	2.2	3.7	5.5	7.5	11.0
E5-03	PM Motor Rated Current (FLA)	A	0.89	1.56	2.81	4.27	7.08	10.31	13.65	20.7
E5-04	PM Motor Pole Count	-	6	6	6	6	6	6	6	6
E5-05	PM Motor Resistance (ohms/phase)	Ω	25.370	9.136	6.010	3.297	1.798	0.982	0.786	0.349
E5-06	PM d-axis Inductance (mH/phase)	mH	169.00	92.08	67.71	34.40	32.93	22.7	16.49	13.17
E5-07	PM q-axis Inductance (mH/phase)	mH	197.50	119.56	81.71	54.00	37.70	26.80	23.46	15.60
E5-09	PM Back-EMF V _{peak} (mV/(rad/s))	mVs/rad	392.6	440.6	478.3	466.3	478.8	478.1	520.0	481.5
E5-24	PM Motor Induced Voltage Constant 2 (Ke)	mV/(r/min)	0.0	0.0	0.0	0.0	0.0	0.0	0.0	0.0
E1-04	Maximum Output Frequency	Hz	87.5	87.5	87.5	87.5	87.5	87.5	87.5	87.5
E1-05	Maximum Output Voltage	V	380.0	380.0	380.0	380.0	380.0	380.0	380.0	380.0
E1-06	Base Frequency	Hz	87.5	87.5	87.5	87.5	87.5	87.5	87.5	87.5
E1-09	Minimum Output Frequency	Hz	4.4	4.4	4.4	4.4	4.4	4.4	4.4	4.4
C5-17	Motor Inertia	kgm ²	0.0011	0.0017	0.0023	0.0043	0.0083	0.014	0.017	0.027
L3-24 */	Motor Accel Time for Inertia Cal	s	0.092	0.076	0.051	0.066	0.075	0.083	0.077	0.084
n5-02	Motor Acceleration Time	s	0.092	0.076	0.051	0.066	0.075	0.083	0.077	0.084
n8-49	d-Axis Cur forHighEfficiency Cont	%	-8.6	-11.5	-10.3	-19.8	-8.5	-11.0	-18.6	-12.5

*1 Default settings vary depending on the setting of o2-04 (Drive Model Selection).

Table 10.10 SSR1 series motor code setting for specification of 400 V at 1750 min⁻¹ (r/min)

No.	Name	Unit	Motor Code (setting value of E5-01)							
E5-01	PM Motor Code Selection	-	123E	123F	1240	1242	1243	1244	1245	1246
	Voltage Class	V	400	400	400	400	400	400	400	400
	Capacity	kW	15	18	22	30	37	45	55	75
	Motor Rotation Speed	min ⁻¹	1750	1750	1750	1750	1750	1750	1750	1750
E5-02	PM Motor Rated Power (kW)	kW	15	18.50	22.00	30.00	37.00	45.00	55.00	75.00
E5-03	PM Motor Rated Current (FLA)	A	27.5	33.4	39.8	52.0	65.8	77.5	92.7	126.6
E5-04	PM Motor Pole Count	-	6	6	6	6	6	6	6	6
E5-05	PM Motor Resistance (ohms/phase)	Ω	0.272	0.207	0.148	0.235	0.079	0.054	0.049	0.029
E5-06	PM d-axis Inductance (mH/phase)	mH	10.30	8.72	6.81	5.4	4.08	3.36	3.16	2.12
E5-07	PM q-axis Inductance (mH/phase)	mH	12.77	11.22	8.47	7.26	5.12	3.94	3.88	2.61
E5-09	PM Back-EMF V _{peak} (mV/(rad/s))	mVs/rad	498.8	509.5	503.9	561.7	528.5	558.1	623.8	594.5
E5-24	PM Motor Induced Voltage Constant 2 (Ke)	mV/(r/min)	0.0	0.0	0.0	0.0	0.0	0.0	0.0	0.0
E1-04	Maximum Output Frequency	Hz	87.5	87.5	87.5	87.5	87.5	87.5	87.5	87.5
E1-05	Maximum Output Voltage	V	380.0	380.0	380.0	380.0	380.0	380.0	380.0	380.0
E1-06	Base Frequency	Hz	87.5	87.5	87.5	87.5	87.5	87.5	87.5	87.5
E1-09	Minimum Output Frequency	Hz	4.4	4.4	4.4	4.4	4.4	4.4	4.4	4.4
C5-17	Motor Inertia	kgm ²	0.046	0.055	0.064	0.116	0.140	0.259	0.31	0.42
L3-24 */	Motor Accel Time for Inertia Cal	s	0.102	0.101	0.098	0.130	0.127	0.193	0.191	0.187
n5-02	Motor Acceleration Time	s	0.102	0.101	0.098	0.130	0.127	0.193	0.191	0.187
n8-49	d-Axis Cur for High Efficiency Cont	%	-15.5	-17.9	-15.1	-16.8	-14.1	-8.8	-9.6	-10.3

*1 Default settings vary depending on the setting of o2-04 (Drive Model Selection).

Table 10.11 SSR1 series motor code setting for specification of 400 V at 1750 min⁻¹ (r/min)

No.	Name	Unit	Motor Code (setting value of E5-01)			
E5-01	PM Motor Code Selection	-	1247	1248	1249	124A
	Voltage Class	V	400	400	400	400
	Capacity	kW	90	110	132	160
	Motor Rotation Speed	min ⁻¹	1750	1750	1750	1750
E5-02	PM Motor Rated Power (kW)	kW	90.00	110.00	132.00	160.00
E5-03	PM Motor Rated Current (FLA)	A	160.4	183.3	222.9	267.7

10.22 Parameters Changed by PM Motor Code Selection

No.	Name	Unit	Motor Code (setting value of E5-01)			
E5-04	PM Motor Pole Count	-	6	6	6	6
E5-05	PM Motor Resistance (ohms/phase)	Ω	0.019	0.017	0.012	0.008
E5-06	PM d-axis Inductance (mH/phase)	mH	1.54	1.44	1.21	0.97
E5-07	PM q-axis Inductance (mH/phase)	mH	2.06	2.21	1.46	1.28
E5-09	PM Back-EMF Vpeak (mV/(rad/s))	mVs/rad	524.1	583.7	563.6	601.2
E5-24	PM Motor Induced Voltage Constant 2 (Ke)	mV/(r/min)	0.0	0.0	0.0	0.0
E1-04	Maximum Output Frequency	Hz	87.5	87.5	87.5	87.5
E1-05	Maximum Output Voltage	V	380.0	380.0	380.0	380.0
E1-06	Base Frequency	Hz	87.5	87.5	87.5	87.5
E1-09	Minimum Output Frequency	Hz	4.4	4.4	4.4	4.4
C5-17	Motor Inertia	kgm ²	0.56	0.83	0.96	1.61
L3-24 */	Motor Accel Time for Inertia Cal	s	0.208	0.254	0.243	0.338
n5-02	Motor Acceleration Time	s	0.208	0.254	0.243	0.338
n8-49	d-Axis Cur forHighEfficiencyCont	%	-17.0	-21.7	-10.9	-13.2

*1 Default settings vary depending on the setting of o2-04 (Drive Model Selection).

Table 10.12 SSR1 series motor code setting for specification of 200 V at 1450 min⁻¹ (r/min)

No.	Name	Unit	Motor Code (setting value of E5-01)							
E5-01	PM Motor Code Selection	-	1302	1303	1305	1306	1308	130A	130B	130D
	Voltage Class	V	200	200	200	200	200	200	200	200
	Capacity	kW	0.4	0.75	1.5	2.2	3.7	5.5	7.5	11
	Motor Rotation Speed	min ⁻¹	1450	1450	1450	1450	1450	1450	1450	1450
E5-02	PM Motor Rated Power (kW)	kW	0.4	0.75	1.5	2.2	3.7	5.5	7.5	11.0
E5-03	PM Motor Rated Current (FLA)	A	1.88	3.13	5.63	8.33	14.17	20.63	27.71	39.6
E5-04	PM Motor Pole Count	-	6	6	6	6	6	6	6	6
E5-05	PM Motor Resistance (ohms/phase)	Ω	3.190	1.940	1.206	0.665	0.341	0.252	0.184	0.099
E5-06	PM d-axis Inductance (mH/phase)	mH	32.15	26.12	14.72	12.27	8.27	6.49	6.91	4.07
E5-07	PM q-axis Inductance (mH/phase)	mH	41.74	34.30	20.15	14.77	9.81	7.74	7.66	4.65
E5-09	PM Back-EMF Vpeak (mV/(rad/s))	mVs/rad	264.3	269.6	284.3	287.1	284.5	298.0	335.0	303.9
E5-24	PM Motor Induced Voltage Constant 2 (Ke)	mV/(r/min)	0.0	0.0	0.0	0.0	0.0	0.0	0.0	0.0
E1-04	Maximum Output Frequency	Hz	72.5	72.5	72.5	72.5	72.5	72.5	72.5	72.5

No.	Name	Unit	Motor Code (setting value of E5-01)							
E1-05	Maximum Output Voltage	V	190.0	190.0	190.0	190.0	190.0	190.0	190.0	190.0
E1-06	Base Frequency	Hz	72.5	72.5	72.5	72.5	72.5	72.5	72.5	72.5
E1-09	Minimum Output Frequency	Hz	3.6	3.6	3.6	3.6	3.6	3.6	3.6	3.6
C5-17	Motor Inertia	kgm ²	0.0017	0.0023	0.0043	0.0083	0.0136	0.017	0.027	0.046
L3-24 */	Motor Accel Time for Inertia Cal	s	0.098	0.071	0.066	0.087	0.085	0.072	0.084	0.096
n5-02	Motor Acceleration Time	s	0.098	0.071	0.066	0.087	0.085	0.072	0.084	0.096
n8-49	d-Axis Cur for High Efficiency Cont	%	-6.6	-10.9	-13.5	-9.0	-9.5	-10.1	-6.0	-9.3

*1 Default settings vary depending on the setting of o2-04 (Drive Model Selection).

Table 10.13 SSR1 series motor code setting for specification of 200 V at 1450 min⁻¹ (r/min)

No.	Name	Unit	Motor Code (setting value of E5-01)							
E5-01	PM Motor Code Selection	-	130E	130F	1310	1312	1313	1314	1315	
	Voltage Class	V	200	200	200	200	200	200	200	
	Capacity	kW	15	18	22	30	37	45	55	
	Motor Rotation Speed	min ⁻¹	1450	1450	1450	1450	1450	1450	1450	
E5-02	PM Motor Rated Power (kW)	kW	15.00	18.50	22.00	30.00	37.00	45.00	55.00	
E5-03	PM Motor Rated Current (FLA)	A	55.5	65.6	75.1	105.2	126.0	153.1	186.5	
E5-04	PM Motor Pole Count	-	6	6	6	6	6	6	6	
E5-05	PM Motor Resistance (ohms/phase)	Ω	0.075	0.057	0.041	0.034	0.023	0.015	0.012	
E5-06	PM d-axis Inductance (mH/phase)	mH	3.29	2.53	1.98	1.75	1.48	1.04	0.87	
E5-07	PM q-axis Inductance (mH/phase)	mH	3.84	3.01	2.60	2.17	1.70	1.31	1.10	
E5-09	PM Back-EMF V _{peak} (mV/(rad/s))	mVs/rad	311.2	300.9	327.7	354.2	369.6	351.6	374.7	
E5-24	PM Motor Induced Voltage Constant 2 (K _e)	mV/(r/min)	0.0	0.0	0.0	0.0	0.0	0.0	0.0	
E1-04	Maximum Output Frequency	Hz	72.5	72.5	72.5	72.5	72.5	72.5	72.5	
E1-05	Maximum Output Voltage	V	190.0	190.0	190.0	190.0	190.0	190.0	190.0	
E1-06	Base Frequency	Hz	72.5	72.5	72.5	72.5	72.5	72.5	72.5	
E1-09	Minimum Output Frequency	Hz	3.6	3.6	3.6	3.6	3.6	3.6	3.6	
C5-17	Motor Inertia	kgm ²	0.055	0.064	0.116	0.140	0.259	0.312	0.42	
L3-24 */	Motor Accel Time for Inertia Cal	s	0.085	0.080	0.122	0.108	0.161	0.160	0.175	

10.22 Parameters Changed by PM Motor Code Selection

No.	Name	Unit	Motor Code (setting value of E5-01)						
n5-02	Motor Acceleration Time	s	0.085	0.080	0.122	0.108	0.161	0.160	0.175
n8-49	d-Axis Cur forHighEfficiency Cont	%	-10.7	-13.2	-15.7	-11.5	-7.0	-11.8	-10.2

*1 Default settings vary depending on the setting of o2-04 (Drive Model Selection).

Table 10.14 SSR1 series motor code setting for specification of 400 V at 1450 min⁻¹ (r/min)

No.	Name	Unit	Motor Code (setting value of E5-01)							
E5-01	PM Motor Code Selection	-	1332	1333	1335	1336	1338	133A	133B	133D
	Voltage Class	V	400	400	400	400	400	400	400	400
	Capacity	kW	0.4	0.75	1.5	2.2	3.7	5.5	7.5	11
	Motor Rotation Speed	min ⁻¹	1450	1450	1450	1450	1450	1450	1450	1450
E5-02	PM Motor Rated Power (kW)	kW	0.4	0.75	1.5	2.2	3.7	5.5	7.5	11.0
E5-03	PM Motor Rated Current (FLA)	A	0.94	1.56	2.81	4.27	6.98	10.21	13.85	19.5
E5-04	PM Motor Pole Count	-	6	6	6	6	6	6	6	6
E5-05	PM Motor Resistance (ohms/phase)	Ω	12.760	7.421	4.825	2.656	1.353	0.999	0.713	0.393
E5-06	PM d-axis Inductance (mH/phase)	mH	128.60	85.11	58.87	46.42	31.73	26.20	27.06	15.51
E5-07	PM q-axis Inductance (mH/phase)	mH	166.96	113.19	80.59	60.32	40.45	30.94	33.45	19.63
E5-09	PM Back-EMF V _{peak} (mV/(rad/s))	mVs/rad	528.6	544.2	568.5	572.8	562.9	587.6	670.1	612.7
E5-24	PM Motor Induced Voltage Constant 2 (Ke)	mV/(r/min)	0.0	0.0	0.0	0.0	0.0	0.0	0.0	0.0
E1-04	Maximum Output Frequency	Hz	72.5	72.5	72.5	72.5	72.5	72.5	72.5	72.5
E1-05	Maximum Output Voltage	V	380.0	380.0	380.0	380.0	380.0	380.0	380.0	380.0
E1-06	Base Frequency	Hz	72.5	72.5	72.5	72.5	72.5	72.5	72.5	72.5
E1-09	Minimum Output Frequency	Hz	3.6	3.6	3.6	3.6	3.6	3.6	3.6	3.6
C5-17	Motor Inertia	kgm ²	0.0017	0.0023	0.0043	0.0083	0.0136	0.017	0.027	0.046
L3-24 *1	Motor Accel Time for Inertia Cal	s	0.098	0.071	0.066	0.087	0.085	0.072	0.084	0.096
n5-02	Motor Acceleration Time	s	0.098	0.071	0.066	0.087	0.085	0.072	0.084	0.096
n8-49	d-Axis Cur forHighEfficiency Cont	%	-6.6	-9.2	-13.5	-12.1	-13.7	-10.1	-12.2	-15.5

*1 Default settings vary depending on the setting of o2-04 (Drive Model Selection).

Table 10.15 SSR1 series motor code setting for specification of 400 V at 1450 min⁻¹ (r/min)

No.	Name	Unit	Motor Code (setting value of E5-01)						
			133E	133F	1340	1342	1343	1344	1345
E5-01	PM Motor Code Selection	-	133E	133F	1340	1342	1343	1344	1345
	Voltage Class	V	400	400	400	400	400	400	400
	Capacity	kW	15	18	22	30	37	45	55
	Motor Rotation Speed	min ⁻¹	1450	1450	1450	1450	1450	1450	1450
E5-02	PM Motor Rated Power (kW)	kW	15	18.50	22.00	30.00	37.00	45.00	55.00
E5-03	PM Motor Rated Current (FLA)	A	27.4	32.9	37.6	52.5	63.2	76.4	96.1
E5-04	PM Motor Pole Count	-	6	6	6	6	6	6	6
E5-05	PM Motor Resistance (ohms/phase)	Ω	0.295	0.223	0.164	0.137	0.093	0.059	0.048
E5-06	PM d-axis Inductance (mH/phase)	mH	12.65	9.87	7.90	7.01	5.93	4.17	3.11
E5-07	PM q-axis Inductance (mH/phase)	mH	15.87	12.40	10.38	8.68	6.79	5.22	4.55
E5-09	PM Back-EMF V _{peak} (mV/(rad/s))	mVs/rad	624.6	610.4	655.4	708.4	739.2	703.0	747.1
E5-24	PM Motor Induced Voltage Constant 2 (K _e)	mV/(r/min)	0.0	0.0	0.0	0.0	0.0	0.0	0.0
E1-04	Maximum Output Frequency	Hz	72.5	72.5	72.5	72.5	72.5	72.5	72.5
E1-05	Maximum Output Voltage	V	380.0	380.0	380.0	380.0	380.0	380.0	380.0
E1-06	Base Frequency	Hz	72.5	72.5	72.5	72.5	72.5	72.5	72.5
E1-09	Minimum Output Frequency	Hz	3.6	3.6	3.6	3.6	3.6	3.6	3.6
C5-17	Motor Inertia	kgm ²	0.055	0.064	0.116	0.140	0.259	0.312	0.42
L3-24 */	Motor Accel Time for Inertia Cal	s	0.085	0.080	0.122	0.108	0.161	0.160	0.175
n5-02	Motor Acceleration Time	s	0.085	0.080	0.122	0.108	0.161	0.160	0.175
n8-49	d-Axis Cur for High Efficiency Cont	%	-15.1	-16.0	-15.7	-11.5	-6.8	-11.5	-14.8

*1 Default settings vary depending on the setting of o2-04 (Drive Model Selection).

Table 10.16 SSR1 series motor code setting for specification of 400 V at 1450 min⁻¹ (r/min)

No.	Name	Unit	Motor Code (setting value of E5-01)			
			1346	1347	1348	1349
E5-01	PM Motor Code Selection	-	1346	1347	1348	1349
	Voltage Class	V	400	400	400	400
	Capacity	kW	75	90	110	132
	Motor Rotation Speed	min ⁻¹	1450	1450	1450	1450
E5-02	PM Motor Rated Power (kW)	kW	75.00	90.00	110.00	132.00
E5-03	PM Motor Rated Current (FLA)	A	124.0	153.1	186.5	226.0
E5-04	PM Motor Pole Count	-	6	6	6	6

10.22 Parameters Changed by PM Motor Code Selection

No.	Name	Unit	Motor Code (setting value of E5-01)			
E5-05	PM Motor Resistance (ohms/phase)	Ω	0.028	0.024	0.015	0.011
E5-06	PM d-axis Inductance (mH/phase)	mH	2.32	2.20	1.45	1.23
E5-07	PM q-axis Inductance (mH/phase)	mH	2.97	3.23	1.88	1.67
E5-09	PM Back-EMF V _{peak} (mV/(rad/s))	mVs/rad	639.3	708.0	640.7	677.0
E5-24	PM Motor Induced Voltage Constant 2 (K _e)	mV/(r/min)	0.0	0.0	0.0	0.0
E1-04	Maximum Output Frequency	Hz	72.5	72.5	72.5	72.5
E1-05	Maximum Output Voltage	V	380.0	380.0	380.0	380.0
E1-06	Base Frequency	Hz	72.5	72.5	72.5	72.5
E1-09	Minimum Output Frequency	Hz	3.6	3.6	3.6	3.6
C5-17	Motor Inertia	kgm ²	0.56	0.83	0.96	1.61
L3-24 *1	Motor Accel Time for Inertia Cal	s	0.171	0.213	0.201	0.281
n5-02	Motor Acceleration Time	s	0.171	0.213	0.201	0.281
n8-49	d-Axis Cur forHighEfficiencyCont	%	-15.8	-19.6	-14.9	-15.1

*1 Default settings vary depending on the setting of o2-04 (Drive Model Selection).

Table 10.17 SSR1 series motor code setting for specification of 200 V at 1150 min⁻¹ (r/min)

No.	Name	Unit	Motor Code (setting value of E5-01)							
E5-01	PM Motor Code Selection	-	1402	1403	1405	1406	1408	140A	140B	140D
	Voltage Class	V	200	200	200	200	200	200	200	200
	Capacity	kW	0.4	0.75	1.5	2.2	3.7	5.5	7.5	11
	Motor Rotation Speed	min ⁻¹	1150	1150	1150	1150	1150	1150	1150	1150
E5-02	PM Motor Rated Power (kW)	kW	0.4	0.75	1.5	2.2	3.7	5.5	7.5	11.0
E5-03	PM Motor Rated Current (FLA)	A	1.88	3.02	6.00	8.85	14.27	20.21	26.67	39.9
E5-04	PM Motor Pole Count	-	6	6	6	6	6	6	6	6
E5-05	PM Motor Resistance (ohms/phase)	Ω	4.832	2.704	1.114	0.511	0.412	0.303	0.165	0.113
E5-06	PM d-axis Inductance (mH/phase)	mH	48.68	32.31	19.22	12.15	7.94	11.13	6.59	4.96
E5-07	PM q-axis Inductance (mH/phase)	mH	63.21	40.24	24.38	15.35	11.86	14.06	8.55	6.12
E5-09	PM Back-EMF V _{peak} (mV/(rad/s))	mVs/rad	320.4	327.1	364.4	344.4	357.5	430.8	391.5	384.4
E5-24	PM Motor Induced Voltage Constant 2 (K _e)	mV/(r/min)	0.0	0.0	0.0	0.0	0.0	0.0	0.0	0.0
E1-04	Maximum Output Frequency	Hz	57.5	57.5	57.5	57.5	57.5	57.5	57.5	57.5
E1-05	Maximum Output Voltage	V	190.0	190.0	190.0	190.0	190.0	190.0	190.0	190.0

No.	Name	Unit	Motor Code (setting value of E5-01)							
E1-06	Base Frequency	Hz	57.5	57.5	57.5	57.5	57.5	57.5	57.5	57.5
E1-09	Minimum Output Frequency	Hz	2.9	2.9	2.9	2.9	2.9	2.9	2.9	2.9
C5-17	Motor Inertia	kgm ²	0.0017	0.0023	0.0083	0.0136	0.0171	0.027	0.046	0.055
L3-24 *1	Motor Accel Time for Inertia Cal	s	0.062	0.044	0.080	0.090	0.067	0.072	0.088	0.073
n5-02	Motor Acceleration Time	s	0.062	0.044	0.080	0.090	0.067	0.072	0.088	0.073
n8-49	d-Axis Cur for High Efficiency Cont	%	-8.8	-9.9	-9.3	-10.0	-17.7	-12.3	-15.3	-13.9

*1 Default settings vary depending on the setting of o2-04 (Drive Model Selection).

Table 10.18 SSR1 series motor code setting for specification of 200 V at 1150 min⁻¹ (r/min)

No.	Name	Unit	Motor Code (setting value of E5-01)							
E5-01	PM Motor Code Selection	-	140E	140F	1410	1412	1413	1414		
	Voltage Class	V	200	200	200	200	200	200	200	
	Capacity	kW	15	18	22	30	37	45		
	Motor Rotation Speed	min ⁻¹	1150	1150	1150	1150	1150	1150	1150	
E5-02	PM Motor Rated Power (kW)	kW	15	18.50	22.00	30.00	37.00	45.00		
E5-03	PM Motor Rated Current (FLA)	A	55.6	63.5	74.4	104.2	129.6	154.2		
E5-04	PM Motor Pole Count	-	6	6	6	6	6	6	6	
E5-05	PM Motor Resistance (ohms/phase)	Ω	0.084	0.066	0.048	0.035	0.023	0.016		
E5-06	PM d-axis Inductance (mH/phase)	mH	3.83	3.33	2.38	2.04	1.53	1.16		
E5-07	PM q-axis Inductance (mH/phase)	mH	4.65	4.50	3.15	2.86	2.27	1.54		
E5-09	PM Back-EMF V _{peak} (mV/(rad/s))	mVs/rad	372.1	421.3	410.9	436.1	428.8	433.3		
E5-24	PM Motor Induced Voltage Constant 2 (Ke)	mV/(r/min)	0.0	0.0	0.0	0.0	0.0	0.0	0.0	
E1-04	Maximum Output Frequency	Hz	57.5	57.5	57.5	57.5	57.5	57.5	57.5	
E1-05	Maximum Output Voltage	V	190.0	190.0	190.0	190.0	190.0	190.0	190.0	
E1-06	Base Frequency	Hz	57.5	57.5	57.5	57.5	57.5	57.5	57.5	
E1-09	Minimum Output Frequency	Hz	2.9	2.9	2.9	2.9	2.9	2.9	2.9	
C5-17	Motor Inertia	kgm ²	0.064	0.116	0.140	0.259	0.312	0.418		
L3-24 *1	Motor Accel Time for Inertia Cal	s	0.062	0.091	0.092	0.125	0.122	0.135		
n5-02	Motor Acceleration Time	s	0.062	0.091	0.092	0.125	0.122	0.135		
n8-49	d-Axis Cur for High Efficiency Cont	%	-14.4	-17.9	-15.9	-17.9	-20.1	-13.7		

*1 Default settings vary depending on the setting of o2-04 (Drive Model Selection).

10.22 Parameters Changed by PM Motor Code Selection

Table 10.19 SSR1 series motor code setting for specification of 400 V at 1150 min⁻¹ (r/min)

No.	Name	Unit	Motor Code (setting value of E5-01)							
			1432	1433	1435	1436	1438	143A	143B	143D
E5-01	PM Motor Code Selection	-	1432	1433	1435	1436	1438	143A	143B	143D
	Voltage Class	V	400	400	400	400	400	400	400	400
	Capacity	kW	0.4	0.75	1.5	2.2	3.7	5.5	7.5	11
	Motor Rotation Speed	min ⁻¹	1150	1150	1150	1150	1150	1150	1150	1150
E5-02	PM Motor Rated Power (kW)	kW	0.4	0.75	1.5	2.2	3.7	5.5	7.5	11.0
E5-03	PM Motor Rated Current (FLA)	A	0.94	1.51	3.00	4.43	7.08	10.10	13.33	19.9
E5-04	PM Motor Pole Count	-	6	6	6	6	6	6	6	6
E5-05	PM Motor Resistance (ohms/phase)	Ω	19.320	10.800	4.456	2.044	1.483	1.215	0.660	0.443
E5-06	PM d-axis Inductance (mH/phase)	mH	194.70	129.20	76.88	48.60	37.58	44.54	26.36	19.10
E5-07	PM q-axis Inductance (mH/phase)	mH	252.84	160.90	97.52	61.40	47.65	56.26	34.20	24.67
E5-09	PM Back-EMF V _{peak} (mV/(rad/s))	mVs/rad	640.9	654.1	728.8	688.9	702.0	861.5	783.0	762.2
E5-24	PM Motor Induced Voltage Constant 2 (Ke)	mV/(r/min)	0.0	0.0	0.0	0.0	0.0	0.0	0.0	0.0
E1-04	Maximum Output Frequency	Hz	57.5	57.5	57.5	57.5	57.5	57.5	57.5	57.5
E1-05	Maximum Output Voltage	V	380.0	380.0	380.0	380.0	380.0	380.0	380.0	380.0
E1-06	Base Frequency	Hz	57.5	57.5	57.5	57.5	57.5	57.5	57.5	57.5
E1-09	Minimum Output Frequency	Hz	2.9	2.9	2.9	2.9	2.9	2.9	2.9	2.9
C5-17	Motor Inertia	kgm ²	0.0017	0.0023	0.0083	0.0136	0.0171	0.027	0.046	0.055
L3-24 *1	Motor Accel Time for Inertia Cal	s	0.062	0.044	0.080	0.090	0.067	0.072	0.088	0.073
n5-02	Motor Acceleration Time	s	0.062	0.044	0.080	0.090	0.067	0.072	0.088	0.073
n8-49	d-Axis Cur for High Efficiency Cont	%	-8.8	-9.9	-9.3	-10.0	-12.8	-12.3	-15.3	-16.7

*1 Default settings vary depending on the setting of o2-04 (Drive Model Selection).

Table 10.20 SSR1 series motor code setting for specification of 400 V at 1150 min⁻¹ (r/min)

No.	Name	Unit	Motor Code (setting value of E5-01)					
			143E	143F	1440	1442	1443	1444
E5-01	PM Motor Code Selection	-	143E	143F	1440	1442	1443	1444
	Voltage Class	V	400	400	400	400	400	400
	Capacity	kW	15	18	22	30	37	45
	Motor Rotation Speed	min ⁻¹	1150	1150	1150	1150	1150	1150
E5-02	PM Motor Rated Power (kW)	kW	15	18.50	22.00	30.00	37.00	45.00
E5-03	PM Motor Rated Current (FLA)	A	27.8	31.8	37.2	52.1	64.8	76.6

No.	Name	Unit	Motor Code (setting value of E5-01)					
			6	6	6	6	6	6
E5-04	PM Motor Pole Count	-	6	6	6	6	6	6
E5-05	PM Motor Resistance (ohms/phase)	Ω	0.331	0.264	0.192	0.140	0.093	0.063
E5-06	PM d-axis Inductance (mH/phase)	mH	15.09	13.32	9.52	8.16	6.13	4.63
E5-07	PM q-axis Inductance (mH/phase)	mH	18.56	18.00	12.60	11.40	9.10	6.15
E5-09	PM Back-EMF V _{peak} (mV/(rad/s))	mVs/rad	749.6	842.7	821.8	872.3	857.7	866.6
E5-24	PM Motor Induced Voltage Constant 2 (K _e)	mV/(r/min)	0.0	0.0	0.0	0.0	0.0	0.0
E1-04	Maximum Output Frequency	Hz	57.5	57.5	57.5	57.5	57.5	57.5
E1-05	Maximum Output Voltage	V	380.0	380.0	380.0	380.0	380.0	380.0
E1-06	Base Frequency	Hz	57.5	57.5	57.5	57.5	57.5	57.5
E1-09	Minimum Output Frequency	Hz	2.9	2.9	2.9	2.9	2.9	2.9
C5-17	Motor Inertia	kgm ²	0.064	0.116	0.140	0.259	0.312	0.418
L3-24 */	Motor Accel Time for Inertia Cal	s	0.062	0.091	0.092	0.125	0.122	0.135
n5-02	Motor Acceleration Time	s	0.062	0.091	0.092	0.125	0.122	0.135
n8-49	d-Axis Cur forHighEfficiencyCont	%	-14.9	-17.9	-15.9	-17.7	-20.1	-13.8

*1 Default settings vary depending on the setting of o2-04 (Drive Model Selection).

Table 10.21 SSR1 series motor code setting for specification of 400 V at 1150 min⁻¹ (r/min)

No.	Name	Unit	Motor Code (setting value of E5-01)			
			1445	1446	1447	1448
E5-01	PM Motor Code Selection	-	1445	1446	1447	1448
	Voltage Class	V	400	400	400	400
	Capacity	kW	55	75	90	110
	Motor Rotation Speed	min ⁻¹	1150	1150	1150	1150
E5-02	PM Motor Rated Power (kW)	kW	55.00	75.00	90.00	110.00
E5-03	PM Motor Rated Current (FLA)	A	92.0	127.1	150.5	185.4
E5-04	PM Motor Pole Count	-	6	6	6	6
E5-05	PM Motor Resistance (ohms/phase)	Ω	0.051	0.033	0.027	0.015
E5-06	PM d-axis Inductance (mH/phase)	mH	3.96	3.03	2.60	1.89
E5-07	PM q-axis Inductance (mH/phase)	mH	5.00	5.14	3.28	2.33
E5-09	PM Back-EMF V _{peak} (mV/(rad/s))	mVs/rad	854.0	823.1	853.4	829.2
E5-24	PM Motor Induced Voltage Constant 2 (K _e)	mV/(r/min)	0.0	0.0	0.0	0.0
E1-04	Maximum Output Frequency	Hz	57.5	57.5	57.5	57.5
E1-05	Maximum Output Voltage	V	380.0	380.0	380.0	380.0

10.22 Parameters Changed by PM Motor Code Selection

No.	Name	Unit	Motor Code (setting value of E5-01)			
E1-06	Base Frequency	Hz	57.5	57.5	57.5	57.5
E1-09	Minimum Output Frequency	Hz	2.9	2.9	2.9	2.9
C5-17	Motor Inertia	kgm ²	0.56	0.83	0.96	1.61
L3-24 *1	Motor Accel Time for Inertia Cal	s	0.147	0.161	0.154	0.212
n5-02	Motor Acceleration Time	s	0.147	0.161	0.154	0.212
n8-49	d-Axis Cur forHighEfficiencyCont	%	-12.5	-28.8	-13.3	-11.6

*1 Default settings vary depending on the setting of o2-04 [Drive Model Selection].

◆ Yaskawa SST4 Series IPM Motors (Constant Torque)

Table 10.22 SST4 series motor code setting for specification of 200 V at 1750 min⁻¹ (r/min)

No.	Name	Unit	Motor Code (setting value of E5-01)							
E5-01	PM Motor Code Selection	-	2202	2203	2205	2206	2208	220A	220B	220D
	Voltage Class	V	200	200	200	200	200	200	200	200
	Capacity	kW	0.4	0.75	1.5	2.2	3.7	5.5	7.5	11
	Motor Rotation Speed	min ⁻¹	1750	1750	1750	1750	1750	1750	1750	1750
E5-02	PM Motor Rated Power (kW)	kW	0.4	0.75	1.5	2.2	3.7	5.5	7.5	11.0
E5-03	PM Motor Rated Current (FLA)	A	1.77	3.54	6.56	8.96	14.79	20.94	29.58	41.1
E5-04	PM Motor Pole Count	-	6	6	6	6	6	6	6	6
E5-05	PM Motor Resistance (ohms/phase)	Ω	2.247	1.132	0.774	0.479	0.242	0.275	0.161	0.111
E5-06	PM d-axis Inductance (mH/phase)	mH	22.32	12.38	8.90	7.39	5.06	5.82	3.86	3.59
E5-07	PM q-axis Inductance (mH/phase)	mH	32.50	15.72	11.96	9.63	6.42	6.74	4.66	4.32
E5-09	PM Back-EMF V _{peak} (mV/(rad/s))	mVs/rad	215.2	203.9	219.3	230.6	235.1	251.7	235.7	252.0
E5-24	PM Motor Induced Voltage Constant 2 (Ke)	mV/(r/min)	0.0	0.0	0.0	0.0	0.0	0.0	0.0	0.0
E1-04	Maximum Output Frequency	Hz	87.5	87.5	87.5	87.5	87.5	87.5	87.5	87.5
E1-05	Maximum Output Voltage	V	190.0	190.0	190.0	190.0	190.0	190.0	190.0	190.0
E1-06	Base Frequency	Hz	87.5	87.5	87.5	87.5	87.5	87.5	87.5	87.5
E1-09	Minimum Output Frequency	Hz	4.4	4.4	4.4	4.4	4.4	4.4	4.4	4.4
C5-17	Motor Inertia	kgm ²	0.0016	0.0022	0.0042	0.0081	0.0133	0.013	0.017	0.027
L3-24 *1	Motor Accel Time for Inertia Cal	s	0.134	0.099	0.094	0.124	0.121	0.081	0.075	0.082

No.	Name	Unit	Motor Code (setting value of E5-01)							
n5-02	Motor Acceleration Time	s	0.134	0.099	0.094	0.124	0.121	0.081	0.075	0.082
n8-49	d-Axis Cur for High Efficiency Cont	%	-9.3	-6.4	-10.0	-9.9	-9.7	-8.4	-11.5	-13.1

*1 Default settings vary depending on the setting of o2-04 (Drive Model Selection).

Table 10.23 SST4 series motor code setting for specification of 200 V at 1750 min⁻¹ (r/min)

No.	Name	Unit	Motor Code (setting value of E5-01)							
E5-01	PM Motor Code Selection	-	220E	220F	2210	2212	2213	2214	2215	2216
	Voltage Class	V	200	200	200	200	200	200	200	200
	Capacity	kW	15	18	22	30	37	45	55	75
	Motor Rotation Speed	min ⁻¹	1750	1750	1750	1750	1750	1750	1750	1750
E5-02	PM Motor Rated Power (kW)	kW	15	18.50	22.00	30.00	37.00	45.00	55.00	75.00
E5-03	PM Motor Rated Current (FLA)	A	54.2	68.2	78.6	104.2	129.2	153.1	205.2	260.4
E5-04	PM Motor Pole Count	-	6	6	6	6	6	6	6	6
E5-05	PM Motor Resistance (ohms/phase)	Ω	0.071	0.049	0.040	0.030	0.020	0.013	0.009	0.006
E5-06	PM d-axis Inductance (mH/phase)	mH	2.67	1.98	1.69	1.31	0.88	0.77	0.55	0.40
E5-07	PM q-axis Inductance (mH/phase)	mH	3.10	2.41	2.12	1.61	1.14	1.04	0.69	0.50
E5-09	PM Back-EMF V _{peak} (mV/(rad/s))	mVs/rad	253.7	244.6	256.3	283.1	266.3	260.0	261.5	259.3
E5-24	PM Motor Induced Voltage Constant 2 (Ke)	mV/(r/min)	0.0	0.0	0.0	0.0	0.0	0.0	0.0	0.0
E1-04	Maximum Output Frequency	Hz	87.5	87.5	87.5	87.5	87.5	87.5	87.5	87.5
E1-05	Maximum Output Voltage	V	190.0	190.0	190.0	190.0	190.0	190.0	190.0	190.0
E1-06	Base Frequency	Hz	87.5	87.5	87.5	87.5	87.5	87.5	87.5	87.5
E1-09	Minimum Output Frequency	Hz	4.4	4.4	4.4	4.4	4.4	4.4	4.4	4.4
C5-17	Motor Inertia	kgm ²	0.044	0.054	0.063	0.113	0.137	0.252	0.30	0.41
L3-24 *1	Motor Accel Time for Inertia Cal	s	0.099	0.098	0.096	0.126	0.124	0.188	0.186	0.184
n5-02	Motor Acceleration Time	s	0.099	0.098	0.096	0.126	0.124	0.188	0.186	0.184
n8-49	d-Axis Cur for High Efficiency Cont	%	-10.9	-14.3	-15.1	-11.3	-14.1	-18.8	-11.4	-12.2

*1 Default settings vary depending on the setting of o2-04 (Drive Model Selection).

10.22 Parameters Changed by PM Motor Code Selection

Table 10.24 SST4 series motor code setting for specification of 400 V at 1750 min⁻¹ (r/min)

No.	Name	Unit	Motor Code (setting value of E5-01)							
			2232	2233	2235	2236	2238	223A	223B	223D
E5-01	PM Motor Code Selection	-	2232	2233	2235	2236	2238	223A	223B	223D
	Voltage Class	V	400	400	400	400	400	400	400	400
	Capacity	kW	0.4	0.75	1.5	2.2	3.7	5.5	7.5	11
	Motor Rotation Speed	min ⁻¹	1750	1750	1750	1750	1750	1750	1750	1750
E5-02	PM Motor Rated Power (kW)	kW	0.4	0.75	1.5	2.2	3.7	5.5	7.5	11.0
E5-03	PM Motor Rated Current (FLA)	A	0.92	1.77	3.33	4.48	7.50	10.42	14.27	20.5
E5-04	PM Motor Pole Count	-	6	6	6	6	6	6	6	6
E5-05	PM Motor Resistance (ohms/phase)	Ω	8.935	4.570	3.096	1.906	0.972	1.103	0.630	0.429
E5-06	PM d-axis Inductance (mH/phase)	mH	80.14	48.04	35.60	30.31	20.03	23.41	14.86	14.34
E5-07	PM q-axis Inductance (mH/phase)	mH	110.76	64.88	47.84	38.36	24.97	28.70	17.25	17.25
E5-09	PM Back-EMF V _{peak} (mV/(rad/s))	mVs/rad	416.5	399.4	438.5	475.5	463.7	485.8	470.4	513.4
E5-24	PM Motor Induced Voltage Constant 2 (Ke)	mV/(r/min)	0.0	0.0	0.0	0.0	0.0	0.0	0.0	0.0
E1-04	Maximum Output Frequency	Hz	87.5	87.5	87.5	87.5	87.5	87.5	87.5	87.5
E1-05	Maximum Output Voltage	V	380.0	380.0	380.0	380.0	380.0	380.0	380.0	380.0
E1-06	Base Frequency	Hz	87.5	87.5	87.5	87.5	87.5	87.5	87.5	87.5
E1-09	Minimum Output Frequency	Hz	4.4	4.4	4.4	4.4	4.4	4.4	4.4	4.4
C5-17	Motor Inertia	kgm ²	0.0016	0.0022	0.0042	0.0081	0.0133	0.013	0.017	0.027
L3-24 *1	Motor Accel Time for Inertia Cal	s	0.134	0.099	0.094	0.124	0.121	0.081	0.075	0.082
n5-02	Motor Acceleration Time	s	0.134	0.099	0.094	0.124	0.121	0.081	0.075	0.082
n8-49	d-Axis Cur for High Efficiency Cont	%	-7.5	-8.5	-9.8	-8.2	-9.1	-13.1	-9.2	-12.4

*1 Default settings vary depending on the setting of o2-04 (Drive Model Selection).

Table 10.25 SST4 series motor code setting for specification of 400 V at 1750 min⁻¹ (r/min)

No.	Name	Unit	Motor Code (setting value of E5-01)							
			223E	223F	2240	2242	2243	2244	2245	2246
E5-01	PM Motor Code Selection	-	223E	223F	2240	2242	2243	2244	2245	2246
	Voltage Class	V	400	400	400	400	400	400	400	400
	Capacity	kW	15	18	22	30	37	45	55	75
	Motor Rotation Speed	min ⁻¹	1750	1750	1750	1750	1750	1750	1750	1750
E5-02	PM Motor Rated Power (kW)	kW	15	18.50	22.00	30.00	37.00	45.00	55.00	75.00

No.	Name	Unit	Motor Code (setting value of E5-01)							
E5-03	PM Motor Rated Current (FLA)	A	26.4	34.2	38.8	52.2	65.4	77.6	99.3	130.2
E5-04	PM Motor Pole Count	-	6	6	6	6	6	6	6	6
E5-05	PM Motor Resistance (ohms/phase)	Ω	0.275	0.196	0.160	0.120	0.077	0.052	0.036	0.023
E5-06	PM d-axis Inductance (mH/phase)	mH	9.99	7.92	6.82	5.24	3.57	2.98	1.59	1.59
E5-07	PM q-axis Inductance (mH/phase)	mH	12.37	9.64	8.51	6.44	4.65	3.75	2.78	1.97
E5-09	PM Back-EMF V _{peak} (mV/(rad/s))	mVs/rad	505.3	489.2	509.5	566.2	531.6	530.6	515.2	515.2
E5-24	PM Motor Induced Voltage Constant 2 (Ke)	mV/(r/min)	0.0	0.0	0.0	0.0	0.0	0.0	0.0	0.0
E1-04	Maximum Output Frequency	Hz	87.5	87.5	87.5	87.5	87.5	87.5	87.5	87.5
E1-05	Maximum Output Voltage	V	380.0	380.0	380.0	380.0	380.0	380.0	380.0	380.0
E1-06	Base Frequency	Hz	87.5	87.5	87.5	87.5	87.5	87.5	87.5	87.5
E1-09	Minimum Output Frequency	Hz	4.4	4.4	4.4	4.4	4.4	4.4	4.4	4.4
C5-17	Motor Inertia	kgm ²	0.044	0.054	0.063	0.113	0.137	0.252	0.30	0.41
L3-24 */	Motor Accel Time for Inertia Cal	s	0.099	0.098	0.096	0.126	0.124	0.188	0.186	0.184
n5-02	Motor Acceleration Time	s	0.099	0.098	0.096	0.126	0.124	0.188	0.186	0.184
n8-49	d-Axis Cur for High Efficiency Cont	%	-15.1	-14.3	-15.3	-11.3	-14.5	-13.2	-22.6	-11.9

*1 Default settings vary depending on the setting of o2-04 (Drive Model Selection).

Table 10.26 SST4 series motor code setting for specification of 400 V at 1750 min⁻¹ (r/min)

No.	Name	Unit	Motor Code (setting value of E5-01)							
E5-01	PM Motor Code Selection	-	2247	2248	2249	224A	224C	224D	224E	
	Voltage Class	V	400	400	400	400	400	400	400	
	Capacity	kW	90	110	132	160	200	220	300	
	Motor Rotation Speed	min ⁻¹	1750	1750	1750	1750	1750	1750	1750	
E5-02	PM Motor Rated Power (kW)	kW	90.00	110.00	132.00	160.00	200.00	250.00	300.00	
E5-03	PM Motor Rated Current (FLA)	A	153.1	184.4	229.2	269.8	346.9	421.9	520.8	
E5-04	PM Motor Pole Count	-	6	6	6	6	6	6	6	
E5-05	PM Motor Resistance (ohms/phase)	Ω	0.019	0.017	0.012	0.008	0.005	0.004	0.002	
E5-06	PM d-axis Inductance (mH/phase)	mH	1.51	1.43	1.13	0.96	0.65	0.67	0.40	

10.22 Parameters Changed by PM Motor Code Selection

No.	Name	Unit	Motor Code (setting value of E5-01)						
E5-07	PM q-axis Inductance (mH/phase)	mH	1.76	1.92	1.54	1.26	0.88	0.74	0.52
E5-09	PM Back-EMF Vpeak (mV/(rad/s))	mVs/rad	538.3	590.9	548.2	603.9	556.8	593.1	495.4
E5-24	PM Motor Induced Voltage Constant 2 (Ke)	mV/(r/min)	0.0	0.0	0.0	0.0	0.0	0.0	0.0
E1-04	Maximum Output Frequency	Hz	87.5	87.5	87.5	87.5	87.5	87.5	87.5
E1-05	Maximum Output Voltage	V	380.0	380.0	380.0	380.0	380.0	380.0	380.0
E1-06	Base Frequency	Hz	87.5	87.5	87.5	87.5	87.5	87.5	87.5
E1-09	Minimum Output Frequency	Hz	4.4	4.4	4.4	4.4	4.4	4.4	4.4
C5-17	Motor Inertia	kgm ²	0.55	0.82	0.96	1.60	1.95	2.82	3.70
L3-24 *1	Motor Accel Time for Inertia Cal	s	0.205	0.250	0.244	0.336	0.327	0.379	0.414
n5-02	Motor Acceleration Time	s	0.205	0.250	0.244	0.336	0.327	0.379	0.414
n8-49	d-Axis Cur forHighEfficiency Cont	%	-8.6	-14.8	-17.5	-12.5	-14.7	-5.1	-16.3

*1 Default settings vary depending on the setting of o2-04 (Drive Model Selection).

Table 10.27 SST4 series motor code setting for specification of 200 V at 1450 min⁻¹ (r/min)

No.	Name	Unit	Motor Code (setting value of E5-01)							
E5-01	PM Motor Code Selection	-	2302	2303	2305	2306	2308	230A	230B	230D
	Voltage Class	V	200	200	200	200	200	200	200	200
	Capacity	kW	0.4	0.75	1.5	2.2	3.7	5.5	7.5	11
	Motor Rotation Speed	min ⁻¹	1450	1450	1450	1450	1450	1450	1450	1450
E5-02	PM Motor Rated Power (kW)	kW	0.4	0.75	1.5	2.2	3.7	5.5	7.5	11.0
E5-03	PM Motor Rated Current (FLA)	A	1.77	3.33	5.94	9.48	14.17	20.42	27.92	39.6
E5-04	PM Motor Pole Count	-	6	6	6	6	6	6	6	6
E5-05	PM Motor Resistance (ohms/phase)	Ω	3.154	1.835	0.681	0.308	0.405	0.278	0.180	0.098
E5-06	PM d-axis Inductance (mH/phase)	mH	28.46	19.46	10.00	6.88	8.15	5.77	6.32	3.34
E5-07	PM q-axis Inductance (mH/phase)	mH	39.29	25.89	15.20	9.25	10.76	8.60	8.80	4.61
E5-09	PM Back-EMF Vpeak (mV/(rad/s))	mVs/rad	268.8	256.9	271.9	260.2	286.8	314.9	300.8	292.3
E5-24	PM Motor Induced Voltage Constant 2 (Ke)	mV/(r/min)	0.0	0.0	0.0	0.0	0.0	0.0	0.0	0.0
E1-04	Maximum Output Frequency	Hz	72.5	72.5	72.5	72.5	72.5	72.5	72.5	72.5

No.	Name	Unit	Motor Code (setting value of E5-01)							
E1-05	Maximum Output Voltage	V	190.0	190.0	190.0	190.0	190.0	190.0	190.0	190.0
E1-06	Base Frequency	Hz	72.5	72.5	72.5	72.5	72.5	72.5	72.5	72.5
E1-09	Minimum Output Frequency	Hz	3.6	3.6	3.6	3.6	3.6	3.6	3.6	3.6
C5-17	Motor Inertia	kgm ²	0.0016	0.0022	0.0081	0.0133	0.0133	0.017	0.027	0.044
L3-24 */	Motor Accel Time for Inertia Cal	s	0.092	0.068	0.125	0.139	0.083	0.070	0.082	0.092
n5-02	Motor Acceleration Time	s	0.092	0.068	0.125	0.139	0.083	0.070	0.082	0.092
n8-49	d-Axis Cur for High Efficiency Cont	%	-7.5	-9.4	-13.9	-10.0	-15.0	-17.9	-22.7	-20.5

*1 Default settings vary depending on the setting of o2-04 (Drive Model Selection).

Table 10.28 SST4 series motor code setting for specification of 200 V at 1450 min⁻¹ (r/min)

No.	Name	Unit	Motor Code (setting value of E5-01)							
E5-01	PM Motor Code Selection	-	230E	230F	2310	2312	2313	2314	2315	2316
	Voltage Class	V	200	200	200	200	200	200	200	200
	Capacity	kW	15	18	22	30	37	45	55	75
	Motor Rotation Speed	min ⁻¹	1450	1450	1450	1450	1450	1450	1450	1450
E5-02	PM Motor Rated Power (kW)	kW	15.0	18.50	22.00	30.00	37.00	45.00	55.00	75.00
E5-03	PM Motor Rated Current (FLA)	A	54.2	68.3	75.2	102.0	131.3	160.4	191.7	257.3
E5-04	PM Motor Pole Count	-	6	6	6	6	6	6	6	6
E5-05	PM Motor Resistance (ohms/phase)	Ω	0.073	0.055	0.048	0.034	0.023	0.016	0.012	0.007
E5-06	PM d-axis Inductance (mH/phase)	mH	2.94	2.23	2.08	1.67	1.39	0.94	0.82	0.56
E5-07	PM q-axis Inductance (mH/phase)	mH	3.65	2.85	2.66	2.04	1.73	1.22	1.06	0.76
E5-09	PM Back-EMF V _{peak} (mV/(rad/s))	mVs/rad	305.1	297.6	355.8	355.4	324.0	302.4	337.2	323.4
E5-24	PM Motor Induced Voltage Constant 2 (Ke)	mV/(r/min)	0.0	0.0	0.0	0.0	0.0	0.0	0.0	0.0
E1-04	Maximum Output Frequency	Hz	72.5	72.5	72.5	72.5	72.5	72.5	72.5	72.5
E1-05	Maximum Output Voltage	V	190.0	190.0	190.0	190.0	190.0	190.0	190.0	190.0
E1-06	Base Frequency	Hz	72.5	72.5	72.5	72.5	72.5	72.5	72.5	72.5
E1-09	Minimum Output Frequency	Hz	3.6	3.6	3.6	3.6	3.6	3.6	3.6	3.6
C5-17	Motor Inertia	kgm ²	0.054	0.063	0.113	0.137	0.252	0.304	0.41	0.55
L3-24 */	Motor Accel Time for Inertia Cal	s	0.083	0.079	0.118	0.105	0.157	0.156	0.172	0.169

10.22 Parameters Changed by PM Motor Code Selection

No.	Name	Unit	Motor Code (setting value of E5-01)							
n5-02	Motor Acceleration Time	s	0.083	0.079	0.118	0.105	0.157	0.156	0.172	0.169
n8-49	d-Axis Cur forHighEfficiency Cont	%	-14.6	-16.4	-11.8	-10.5	-14.5	-17.4	-13.8	-17.5

*1 Default settings vary depending on the setting of o2-04 (Drive Model Selection).

Table 10.29 SST4 series motor code setting for specification of 400 V at 1450 min⁻¹ (r/min)

No.	Name	Unit	Motor Code (setting value of E5-01)							
E5-01	PM Motor Code Selection	-	2332	2333	2335	2336	2338	233A	233B	233D
	Voltage Class	V	400	400	400	400	400	400	400	400
	Capacity	kW	0.4	0.75	1.5	2.2	3.7	5.5	7.5	11
	Motor Rotation Speed	min ⁻¹	1450	1450	1450	1450	1450	1450	1450	1450
E5-02	PM Motor Rated Power (kW)	kW	0.4	0.75	1.5	2.2	3.7	5.5	7.5	11.0
E5-03	PM Motor Rated Current (FLA)	A	0.91	1.67	3.02	4.74	7.08	10.21	13.96	20.5
E5-04	PM Motor Pole Count	-	6	6	6	6	6	6	6	6
E5-05	PM Motor Resistance (ohms/phase)	Ω	12.616	7.340	2.724	1.232	1.509	1.112	0.720	0.393
E5-06	PM d-axis Inductance (mH/phase)	mH	113.84	77.84	40.00	27.52	31.73	23.09	25.28	13.36
E5-07	PM q-axis Inductance (mH/phase)	mH	157.16	103.56	60.80	37.00	40.88	34.39	35.20	18.44
E5-09	PM Back-EMF V _{peak} (mV/(rad/s))	mVs/rad	490.8	513.8	543.7	520.3	580.8	602.7	601.5	584.6
E5-24	PM Motor Induced Voltage Constant 2 (Ke)	mV/(r/min)	0.0	0.0	0.0	0.0	0.0	0.0	0.0	0.0
E1-04	Maximum Output Frequency	Hz	72.5	72.5	72.5	72.5	72.5	72.5	72.5	72.5
E1-05	Maximum Output Voltage	V	380.0	380.0	380.0	380.0	380.0	380.0	380.0	380.0
E1-06	Base Frequency	Hz	72.5	72.5	72.5	72.5	72.5	72.5	72.5	72.5
E1-09	Minimum Output Frequency	Hz	3.6	3.6	3.6	3.6	3.6	3.6	3.6	3.6
C5-17	Motor Inertia	kgm ²	0.0016	0.0022	0.0081	0.0133	0.0133	0.017	0.027	0.044
L3-24 *1	Motor Accel Time for Inertia Cal	s	0.092	0.068	0.125	0.139	0.083	0.070	0.082	0.092
n5-02	Motor Acceleration Time	s	0.092	0.068	0.125	0.139	0.083	0.070	0.082	0.092
n8-49	d-Axis Cur forHighEfficiency Cont	%	-9.5	-9.4	-13.7	-10.0	-12.9	-19.9	-22.8	-19.8

*1 Default settings vary depending on the setting of o2-04 (Drive Model Selection).

Table 10.30 SST4 series motor code setting for specification of 400 V at 1450 min⁻¹ (r/min)

No.	Name	Unit	Motor Code (setting value of E5-01)							
			233E	233F	2340	2342	2343	2344	2345	2346
E5-01	PM Motor Code Selection	-	233E	233F	2340	2342	2343	2344	2345	2346
	Voltage Class	V	400	400	400	400	400	400	400	400
	Capacity	kW	15	18	22	30	37	45	55	75
	Motor Rotation Speed	min ⁻¹	1450	1450	1450	1450	1450	1450	1450	1450
E5-02	PM Motor Rated Power (kW)	kW	15	18.50	22.00	30.00	37.00	45.00	55.00	75.00
E5-03	PM Motor Rated Current (FLA)	A	27.1	34.2	37.6	50.9	65.4	80.2	96.1	129.2
E5-04	PM Motor Pole Count	-	6	6	6	6	6	6	6	6
E5-05	PM Motor Resistance (ohms/phase)	Ω	0.291	0.220	0.192	0.136	0.091	0.064	0.048	0.028
E5-06	PM d-axis Inductance (mH/phase)	mH	11.77	8.94	8.32	6.68	5.30	3.76	3.09	2.24
E5-07	PM q-axis Inductance (mH/phase)	mH	14.60	11.40	10.64	8.16	6.80	4.88	4.75	3.03
E5-09	PM Back-EMF V _{peak} (mV/(rad/s))	mVs/rad	610.3	595.2	711.6	710.8	652.7	604.8	669.1	646.8
E5-24	PM Motor Induced Voltage Constant 2 (Ke)	mV/(r/min)	0.0	0.0	0.0	0.0	0.0	0.0	0.0	0.0
E1-04	Maximum Output Frequency	Hz	72.5	72.5	72.5	72.5	72.5	72.5	72.5	72.5
E1-05	Maximum Output Voltage	V	380.0	380.0	380.0	380.0	380.0	380.0	380.0	380.0
E1-06	Base Frequency	Hz	72.5	72.5	72.5	72.5	72.5	72.5	72.5	72.5
E1-09	Minimum Output Frequency	Hz	3.6	3.6	3.6	3.6	3.6	3.6	3.6	3.6
C5-17	Motor Inertia	kgm ²	0.054	0.063	0.113	0.137	0.252	0.304	0.41	0.55
L3-24 */	Motor Accel Time for Inertia Cal	s	0.083	0.079	0.118	0.105	0.157	0.156	0.172	0.169
n5-02	Motor Acceleration Time	s	0.083	0.079	0.118	0.105	0.157	0.156	0.172	0.169
n8-49	d-Axis Cur for High Efficiency Cont	%	-14.5	-16.1	-11.8	-10.5	-15.6	-17.4	-21.7	-17.3

*1 Default settings vary depending on the setting of o2-04 (Drive Model Selection).

Table 10.31 SST4 series motor code setting for specification of 400 V at 1450 min⁻¹ (r/min)

No.	Name	Unit	Motor Code (setting value of E5-01)					
			2347	2348	2349	234A	234C	234D
E5-01	PM Motor Code Selection	-	2347	2348	2349	234A	234C	234D
	Voltage Class	V	400	400	400	400	400	400
	Capacity	kW	90	110	132	160	200	250
	Motor Rotation Speed	min ⁻¹	1450	1450	1450	1450	1450	1450
E5-02	PM Motor Rated Power (kW)	kW	90.00	110.00	132.00	160.00	200.00	250.00

10.22 Parameters Changed by PM Motor Code Selection

No.	Name	Unit	Motor Code (setting value of E5-01)					
E5-03	PM Motor Rated Current (FLA)	A	153.1	191.7	226.0	268.8	331.3	422.9
E5-04	PM Motor Pole Count	-	6	6	6	6	6	6
E5-05	PM Motor Resistance (ohms/phase)	Ω	0.024	0.015	0.011	0.007	0.006	0.003
E5-06	PM d-axis Inductance (mH/phase)	mH	2.20	1.34	1.23	0.92	0.84	0.61
E5-07	PM q-axis Inductance (mH/phase)	mH	3.23	2.16	1.67	1.30	1.25	0.89
E5-09	PM Back-EMF V _{peak} (mV/(rad/s))	mVs/rad/s)	708.0	637.8	677.0	661.7	687.1	655.9
E5-24	PM Motor Induced Voltage Constant 2 (K _e)	mV/(r/min)	0.0	0.0	0.0	0.0	0	0.0
E1-04	Maximum Output Frequency	Hz	72.5	72.5	72.5	72.5	72.5	72.5
E1-05	Maximum Output Voltage	V	380.0	380.0	380.0	380.0	380.0	380.0
E1-06	Base Frequency	Hz	72.5	72.5	72.5	72.5	72.5	72.5
E1-09	Minimum Output Frequency	Hz	3.6	3.6	3.6	3.6	3.6	3.6
C5-17	Motor Inertia	kgm ²	0.82	0.96	1.60	1.95	2.82	3.70
L3-24 *1	Motor Accel Time for Inertia Cal	s	0.210	0.201	0.279	0.281	0.325	0.341
n5-02	Motor Acceleration Time	s	0.210	0.201	0.279	0.281	0.325	0.341
n8-49	d-Axis Cur for High Efficiency Cont	%	-19.6	-24.1	-15.1	-17.0	-19.8	-19.3

*1 Default settings vary depending on the setting of o2-04 (Drive Model Selection).

Table 10.32 SST4 series motor code setting for specification of 200 V at 1150 min⁻¹ (r/min)

No.	Name	Unit	Motor Code (setting value of E5-01)							
E5-01	PM Motor Code Selection	-	2402	2403	2405	2406	2408	240A	240B	240D
	Voltage Class	V	200	200	200	200	200	200	200	200
	Capacity	kW	0.4	0.75	1.5	2.2	3.7	5.5	7.5	11
	Motor Rotation Speed	min ⁻¹	1150	1150	1150	1150	1150	1150	1150	1150
E5-02	PM Motor Rated Power (kW)	kW	0.4	0.75	1.5	2.2	3.7	5.5	7.5	11.0
E5-03	PM Motor Rated Current (FLA)	A	1.77	3.44	5.94	9.17	14.79	20.21	27.40	39.0
E5-04	PM Motor Pole Count	-	6	6	6	6	6	6	6	6
E5-05	PM Motor Resistance (ohms/phase)	Ω	2.680	1.520	1.071	0.542	0.362	0.295	0.162	0.115
E5-06	PM d-axis Inductance (mH/phase)	mH	30.55	15.29	17.48	11.98	8.60	9.54	5.31	4.44

No.	Name	Unit	Motor Code (setting value of E5-01)							
E5-07	PM q-axis Inductance (mH/phase)	mH	42.71	24.28	22.51	15.51	10.69	13.84	8.26	5.68
E5-09	PM Back-EMF V _{peak} (mV/(rad/s))	mVs/rad	313.1	313.1	345.3	342.9	363.8	384.3	379.9	370.2
E5-24	PM Motor Induced Voltage Constant 2 (Ke)	mV/(r/min)	0.0	0.0	0.0	0.0	0.0	0.0	0.0	0.0
E1-04	Maximum Output Frequency	Hz	57.5	57.5	57.5	57.5	57.5	57.5	57.5	57.5
E1-05	Maximum Output Voltage	V	190.0	190.0	190.0	190.0	190.0	190.0	190.0	190.0
E1-06	Base Frequency	Hz	57.5	57.5	57.5	57.5	57.5	57.5	57.5	57.5
E1-09	Minimum Output Frequency	Hz	2.9	2.9	2.9	2.9	2.9	2.9	2.9	2.9
C5-17	Motor Inertia	kgm ²	0.0022	0.0042	0.0081	0.0133	0.0168	0.027	0.044	0.054
L3-24 */	Motor Accel Time for Inertia Cal	s	0.080	0.081	0.078	0.088	0.066	0.070	0.085	0.071
n5-02	Motor Acceleration Time	s	0.080	0.081	0.078	0.088	0.066	0.070	0.085	0.071
n8-49	d-Axis Cur for High Efficiency Cont	%	-8.4	-11.0	-10.7	-10.7	-9.4	-22.5	-22.2	-16.7

*1 Default settings vary depending on the setting of o2-04 (Drive Model Selection).

Table 10.33 SST4 series motor code setting for specification of 200 V at 1150 min⁻¹ (r/min)

No.	Name	Unit	Motor Code (setting value of E5-01)							
E5-01	PM Motor Code Selection	-	240E	240F	2410	2412	2413	2414	2415	2416
	Voltage Class	V	200	200	200	200	200	200	200	200
	Capacity	kW	15	18	22	30	37	45	55	75
	Motor Rotation Speed	min ⁻¹	1150	1150	1150	1150	1150	1150	1150	1150
E5-02	PM Motor Rated Power (kW)	kW	15	18.50	22.00	30.00	37.00	45.00	55.00	75.00
E5-03	PM Motor Rated Current (FLA)	A	55.9	65.4	77.0	103.5	126.0	153.1	188.5	260.4
E5-04	PM Motor Pole Count	-	6	6	6	6	6	6	6	6
E5-05	PM Motor Resistance (ohms/phase)	Ω	0.083	0.065	0.052	0.035	0.026	0.019	0.013	0.009
E5-06	PM d-axis Inductance (mH/phase)	mH	3.50	2.92	2.55	2.03	1.59	1.24	0.98	0.70
E5-07	PM q-axis Inductance (mH/phase)	mH	4.23	3.79	3.22	2.46	1.92	1.64	1.37	0.97
E5-09	PM Back-EMF V _{peak} (mV/(rad/s))	mVs/rad	364.5	404.5	445.1	444.4	447.3	470.8	422.4	418.3
E5-24	PM Motor Induced Voltage Constant 2 (Ke)	mV/(r/min)	0.0	0.0	0.0	0.0	0.0	0.0	0.0	0.0
E1-04	Maximum Output Frequency	Hz	57.5	57.5	57.5	57.5	57.5	57.5	57.5	57.5

10.22 Parameters Changed by PM Motor Code Selection

No.	Name	Unit	Motor Code (setting value of E5-01)							
E1-05	Maximum Output Voltage	V	190.0	190.0	190.0	190.0	190.0	190.0	190.0	190.0
E1-06	Base Frequency	Hz	57.5	57.5	57.5	57.5	57.5	57.5	57.5	57.5
E1-09	Minimum Output Frequency	Hz	2.9	2.9	2.9	2.9	2.9	2.9	2.9	2.9
C5-17	Motor Inertia	kgm ²	0.063	0.113	0.137	0.252	0.304	0.410	0.55	0.82
L3-24 */	Motor Accel Time for Inertia Cal	s	0.061	0.089	0.090	0.122	0.119	0.132	0.145	0.159
n5-02	Motor Acceleration Time	s	0.061	0.089	0.090	0.122	0.119	0.132	0.145	0.159
n8-49	d-Axis Cur for High Efficiency Cont	%	-13.7	-15.2	-10.9	-9.8	-9.3	-11.5	-17.7	-17.1

*1 Default settings vary depending on the setting of o2-04 (Drive Model Selection).

Table 10.34 SST4 series motor code setting for specification of 400 V at 1150 min⁻¹ (r/min)

No.	Name	Unit	Motor Code (setting value of E5-01)							
E5-01	PM Motor Code Selection	-	2432	2433	2435	2436	2438	243A	243B	
	Voltage Class	V	400	400	400	400	400	400	400	
	Capacity	kW	0.4	0.75	1.5	2.2	3.7	5.5	7.5	
	Motor Rotation Speed	min ⁻¹	1150	1150	1150	1150	1150	1150	1150	
E5-02	PM Motor Rated Power (kW)	kW	0.4	0.75	1.5	2.2	3.7	5.5	7.5	
E5-03	PM Motor Rated Current (FLA)	A	0.89	1.72	3.02	4.58	7.40	10.21	13.75	
E5-04	PM Motor Pole Count	-	6	6	6	6	6	6	6	
E5-05	PM Motor Resistance (ohms/phase)	Ω	10.720	6.080	4.336	2.143	1.428	1.199	0.648	
E5-06	PM d-axis Inductance (mH/phase)	mH	122.20	61.16	70.24	46.20	33.87	41.67	21.24	
E5-07	PM q-axis Inductance (mH/phase)	mH	170.80	97.12	90.04	60.28	42.98	69.15	33.04	
E5-09	PM Back-EMF V _{peak} (mV/(rad/s))	mVs/rad	626.1	626.1	703.1	727.6	699.0	861.5	759.7	
E5-24	PM Motor Induced Voltage Constant 2 (K _e)	mV/(r/min)	0.0	0.0	0.0	0.0	0.0	0.0	0.0	
E1-04	Maximum Output Frequency	Hz	57.5	57.5	57.5	57.5	57.5	57.5	57.5	
E1-05	Maximum Output Voltage	V	380.0	380.0	380.0	380.0	380.0	380.0	380.0	
E1-06	Base Frequency	Hz	57.5	57.5	57.5	57.5	57.5	57.5	57.5	
E1-09	Minimum Output Frequency	Hz	2.9	2.9	2.9	2.9	2.9	2.9	2.9	
C5-17	Motor Inertia	kgm ²	0.0022	0.0042	0.0081	0.0133	0.0168	0.027	0.044	
L3-24 */	Motor Accel Time for Inertia Cal	s	0.080	0.081	0.078	0.088	0.066	0.070	0.085	

No.	Name	Unit	Motor Code (setting value of E5-01)						
n5-02	Motor Acceleration Time	s	0.080	0.081	0.078	0.088	0.066	0.070	0.085
n8-49	d-Axis Cur for High Efficiency Cont	%	-8.4	-11.0	-9.9	-9.0	-11.4	-23.2	-22.1

*1 Default settings vary depending on the setting of o2-04 (Drive Model Selection).

Table 10.35 SST4 series motor code setting for specification of 400 V at 1150 min⁻¹ (r/min)

No.	Name	Unit	Motor Code (setting value of E5-01)						
E5-01	PM Motor Code Selection	-	243D	243E	243F	2440	2442	2443	2444
	Voltage Class	V	400	400	400	400	400	400	400
	Capacity	kW	11	15	18	22	30	37	45
	Motor Rotation Speed	min ⁻¹	1150	1150	1150	1150	1150	1150	1150
E5-02	PM Motor Rated Power (kW)	kW	11.0	15	18.50	22.00	30.00	37.00	45.00
E5-03	PM Motor Rated Current (FLA)	A	19.5	27.7	32.7	39.2	51.8	63.0	76.6
E5-04	PM Motor Pole Count	-	6	6	6	6	6	6	6
E5-05	PM Motor Resistance (ohms/phase)	Ω	0.460	0.325	0.260	0.209	0.140	0.106	0.076
E5-06	PM d-axis Inductance (mH/phase)	mH	17.76	12.83	11.68	10.09	8.12	6.43	4.96
E5-07	PM q-axis Inductance (mH/phase)	mH	22.72	17.19	15.16	16.25	9.84	7.71	6.56
E5-09	PM Back-EMF V _{peak} (mV/(rad/s))	mVs/rad	740.4	716.6	809.1	786.2	888.8	857.7	941.6
E5-24	PM Motor Induced Voltage Constant 2 (Ke)	mV/(r/min)	0.0	0.0	0.0	0.0	0.0	0.0	0.0
E1-04	Maximum Output Frequency	Hz	57.5	57.5	57.5	57.5	57.5	57.5	57.5
E1-05	Maximum Output Voltage	V	380.0	380.0	380.0	380.0	380.0	380.0	380.0
E1-06	Base Frequency	Hz	57.5	57.5	57.5	57.5	57.5	57.5	57.5
E1-09	Minimum Output Frequency	Hz	2.9	2.9	2.9	2.9	2.9	2.9	2.9
C5-17	Motor Inertia	kgm ²	0.054	0.063	0.113	0.137	0.252	0.304	0.410
L3-24 *1	Motor Accel Time for Inertia Cal	s	0.071	0.061	0.089	0.090	0.122	0.119	0.132
n5-02	Motor Acceleration Time	s	0.071	0.061	0.089	0.090	0.122	0.119	0.132
n8-49	d-Axis Cur for High Efficiency Cont	%	-16.7	-20.2	-15.2	-27.7	-9.8	-10.2	-11.5

*1 Default settings vary depending on the setting of o2-04 (Drive Model Selection).

10.22 Parameters Changed by PM Motor Code Selection

Table 10.36 SST4 series motor code setting for specification of 400 V at 1150 min⁻¹ (r/min)

No.	Name	Unit	Motor Code (setting value of E5-01)						
			2445	2446	2447	2448	2449	244A	244C
E5-01	PM Motor Code Selection	-	2445	2446	2447	2448	2449	244A	244C
	Voltage Class	V	400	400	400	400	400	400	400
	Capacity	kW	55	75	90	110	132	160	200
	Motor Rotation Speed	min ⁻¹	1150	1150	1150	1150	1150	1150	1150
E5-02	PM Motor Rated Power (kW)	kW	55.00	75.00	90.00	110.00	132.00	160.00	200.00
E5-03	PM Motor Rated Current (FLA)	A	93.1	128.1	153.1	186.5	221.9	269.8	336.5
E5-04	PM Motor Pole Count	-	6	6	6	6	6	6	6
E5-05	PM Motor Resistance (ohms/phase)	Ω	0.051	0.032	0.026	0.015	0.012	0.009	0.007
E5-06	PM d-axis Inductance (mH/phase)	mH	3.99	2.97	2.44	1.87	1.49	1.41	1.22
E5-07	PM q-axis Inductance (mH/phase)	mH	5.39	3.90	3.23	2.46	2.08	1.88	1.51
E5-09	PM Back-EMF V _{peak} (mV/(rad/s))	mVs/rad	853.8	829.6	835.6	833.4	848.6	889.1	915.0
E5-24	PM Motor Induced Voltage Constant 2 (K _e)	mV/(r/min)	0.0	0.0	0.0	0.0	0.0	0.0	0.0
E1-04	Maximum Output Frequency	Hz	57.5	57.5	57.5	57.5	57.5	57.5	57.5
E1-05	Maximum Output Voltage	V	380.0	380.0	380.0	380.0	380.0	380.0	380.0
E1-06	Base Frequency	Hz	57.5	57.5	57.5	57.5	57.5	57.5	57.5
E1-09	Minimum Output Frequency	Hz	2.9	2.9	2.9	2.9	2.9	2.9	2.9
C5-17	Motor Inertia	kgm ²	0.55	0.82	0.96	1.60	1.95	2.82	3.70
L3-24 *1	Motor Accel Time for Inertia Cal	s	0.145	0.159	0.155	0.211	0.214	0.256	0.268
n5-02	Motor Acceleration Time	s	0.145	0.159	0.155	0.211	0.214	0.256	0.268
n8-49	d-Axis Cur for High Efficiency Cont	%	-15.9	-15.7	-15.7	-14.7	-16.5	-14.1	-10.3

*1 Default settings vary depending on the setting of o2-04 [Drive Model Selection].

Parameter Details

11.1	Safety Precautions	570
11.2	A: Initialization Parameters	571
11.3	b: Application	592
11.4	C: Tuning	643
11.5	d: Reference Settings	668
11.6	E: Motor Parameters	689
11.7	F: Options	711
11.8	H: Terminal Functions	752
11.9	L: Protection Function	827
11.10	n: Special Adjustment	874
11.11	o: Keypad-Related Settings	897
11.12	T: Auto-Tuning	916

11.1 Safety Precautions

DANGER

Heed the safety messages in this manual. Failure to comply will result in death or serious injury.

The operating company is responsible for any injuries or equipment damage resulting from failure to heed the warnings in this manual.

11.2 A: Initialization Parameters

A parameters [Initialization Parameters] set the operating environment and operating conditions for the drive.

◆ A1: Initialization

A1 parameters set the operating environment and operating conditions for the drive. For example, these parameters set the keypad language, the control method for the drive, and the parameter access level.

■ A1-00: Language Selection

No. (Hex.)	Name	Description	Default (Range)
A1-00 (0100) RUN	Language Selection	V/f CL-V/f OLV CLV AOLV OLV/PM AOLV/PM CLV/PM EZOLV Selects the language for the LCD keypad.	1 (0 - 12)

Note:

This parameter is not reset when the drive is initialized using parameter A1-03 [Initialize Parameters].

0 : English

1 : Japanese

2 : German

3 : French

4 : Italian

5 : Spanish

6 : Portuguese

7 : Chinese (simplified)

8 : Czech

9 : Russian

10 : Turkish

11 : Polish

12 : Greek

■ A1-01: Access Level Selection

No. (Hex.)	Name	Description	Default Setting (Range)
A1-01 (0101) RUN	Access Level Selection	V/f CL-V/f OLV CLV AOLV OLV/PM AOLV/PM CLV/PM EZOLV Restricts user access to parameter settings. The set access level restricts what parameters the keypad will display, and what parameters the user can set.	2 (0 - 3)

0 : Operation Only

Access to A1-00, A1-01, A1-04 [Password] and the U Monitor.

1 : User Parameters

Access to A1-00, A1-01, A1-04 and A2-01 to A2-32 [User Parameters 1 to 32] only.

2 : Advanced Level

Access to all parameters except those for the Expert mode.

3 : Expert Level

Access to all parameters including those for the Expert mode.

Note the following points about the Parameter Access.

- Users cannot change the setting values set in A1-01 to A1-03, A1-06, A1-07, and A2-01 through A2-32 when a password is set to the drive using A1-04 and A1-05 [Password Setting].
- Parameter settings cannot be changed even if A1-01 = 1, 2, 3 is set when H1-xx [MFDI Function Select] = 1B [Program Lockout] is OFF, unless H1-xx = 1B is turned ON.

- The keypad cannot be used to change any parameter settings when using MEMOBUS/Modbus communications until the Enter command is issued from the controller to the drive to complete the serial communication write process.

■ **A1-02: Control Method Selection**

No. (Hex.)	Name	Description	Default Setting (Range)
A1-02 (0102)	Control Method Selection	 Selects the control method for the drive application and the motor.	2 (0 - 8)

Note:

- Parameters that are determined by A1-02 are changed back to their default settings whenever the control method is changed.
- When using the 2 motor switchover function, turn off the terminal to which H1-xx = 16 [Terminal Sx Function Select = Motor 2 Selection] has been assigned, and then change the A1-02 setting. An incorrect procedure will trigger oPE08 [Parameter Selection Error].

Selects the control method for the drive application and the motor.

0 : V/f Control

Use this control method for general variable speed control applications that do not require a high level of responsiveness and high-precision speed control and connect multiple motors to a single drive. Also use this control method when there is not enough data to set the motor parameters or when it is not possible to perform Auto-Tuning. The speed control range is 1:40.

1 : Closed Loop V/f Control

Use this control method for general applications that do not require a high level of responsiveness but require high-precision speed control. Also use this control method when it is not possible to perform Auto-Tuning because there is not enough data to set the motor parameters. The speed control range is 1:40.

2 : Open Loop Vector Control

Use this control method for general variable speed control applications that require high-precision speed control. This control method achieves high torque response as well as high torque even when operating at low speeds, even without a feedback signal from the motor. The speed control range is 1:120.

3 : Closed Loop Vector Control

Use this control method for general variable speed control applications that require high torque response, high-precision speed control up to zero speed, and high-precision torque control. This method requires a speed feedback signal from the motor. The speed control range is 1:1500.

4 : Advanced OpenLoop Vector Control

This is a control method for induction motors. Use this control method for applications that require high-precision speed control.

This control method achieves high speed and torque response as well as high torque even when operating at low speeds. The speed control range is 1:200.

5 : PM Open Loop Vector Control

Use this control method for general variable speed control applications that do not require a high level of responsiveness and high-precision speed control. The drive can control an IPM motor or SPM motor within the speed control range 1: 20.

6 : PM Advanced Open Loop Vector

Use this control method for general variable speed control applications that require high-precision speed control and torque limit. The drive can control an IPM motor within the speed control range 1: 20. The speed control range is 1:100 when n8-57 = 1 [High Frequency Injection = Enabled].

7 : PM Closed Loop Vector Control

Use this control method for constant torque applications that require high-precision control with a PM motor, and for general variable speed control applications that require high torque response and high-precision torque control. The speed control range is 1:1500. This method requires a speed feedback signal from the motor.

8 : EZ Open Loop Vector Control

This is a control method for induction motors and PM motors. The drive can operate motors efficiently with a simpler procedure. Use this control method for derating torque applications such as fans and pumps.

■ A1-03: Initialize Parameters

No. (Hex.)	Name	Description	Default (Range)
A1-03 (0103)	Initialize Parameters	<div style="display: flex; justify-content: space-between; font-size: 0.8em; font-weight: bold; background-color: #333; color: white; padding: 2px;"> V/f CL-V/f OLV CLV AOLV OLV/PM AOLV/PM CLV/PM EZOLV </div> Resets parameters to default values.	0 (0 - 3330)

Note:

- $A1-03 = 0$ is automatically set after initializing the drive.
- User Parameter Settings let the user save parameter values needed for the application, and have the drive use those parameter settings as the default value when initializing the drive.
- When using the 2 motor switchover function, turn off the terminal to which $H1-xx = 16$ [Terminal Sx Function Select = Motor 2 Selection] has been assigned, and then change the $A1-03$ setting. An incorrect procedure will trigger $oPE08$ [Parameter Selection Error].

0 : No initialization

1110 : User Initialization

Resets parameters to the values selected by the user as User Settings. Set $o2-03 = 1$ [User Parameter Default Value = Set defaults] to save the user settings.

Users can save the parameter settings adjusted for the test run as user-set default values to the drive. Set $A1-03 = 1110$ to reset to the saved parameter settings.

Follow the following steps to save User Parameter setting values, and to perform a User Initialization.

1. Set parameters appropriately for the application.
2. Set $o2-03 = 1$ [User Parameter Default Value = Set defaults] after setting parameters. This saves parameter settings for a User Initialization. The setting value for $o2-03$ automatically goes back to 0.
3. Any changes made after settings are saved as User Parameter Settings will be reset to the previously set value when setting $A1-03 = 1110$. The drive initializes parameter values by setting them back to the User Parameter Setting values.

2220 : 2-Wire initialization

Resets multi-function digital input terminal S1 to Forward Run and terminal S2 to Reverse Run, and resets all parameters to default settings.

3330 : 3-Wire initialization

Resets multi-function digital input terminal S1 to Run, terminal S2 to Stop, and terminal S5 to FWD/REV, and resets all parameters to default settings

The following parameters are not initialized when setting $A1-03 = 2220, 3330$.

No.	Name
A1-00	Language Selection
A1-02	Control Method Selection
A1-07	DriveWorksEZ Function Selection
E1-03	V/f Pattern Selection
E5-01	PM Motor Code Selection
E5-02	PM Motor Rated Power (kW)
E5-03	PM Motor Rated Current (FLA)
E5-04	PM Motor Pole Count
E5-05	PM Motor Resistance (ohms/phase)
E5-06	PM d-axis Inductance (mH/phase)
E5-07	PM q-axis Inductance (mH/phase)
E5-09	PM Back-EMF V_{peak} (mV/(rad/s))
E5-11	Encoder Z-Pulse Offset
E5-24	PM Back-EMF L-L V_{rms} (mV/rpm)
E5-25	Polarity Estimation Reversal
F6-08	Comm Parameter Reset @Initialize









11.2 A: Initialization Parameters

No.	Name
F6-xx/F7-xx	Communication Option Card Communication option card parameters are initialized when setting F6-08 = 1 [Comm Parameter Reset @Initialize = Reset - back to factory default].
L8-35	Installation Method Selection
o2-04	Drive Model Selection
q1-xx - q8-xx	DriveWorksEZ Parameters
r1-xx	DWEZ Connection 1-20

Note:

- Setting A1-06 [Application Preset] automatically optimizes parameter settings for the application that was selected, although the drive does not initialize A1-02 when the user sets A1-03 = 2220, 3330.
- Setting A1-03 = 2220, 3330 initializes A1-05 [Password Setting] to 0000. Be sure to set the password again for applications that require a password.

■ A1-04: Password

No. (Hex.)	Name	Description	Default (Range)
A1-04 (0104)	Password	         Enter the correct password set in A1-05 [Password Setting] to unlock parameters. The user can still view parameter settings while they are locked without entering the password. Enter the password in A1-04 [Password] to unlock and change the settings.	0000 (0000 - 9999)

The following parameters cannot be changed if the password entered in A1-04 does not match the password setting that was set in A1-05.















- A1-01 [Access Level Selection]
- A1-02 [Control Method Selection]
- A1-03 [Initialize Parameters]
- A1-06 [Application Preset]
- A1-07 [DriveWorksEZ Function Selection]
- A2-01 to A2-32 [User Parameters 1 to 32]

To lock parameter settings after making changes without changing the password, enter the incorrect password in A1-04 and press .

Enter the Password to Unlock Parameters

Follow the directions below to unlock parameter settings.

Set the password in A1-05 [Password Setting], and display the Parameter Setting Mode screen. This procedure verifies the password, and checks if parameter settings are unlocked.



1. Press  or  to select "A: Initialization Parameters," and press .
2. Press  or  to select [A1-04], and press . Parameter settings can now be changed.
3. Press  or  to move the digit and enter the password.
4. Press  to confirm the password. The drive unlocks parameters, and automatically switches to the Parameter Settings screen.
5. Press  or  to show [A1-02], and press . The keypad displays the setting value for [A1-02].
6. Press  or  to verify that the setting value can be changed.

After verifying that the setting value can be changed, press  (Back) until the Parameter Setup Mode screen appears.

■ A1-05: Password Setting

No. (Hex.)	Name	Description	Default (Range)
A1-05 (0105)	Password Setting	<div style="display: flex; justify-content: space-between; font-size: 0.8em; font-weight: bold; margin-bottom: 5px;"> V/f CL-V/f OLV CLV AOLV OLV/PM AOLV/PM CLV/PM EZOLV </div> The drive locks the following parameters once the password has been set. The following parameters can be changed if the user enters the correct password in A1-04 [Password] that matches the password set in A1-05.	0000 (0000 - 9999)

Note:

- Normally, A1-05 will not appear. To make A1-05 appear and to set it, display A1-04 and then, while pressing the  on the keypad, press the .
- Once A1-05 is set, A1-05 is not displayed again unless the correct password is entered in A1-04. Ensure that the A1-05 setting value is not forgotten. In case of forgetting the A1-05 setting value, contact Yaskawa or your nearest sales representative.
- The drive is initialized to A1-05 = 0000 when A1-03 = 2220, 3330 [2-Wire initialization, 3-Wire initialization] is set. Be sure to set the password again for applications that require a password.
- Change the setting value in A1-05 to change the password. The value entered becomes the new password.
- To lock the parameter again with the same password after unlocking the parameter with the configured password and changing the parameter, enter a setting value other than the password such as 0000 in A1-04 [Password].

■ A1-06: Application Preset

WARNING! Sudden Movement Hazard. Confirm the drive I/O signals and external sequence before performing a test run. Setting parameter A1-06 [Application Preset] may automatically change the I/O terminal function from the default setting. Failure to comply may result in death or serious injury.

No. (Hex.)	Name	Description	Default (Range)
A1-06 (0127)	Application Preset	<div style="display: flex; justify-content: space-between; font-size: 0.8em; font-weight: bold; margin-bottom: 5px;"> V/f CL-V/f OLV CLV AOLV OLV/PM AOLV/PM CLV/PM EZOLV </div> This parameter conveniently sets up the drive for certain applications.	0 (0 - 7)

The drive is loaded with the following application presets. By selecting the preset in A1-06 that matches the application, the drive automatically optimizes parameter settings related to that application. The drive saves parameters frequently used for the application to A2-01 to A2-16 [User Parameters 1 to 16] so that they can be easily set or referenced in [User Parameters] under the main menu.

- Water supply pump
- Conveyor
- Exhaust fan
- HVAC
- Air compressor
- Hoist
- Traveling

Note:

- Be sure to initialize parameters by setting A1-03 = 2220, 3330 [Initialize Parameters = 2-Wire initialization, 3-Wire initialization] prior to setting A1-06.
- Be sure to perform Auto-Tuning after setting A1-06 for a hoist application.
- It is not possible to change the value set in A1-06. To select another application preset, initialize parameters first by setting A1-03 = 2220 and then make another selection to A1-06. It is not necessary to change settings if initializing all parameters will create a problem. Parameters automatically registered to A2-17 to A2-32 [User Parameters 17 to 32] by setting A2-33 = 1 [User Parameter Auto Selection = Enabled] will be reset when changing the setting of A1-06.

0 : Disabled

1 : Water supply pump 2

Automatically sets the following parameters for a water supply pump.

Table 11.1 Optimal Settings for Water Supply Pump Applications

No.	Name	Optimal Value
A1-02	Control Method Selection	0: V/f Control
b1-04	Reverse Operation Selection	1: Reverse disabled
C1-01	Acceleration Time 1	1.0 s

11.2 A: Initialization Parameters

No.	Name	Optimal Value
C1-02	Deceleration Time 1	1.0 s
C6-01	Normal / Heavy Duty Selection	1: Normal Duty Rating
E1-03	V/f Pattern Selection	F: User Defined (C6-03 to C6-05)
E1-07	Mid Point A Frequency	30.0 Hz
E1-08	Mid Point A Voltage	50.0 V
L2-01	Momentary Power Loss Ope Select	1: Enabled
L3-04	Decel Stall Prevention Selection	1: Enabled

The drive saves the following parameters as User Parameters.

Table 11.2 Parameters Saved as User Parameters with the Water Supply Pump Preset

User Parameters No.	Parameter No. Saved	Name
A2-01	b1-01	Frequency Reference Selection 1
A2-02	b1-02	Run Command Selection 1
A2-03	b1-04	Reverse Operation Selection
A2-04	C1-01	Acceleration Time 1
A2-05	C1-02	Deceleration Time 1
A2-06	E1-03	V/f Pattern Selection
A2-07	E1-07	Mid Point A Frequency
A2-08	E1-08	Mid Point A Voltage
A2-09	E2-01	Motor Rated Current
A2-10	H1-05	Terminal S5 Function Select
A2-11	H1-06	Terminal S6 Function Select
A2-12	H1-07	Terminal S7 Function Select
A2-13	L5-01	Number of Auto Restart Attempts

2 : Conveyor

Automatically sets the following parameters for a conveyor.

Table 11.3 Optimal Settings for Conveyor Applications

No.	Name	Optimal Value
A1-02	Control Method Selection	0: V/f Control
C1-01	Acceleration Time 1	3.0 s
C1-02	Deceleration Time 1	3.0 s
C6-01	Normal / Heavy Duty Selection	0: Heavy Duty Rating
L3-04	Decel Stall Prevention Selection	1: Enabled

The drive saves the following parameters as User Parameters.

Table 11.4 Parameters Saved as User Parameters with the Conveyor Preset

User Parameters No.	Parameter No. Saved	Name
A2-01	A1-02	Control Method Selection
A2-02	b1-01	Frequency Reference Selection 1
A2-03	b1-02	Run Command Selection 1
A2-04	C1-01	Acceleration Time 1
A2-05	C1-02	Deceleration Time 1
A2-06	E2-01	Motor Rated Current
A2-07	L3-04	Decel Stall Prevention Selection

3 : Exhaust fan

Automatically sets the following parameters for an exhaust fan.

Table 11.5 Optimal Settings for Exhaust Fan Applications

No.	Name	Optimal Value
A1-02	Control Method Selection	0: V/f Control
b1-04	Reverse Operation Selection	1: Reverse disabled
C6-01	Normal / Heavy Duty Selection	1: Normal Duty Rating
E1-03	V/f Pattern Selection	F: User Defined (C6-03 to C6-05)
E1-07	Mid Point A Frequency	30.0 Hz
E1-08	Mid Point A Voltage	50.0 V
L2-01	Momentary Power Loss Ope Select	1: Enabled
L3-04	Decel Stall Prevention Selection	1: Enabled

The drive saves the following parameters as User Parameters.

Table 11.6 Parameters Saved as User Parameters with the Exhaust Fan Preset

User Parameters No.	Parameter No. Saved	Name
A2-01	b1-01	Frequency Reference Selection 1
A2-02	b1-02	Run Command Selection 1
A2-03	b1-04	Reverse Operation Selection
A2-04	b3-01	Speed Search Selection at Start
A2-05	C1-01	Acceleration Time 1
A2-06	C1-02	Deceleration Time 1
A2-07	E1-03	V/f Pattern Selection
A2-08	E1-07	Mid Point A Frequency
A2-09	E1-08	Mid Point A Voltage
A2-10	E2-01	Motor Rated Current
A2-11	H1-05	Terminal S5 Function Select
A2-12	H1-06	Terminal S6 Function Select
A2-13	H1-07	Terminal S7 Function Select
A2-14	L5-01	Number of Auto Restart Attempts

4 : HVAC

Automatically sets the following parameters for a HVAC.

Table 11.7 Optimal Settings for HVAC Applications

No.	Name	Optimal Value
A1-02	Control Method Selection	0: V/f Control
b1-04	Reverse Operation Selection	1: Reverse disabled
b1-17	Run Command at Power Up	1: Accept existing RUN command
C6-01	Normal / Heavy Duty Selection	1: Normal Duty Rating
C6-02	Carrier Frequency Selection	3: 8.0 kHz
H2-03	Terminal P1-C1 Function Select	39: Watt Hour Pulse Output
L2-01	Momentary Power Loss Ope Select	2: Enbl whl CPU act
L8-03	Overheat Pre-Alarm Ope Selection	4: Run@L8-19 Rate
L8-38	Carrier Frequency Reduction	2: Enabled for the EntireSpeedRange

The drive saves the following parameters as User Parameters.

Table 11.8 Parameters Saved as User Parameters with the HVAC Preset

User Parameters No.	Parameter No. Saved	Name
A2-01	b1-01	Frequency Reference Selection 1
A2-02	b1-02	Run Command Selection 1
A2-03	b1-03	Stopping Method Selection
A2-04	b1-04	Reverse Operation Selection
A2-05	C1-01	Acceleration Time 1
A2-06	C1-02	Deceleration Time 1
A2-07	C6-02	Carrier Frequency Selection
A2-08	d2-01	Frequency Reference Upper Limit
A2-09	d2-02	Frequency Reference Lower Limit
A2-10	E1-03	V/f Pattern Selection
A2-11	E1-04	Maximum Output Frequency
A2-12	E2-01	Motor Rated Current
A2-13	H3-11	Terminal A2 Gain Setting
A2-14	H3-12	Terminal A2 Bias Setting
A2-15	L2-01	Momentary Power Loss Ope Select
A2-16	o4-12	kWh Monitor Initialization

5 : Air compressor

Automatically sets the following parameters for an air compressor.

Table 11.9 Optimal Settings for Air Compressor Applications

No.	Name	Optimal Value
A1-02	Control Method Selection	0: V/f Control
b1-04	Reverse Operation Selection	1: Reverse disabled
C1-01	Acceleration Time 1	5.0 s
C1-02	Deceleration Time 1	5.0 s
C6-01	Normal / Heavy Duty Selection	0: Heavy Duty Rating
E1-03	V/f Pattern Selection	F: User Defined (C6-03 to C6-05)
L2-01	Momentary Power Loss Ope Select	1: Enabled
L3-04	Decel Stall Prevention Selection	1: Enabled

The drive saves the following parameters as User Parameters.

Table 11.10 Parameters Saved as User Parameters with the Air Compressor Preset

User Parameters No.	Parameter No. Saved	Name
A2-01	b1-01	Frequency Reference Selection 1
A2-02	b1-02	Run Command Selection 1
A2-03	b1-04	Reverse Operation Selection
A2-04	C1-01	Acceleration Time 1
A2-05	C1-02	Deceleration Time 1
A2-06	E1-03	V/f Pattern Selection
A2-07	E1-07	Mid Point A Frequency
A2-08	E1-08	Mid Point A Voltage
A2-09	E2-01	Motor Rated Current

6 : Crane (hoist)

Automatically sets the following parameters for a hoist.

Note:

Be sure to perform Auto-Tuning after setting *A1-06* for a hoist application. *Refer to Notes when Applying the Drive to the Elevator on page 581* for hoist (elevator) instructions.

Table 11.11 Optimal Settings for Hoist Applications

No.	Name	Optimal Value
A1-02	Control Method Selection	2: Open Loop Vector Control
b1-01	Frequency Reference Selection 1	0: Keypad
b6-01	Dwell Reference at Start	3.0 Hz
b6-02	Dwell Time at Start	0.3 s
C1-01	Acceleration Time 1	3.0 s
C1-02	Deceleration Time 1	3.0 s
C6-01	Normal / Heavy Duty Selection	0: Heavy Duty Rating
C6-02	Carrier Frequency Selection	2: 5.0 kHz (4.0 kHz for AOLV/PM)
d1-01	Reference 1	6.00 Hz
d1-02	Reference 2	30.00 Hz
d1-03	Reference 3	60.00 Hz
E1-03	V/f Pattern Selection	F: User Defined (C6-03 to C6-05)
H2-01	Terminal M1-M2 Function Select	5: Frequency Detection 2
H2-02	Terminal M3-M4 Function Select	37: During Frequency Output
H3-06	Terminal A3 Function Selection	F: Through Mode
L2-03	Momentary Power Loss Min BB Time	0.3 s
L3-04	Decel Stall Prevention Selection	0: Disabled
L4-01	Speed Agree Detection Level	2.0 Hz
L4-02	Speed Agree Detection Width	0.0 Hz
L6-01	Torque Detection Selection 1	8: UL Flt dur RUN
L6-02	Torque Detection Level 1	2%
L6-03	Torque Detection Time 1	0.5 s
L8-05	Input Phase Loss Protect Select	1: Enabled
L8-07	Output Phase Loss Protect Select	1: Enabled
L8-38	Carrier Frequency Reduction	1: Enabled below 6 Hz
L8-41	High Current Alarm Selection	1: Enabled

The drive saves the following parameters as User Parameters.

Table 11.12 Parameters Saved as User Parameters with the Hoist Preset

User Parameters No.	Parameter No. Saved	Name
A2-01	A1-02	Control Method Selection
A2-02	b1-01	Frequency Reference Selection 1
A2-03	b6-01	Dwell Reference at Start
A2-04	b6-02	Dwell Time at Start
A2-05	C1-01	Acceleration Time 1
A2-06	C1-02	Deceleration Time 1
A2-07	C6-02	Carrier Frequency Selection
A2-08	d1-01	Reference 1
A2-09	d1-02	Reference 2
A2-10	d1-03	Reference 3
A2-11	E1-08	Mid Point A Voltage

11.2 A: Initialization Parameters

User Parameters No.	Parameter No. Saved	Name
A2-12	H2-01	Terminal M1-M2 Function Select
A2-13	L1-01	Motor Overload Protection Select
A2-14	L4-01	Speed Agree Detection Level
A2-15	L6-02	Torque Detection Level 1
A2-16	L6-03	Torque Detection Time 1

7 : Crane (Traveling)

Automatically sets the following parameters for traveling.

Table 11.13 Optimal Settings for Traveling Applications

No.	Name	Optimal Value
A1-02	Control method	0: V/f Control
b1-01	Frequency Reference Selection 1	0: Keypad
C1-01	Acceleration Time 1	3.0 s
C1-02	Deceleration Time 1	3.0 s
C6-01	Normal / Heavy Duty Selection	0: Heavy Duty Rating
C6-02	Carrier Frequency Selection	2: 5.0 kHz (4.0 kHz for AOLV/PM)
d1-01	Reference 1	6.00 Hz
d1-02	Reference 2	30.00 Hz
d1-03	Reference 3	60.00 Hz
H1-05	Terminal S5 Function Select	3: Multi-Step Speed Reference 1
H1-06	Terminal S6 Function Select	4: Multi-Step Speed Reference 2
H2-01	Terminal M1-M2 Function Select	37: During Frequency Output
H2-02	Terminal M3-M4 Function Select	37: During Frequency Output
H3-06	Terminal A3 Function Selection	1F: Through Mode
L3-04	Decel Stall Prevention Selection	0: Disabled
L8-05	Input Phase Loss Protect Select	1: Enabled
L8-07	Output Phase Loss Protect Select	1: 1PH Loss Det
L8-38	Carrier Frequency Reduction	1: Enabled below 6 Hz
L8-41	High Current Alarm Selection	1: Enabled

The drive saves the following parameters as User Parameters.

Table 11.14 Parameters Saved as User Parameters with the Traveling Preset

User Parameters No.	Parameter No. Saved	Name
A2-01	b1-01	Frequency Reference Selection 1
A2-02	C1-01	Acceleration Time 1
A2-03	C1-02	Deceleration Time 1
A2-04	C6-02	Carrier Frequency Selection
A2-05	d1-01	Reference 1
A2-06	d1-02	Reference 2
A2-07	d1-03	Reference 3
A2-08	E2-01	Motor Rated Current
A2-09	H1-05	Terminal S5 Function Select
A2-10	H1-06	Terminal S6 Function Select
A2-11	H2-01	Terminal M1-M2 Function Select
A2-12	L1-01	Motor Overload Protection Select

■ Notes when Applying the Drive to the Elevator

When applying the drive for an elevator application, read the safety descriptions and precautions well, and use the device in a safe and proper manner.

Brake Open and Close Conditions

Be sure to set $L4-07 = 0$ [*Speed Agree Detection Selection = No detection during baseblock*] as a condition in which to close and open the holding brake.

Setting $L4-07 = 1$ [*Detection always enabled*] causes the output frequency to rise if the Run command is input even when the external baseblock command is input. For this reason, speed detection operates and will result in the brake signal opening.

• Setting of Related Parameters

The table below shows examples of parameter settings that are utilized when using the MFDO terminal (M1-M2) as the holding brake open and close signal.

Table 11.15 Holding Brake Open and Close Signal Setting Example

Brake Open and Close Signal		Brake Open and Close Level Adjust		Applicable Control Methods (A1-02 setting value)			
Signal Name	Parameter Settings	Signal Name	Parameter Settings	V/f (0)	OLV (2)	CLV (3)	CLV/PM (7) *1
Frequency (FOUT) Detection 2	$L4-07 = 0$	Speed Agree Detection Level	$L4-01 = 1.0 \text{ Hz to } 3.0 \text{ Hz}^*2$	x	x	-	-
	$H2-01 = 5$	Speed Agree Detection Width	$L4-02 = 0.0 \text{ Hz to } 0.5 \text{ Hz}^*3$				
During Frequency Output	$H2-01 = 37$	DC Injection/Zero Speed Threshold	$b2-01 = 0.1 \text{ Hz to } 0.5 \text{ Hz}$	-	-	x	x

*1 If $A1-02 = 7$ [*PM Closed Loop Vector Control*], when auto-tuning or switching the encoder, the motor needs to be in a state in which it is capable of rotating. For the signal that is used and the adjustment method, refer to the Closed Loop Vector Control for the induction motor.

*2 It is the normal setting range when $A1-02 = 2$ [*Open Loop Vector Control*]. When $A1-02 = 0$ [*V/f Control*], set $L4-01$ to the rated slip frequency of the motor + approx. 0.5 Hz. If the setting value is set too low, it may lead to insufficient motor torque and cause rollback. Be sure to set the setting value so that it satisfies the following two conditions simultaneously. However, if the setting value is too high, shock will likely occur during startup.

- $L4-01 > E1-09$ [Minimum Output Frequency]
- $L4-01 > L4-02$ [Speed Agree Detection Width]

*3 The detection width of Frequency Detection 2 can be adjusted with $L4-02$. If rollback occurs when the motor is stopped, change the frequency to around 0.1 Hz.

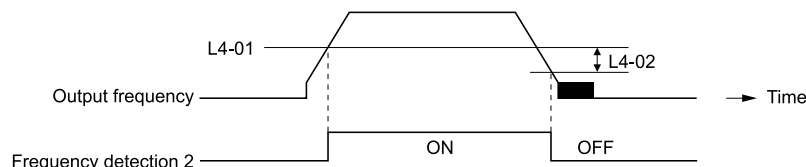

Figure 11.1 Frequency Detection 2

Sequence Circuit Configuration

Set the circuit for the open/close sequence of the holding brake as follows.

- Set the sequence which opens the holding brake by turning terminal M1-M2 on when the sequence side operation conditions are met.
- Set the sequence so that the holding brake will be firmly closed when a fault signal is detected in the event of an emergency.
- If a raise or lower command is entered, set the sequence so that the holding brake will be open.

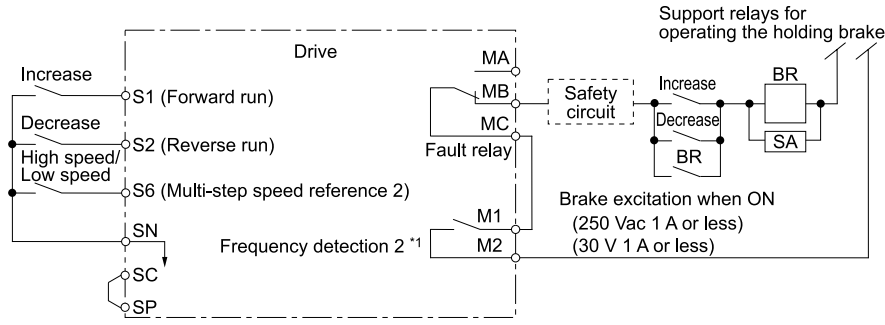

Figure 11.2 Sequence Circuit Configuration Diagram

*1 $L4-07 = 0$ [Speed Agree Detection Selection = No detection during baseblock] or During Frequency Output

Time Chart

The following time chart shows the open/close sequence of the holding brake.

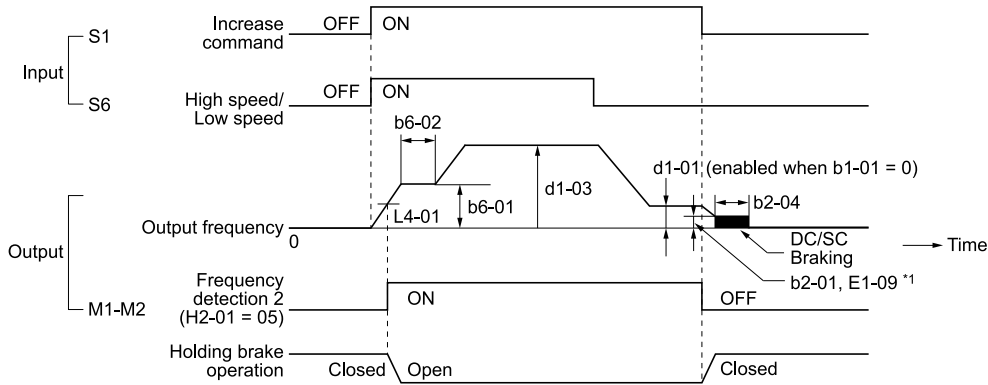

Figure 11.3 Holding Brake Open and Close Sequence Time Chart (V/f Control, Closed Loop V/f Control, or Open Loop Vector Control)

*1 Start braking from whichever parameter $b2-01$ [DC Injection/Zero SpeedThreshold] or $E1-09$ [Minimum Output Frequency] has the higher set frequency.

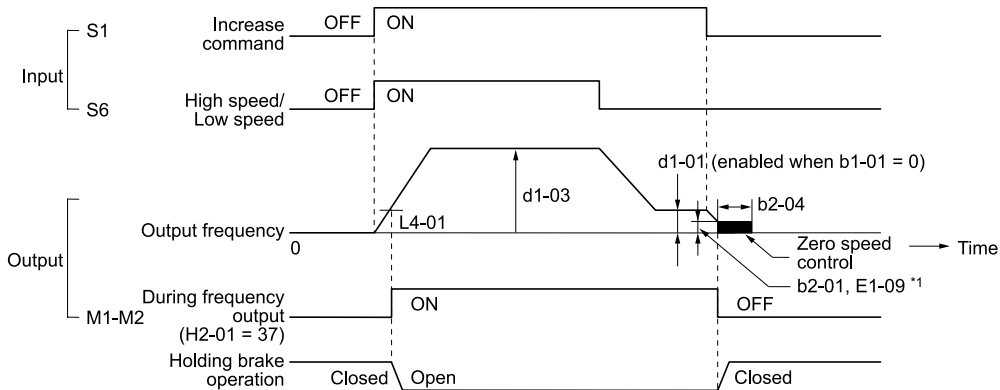

Figure 11.4 Holding Brake Open and Close Sequence Time Chart (Closed Loop Vector Control, Closed Loop Vector Control for PM)

*1 Start braking from whichever parameter $b2-01$ [DC Injection/Zero SpeedThreshold] or $E1-09$ [Minimum Output Frequency] has the higher set frequency.

Notes on when using Other Functions

Function	Notes
Decel stall prevention function	<p>Make sure to set $L3-04 = 0$ [Decel Stall Prevention Selection = Disabled] when connecting the braking resistor that discharges the regenerative power to the drive.</p> <p>Note:</p> <ul style="list-style-type: none"> The drive may not stop within the designated deceleration time if $L3-04 = 1$ [General Purpose]. Do not change the following default settings of the related parameters. $L3-01 = 1$ [Stall Prevent Select during Accel = General Purpose] $L3-05 = 1$ [Stall Prevent Select during Run = Decel time 1 (Decelerate using C1-02 [Deceleration Time 1])]
Auto-Tuning for Induction Motors	<ul style="list-style-type: none"> When $A1-02 = 2$ or 3 [Control Method Selection = Open Loop Vector Control or Closed Loop Vector Control], auto-tune the motor alone before operating the drive. To execute Rotational Auto-Tuning, be sure that the drive is uncoupled from the motor. Auto-Tuning executes automatically for about 1 minute. Do not execute Auto-Tuning with the motor inserted in the elevator system. <p>Note:</p> <ul style="list-style-type: none"> If motor cannot be uncoupled from the machine, perform Stationary Auto-Tuning. When Stationary Auto-Tuning is performed, the drive energizes the motor while the motor remains stopped. During this time the necessary motor data is automatically measured. When information from the motor's test report or nameplate is not available, use Stationary Auto-Tuning. To improve torque characteristics at low speeds in the V/f Control mode, perform Stationary Auto-Tuning for Line-to-Line Resistance. To auto-tune a specialized motor such as a wound motor, prepare a motor test report beforehand and ensure that the motor parameter $E2-xx$ that was tuned does not differ significantly from the value in the test report.
Auto-Tuning for PM Motors	<p>To run a PM motor, the motor data must be set in the drive.</p> <ul style="list-style-type: none"> When using a PM motor recommended by Yaskawa Input the motor code in $E5-01$. $E5$ and other related motor parameters will be automatically set to the optimal values. When using a PM motor other than a Yaskawa Execute Auto-Tuning. <ul style="list-style-type: none"> If information from motor nameplates or test reports is available, enter the PM motor parameters directly with PM Motor Parameter Settings. If no motor name plates or test reports are available, and if in an environment where the motor is unable to rotate, perform PM Stationary Auto-Tuning. If no motor name plates or test reports are available, and if in an environment where the motor is able to rotate, perform PM Rotational Auto-Tuning. Whenever the failed encoder has been replaced, put the motor in the state where it can rotate and perform Z Pulse Offset Tuning or PM Rotational Auto-Tuning. <p>Note:</p> <ul style="list-style-type: none"> Use in Closed Loop Vector Control for PM mode. When auto-tuning or replacing the encoder, place the motor in a state in which it can be rotated. Be sure to set the Encoder Z-Pulse Offset. For the signal that is used and the adjustment description, refer to the Closed Loop Vector Control for the induction motor.
Braking Resistor Overheat Protection	<p>This function detects overheating of the braking resistor via thermal overload relay when using a braking resistor other than the optional Yaskawa braking resistor unit (LKEB series). Load a sequence program that cuts the drive input power supply when the braking resistor overheats.</p> <p>Note:</p> <p>When loading the sequence circuit, refer to "Standard connection diagrams."</p>
Continuous operation function	<p>Do not use the momentary power loss continuous operation function and the Auto Restart function. If these functions are used, there is a risk that the motor will coast to a stop while the brake is open in the event of a momentary power loss while the drive is running or in the event of a fault.</p> <p>Set the following parameters associated with these functions.</p> <ul style="list-style-type: none"> $L2-01 = 0$ [Momentary Power Loss Ope Select = Disabled] $L5-01 = 0$ [Number of Auto Restart Attempts = 0]
Torque limit function	<p>The $L7-01$ to $L7-04$ [Torque Limit] value is based on the motor rated torque. When torque will likely be insufficient during startup, replace the drive with a large capacity drive and adjust the torque limit between 200% and 300%. The $L7-01$ to $L7-04$ default setting is 200%.</p>

11.2 A: Initialization Parameters

Function	Notes
I/O phase loss protection, overtorque detection function	<p>To arrest the fall due to phase loss, set the following relevant parameters.</p> <ul style="list-style-type: none"> • L8-05 = 1 [Input Phase Loss Protect Select = Enabled] • L8-07 = 1 [Output Phase Loss Protect Select = 1PH Loss Det] • L6-01, L6-04 = 1 to 8 [Torque Detection Selection 1/2 = UL Flt dur RUN] • L6-02, L6-05 [Torque Detection Level 1/2] • L6-03, L6-06 [Torque Detection Time 1 1/2] <p>Note: Execute safety measures such as fall detection on the machine side.</p>
External baseblock command	<ul style="list-style-type: none"> • If the external baseblock signal set with H1-01 to H1-08 = 8 or 9 [Terminal S1 to S8 Function Select = Baseblock Command] is entered during run, the motor immediately coasts to stop. Do not enter an unnecessary external baseblock command while the motor is operating. • When using an external baseblock command for the fast stop and operation startup interlocks, load the sequence which firmly locks the holding brake while the external baseblock command is entered. • When the external baseblock command is immediately removed after it is entered, the drive will not output the voltage within the time set in L2-03 [Momentary Power Loss Min BB Time]. Do not use an external baseblock command for applications involving frequent Run/Stop execution.
Accel/Decel Time	<p>If the acceleration and deceleration times for the drive side are set short without factoring the mechanical operation delay time of the holding brake, the holding brake could operate late, or could experience overcurrent at startup, brake grinding and rollback when stopping. In such cases, adjust the timing for the holding brake using Dwell Reference at Start/Time and DC Injection Braking at Stop.</p>
Electromagnetic contactor on the drive output side	<p>Ordinarily, the electromagnetic contactor should not be installed between the drive and motor. If however, an electromagnetic contactor must be installed to switchover multiple motors via a single drive based on regulations, take the following precautions.</p> <ul style="list-style-type: none"> • Load a sequence that opens and closes the electromagnetic contactor when both of the following conditions are satisfied at once. Unless there is an emergency. <ul style="list-style-type: none"> – The holding brake is completely closed – The drive terminals to which H2-xx = 8 or 1B [Output Terminal Function Selection = During Baseblock] has been assigned have been turned ON • If the electromagnetic contactor is opened and closed during motor control or during DC Injection Braking (or zero speed control), fault detections may occur due to the effects of the surge voltage and the motor direct input current. • When the electromagnetic contactor has been installed between the drive and the motor, set L8-07 = 1 or 2 [Output Phase Loss Protect Select = 1PH Loss Det or 2/3PH Loss Det].

Adjustments Relating to Control

This drive is built to even deliver optimum performance for elevators. However, when phenomenon occur that cause oscillation, rollback and other control problems, adjust the parameters in accordance with the control method.

In the following table, only the parameters that are frequently adjusted are listed.

Note:

As torque and speed response for the high-resistance motor and high-slip motor are slow, adjust the torque and speed response to increase them. Conversely, low impedance (low-slip) motors are likely to experience hunting and oscillation. Therefore, adjust the torque and speed response to increase them.

V/f Control and Closed Loop V/f Control

While in V/f Control, do not use C3-01 [Slip Compensation Gain].

While in Closed Loop V/f Control, continue to use default settings for C5-01 to C5-05 [ASR Parameters]. Significantly altering the default settings will likely cause oscillation.

Table 11.16 Adjustment of Drive Control (V/f Control and Closed Loop V/f Control Methods)

Adjustment description	Parameter Number	Solution	Default Setting	Suggested Setting
<ul style="list-style-type: none"> Hunting and oscillation suppression at middle-range speeds (10 Hz to 40 Hz) 	n1-02 [Hunting Prevention Gain Setting]	<ul style="list-style-type: none"> Reduce the setting when torque is insufficient with heavy loads. If hunting, oscillation occurs with light loads, increase the setting. 	1.00	0.50 - 2.00
<ul style="list-style-type: none"> Increasing motor excitation sound Hunting and oscillation suppression at low speeds and middle-range speeds 	C6-02 [Carrier Frequency Selection]	<ul style="list-style-type: none"> Increase the setting value if there is a marked motor excitation sound. If hunting and oscillation occurs at low speeds and middle-range speeds reduce the setting value. 	*1	1 - F
<ul style="list-style-type: none"> Increasing torque at low speeds (10 Hz or lower) Hunting, oscillation suppression 	C4-01 [Torque Compensation Gain]	<ul style="list-style-type: none"> Increase the setting value when torque is insufficient at low speeds. If hunting, oscillation occurs with light loads, reduce the setting value. 	1.00	0.50 - 1.50
<ul style="list-style-type: none"> Increasing torque at low speeds Shock suppression during startup 	E1-08 [Mid Point A Voltage]	<ul style="list-style-type: none"> Increase the setting value when torque is insufficient at low speeds. Reduce the setting value if there is marked shock during drive startup. 	15.0 V *2 *3	13.0 V to 16.0 V *3
	E1-10 [Minimum Output Voltage]		9.0 V *2 *3	7.0 V to 10.0 V *3

*1 The default setting differs depending on settings for C6-01 [Normal / Heavy Duty Selection] and o2-04 [Drive Model Selection].

*2 The default setting differs depending on settings for A1-02 [Control Method Selection] and E1-03 [V/f Pattern Selection].

*3 Set for 200 V class drives. Voltage is double for 400 V class drives.

Open Loop Vector Control Method

C4-01 [Torque Compensation Gain] should be left at its default setting. Do not adjust it.

If speed accuracy cannot be obtained during regeneration, set C3-04 = 1 [Slip Compensation @ Regen Select = Enabled above 6 Hz]. If speed accuracy cannot be obtained at high speeds, set C3-05 = 1 [Output Voltage limit Selection = Enabled].

Table 11.17 Adjustment of Drive Control (Open Loop Vector Control Method)

Adjustment description	Parameter Number	Solution	Default Setting	Suggested Setting
<ul style="list-style-type: none"> Torque, increasing speed response Hunting and oscillation suppression at middle-range speeds (10 Hz to 40 Hz) 	n2-01 [SpdFeedbackDetectCtr (AFR) Gain]	<ul style="list-style-type: none"> Reduce the setting value when torque and speed response are slow. If hunting, oscillation occurs, increase the setting value. 	1.00	0.50 - 2.00
<ul style="list-style-type: none"> Torque, increasing speed response Hunting, oscillation suppression 	C4-02 [Torque Compensation Delay Time] *1	<ul style="list-style-type: none"> Reduce the setting value when torque and speed response are slow. If hunting, oscillation occurs, increase the setting value. 	20 ms	20 - 100 ms
<ul style="list-style-type: none"> Increasing speed response Improving speed stability 	C3-02 [Slip Compensation Delay Time]	<ul style="list-style-type: none"> Reduce the setting value when speed response is slow. Increase the setting value if speed is not stable. 	200 ms	100 - 500 ms

11.2 A: Initialization Parameters

Adjustment description	Parameter Number	Solution	Default Setting	Suggested Setting
<ul style="list-style-type: none"> Improving speed accuracy 	C3-01 [Slip Compensation Gain]	<ul style="list-style-type: none"> Increase the setting value if speed is slow. Reduce the setting value if speed is fast. 	1.0	0.5 - 1.5
<ul style="list-style-type: none"> Increasing motor excitation sound Hunting and oscillation suppression at low speeds (10 Hz or lower) 	C6-02 [Carrier Frequency Selection]	<ul style="list-style-type: none"> Increase the setting value if there is a marked motor excitation sound. If hunting and oscillation occur at low speeds, reduce the setting value. 	*2	1 - F
<ul style="list-style-type: none"> Increasing torque and speed response at low speeds Shock suppression during startup 	E1-08 [Mid Point A Voltage]	<ul style="list-style-type: none"> Increase the setting value when torque and speed response are slow. Reduce the setting value if there is marked shock during drive startup. 	11.0 V *3	12.0 V to 13.0 V *3
	E1-10 [Minimum Output Voltage]		2.0 V *3	2.0 V to 3.0 V *3

*1 If C4-02 [Torque Compensation Delay Time] is high, the current may increase during startup. Adjust the current during startup while checking it.

*2 The default setting differs depending on settings for C6-01 [Normal / Heavy Duty Selection] and o2-04 [Drive Model Selection].

*3 Set for 200 V class drives. Voltage is double for 400 V class drives.

Closed Loop Vector Control Method

Table 11.18 Adjustment of Drive Control (Closed Loop Vector Control Method)

Adjustment description	Parameter Number	Solution	Default Setting	Suggested Setting
<ul style="list-style-type: none"> Torque, increasing speed response Hunting, oscillation suppression 	C5-01 (ASR Proportional Gain 1)	<ul style="list-style-type: none"> Increase the setting value when torque and speed response are slow. Reduce the setting value when hunting and oscillation occurs. 	20.00	10.00 - 50.00
	C5-03 (ASR Proportional Gain 2)			
<ul style="list-style-type: none"> Torque, increasing speed response Hunting, oscillation suppression 	C5-02 (ASR Integral Time 1)	<ul style="list-style-type: none"> Reduce the setting value when torque and speed response are slow. If hunting, oscillation occurs, increase the setting value. 	0.500 s	0.300 to 1.000 seconds
	C5-04 (ASR Integral Time 2)			
Change the ASR proportional gain and ASR integral time in accordance with the output frequency.	C5-07 (ASR Gain Switchover Frequency)	When ASR proportional gain or integral time cannot be established for low speed or high speed, switch in accordance with the output frequency.	0.0 Hz (Do not switch)	0.0 to Maximum frequency
<ul style="list-style-type: none"> Hunting, oscillation suppression 	C5-06 (ASR Delay Time)	<ul style="list-style-type: none"> Increase the setting value when oscillation is likely to occur due to poor machine rigidity. 	0.004 s	0.004 to 0.020 seconds

Elevator Start/Stop and Accel/Decel Time Shock Reduction

Shock when starting and stopping the elevator, and when accelerating and decelerating is an issue for passenger elevator applications. Adjust the following parameters when shock affects ride quality.

S-Curve Characteristics, Accel & Decel Time

Adjustment parameter	Name
C1-01, C1-03, C1-05, C1-07	Acceleration Time 1 to 4
C1-02, C1-04, C1-06, C1-08	Deceleration Time 1 to 4
C2-01	S-Curve Time @ start of Accel

Adjustment parameter	Name
C2-02	S-Curve Time @ end of Accel
C2-03	S-Curve Time @ start of Decel
C2-04	S-Curve Time @ end of Decel

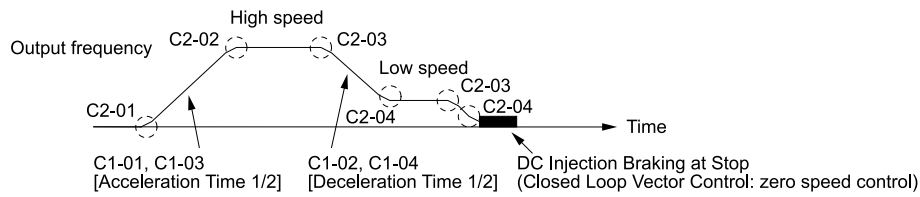

Figure 11.5 S-curve characteristics, Accel & Decel Time

Note:

- When shortened operation times are required, such as with cranes and hoists, do not use S-curve characteristics times.
- The default setting for C2-04 [S-Curve Time @ end of Decel] will be 0.00 seconds. The default setting for any other S-curve characteristics will be 0.20 seconds. Set the acceleration/deceleration times and S-curve characteristics time correctly for both timings of acceleration/deceleration startup and end. The suggested setting of the S-curve characteristics time is 0.2 to 1.0 seconds.
- When using the C1-11 [Accel/Decel Time Switchover Freq], the acceleration/deceleration rate can be switched automatically during acceleration/deceleration. The default setting will be disabled.
When the Output Frequency \geq C1-11, C1-01 and C1-02, operate at the acceleration and deceleration times
When the Output Frequency $<$ C1-11, C1-07 and C1-08, operate at the acceleration and deceleration times
- During low speed operation, if the Output Frequency $<$ E1-09 [Minimum Output Frequency] within the S-Curve Time @ start of Decel, the S-curve characteristics are canceled and the DC Inject Braking at Stop (zero speed control) is executed.

Dwell Function at Start

Adjustment parameter	Name
b6-01	Dwell Reference at Start
b6-02	Dwell Time at Start
H2-xx = 5	Frequency Detection 2

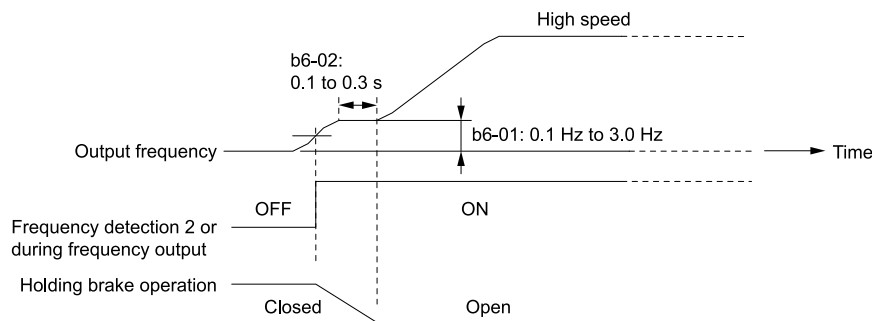

Figure 11.6 Dwell Function at Start

Note:

- When the mechanical operation of the holding brake is slow, to prevent brake grinding (friction), use the Dwell Function at Start. After the brake is completely open, accelerate.
- While in V/f Control and Open Loop Vector Control modes, set b6-01 [Dwell Reference at Start] higher than Frequency Detection 2 (brake open frequency).
- If the torque for the motor tends to be insufficient during startup, use the DC Inject Braking function to secure the motor current (torque) prior to starting the motor.
-b2-02 [DC Injection Braking Current] suggested setting: 50 to 80% (V/f Control, Open Loop Vector Control only)
-b2-03 [DC Inject Braking Time at Start] suggested setting: 0.2 s to 0.5 s

DC Injection Braking at Stop, Zero Speed Control Function

NOTICE: If regulations require that the motor and drive are disconnected when the elevator is stopped as in Europe, then make sure that the holding brake is completely closed and the drive is disconnected during baseblock (i.e., while the baseblock signal is ON). This does not apply to emergency situations. A voltage surge may trigger a fault in the drive if disconnected while it is controlling the motor or during DC Injection Braking (Zero speed level). Set L8-07 = 1 or 2 [Output Phase Loss Protect Select = 1PH Loss Det, 2/3PH Loss Det] if using an electromagnetic contactor between the drive and motor.

11.2 A: Initialization Parameters

Adjustment parameter	Name
b2-01	DC Injection/Zero SpeedThreshold
b2-02	DC Injection Braking Current
b2-04	DC Inject Braking Time at Stop
H2-xx = 5	Frequency Detection 2

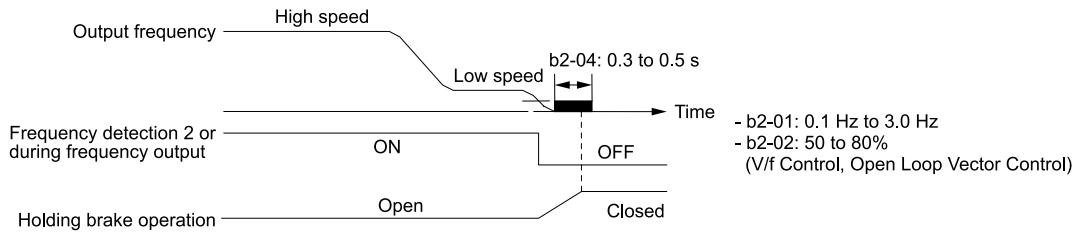

Figure 11.7 DC Injection Braking at Stop, Zero Speed Control Function

Note:

- When the mechanical operation of the holding brake is slow, to prevent rollback while the motor is stopped, DC Injection Braking (zero speed control when set to closed loop vector) should be performed until the brake is fully closed.
- While in V/f Control and Open Loop Vector Control modes, when the load cannot be held via DC Injection Braking while stopped, use Dwell Function at Stop.
 - b6-03 [Dwell Reference at Stop]: Minimum output frequency to 3.0 Hz
However, for conditions under which Frequency Detection 2 is OFF, it is less than L4-01 - L4-02 [Speed Agree Detection Level - Speed Agree Detection Width].
 - b6-04 [Dwell Time at Stop] suggested setting: 0.3 to 0.5 s
 - b2-04 [DC Inject Braking Time at Stop] suggested setting: 0.0 s

Torque Compensation (Torque Bias)

This function allows the shock from opening and closing the holding brake to be reduced by entering the torque compensation (torque bias) signal that matches a predefined load from the MFAI terminal while in Closed Loop Vector Control. Detection of the load and motoring/regeneration on the machine side must be done beforehand. If there is a polarity error, shock may increase in some circumstances.

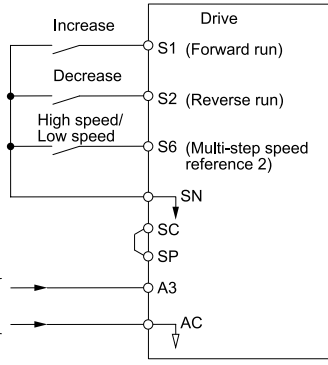
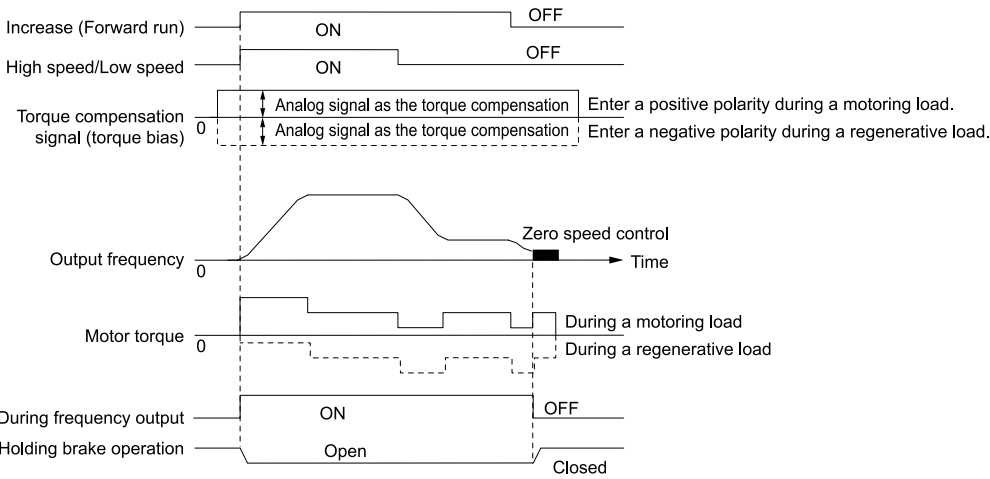
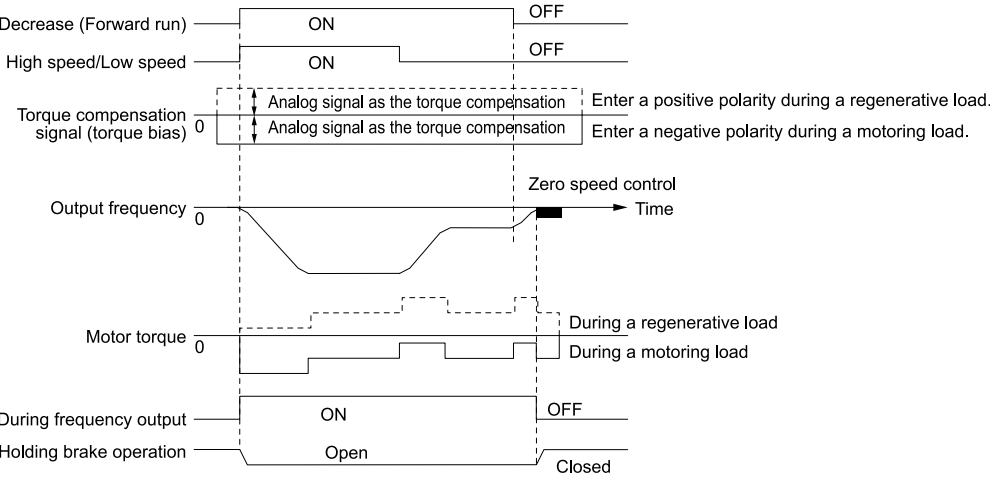
Item	Description
Sequence Circuit Configuration	 <p>H3-05 (Terminal A3 Signal Level Select) = 1 (-10 to +10 V) H3-06 (Terminal A3 Function Selection) = 14 [Torque Compensation (Torque Bias)] Fine tune by H3-07 and H3-08</p>
Time chart: Increase	<p>Enter the analog signal as the torque compensation (torque bias) signal in accordance with load amount prior to running the drive up till drive operation completes. The default setting is 10 V/100% torque.</p> <p>Enter a positive polarity during a motoring load, and enter a negative polarity during a regenerative load.</p> 
Time chart: Decrease	<p>In the same manner as an increase, enter the analog signal as the torque compensation (torque bias) signal in accordance with load amount before running the drive up to when it finishes running. The default setting is 10 V/100% torque.</p> <p>Enter a negative polarity during a motoring load, and enter a positive polarity during a regenerative load.</p> 

Note:

- Holds via an external source so that the torque compensation signal does not change during run. If the torque compensation signal is changed during run, the motor may produce oscillation.
- When motor reverse is set to the increase command and motor forward is set to the decrease command, the polarity of the torque compensation signal will reverse.

Analog Input Filter Time Constant

When setting $b1-01 = 1$ [Frequency Reference Selection 1 = Analog Input], noise is introduced into the analog frequency reference during run. If the ride quality of the elevator worsens, take the following measures.

11.2 A: Initialization Parameters

- Minimize the effects of noise.
- Change *H3-13 [Analog Input FilterTime Constant]* to a range of 0.01 s to 0.10 s.

Startup Current Check

When performing a test run, set *L8-41 = 1 [High Current Alarm Selection = Enabled]* and check the motor current during startup using *U4-13 [Peak Hold Current]* and a clamp ammeter with the machine under load and not under load.

When the motor torque is insufficient during startup and conversely when the motor keeps locking from the lack of timing between it and the holding brake, it causes extremely significant current to flow. Current flow where it exceeds 150% of the drive rated current may shorten the service life of parts due to heat stress placed on the IGBT in the drive. In such a case, readjust the parameters and decrease the load to reduce the current to less than 150%.

To reduce the effects of heat stress, decrease the carrier frequency of the drive to 2.0 kHz to 2.5 kHz for applications requiring low audible noise.

Overvoltage Suppression Function

If the overvoltage suppression function is used in elevator type applications, there is a risk of rollback and falls. Set *L3-11 = 0 [OV Suppression Function Select = Disabled]*.

The overvoltage suppression function is designed to prevent an overvoltage trip in a situation in which a braking resistor is not used with a regenerative load. If the overvoltage suppression function is enabled, the regeneration torque reference within the drive is automatically controlled during regeneration.

Note:

When using the drive for applications such as high speed elevators with a speed of 2 ms or more and direct drive elevators, or when you need drives designed for cranes, contact Yaskawa or your Yaskawa sales representative.

■ A1-07: DriveWorksEZ Function Selection

No. (Hex.)	Name	Description	Default (Range)
A1-07 (0128)	DriveWorksEZ Function Selection	V/f CL-V/f OLV CLV AOLV OLV/PM AOLV/PM CLV/PM EZOLV Sets the drive for operation with a program created in DriveWorksEZ.	0 (0 - 2)

DriveWorksEZ is a simple visual programming tool. DriveWorksEZ is a PC programming tool that lets the user connect function blocks to customize the drive and add PLC functions.

Note:

- DriveWorksEZ will overwrite drive settings when it uses the multi-function digital I/O and the multi-function analog I/O. Be aware that setting changes made using DriveWorksEZ will remain after DriveWorksEZ is disabled.
- For more information on DriveWorksEZ, contact Yaskawa or your nearest sales representative.

0 : DWEZ Disabled

1 : DWEZ Enabled

2 : Digital input

Set *H1-xx = 9F [MFDI Function Select = DriveWorksEZ Disable]*. Programs created with DriveWorksEZ are enabled when the digital input is OFF, and disabled when the terminal is ON.

■ A1-11: Firmware update lock

No. (Hex.)	Name	Description	Default Setting (Range)
A1-11 (111D)	Firmware update lock	V/f CL-V/f OLV CLV AOLV OLV/PM AOLV/PM CLV/PM EZOLV Enables and disables the firmware update function via cloud service.	0 (0, 1)

0 : Disable

The update function of the drive firmware is used.

1 : Enable

The update function of the drive firmware is not used.

◆ A2: User Parameters

Users can register frequently used parameters and recently changed parameters here for quick access. Registered parameters can be displayed in [User Parameters] under the main menu.

■ A2-01 to A2-32: User Parameters 1 to 32

No. (Hex.)	Name	Description	Default Setting (Range)
A2-01 to A2-32 (0106 - 0125)	User Parameters 1 to 32	<div style="display: flex; justify-content: space-between; font-size: 0.8em; font-weight: bold;"> V/f CL-V/f OLV CLV AOLV OLV/PM AOLV/PM CLV/PM EZOLV </div> <p>The user can select up to 32 parameters for the drive and assign them to parameters <i>A2-01 through A2-32</i>. Registered parameters can be displayed in [User Parameters] under the main menu. The user can immediately access necessary parameters.</p>	Parameters in General-Purpose Setup Mode (Determined by A1-07)

Note:

- Settings for *A2-01 to A2-32* vary depending on the value selected for *A1-06 [Application Preset]*.
- Users are only able to access parameters *A2-01 to A2-32* when *A1-01 = 1 [Access Level Selection = User Parameters]* is set.

The drive registers the following parameters to *A2-01 to A2-32*.

- The drive registers up to 32 parameters selected by the user.

Note:

Set *A1-01 = 2 [Advanced Level]* and register any parameter.

- The drive automatically registers any parameters that are changed to *A2-17 to A2-32*.

Note:

Set *A2-33 = 1 [User Parameter Auto Selection = Enabled]*.

■ A2-33: User Parameter Auto Selection

No. (Hex.)	Name	Description	Default (Range)
A2-33 (0126)	User Parameter Auto Selection	<div style="display: flex; justify-content: space-between; font-size: 0.8em; font-weight: bold;"> V/f CL-V/f OLV CLV AOLV OLV/PM AOLV/PM CLV/PM EZOLV </div> <p>Determines if the drive automatically saves the history of parameter changes to <i>A2-17 to A2-32 [User Parameters 17 to 32]</i>.</p>	Determined by A1-06 (0, 1)

0 : Disabled

The user manually registers parameters to the User Parameters.

1 : Enabled

The drive automatically registers any parameters that are changed to *A2-17 to A2-32*. The drive automatically saves the most recently changed parameter to *A2-17*, and saves a maximum of 16 parameters. Once 16 parameters have been registered, the drive will start to remove old parameters from the User Parameter list.

Registered parameters can be displayed in [User Parameters] under the main menu.

Note:

In General-Purpose Setup Mode, the drive registers parameters starting from *A2-27* since parameters up to *A2-26* are already registered by default.

11.3 b: Application

b parameters set the following functions.

- Frequency reference source/Run command source
- Stopping method settings
- DC Injection Braking
- Speed Search
- Timer Function
- PID control
- Dwell function
- Droop control
- Energy Savings Control
- Zero Servo Control

◆ b1: Operation Mode Selection

b1 parameters set the operation mode for the drive.

■ b1-01: Frequency Reference Selection 1

No. (Hex.)	Name	Description	Default (Range)
b1-01 (0180)	Frequency Reference Selection 1	V/f CL-V/f OLV CLV AOLV OLV/PM AOLV/PM CLV/PM EZOLV Selects frequency reference input method.	1 (0 - 4)

Note:

- Set the input mode to LOCAL by pressing LO/RE on the keypad to enter the frequency reference from the keypad.
- The RUN light on the keypad will flash if the Run command is entered when the frequency reference is 0 Hz or below the value set in *E1-09* [Minimum Output Frequency]. Check the setting for the frequency reference input and enter a value greater than or equal to what is set in *E1-09*.

0 : Keypad

Use the keypad to enter the frequency reference.

The frequency reference can be changed by using the ▲ and ▼ on the keypad.

1 : Analog Input

Use the multi-function analog input terminals A1, A2, and A3 to input an analog frequency reference with a voltage or current input signal.

• Voltage Input

Refer to the following table when using a voltage signal input to one of the multi-function analog input terminals.

Table 11.19 Frequency Reference Voltage Input

Terminal	Terminal Signal Level	Parameter Settings				Note
		Signal Level Selection	Function Selection	Gain	Bias	
A1	0 - 10 V	H3-01 = 0	H3-02 = 0	H3-03	H3-04	Set DIP switch S1-1 to "V" for voltage input.
	-10 - 10 V	H3-01 = 1	[Frequency Bias]			
A2	0 - 10 V	H3-09 = 0	H3-10 = 0	H3-11	H3-12	Set DIP switch S1-2 to "V" for voltage input.
	-10 - 10 V	H3-09 = 1	[Frequency Bias]			
A3	0 - 10 V	H3-05 = 0	H3-06 = 0	H3-07	H3-08	Set DIP switch S1-3 to "V" for voltage input. Set DIP switch S4 to "AI" for analog input.
	-10 - 10 V	H3-05 = 1	[Frequency Bias]			

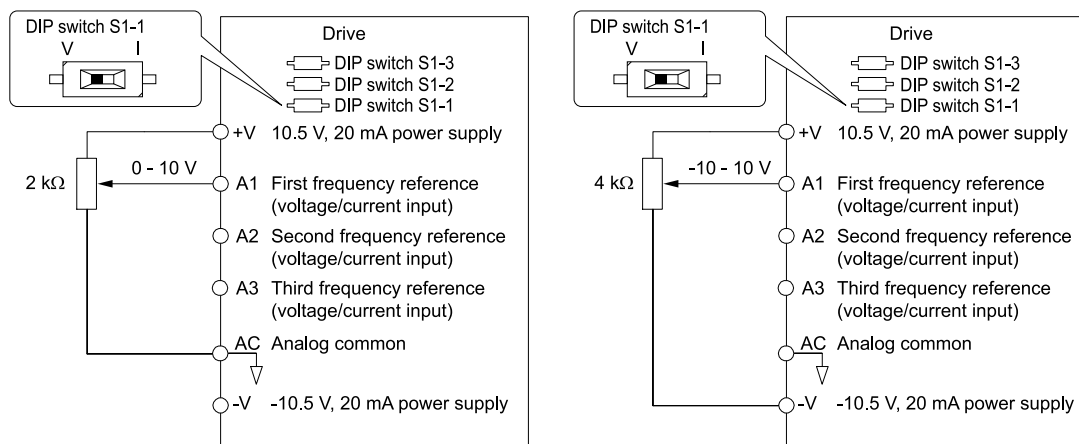

Figure 11.8 Example of Setting the Frequency Reference with a Voltage Signal to Terminal A1

Note:

Use this diagram also when wiring terminals A2 and A3.

• **Current Input**

Refer to the following table when using a current signal input to one of the multi-function analog input terminals.

Terminal	Signal Level	Parameter Settings				Note
		Signal Level Selection	Function Selection	Gain	Bias	
A1	4 - 20 mA	H3-01 = 2	H3-02 = 0 [Frequency Bias]	H3-03	H3-04	Set DIP switch S1-1 to "I" for current input.
	0 - 20 mA	H3-01 = 3				
A2	4 - 20 mA	H3-09 = 2	H3-10 = 0 [Frequency Bias]	H3-11	H3-12	Set DIP switch S1-2 to "I" for current input.
	0 - 20 mA	H3-09 = 3				
A3	4 - 20 mA	H3-05 = 2	H3-06 = 0 [Frequency Bias]	H3-07	H3-08	Set DIP switch S1-3 to "I" for current input. Set DIP switch S4 to "AI" for analog input.
	0 - 20 mA	H3-05 = 3				

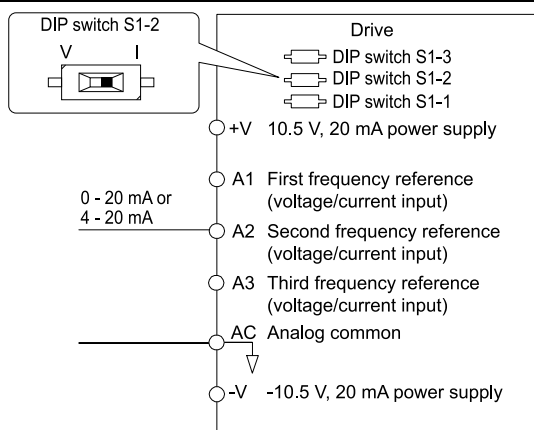

Figure 11.9 Example of Setting the Frequency Reference with a Current Signal to Terminal A2

Note:

Use this diagram also when wiring terminals A1 and A3.

Switching between master/auxiliary frequency references

The user can switch frequency reference input between terminals A1, A2, and A3 using the multi-step speed reference function.

2 : Memobus/Modbus Communications

Enter the frequency reference by using MEMOBUS/Modbus communications.

3 : Option PCB

Use a communications option card or input option card connected to the drive to enter the frequency reference.

11.3 b: Application

Refer to the instruction manual included with the option card for installing and setting the option card.

Note:

If $b1-01 = 3$ is set and an option card is not connected, then $oPE05$ [Run Cmd/Freq Ref Source Sel Err] will flash on the keypad.

4 : Pulse train input

Use a pulse train signal from the pulse train input terminal RP to enter the frequency reference.

Follow the procedure below to make sure that the pulse train signal is functioning properly.

1. Set $b1-01 = 4$, $H6-01 = 0$ [PulseTrain InTerm RP Func Select = Frequency reference].
2. Set $H6-02$ [Pulse Train Input Scaling] to the number of pulses that determine 100% of the frequency reference.
3. Enter a pulse train signal on the terminal RP and make sure that the keypad shows a correct frequency reference.

■ b1-02: Run Command Selection 1

No. (Hex.)	Name	Description	Default Setting (Range)
b1-02 (0181)	Run Command Selection 1	 Selects the Run command input method.	1 (0 - 3)

0 : Keypad

Use the keypad to enter the Run command.

The user can execute the JOG operation or the FWD/REV commands from the keypad.

Note:

The LO/RE light will light when the Run command source is set to the keypad.

1 : Digital Input

Use the control circuit terminals to enter the Run command. Select the input method for the Run command using a parameter. Set $H1-xx = 0, 40$ to 43 [3-Wire Sequence, Run Command (2-Wire Sequence)]. The default setting is 2-wire sequence 1.

- 2-wire Sequence 1

This sequence allows for two types of input: FWD/Stop and REV/Stop. Setting $A1-03 = 2220$ [Initialize Parameters = 2-Wire initialization] and initializing the drive sets terminals S1 and S2 for a 2-wire sequence.

- 2-wire Sequence 2

This sequence allows for two types of input: Run/Stop and FWD/REV.

- 3-Wire Sequence

This sequence allows for three types of input: Run, Stop, and FWD/REV. Setting $A1-03 = 3330$ [Initialize Parameters = 3-Wire initialization] and initializing the drive sets terminals S1, S2, and S5 for a 3-wire sequence.

2 : Memobus/Modbus Communications

Enter the Run command by using MEMOBUS/Modbus communications.

3 : Option PCB

Use a communications option card or input option card connected to the drive to enter the Run command.

Refer to the instruction manual included with the option card for installation and communications settings.

Note:

If $b1-02 = 3$ is set and an option card is not connected, then $oPE05$ [Run Cmd/Freq Ref Source Sel Err] will flash on the keypad.

■ b1-03: Stopping Method Selection

No. (Hex.)	Name	Description	Default Setting (Range)
b1-03 (0182)	Stopping Method Selection	 Selects how the drive stops the motor after removing a Run command or entering a Stop command.	0 (0 - 3)

Note:

The setting range is 0, 1, and 3 when $A1-02 = 3, 4, 5, 6, 7,$ or 8 [Control Method Selection = Closed Loop Vector Control, Advanced OpenLoop Vector Control, PM Open Loop Vector Control, PM Advanced Open Loop Vector, PM Closed Loop Vector Control, or EZ Open Loop Vector Control].

Select the appropriate stopping method for the application from the following four options.

0 : Ramp to Stop

The drive decelerates the motor to stop when the Stop command is entered (or when the Run command is switched OFF).

The drive ramps the motor to stop according to the deceleration time. The default setting for the deceleration time is *C1-02 [Deceleration Time 1]*. The actual deceleration time will vary depending on load conditions, such as mechanical loss and inertia.

If the output frequency falls below or is equal to the value set in *b2-01 [DC Injection/Zero Speed Threshold]* during deceleration, then the drive will perform DC Injection Braking, Zero Speed Control, or Short Circuit Braking, depending on the control mode.

- **Ramp to stop with V/f control, Advanced Open Loop Vector Control, Closed Loop V/f Control, Open Loop Vector Control Mode**

Parameter *b2-01* sets the frequency to begin DC Injection Braking at stop. If the output frequency falls below or is equal to the value set in *b2-01* during deceleration, then the drive will perform DC Injection Braking for the time set in *b2-04 [DC Inject Braking Time at Stop]*.

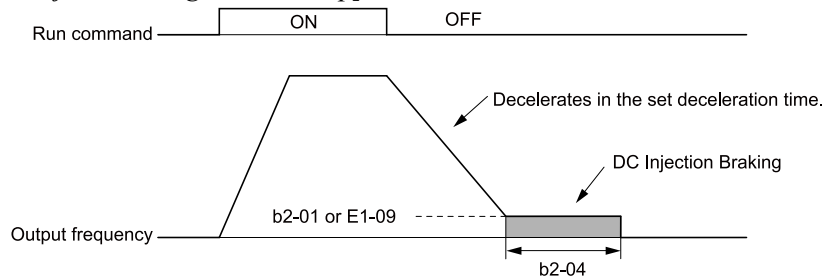

Figure 11.10 Ramping to Stop in V/f, CL-V/f, or OLV

Note:

The drive will begin DC Injection Braking from the frequency set in *E1-09 [Minimum Output Frequency]* if $b2-01 \leq E1-09$.

- **Ramp to stop with Closed Loop Vector Control for PM, Advanced Open Loop Vector Control for PM, and EZ Open Loop Vector Control Mode**

Parameter *b2-01* sets the frequency to begin Short Circuit Braking. If the output frequency falls below or is equal to the value set in *b2-01* during deceleration, then the drive will perform Short Circuit Braking for the time set in *b2-13 [Short Circuit Brake Time @ Start]*. If $b2-04 \neq 0$, then the drive will perform DC Injection Braking for the time set in *b2-04* once Short Circuit Braking is complete.

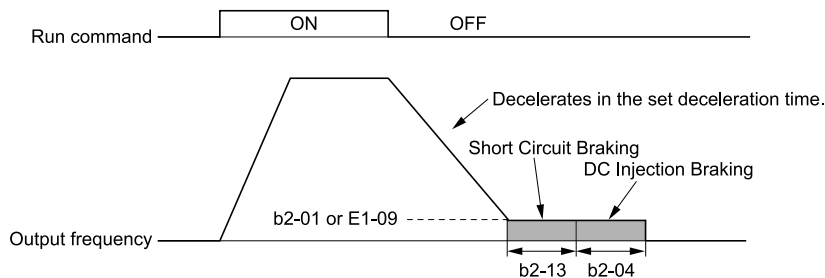

Figure 11.11 Ramp to Stop with Open Loop Vector Control for PM, Advanced Open Loop Vector Control for PM, and EZ Open Loop Vector Control Mode

Note:

The drive will begin Short Circuit Braking from the frequency set in *E1-09 [Minimum Output Frequency]* if $b2-01 \leq E1-09$.

The drive will not perform Short Circuit Braking if $b2-01 = 0$ Hz and $E1-09 = 0$ Hz.

- **Ramping to Stop in Closed Loop Vector Control or Closed Loop Vector Control for PM**

Parameter *b2-01* sets the frequency to begin Zero Speed Control at stop. If the output frequency falls below or is equal to the value set in *b2-01* during deceleration, then the drive will perform Zero Speed Control for the time set in *b2-04*.

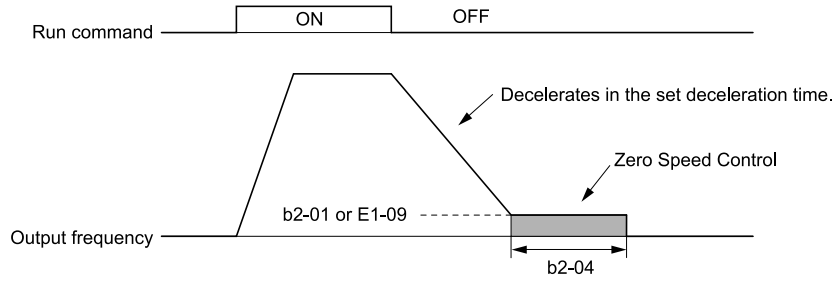

Figure 11.12 Ramping to Stop in CLV or CLV/PM

Note:

The drive will begin Zero Speed Control from the frequency set in *E1-09* [Minimum Output Frequency] if $b2-01 \leq E1-09$.

1 : Coast to Stop

The drive shuts OFF its output when the Stop command is entered (or when the Run command is switched OFF). Motor coasts to stop.

Load conditions such as mechanical loss and inertia determine the deceleration rate as the motor coasts to stop.

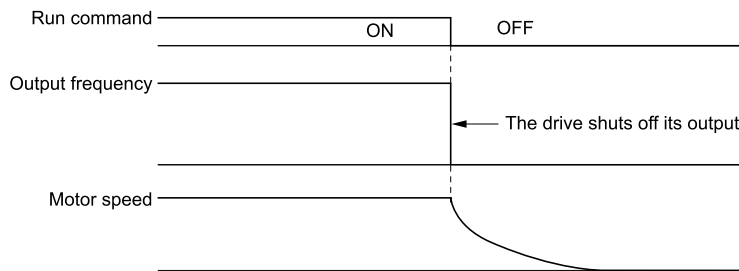

Figure 11.13 Coast to Stop

Note:

The drive disregards the Run command for the time set in *L2-03* [Momentary Power Loss Min BB Time] when the Stop command is entered (or when the Run command is switched OFF). Do not enter the Run command until the motor comes to a complete stop. Use DC Injection or Speed Search to restart the motor before it stops.

2 : DC Injection Braking to Stop

The drive shuts off its output for the time set in *L2-03* when the Stop command is entered (or when the Run command is switched OFF). Once the minimum baseblock time has passed, the drive then injects the amount of DC current into the motor that is set in *b2-02* [DC Injection Braking Current], stopping the motor with DC current.

DC Injection Braking stops the motor more quickly than coasting to stop.

Note:

DC Injection Braking to Stop is not available if *A1-02* = 3, 4, 5, 6, or 7.

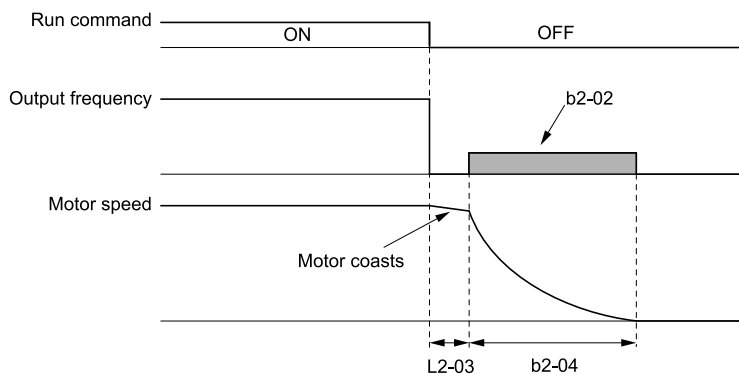

Figure 11.14 DC Injection Braking to Stop

The value set in *b2-04* and the output frequency when the Stop command is entered determine the DC Injection Braking time. The drive calculates the DC Injection Braking time as follows.

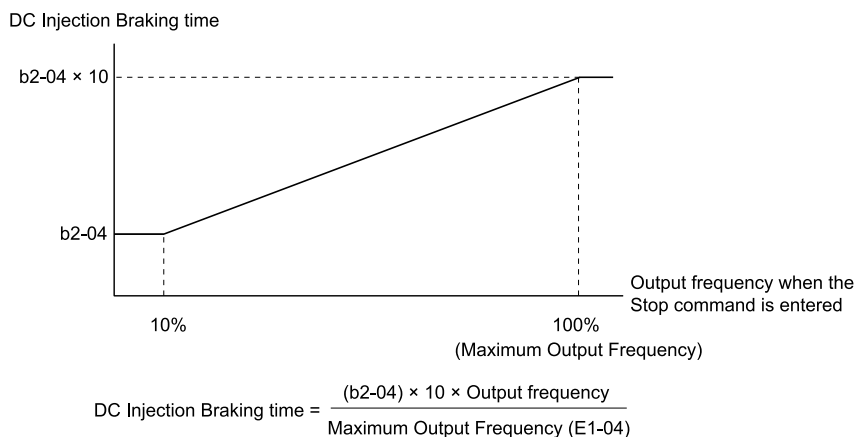

Figure 11.15 DC Injection Braking Time and Output Frequency

Note:

Set L2-03 to a high enough value so that *oC* [Overcurrent] is not triggered when using DC Injection Braking to stop the motor.

3 : Coast-to-Stop with Timer

The drive shuts off its output when the Stop command is entered (or when the Run command is switched OFF). Motor coasts to stop. The drive ignores the Run command until the “Run wait time” *t* has passed.

To start the drive again, re-enter the Run command once the “Run wait time” *t* has passed.

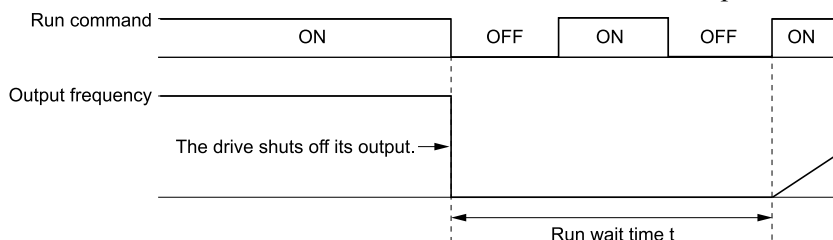

Figure 11.16 Coast-to-Stop with Timer

The active deceleration time and the output frequency when the Stop command is entered determine the length of “Run wait time” *t*.

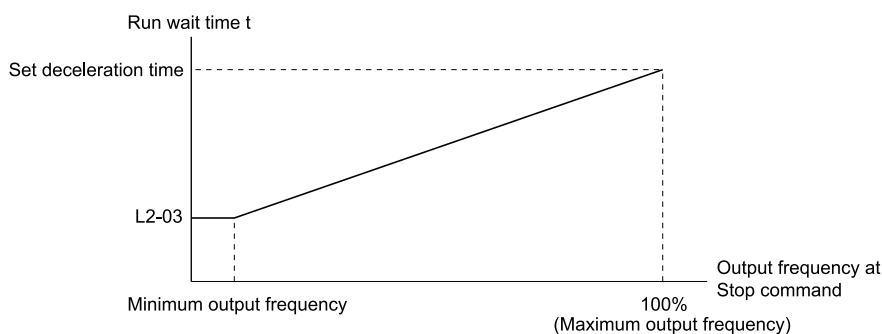

Figure 11.17 Run Wait Time and Output Frequency

■ b1-04: Reverse Operation Selection

No. (Hex.)	Name	Description	Default (Range)
b1-04 (0183)	Reverse Operation Selection	<div style="display: flex; gap: 5px;"> V/f CL-V/f OLV CLV AOLV OLV/PM AOLV/PM CLV/PM EZOLV </div> <p>Enables and disables reverse operation. Used in applications such as fans or pumps where reverse motor rotation is potentially problematic.</p>	0 (0, 1)

The drive does not accept the Reverse operation command when reverse operation is prohibited.

0 : Reverse enabled

The drive accepts the Reverse operation command.

1 : Reverse disabled

The drive disregards the Reverse operation command.

■ b1-05: Operation Below Minimum Freq

No. (Hex.)	Name	Description	Default Setting (Range)
b1-05 (0184)	Operation Below Minimum Freq	<div style="display: flex; justify-content: space-between; font-size: small;"> V/f CL-V/f OLV CLV AOLV OLV/PM AOLV/PM CLV/PM EZOLV </div> Sets the operation to perform when the frequency reference falls below the value set in E1-09 [Minimum Output Frequency].	0 (0 - 3)

0 : Operate at frequency reference

The drive operates the motor according to the frequency reference, even if the frequency reference falls below the value set in E1-09.

If the motor speed falls below or is equal to the value set in b2-01 [DC Injection/Zero SpeedThreshold] after the Stop command is entered (or the Run command is switched OFF), then the drive will perform Zero Speed Control for the time set in b2-04 [DC Inject Braking Time at Stop] before shutting off its output.

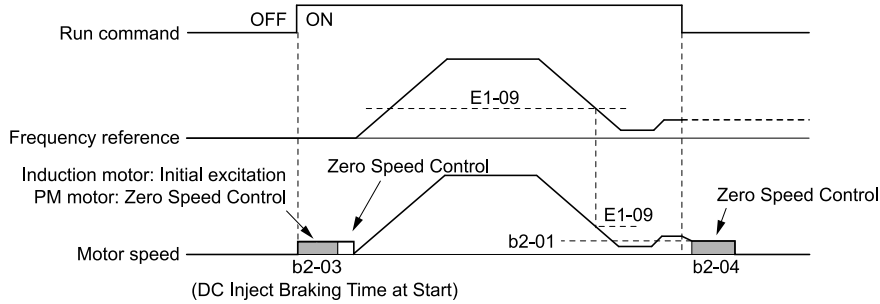

Figure 11.18 Operate at the Frequency Reference

1 : Baseblock (motor coasts)

The drive shuts off its output and the motor coasts to stop when the frequency reference falls below the value set in E1-09. If the motor speed falls below or is equal to the value set in b2-01, then the drive will perform Zero Speed Control for the time set in b2-04.

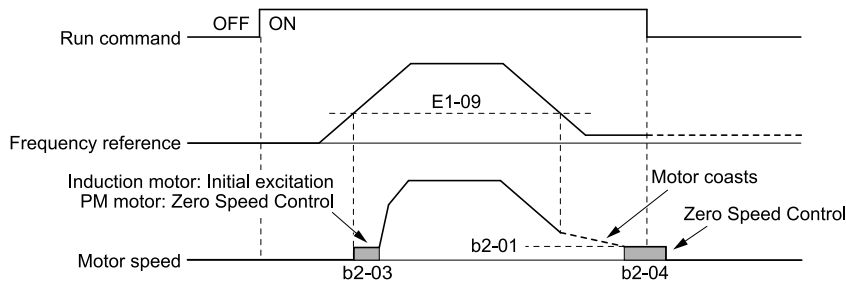

Figure 11.19 Baseblock (Motor Coasts)

2 : Operate at minimum frequency

The drive operates the motor at the minimum frequency reference set in E1-09 when the frequency reference falls below the value set in E1-09 and the Run command is still enabled.

The drive decelerates the motor when the Stop command is entered (or when the Run command is switched OFF). If the motor speed falls below or is equal to the value set in b2-01, then the drive will perform Zero Speed Control for the time set in b2-04.

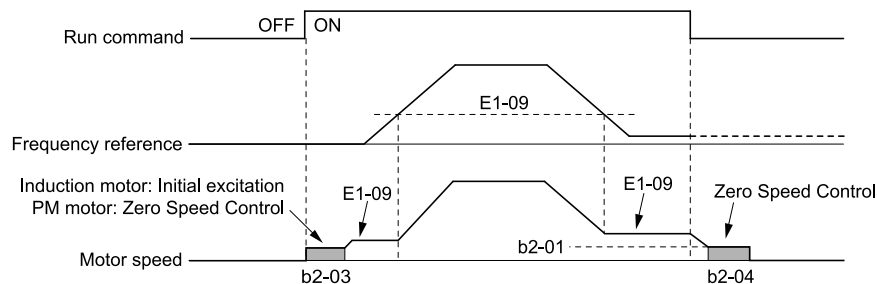

Figure 11.20 Operate at Minimum Frequency

3 : Operate at zero speed

The drive performs Zero Speed Control when the frequency reference falls below the value set in E1-09.

The drive performs Zero Speed Control again for the time set in *b2-04* when the Stop command is entered (or when the Run command is switched OFF).

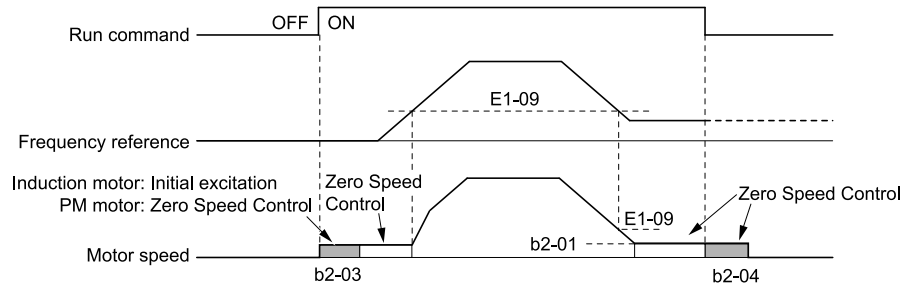

Figure 11.21 Operate at Zero Speed

■ b1-06: Digital Input Reading

No. (Hex.)	Name	Description	Default (Range)
b1-06 (0158)	Digital Input Reading	<input type="checkbox"/> V/f <input type="checkbox"/> CL-V/f <input type="checkbox"/> OLV <input type="checkbox"/> CLV <input type="checkbox"/> AOLV <input type="checkbox"/> OLV/PM <input type="checkbox"/> AOLV/PM <input type="checkbox"/> CLV/PM <input type="checkbox"/> EZOLV Selects if the drive should read the sequence input (FWD/REV, multi-function input) command once or twice to prevent problems from noise.	1 (0, 1)

0 : Input status is read once

Reads the state of the terminal once. Any changes to the state of the terminals are read immediately.

The drive can respond more quickly to changes in the sequence, but there may be problems due to noise.

1 : Input status is read twice

Reads the state of the terminal twice. Any changes to the state of the terminals are read twice to make sure the reading is the same.

The drive is less responsive compared to reading the sequence once, but this prevents problems caused by noise.

■ b1-07: LOCAL/REMOTE Run Selection

No. (Hex.)	Name	Description	Default (Range)
b1-07 (0186)	LOCAL/REMOTE Run Selection	<input type="checkbox"/> V/f <input type="checkbox"/> CL-V/f <input type="checkbox"/> OLV <input type="checkbox"/> CLV <input type="checkbox"/> AOLV <input type="checkbox"/> OLV/PM <input type="checkbox"/> AOLV/PM <input type="checkbox"/> CLV/PM <input type="checkbox"/> EZOLV When switching from LOCAL to REMOTE, or between External reference 1 and External reference 2, the Run command may already be present at the location to which the source is being switched. In this case, use parameter b1-07 to determine how the Run command is treated.	0 (0, 1)

This parameter interlocks the drive, preventing accidents that might otherwise occur from the motor suddenly rotating when switching the source of the Run command.

Press **LORE** on the keypad or set *H1-xx = 1, 2* [*MFDI Function Select = LOCAL/REMOTE Selection, External reference 1/2 Selection*] and turn the terminal ON/OFF to switch the RUN command source.

0 : Cycle existing RUN command

The drive will not operate the motor even if a Run command is already enabled when switching between Run command sources.

If the drive is already operating the motor, then shut the Run command OFF to stop the motor. Re-enter the Run command to begin operation again.

1 : Accept existing RUN command

The drive will begin operating the motor if a Run command is already enabled when switching between Run command sources.

The drive will continue operating the motor if it is already doing so.

WARNING! Sudden Movement Hazard. When using a 3-Wire sequence, set the drive to 3-Wire sequence and set *b1-17 = 0* [*Run Command at Power Up = Disregard Existing RUN Command*] before wiring the control terminals so the drive will not accept a Run command at power up. The motor may rotate in reverse when the drive is powered up if the drive is wired for a 3-wire sequence but set up for a 2-wire sequence (default) and *b1-17 = 1* [*Accept Existing RUN Command*]. Failure to comply could cause death or serious injury from moving equipment.

■ b1-08: Run Command Select in PRG Mode

No. (Hex.)	Name	Description	Default (Range)
b1-08 (0187)	Run Command Select in PRG Mode	<p>Sets the conditions for the drive to accept a Run command entered from an external source when using the keypad to set parameters.</p>	0 (0 - 2)

For safety purposes, the default setting is to disregard the Run command while in the Programming Mode.

This parameter prevents accidents that might otherwise occur from the motor suddenly rotating when the Run command is entered from an external source while the user is programming the drive. The user can also set the drive so that the keypad won't display the Programming Mode as long as the Run command is active.

Note:

The Programming Mode has the following modes.

- Verify Menu
- Setup Mode
- Parameter Settings Mode
- Auto-Tuning Mode

0 : Do not accept RUN at Programming

The drive does not accept the Run command while in the Programming Mode.

1 : Accept RUN while Programming

The drive accepts a Run command entered from an external source while in the Programming Mode.

2 : Allow Programming only at Stop

The drive does not allow the user to enter the Programming Mode while the Run command is enabled. The keypad does not display the Programming Mode while the Run command is enabled.

■ b1-14: Phase Order Selection

No. (Hex.)	Name	Description	Default Setting (Range)
b1-14 (01C3)	Phase Order Selection	<p>Sets the phase order for output terminals U/T1, V/T2, and W/T3. This parameter is useful for making sure the Forward Run command from the drive and the forward direction of the motor match, without needing to change any wiring.</p>	0 (0, 1)

0 : Standard

1 : Switch phase order

■ b1-15: Frequency Reference Selection 2

No. (Hex.)	Name	Description	Default (Range)
b1-15 (01C4)	Frequency Reference Selection 2	<p>Selects the input method for frequency reference 2.</p>	0 (0 - 4)

Enabled when $HI-xx = 2$ [*MFDI Function Select = External Reference 1/2 Selection*] is set and switched ON.

Note:

- Set the input mode to LOCAL by pressing on the keypad to enter the frequency reference from the keypad.
- The RUN light on the keypad will flash if the Run command is entered when the frequency reference is 0 Hz or equal to or below the value set in *E1-09* [*Minimum Output Frequency*]. Check the setting for the frequency reference input and enter a value greater than or equal to what is set in *E1-09*.

0 : Keypad

Use the keypad to enter the frequency reference.

Change the frequency reference by using and on the keypad.

1 : Analog Input

Use the multi-function analog input terminals A1, A2, and A3 to input an analog frequency reference with a voltage or current input signal.

- **Voltage Input**

Refer to the following table when using a voltage signal input to one of the multi-function analog input terminals.

Table 11.20 Frequency Reference Voltage Input

Terminal	Terminal Signal Level	Parameter Settings				Note
		Signal Level Selection	Function Selection	Gain	Bias	
A1	0 - 10 V	H3-01 = 0	H3-02 = 0 [Frequency Bias]	H3-03	H3-04	Set DIP switch S1-1 to "V" for voltage input.
	-10 - +10 V	H3-01 = 1				
A2	0 - 10 V	H3-09 = 0	H3-10 = 0 [Frequency Bias]	H3-11	H3-12	Set DIP switch S1-2 to "V" for voltage input.
	-10 - +10 V	H3-09 = 1				
A3	0 - 10 V	H3-05 = 0	H3-06 = 0 [Frequency Bias]	H3-07	H3-08	Set DIP switch S1-3 to "V" for voltage input. Set DIP switch S4 to "AI" for analog input.
	-10 - +10 V	H3-05 = 1				

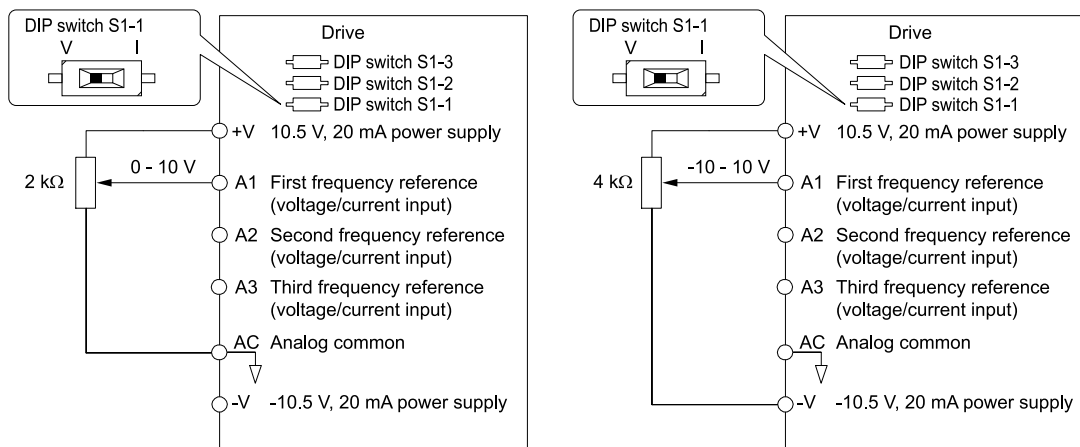

Figure 11.22 Example of Setting the Frequency Reference with a Voltage Signal to Terminal A1

Note:

Use this diagram also when wiring terminals A2 and A3.

• **Current Input**

Refer to the following table when using a current signal input to one of the multi-function analog input terminals.

Terminal	Signal Level	Parameter Settings				Note
		Signal Level Selection	Function Selection	Gain	Bias	
A1	4 - 20 mA	H3-01 = 2	H3-02 = 0 [Frequency Bias]	H3-03	H3-04	Set DIP switch S1-1 to "I" for current input.
	0 - 20 mA	H3-01 = 3				
A2	4 - 20 mA	H3-09 = 2	H3-10 = 0 [Frequency Bias]	H3-11	H3-12	Set DIP switch S1-2 to "I" for current input.
	0 - 20 mA	H3-09 = 3				
A3	4 - 20 mA	H3-05 = 2	H3-06 = 0 [Frequency Bias]	H3-07	H3-08	Set DIP switch S1-3 to "I" for current input. Set DIP switch S4 to "AI" for analog input.
	0 - 20 mA	H3-05 = 3				

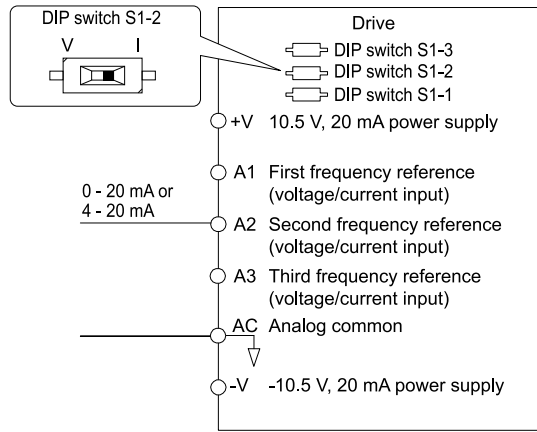

Figure 11.23 Example of Setting the Frequency Reference with a Current Signal to Terminal A2

Note:

Use this diagram also when wiring terminals A1 and A3.

Switching between master/auxiliary frequency references

The user can switch frequency reference input between terminals A1, A2, and A3 using the multi-step speed reference function.

2 : Memobus/Modbus Communications

Enter the frequency reference by using MEMOBUS/Modbus communications.

3 : Option PCB

Use a communications option card or input option card connected to the drive to enter the frequency reference. Refer to the instruction manual included with the option card for installing and setting the option card.

Note:

If $b1-01 = 3$ is set and an option card is not connected, then $oPE05$ [Run Cmd/Freq Ref Source Sel Err] will flash on the keypad.

4 : Pulse Train Input

Use a pulse train signal from the pulse train input terminal RP to enter the frequency reference.

Follow the procedure below to make sure that the pulse train signal is functioning properly.

1. Set $b1-01 = 4$, $H6-01 = 0$ [PulseTrain InTerm RP Func Select = Frequency reference].
2. Set $H6-02$ [Pulse Train Input Scaling] to the number of pulses that determine 100% of the frequency reference.
3. Enter a pulse train signal on the terminal RP and make sure that the keypad shows a correct frequency reference.

■ b1-16: Run Command Selection 2

No. (Hex.)	Name	Description	Default (Range)
b1-16 (01C5)	Run Command Selection 2	<div style="display: flex; justify-content: space-between; align-items: center;"> <input type="checkbox"/> V/f <input type="checkbox"/> CL-V/f <input type="checkbox"/> OLV <input type="checkbox"/> CLV <input type="checkbox"/> AOLV <input type="checkbox"/> OLV/IPM <input type="checkbox"/> AOLV/IPM <input type="checkbox"/> CLV/IPM <input type="checkbox"/> EZOLV </div> <p>Sets the input method for Run Command 2 when changing the source of the Run command by switching the control circuit terminals ON/OFF.</p>	0 (0 - 3)

Enabled when $H1-xx = 2$ [MFDI Function Select = External Reference 1/2 Selection] is set and switched ON.

0 : Keypad

Use the keypad to enter the Run command.

The user can execute the JOG operation or the FWD/REV commands from the keypad.

Note:

The LO/RE light will light when the Run command source is set to the keypad.

1 : Analog Input

Use the control circuit terminals to enter the Run command. Input method for the Run command is determined by the sequence.

- 2-wire Sequence 1

This sequence allows for two types of input: FWD/Stop and REV/Stop. Setting $A1-03 = 2220$ [Initialize Parameters = 2-Wire initialization] and initializing the drive sets terminals S1 and S2 for a 2-wire sequence.

- 2-wire Sequence 2
This sequence allows for two types of input: Run/Stop and FWD/REV.
- 3-Wire Sequence
This sequence allows for three types of input: Run, Stop, and FWD/REV. Setting $A1-03 = 3330$ [Initialize Parameters = 3-Wire initialization] and initializing the drive sets terminals S1, S2, and S5 for a 3-wire sequence.

2 : Memobus/Modbus Communications

Enter the Run command by using MEMOBUS/Modbus communications, which comes standard with the drive.

3 : Option PCB

Use a communications option card or input option card connected to the drive to enter the Run command. Refer to the instruction manual included with the option card for installation and communications settings.

Note:

If $b1-02 = 3$ is set and an option card is not connected, then $oPE05$ [Run Cmd/Freq Ref Source Sel Err] will flash on the keypad.

■ b1-17: Run Command at Power Up

No. (Hex.)	Name	Description	Default (Range)
b1-17 (01C6)	Run Command at Power Up	<div style="display: flex; justify-content: space-between; font-size: small;"> V/f CL-V/f OLV CLV AOLV OLV/PM AOLV/PM CLV/PM EZOLV </div> Selects what action to take when the power supply is switched ON and the Run command is input from an external source. It is necessary to set this parameter in applications where the Run command is already enabled when the power supply switches ON/OFF.	0 (0, 1)

0 : Disregard existing RUN command

The drive does not start operating the application when the power is switched ON, even if the Run command is already enabled.

Re-enter the Run command to have the drive operate the application.

Note:

For safety, the drive is set so that it will not start operating the application when the power is switched ON, even if the Run command is

already enabled. The  light on the keypad will flash quickly if the Run command is already enabled from an external source when the power is switched ON.

1 : Accept existing RUN command

The drive starts operating the application when the power is switched ON if the Run command is already enabled.

WARNING! Sudden Movement Hazard. When using a 3-Wire sequence, set the drive to 3-Wire sequence and set $b1-17 = 0$ [Run Command at Power Up = Disregard Existing RUN Command] before wiring the control terminals so the drive will not accept a Run command at power up. The motor may rotate in reverse when the drive is powered up if the drive is wired for a 3-wire sequence but set up for a 2-wire sequence (default) and $b1-17 = 1$ [Accept Existing RUN Command]. Failure to comply could cause death or serious injury from moving equipment.

■ b1-21: CLV Start Selection

No. (Hex.)	Name	Description	Default Setting (Range)
b1-21 (0748)	CLV Start Selection	<div style="display: flex; justify-content: space-between; font-size: small;"> V/f CL-V/f OLV CLV AOLV OLV/PM AOLV/PM CLV/PM EZOLV </div> Selects the condition used to accept the Run command when $A1-02 = 3$ or 7 [Control Method Selection = Closed Loop Vector Control or PM Closed Loop Vector Control]. Normally there is no need to change this setting.	0 (0, 1)

0 : Reject Run if $b2-01 < Nfdbk < E1-09$

The Run command input is not accepted when the motor speed is at least the setting value of $b2-01$ or less than the setting value of $E1-09$.

1 : Accept Run command at any speed

The Run command input is accepted when the motor speed is at least the setting value of $b2-01$ or less than the setting value of $E1-09$.

■ **b1-35: Multi-Function DI dead band time**

No. (Hex.)	Name	Description	Default Setting (Range)
b1-35 (1117)	Multi-Function DI dead band time	V/f CL-V/f OLV CLV AOLV OLV/PM AOLV/PM CLV/PM EZOLV Sets the dead band time for multi-function digital inputs.	0.0 ms (0.0 to 100.0 ms)

The multi-function digital input is enabled when the on/off time for multi-function digital inputs is longer than the time set in *b1-35*. Set this parameter to prevent malfunctions caused by relay chattering for applications in which multi-function digital input terminals receive input via relays.

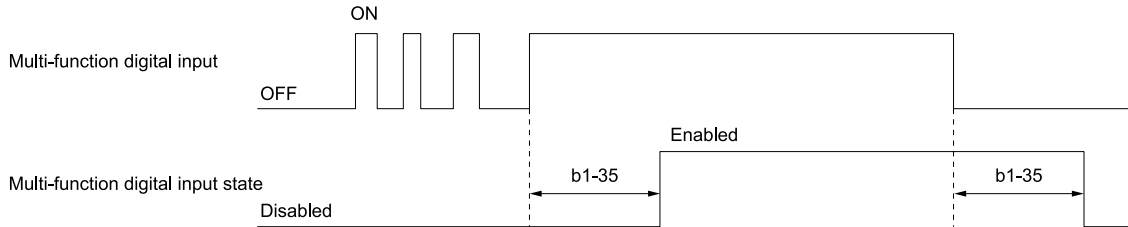

◆ **b2: DC Injection Braking and Short Circuit Braking**

b2 parameters set the DC Injection Braking and Short Circuit Braking functions.

- DC Injection Braking: A braking method that injects DC current into the motor windings. This function should not be used too frequently, because it generates a fair amount of heat in the motor.
- Short Circuit Braking: A braking method for PM motors.

■ **b2-01: DC Injection/Zero SpeedThreshold**

No. (Hex.)	Name	Description	Default Setting (Range)
b2-01 (0189)	DC Injection/Zero SpeedThreshold	V/f CL-V/f OLV CLV AOLV OLV/PM AOLV/PM CLV/PM EZOLV Sets the frequency to begin DC Injection Braking, Short Circuit Braking, and Zero Servo.	Determined by A1-02 (0.0 - 10.0 Hz)

Note:

This parameter is available when *b1-03* = 0 [Stopping Method Selection = Ramp to Stop].

The function triggered by *b2-01* depends on the control mode that has been selected with *A1-02* [Control Method Selection].

- When *A1-02* = 0, 1, 2, or 4 [V/f Control, Closed Loop V/f Control, Open Loop Vector Control, or Advanced Open Loop Vector Control] and *n4-72* = 0 [PG Mode = Without PG]
 For these control modes, *b2-01* sets the starting frequency for DC Injection Braking at Stop. If the output frequency falls below or is equal to the value set in *b2-01*, then the drive will inject the amount of DC current set in *b2-02* [DC Injection Braking Current] into the motor for the time set in *b2-04* [DC Inject Braking Time at Stop].

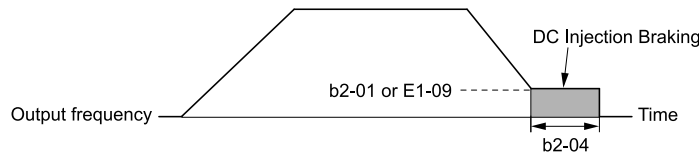

Figure 11.24 DC Injection Braking at Stop

Note:

The drive will begin DC Injection Braking from the frequency set in *E1-09* [Minimum Output Frequency] if *b2-01* is set to a value lower than or equal to what is set in *E1-09*.

- When *A1-02* = 5, 6, or 8 [PM Open Loop Vector Control, PM Advanced Open Loop Vector, or EZ Open Loop Vector Control]
 For these control modes, *b2-01* sets the starting frequency for Short Circuit Braking at Stop. If the output frequency falls below or is equal to the value set in *b2-01*, then the drive will perform Short Circuit Braking for the time set in *b2-13* [Short Circuit Brake Time @ Start]. If *b2-04* has been set to a value greater than 0 Hz, then the drive will perform DC Injection Braking for the time set in *b2-04* once Short Circuit Braking is complete.

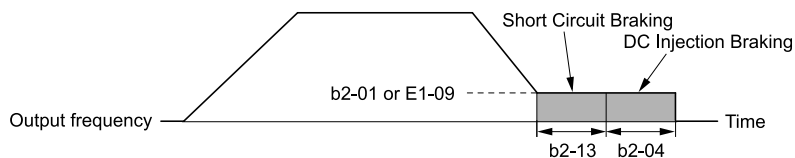

Figure 11.25 Short Circuit Braking at Stop

Note:

The drive will begin Short Circuit Braking from the frequency set in *E1-09* if *b2-01* is set to a value lower than or equal to what is set in *E1-09*. The drive will not perform Short Circuit Braking if both *b2-01* and *E1-09* are set to 0 Hz.

- When *A1-02* = 3 or 7 [Closed Loop Vector Control or PM Closed Loop Vector Control] or when *A1-02* = 4 [Advanced OpenLoop Vector Control] and *n4-72* = 1 [With PG]
For these control modes, *b2-01* sets the starting frequency for Zero Speed Control at Stop. If the output frequency falls below or is equal to the value set in *b2-01*, then the drive will perform Zero Speed Control for the time set in *b2-04*.

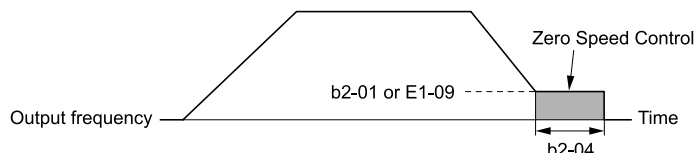

Figure 11.26 Zero Speed Control at Stop

Note:

The drive will begin Zero Speed Control from the frequency set in *E1-09* if *b2-01* is set to a value lower than or equal to what is set in *E1-09*.

■ b2-02: DC Injection Braking Current

No. (Hex.)	Name	Description	Default (Range)
b2-02 (018A)	DC Injection Braking Current	V/f CL-V/f OLV CLV AOLV OLV/PM AOLV/PM CLV/PM EZOLV Sets the DC Injection Braking current as a percentage of the drive rated current.	50% (0 - 100%)

The drive lowers the carrier frequency to 1 kHz when the DC Injection Braking current is set higher than 50%. The amount of DC Injection Braking current that can be used is limited by the motor rated current.

The current level used for DC Injection Braking affects the strength of the magnetic field attempting to lock the motor shaft. Increasing the current level will increase the amount of heat generated by the motor windings. Do not set this parameter higher than the level necessary to hold the motor shaft.

Note:

The setting of *b2-02* is ignored, and initial excitation is performed when *A1-02* = 4 [Control Method Selection = Advanced OpenLoop Vector Control] and *n4-72* = 1 [PG Mode = With PG].

■ b2-03: DC Inject Braking Time at Start

No. (Hex.)	Name	Description	Default Setting (Range)
b2-03 (018B)	DC Inject Braking Time at Start	V/f CL-V/f OLV CLV AOLV OLV/PM AOLV/PM CLV/PM EZOLV Sets the DC Inject Braking Time at start. Configures the zero speed control at start when using Closed Loop Vector Control, Advanced Open Loop Vector Control, or Closed Loop Vector Control for PM.	<i>A1-02</i> = 4: 0.03 s Other than <i>A1-02</i> = 4: 0.00 s (0.00 - 10.00 s)

This function is used to stop a coasting motor and restart it, or to increase motor flux to create high starting torque (a process called initial excitation). A setting of 0.00 disables this function.

Note:

To restart a coasting motor, either use DC Injection Braking to stop and then restart the motor, or enable Speed Search. DC Injection Braking may trigger *ov* [Overvoltage] or *oC* [Overcurrent].

■ **b2-04: DC Inject Braking Time at Stop**

No. (Hex.)	Name	Description	Default Setting (Range)
b2-04 (018C)	DC Inject Braking Time at Stop	<div style="display: flex; justify-content: space-between; font-size: small;"> V/f CL-V/f OLV CLV AOLV OLV/PM AOLV/PM CLV/PM EZOLV </div> <p>Sets the DC Inject Braking Time at stop. Configures the zero speed control at stop when using Closed Loop Vector Control, Advanced Open Loop Vector Control, or Closed Loop Vector Control for PM.</p>	Determined by A1-02 (0.00 - 10.00 s)

This function is used to completely stop a motor with a large inertia during deceleration, and prevent the inertia from causing the motor to continue rotating.

A setting of 0.00 disables this function.

Set a higher value when a longer time is required to stop the motor.

■ **b2-08: Magnetic Flux Compensation Value**

No. (Hex.)	Name	Description	Default (Range)
b2-08 (0190)	Magnetic Flux Compensation Value	<div style="display: flex; justify-content: space-between; font-size: small;"> V/f CL-V/f OLV CLV AOLV OLV/PM AOLV/PM CLV/PM EZOLV </div> <p>Sets the amount of current injected in the beginning of DC Injection Braking at start (initial excitation) as a percentage of the value set in E2-03 [Motor No-Load Current].</p>	0% (0 - 1000%)

Parameter *b2-08* is effective for starting a high-capacity motor (motors with a large secondary circuit time constant). This function is used to quickly increase motor flux to create high starting torque (a process called initial excitation).

The current level used for DC Injection Braking at start changes linearly from the value set in *b2-08* up to the value set in *E2-03*, as shown in the following figure.

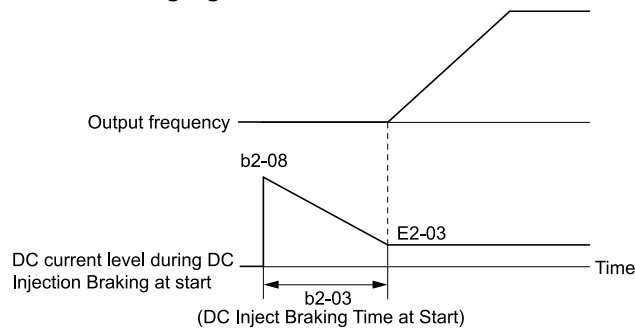

Figure 11.27 DC Current Level during DC Injection Braking at Start

Note:

- It can take a relatively long time for flux to develop if *b2-08* is set below 100%.
- The DC current level will be the DC Injection current set in *b2-02* [DC Injection Braking Current] if *b2-08* is set to 0%.
- DC Injection Braking at start may generate a fair amount of noise if *b2-08* is set too high. Adjust *b2-08* so that the noise is in the allowable range.

■ **b2-12: Short Circuit Brake Time @ Start**

No. (Hex.)	Name	Description	Default Setting (Range)
b2-12 (01BA)	Short Circuit Brake Time @ Start	<div style="display: flex; justify-content: space-between; font-size: small;"> V/f CL-V/f OLV CLV AOLV OLV/PM AOLV/PM CLV/PM EZOLV </div> <p>Sets the Short Circuit Braking time at start.</p>	0.00 s (0.00 - 25.50 s)

After stopping a coasting PM motor, use this function to restart it. The drive generates braking torque in the motor by short circuiting all three motor phases.

A setting of 0.00 disables this function.

Note:

- Short Circuit Braking cannot prevent the PM motor from rotating due to an external force. Use DC Injection Braking to prevent the load from rotating the motor.
- It may be necessary to install a dynamic braking option to the drive, depending on motor speed and load conditions.

■ b2-13: Short Circuit Brake Time @ Start

No. (Hex.)	Name	Description	Default Setting (Range)
b2-13 (01BB)	Short Circuit Brake Time @ Start	<div style="display: flex; justify-content: space-between; font-size: 0.8em; margin-bottom: 5px;"> V/f CL-V/f OLV CLV AOLV OLV/PM AOLV/PM CLV/PM EZOLV </div> Sets the Short Circuit Braking time at stop.	A1-02 = 8: 0.00 s Other than A1-02 = 8: 0.50 s (0.00 - 25.50 s)

This function is used to fully stop a PM motor with a large inertia during deceleration, and prevent the inertia from causing the motor to continue rotating.

Short Circuit Braking operates for the time set in *b2-13* when output frequency falls below either the value set in *b2-01* [*DC Injection/Zero SpeedThreshold*] or *E1-09* [*Minimum Output Frequency*].

A setting of 0.00 disables this function.

Note:

It may be necessary to install a dynamic braking option to the drive, depending on motor speed and load conditions.

■ b2-18: Short Circuit Braking Current

No. (Hex.)	Name	Description	Default Setting (Range)
b2-18 (0177)	Short Circuit Braking Current	<div style="display: flex; justify-content: space-between; font-size: 0.8em; margin-bottom: 5px;"> V/f CL-V/f OLV CLV AOLV OLV/PM AOLV/PM CLV/PM EZOLV </div> Sets the Short Circuit Braking current as a percentage of the motor rated current.	100.0% (0.0 - 200.0%)

The Short Circuit Braking current cannot be higher than the drive rated current, although a higher current level can be set using *b2-18*. The maximum rated current is 120% when the drive is set for Normal Duty (*C6-01* = 1 [*Normal Duty Rating*]). The maximum rated current is 150% when the drive is set for Heavy Duty (*C6-01* = 0 [*Heavy Duty Rating*]).

◆ b3: Speed Search

The Speed Search function detects the actual speed of a coasting motor, then restarts the motor without stopping it. Speed Search is used in the following situations.

- Continuing operation after momentary power loss
- Switching from commercial power supply to the drive
- Restarting a coasting fan

For example, the drive output shuts off and the motor coasts when a momentary loss of power occurs. Once power is restored, the drive performs Speed Search on the coasting motor, and then restarts the motor from the speed it detected.

Be sure to enable *b3-01* [*Speed Search Selection at Start*] when using a PM motor.

There are two types of Speed Search for induction motors: Current Detection and Speed Estimation. Select the type of Speed Search with parameter *b3-24* [*Speed Search Method Selection*].

Parameter settings vary depending on the type of Speed Search. Refer to the following table.

Table 11.21 Speed Search and Related Parameters

Parameters	Current Detection 2	Speed Estimation
b3-01 [Speed Search Selection at Start]	x	x
b3-03 [Speed Search Deceleration Time]	x	-
b3-05 [Speed Search Delay Time]	x	x
b3-06 [Speed Estimation Current Level 1]	-	x
b3-07 [Speed Estimation Current Level 2]	-	x
b3-08 [Speed Estimation ACR P Gain]	-	x
b3-09 [Speed Estimation ACR I Time]	-	x
b3-10 [Speed Estimation Detection Gain]	-	x
b3-14 [Bi-Direction Speed Search Select]	-	x

Parameters	Current Detection 2	Speed Estimation
b3-17 [Speed Est. Retry Current Level]	x	x
b3-18 [Speed Est. Retry Detection Time]	x	x
b3-19 [Number of Speed Search Restarts]	x	x
b3-24 [Speed Search Method Selection]	x (2)	x (1)
b3-25 [Speed Search Wait Time]	x	x
b3-26 [Direction Determining Level]	-	x
b3-27 [Start Speed Search Select]	x	x
b3-29 [Speed Search Back-EMF Threshold]	-	-
b3-31 [Search Current Level 1]	x	-
b3-32 [Search Current Level 2]	x	-
b3-33 [Spd Search during UV Selection]	x	x
b3-35 [Voltage Detection Low Level]	x	x
b3-36 [Wait Restart Level]	x	x
b3-54 [Search Time]	-	-
b3-55 [Current Increment Time]	-	-

Note:

Note the following points when using Speed Estimation Speed Search.

- Perform Rotational Auto-Tuning before configuring the speed search function to use Speed Estimation Speed Search with V/f Control. Perform Stationary Auto-Tuning for Line-to-Line Resistance process again when the wire length between the drive and motor has changed since Auto-Tuning was last performed.
- Use Short Circuit Braking to restart the motor and not Speed Search when *A1-02 = 5, 6 [PM Open Loop Vector Control, PM Advanced Open Loop Vector]*, if there is a substantial wiring distance between the motor and drive, or if the motor is coasting at greater than or equal to 200 Hz.

■ Current Detection 2

This Speed Search function is used with induction motors. Set *b3-24 = 2 [Speed Search Method Selection = Current Detection 2]*. Current Detection Speed Search detects the speed of an induction motor by injecting current into the motor. Speed Search increases the output voltage for the time set in *L2-04 [MomentPowLossVolRecoveryRampTime]*, starting from either the maximum output frequency or the frequency reference.

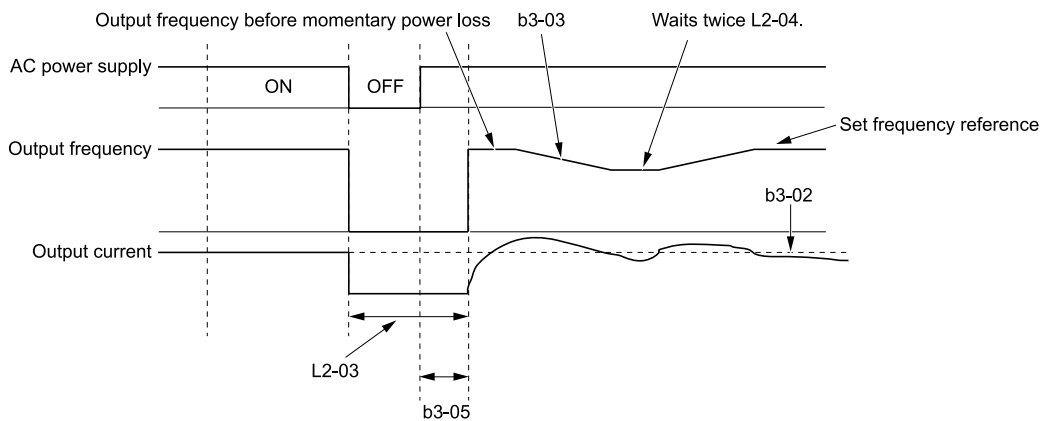

Figure 11.28 Current Detection Speed Search after Momentary Power Loss

Note:

Once power is restored, the drive will not execute Speed Search until the time set in *b3-05 [Speed Search Delay Time]* has passed. Consequently, the drive sometimes will not begin Speed Search even though the time set in *L2-03 [Momentary Power Loss Min BB Time]* has already passed.

If the Run command is entered at the same time as Speed Search, the drive will not execute Speed Search until the time set in *L2-03* has passed. If the value set in *L2-03* is shorter than *b3-05*, then the drive will use the wait time set in *b3-05*.

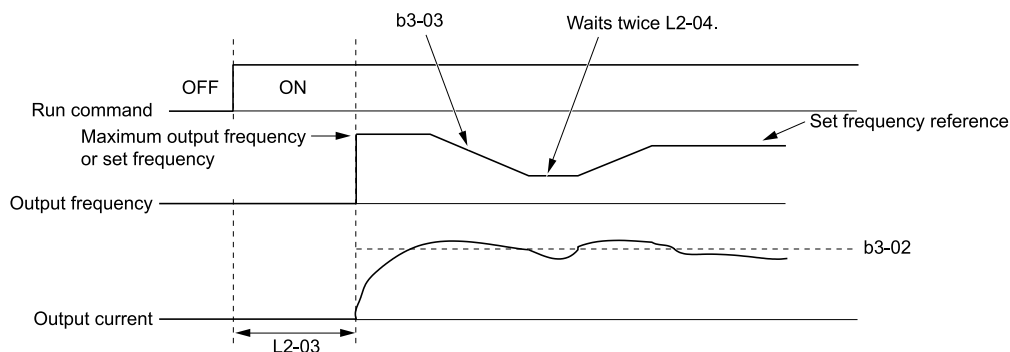

Figure 11.29 Speed Search Selection at Start (Current Detection Type)

Note:

Note the following points when using Current Detection Speed Search.

- Current Detection Speed Search cannot be used with PM motors.
- Speed Search will not be performed if the motor is rotating in reverse.
- Caution should be taken when using Current Detection Speed Search with light loads or a stopped motor, because the motor may suddenly accelerate.
- Lower the value set in *b3-03* if *oL1* [Motor Overload] is triggered when executing Current Detection Speed Search.
- Set a higher value in *L2-03* if *oC* [Overcurrent] or *ov* [Overvoltage] is triggered when executing Current Detection Speed Search after recovering from a momentary power loss.

■ Speed Estimation

This Speed Search function is used with induction motors. Set *b3-24* = 1 [Speed Search Method Selection = Speed Estimation]. This function has the advantage of using less current and a shorter search time. Speed Search can be performed even if the motor is rotating in reverse. There is no concern of sudden acceleration after power is restored following a power loss.

Note:

Speed Estimation Speed Search cannot be performed in the following situations. Use Current Detection Speed Search instead.

- When operating multiple motors on a single drive.
- When using a high-speed motor (200 Hz or higher)
- When using a motor 1.5 kW or smaller
- When the motor output is more than 1 frame size smaller than the drive capacity
- When using a long wiring distance between the drive and motor

Speed Estimation Speed Search estimates the motor speed in the following two steps.

1. Residual Voltage Search

The drive searches for residual voltage when there is a short baseblock time. The drive estimates the motor speed and direction of rotation by the residual voltage in the motor. The drive outputs the motor speed it estimated as frequency, then raises voltage using the deceleration rate set in *L2-04*. Once the output voltage matches the V/f pattern, the drive accelerates or decelerates the motor to the frequency reference. If the drive is unable to estimate the motor speed due to low residual voltage, then it will automatically execute Current Injection.

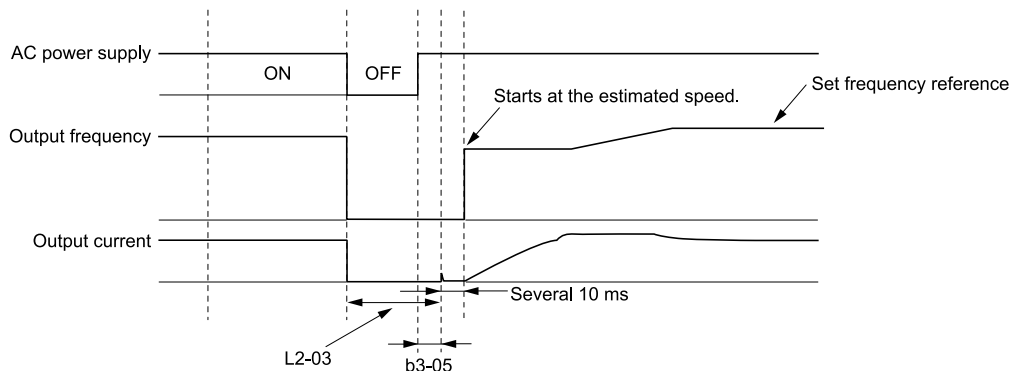

Figure 11.30 Speed Search after Baseblock

Note:

Once power is restored, the drive waits for the time set in *b3-05*. If power loss is longer than the time set in *L2-03*, the drive will begin Speed Search when the time set in *b3-05* has passed after the power recovery.

2. Current Injection

The drive executes Current Injection if there isn't enough residual voltage in the motor. The drive estimates the motor speed and direction of rotation by injecting the amount of DC current set in *b3-06 [Speed Estimation Current Level I]* into the motor windings. The drive outputs the motor speed it estimated as frequency, then raises voltage using the deceleration rate set in *L2-04*. Once the output voltage matches the *V/f* pattern, the drive accelerates or decelerates the motor to the frequency reference.

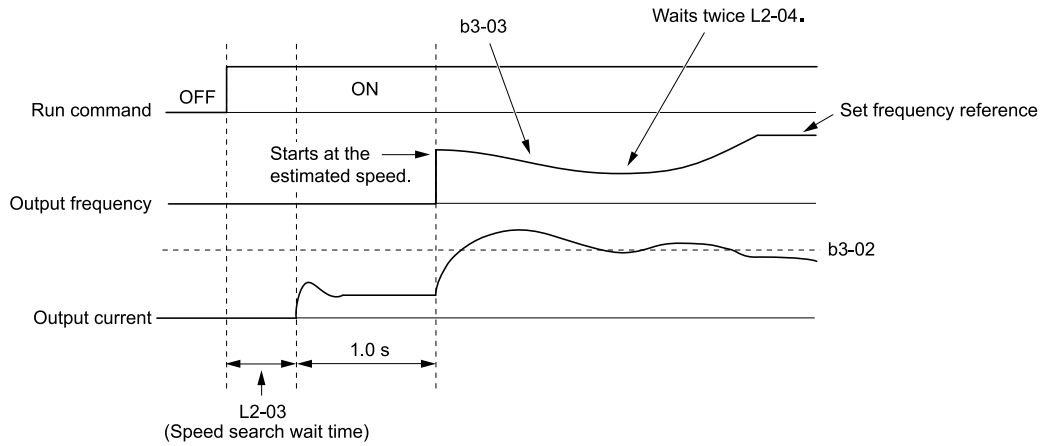

Figure 11.31 Speed Search Selection at Start

Note:

Set the lower limit of the delay time to *b3-05* for when Speed Search begins.

■ **Speed Search and Operation Conditions**

The following conditions apply to Speed Search operation. Select *b3-24 [Speed Search Method Selection]* before performing Speed Search if *A1-02 = 0, 1, 2 [Control Method Selection = V/f Control, Closed Loop V/f Control, Open Loop Vector Control]*.

- Executing Speed Search with each Run Command
The drive disregards a Speed Search command from the external terminals.
- Using Multi-Function Digital Input to Execute an External Speed Search Command
To execute Speed Search using a multi-function digital input, the Run command should be input either at the same time that terminal *Sx* set for Speed Search switches ON, or after Speed Search switches ON. Set Speed Search to *H1-xx* to execute the function externally. It is not possible to set both external Speed Search 1 and 2 at the same time.

Table 11.22 Execute Speed Search via the Digital Input Terminals

H1-xx Setting	Name	Current Detection 2	Speed Estimation
61	External Speed Search Command 1	ON: Speed Search starts from <i>E1-04 [Maximum Output Frequency]</i> .	External Speed Search commands 1 and 2 have the same behavior.
62	External Speed Search Command 2	ON: Speed Search starts from the frequency reference just before the Speed Search command was input.	The drive estimates the motor speed, then begins Speed Search from the speed that was detected.

- Executing Speed Search with Each Auto Restart
Set *L5-01 [Number of Auto Restart Attempts] = 1* or greater. The drive automatically executes Speed Search after a fault covered by the Auto Restart function occurs.
- Executing Speed Search after Momentary Power Loss
Set *L2-01 = 1, 2 [Momentary Power Loss Ope Select = Enbl with Timer, Enbl whl CPU act]*.
- Executing Speed Search after the External Baseblock Command is Cleared
The drive executes Speed Search after the external baseblock command is cleared, the Run command is enabled, and the output frequency is higher than the minimum frequency.

■ **b3-01: Speed Search Selection at Start**

No. (Hex.)	Name	Description	Default (Range)
b3-01 (0191)	Speed Search Selection at Start	<input type="checkbox"/> V/f <input type="checkbox"/> CL-V/f <input type="checkbox"/> OLV <input type="checkbox"/> CLV <input type="checkbox"/> AOLV <input type="checkbox"/> OLV/IPM <input type="checkbox"/> AOLV/IPM <input type="checkbox"/> CLV/IPM <input type="checkbox"/> EZOLV	Determined by A1-02 (0, 1)

0 : Disabled

This setting starts operating the drive at the minimum output frequency when the Run command is entered.

The drive will execute Speed Search and begin operating the motor when the Run command is enabled while the *External Speed Search command 1 or 2 [H1-xx = 61, 62]* is input from a multi-function input terminal.

1 : Enabled

This setting performs Speed Search when the Run command is entered. The drive begins running the motor after Speed Search is complete.

■ b3-02: Speed Search Deactivation Current

No. (Hex.)	Name	Description	Default (Range)
b3-02 (0192)	Speed Search Deactivation Current	V/f CL-V/f OLV CLV AOLV OLV/PM AOLV/PM CLV/PM EZOLV Sets the current level that ends Speed Search as a percentage of the drive rated output current. Normally there is no need to change this setting.	Determined by A1-02 (0 - 200%)

Lower this setting if the drive is unable to restart the motor.

■ b3-03: Speed Search Deceleration Time

No. (Hex.)	Name	Description	Default (Range)
b3-03 (0193)	Speed Search Deceleration Time	V/f CL-V/f OLV CLV AOLV OLV/PM AOLV/PM CLV/PM EZOLV Determines the deceleration time during Speed Search operation. Set the time it takes to decelerate from the maximum output frequency to the minimum output frequency.	2.0 s (0.1 - 10.0 s)

This is the output frequency deceleration time used by Current Detection Speed Search and by the Current Injection Method of Speed Estimation Speed Search.

Note:

Lower the value set in *b3-03* if *oL1 [Motor Overload]* is triggered when executing Current Detection Speed Search.

■ b3-04: V/f Gain during Speed Search

No. (Hex.)	Name	Description	Default Setting (Range)
b3-04 (0194)	V/f Gain during Speed Search	V/f CL-V/f OLV CLV AOLV OLV/PM AOLV/PM CLV/PM EZOLV Configures the ratio used to reduce the V/f during searches to reduce the output current during speed searches.	Determined by o2-04 (10 - 100)

Use the following expression to calculate the output voltage during speed searches.

Output voltage during speed searches = Configured V/f × b3-04

This configuration is unnecessary if the current detection search operates correctly.

■ b3-05: Speed Search Delay Time

No. (Hex.)	Name	Description	Default (Range)
b3-05 (0195)	Speed Search Delay Time	V/f CL-V/f OLV CLV AOLV OLV/PM AOLV/PM CLV/PM EZOLV If a magnetic contactor is installed between the drive and the motor, this parameter sets a delay time to activate the magnetic contactor by delaying Speed Search.	0.2 s (0.0 - 100.0 s)

In cases where a magnetic contactor is used between the drive and the motor, the contactor must be closed before the drive can perform Speed Search. This parameter sets a delay time to activate the magnetic contactor in such cases.

■ b3-06: Speed Estimation Current Level 1

No. (Hex.)	Name	Description	Default Setting (Range)
b3-06 (0196)	Speed Estimation Current Level 1	V/f CL-V/f OLV CLV AOLV OLV/PM AOLV/PM CLV/PM EZOLV Configure the amount of current that flows to the motor as a coefficient of the motor rated current when executing the Speed Estimation Speed Search. Normally there is no need to change this setting.	Determined by o2-04 (0.0 - 2.0)

11.3 b: Application

Increase the setting when the speed estimation value is the minimum output frequency even if the motor is coasting at a high speed when the drive is estimating the speed during the Speed Estimation Speed Search. The output current during speed search is automatically limited to the drive rated current.

Note:

Use the Current Detection Speed Search when the speed cannot be accurately estimated even after adjusting *b3-06*.

■ b3-07: Speed Estimation Current Level 2

No. (Hex.)	Name	Description	Default Setting (Range)
b3-07 (0197)	Speed Estimation Current Level 2	<div style="display: flex; justify-content: space-between; font-size: 0.8em; font-weight: bold; margin-bottom: 5px;"> V/f CL-V/f OLV CLV AOLV OLV/PM AOLV/PM CLV/PM EZOLV </div> The amount of current that flows to the motor when Speed Estimation Speed Searches are executed is configured as a coefficient of <i>E2-03 [Motor No-Load Current]</i> or <i>E4-03 [Motor 2 Rated No-Load Current]</i> . Normally there is no need to change this setting.	1.0 (0.0 - 3.0)

Increase the setting value in increments of 0.1 when the speed estimation value reaches the minimum output frequency during Speed Estimation Speed Searches. The output current during speed search is automatically limited to the drive rated current.

■ b3-08: Speed Estimation ACR P Gain

No. (Hex.)	Name	Description	Default Setting (Range)
b3-08 (0198)	Speed Estimation ACR P Gain	<div style="display: flex; justify-content: space-between; font-size: 0.8em; font-weight: bold; margin-bottom: 5px;"> V/f CL-V/f OLV CLV AOLV OLV/PM AOLV/PM CLV/PM EZOLV </div> Configures the proportional gain for the current controller used when executing the Speed Estimation Speed Search. Adjusts the speed search responsiveness. Normally there is no need to change this setting.	A1-02 = 0 through 4: Determined by o2-04, A1-02 = 5, 6, or 8: Determined by A1-02 (0.00 - 6.00)

■ b3-09: Speed Estimation ACR I Time

No. (Hex.)	Name	Description	Default Setting (Range)
b3-09 (0199)	Speed Estimation ACR I Time	<div style="display: flex; justify-content: space-between; font-size: 0.8em; font-weight: bold; margin-bottom: 5px;"> V/f CL-V/f OLV CLV AOLV OLV/PM AOLV/PM CLV/PM EZOLV </div> Configures the integral time for the current controller used when executing the Speed Estimation Speed Search. Adjusts the speed search responsiveness. Normally there is no need to change this setting.	Determined by A1-02 (0.0 - 1000.0 ms)

■ b3-10: Speed Estimation Detection Gain

No. (Hex.)	Name	Description	Default Setting (Range)
b3-10 (019A)	Speed Estimation Detection Gain	<div style="display: flex; justify-content: space-between; font-size: 0.8em; font-weight: bold; margin-bottom: 5px;"> V/f CL-V/f OLV CLV AOLV OLV/PM AOLV/PM CLV/PM EZOLV </div> Configures the gain used to correct frequencies estimated by the Speed Estimation Speed Search.	1.05 (1.00 - 1.20)

Increase the setting value if *ov [DC Bus Overvoltage]* is detected when restarting the motor.

■ b3-14: Bi-Direction Speed Search Select

No. (Hex.)	Name	Description	Default Setting (Range)
b3-14 (019E)	Bi-Direction Speed Search Select	<div style="display: flex; justify-content: space-between; font-size: 0.8em; font-weight: bold; margin-bottom: 5px;"> V/f CL-V/f OLV CLV AOLV OLV/PM AOLV/PM CLV/PM EZOLV </div> Selects which direction to start Speed Estimation Speed Search, either in the direction of the frequency reference, or the direction that the drive detected the motor is rotating.	Determined by A1-02 (0, 1)

0 : Disabled

The drive detects the direction of motor rotation from the frequency reference.

1 : Enabled

The drive detects the direction of motor rotation during Speed Search.

■ b3-17: Speed Est. Retry Current Level

No. (Hex.)	Name	Description	Default Setting (Range)
b3-17 (01F0)	Speed Est. Retry Current Level	<div style="display: flex; justify-content: space-between; font-size: 0.8em; margin-bottom: 5px;"> V/f CL-V/f OLV CLV AOLV OLV/PM AOLV/PM CLV/PM EZOLV </div> Configures the current level used to operate the search retry function for Speed Estimation Speed Search, as a percentage, on the basis that the drive rated current is the 100% value.	150% (0 - 200%)

The drive pauses operation to prevent overvoltage and overcurrent occurs when significant current flows during Speed Estimation Speed Search. The speed search is reexecuted (retried) when the current reaches the level set in *b3-17*.

■ b3-18: Speed Est. Retry Detection Time

No. (Hex.)	Name	Description	Default Setting (Range)
b3-18 (01F1)	Speed Est. Retry Detection Time	<div style="display: flex; justify-content: space-between; font-size: 0.8em; margin-bottom: 5px;"> V/f CL-V/f OLV CLV AOLV OLV/PM AOLV/PM CLV/PM EZOLV </div> Configures the time until the speed search is reexecuted (retried) when a speed search is interrupted due to significant current flowing during Speed Estimation Speed Search.	0.10 s (0.00 - 1.00 s)

Retries the speed search when the current exceeds the current level set in *b3-17* [*Speed Est. Retry Current Level*] during the time set in *b3-18*.

■ b3-19: Number of Speed Search Restarts

No. (Hex.)	Name	Description	Default (Range)
b3-19 (01F2)	Number of Speed Search Restarts	<div style="display: flex; justify-content: space-between; font-size: 0.8em; margin-bottom: 5px;"> V/f CL-V/f OLV CLV AOLV OLV/PM AOLV/PM CLV/PM EZOLV </div> Sets the number of times to restart Speed Search if Speed Search fails.	3 times (0 - 10 times)

The drive will trigger *Ser* [*Too Many Speed Search Restarts*] if it reaches the number of Speed Search restarts set here.

■ b3-24: Speed Search Method Selection

No. (Hex.)	Name	Description	Default (Range)
b3-24 (01C0)	Speed Search Method Selection	<div style="display: flex; justify-content: space-between; font-size: 0.8em; margin-bottom: 5px;"> V/f CL-V/f OLV CLV AOLV OLV/PM AOLV/PM CLV/PM EZOLV </div> Selects the type of Speed Search to perform when starting the motor, or when power is restored following a momentary power loss.	2 (1, 2)

Set *b3-01* = 1 [*Speed Search Selection at Start = Enabled*] to execute Speed Search at start. Set *L2-01* = 1 [*Momentary Power Loss Ope Select = Enbl with Timer*] to execute Speed Search once power is restored following a momentary power loss.

1 : Speed Estimation

The drive estimates the motor speed based on residual voltage when using a short baseblock time.

If there is not enough residual voltage, then the drive will inject DC current into the motor to estimate the motor speed.

2 : Current Detection 2

The drive detects motor speed by injecting DC current into the motor.

■ b3-25: Speed Search Wait Time

No. (Hex.)	Name	Description	Default Setting (Range)
b3-25 (01C8)	Speed Search Wait Time	<div style="display: flex; justify-content: space-between; font-size: 0.8em; margin-bottom: 5px;"> V/f CL-V/f OLV CLV AOLV OLV/PM AOLV/PM CLV/PM EZOLV </div> Configures the wait time used until the speed search retry function is executed.	0.5 s (0.0 - 30.0 s)

Increase the setting value when the drive detects the following faults during speed searches.

- *oC* [*Overcurrent*]

- *ov [DC Bus Overvoltage]*
- *SEr [Too Many Speed Search Restarts]*

■ **b3-26: Direction Determining Level**

No. (Hex.)	Name	Description	Default Setting (Range)
b3-26 (01C7)	Direction Determining Level	<div style="display: flex; justify-content: space-between; font-size: 0.8em; font-weight: bold; margin-bottom: 5px;"> V/f CL-V/f OLV CLV AOLV OLV/PM AOLV/PM CLV/PM EZOLV </div> Configures the level used to determine the direction of motor rotation. Increase the setting value if determination fails.	1000 (40 to 60000)

■ **b3-27: Start Speed Search Select**

No. (Hex.)	Name	Description	Default Setting (Range)
b3-27 (01C9)	Start Speed Search Select	<div style="display: flex; justify-content: space-between; font-size: 0.8em; font-weight: bold; margin-bottom: 5px;"> V/f CL-V/f OLV CLV AOLV OLV/PM AOLV/PM CLV/PM EZOLV </div> Configures the conditions used to start the speed search.	0 (0, 1)

Executes *External Speed Search command 1/2 [HI-xx = 61/62]* for initial speed searches or from the MFDI terminal when the selected conditions are satisfied.

0 : SS only if RUN applied before BB

1 : SS regardless of RUN/BB sequence

■ **b3-29: Speed Search Back-EMF Threshold**

No. (Hex.)	Name	Description	Default Setting (Range)
b3-29 (077C)	Speed Search Back-EMF Threshold	<div style="display: flex; justify-content: space-between; font-size: 0.8em; font-weight: bold; margin-bottom: 5px;"> V/f CL-V/f OLV CLV AOLV OLV/PM AOLV/PM CLV/PM EZOLV </div> Configures the induced voltage of motors for which speed searches are performed. Speed searches are performed when the level of the motor induced voltage reaches the setting value. Normally there is no need to change this setting.	10% (0 - 10%)

Gradually reduce the setting value to make adjustments. If the setting value is reduced too significantly, the speed search may not operate correctly.

■ **b3-31: Search Current Level 1**

No. (Hex.)	Name	Description	Default Setting (Range)
b3-31 (0BC0)	Search current Level 1	<div style="display: flex; justify-content: space-between; font-size: 0.8em; font-weight: bold; margin-bottom: 5px;"> V/f CL-V/f OLV CLV AOLV OLV/PM AOLV/PM CLV/PM EZOLV </div> Configures the current level used to restrict the output current during the Current Detection Speed Search.	1.50 (1.50 - 3.50)

Configure this setting as a ratio of *E2-03 [Motor No-Load Current]*. Determines a current level given that *E2-03* is 30% of the motor rated current when $E2-03 \leq \text{Motor Rated Current} \times 0.3$.

■ **b3-32: Search Current Level 2**

No. (Hex.)	Name	Description	Default Setting (Range)
b3-32 (0BC1)	Search current Level 2	<div style="display: flex; justify-content: space-between; font-size: 0.8em; font-weight: bold; margin-bottom: 5px;"> V/f CL-V/f OLV CLV AOLV OLV/PM AOLV/PM CLV/PM EZOLV </div> Configures the current level used to complete motor speed searches.	1.20 (0.00 - 1.49)

The Current Detection Speed Search gradually reduces the output frequency to search for the motor speed when the output current reaches or falls below Search current Level 2.

Configure this setting as a ratio of *E2-03 [Motor No-Load Current]*. Determines a current level given that *E2-03* is 30% of the motor rated current when $E2-03 \leq \text{Motor Rated Current} \times 0.3$.

■ b3-33: Spd Search during UV Selection

No. (Hex.)	Name	Description	Default Setting (Range)
b3-33 (0B3F)	Spd Search during UV Selection	<div style="display: flex; justify-content: space-between; font-size: 0.8em; font-weight: bold;"> V/f CL-V/f OLV CLV AOLV OLV/PM AOLV/PM CLV/PM EZOLV </div> <p>Selects whether or not to execute the speed search at start-up when the Run command is input while U_v [DC Bus Undervoltage] is detected.</p>	1 (0, 1)

This parameter is enabled when three parameters are configured as follows.

- $L2-01 = 1, 2$ [Momentary Power Loss Ope Select = Enbl with Timer, Enbl whl CPU act]
- $b3-01 = 1$ [Speed Search Selection at Start = Enabled]
- $b1-03 = 1$ [Stopping Method Selection = Coast to Stop]

0 : Disabled

1 : Enabled

■ b3-35: Voltage Detection Low Level

No. (Hex.)	Name	Description	Default Setting (Range)
b3-35 (0BC3)	Voltage Detection Low Level	<div style="display: flex; justify-content: space-between; font-size: 0.8em; font-weight: bold;"> V/f CL-V/f OLV CLV AOLV OLV/PM AOLV/PM CLV/PM EZOLV </div> <p>The speed search is enabled when the detected induced voltage of motors $\geq b3-35$.</p>	10% (5 - 50%)

For example, restarts are performed if the induced voltage at 10% of the setting is at least 20 V for 200 V class drives.

■ b3-36: Wait Restart Level

No. (Hex.)	Name	Description	Default Setting (Range)
b3-36 (0BC4)	Wait Restart Level	<div style="display: flex; justify-content: space-between; font-size: 0.8em; font-weight: bold;"> V/f CL-V/f OLV CLV AOLV OLV/PM AOLV/PM CLV/PM EZOLV </div> <p>The restart process is prohibited and the drive enters the standby state when the detected induced voltage of the motor \geq power supply voltage $\times b3-36$. The restart process is executed when the detected induced voltage of the motor $<$ power supply voltage $\times b3-36$. Normally there is no need to change this setting.</p>	0.970 (0.500 - 1.000)

For example, the restart will not be performed if the setting value is 0.83% and the voltage does not fall to the induced voltage at approximately 183 V when the power supply voltage is 220 V.

■ b3-54: Search Time

No. (Hex.)	Name	Description	Default Setting (Range)
b3-54 (3123)	Search Time	<div style="display: flex; justify-content: space-between; font-size: 0.8em; font-weight: bold;"> V/f CL-V/f OLV CLV AOLV OLV/PM AOLV/PM CLV/PM EZOLV </div> <p>Configures the speed search time.</p>	400 ms (10 - 2000 ms)

If the setting value is reduced too significantly, the speed search may not operate correctly.

Implement the following measures when oC [Overcurrent] are detected immediately after speed searches start.

- Increase the value of $L2-03$ [Minimum Baseblock Time] and reduce the motor speed used when starting speed searches.
- Increases the setting value of $b3-08$ [Speed Estimation ACR P Gain].
- Increase the value of $b3-54$.

Increase the setting value of $b3-08$ when oC or ov [DC Bus Overvoltage] occurs during speed searches.

■ b3-55: Current Increment Time

No. (Hex.)	Name	Description	Default Setting (Range)
b3-55 (3124)	Current Increment Time	<div style="display: flex; justify-content: space-between; font-size: 0.8em; font-weight: bold;"> V/f CL-V/f OLV CLV AOLV OLV/PM AOLV/PM CLV/PM EZOLV </div> <p>Configures the time used to increase the current value from zero current until the setting value of $b3-06$ [Speed Estimation Current Level 1].</p>	10 ms (10 - 2000 ms)

Gradually increase the setting value when significant current flows after a speed search starts. If the setting value is increased too significantly, the speed search may not operate correctly.

◆ b4: Timer Function

The drive uses timers to delay switching multi-function digital output terminals ON/OFF.

Timers prevent chattering noise from sensors and switches.

There are two types of timers.

- Timers that set a delay for timer inputs and timer outputs.
These timers delay the switching of the multi-function inputs and multi-function digital outputs. To enable this function, set $H1-xx = 18$ [MFDI Function Select = Timer Function Input], and set $H2-01$ through $H2-04 = 12$ [MFDO Function Select = Timer Output].
- Timers that set a delay for switching output terminals ON/OFF.
These timers delay switching the multi-function digital output terminals ON/OFF. Set delay times in parameters $b4-03$ to $b4-08$ to enable this function.

■ Timer Function Operation

- Timers that set a delay for timer inputs and timer outputs.
Triggers timer output if the timer input has been ON for longer than the time set in $b4-01$ [Timer Function On-Delay Time]. Triggers timer output late for the time set in $b4-02$ [Timer Function Off-Delay Time]. The following diagram shows an example of how the timer function works.

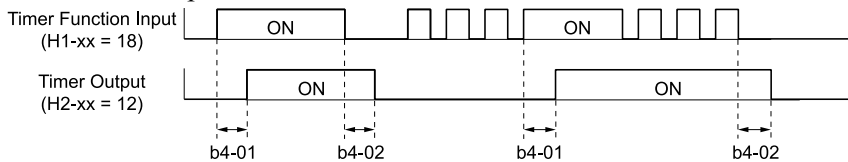

Figure 11.32 Example of Timer Function Operation

- Setting on/off-delay time of multi-function digital output
The following diagram shows an example of how the timer function works using H2-01 terminals. Set this function using $b4-03$ [H2-01 ON Delay Time] and $b4-04$ [H2-01 OFF Delay Time].

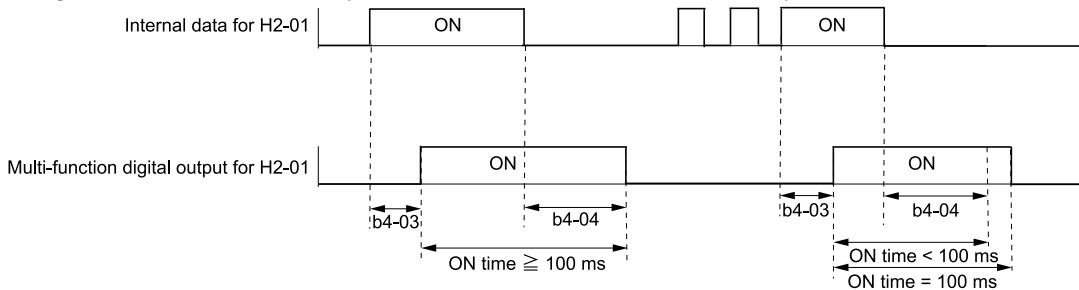

Figure 11.33 Example of How the Timer Function Works Using H2-01 Terminals

Note:

Once the terminal is triggered, it lasts for at least 100 ms regardless of the setting of on/off-delay time of multi-function digital output terminal.

■ b4-01: Timer Function On- Delay Time

No. (Hex.)	Name	Description	Default (Range)
b4-01 (01A3)	Timer Function On-Delay Time	V/f CL-V/f OLV CLV AOLV OLV/PM AOLV/PM CLV/PM EZOLV Sets the ON-delay time for the timer input.	0.0 s (0.0 - 3000.0 s)

■ b4-02: Timer Function Off- Delay Time

No. (Hex.)	Name	Description	Default (Range)
b4-02 (01A4)	Timer Function Off-Delay Time	V/f CL-V/f OLV CLV AOLV OLV/PM AOLV/PM CLV/PM EZOLV Sets the OFF-delay time for the timer input.	0.0 s (0.0 - 3000.0 s)

■ b4-03: H2-01 ON Delay Time

No. (Hex.)	Name	Description	Default Setting (Range)
b4-03 (0B30)	H2-01 ON Delay Time	<div style="display: flex; justify-content: space-between; gap: 5px;"> V/f CL-V/f OLV CLV AOLV OLV/PM AOLV/PM CLV/PM EZOLV </div> Configures the delay time until the contact is turned on after the function selected with <i>H2-01</i> turns on.	0 ms (0 - 65000 ms)

■ b4-04: H2-01 OFF Delay Time

No. (Hex.)	Name	Description	Default Setting (Range)
b4-04 (0B31)	H2-01 OFF Delay Time	<div style="display: flex; justify-content: space-between; gap: 5px;"> V/f CL-V/f OLV CLV AOLV OLV/PM AOLV/PM CLV/PM EZOLV </div> Configures the delay time until the contact is turned off after the function selected with <i>H2-01</i> turns off.	0 ms (0 - 65000 ms)

■ b4-05: H2-02 ON Delay Time

No. (Hex.)	Name	Description	Default Setting (Range)
b4-05 (0B32)	H2-02 ON Delay Time	<div style="display: flex; justify-content: space-between; gap: 5px;"> V/f CL-V/f OLV CLV AOLV OLV/PM AOLV/PM CLV/PM EZOLV </div> Configures the delay time until the contact is turned on after the function selected with <i>H2-02</i> turns on.	0 ms (0 - 65000 ms)

■ b4-06: H2-02 OFF Delay Time

No. (Hex.)	Name	Description	Default Setting (Range)
b4-06 (0B33)	H2-02 OFF Delay Time	<div style="display: flex; justify-content: space-between; gap: 5px;"> V/f CL-V/f OLV CLV AOLV OLV/PM AOLV/PM CLV/PM EZOLV </div> Configures the delay time until the contact is turned off after the function selected with <i>H2-02</i> turns off.	0 ms (0 - 65000 ms)

■ b4-07: H2-03 ON Delay Time

No. (Hex.)	Name	Description	Default Setting (Range)
b4-07 (0B34)	H2-03 ON Delay Time	<div style="display: flex; justify-content: space-between; gap: 5px;"> V/f CL-V/f OLV CLV AOLV OLV/PM AOLV/PM CLV/PM EZOLV </div> Configures the delay time until the contact is turned on after the function selected with <i>H2-03</i> turns on.	0 ms (0 - 65000 ms)

■ b4-08: H2-03 OFF Delay Time

No. (Hex.)	Name	Description	Default Setting (Range)
b4-08 (0B35)	H2-03 OFF Delay Time	<div style="display: flex; justify-content: space-between; gap: 5px;"> V/f CL-V/f OLV CLV AOLV OLV/PM AOLV/PM CLV/PM EZOLV </div> Configures the delay time until the contact is turned off after the function selected with <i>H2-03</i> turns off.	0 ms (0 - 65000 ms)

■ b4-09: H2-04 ON Delay Time

No. (Hex.)	Name	Description	Default Setting (Range)
b4-09 (0B36)	H2-04 ON Delay Time	<div style="display: flex; justify-content: space-between; gap: 5px;"> V/f CL-V/f OLV CLV AOLV OLV/PM AOLV/PM CLV/PM EZOLV </div> Sets the delay time until the contact is turned on after the function selected with <i>H2-04</i> turns on.	0 ms (0 - 65000 ms)

■ b4-10: H2-04 OFF Delay Time

No. (Hex.)	Name	Description	Default Setting (Range)
b4-10 (0B37)	H2-04 OFF Delay Time	<div style="display: flex; justify-content: space-between; gap: 5px;"> V/f CL-V/f OLV CLV AOLV OLV/PM AOLV/PM CLV/PM EZOLV </div> Sets the delay time until the contact is turned off after the function selected with <i>H2-04</i> turns off.	0 ms (0 - 65000 ms)

◆ b5: PID Control

The drive is equipped with a PID control function. The user can control drive output so that the target value matches the detected value by adjusting the proportional gain, integral time, and derivative time that affects the bias between the target value and the feedback value. Use this function to adjust the drive output so that the flow, pressure, and temperature in the application match the target value precisely.

Optimize performance by using a combination of the following controls.

- P control

P control affects the deviation proportionally. It outputs the product (the controlled output) proportional to the deviation. The user cannot reach zero deviation by using only the offset from P control.

- I control

I control is the integral of the deviation. It outputs the product (the controlled output) using an integral value of the deviation. I control is effective in getting the feedback value and the target value to match. Although using only proportional control (P control) creates an offset, combining it with integral control eliminates the offset by using a time constant.

- D control

D control is the derivative of the deviation. D control has a large affect on drive output for when there are sudden, drastic changes in the output. It quickly restores drive output to what it was before the sudden change. It multiplies a time constant by a derivative value of the deviation (slope of the deviation), and by then adding that result to PID input, D control calculates the deviation of the signal, and corrects the deviation.

Note:

D control has a tendency to cause less stable operation due to noise affecting the deviation signal. Use D control only when necessary.

■ PID Control Operation

The following diagram demonstrates PID control operation. The modified output (output frequency) changes as shown as the drive uses PID control to keep the deviation (the difference between the target value and the feedback value) constant.

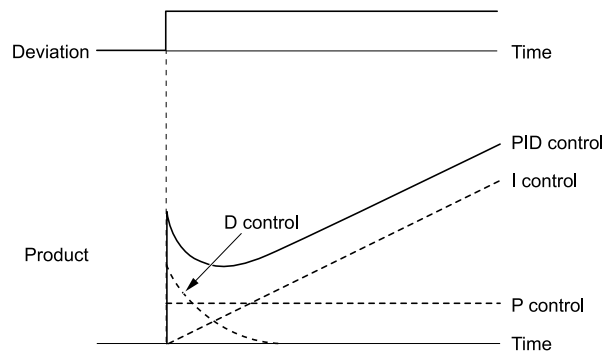

Figure 11.34 PID Control Operation

■ PID Control Applications

The followings are applications for the PID control feature.

Table 11.23 PID Control Applications

Application	Description	Sensors Used
Speed control	<ul style="list-style-type: none"> • The drive uses a feedback signal for the machine speed, and adjusts that speed so that it matches the target value. • The drive performs synchronous control by using speed data from other machinery as the target value. The drive then combines that target value with the feedback from the machine it is operating to match its speed with that other machinery. 	Tacho generator
Pressure control	The drive maintains constant pressure by using feedback from the actual pressure.	Pressure sensor

Application	Description	Sensors Used
Flow control	The drive maintains constant flow by using feedback from the actual flow.	Flow rate sensor
Temperature control	The drive maintains constant temperature by controlling a fan using feedback from the actual temperature.	Thermocoupler, thermistor

Input Methods for the PID Setpoint

Select how the PID setpoint is input to the drive with *b5-01 [PID Function Setting]*.

If *b5-01 = 1 or 2 [PID Function Setting = Enabled D=Fdbk or Enabled D=Fdfwd]*, then the frequency reference set in *b1-01 [Reference 1 Source]* or *b1-15 [Frequency Reference Selection 2]* will be the PID setpoint, or the one of the values shown in the following table will be the PID setpoint.

If *b5-01 = 3 or 4 [PID Function Setting = Fref+PID D=Fdbk or Fref+PID D=Fdfwd]*, then one of the inputs in the following table will be the PID setpoint.

Table 11.24 Input Methods for the PID Setpoint

Input Methods for the PID Setpoint	Setting
Multi-function analog input terminal A1	Set <i>H3-02 = C [Terminal A1 Function Selection = PID Setpoint]</i> .
Multi-function analog input terminal A2	Set <i>H3-10 [Terminal A2 Function Selection] = C</i> .
Multi-function analog input terminal A3	Set <i>H3-06 [Terminal A3 Function Selection] = C</i> .
MEMOBUS/Modbus register 0006H	Sets MEMOBUS/Modbus register 000FH (Control Selection Setting) bit 1 to 1 (PID setpoint input). Enters the PID setpoint to MEMOBUS/Modbus register 0006H (PID Target, 0.01% units, signed).
Pulse train input terminal RP	Set <i>H6-01 = 2 [PulseTrain InTerm RP Func Select = PID setpoint value]</i> .
<i>b5-19 [PID Setpoint Value]</i>	Set <i>b5-18 = 1 [PID Setpoint Selection = Enabled]</i> . Enters the PID setpoint to <i>b5-19</i> .

Note:

Setting two inputs for the PID setpoint will trigger operation error *oPE07 [MF Analog Input Selection Error]*.

Entering the PID Feedback Value

There are two ways of inputting the PID feedback value to the drive. One method uses a single feedback signal for normal PID control. The other method uses two signals, and the difference between those signals determines the deviation.

Using one feedback signal.

Select how the feedback signal is input to the drive for PID control from the following table.

Table 11.25 PID Feedback Input Method

PID Feedback Input Method	Setting
Multi-function analog input terminal A1	Set <i>H3-02 = B [PID Feedback]</i> .
Multi-function analog input terminal A2	Set <i>H3-10 = B</i> .
Multi-function analog input terminal A3	Set <i>H3-06 = B</i> .
Pulse train input terminal RP	Set <i>H6-01 = 1 [PID feedback value]</i> .

The drive uses two feedback signals, and the difference between those signals becomes the deviation.

Select how the second feedback signal is input to the drive from the following table. The drive calculates the deviation of the second feedback value. Enable the second feedback signal that is used to calculate the deviation by setting *H3-02, H3-06, or H3-10 = 16 [Terminal A1/A3/A2 Function Selection = Differential PID feedback]*.

Table 11.26 PID Differential Feedback Input Method

PID Differential Feedback Input Method	Setting
Multi-function analog input terminal A1	Set <i>H3-02 = 16 [Differential PID feedback]</i> .
Multi-function analog input terminal A2	Set <i>H3-10 = 16</i> .
Multi-function analog input terminal A3	Set <i>H3-06 = 16</i> .

Note:

Setting more than one of the parameters *H3-02*, *H3-06*, and *H3-10* to 16 will trigger *oPE07 [MF Analog Input Selection Error]*.

■ PID Control Block Diagram

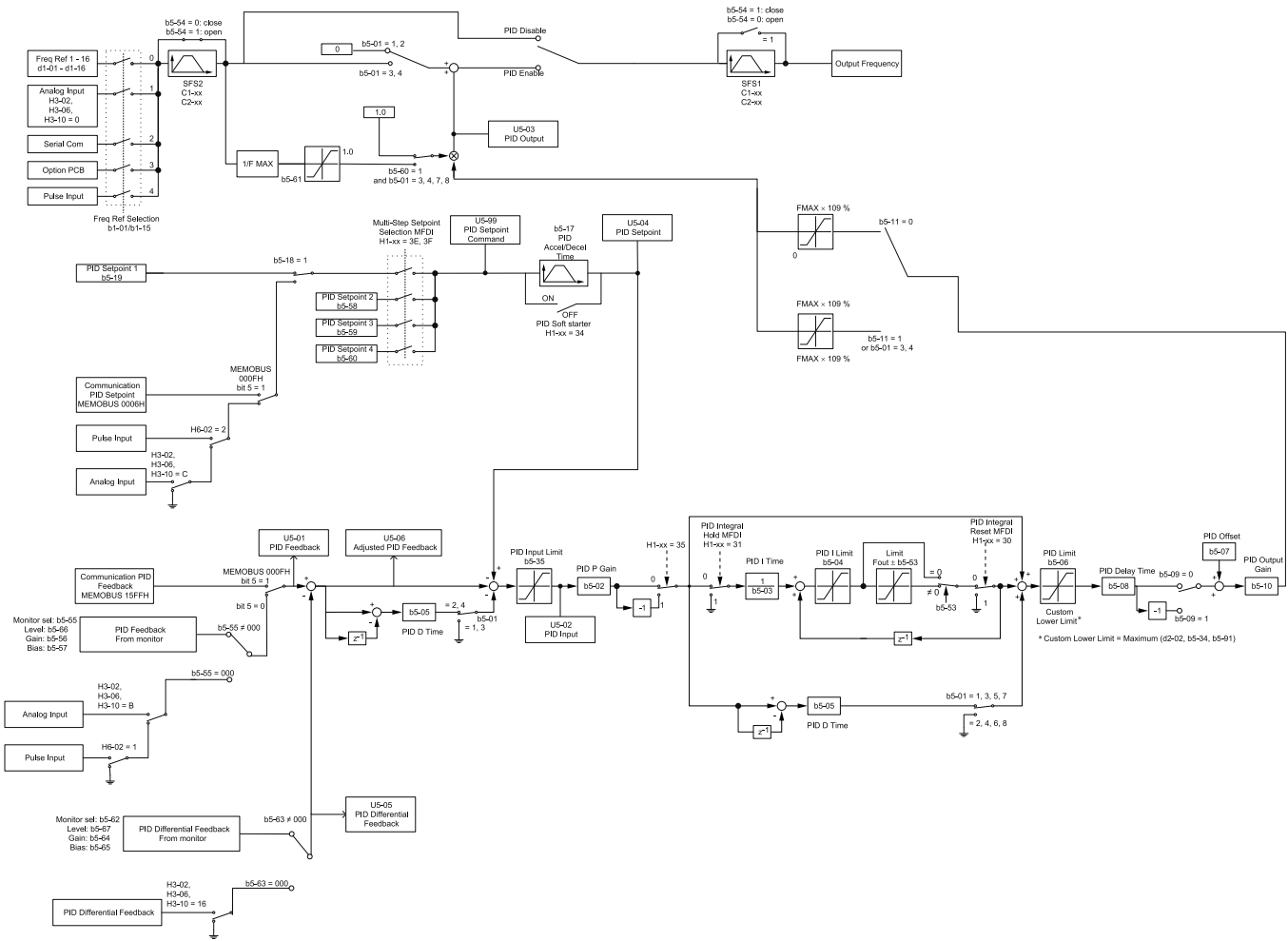

Figure 11.35 PID Control Block Diagram

■ PID Feedback Loss Detection

The PID feedback loss detection function detects broken sensors and faulty wiring between the drive and sensors. Be sure to use the PID feedback loss detection function whenever using PID control. The motor may suddenly accelerate up to the maximum output frequency as a result of the feedback signal being too low. This function prevents such risks to the load.

Feedback loss can be detected in two ways:

• *PID Feedback Loss [FbL]*

Set the following parameters to execute the PID feedback loss detection function.

The drive detects feedback loss when the feedback value falls below the value in *b5-13* for longer than the time in *b5-14*.

- *b5-12 [Feedback Loss Detection Select]*
- *b5-13 [PID Feedback Loss Detection Lvl]*
- *b5-14 [PID Feedback Loss Detection Time]*

• *Excessive PID Feedback [FbH]*

Set the following parameters to determine how the drive detects too high of a feedback level.

The drive detects excessive PID feedback when the feedback value rises above the value in *b5-36* for longer than the time in *b5-37*.

- *b5-12 [Feedback Loss Detection Select]*
- *b5-36 [PID Feedback High Detection Lvl]*
- *b5-37 [PID Feedback High Detection Time]*

The following diagram shows the operation principle when the feedback value has fallen too low, and the drive detects feedback loss. The operation is the same when the drive detects excessive feedback.

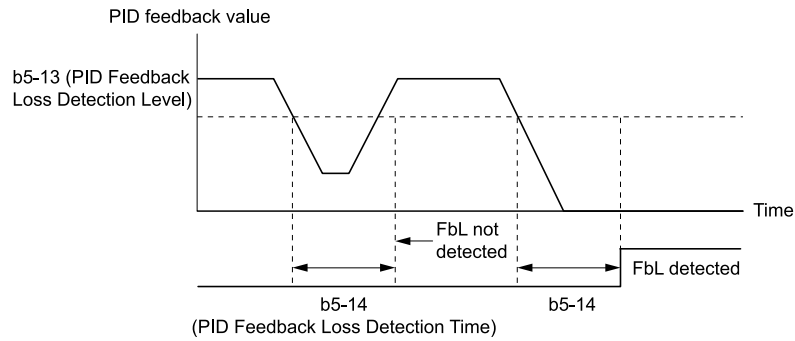

Figure 11.36 Time Chart for PID Feedback Loss Detection Time

■ PID Sleep

PID sleep stops drive operation if the PID output or the frequency reference falls below *b5-15 [PID Sleep Function Start Level]*. This function is used to shut off drive output when the motor has decelerated down to the designated frequency.

The drive will automatically restart the motor once the PID output or the frequency reference rises above *b5-15* for the time set in *b5-16 [PID Sleep Delay Time]*.

The following time chart shows PID Sleep function.

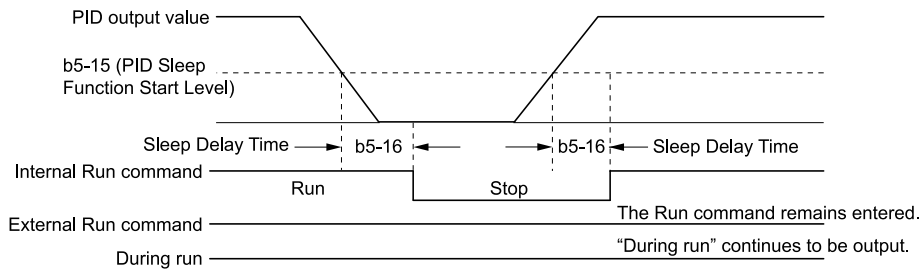

Figure 11.37 PID Sleep Time Chart

Note:

- The PID Sleep function remains enabled even when PID control is disabled.
- The drive will stop the motor according to *b1-03 [Stopping Method Selection]* when the PID Sleep function is triggered.

■ Fine-Tuning PID

Fine-tune the following parameter settings to have PID control eliminate problems with overshoot and oscillation.

- *b5-02 [Proportional Gain Setting (P)]*
- *b5-03 [Integral Time Setting (I)]*
- *b5-05 [Derivative Time (D)]*
- *b5-08 [PID Primary Delay Time Constant]*

Purpose	Procedure	Results
Suppress overshoot.	<ul style="list-style-type: none"> Set a smaller value to <i>b5-05 [Derivative Time (D)]</i>. Set a larger value to <i>b5-03 [Integral Time Setting (I)]</i>. 	
Quickly stabilize control.	<ul style="list-style-type: none"> Set a smaller value to <i>b5-03 [Integral Time Setting (I)]</i>. Set a larger value to <i>b5-05 [Derivative Time (D)]</i>. 	
Suppress long-cycle oscillations.	Set a larger value to <i>b5-03 [Integral Time Setting (I)]</i> .	
Suppress short-cycle oscillations.	<ul style="list-style-type: none"> Set a smaller value to <i>b5-05 [Derivative Time (D)]</i>. If oscillation is not suppressed by setting <i>b5-05 = 0.00 [Derivative Time (D) = disabling D control]</i>, then either set a smaller value to <i>b5-02 [Proportional Gain Setting (P)]</i> or set a larger value to <i>b5-08 [PID Primary Delay Time Constant]</i>. 	

■ EZ Sleep/Wake-up Functionality

Configures *b5-89 = 1 [Sleep Method Selection = EZ Sleep/Wake-up]* to enable the EZ Sleep/Wake-up function.

Note:

- When *b5-89 = 0 [Sleep Mode Selection = Standard]*, the EZ Sleep function and related parameters are disabled. Parameter *b5-91 [EZ Minimum Speed]* is excluded from this rule.
- Parameter *b5-15 [PID Sleep Function Start Level]* is disabled when *b5-89 = 1*.

Configuration Parameter	Description
<i>b5-90 [EZ Sleep Unit]</i>	<p>Determines the unit of measure for <i>b5-92 [EZ Sleep Level]</i>. The setting range of <i>b5-91 [EZ Minimum Speed]</i> is 0.0 to 590.0 Hz when <i>b5-90 = 0 [0.1Hz units]</i>. The setting range is 0 to 35400 min⁻¹ (r/min) when <i>b5-90 = 1 [rev/min]</i>.</p> <p>Note: The value of <i>b5-92</i> is not automatically updated when <i>b5-90</i> is changed.</p>
<i>b5-91 [EZ Minimum Speed]</i>	<p>This parameter functions as the lower limit for PID output. The lower limit of PID output is internally configured with the larger value between <i>b5-91</i>, <i>b5-34 [PID Output Lower Limit]</i>, and <i>d2-02 [Frequency Reference Lower Limit]</i>, regardless of the setting of <i>b5-89</i>.</p>

Configuration Parameter	Description
<i>b5-92 [EZ Sleep Level]</i>	The drive enters the sleep state when the output frequency or motor speed drops below the value of <i>b5-92</i> continuously for a time longer than the setting value of <i>b5-93 [EZ Sleep Time]</i> .
<i>b5-95 = 0 [EZ Wake-up Mode = Absolute]</i>	The drive resumes operation from the sleep state when the PID feedback has dropped below the value of <i>b5-94 [EZ Wake-up Level]</i> for longer than the time configured with <i>b5-96 [EZ Sleep Time]</i> .
<i>b5-95 = 1 [EZ Wake-up Mode = Setpoint Delta]</i>	The drive resumes operation from the sleep state when the PID feedback has dropped below the value defined as the PID setpoint value minus <i>b5-94</i> continuously for the time configured with <i>b5-96</i> .

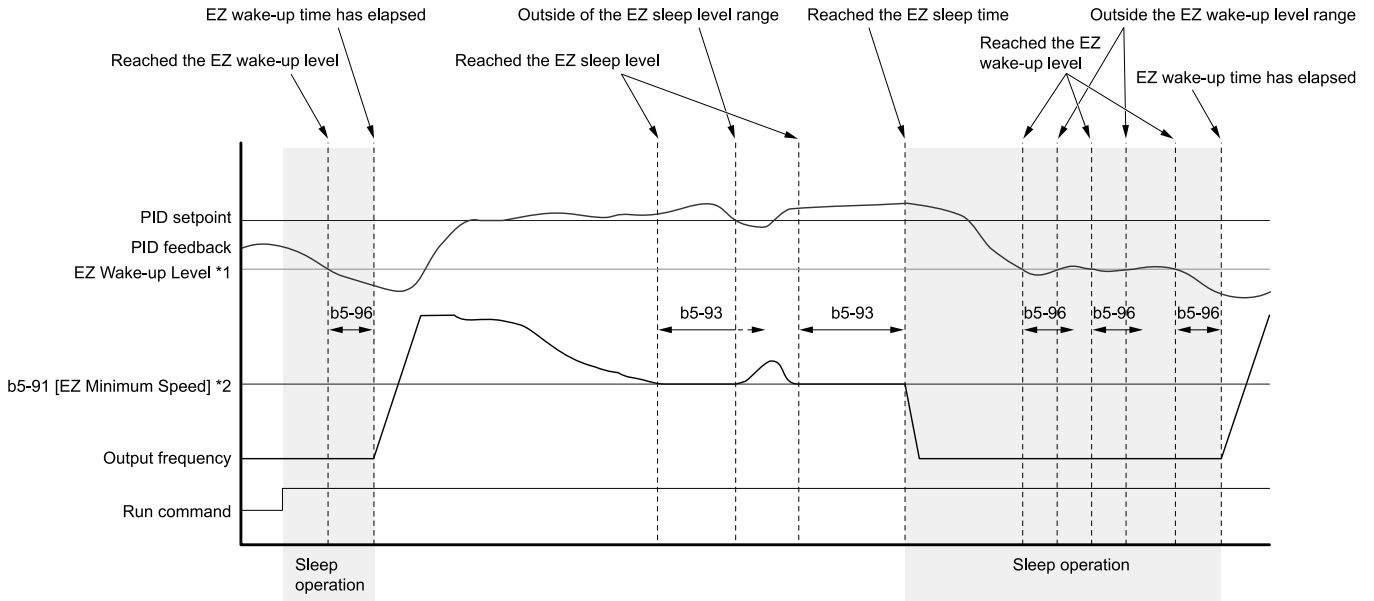

Figure 11.38 EZ Sleep/Wake-up Operation: PID Output is Normal and *b5-92* = 0.0 Hz

- *1 Operation is determined by the setting values of *b5-94* and *b5-95*.
- *2 In the example, *b5-92* is at the default setting of 0.0 Hz. In this scenario, *b5-91* functions as the EZ sleep level.

■ b5-01: PID Function Setting

No. (Hex.)	Name	Description	Default (Range)
b5-01 (01A5)	PID Function Setting	V/f CL-V/f OLV CLV AOLV OLV/PM AOLV/PM CLV/PM EZOLV Selects the type of PID control.	0 (0 - 8)

0 : Disabled

1 : Enabled D=Fdbk

The drive performs D control on the difference between the feedback value and the PID setpoint output via *U5-02 [PID Input]*.

2 : Enabled D=Fdfwd

The drive performs D control on the feedback output via *U5-06 [PID AdjustedFeedback]*.

3 : Fref+PID D=Fdbk

The drive adds the frequency reference to the PID output. The drive performs D control on the difference between the feedback value and the PID setpoint output via *U5-02 [PID Input]*.

4 : Fref+PID D=Fdfwd

The drive adds the frequency reference to the PID output. The drive performs D control on the feedback output via *U5-06 [PID AdjustedFeedback]*.

5 : Enabled D=Fdbk2

6 : Enabled D=Fdfwd2

7 : Fref+PID D=Fdbk2

8 : Fref+PID D=Fdfwd2

Note:

Use settings 5 to 8 instead of settings 1 to 4 if retrofitting the drive with a Varispeed series drive, or a similar product from a previous product line.

■ **b5-02: Proportional Gain Setting (P)**

No. (Hex.)	Name	Description	Default (Range)
b5-02 (01A6) RUN	Proportional Gain Setting (P)	V/f CL-V/f OLV CLV AOLV OLV/PM AOLV/PM CLV/PM EZOLV Sets the proportional gain (P) applied to PID input.	1.00 (0.00 - 25.00)

Larger values will tend to reduce the error but may cause oscillations if set too high. Lower values may allow too much offset between the setpoint and feedback.

Set *b5-02* = 0.00 to disable P control.

■ **b5-03: Integral Time Setting (I)**

No. (Hex.)	Name	Description	Default (Range)
b5-03 (01A7) RUN	Integral Time Setting (I)	V/f CL-V/f OLV CLV AOLV OLV/PM AOLV/PM CLV/PM EZOLV Sets the integral time (I) in seconds that is applied to PID input.	1.0 s (0.0 - 360.0 s)

The shorter the integral time set to b5-03, the faster the offset will be eliminated. If the integral time is set too short, however, overshoot or oscillation may occur.

Set *b5-03* = 0.00 to disable I control.

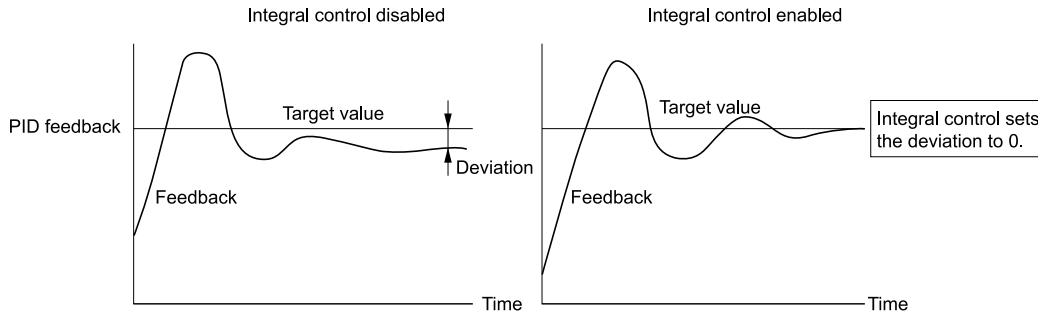

Figure 11.39 Integral Time and Deviation

■ **b5-04: Integral Limit Setting**

No. (Hex.)	Name	Description	Default (Range)
b5-04 (01A8) RUN	Integral Limit Setting	V/f CL-V/f OLV CLV AOLV OLV/PM AOLV/PM CLV/PM EZOLV Sets the upper limit for I control as a percentage of <i>E1-04</i> [Maximum Output Frequency].	100.0% (0.0 - 100.0%)

On some applications, especially those with rapidly varying loads, the output of the PID function may show a fair amount of oscillation. Set a low value to suppress oscillation as well as prevent mechanical loss and motor speed loss.

■ **b5-05: Derivative Time (D)**

No. (Hex.)	Name	Description	Default (Range)
b5-05 (01A9) RUN	Derivative Time (D)	V/f CL-V/f OLV CLV AOLV OLV/PM AOLV/PM CLV/PM EZOLV Sets the derivative time (D) for PID control. This parameter adjusts system responsiveness.	0.00 s (0.00 - 10.00 s)

Longer time settings improve the response but can cause vibrations. Shorter time settings reduce the overshoot but reduce controller responsiveness.

Set *b5-05* = 0.00 to disable D control.

■ b5-06: PID Output Limit

No. (Hex.)	Name	Description	Default (Range)
b5-06 (01AA) RUN	PID Output Limit	V/f CL-V/f OLV CLV AOLV OLV/PM AOLV/PM CLV/PM EZOLV Sets the maximum output possible from the entire PID controller as a percentage of E1-04 [Maximum Output Frequency].	100.0% (0.0 - 100.0%)

■ b5-07: PID Offset Adjustment

No. (Hex.)	Name	Description	Default Setting (Range)
b5-07 (01AB) RUN	PID Offset Adjustment	V/f CL-V/f OLV CLV AOLV OLV/PM AOLV/PM CLV/PM EZOLV Sets the offset for the PID control output as a percentage of E1-04 [Maximum Output Frequency].	0.0% (-100.0 - +100.0%)

■ b5-08: PID Primary Delay Time Constant

No. (Hex.)	Name	Description	Default Setting (Range)
b5-08 (01AC)	PID Primary Delay Time Constant	V/f CL-V/f OLV CLV AOLV OLV/PM AOLV/PM CLV/PM EZOLV Configures the primary delay time constant for the PID control output. Normally there is no need to change this setting.	0.00 s (0.00 - 10.00 s)

Prevents resonance from occurring when mechanical friction is significant or rigidity is poor. Configure the value larger than the resonant frequency cycle. If the setting value is too significant, the responsiveness of the drive is reduced.

■ b5-09: PID Output Level Selection

No. (Hex.)	Name	Description	Default (Range)
b5-09 (01AD)	PID Output Level Selection	V/f CL-V/f OLV CLV AOLV OLV/PM AOLV/PM CLV/PM EZOLV Reverses the polarity of the PID output.	0 (0, 1)

Used in applications where the drive output frequency drops when increasing the PID setpoint.

0 : Normal output (direct acting)

A positive PID input causes an increase in the PID output (direct acting).

1 : Reverse output (reverse acting)

A positive PID input causes a decrease in the PID output (reverse acting).

■ b5-10: PID Output Gain Setting

No. (Hex.)	Name	Description	Default (Range)
b5-10 (01AE) RUN	PID Output Gain Setting	V/f CL-V/f OLV CLV AOLV OLV/PM AOLV/PM CLV/PM EZOLV Adjusts the degree of compensation by multiplying the gain by the PID output.	1.00 (0.00 - 25.00)

Applies a gain to the PID output and can be helpful when $b5-01 = 3$ or 4 [PID Function Setting = $Fref+PID D = Fdbk, Fref+PID D = Fdfwd$].

■ b5-11: PID Output Reverse Selection

No. (Hex.)	Name	Description	Default (Range)
b5-11 (01AF)	PID Output Reverse Selection	V/f CL-V/f OLV CLV AOLV OLV/PM AOLV/PM CLV/PM EZOLV Sets whether or not the motor should rotate in reverse when the PID control output is negative.	0 (0, 1)

11.3 b: Application

This parameter is disabled when $b5-01 = 3, 4$ [PID Function Setting = $Fref+PID D=Fdbk, Fref+PID D=Fdfwd$]. There is no limit for PID output (PID output can be positive or negative). Operates the same as setting "1: Enabled: Negative lower limit."

0 : Disabled: 0 lower limit

Limits the PID output to zero when PID output is negative and shuts off drive output.

1 : Enabled: Negative lower limit

Rotates the motor in reverse when the PID output is negative.

■ b5-12: Feedback Loss Detection Select

No. (Hex.)	Name	Description	Default Setting (Range)
b5-12 (01B0)	Feedback Loss Detection Select	<div style="display: flex; justify-content: space-between; font-size: small;"> V/f CL-V/f OLV CLV AOLV OLV/PM AOLV/PM CLV/PM EZOLV </div> <p>Enables or disables PID feedback loss detection. Sets operation after the drive detects PID feedback loss.</p>	0 (0 - 5)

0 : No alarm_Always detected_DO only

Triggers the multi-function digital output terminal set for *PID Feedback Low* or *PID Feedback High* [H2-01 to H2-04 = 3E, 3F]. The keypad will not display an alarm when triggered. The drive continues operation.

The drive triggers the multi-function digital output set for a *PID Feedback Low* when the feedback signal falls below the level set in *b5-13* [PID Feedback Loss Detection Lvl] for longer than the time set in *b5-14* [PID Feedback Loss Detection Time].

The drive triggers the multi-function digital output set for a *PID Feedback High* when the feedback signal exceeds the level set in *b5-36* [PID Feedback High Detection Lvl] for longer than the time set in *b5-37* [PID Feedback High Detection Time].

The drive resets the fault output when the feedback value is no longer within the detection range.

1 : Alarm_Always detected

Detects *FbL* [PID Feedback Loss] and *FbH* [Excessive PID Feedback]. Triggers the multi-function digital output terminal set for *PID Feedback Low* or *PID Feedback High* [H2-01 to H2-04 = 3E, 3F]. The output terminal set for *Minor Fault* [H2-01 to H2-04 = 10] switches ON. The drive continues operation.

The drive triggers the multi-function digital output set for a *PID Feedback Low* when the feedback signal falls below the level set in *b5-13* for longer than the time set in *b5-14*.

The drive triggers the multi-function digital output set for a *PID Feedback High* when the feedback signal rises above the level set in *b5-36* for longer than the time set in *b5-37*.

The drive resets the alarm output when the feedback value goes outside the detection range.

2 : Fault_Always detected

Detects *FbL* and *FbH*. The output terminal set for *Fault* [H2-01 to H2-04 = E] switches ON. The motor coasts to stop.

The drive detects *FbL* when the feedback signal falls below the level set in *b5-13* for the time set in *b5-14*.

The drive detects *FbH* when the feedback signal rises above the level set in *b5-36* for the time set in *b5-37*.

3 : No alarm_only @ PID enbl_DO only

Triggers the multi-function digital output terminal set for *PID Feedback Low* or *PID Feedback High*. The keypad will not display an alarm when triggered. The drive continues operation.

The drive disables fault detection when the multi-function digital input terminal set to *PID Disable* [H1-xx = 19] switches ON.

4 : Alarm_only detected @ PID Enbl

Detects *FbL* and *FbH*. Triggers the multi-function digital output terminal set for *PID Feedback Low* or *PID Feedback High*. The output terminal set for *Minor Fault* [H2-01 to H2-04 = 10] switches ON. The drive continues operation.

The drive disables fault detection when the multi-function digital input terminal set to *PID Disable* [H1-xx = 19] switches ON.

5 : Fault_only detected @ PID Enbl

Detects *FbL* and *FbH*. The output terminal set for *Fault* [H2-01 to H2-04 = E] switches ON. The motor coasts to stop.

The drive disables fault detection when the multi-function digital input terminal set to *PID Disable* [*H1-xx = 19*] switches ON.

■ b5-13: PID Feedback Loss Detection Lvl

No. (Hex.)	Name	Description	Default (Range)
b5-13 (01B1)	PID Feedback Loss Detection Lvl	V/f CL-V/f OLV CLV AOLV OLV/PM AOLV/PM CLV/PM EZOLV Sets the level that triggers <i>PID Feedback Loss</i> [<i>FbL</i>] as a percentage of the maximum output frequency.	0% (0 - 100%)

The drive detects *PID Feedback Loss* [*FbL*] when the feedback signal falls below the level set in *b5-13* for longer than the time set in *b5-14* [*PID Feedback Loss Detection Time*].

■ b5-14: PID Feedback Loss Detection Time

No. (Hex.)	Name	Description	Default (Range)
b5-14 (01B2)	PID Feedback Loss Detection Time	V/f CL-V/f OLV CLV AOLV OLV/PM AOLV/PM CLV/PM EZOLV Sets the time that the PID feedback has to fall below <i>b5-13</i> [<i>PID Feedback Loss Detection Lvl</i>] before <i>PID Feedback Loss</i> [<i>FbL</i>] is detected.	1.0 s (0.0 - 25.5 s)

■ b5-15: PID Sleep Function Start Level

No. (Hex.)	Name	Description	Default Setting (Range)
b5-15 (01B3)	PID Sleep Function Start Level	V/f CL-V/f OLV CLV AOLV OLV/PM AOLV/PM CLV/PM EZOLV Sets the output level that triggers the PID Sleep function.	Determined by A1-02 (0.0 - 590.0)

The drive goes into Sleep mode if the PID output or frequency reference is smaller than *b5-15* for longer than the time set to *b5-16* [*PID Sleep Delay Time*]. The drive resumes operation when the PID output or frequency reference is above *b5-15* for longer than the time set to *b5-16*.

■ b5-16: PID Sleep Delay Time

No. (Hex.)	Name	Description	Default (Range)
b5-16 (01B4)	PID Sleep Delay Time	V/f CL-V/f OLV CLV AOLV OLV/PM AOLV/PM CLV/PM EZOLV Sets a delay time to activate or deactivate the PID Sleep function.	0.0 s (0.0 - 25.5 s)

■ b5-17: PID Accel/Decel Time

No. (Hex.)	Name	Description	Default (Range)
b5-17 (01B5)	PID Accel/Decel Time	V/f CL-V/f OLV CLV AOLV OLV/PM AOLV/PM CLV/PM EZOLV Raises or lowers the PID setpoint using the acceleration and deceleration times set to the drive. This is a soft-starter for the PID setpoint.	0.0 s (0.0 - 6000.0 s)

The drive normally uses the acceleration and deceleration times set in *CI-xx* [*Accel and Decel Times*], but when PID control is enabled, the drive applies *CI-xx* after PID output. Consequently, the drive's responsiveness worsens when the PID setpoint is changed frequently. Set *b5-17* as longer acceleration and deceleration times if resonance with PID control causes hunting, overshoot, or undershoot.

Lower *CI-xx* until hunting no longer occurs, then check the acceleration and deceleration times with *b5-17*. The user can enable and disable the setting in *b5-17* via a multi-function digital input terminal by setting *PID soft starter cancel* [*H1-xx = 34*].

■ b5-18: PID Setpoint Selection

No. (Hex.)	Name	Description	Default (Range)
b5-18 (01DC)	PID Setpoint Selection	V/f CL-V/f OLV CLV AOLV OLV/PM AOLV/PM CLV/PM EZOLV Enables or disables <i>b5-19</i> [<i>PID Setpoint Value</i>].	0 (0, 1)

0 : Disabled

The drive does not use the value set in *b5-19* as the PID setpoint.

1 : Enabled

The drive uses the value set in *b5-19* as the PID setpoint.

■ b5-19: PID Setpoint Value

No. (Hex.)	Name	Description	Default (Range)
b5-19 (01DD) RUN	PID Setpoint Value	<div style="display: flex; justify-content: space-between; font-size: 0.8em; font-weight: bold;"> V/f CL-V/f OLV CLV AOLV OLV/PM AOLV/PM CLV/PM EZOLV </div> <p>This setting is the PID setpoint when <i>b5-18</i> = 1 [<i>PID Setpoint Selection = Enabled</i>].</p>	0.00% (0.00 - 100.00%)

■ b5-20: PID Setpoint Scaling

No. (Hex.)	Name	Description	Default (Range)
b5-20 (01E2)	PID Setpoint Scaling	<div style="display: flex; justify-content: space-between; font-size: 0.8em; font-weight: bold;"> V/f CL-V/f OLV CLV AOLV OLV/PM AOLV/PM CLV/PM EZOLV </div> <p>Determines the units used to set and display <i>b5-19</i> [<i>PID Setpoint Value</i>].</p>	1 (0 - 3)

0 : 0.01 Hz units

The drive uses 0.01 Hz units.

1 : 0.01% units

The drive uses 0.01% units. Set a value as a percentage of *E1-04* [*Maximum Output Frequency*].

2 : min⁻¹

The drive uses min⁻¹. Set *E2-04*, *E4-04*, or *E5-04* [*PM Motor Pole Count*].

3 : User Units

Applies user-defined units. The drive uses *b5-38* [*PID Setpoint User Display*] and *b5-39* [*PID Setpoint Display Digits*].

Determines the units to display the PID setpoint in *U5-01*, *U5-04*, *U5-06* [*PID Feedback, PID Setpoint, PID AdjustedFeedback*].

■ b5-34: PID Output Lower Limit

No. (Hex.)	Name	Description	Default (Range)
b5-34 (019F) RUN	PID Output Lower Limit	<div style="display: flex; justify-content: space-between; font-size: 0.8em; font-weight: bold;"> V/f CL-V/f OLV CLV AOLV OLV/PM AOLV/PM CLV/PM EZOLV </div> <p>Sets the output lower limit for the PID control as a percentage of <i>E1-04</i> [<i>Maximum Output Frequency</i>].</p>	0.0% (-100.0 - +100.0%)

Use a lower limit to keep PID control output from dropping below a fixed level.

Setting *b5-34* to 0.0% disables this function.

■ b5-35: PID Input Limit

No. (Hex.)	Name	Description	Default (Range)
b5-35 (01A0) RUN	PID Input Limit	<div style="display: flex; justify-content: space-between; font-size: 0.8em; font-weight: bold;"> V/f CL-V/f OLV CLV AOLV OLV/PM AOLV/PM CLV/PM EZOLV </div> <p>Sets the input upper limit for the PID control as a percentage of <i>E1-04</i> [<i>Maximum Output Frequency</i>].</p>	1000.0% (0.0 - 1000.0%)

A large input value for PID control creates a high output. This limit is applied to both negative and positive domains.

■ b5-36: PID Feedback High Detection Lvl

No. (Hex.)	Name	Description	Default (Range)
b5-36 (01A1)	PID Feedback High Detection Lvl	V/f CL-V/f OLV CLV AOLV OLV/PM AOLV/PM CLV/PM EZOLV Sets the level that triggers <i>Excessive PID Feedback [FbH]</i> as a percentage of <i>E1-04 [Maximum Output Frequency]</i> .	100% (0 - 100%)

The drive detects that *Excessive PID Feedback [FbH]* when the feedback signal rises above the level set in *b5-36* for the time set in *b5-37 [PID Feedback High Detection Time]*.

■ b5-37: PID Feedback High Detection Time

No. (Hex.)	Name	Description	Default (Range)
b5-37 (01A2)	PID Feedback High Detection Time	V/f CL-V/f OLV CLV AOLV OLV/PM AOLV/PM CLV/PM EZOLV Sets the time that triggers <i>Excessive PID Feedback [FbH]</i> when the feedback signal rises above the level set in <i>b5-36 [PID Feedback High Detection Lvl]</i> .	1.0 s (0.0 - 25.5 s)

■ b5-38: PID Setpoint User Display

No. (Hex.)	Name	Description	Default (Range)
b5-38 (01FE)	PID Setpoint User Display	V/f CL-V/f OLV CLV AOLV OLV/PM AOLV/PM CLV/PM EZOLV Determines the value for setting and displaying <i>U5-01, U5-04</i> when outputting the maximum output frequency.	Determined by b5-20 (1 - 60000)

The drive uses this parameter in combination with *b5-39 [PID Setpoint Display Digits]*.

The drive applies user-set PID setpoint and display units to *U5-01 [PID Feedback]* and *U5-04 [PID Setpoint]* when parameter *b5-20 = 3 [PID Setpoint Scaling = User Units]*.

■ b5-39: PID Setpoint Display Digits

No. (Hex.)	Name	Description	Default (Range)
b5-39 (01FF)	PID Setpoint Display Digits	V/f CL-V/f OLV CLV AOLV OLV/PM AOLV/PM CLV/PM EZOLV Sets the number of digits for setting and displaying the PID setpoint.	Determined by b5-20 (0 - 3)

The drive uses this parameter in combination with *b5-38 [PID Setpoint User Display]*.

The drive applies user-set PID setpoint and display units to *U5-01 [PID Feedback]* and *U5-04 [PID Setpoint]* when parameter *b5-20 = 3 [PID Setpoint Scaling = User Units]*.

0 : No decimal places 1

1 : One decimal place

2 : Two decimal places

3 : Three decimal places

■ b5-40: Frequency Reference Monitor @PID

No. (Hex.)	Name	Description	Default (Range)
b5-40 (017F)	Frequency Reference Monitor @PID	V/f CL-V/f OLV CLV AOLV OLV/PM AOLV/PM CLV/PM EZOLV Selects the contents displayed in monitor <i>U1-01 [Freq Reference]</i> when using PID control.	0 (0, 1)

0 : with PID

Monitor *U1-01* displays the frequency reference increased or reduced for the PID output.

1 : without PID

Monitor *U1-01* displays the frequency value.

■ b5-47: PID Output Reverse Selection 2

No. (Hex.)	Name	Description	Default (Range)
b5-47 (017D)	PID Output Reverse Selection 2	V/f CL-V/f OLV CLV AOLV OLV/PM AOLV/PM CLV/PM EZOLV Sets whether or not the motor should rotate in reverse when the PID control output is negative.	1 (0, 1)

This parameter is enabled when $b5-01 = 3$ or 4 [PID Function Setting = $Fref+PID D=Fdbk$, $Fref+PID D=Fdfwd$].

0 : Disabled: 0 lower limit

Limits the PID output to zero when PID output is negative. The drive output will be stopped.

1 : Enabled: Negative lower limit

Rotates the motor in reverse when the PID output is negative.

■ b5-53: Integrator Ramp Limit

No. (Hex.)	Name	Description	Default Setting (Range)
b5-53 (0B8F) RUN	Integrator Ramp Limit	V/f CL-V/f OLV CLV AOLV OLV/PM AOLV/PM CLV/PM EZOLV Adjusts the responsiveness of PID control when the PID feedback changes rapidly.	0.0 Hz (0.0 - 10.0 Hz)

Note:

- This parameter is disabled when configured to 0.0 Hz.
- The PID integrator value is limited to the range defined by the output frequency $\pm b5-53$ when the integrator ramp limit is enabled ($b5-53 > 0.0$ Hz).
- Gradually reduce the value of $b5-53$ in increments of 0.1 Hz to slow down the response of PID control when the PID feedback changes rapidly.

■ b5-54: PID softstarter cancel selection

No. (Hex.)	Name	Description	Default Setting (Range)
b5-54 (0BB7)	PID softstarter cancel selection	V/f CL-V/f OLV CLV AOLV OLV/PM AOLV/PM CLV/PM EZOLV Selects the relationship between the soft starter and PID input/output.	0 (0, 1)

The following illustrates the relationship between the soft starter and PID input/output.

Selection	PID Frequency Reference Input	PID Frequency Reference Output	Soft Starter Input	Soft Starter Output
Soft Starter 1	Frequency Reference	Soft Starter Input	PID Frequency Reference Output	Output frequency
Soft Starter 2	Soft Starter Output	Output frequency	Frequency Reference	PID Frequency Reference Input

0 : None

Performs the soft starter process downstream from the PID function. (The PID function input functions as the frequency reference, the PID function output functions as the soft starter input, and the soft starter output functions as the output frequency.)

1 : Softstarter is canceled

Performs the soft starter process upstream from the PID function. (The soft starter input functions as the frequency reference, the soft starter output functions as the soft starter input, and the PID function output functions as the output frequency.)

■ b5-55: PID feedback monitor selection

No. (Hex.)	Name	Description	Default Setting (Range)
b5-55 (0BE1)	PID feedback monitor selection	V/f CL-V/f OLV CLV AOLV OLV/PM AOLV/PM CLV/PM EZOLV Selects the monitor ($Ux-xx$) used as the PID Feedback.	000 (000 - 999)

Note:

- Parameter U5-xx cannot be selected.
- This parameter is disabled when set to 000.

■ b5-56: PID feedback monitor gain

No. (Hex.)	Name	Description	Default Setting (Range)
b5-56 (0BE2)	PID feedback monitor gain	<input type="checkbox"/> V/f <input type="checkbox"/> CL-V/f <input type="checkbox"/> OLV <input type="checkbox"/> CLV <input type="checkbox"/> AOLV <input type="checkbox"/> OLV/IPM <input type="checkbox"/> AOLV/IPM <input type="checkbox"/> CLV/IPM <input type="checkbox"/> EZOLV Configures the gain for the monitor selected with b5-55 [PID feedback monitor selection].	1.00 (0.00 - 10.00)

Note:

This parameter is enabled only when b5-18 = 1.

■ b5-57: PID Feedback Monitor Bias

No. (Hex.)	Name	Description	Default Setting (Range)
b5-57 (11DD)	PID Feedback Monitor Bias	<input type="checkbox"/> V/f <input type="checkbox"/> CL-V/f <input type="checkbox"/> OLV <input type="checkbox"/> CLV <input type="checkbox"/> AOLV <input type="checkbox"/> OLV/IPM <input type="checkbox"/> AOLV/IPM <input type="checkbox"/> CLV/IPM <input type="checkbox"/> EZOLV Configures the bias for the monitor selected with b5-55 [PID feedback monitor selection].	0.00 (-10.00 - +10.00)

■ b5-58 through b5-60: PID Setpoints 2 through 4

No. (Hex.)	Name	Description	Default Setting (Range)
b5-58 through b5-60 (1182 - 1184) RUN	PID Setpoints 2 through 4	<input type="checkbox"/> V/f <input type="checkbox"/> CL-V/f <input type="checkbox"/> OLV <input type="checkbox"/> CLV <input type="checkbox"/> AOLV <input type="checkbox"/> OLV/IPM <input type="checkbox"/> AOLV/IPM <input type="checkbox"/> CLV/IPM <input type="checkbox"/> EZOLV Configures the PID setpoint selected with H1-xx = 3E or 3F [Terminal Sx Function Select = PID Setpoint Selection 1/2]. This parameter is configured on the basis of the maximum output frequency being the 100% value.	0.00% (0.00 - 100.00%)

The following illustrates the relationship regarding the switching of multi-function digital input PID setpoints (H1-xx = 3E or 3F).

H1-xx = 3E	H1-xx = 3F	PID Setpoint Value
OFF	OFF	No switch
ON	OFF	b5-58 [PID setpoint2]
OFF	ON	b5-59 [PID setpoint3]
ON	ON	b5-60 [PID setpoint4]

■ b5-61: PID Trim lower limit selection

No. (Hex.)	Name	Description	Default Setting (Range)
b5-61 (119A)	PID Trim lower limit selection	<input type="checkbox"/> V/f <input type="checkbox"/> CL-V/f <input type="checkbox"/> OLV <input type="checkbox"/> CLV <input type="checkbox"/> AOLV <input type="checkbox"/> OLV/IPM <input type="checkbox"/> AOLV/IPM <input type="checkbox"/> CLV/IPM <input type="checkbox"/> EZOLV Configures the function used to adjust the PID output in proportion with the frequency reference.	0 (0, 1)

0 : Disabled

Does not adjust the PID output using the frequency reference.

1 : Enabled

Adjusts the PID output in proportion to the frequency reference. The lower limit of the post-adjustment value is determined by the setting value of b5-62, and the upper limit is determined by the maximum output frequency.

11.3 b: Application

Note:

- This parameter is enabled only when $b5-01 = 3, 4, 7, \text{ or } 8$.
- When $b5-61 = 1$, adjustments can be made with PID output that is proportional to the frequency reference using the following expression.

$$U5-03 = U5-03 \times \left| \frac{Fref}{Fmax} \right|^{*1}$$

$U5-03$ [PID Output], $Fref$ [Freq Reference], and $Fmax$ [Maximum Output Frequency]

*1 Lower limit = $b5-62$ [PID Trim lower limit], Upper limit = Maximum output frequency

■ b5-62: PID Trim lower limit

No. (Hex.)	Name	Description	Default Setting (Range)
b5-62 (119B)	PID Trim lower limit	<input type="checkbox"/> V/f <input type="checkbox"/> CL-V/f <input type="checkbox"/> OLV <input type="checkbox"/> CLV <input type="checkbox"/> AOLV <input type="checkbox"/> OLV/PM <input type="checkbox"/> AOLV/PM <input type="checkbox"/> CLV/PM <input type="checkbox"/> EZOLV Configures the lower limit of the PID frequency reference trim on the basis of the maximum output frequency as the 100% value.	0.00% (0.00 - 100.00%)

Note:

This parameter is enabled only when $b5-01 = 3, 4, 7, \text{ or } 8$.

■ b5-63: Differential PID Feedback Select

No. (Hex.)	Name	Description	Default Setting (Range)
b5-63 (119C)	Differential PID Feedback Select	<input type="checkbox"/> V/f <input type="checkbox"/> CL-V/f <input type="checkbox"/> OLV <input type="checkbox"/> CLV <input type="checkbox"/> AOLV <input type="checkbox"/> OLV/PM <input type="checkbox"/> AOLV/PM <input type="checkbox"/> CLV/PM <input type="checkbox"/> EZOLV Selects the monitor ($Ux-xx$) used as the PID Differential Feedback.	000 (000 - 999)

Note:

- Parameter $U5-xx$ cannot be selected.
- This parameter is disabled when $b5-63 = 000$.

■ b5-64: Differential PID Feedback Gain

No. (Hex.)	Name	Description	Default Setting (Range)
b5-64 (119D)	Differential PID Feedback Gain	<input type="checkbox"/> V/f <input type="checkbox"/> CL-V/f <input type="checkbox"/> OLV <input type="checkbox"/> CLV <input type="checkbox"/> AOLV <input type="checkbox"/> OLV/PM <input type="checkbox"/> AOLV/PM <input type="checkbox"/> CLV/PM <input type="checkbox"/> EZOLV Configures the gain of the monitor configured with $b5-63$ [Differential PID Feedback Select].	1.00 (0.00 - 10.00)

Note:

This parameter is enabled only when $b5-18 = 1$ [PID Setpoint Selection = Enabled].

■ b5-65: PID Diff Fdbk Monitor Bias

No. (Hex.)	Name	Description	Default Setting (Range)
b5-65 (119F)	PID Diff Fdbk Monitor Bias	<input type="checkbox"/> V/f <input type="checkbox"/> CL-V/f <input type="checkbox"/> OLV <input type="checkbox"/> CLV <input type="checkbox"/> AOLV <input type="checkbox"/> OLV/PM <input type="checkbox"/> AOLV/PM <input type="checkbox"/> CLV/PM <input type="checkbox"/> EZOLV Configures the bias for the monitor selected with $b5-63$ [Differential PID Feedback Select].	0.00 (-10.00 - +10.00)

Note:

This parameter is enabled only when $b5-18 = 1$ [PID Setpoint Selection = Enabled].

■ b5-66: PID Feedback Monitor Lvl

No. (Hex.)	Name	Description	Default Setting (Range)
b5-66 (11DE)	PID feedback monitor Lvl	<input type="checkbox"/> V/f <input type="checkbox"/> CL-V/f <input type="checkbox"/> OLV <input type="checkbox"/> CLV <input type="checkbox"/> AOLV <input type="checkbox"/> OLV/PM <input type="checkbox"/> AOLV/PM <input type="checkbox"/> CLV/PM <input type="checkbox"/> EZOLV Configures the signal level for the monitor selected with $b5-55$ [PID feedback monitor selection].	0 (0, 1)

0 : Absolute

1 : +/-

■ b5-67: PID Diff Fdbk Monitor Lvl

No. (Hex.)	Name	Description	Default Setting (Range)
b5-67 (11DF)	PID Diff Fdbk monitor Lvl	<div style="display: flex; justify-content: space-between; font-size: 0.8em; font-weight: bold;"> V/f CL-V/f OLV CLV AOLV OLV/PM AOLV/PM CLV/PM EZOLV </div> Configures the signal level for the monitor selected with <i>b5-63 [Differential PID Feedback Select]</i> .	0 (0, 1)

0 : Absolute

1 : +/-

■ b5-89: Sleep Method Selection

No. (Hex.)	Name	Description	Default Setting (Range)
b5-89 (0B89) RUN	Sleep Method Selection	<div style="display: flex; justify-content: space-between; font-size: 0.8em; font-weight: bold;"> V/f CL-V/f OLV CLV AOLV OLV/PM AOLV/PM CLV/PM EZOLV </div> Configures the sleep and start operations modes when using the PID function.	0 (0, 1)

0 : Standard

1 : EZ Sleep/Wake-up

■ b5-90: EZ Sleep Unit

No. (Hex.)	Name	Description	Default Setting (Range)
b5-90 (0B90)	EZ Sleep Unit	<div style="display: flex; justify-content: space-between; font-size: 0.8em; font-weight: bold;"> V/f CL-V/f OLV CLV AOLV OLV/PM AOLV/PM CLV/PM EZOLV </div> Configures the unit of measure for <i>b5-91 [EZ Minimum Speed]</i> and <i>b5-92 [EZ Sleep Level]</i> .	0 (0, 1)

0 : 0.1Hz units

1 : rev/min

■ b5-91: EZ Minimum Speed

No. (Hex.)	Name	Description	Default Setting (Range)
b5-91 (0B91) RUN	EZ Minimum Speed	<div style="display: flex; justify-content: space-between; font-size: 0.8em; font-weight: bold;"> V/f CL-V/f OLV CLV AOLV OLV/PM AOLV/PM CLV/PM EZOLV </div> Configures the minimum speed for the EZ Sleep/Wake-up function. The larger value between <i>b5-91</i> , <i>b5-34 [PID Output Lower Limit]</i> , and <i>d2-02 [Frequency Reference Lower Limit]</i> is used internally to configure this parameter.	0.0 Hz or 0 min ⁻¹ (r/min) (0.0 to 590.0 Hz or 0 to 35400 min ⁻¹ (r/min))

Note:

The unit of measure is determined by the setting value of *b5-90 [EZ Sleep Unit]*. This parameter is not automatically updated when *b5-90* is changed. Make sure to reconfigure this parameter if the setting value of *b5-90* is changed.

■ b5-92: EZ Sleep Level

No. (Hex.)	Name	Description	Default Setting (Range)
b5-92 (0B92) RUN	EZ Sleep Level	<div style="display: flex; justify-content: space-between; font-size: 0.8em; font-weight: bold;"> V/f CL-V/f OLV CLV AOLV OLV/PM AOLV/PM CLV/PM EZOLV </div> The drive enters the sleep state when the output frequency or motor speed drops below the value of <i>b5-92</i> for a time longer than the setting value of <i>b5-93 [EZ Sleep Time]</i> .	0.0 Hz or 0 min ⁻¹ (r/min) (0.0 to 590.0 Hz or 0 to 35400 min ⁻¹ (r/min))

Note:

The unit of measure is determined by the setting value of *b5-90 [EZ Sleep Unit]*. This parameter is not automatically updated when *b5-90* is changed. Make sure to reconfigure this parameter if the setting value of *b5-90* is changed.

■ b5-93: EZ Sleep Time

No. (Hex.)	Name	Description	Default Setting (Range)
b5-93 (0B93) RUN	EZ Sleep Time	<div style="display: flex; justify-content: space-between; font-size: 0.8em; font-weight: bold; margin-bottom: 5px;"> V/f CL-V/f OLV CLV AOLV OLV/PM AOLV/PM CLV/PM EZOLV </div> The drive enters the sleep state when the output frequency or motor speed drops below the value of <i>b5-92 [EZ Sleep Level]</i> for a time longer than the setting value of <i>b5-93</i> .	5.0 s (0.0 - 1000.0 s)

■ b5-94: EZ Wake-up Level

No. (Hex.)	Name	Description	Default Setting (Range)
b5-94 (0B94) RUN	EZ Wake-up Level	<div style="display: flex; justify-content: space-between; font-size: 0.8em; font-weight: bold; margin-bottom: 5px;"> V/f CL-V/f OLV CLV AOLV OLV/PM AOLV/PM CLV/PM EZOLV </div> Configures the level at which the drive resumes operation from the Sleep mode.	0.00% (0.00 - 600.00%)

Note:

The unit of measure is determined by the settings of *b5-20 [PID Setpoint Scaling]*, *b5-38 [PID Setpoint User Display]*, and *b5-39 [PID Setpoint Display Digits]*. This parameter is not automatically updated when *b5-20*, *b5-38*, and *b5-39* are changed. Make sure to reconfigure this parameter if the setting values of *b5-20*, *b5-38*, and *b5-39* are changed.

- When *b5-95 = 0 [EZ Wake-up Mode = Absolute]*:
The drive resumes operation from the sleep state when the *CASE AI 1 [H3-xx = 20]* drops below the setting value of *b5-94* for a time longer than the setting value of *b5-96 [EZ Wake-up Time]* while *b5-09 = 0 [PID Output Level Selection = Normal output (direct acting)]*. The drive resumes operation from the sleep state when the PID feedback rises above the setting value of *b5-94* for a time longer than the setting value of *b5-96* while *b5-09 = 1 [PID Output Level Selection = Reverse output (reverse acting)]*.
- When *b5-95 = 1 [Setpoint Delta]*:
The drive resumes operation from the sleep state when the PID feedback drops below the setting value of *b5-94* for a time longer than the setting value of *b5-96* while *b5-09 = 0 [PID Output Level Selection = Normal output (direct acting)]*. The drive resumes operation from the sleep state when the PID feedback rises above the setting value of *b5-94* for a time longer than the setting value of *b5-96* while *b5-09 = 1 [PID Output Level Selection = Reverse output (reverse acting)]*.

■ b5-95: EZ Wake-up Mode

No. (Hex.)	Name	Description	Default Setting (Range)
b5-95 (0B95)	EZ Wake-up Mode	<div style="display: flex; justify-content: space-between; font-size: 0.8em; font-weight: bold; margin-bottom: 5px;"> V/f CL-V/f OLV CLV AOLV OLV/PM AOLV/PM CLV/PM EZOLV </div> Selects the wake-up mode used when resuming operation from the Sleep mode.	0 (0, 1)

0 : Absolute

1 : Setpoint Delta

■ b5-96: EZ Wake-up Time

No. (Hex.)	Name	Description	Default Setting (Range)
b5-96 (0B96)	EZ Wake-up Time	<div style="display: flex; justify-content: space-between; font-size: 0.8em; font-weight: bold; margin-bottom: 5px;"> V/f CL-V/f OLV CLV AOLV OLV/PM AOLV/PM CLV/PM EZOLV </div> Configures the EZ Wake-up time.	1.0 s (0.0 - 1000.0 s)

The drive resumes operation from the sleep state when the PID feedback has dropped below the value of *b5-94 [EZ Wake-up Level]* continuously for the time configured with *b5-96*.

◆ b6: Dwell Function

The Dwell function briefly maintains the output frequency at start and stop.

This prevents motor speed loss when stopping and starting heavy loads. The Dwell function is also enabled when shock occurs at the beginning of acceleration and deceleration due to backlash on the machine side.

At the start of acceleration, the drive automatically operates at low speed using the output frequency and acceleration time set for the Dwell function to minimize the effects of backlash. Afterwards, the drive can accelerate again. The Dwell function is used in the same way for deceleration.

For a conveyor, the Dwell function also allows the drive to interlock the output frequency and a delay time for the holding brake on the load side.

The Dwell function prevents a PM motor from stepping out by briefly pausing during acceleration. The following diagram shows how the Dwell function works.

Note:

Set $b1-03 = 0$ [Stopping Method Selection = Ramp to Stop] when using the Dwell function at stop.

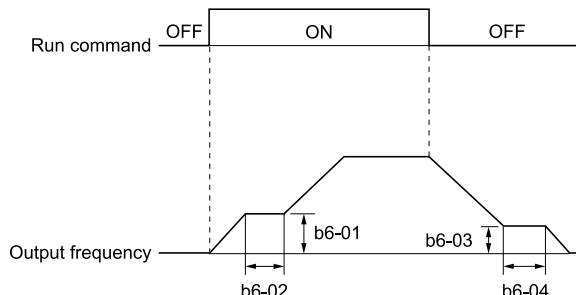

Figure 11.40 Time Chart for the Dwell Function at Start/Stop

■ b6-01: Dwell Reference at Start

No. (Hex.)	Name	Description	Default (Range)
b6-01 (01B6)	Dwell Reference at Start	V/f CL-V/f OLV CLV AOLV OLV/PM AOLV/PM CLV/PM EZOLV Sets the output frequency to briefly maintain when starting the motor.	0.0 (Determined by A1-02)

Once the drive accelerates to the output frequency set in $b6-01$, it holds that frequency for the time set in $b6-02$ [Dwell Time at Start], and then resumes acceleration.

■ b6-02: Dwell Time at Start

No. (Hex.)	Name	Description	Default (Range)
b6-02 (01B7)	Dwell Time at Start	V/f CL-V/f OLV CLV AOLV OLV/PM AOLV/PM CLV/PM EZOLV Sets the time for the drive to hold the output frequency when starting the motor.	0.0 s (0.0 - 10.0 s)

■ b6-03: Dwell Reference at Stop

No. (Hex.)	Name	Description	Default (Range)
b6-03 (01B8)	Dwell Reference at Stop	V/f CL-V/f OLV CLV AOLV OLV/PM AOLV/PM CLV/PM EZOLV Sets the output frequency to briefly maintain when ramping to stop.	0.0 (Determined by A1-02)

Once the drive decelerates to the output frequency set in $b6-03$, it holds that frequency for the time set in $b6-04$ [Dwell Time at Stop] and then resumes deceleration.

■ b6-04: Dwell Time at Stop

No. (Hex.)	Name	Description	Default (Range)
b6-04 (01B9)	Dwell Time at Stop	V/f CL-V/f OLV CLV AOLV OLV/PM AOLV/PM CLV/PM EZOLV Sets the time for the drive to hold the output frequency when ramping to stop.	0.0 s (0.0 - 10.0 s)

◆ b7: Droop Control

Droop control automatically balances the load level between two motors driving the same load.

Droop control reduces motor speed in accordance with changes to the load. The Droop control function needs to be enabled for each motor it is driving.

11.3 b: Application

The Droop control function reduces motor speed by lowering the speed reference when the torque reference rises due to an increase in the load. The Droop control function increases motor speed by raising the speed reference when the torque reference drops due to a decrease in the load. The Droop control function adjusts motor speed in accordance with changes in the torque reference to balance the load between the motors.

Note:

Set $n5-01 = 0$ [Feed Forward Control Selection = Disabled] when using the Droop control.

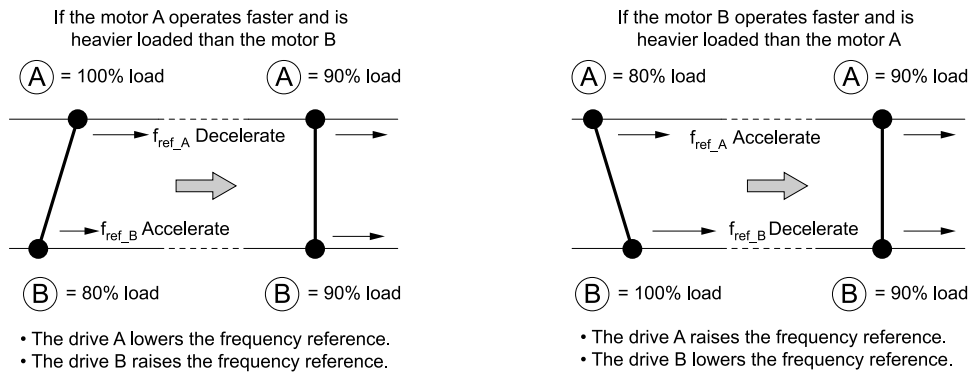

Figure 11.41 Droop Control (Traveling Motion of a Crane Is Viewed from Above)

■ b7-01: Droop Control Gain

No. (Hex.)	Name	Description	Default (Range)
b7-01 (01CA) RUN	Droop Control Gain	<input type="checkbox"/> V/f <input type="checkbox"/> CL-V/f <input type="checkbox"/> OLV <input checked="" type="checkbox"/> CLV <input type="checkbox"/> AOLV <input type="checkbox"/> OLV/PM <input type="checkbox"/> AOLV/PM <input type="checkbox"/> CLV/PM <input type="checkbox"/> EZOLV Sets the amount of deceleration when the torque reference is at 100% as a percentage of Maximum Output Frequency.	0.0% (0.0 - 100.0%)

Set $b7-01$ to 0.0% to disable Droop control.

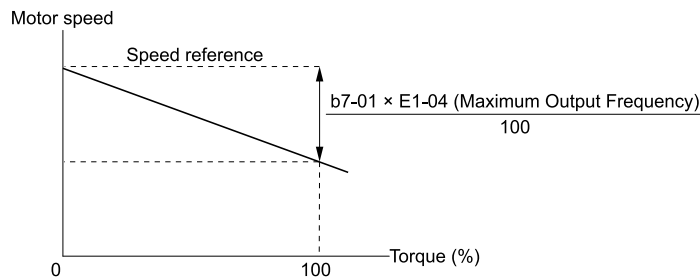

Figure 11.42 Droop Control Gain

■ b7-02: Droop Control Delay Time

No. (Hex.)	Name	Description	Default (Range)
b7-02 (01CB) RUN	Droop Control Delay Time	<input type="checkbox"/> V/f <input type="checkbox"/> CL-V/f <input type="checkbox"/> OLV <input checked="" type="checkbox"/> CLV <input type="checkbox"/> AOLV <input type="checkbox"/> OLV/PM <input type="checkbox"/> AOLV/PM <input checked="" type="checkbox"/> CLV/PM <input type="checkbox"/> EZOLV Adjusts the responsiveness of Droop control. Lower this setting when drive response is slow. Raise this setting when hunting or oscillation occur.	0.05 s (0.03 - 2.00 s)

■ b7-03: Droop Control Limit Selection

No. (Hex.)	Name	Description	Default (Range)
b7-03 (017E)	Droop Control Limit Selection	<input type="checkbox"/> V/f <input type="checkbox"/> CL-V/f <input type="checkbox"/> OLV <input checked="" type="checkbox"/> CLV <input type="checkbox"/> AOLV <input type="checkbox"/> OLV/PM <input type="checkbox"/> AOLV/PM <input type="checkbox"/> CLV/PM <input type="checkbox"/> EZOLV Enables or disables the limit when using Droop control.	1 (0, 1)

0 : Disabled

1 : Enabled

◆ b8: Energy Saving

Energy-saving control improves overall system operating efficiency by operating the motor at its most efficient level.

Set *b8-01* and the following parameters according to the control mode and the motor.

- Set parameters *b8-04*, *b8-05*, and *b8-06* when using V/f Control or Closed Loop V/f Control.
- Set parameters *b8-02*, *b8-03* when using vector control with an induction motor.
- Set parameters *b8-16*, *b8-17* when using a PM motor.

Note:

- Energy-saving control is not appropriate for applications with sudden changes in the load, or applications driving heavy loads such as a traverse car application.
- Energy-saving control maximizes operation based on precise motor data set to the drive. Be sure to perform Auto-Tuning and enter the correct information about the motor before using the Energy-saving control.

■ b8-01: Energy Saving Control Selection

No. (Hex.)	Name	Description	Default (Range)
b8-01 (01CC)	Energy Saving Control Selection	<div style="display: flex; justify-content: space-between; font-size: 0.8em; font-weight: bold; background-color: #f0f0f0; padding: 2px;"> V/f CL-V/f OLV CLV AOLV OLV/PM AOLV/PM CLV/PM EZOLV </div> Enables or disables Energy-saving control.	0 (Determined by A1-02)

0 : Disabled

1 : Enabled

2 : Search Enabled

■ b8-02: Energy Saving Gain

No. (Hex.)	Name	Description	Default Setting (Range)
b8-02 (01CD) RUN	Energy Saving Gain	<div style="display: flex; justify-content: space-between; font-size: 0.8em; font-weight: bold; background-color: #f0f0f0; padding: 2px;"> V/f CL-V/f OLV CLV AOLV OLV/PM AOLV/PM CLV/PM EZOLV </div> Configures the gain for energy-saving control.	Determined by A1-02 (0.0 - 10.0)

Increasing the setting value increases the energy conservation effect. If the setting value is excessive, the motor may stall.

■ b8-03: Energy Saving Filter Time

No. (Hex.)	Name	Description	Default Setting (Range)
b8-03 (01CE) RUN	Energy Saving Filter Time	<div style="display: flex; justify-content: space-between; font-size: 0.8em; font-weight: bold; background-color: #f0f0f0; padding: 2px;"> V/f CL-V/f OLV CLV AOLV OLV/PM AOLV/PM CLV/PM EZOLV </div> Configures the responsiveness for energy-saving control.	Determined by A1-02, C6-01, and o2-04 (0.00 - 10.00 s)

Reducing the setting value improves responsiveness. However, if the setting value is too low, operation may become unstable.

■ b8-04: Energy Saving Coefficient Value

No. (Hex.)	Name	Description	Default Setting (Range)
b8-04 (01CF)	Energy Saving Coefficient Value	<div style="display: flex; justify-content: space-between; font-size: 0.8em; font-weight: bold; background-color: #f0f0f0; padding: 2px;"> V/f CL-V/f OLV CLV AOLV OLV/PM AOLV/PM CLV/PM EZOLV </div> Configures the energy-saving coefficient. The energy-saving coefficient is used to maintain maximum motor efficiency. The default setting is the Yaskawa motor value.	Determined by C6-01, E2-11, and o2-04. (0.00 - 655.00)

When using motors from other manufacturers, increase the setting value in increments of 5% to find the minimum value usable for *U1-08 [Output Power]* at light loads.

Reducing the setting value reduces the output voltage to reduce power consumption. However, if the setting value is too small, the motor may stall.

Note:

The energy-saving coefficient is automatically configured when Rotational Auto-Tuning is performed.

■ **b8-05: Power Detection Filter Time**

No. (Hex.)	Name	Description	Default Setting (Range)
b8-05 (01D0)	Power Detection Filter Time	V/f CL-V/f OLV CLV AOLV OLV/PM AOLV/PM CLV/PM EZOLV Configures the time constant used by the drive to measure output power.	20 ms (0 - 2000 ms)

Reducing the setting value improves responsiveness to load changes. However, motor speed becomes unstable if the setting value is too low during operation at light loads.

■ **b8-06: Search Operation Voltage Limit**

No. (Hex.)	Name	Description	Default Setting (Range)
b8-06 (01D1)	Search Operation Voltage Limit	V/f CL-V/f OLV CLV AOLV OLV/PM AOLV/PM CLV/PM EZOLV On the basis that the motor rated voltage is the 100% value, this parameter configures the limit value of the voltage range defined for Search Operations as a percentage.	0% (0 - 100%)

The Search Operation is a function that changes the output voltage in fine increments to find a setpoint at which the drive can operate using the minimum amount of power.

Setting this parameter to 0 disables the Search Operation function. However, energy-saving control will still be enabled.

If the setting value is too low, the motor may stall when loads suddenly increase.

■ **b8-16: PM E-Save Coefficient Ki**

No. (Hex.)	Name	Description	Default Setting (Range)
b8-16 (01F8)	PM E-Save Coefficient Ki	V/f CL-V/f OLV CLV AOLV OLV/PM AOLV/PM CLV/PM EZOLV This coefficient maintains torque linearity. Enter the Ki value written on the motor nameplate. Normally there is no need to change this setting.	1.00 (0.00 - 3.00)

The energy-saving coefficient is automatically calculated and controlled when $b8-16 = 1.00$ (default setting). If the motor nameplate contains the "Ki" description, set this parameter to that Ki value.

Follow the following procedure to prevent oscillation that may occur when setting $b8-01 = 1$ [Energy Saving Control Selection = Enabled].

1. Check U5-21 [AutoCalEnSav Coef Ki] and make sure it is the same as the Ki value written on the motor nameplate.
2. If the numbers are different, then set $b8-16$ to the Ki value written on the motor nameplate.

■ **b8-17: PM E-Save Coefficient Kt**

No. (Hex.)	Name	Description	Default Setting (Range)
b8-17 (01F9)	PM E-Save Coefficient Kt	V/f CL-V/f OLV CLV AOLV OLV/PM AOLV/PM CLV/PM EZOLV This coefficient maintains torque linearity. Enter the Kt value written on the motor nameplate. Normally there is no need to change this setting.	1.00 (0.00 - 3.00)

The drive controls operation with the Energy-saving coefficient Kt it automatically calculated internally when $E5-01 = 1xxx, 2xxx$ [PM Motor Code Selection = Yaskawa SSRI or SST4 series IPM motor].

Follow the following procedure to prevent oscillation that may occur when setting $b8-01 = 1$ [Energy Saving Control Selection = Enabled].

1. Check U5-22 [Auto Cal En Sav Coef Kt] and make sure it is the same as the Kt value written on the motor nameplate.
2. If the numbers are different, then set $b8-17$ to the Kt value written on the motor nameplate.

■ b8-18: E-Save d-axis Current FilterTime

No. (Hex.)	Name	Description	Default Setting (Range)
b8-18 (01FA)	E-Save d-axis Current FilterTime	V/f CL-V/f OLV CLV AOLV OLV/PM AOLV/PM CLV/PM EZOLV Configures the d-axis current reference filter time constant.	0.100 s (0.000 - 5.000 s)

■ b8-19: E-Save Search Injection Freq

No. (Hex.)	Name	Description	Default Setting (Range)
b8-19 (0B40)	E-Save Search Injection Freq	V/f CL-V/f OLV CLV AOLV OLV/PM AOLV/PM CLV/PM EZOLV Configures the energy-saving control search operation frequency. Normally there is no need to change this setting.	Determined by A1-02 (20 - 300 Hz)

Note:

- If the machine vibrates due to low inertia, increase the setting value in increments of 10 Hz while checking the responsiveness. If $A1-02 = 8$ [Control Method Selection = EZ Open Loop Vector Control], increase the setting value in increments of 1 Hz.
- To improve motor efficiency, reduce the setting value in increments of 1 Hz until the point just before machine vibration begins to occur.

■ b8-20: PM E-Save Search Width

No. (Hex.)	Name	Description	Default Setting (Range)
b8-20 (0B41)	PM E-Save Search Width	V/f CL-V/f OLV CLV AOLV OLV/PM AOLV/PM CLV/PM EZOLV Configures the amplitude of energy-saving control search operations.	1.0 degrees (0.1 to 5.0 degrees)

Increasing the value may improve operational efficiency. However, adjustment may be necessary to prevent machine vibration if the load inertia is small.

Note:

- If the machine vibrates due to low inertia, reduce the setting value in increments of 1.0 degrees while checking the responsiveness.
- To improve motor efficiency, increase the setting value in increments of 1.0 degrees until the point just before machine vibration begins to occur.

■ b8-21: PM E-Save Search Gain

No. (Hex.)	Name	Description	Default Setting (Range)
b8-21 (0B42)	PM E-Save Search Gain	V/f CL-V/f OLV CLV AOLV OLV/PM AOLV/PM CLV/PM EZOLV Configures the gain of search operations.	0.3Hz (0.1 - 20.0 Hz)

When the value of $C5-01$ [ASR Proportional Gain 1] is reduced, make sure to also reduce the value of $b8-21$ to maintain the correct ratio.

■ b8-22: PM E-Save Search LPF Cutoff Freq

No. (Hex.)	Name	Description	Default Setting (Range)
b8-22 (0B43)	PM E-Save Search LPF Cutoff Freq	V/f CL-V/f OLV CLV AOLV OLV/PM AOLV/PM CLV/PM EZOLV Configures the frequency of the filter used to extract the high-efficiency phase from search operations. Normally there is no need to change this setting.	10.0 Hz (1.0 - 30.0 Hz)

■ b8-23: PM E-Save Search Limit

No. (Hex.)	Name	Description	Default Setting (Range)
b8-23 (0B44)	PM E-Save Search Limit	V/f CL-V/f OLV CLV AOLV OLV/PM AOLV/PM CLV/PM EZOLV Configures the limit value of search operation output. Normally there is no need to change this setting.	15.0 degrees (0.0 to 30.0 degrees)

Depending on the motor characteristics, increasing this value may improve efficiency.

■ b8-24: PM E-Save High Freq ACR Gain

No. (Hex.)	Name	Description	Default Setting (Range)
b8-24 (0B45)	PM E-Save High Freq ACR Gain	V/f CL-V/f OLV CLV AOLV OLV/PM AOLV/PM CLV/PM EZOLV Configures the gain for high-frequency current control.	200.0 Hz (100.0 - 1000.0 Hz)

Note:

Reduce the value if *oC [Overcurrent]* occurs.

■ b8-25: PM E-Save Search Start level

No. (Hex.)	Name	Description	Default Setting (Range)
b8-25 (0B46)	PM E-Save Search Start level	V/f CL-V/f OLV CLV AOLV OLV/PM AOLV/PM CLV/PM EZOLV Configures the level at which search operations start.	10.0% (0.0 - 100.0%)

Note:

Increase the value when the machine vibrates.

■ b8-26: PM E-Save Power Setpoint

No. (Hex.)	Name	Description	Default Setting (Range)
b8-26 (0B47)	PM E-Save Power Setpoint	V/f CL-V/f OLV CLV AOLV OLV/PM AOLV/PM CLV/PM EZOLV Adjust this parameter when torque accuracy cannot be ensured.	0.0% (-10.0 - +10.0%)

■ b8-28: Save Energy Priority Function

No. (Hex.)	Name	Description	Default Setting (Range)
b8-28 (0B8B)	Save Energy Priority Function	V/f CL-V/f OLV CLV AOLV OLV/PM AOLV/PM CLV/PM EZOLV Enables and disables operation toward an overexcitation state.	0 (0, 1)

Enable this parameter when operation is unstable at low speeds.

0 : Priority:Followingness

1 : Priority:Save Energy

■ b8-29: Save Energy Priority Function

No. (Hex.)	Name	Description	Default Setting (Range)
b8-29 (0B8C)	Save Energy Priority Function	V/f CL-V/f OLV CLV AOLV OLV/PM AOLV/PM CLV/PM EZOLV Switches between prioritizing the capability to respond to load changes or the energy-saving control.	0 (0, 1)

Enable this parameter when load changes are minimal. The motor may not be able to respond appropriately to load changes.

0 : Priority:Followingness

1 : Priority:Save Energy

■ b8-50: Standby Mode Selection

No. (Hex.)	Name	Description	Default Setting (Range)
b8-50 (0B0D)	Standby mode selection	V/f CL-V/f OLV CLV AOLV OLV/PM AOLV/PM CLV/PM EZOLV Enables and disables standby mode.	0 (0, 1)

0 : Disabled

1 : Enabled

Standby mode reduces power consumed by the drive while in the standby state.

In doing so, this mode shuts off the main circuit power supply by shutting off the input side electromagnetic contactor (MC) using the relay output of a multi-function digital output terminal after the drive stops, and reduces standby electricity of the drive.

Note:

Make sure the following conditions are satisfied when using this function.

- Connect an external 24 V power supply.
- Connect a electromagnetic contactor to the drive input side and connect the multi-function digital output terminal that has been configured with $H2-xx = 65$ [Standby output]. The electromagnetic contactor must be off when the multi-function digital output terminal is off.
- Repetitive opening and closing of the electromagnetic contactor due to frequent starts and stops may reduce the service life of the drive.

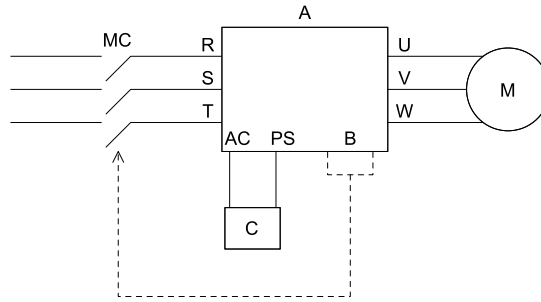

A - Drive
 B - Multi-function Digital Output Terminal
 C - External 24 V power supply

■ **b8-51: Standby Mode Waiting Time**

No. (Hex.)	Name	Description	Default Setting (Range)
b8-51 (0B01)	Standby mode waiting time	V/f CL-V/f OLV CLV AOLV OLV/PM AOLV/PM CLV/PM EZOLV Configures the delay time until the input side electromagnetic contactor shuts off after the drive stops.	600 s (0 - 6000 s)

◆ **b9: Zero Servo**

Zero Servo is a position control function that stops and holds the motor shaft. The drive secures the stopped motor so that the motor does not move when an external force is applied.

The drive saves the home position when the Zero Servo function is enabled. The drive can correct the motor position to bring the motor back to the home position, even if the load rotates the motor.

Set $H1-xx = 72$ [MFDI Function Select = Zero Servo] to enable Zero Servo. The drive begins Zero Servo once the multi-function digital input terminal set for Zero Servo [$H1-xx = 72$] switches ON and the motor speed drops below the value set in $b2-01$ [DC Injection/Zero SpeedThreshold]. The drive stops and holds the motor in the Zero Servo start position. The drive will continue to hold the motor in position as long as Zero Servo is enabled, even if the frequency reference rises above the setting in $b2-01$. The drive accelerates back to the frequency reference when the multi-function digital input terminal assigned to trigger the Zero Servo function is released and the Run command is still present.

Note:

Zero Servo is available when $A1-02 = 3, 7$ [Control Method Selection = Closed Loop Vector Control, PM Closed Loop Vector Control].

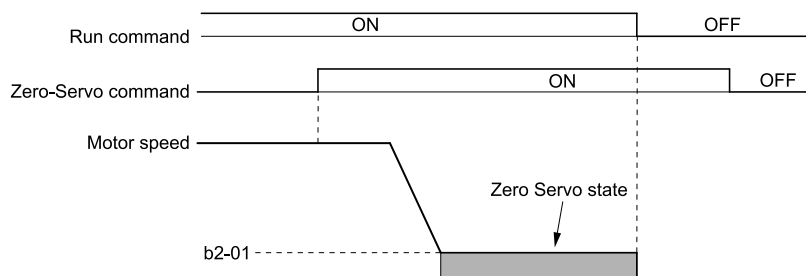

Figure 11.43 Zero Servo Time Chart

11.3 b: Application

Monitor *U6-22 [ZeroServoPulse Move]* displays the deviation between the actual position of the motor shaft and Zero Servo start position when Zero Servo is enabled. Divide the number of pulses shown in *U6-22* by 4 to find deviation.

The drive will turn ON a multi-function digital output terminal set for *Zero Servo Complete [H2-xx = 33]* once the position of the motor shaft is within the range “Zero Servo start position \pm *b9-02 [Zero Servo Completion Width]*.”

Note:

- Leave the Run command ON when using the Zero Servo function. The drive will not hold the motor shaft in position if the Run command is switched OFF.
- The terminal set for Zero Servo Complete will switch OFF once the Zero-Servo command is switched OFF.
- Do not have the Zero Servo function hold 100% load for prolonged periods of time. Doing so may damage the drive. If the application needs to hold 100% load for long periods using Zero Servo, then either operate within 50% of the drive rated output current, or select a larger capacity drive.
- The drive will detect *dv4 [Inversion Prevention Detection]* if an external force rotates the motor during Zero Servo when *A1-02 = 7 [PM Closed Loop Vector Control]*. Increase *b9-01 [Zero Servo Gain]* or increase the number of pulses set in *F1-19 [Deviation 4 Detection Selection]* to prevent *dv4* detection.

■ b9-01: Zero Servo Gain

No. (Hex.)	Name	Description	Default (Range)
b9-01 (01DA)	Zero Servo Gain	<div style="display: flex; justify-content: space-between; font-size: small;"> V/f CL-V/f OLV CLV AOLV OLV/PM AOLV/PM CLV/PM EZOLV </div> Sets the responsiveness for the Zero Servo function.	5 (0 - 100)

Increase this setting if the drive is not responsive, or if there is too much deviation from the Zero Servo start point when increasing the load. Lower this setting if oscillation or hunting occurs.

Note:

- Parameter *C5-xx [Automatic Speed Regulator (ASR)]* must be set appropriately before adjusting the Zero Servo gain.
- Oscillation and hunting should not occur while operating with the Zero-Servo command enabled.

■ b9-02: Zero Servo Completion Width

No. (Hex.)	Name	Description	Default (Range)
b9-02 (01DB)	Zero Servo Completion Width	<div style="display: flex; justify-content: space-between; font-size: small;"> V/f CL-V/f OLV CLV AOLV OLV/PM AOLV/PM CLV/PM EZOLV </div> Sets the output width that triggers the Zero Servo complete command. Set the allowable position displacement (deviation) from Zero Servo start position.	10 (0 - 16383)

The drive will turn ON a multi-function digital output terminal set for *Zero Servo Complete [H2-xx = 33]* once the position of the motor shaft is within the range “Zero Servo start position \pm *b9-02*.”

11.4 C: Tuning

C parameters are used to adjust drive operation.

- Acceleration Time
- Deceleration Time
- Slip Compensation
- Torque Compensation
- Carrier Frequency

◆ C1: Accel and Decel Times

Four different sets of acceleration and deceleration times can be set in this product. Acceleration and deceleration times can be switched during run when switching H1-xx = 7, 16, 1A [MFDI Function Select = Accel/Decel Time Selection 1, Motor 2 Selection, Accel/Decel Time Selection 2] ON and OFF.

Acceleration time parameters always set the time to accelerate from 0 Hz to *E1-04* [Maximum Output Frequency]. Deceleration time parameters always set the time to decelerate from *E1-04* to 0 Hz.

C1-01 [Acceleration Time 1] and *C1-02* [Deceleration Time 1] are the default active accel/decel settings.

Parameters	Setting Range
<i>C1-01</i> [Acceleration Time 1]	0.0 to 6000.0 s
<i>C1-02</i> [Deceleration Time 1]	
<i>C1-03</i> [Acceleration Time 2]	
<i>C1-04</i> [Deceleration Time 2]	
<i>C1-05</i> [Acceleration Time 3]	
<i>C1-06</i> [Deceleration Time 3]	
<i>C1-07</i> [Acceleration Time 4]	
<i>C1-08</i> [Deceleration Time 4]	

Note:

The setting range for acceleration and deceleration times is 0.00 to 600.00 s when *C1-10* = 0 [Accel/Decel Time Setting Units = 0.01 s (0.00 to 600.00 s)].

■ Switching Acceleration Times by Multi-Function Input Terminal

Select the different acceleration and deceleration times as shown in the following table.

H1-xx = 7 [Accel/decel Time Selection 1]	H1-xx = 1A [Accel/Decel Time Selection 2]	Active Parameter	
		Acceleration Time	Deceleration Time
OFF	OFF	<i>C1-01</i> [Acceleration Time 1]	<i>C1-02</i> [Deceleration Time 1]
ON	OFF	<i>C1-03</i> [Acceleration Time 2]	<i>C1-04</i> [Deceleration Time 2]
OFF	ON	<i>C1-05</i> [Acceleration Time 3]	<i>C1-06</i> [Deceleration Time 3]
ON	ON	<i>C1-07</i> [Acceleration Time 4]	<i>C1-08</i> [Deceleration Time 4]

The following figure shows an operation example for changing acceleration and deceleration times. The example below requires that the stopping method be set for *b1-03* = 0 [Stopping Method Selection = Ramp to Stop].

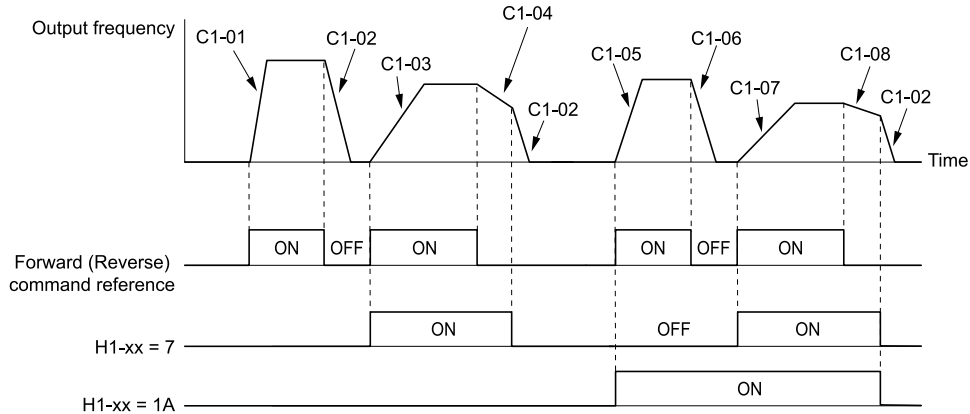

Figure 11.44 Timing Diagram of Acceleration and Deceleration Times

■ Switching Acceleration and Deceleration Times by Motor Selection

Setting $H1-xx = 16$ [MFDI Function Select = Motor 2 Selection] enables switching between motor 1 and motor 2 by turning the input terminal on and off.

Note:

The Motor 2 Selection function cannot be used with PM motors.

The following table lists the possible acceleration and deceleration time combinations when using the Motor 2 Selection function.

Table 11.27 Motor Selection and Acceleration and Deceleration Times

H1-xx = 7 [Accel/decel Time Selection 1]	H1-xx = 16 [Motor 2 Selection]			
	Motor 2 Selection: OFF		Motor 2 Selection: ON	
	Acceleration Time	Deceleration Time	Acceleration Time	Deceleration Time
OFF	C1-01	C1-02	C1-05	C1-06
ON	C1-03	C1-04	C1-07	C1-08

■ Switching Acceleration and Deceleration Times by an Output Frequency Level

The drive can switch between different acceleration and deceleration times automatically by output frequency. The acceleration and deceleration times for the drive are switched automatically when output frequency reaches the setting value set to $C1-11$ [Accel/Decel Time Switchover Freq]. Setting $C1-11 = 0.0$ Hz disables this function.

Note:

- Acceleration and deceleration times set to multi-function digital inputs have priority over the automatic switching by the frequency level set to $C1-11$. For example, if the multi-function digital input terminal set for *Accel/decel Time Selection 1* [$H1-xx = 7$] is ON, the drive will use only accel/decel time 2 (or accel/decel time 4 for motor 2). The automatic switching of acceleration and deceleration times will not be triggered when using a frequency level set to $C1-11$.
- If Motor 2 Selection [$H1-xx = 16$] is ON, the drive will set the acceleration/deceleration time to $C1-05$ and $C1-06$ for motor 2 when the output frequency exceeds the frequency level set to parameter $C1-11$.

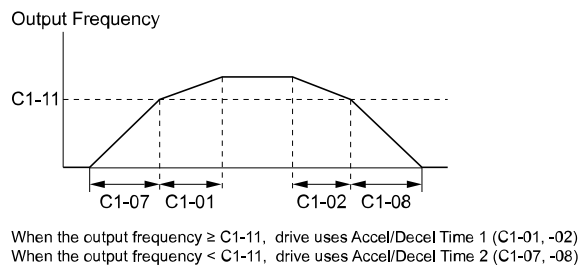

Figure 11.45 Accel/Decel Time Switchover Freq

■ C1-01: Acceleration Time 1

No. (Hex.)	Name	Description	Default (Range)
C1-01 (0200) RUN	Acceleration Time 1	V/f CL-V/f OLV CLV AOLV OLV/PM AOLV/PM CLV/PM EZOLV Sets the time it takes to accelerate from zero to the maximum output frequency.	10.0 s (0.0 - 6000.0 s)

Note:

If $C1-10 = 0$ [Accel/Decel Time Setting Units = 0.01 s (0.00 to 600.00 s)], the setting range will be 0.00 to 600.00 s.

■ C1-02: Deceleration Time 1

No. (Hex.)	Name	Description	Default (Range)
C1-02 (0201) RUN	Deceleration Time 1	V/f CL-V/f OLV CLV AOLV OLV/PM AOLV/PM CLV/PM EZOLV Sets the time it takes to decelerate from the maximum output frequency to zero.	10.0 s (0.0 - 6000.0 s)

Note:

If $C1-10 = 0$ [Accel/Decel Time Setting Units = 0.01 s (0.00 to 600.00 s)], the setting range will be 0.00 to 600.00 s.

■ C1-03: Acceleration Time 2

No. (Hex.)	Name	Description	Default (Range)
C1-03 (0202) RUN	Acceleration Time 2	V/f CL-V/f OLV CLV AOLV OLV/PM AOLV/PM CLV/PM EZOLV Sets the time to accelerate from 0 to maximum frequency.	10.0 s (0.0 - 6000.0 s)

Note:

If $C1-10 = 0$ [Accel/Decel Time Setting Units = 0.01 s (0.00 to 600.00 s)], the setting range will be 0.00 to 600.00 s.

■ C1-04: Deceleration Time 2

No. (Hex.)	Name	Description	Default (Range)
C1-04 (0203) RUN	Deceleration Time 2	V/f CL-V/f OLV CLV AOLV OLV/PM AOLV/PM CLV/PM EZOLV Sets the time to decelerate from maximum frequency to 0.	10.0 s (0.0 - 6000.0 s)

Note:

If $C1-10 = 0$ [Accel/Decel Time Setting Units = 0.01 s (0.00 to 600.00 s)], the setting range will be 0.00 to 600.00 s.

■ C1-05: Acceleration Time 3

No. (Hex.)	Name	Description	Default (Range)
C1-05 (0204) RUN	Acceleration Time 3	V/f CL-V/f OLV CLV AOLV OLV/PM AOLV/PM CLV/PM EZOLV Sets the time to accelerate from 0 to maximum frequency.	10.0 s (0.0 - 6000.0 s)

Note:

If $C1-10 = 0$ [Accel/Decel Time Setting Units = 0.01 s (0.00 to 600.00 s)], the setting range will be 0.00 to 600.00 s.

■ C1-06: Deceleration Time 3

No. (Hex.)	Name	Description	Default (Range)
C1-06 (0205) RUN	Deceleration Time 3	V/f CL-V/f OLV CLV AOLV OLV/PM AOLV/PM CLV/PM EZOLV Sets the time to decelerate from maximum frequency to 0.	10.0 s (0.0 - 6000.0 s)

Note:

If $C1-10 = 0$ [Accel/Decel Time Setting Units = 0.01 s (0.00 to 600.00 s)], the setting range will be 0.00 to 600.00 s.

■ **C1-07: Acceleration Time 4**

No. (Hex.)	Name	Description	Default (Range)
C1-07 (0206) RUN	Acceleration Time 4	V/f CL-V/f OLV CLV AOLV OLV/PM AOLV/PM CLV/PM EZOLV Sets the time to accelerate from 0 to maximum frequency.	10.0 s (0.0 - 6000.0 s)

Note:

If $C1-10 = 0$ [Accel/Decel Time Setting Units = 0.01 s (0.00 to 600.00 s)], the setting range will be 0.00 to 600.00 s.

■ **C1-08: Deceleration Time 4**

No. (Hex.)	Name	Description	Default (Range)
C1-08 (0207) RUN	Deceleration Time 4	V/f CL-V/f OLV CLV AOLV OLV/PM AOLV/PM CLV/PM EZOLV Sets the time to decelerate from maximum frequency to 0.	10.0 s (0.0 - 6000.0 s)

Note:

If $C1-10 = 0$ [Accel/Decel Time Setting Units = 0.01 s (0.00 to 600.00 s)], the setting range will be 0.00 to 600.00 s.

■ **C1-09: Fast Stop Time**

No. (Hex.)	Name	Description	Default (Range)
C1-09 (0208)	Fast Stop Time	V/f CL-V/f OLV CLV AOLV OLV/PM AOLV/PM CLV/PM EZOLV Sets the deceleration time for the drive to trigger the Fast Stop.	10.0 s (0.0 - 6000.0 s)

Note:

If $C1-10 = 0$ [Accel/Decel Time Setting Units = 0.01 s (0.00 to 600.00 s)], the setting range becomes 0.00 to 600.00 s.

The Fast Stop function will be triggered in the following circumstances.

- The Fast Stop operation will be triggered by the input of the Fast Stop command via the multi-function digital input terminal.
- The Fast Stop operation is will be triggered when by the input of the Fast Stop command is input via the multi-function digital input terminal.

Set $H1-xx = 15, 17$ [MFDI Function Select = Fast Stop (N.O.), Fast Stop (N.C.)].

When the Fast Stop command is input, the Fast Stop operation will be triggered at the deceleration time set to $C1-09$. The drive cannot be restarted after initiating a Fast Stop operation until deceleration is complete. Complete deceleration and cycle the Run command to clear the Fast Stop input.

The terminal set for $H2-xx = 4C$ [Multi-function Digital Outputs = During Fast Stop] will be ON during Fast Stop.

Note:

Rapid deceleration can trigger *ov* [Overvoltage]. When *ov* is detected, the drive output will shut off and the motor will coast. Set an appropriate Fast Stop time to $C1-09$ to avoid motor coasting and to ensure that the motor stops quickly and safely.

■ **C1-10: Accel/Decel Time Setting Units**

No. (Hex.)	Name	Description	Default (Range)
C1-10 (0209)	Accel/Decel Time Setting Units	V/f CL-V/f OLV CLV AOLV OLV/PM AOLV/PM CLV/PM EZOLV Selects the setting units for $C1-01$ to $C1-08$ [Acceleration Time 1 through Deceleration Time 4], $C1-09$ [Fast Stop Time], $L2-06$ [KEB Deceleration Time], and $L2-07$ [KEB Acceleration Time].	1 (0, 1)

0 : 0.01 s units

Sets acceleration and deceleration times in 0.01 s units. The setting range is 0.0 to 6000.0 s.

$C1-10 = 0$ cannot be set if any of the following parameters are set to 1000.0 s or longer. $C1-10 = 0$ can be set, but the time will change to 600.00 s when the time is set to 600.1 s to less than 1000.0 s.

- C1-01 to C1-09
- L2-06
- L2-07

1 : 0.1 s units

The acceleration and deceleration times are set in 0.1 s units. The setting range is 0.0 to 6000.0 s.

■ C1-11: Accel/Decel Time Switchover Freq

No. (Hex.)	Name	Description	Default (Range)
C1-11 (020A)	Accel/Decel Time Switchover Freq	V/f CL-V/f OLV CLV AOLV OLV/PM AOLV/PM CLV/PM EZOLV Sets the frequency at which acceleration and deceleration times are automatically changed.	Determined by A1-02 (0.0 - 590.0 Hz)

The acceleration and deceleration times for the drive are switched automatically when output frequency reaches the setting value set to C1-11. Setting *C1-11 = 0.0 Hz (0.0%)* disables this function.

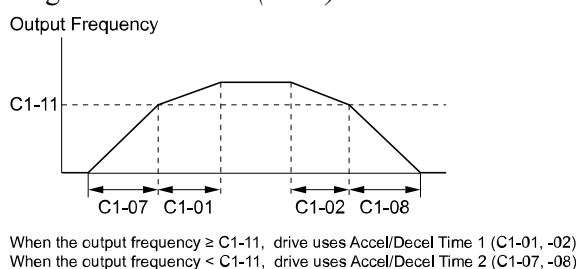

Figure 11.46 Accel/Decel Time Switchover Freq

The following table lists the possible combinations of acceleration and deceleration time switchover frequencies and the acceleration times when using the Motor 2 Selection function.

Table 11.28 Motor and Acceleration and Deceleration Time Combination

C1-11	Motor 1		Motor 2	
	Acceleration Time	Deceleration Time	Acceleration Time	Deceleration Time
Less than the setting value	C1-07 [Acceleration Time 4]	C1-08 [Deceleration Time 4]	C1-07 [Acceleration Time 4]	C1-08 [Deceleration Time 4]
At least the setting value	C1-01 [Acceleration Time 1]	C1-02 [Deceleration Time 1]	C1-05 [Acceleration Time 3]	C1-06 [Deceleration Time 3]

◆ C2: S-Curve Characteristics

Use S-curve characteristics to smooth acceleration and deceleration and to minimize abrupt shock to the load. Set S-curve characteristic time during acceleration/deceleration at start and acceleration/deceleration at stop. The following figure explains how S-curves are applied.

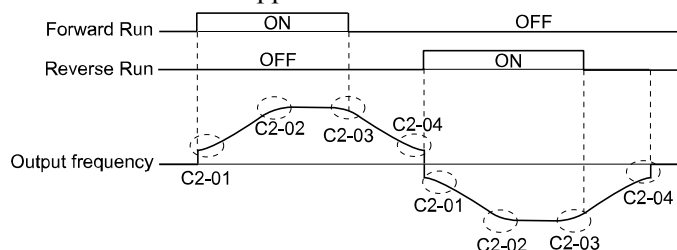

Figure 11.47 S-Curve Timing Diagram - Forward/Reverse Operation

Note:

- If *STPo [Pull-Out Detection]* occurs when starting a PM motor, try increasing the value set to C2-01.
- Setting the S-curve will increase the acceleration and deceleration times.

$$\text{Acceleration time} = \text{Selected acceleration time} + \frac{C2-01 + C2-02}{2}$$

$$\text{Deceleration time} = \text{Selected deceleration time} + \frac{C2-03 + C2-04}{2}$$

■ C2-01: S-Curve Time @ start of Accel

No. (Hex.)	Name	Description	Default (Range)
C2-01 (020B)	S-Curve Time @ Start of Accel	V/f CL-V/f OLV CLV AOLV OLV/PM AOLV/PM CLV/PM EZOLV Sets the S-curve time to the time to start acceleration.	Determined by A1-02 (0.00 to 10.00 s)

■ C2-02: S-Curve Time @ end of Accel

No. (Hex.)	Name	Description	Default (Range)
C2-02 (020C)	S-Curve Time @ End of Accel	V/f CL-V/f OLV CLV AOLV OLV/PM AOLV/PM CLV/PM EZOLV Sets the S-curve time to the time to complete acceleration.	0.20 s (0.00 - 10.00 s)

■ C2-03: S-Curve Time @ start of Decel

No. (Hex.)	Name	Description	Default (Range)
C2-03 (020D)	S-Curve Time @ Start of Decel	V/f CL-V/f OLV CLV AOLV OLV/PM AOLV/PM CLV/PM EZOLV Sets the S-curve time to the time to start deceleration.	0.20 s (0.00 - 10.00 s)

■ C2-04: S-Curve Time @ end of Decel

No. (Hex.)	Name	Description	Default (Range)
C2-04 (020E)	S-Curve Time @ End of Decel	V/f CL-V/f OLV CLV AOLV OLV/PM AOLV/PM CLV/PM EZOLV Sets the S-curve time to the time to complete deceleration.	0.00 s (0.00 - 10.00 s)

◆ C3: Slip Compensation

The Slip Compensation function improves the speed accuracy of an induction motor. As loads on induction motors increase, motor slip increases and motor speed decreases. By adjusting the output frequency in accordance with the motor load, it compensates the slip and makes the motor speed equal to the frequency reference.

■ C3-01: Slip Compensation Gain

No. (Hex.)	Name	Description	Default (Range)
C3-01 (020F) RUN	Slip Compensation Gain	V/f CL-V/f OLV CLV AOLV OLV/PM AOLV/PM CLV/PM EZOLV Sets the gain for the slip compensation function. Normally there is no need to change this setting.	Determined by A1-02 (0.0 - 2.5)

Note:

- Confirm that the following parameters are correctly set before changing the slip compensation gain. If A1-02 = 2 [Control Method Selection = Open Loop Vector Control], E2-02 [Motor Rated Slip] can be set by Auto-Tuning.
 - E2-01 [Motor Rated Current (FLA)]
 - E2-02 [Motor Rated Slip]
 - E2-03 [Motor No-Load Current]
- If A1-02 = 3 [Closed Loop Vector Control], the slip compensation gain will become the motor temperature compensation gain. The motor internal constant changes as the motor temperature rises, which increases the slip. If C3-01 is set, the slip will be adjusted in accordance with rises in temperature. Adjust the parameter in the following circumstances. Increasing the setting value also increases the compensation.
 - Torque control is being performed.
 - Torque limits are in place.
 - Output torque changes in accordance with temperature.

Adjustment may help in the following situations:

- If the motor speed is slower than the frequency reference, increase C3-01 by 0.1.
- If the motor at constant speed is faster than the frequency reference, decrease C3-01 by 0.1.

■ C3-02: Slip Compensation Delay Time

No. (Hex.)	Name	Description	Default (Range)
C3-02 (0210) RUN	Slip Compensation Delay Time	<div style="display: flex; justify-content: space-between; font-size: small;"> V/f CL-V/f OLV CLV AOLV OLV/PM AOLV/PM CLV/PM EZOLV </div> Adjusts the slip compensation delay time when speed is unstable or when the slip compensation response is too slow. There is normally no need to change this parameter from the default value.	Determined by A1-02 (0 - 10000 ms)

Adjustment may help in the following situations:

- Increase this setting when speed is unstable.
- Decrease the setting when the slip compensation response is too slow.

■ C3-03: Slip Compensation Limit

No. (Hex.)	Name	Description	Default (Range)
C3-03 (0211)	Slip Compensation Limit	<div style="display: flex; justify-content: space-between; font-size: small;"> V/f CL-V/f OLV CLV AOLV OLV/PM AOLV/PM CLV/PM EZOLV </div> Sets the upper limit for the slip compensation function as a percentage of the motor rated slip.	200% (0 - 250%)

This parameter is used when the motor speed is low despite increasing the setting value of C3-01 [Slip Compensation Gain]. This parameter becomes effective when the slip reaches the upper limit of slip compensation. Adjust this parameter while measuring the motor speed after increasing the value set to C3-03. Set this parameter so that the combined value of the frequency reference and the slip compensation limit does not exceed the machine's allowable range.

The slip compensation limit is constant in the constant torque range (frequency reference \leq E1-06 [Base Frequency]). In the constant power range the frequency reference \geq E1-06 increases based on C3-03 and the output frequency as shown in the following figure.

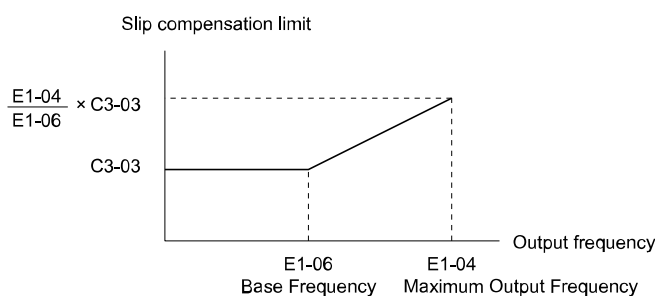

Figure 11.48 Slip Compensation Limit

■ C3-04: Slip Compensation @ Regen Select

No. (Hex.)	Name	Description	Default (Range)
C3-04 (0212) RUN	Slip Compensation @ Regen Select	<div style="display: flex; justify-content: space-between; font-size: small;"> V/f CL-V/f OLV CLV AOLV OLV/PM AOLV/PM CLV/PM EZOLV </div> Enables or disables slip compensation during regenerative operation.	0 (0 - 2)

When slip compensation during regeneration has been activated and a regenerative load is applied, it might be necessary to use a dynamic braking option (braking resistor or braking resistor unit).

0 : Disabled

Slip compensation is not provided.

Depending on the load and operation status (regenerative operation), the actual motor speed may be higher or lower than the frequency reference.

1 : Enabled (6 Hz and above)

Slip compensation is enabled during regenerative operation. It will not be active at output frequencies of 6 Hz or less.

2 : Enabled (compensation provided wherever possible)

The drive uses the motor rated slip set to *E2-02 [Motor Rated Slip]* to automatically calculate the frequency range where compensation will be disabled.

Slip compensation is enabled at frequencies as low as 2 Hz.

■ C3-05: Output Voltage limit Selection

No. (Hex.)	Name	Description	Default (Range)
C3-05 (0213)	Output Voltage limit Selection	<div style="display: flex; justify-content: space-between; font-size: small;"> V/f CL-V/f OLV CLV AOLV OLV/PM AOLV/PM CLV/PM EZOLV </div> Selects whether to automatically reduce the motor magnetic flux when the output voltage is saturated.	0 (0, 1)

Confirm the drive current margin before setting this parameter. Setting this parameter to 0 *[Enabled]* increases the output current up to a maximum of 10% when running the motor at constant speed. The reduction in flux causes a slightly higher current to compensate torque when this function is enabled.

Enable this parameter in the following circumstances.

- Power supply voltage is low.
- Motor rated voltage is high.
- To improve speed accuracy to move heavy loads at high speeds.

Do not enable output voltage limit operation in the following circumstances.

- Driving motors at middle speed range or low speed range
- Power supply voltage is 10% or higher than the motor rated voltage

If the power supply voltage is far lower than the motor rated voltage, accurate torque control may not be possible even if the output voltage limit operation is enabled.

0 : Disabled

1 : Enabled

■ C3-16: Vout Modulation Limit Start Lvl

No. (Hex.)	Name	Description	Default (Range)
C3-16 (0261)	Vout Modulation Limit Start Lvl	<div style="display: flex; justify-content: space-between; font-size: small;"> V/f CL-V/f OLV CLV AOLV OLV/PM AOLV/PM CLV/PM EZOLV </div> Sets the level (modulation factor) used to start the output voltage limit operation when <i>C3-05 = 1 [Output Voltage limit Selection = Enabled]</i> .	90.0% (70.0 - 90.0%)

■ C3-17: Vout Modulation Limit Max Level

No. (Hex.)	Name	Description	Default (Range)
C3-17 (0262)	Maximum Output Voltage Limit Level	<div style="display: flex; justify-content: space-between; font-size: small;"> V/f CL-V/f OLV CLV AOLV OLV/PM AOLV/PM CLV/PM EZOLV </div> Sets the level (modulation factor) used with <i>C3-18 [Output Voltage Limit Level]</i> for the output voltage limit operation when <i>C3-05 = 1 [Output Voltage limit Selection = Enabled]</i> .	100.0% (85.0 - 100.0%)

■ C3-18: Output Voltage Limit Level

No. (Hex.)	Name	Description	Default (Range)
C3-18 (0263)	Output Voltage Limit Level	<div style="display: flex; justify-content: space-between; font-size: small;"> V/f CL-V/f OLV CLV AOLV OLV/PM AOLV/PM CLV/PM EZOLV </div> Sets the maximum drop width of the voltage reference when <i>C3-05 = 1 [Output Voltage limit Selection = Enabled]</i> .	90.0% (50.0 - 100.0%)

■ C3-21: Motor 2 Slip Compensation Gain

No. (Hex.)	Name	Description	Default (Range)
C3-21 (033E) RUN	Motor 2 Slip Compensation Gain	<div style="display: flex; justify-content: space-between; font-size: small;"> V/f CL-V/f OLV CLV AOLV OLV/PM AOLV/PM CLV/PM EZOLV </div> Sets the gain for the motor 2 slip compensation function. There is normally no need to change this parameter from the default value.	Determined by E3-01 (0.0 - 2.5)

Note:

Confirm that the following parameters are correctly set before changing the slip compensation gain. If $E3-01 = 2$ [Motor 2 Control Mode Selection = Open Loop Vector Control] is set, $E4-02$ [Motor 2 Rated Slip] can be set by Auto-Tuning.

- $E4-01$ [Motor 2 Rated Current]
- $E4-02$ [Motor 2 Rated Slip]
- $E4-03$ [Motor 2 Rated No-Load Current]

Adjustment may help in the following situations:

- If the motor speed is slower than the frequency reference, increase $C3-01$ by 0.1.
- If the motor at constant speed is faster than the frequency reference, decrease $C3-01$ by 0.1.

■ C3-22: Motor 2 Slip Comp DelayTime

No. (Hex.)	Name	Description	Default (Range)
C3-22 (0241) RUN	Motor 2 Slip Comp DelayTime	<div style="display: flex; justify-content: space-between; font-size: small;"> V/f CL-V/f OLV CLV AOLV OLV/PM AOLV/PM CLV/PM EZOLV </div> <p>Adjusts the slip compensation delay time for motor 2 when speed is unstable or when the slip compensation response is too slow. Normally there is no need to change this setting.</p>	Determined by E3-01 (0 - 10000 ms)

Adjustment may help in the following situations:

- Increase this setting when speed is unstable.
- Decrease the setting when the slip compensation response is too slow.

■ C3-23: Motor 2 Slip Compensation Limit

No. (Hex.)	Name	Description	Default (Range)
C3-23 (0242) RUN	Motor 2 Slip Compensation Limit	<div style="display: flex; justify-content: space-between; font-size: small;"> V/f CL-V/f OLV CLV AOLV OLV/PM AOLV/PM CLV/PM EZOLV </div> <p>Sets the upper limit for the slip compensation function as a percentage of the motor 2 rated slip.</p>	200% (0 - 250%)

This parameter is used when the motor speed is low despite increasing the setting value of $C3-21$ [Motor 2 Slip Compensation Gain]. The slip may have reached the upper limit of slip compensation. Adjust this parameter while measuring the motor speed after increasing the value set to $C3-23$. Set this parameter so that the combined value of the frequency reference and the slip compensation limit does not exceed the machine's allowable range.

The slip compensation limit is constant in the constant torque range (frequency reference $\leq E3-06$ [Motor 2 Base Frequency]). In the constant power range the frequency reference $> E3-06$ increases based on $C3-23$ and the output frequency as shown in the following figure.

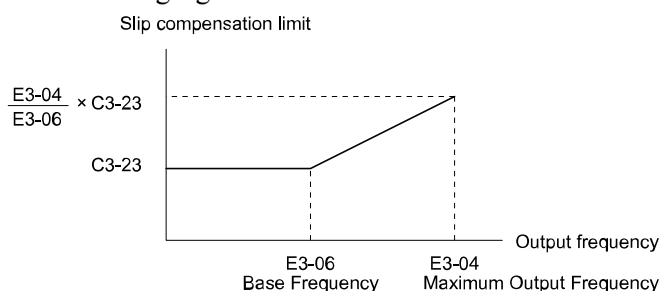

Figure 11.49 Motor 2 Slip Compensation Limit

■ C3-24: Motor 2 Slip Comp @ Regen Select

No. (Hex.)	Name	Description	Default (Range)
C3-24 (0243) RUN	Motor 2 Slip Comp @ Regen Select	<div style="display: flex; justify-content: space-between; font-size: small;"> V/f CL-V/f OLV CLV AOLV OLV/PM AOLV/PM CLV/PM EZOLV </div> <p>Enables or disables slip compensation for motor 2 during regenerative operation.</p>	0 (0 - 2)

When slip compensation during regeneration has been activated and a regenerative load is applied, it might be necessary to use a dynamic braking option (braking resistor or braking resistor unit).

0 : Disabled

Slip compensation is not provided.

Depending on the load and operation status (regenerative operation), the actual motor speed may be higher or lower than the frequency reference.

1 : Enabled (6 Hz and above)

Slip compensation is enabled during regenerative operation. It will not be active at output frequencies of 6 Hz or less.

2 : Enabled (compensation provided wherever possible)

Slip compensation is enabled during regenerative operation. Slip compensation is enabled at frequencies as low as 2 Hz.

The drive uses the motor rated slip set to *E2-02 [Motor Rated Slip]* to automatically calculate the frequency range where compensation will be disabled.

■ C3-28: Adaptive Slip Contrl Mode Select

No. (Hex.)	Name	Description	Default (Range)
C3-28 (1B5B)	Adaptive Slip Contrl Mode Select	<div style="display: flex; justify-content: space-between; font-size: small;"> V/f CL-V/f OLV CLV AOLV OLV/PM AOLV/PM CLV/PM EZOLV </div> Selects the mode for the slip compensation function.	0 (0, 1)

0 : Normal

1 : Advance

Note:

Set *C3-28 = 0* to improve torque accuracy. If this does not make any improvements, set *C3-28 = 1* and then increase the value of *n4-65 [FluxEstimationResponseForHighFrq]* or *n4-66 [FluxEstimationResponseForLowFreq]* in increments of *0.1*. In this case, the Rotational Auto-Tuning process must be executed.

◆ C4: Torque Compensation

Torque compensation is a function that increases voltage to increase output torque as compensation for insufficient torque production at start-up or low-speed operation.

Voltage drops due to motor winding resistance cause torque generating voltage to decrease, which causes insufficient torque. If the main circuit cable connecting the drive and motor is long, this can also cause insufficient torque due to voltage drops.

Note:

Set the motor parameters and V/f pattern properly before setting *C4 parameters*.

■ C4-01: Torque Compensation Gain

No. (Hex.)	Name	Description	Default (Range)
C4-01 (0215) RUN	Torque Compensation Gain	<div style="display: flex; justify-content: space-between; font-size: small;"> V/f CL-V/f OLV CLV AOLV OLV/PM AOLV/PM CLV/PM EZOLV </div> Sets the gain for the torque compensation function. Sets the gain for motor 1 when multiple motors are driven.	Determined by A1-02 (0.00 - 2.50)

Adjust the value set to *C4-01* in small steps of 0.05 in V/f Control or Closed Loop V/f Control in the following situations:

- Increase the setting value when torque is insufficient during low-speed operation of 10 Hz or less.
- Decrease the setting value when the motor vibrates or hunts while running the drive with a light load.
- Increase this setting when using a long motor cable.

Note:

- Adjust *C4-01* so the output current does not exceed the drive rated current while running the drive with a light load.
- Normally, refrain from adjusting this parameter in PM Open Loop Vector Control. It can have a negative effect on torque accuracy.
- Normally, refrain from adjusting this parameter in PM Open Loop Vector Control. Setting this value too high can cause overcompensation and motor oscillation.

■ C4-02: Torque Compensation Delay Time

No. (Hex.)	Name	Description	Default (Range)
C4-02 (0216) RUN	Torque Compensation Delay Time	<input type="checkbox"/> V/f <input type="checkbox"/> CL-V/f <input checked="" type="checkbox"/> OLV <input type="checkbox"/> CLV <input type="checkbox"/> AOLV <input type="checkbox"/> OLV/PM <input type="checkbox"/> AOLV/PM <input type="checkbox"/> CLV/PM <input type="checkbox"/> EZOLV Sets the torque compensation delay time in milliseconds. Normally there is no need to change this setting.	Determined by A1-02 (0 - 60000 ms)

Adjustment may help in the following situations:

- Increase this setting if the motor vibrates.
- Decrease this setting if the motor speed or motor torque responds too slowly.

■ C4-03: Torque Compensation @ FWD Start

No. (Hex.)	Name	Description	Default (Range)
C4-03 (0217)	Torque Compensation @ FWD Start	<input type="checkbox"/> V/f <input type="checkbox"/> CL-V/f <input checked="" type="checkbox"/> OLV <input type="checkbox"/> CLV <input type="checkbox"/> AOLV <input type="checkbox"/> OLV/PM <input type="checkbox"/> AOLV/PM <input type="checkbox"/> CLV/PM <input type="checkbox"/> EZOLV Sets the amount of torque reference at start in the forward direction as a percentage of the motor rated torque.	0.0% (0.0 - 200.0%)

Compensation is applied using the time constant set in *C4-05 [Torque Compensation Time]*.

Enable this function when starting the motor with a Forward run command. Setting 0 disables this feature.

■ C4-04: Torque Compensation @ REV Start

No. (Hex.)	Name	Description	Default (Range)
C4-04 (0218)	Torque Compensation @ REV Start	<input type="checkbox"/> V/f <input type="checkbox"/> CL-V/f <input checked="" type="checkbox"/> OLV <input type="checkbox"/> CLV <input type="checkbox"/> AOLV <input type="checkbox"/> OLV/PM <input type="checkbox"/> AOLV/PM <input type="checkbox"/> CLV/PM <input type="checkbox"/> EZOLV Sets the amount of torque reference at start in the reverse direction as a percentage of the motor rated torque.	0.0% (-200.0 - 0.0%)

Compensation is applied using the time constant set in *C4-05 [Torque Compensation Time]*.

This function operates only when the motor starts in the reverse run orientation. Setting 0 disables this feature.

■ C4-05: Torque Compensation Time

No. (Hex.)	Name	Description	Default (Range)
C4-05 (0219)	Torque Compensation Time	<input type="checkbox"/> V/f <input type="checkbox"/> CL-V/f <input checked="" type="checkbox"/> OLV <input type="checkbox"/> CLV <input type="checkbox"/> AOLV <input type="checkbox"/> OLV/PM <input type="checkbox"/> AOLV/PM <input type="checkbox"/> CLV/PM <input type="checkbox"/> EZOLV Sets the starting torque constant used with <i>C4-03</i> and <i>C4-04 [Torque Compensation @ REV Start]</i> .	10 ms (0 - 200 ms)

■ C4-06: Motor 2 Torque Comp Delay Time

No. (Hex.)	Name	Description	Default (Range)
C4-06 (021A)	Motor 2 Torque Comp Delay Time	<input type="checkbox"/> V/f <input type="checkbox"/> CL-V/f <input checked="" type="checkbox"/> OLV <input type="checkbox"/> CLV <input type="checkbox"/> AOLV <input type="checkbox"/> OLV/PM <input type="checkbox"/> AOLV/PM <input type="checkbox"/> CLV/PM <input type="checkbox"/> EZOLV Sets the value if <i>ov [Overvoltage]</i> occurs with sudden changes in the load, at the end of acceleration, or at the start of deceleration.	150 ms (0 - 10000 ms)

Sets the time constant used during Speed Search or during regenerative operation when *ov* occurs.

Adjust this parameter in the following circumstances.

- Gradually reduce the setting in 10 ms increments and check the performance to improve motor torque speed response when *ov* occurs.

Note:

- Ensure that $C4-06 \geq C4-02$ [*Torque Compensation Delay Time*].
- Increase the setting value of *n2-03 (AFR Time Constant 2)* proportional to *C4-06*.

■ C4-07: Motor 2 Torque Compensation Gain

No. (Hex.)	Name	Description	Default (Range)
C4-07 (0341) RUN	Motor 2 Torque Compensation Gain	<div style="display: flex; justify-content: space-between; font-size: 0.8em; font-weight: bold; margin-bottom: 5px;"> V/f CL-V/f OLV CLV AOLV OLV/PM AOLV/PM CLV/PM EZOLV </div> Sets the motor 2 gain for the torque compensation function when using the Motor Switch function.	1.00 (0.00 - 2.50)

Adjust the value set to *C4-07* in small steps of 0.05 in V/f Control or Closed Loop V/f Control in the following situations:

- Increase the setting value when torque is insufficient during low-speed operation of 10 Hz or less.
- Decrease the setting value when the motor vibrates or hunts while running the drive with a light load.
- Increase this setting when using a long motor cable.

Note:

- Adjust *C4-07* so the output current does not exceed the drive rated current while running the drive with a light load.
- Normally, refrain from adjusting this parameter in PM Open Loop Vector Control. Torque accuracy is reduced.

■ C4-19: T-ripple suppress freq

No. (Hex.)	Name	Description	Default (Range)
C4-19 (0B8D)	T-ripple suppress freq	<div style="display: flex; justify-content: space-between; font-size: 0.8em; font-weight: bold; margin-bottom: 5px;"> V/f CL-V/f OLV CLV AOLV OLV/PM AOLV/PM CLV/PM EZOLV </div> Increase the setting in increments of approximately 1.0 when current ripples and torque ripples occur during low-speed operation. If this still does not improve the situation, set <i>C4-19</i> = 0 to disable this function. Normally there is no need to change this setting.	0.1 Hz (0.0 - 10.0 Hz)

Note:

This parameter is enabled when *C4-20* [vol compensation adjust 1] is set to any value other than 0.

■ C4-20: vol compensation adjust 1

No. (Hex.)	Name	Description	Default (Range)
C4-20 (0BCB)	vol compensation adjust 1	<div style="display: flex; justify-content: space-between; font-size: 0.8em; font-weight: bold; margin-bottom: 5px;"> V/f CL-V/f OLV CLV AOLV OLV/PM AOLV/PM CLV/PM EZOLV </div> This parameter compensates the voltage accuracy. Normally there is no need to change this setting.	120 (0 - 200)

Note:

Configure such that *C4-20* = 0 when noise occurs during low-speed operation.

■ C4-21: vol compensation adjust 2

No. (Hex.)	Name	Description	Default (Range)
C4-21 (0BCC)	vol compensation adjust 2	<div style="display: flex; justify-content: space-between; font-size: 0.8em; font-weight: bold; margin-bottom: 5px;"> V/f CL-V/f OLV CLV AOLV OLV/PM AOLV/PM CLV/PM EZOLV </div> This parameter compensates the voltage accuracy. Normally there is no need to change this setting.	5 (0 - 10)

Note:

Set *C4-21* = 0 when noise occurs during high-speed operation.

◆ C5: Automatic Speed Regulator (ASR)

The ASR adjusts the output frequency or torque reference to minimize the difference between frequency reference and actual motor speed. The exact parameter that is adjusted depends on the control mode.

Control method	Targets of adjustment
Closed Loop V/f Control (CL-V/f)	Output frequency
<ul style="list-style-type: none"> Closed Loop Vector Control (CLV) Advanced Open Loop Vector Control (AOLV) Closed Loop Vector Control for PM (CLV/PM) PM Advanced Open Loop Vector (AOLV/PM) EZ Vector Control (EZOLV) 	Torque Reference

Figure 11.50 is a speed control block diagram of each control mode.

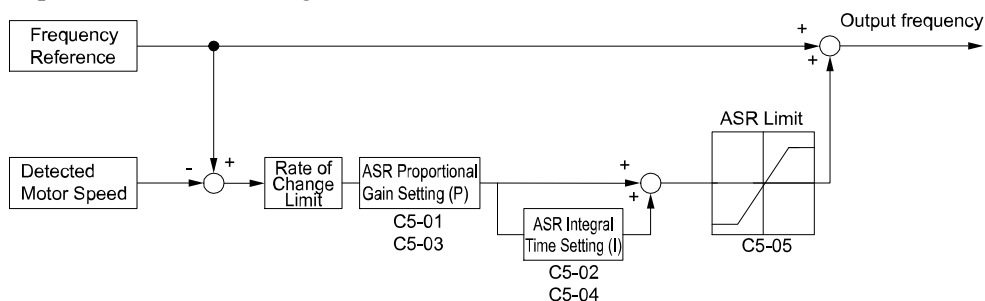

Figure 11.50 Speed Control Block Diagram for Closed Loop V/f Control (CL-V/f)

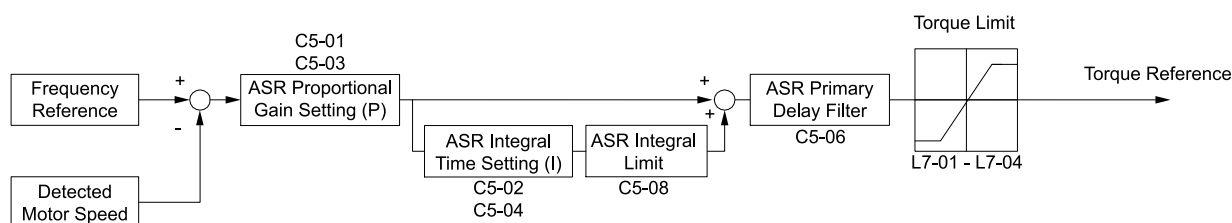

Figure 11.51 Speed Control Block Diagram for CLV, AOLV, CLV/PM, AOLV/PM, and EZOLV

Note:

The detected speed is the speed estimation value when configured such that $A1-02 = 4, 6, \text{ or } 8$ [Control Method Selection = Advanced OpenLoop Vector Control (AOLV), PM Open Loop Vector Control (AOLV/PM), or EZ Open Loop Vector Control (EZOLV)].

■ Before Adjusting ASR Parameters

- Perform Auto-Tuning and set up all motor data correctly prior to adjusting ASR parameters.
- Always make adjustments with the load connected to the motor.
- Use analog output signals to monitor $UI-16$ [Output Freq afterSFS] and $UI-05$ [Motor Speed] when adjusting the ASR.

■ ASR Adjustment Procedure for Closed Loop V/f Control (CL-V/f)

Perform the following steps for adjusting ASR parameters:

1. Run the motor at minimum speed and increase $C5-03$ [ASR Proportional Gain 2] as much as possible without oscillation.

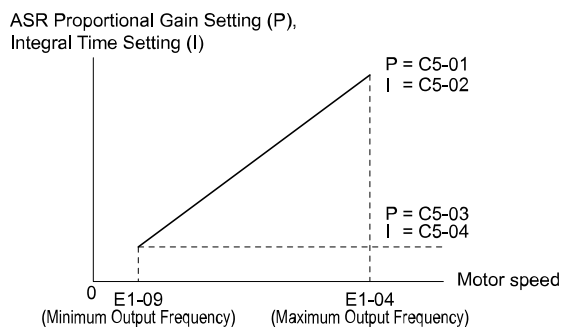

Figure 11.52 ASR Gain and Integral Time Adjustment

2. Run the motor at minimum speed and decrease $C5-04$ [ASR Integral Time 2] as much as possible without oscillation.

3. Check the output current monitor to make sure that the output current is less than 50% of the drive rated current. If the setting value is higher than 50%, decrease *C5-03* and increase *C5-04*.
4. Run the motor at maximum speed and increase *C5-01* [*ASR Proportional Gain 1*] as much as possible without oscillations.
5. Run the motor at maximum speed and decrease *C5-02* [*ASR Integral Time 1*] as much as possible without oscillations.
6. If higher speed precision and faster response during acceleration or deceleration are required, enable integral control during acceleration /decel by setting *C5-12* = 1 [*Integral Operation @ Accel/Decel = Enabled*].

Note:

- If overshooting occurs when acceleration ends, reduce the value set in *C5-01* and increase the value set in *C5-02*.
- Decrease *C5-03* and increase *C5-04* if undershoot occurs at stop.
- If adjusting the gain does not resolve issues of overshooting and undershooting, decrease the value set to *C5-05* [*ASR Limit*] to decrease the upper limit of the frequency reference compensation.

■ ASR Adjustment Procedure for CLV, AOLV, AOLV/PM, CLV/PM, and EZOLV

Perform the following steps for adjusting ASR parameters:

1. Run the motor at zero speed or low speed and increase *C5-01* [*ASR Proportional Gain 1*] until just before vibration begins to occur.
2. Run the motor at zero speed or low speed and decrease *C5-02* [*ASR Integral Time 1*] until just before vibration begins to occur.
3. Check for any oscillation when running the motor at maximum speed.
4. Increase *C5-02* and decrease *C5-01* if oscillation occurs. The adjustment procedure is complete if there is no oscillation.
5. Set the low-speed gain. Run the motor at zero speed or low speed and increase *C5-03* [*ASR Proportional Gain 2*] until just before vibration begins to occur.

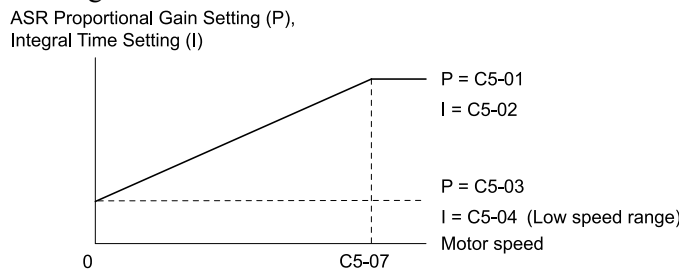

Figure 11.53 Low-speed/High-speed Gain Settings

6. Set the low-speed integral time. Run the motor at zero speed or low speed and decrease *C5-04* [*ASR Integral Time 2*] until just before vibration begins to occur.
7. Set *C5-07* [*ASR Gain Switchover Frequency*].
8. Check for any oscillation when running the motor at speeds above the setting in *C5-07*.

Note:

- If overshooting occurs when acceleration ends, decrease the value set in *C5-01* and increase the value set in *C5-02*.
- Decrease *C5-03* and increase *C5-04* if undershoot occurs at stop.

■ Proportional Gain via Multi-function Digital Input Switch

Note:

This function cannot be set when *A1-02* = 1 [*Control Method Selection = Closed Loop V/f Control*].

The proportional gains set with *C5-01* and *C5-03* can be switched by using the input terminals set for ASR Gain Switch [*H1-xx* = 77]. The proportional gain set for *C5-01* is selected when the configured input terminal is turned off. The proportional gain set for *C5-03* is selected when the terminal is turned on. The proportional gain changes linearly over the time set in *C5-02* [*ASR Integral Time 1*]. The signals from this multi-function input terminal have priority over *C5-07* [*ASR Gain Switchover Frequency*].

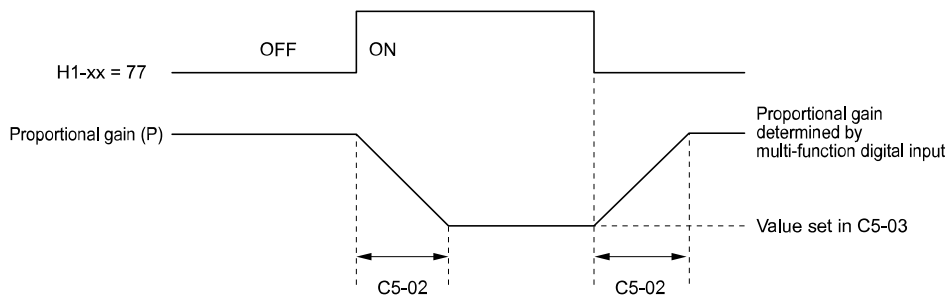

Figure 11.54 Proportional Gain via Multi-function Digital Input Switch

Speed Waveform Monitoring Method

To make fine adjustments of ASR parameters, observe speed waveforms while making adjustments. The following table lists example settings of parameters used to observe speed waveforms.

Table 11.29 Example Settings of Multi-function Analog Output Terminals Used to Monitor Speed Waveforms

No.	Name	Setting Value	Description
H4-01	MFAO Terminal FM Monitor Select	116	This setting enables use of the terminal FM to monitor <i>U1-16 [Output Freq afterSFS]</i> .
H4-02	FM Analog Output Gain	100.0%	
H4-03	FM Analog Output Bias	0.0%	
H4-04	MFAO Terminal AM Monitor Select	105	This setting enables use of the terminal AM to monitor <i>U1-05 [Motor Speed]</i> .
H4-05	AM Analog Output Gain	50.0%	
H4-06	AM Analog Output Bias	0.0%	
H4-07	MFAO Term FM Signal Level Select	1	This setting enables monitoring within a range of -10 to +10 V.
H4-08	MFAO Term AM Signal Level Select	1	

These settings result in the following multi-function analog output configuration. The multi-function analog output common is the terminal AC.

- Terminal FM: Outputs the output frequency after SFS within a range of -10 to +10 V (-100 to +10).
- Terminal AM: Outputs the motor speed within a range of -10 to +10 V (-200 to +20).

Yaskawa recommends monitoring both the output frequency after SFS and the motor speed to observe any delay in response and differences in reference values.

Adjusting the ASR Parameters

Use the following table when making adjustments to ASR. The table lists parameters for motor 1. Though the parameters listed below are for motor 1, the same changes can be made to the corresponding motor 2 parameters when running a second motor.

Note:

When adjusting the proportional gain and integral time, adjust the proportional gain first.

Problem		Possible Solutions
Speed response is slow.		<ul style="list-style-type: none"> • Increase C5-01/C5-03 [ASR Proportional Gain]. • Decrease C5-02/C5-04 [ASR Integral Time].
Overshoot or undershoot occurs at the end of acceleration or deceleration.		<ul style="list-style-type: none"> • Decrease C5-01/C5-03. • Increase C5-02/C5-04.

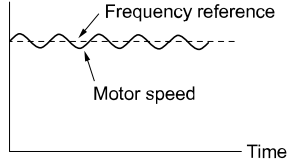
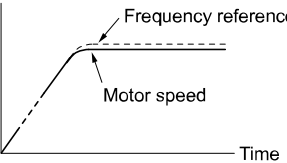
Problem		Possible Solutions
Vibration and oscillation occur at constant speed.		<ul style="list-style-type: none"> Decrease C5-01/C5-03. Increase C5-02/C5-04. Increase C5-06 [ASR Delay Time].
Speed accuracy is poor when running motors with significant rated slip in Closed Loop V/f Control mode.		<ul style="list-style-type: none"> Check the pulse number set to F1-01 [PG 1 Pulses Per Revolution] and the gear ratio to F1-12 [PG 1 Gear Teeth 1] and F1-13 [PG 1 Gear Teeth 2]. Make sure the pulse signal from the encoder is set up properly. Check U6-04 [ASR Output] and determine if the ASR is working at its output limit set to C5-05 [ASR Limit]. If the ASR is at the output limit, increase C5-05.
If C5-12 = 1 or C5-32 = 1 [Enabled] in Closed Loop V/f Control and over/undershoot occurs when changing speed.	-	<ul style="list-style-type: none"> Decrease C5-01/C5-03. Increase C5-02/C5-04. Decrease the value set to C5-05.
Oscillation at low speed and response is too slow at high speed. Alternatively, the opposite problem occurs.	-	<ul style="list-style-type: none"> Closed Loop V/f Control Mode: Use C5-03 and C5-04 at maximum speed and C5-01 and C5-02 at minimum speed to set up different ASR settings. Closed Loop Vector Control, PM Advanced Open Loop Vector Control, and PM Closed Loop Vector Control: Use C5-01 to C5-04 to define optimal ASR settings for high and low speed. Use C5-07 [ASR Gain Switchover Frequency] to switch the ASR proportional gain and ASR integral time in accordance with the output frequency.

■ C5-01: ASR Proportional Gain 1

No. (Hex.)	Name	Description	Default (Range)
C5-01 (021B) RUN	ASR Proportional Gain 1	<div style="display: flex; justify-content: space-between; font-size: small;"> V/f CL-V/f OLV CLV AOLV OLV/PM AOLV/PM CLV/PM EZOLV </div> Sets the gain to adjust ASR response.	Determined by A1-02 (0.00 - 300.00)

The speed response increases with the weight of the load. Normally, the gain increases with larger loads. Excessive gain causes vibration.

Note:

- Motor 1 ASR is normally set using C5-01 and C5-02 [ASR Integral Time 1]. C5-03 [ASR Proportional Gain 2] can be used in place of C5-01 by setting H1-xx = 77 [MFDI Function Select = ASR Gain Switch]. C5-01 can also be used in place of C5-04 [ASR Integral Time 2] when the speed is less than or equal to the frequency set to C5-07 [ASR Gain Switchover Frequency].
- C5-01 is automatically adjusted when the ASR Tuning process is executed.

■ C5-02: ASR Integral Time 1

No. (Hex.)	Name	Description	Default (Range)
C5-02 (021C) RUN	ASR Integral Time 1	<div style="display: flex; justify-content: space-between; font-size: small;"> V/f CL-V/f OLV CLV AOLV OLV/PM AOLV/PM CLV/PM EZOLV </div> Sets the ASR integral time.	Determined by A1-02 (0.000 - 10.000 s)

An integral time that is too long reduces the responsiveness of the speed control and weakens repulsion against external force. An integral time that is too short can cause oscillation.

■ C5-03: ASR Proportional Gain 2

No. (Hex.)	Name	Description	Default (Range)
C5-03 (021D) RUN	ASR Proportional Gain 2	V/f CL-V/f OLV CLV AOLV OLV/PM AOLV/PM CLV/PM EZOLV Sets the gain to adjust ASR response.	Determined by A1-02 (0.00 - 300.00)

The speed response increases with the weight of the load. Normally, the gain increases with larger loads. Excessive gain causes vibration.

■ C5-04: ASR Integral Time 2

No. (Hex.)	Name	Description	Default (Range)
C5-04 (021E) RUN	ASR Integral Time 2	V/f CL-V/f OLV CLV AOLV OLV/PM AOLV/PM CLV/PM EZOLV Sets the ASR integral time.	Determined by A1-02 (0.000 - 10.000 s)

An integral time that is too long reduces the responsiveness of the speed control and weakens repulsion against external force. An integral time that is too short can cause oscillation.

■ C5-05: ASR Limit

No. (Hex.)	Name	Description	Default (Range)
C5-05 (021F) RUN	ASR Limit	V/f CL-V/f OLV CLV AOLV OLV/PM AOLV/PM CLV/PM EZOLV Sets the ASR output limit as a percentage of E1-04 [Maximum Output Frequency].	5.0% (0.0 - 20.0%)

If the motor rated slip is high, the setting might need to be increased to provide proper motor speed control. Use U6-04 [ASR Output] to determine if ASR is working at the limit set to C5-05. If ASR is working at the limit, make sure F1-01 [PG 1 Pulses Per Revolution], F1-12 [PG 1 Gear Teeth 1], and F1-13 [PG 1 Gear Teeth 2], and the PG signal are set correctly before making further changes to C5-05.

■ C5-06: ASR Delay Time

No. (Hex.)	Name	Description	Default (Range)
C5-06 (0220) RUN	ASR Delay Time	V/f CL-V/f OLV CLV AOLV OLV/PM AOLV/PM CLV/PM EZOLV Sets the filter time constant for the time from the speed loop to the torque command output. There is normally no need to change this parameter from the default value.	Determined by A1-02 (0.000 - 0.500 s)

Increase this setting gradually in increments of 0.01 for loads with low rigidity or when oscillation is a problem.

■ C5-07: ASR Gain Switchover Frequency

No. (Hex.)	Name	Description	Default (Range)
C5-07 (0221)	ASR Gain Switchover Frequency	V/f CL-V/f OLV CLV AOLV OLV/PM AOLV/PM CLV/PM EZOLV Sets the frequency where the drive should switch between C5-01 [ASR Proportional Gain 1] and C5-03 [ASR Proportional Gain 2] as well as between integral time 1 and 2 (C5-02, C5-04). Sets the frequency where the drive should switch between C5-02 [ASR Integral Time 1] and C5-04 [ASR Integral Time 2] as well as between C5-01 and C5-03.	Determined by A1-02 (Determined by A1-02)

Switching the proportional gain and integral time in the low or high speed range can help stabilize operation. A good switching point is 80% of the frequency where oscillation occurs or at 80% of the maximum output frequency.

Note:

A multi-function input set for H1-xx = 77 [MFDI Function Select = ASR Gain Switch] takes priority over the ASR gain switching frequency.

■ C5-08: ASR Integral Limit

No. (Hex.)	Name	Description	Default (Range)
C5-08 (0222)	ASR Integral Limit	<input type="checkbox"/> V/f <input type="checkbox"/> CL-V/f <input type="checkbox"/> OLV <input checked="" type="checkbox"/> CLV <input type="checkbox"/> AOLV <input type="checkbox"/> OLV/PM <input type="checkbox"/> AOLV/PM <input type="checkbox"/> CLV/PM <input type="checkbox"/> EZOLV Sets the upper limit for ASR as a percentage of the rated load.	400% (0 - 400%)

■ C5-12: Integral Operation @ Accel/Decel

No. (Hex.)	Name	Description	Default (Range)
C5-12 (0386)	Integral Operation @ Accel/Decel	<input type="checkbox"/> V/f <input checked="" type="checkbox"/> CL-V/f <input type="checkbox"/> OLV <input type="checkbox"/> CLV <input type="checkbox"/> AOLV <input type="checkbox"/> OLV/PM <input type="checkbox"/> AOLV/PM <input type="checkbox"/> CLV/PM <input type="checkbox"/> EZOLV Enables or disables integral operation during acceleration and deceleration.	0 (0, 1)

Enabling integral operation when driving a heavy load or a high inertia load may cause problems with overshoot or undershoot at the end of acceleration and deceleration. Set $C5-12 = 0$ if there are problems of overshooting and undershooting.

0 : Disabled

Integral operation is not enabled during acceleration or deceleration. Integral operation is always enabled during constant speed.

1 : Enabled

Integral operation is always enabled.

■ C5-17: Motor Inertia

No. (Hex.)	Name	Description	Default (Range)
C5-17 (0276)	Motor inertia	<input type="checkbox"/> V/f <input type="checkbox"/> CL-V/f <input type="checkbox"/> OLV <input checked="" type="checkbox"/> CLV <input type="checkbox"/> AOLV <input type="checkbox"/> OLV/PM <input type="checkbox"/> AOLV/PM <input type="checkbox"/> CLV/PM <input type="checkbox"/> EZOLV Sets the motor inertia.	Determined by o2-04, C6-01, and E5-01 (0.0001 - 600.00 kgm ²)

When $A1-02 = 3$ or 7 [Control Method Selection = Closed Loop Vector Control or PM Closed Loop Vector Control], $C5-17$ is automatically set the value of [Motor Inertia] when any of the following Auto-Tuning processes are executed.

- Inertia Tuning
- ASR Tuning

■ C5-18: Load Inertia Ratio

No. (Hex.)	Name	Description	Default (Range)
C5-18 (0277)	Load Inertia Ratio	<input type="checkbox"/> V/f <input type="checkbox"/> CL-V/f <input type="checkbox"/> OLV <input checked="" type="checkbox"/> CLV <input type="checkbox"/> AOLV <input type="checkbox"/> OLV/PM <input type="checkbox"/> AOLV/PM <input type="checkbox"/> CLV/PM <input type="checkbox"/> EZOLV Sets the load inertia ratio for the motor inertia.	1.0 (0.0 - 6000.0)

When $A1-02 = 3$ or 7 [Control Method Selection = Closed Loop Vector Control or PM Closed Loop Vector Control], $C5-18$ is automatically set to the load inertia ratio when any of the following Auto-Tuning processes are executed.

- Inertia Tuning
- ASR Tuning

■ C5-21: Motor 2 ASR Proportional Gain 1

No. (Hex.)	Name	Description	Default (Range)
C5-21 (0356) RUN	Motor 2 ASR Proportional Gain 1	<input type="checkbox"/> V/f <input checked="" type="checkbox"/> CL-V/f <input type="checkbox"/> OLV <input checked="" type="checkbox"/> CLV <input type="checkbox"/> AOLV <input type="checkbox"/> OLV/PM <input type="checkbox"/> AOLV/PM <input type="checkbox"/> CLV/PM <input type="checkbox"/> EZOLV Sets the gain to adjust ASR response.	Determined by E3-01 (0.00 - 300.00)

The speed response increases with the weight of the load. Normally, the gain increases with larger loads. Excessive gain causes vibration.

Note:

- Motor 2 ASR is normally set using C5-21 and C5-22 [Motor 2 ASR Integral Time 1]. C5-23 [Motor 2 ASR Proportional Gain 2] can be used instead of C5-21 by setting H1-xx = 77 [MFDI Function Select = ASR Gain Switch]. C5-23 can also be used in place of C5-21 when the speed is less than or equal to the frequency set in C5-27 [Motor 2 ASR Gain Switchover Freq].
- C5-21 is automatically adjusted when the ASR Tuning process is executed.

■ C5-22: Motor 2 ASR Integral Time 1

No. (Hex.)	Name	Description	Default (Range)
C5-22 (0357) RUN	Motor 2 ASR Integral Time 1	<input type="checkbox"/> V/f <input checked="" type="checkbox"/> CL-V/f <input type="checkbox"/> OLV <input checked="" type="checkbox"/> CLV <input type="checkbox"/> AOLV <input type="checkbox"/> OLV/PM <input type="checkbox"/> AOLV/PM <input type="checkbox"/> CLV/PM <input type="checkbox"/> EZOLV Sets the ASR integral time.	Determined by E3-01 (0.000 - 10.000 s)

An integral time that is too long reduces the responsiveness of the speed control and weakens repulsion against external force. An integral time that is too short can cause oscillation.

Note:

Closed Loop Vector Control is normally set using C5-21 [Motor 2 ASR Proportional Gain 1] and C5-22 [Motor 2 ASR Integral Time 1]. C5-22 can also be used instead of C5-24 [Motor 2 ASR Integral Time 2] when the speed is less than or equal to the frequency set to C5-27 [Motor 2 ASR Gain Switchover Freq].

■ C5-23: Motor 2 ASR Proportional Gain 2

No. (Hex.)	Name	Description	Default (Range)
C5-23 (0358) RUN	Motor 2 ASR Proportional Gain 2	<input type="checkbox"/> V/f <input checked="" type="checkbox"/> CL-V/f <input type="checkbox"/> OLV <input checked="" type="checkbox"/> CLV <input type="checkbox"/> AOLV <input type="checkbox"/> OLV/PM <input type="checkbox"/> AOLV/PM <input type="checkbox"/> CLV/PM <input type="checkbox"/> EZOLV Sets the gain to adjust ASR response.	Determined by E3-01 (0.00 - 300.00)

The speed response increases with the weight of the load. Normally, the gain increases with larger loads. Note that excessive gain causes oscillation.

■ C5-24: Motor 2 ASR Integral Time 2

No. (Hex.)	Name	Description	Default (Range)
C5-24 (0359) RUN	Motor 2 ASR Integral Time 2	<input type="checkbox"/> V/f <input checked="" type="checkbox"/> CL-V/f <input type="checkbox"/> OLV <input checked="" type="checkbox"/> CLV <input type="checkbox"/> AOLV <input type="checkbox"/> OLV/PM <input type="checkbox"/> AOLV/PM <input type="checkbox"/> CLV/PM <input type="checkbox"/> EZOLV Sets the ASR integral time.	Determined by E3-01 (0.000 - 10.000 s)

An integral time that is too long reduces the responsiveness of the speed control and weakens repulsion against external force. An integral time that is too short can cause oscillation.

Note:

Closed Loop Vector Control is normally set using C5-21 [Motor 2 ASR Proportional Gain 1] and C5-22 [Motor 2 ASR Integral Time 1]. C5-22 can also be used instead of C5-24 when the speed is less than or equal to the frequency set to C5-27 [Motor 2 ASR Gain Switchover Freq].

■ C5-25: Motor 2 ASR Limit

No. (Hex.)	Name	Description	Default (Range)
C5-25 (035A)	Motor 2 ASR Limit	<input type="checkbox"/> V/f <input checked="" type="checkbox"/> CL-V/f <input type="checkbox"/> OLV <input type="checkbox"/> CLV <input type="checkbox"/> AOLV <input type="checkbox"/> OLV/PM <input type="checkbox"/> AOLV/PM <input type="checkbox"/> CLV/PM <input type="checkbox"/> EZOLV Sets the ASR output limit as a percentage of E1-04 [Maximum Output Frequency].	5.0% (0.0 - 20.0%)

If the motor rated slip is high, the setting might need to be increased to provide proper motor speed control. Use U6-04 [ASR Output] to determine if ASR is working at the limit set to C5-05. If ASR is working at the limit, make sure F1-31 [PG 2 Pulses Per Revolution], F1-33 [PG 2 Gear Teeth 1], F1-34 [PG 2 Gear Teeth 2], and the PG signal are set correctly before making further changes to C5-25.

■ **C5-26: Motor 2 ASR Delay Time**

No. (Hex.)	Name	Description	Default (Range)
C5-26 (035B)	Motor 2 ASR Delay Time	<div style="display: flex; justify-content: space-between; font-size: small;"> V/f CL-V/f OLV CLV AOLV OLV/PM AOLV/PM CLV/PM EZOLV </div> <p>Sets the filter time constant for the time from the speed loop to the torque command output. There is normally no need to change this parameter from the default value.</p>	Determined by E3-01 (0.000 - 0.500 s)

Increase this setting gradually in increments of 0.01 for loads with low rigidity or when oscillation is a problem.

■ **C5-27: Motor 2 ASR Gain Switchover Freq**

No. (Hex.)	Name	Description	Default (Range)
C5-27 (035C)	Motor 2 ASR Gain Switchover Freq	<div style="display: flex; justify-content: space-between; font-size: small;"> V/f CL-V/f OLV CLV AOLV OLV/PM AOLV/PM CLV/PM EZOLV </div> <p>Sets the frequency where the drive should switch between C5-21 [Motor 2 ASR Proportional Gain 1] and C5-23 [Motor 2 ASR Proportional Gain 2]. Sets the frequency where the drive should switch between C5-22 [Motor 2 ASR Integral Time 1] and C5-24 [Motor 2 ASR Integral Time 2] as well as between C5-21 and C5-23.</p>	0.0 (Determined by A1-02)

Switching the proportional gain and integral time in the low or high speed range can help stabilize operation. A good switching point is 80% of the frequency where oscillation occurs or at 80% of the maximum output frequency.

Note:

A multi-function input set for H1-xx = 77 [MFDI Function Select = ASR Gain Switch] takes priority over the ASR gain switching frequency.

■ **C5-28: Motor 2 ASR Integral Limit**

No. (Hex.)	Name	Description	Default (Range)
C5-28 (035D)	Motor 2 ASR Integral Limit	<div style="display: flex; justify-content: space-between; font-size: small;"> V/f CL-V/f OLV CLV AOLV OLV/PM AOLV/PM CLV/PM EZOLV </div> <p>Sets the upper limit for ASR in units of %. Sets the percentage of the rated load.</p>	400% (0 - 400%)

■ **C5-29: Speed Control Response**

No. (Hex.)	Name	Description	Default (Range)
C5-29 (0B18)	Speed Control Response	<div style="display: flex; justify-content: space-between; font-size: small;"> V/f CL-V/f OLV CLV AOLV OLV/PM AOLV/PM CLV/PM EZOLV </div> <p>Selects the responsiveness of speed control. Normally there is no need to change this setting.</p>	0 (0, 1)

If a high level of speed control responsiveness is necessary, set C5-29 = 1 and then adjust the speed control (ASR) parameter.

0 : Standard

1 : High speed

■ **C5-32: Motor 2 Integral Oper @ Acc/Dec**

No. (Hex.)	Name	Description	Default (Range)
C5-32 (0361)	Motor 2 Integral Oper @ Acc/Dec	<div style="display: flex; justify-content: space-between; font-size: small;"> V/f CL-V/f OLV CLV AOLV OLV/PM AOLV/PM CLV/PM EZOLV </div> <p>Enables or disables integral operation during acceleration and deceleration.</p>	0 (0, 1)

Enabling integral operation when driving a heavy load or a high inertia load may cause problems with overshoot or undershoot at the end of acceleration and deceleration. Set C5-32 = 0 [Disabled] if there are problems of overshooting or undershooting.

0 : Disabled

Integral operation is enabled during constant speed. Integral operation is not enabled during acceleration or deceleration.

1 : Enabled

Integral operation is always enabled.

■ C5-37: Motor 2 Inertia

No. (Hex.)	Name	Description	Default (Range)
C5-37 (0278)	Motor 2 Inertia	<input type="checkbox"/> V/f <input type="checkbox"/> CL-V/f <input type="checkbox"/> OLV <input checked="" type="checkbox"/> CLV <input type="checkbox"/> AOLV <input type="checkbox"/> OLV/PM <input type="checkbox"/> AOLV/PM <input type="checkbox"/> CLV/PM <input type="checkbox"/> EZOLV Configures the motor inertia.	Determined by o2-04 and C6-01 (0.0001 - 6.0000 kgm ²)

Executing any of the following Auto-Tuning processes automatically sets C5-37 with the value of [Motor Inertia].

- *Inertia Tuning*
- *ASR Tuning*

■ C5-38: Motor 2 Load Inertia Ratio

No. (Hex.)	Name	Description	Default (Range)
C5-38 (0279)	Motor 2 Load Inertia Ratio	<input type="checkbox"/> V/f <input type="checkbox"/> CL-V/f <input type="checkbox"/> OLV <input checked="" type="checkbox"/> CLV <input type="checkbox"/> AOLV <input type="checkbox"/> OLV/PM <input type="checkbox"/> AOLV/PM <input type="checkbox"/> CLV/PM <input type="checkbox"/> EZOLV Sets the load inertia ratio for the motor inertia.	1.0 (0.0 - 6000.0)

Executing any of the following Auto-Tuning processes automatically sets C5-38 with the value of [Load Inertia Ratio].

- *Inertia Tuning*
- *ASR Tuning*

■ C5-39: ASR Primary Delay Time Const 2

No. (Hex.)	Name	Description	Default (Range)
C5-39 (030D)	ASR Primary Delay Time Const 2	<input type="checkbox"/> V/f <input type="checkbox"/> CL-V/f <input type="checkbox"/> OLV <input type="checkbox"/> CLV <input type="checkbox"/> AOLV <input type="checkbox"/> OLV/PM <input checked="" type="checkbox"/> AOLV/PM <input type="checkbox"/> CLV/PM <input type="checkbox"/> EZOLV Sets the filter time constant used for the time from the speed loop to the torque command output. There is normally no need to change this parameter from the default value.	0.000 s (0.000 - 0.500 s)

Increase this setting gradually in increments of 0.01 for loads with low rigidity or when oscillation is a problem.

■ C5-50: Notch Filter Frequency

No. (Hex.)	Name	Description	Default (Range)
C5-50 (0B14)	Notch filter frequency	<input type="checkbox"/> V/f <input type="checkbox"/> CL-V/f <input type="checkbox"/> OLV <input checked="" type="checkbox"/> CLV <input type="checkbox"/> AOLV <input type="checkbox"/> OLV/PM <input type="checkbox"/> AOLV/PM <input type="checkbox"/> CLV/PM <input type="checkbox"/> EZOLV Sets the machine resonance frequency in increments of 1 Hz.	0 Hz (0, or 2 to 100 Hz)

Machine resonance can cause high-frequency noise to occur during operation and can cause vibration. The notch filter can sometimes help suppress this noise and vibration. Notch filters can be used to remove specific vibrational frequency components generated by machine resonance by setting the resonant frequency of the machine.

Note:

- Make sure to set the value for the notch filter frequency correctly. If the frequency setting value is too low in regards to the speed loop response frequency, this could adversely affect the speed control functionality. Set the frequency to be at least 4 times the speed loop response frequency.
- Setting C5-50 to 0 Hz disables the notch filter.

■ C5-51: Notch Filter Bandwidth

No. (Hex.)	Name	Description	Default (Range)
C5-51 (0B15)	Notch Filter Bandwidth	<input type="checkbox"/> V/f <input type="checkbox"/> CL-V/f <input type="checkbox"/> OLV <input checked="" type="checkbox"/> CLV <input type="checkbox"/> AOLV <input type="checkbox"/> OLV/PM <input type="checkbox"/> AOLV/PM <input type="checkbox"/> CLV/PM <input type="checkbox"/> EZOLV Sets the notch width of the notch filter.	1.0 (0.5 - 5.0)

◆ C6: Carrier Frequency

C6 parameters are used to set the selection of drive duty rating, selection of carrier frequency, and upper and lower limits of carrier frequencies.

■ C6-01: Normal / Heavy Duty Selection

No. (Hex.)	Name	Description	Default (Range)
C6-01 (0223)	Normal / Heavy Duty Selection	V/f CL-V/f OLV CLV AOLV OLV/PM AOLV/PM CLV/PM EZOLV Selects the drive duty rating.	0 (0, 1)

0 : Constant Torque Application Heavy Duty Rating 1 (HD1)

The overload tolerance is 150% of the rated output current for 60 seconds.

1 : Variable Torque Application Normal Duty Rating 1 (ND1)

The overload tolerance is 110% of the rated output current for 60 seconds.

The ratings for this product are based on two types of load ratings depending on the load characteristics of an application: Heavy Duty Rating (HD) and Normal Duty Rating (ND).

The drive rated output current, overload tolerance, and acceleration stall prevention level differs between HD and ND modes. Configure in accordance with the duty rating of the selected drive capacity. When HD is selected, the tolerance is a 150% overload state for 60 seconds. When ND is selected, the tolerance is a 110% overload state for 60 seconds. In other words, the rated output current for ND drives is higher than that for HD drives. Refer to "Model Specifications (200 V Class)" and "Model Specifications (400 V Class)" for more information on rated output current.

Table 11.30 Differences between Heavy Duty Rating and Normal Duty Rating

Item	Heavy Duty Rating (HD1)	Normal Duty Rating (ND1)
C6-01 Setting	0	1
Load characteristics		
Application	This is applicable when significant overload tolerance is required during startup, acceleration, deceleration, and similar scenarios. <ul style="list-style-type: none"> • Extruder • Conveyor • Cranes and hoists • Applications that require constant torque or high overload capacity 	This is applicable when overload tolerance is not particularly necessary. <ul style="list-style-type: none"> • Fan • Pump • Blower
Overload Tolerance	150% - 60 seconds	110% - 60 seconds
Stall Prevent Level during Accel	150%	110%
Stall Prevent Level during Run	150%	110%
Carrier Frequency	2 kHz	2 kHz Swing-PWM

Note:

- Configure the stall prevention level used during acceleration with L3-02 and the stall prevention level used during run with L3-06.
- Changing *C6-01* changes the maximum capacity of applicable drive motors. The setting values of *E2-xx* and *E4-xx* are automatically changed to suitable values. The following parameters that are dependent on motor output are also automatically changed.
 - b8-04 [Energy Saving Coefficient Value]
 - C5-17 [Motor Inertia]
 - C5-37 [Motor 2 Inertia]
 - L2-03 [Momentary Power Loss Min BB Time]
 - L3-24 [Motor Accel Time for Inertia Cal]
 - n5-02 [Motor Acceleration Time]

■ C6-02: Carrier Frequency Selection

No. (Hex.)	Name	Description	Default (Range)
C6-02 (0224)	Carrier Frequency Selection	<div style="display: flex; justify-content: space-between; font-size: small; font-weight: bold;"> V/f CL-V/f OLV CLV AOLV OLV/PM AOLV/PM CLV/PM EZOLV </div> Selects the switching frequency (carrier frequency) for the transistors inside the drive.	Determined by A1-02, C6-01, and o2-04 (Determined by A1-02)

Changes to the switching frequency lower audible noise and reduce leakage current.

Note:

Increasing the carrier frequency above the default setting automatically lowers the drive current rating.

1 : 2.0 kHz

2 : 5.0 kHz (4.0 kHz)

3 : 8.0 kHz (6.0 kHz)

4 : 10.0 kHz (8.0 kHz)

5 : 12.5 kHz (10.0 kHz)

6 : 15.0 kHz (12.0 kHz)

7 : Swing PWM 1

8 : Swing PWM 2

9 : Swing PWM 3

A : Swing PWM 4

F : User Defined (C6-03 to C6-05)

Set detailed setting values using *C6-03 to C6-05*.

Note:

- Swing PWM uses a carrier frequency of 2.0 kHz as a base. Swing PWM applies a special PWM pattern to reduce the audible noise.
- The value in parenthesis indicates the carrier frequency when *A1-02 = 6 [Control Method Selection = PM Advanced Open Loop Vector]*.

Table 11.31 Guidelines for Carrier Frequency Parameter Setup

Symptom	Remedy
Speed and torque are unstable at low speed.	Lower the carrier frequency.
Noise from the drive affects peripheral devices.	Lower the carrier frequency.
Excessive leakage current from the drive.	Lower the carrier frequency.
Wiring between the drive and motor is too long.	Lower the carrier frequency. Note: Refer to Table 11.32 for the wiring distance and lower the carrier frequency. The carrier frequency may need to be lowered if the motor cable is too long. Refer to the following table.
Audible motor noise is too loud.	Increase the carrier frequency. Use Swing PWM. Note: The default carrier frequency in ND is Swing PWM (C6-02 = 7), using a 2 kHz base. Increasing the carrier frequency is permissible when the drive is set for Normal Duty, however the drive rated current is reduced when the carrier frequency is increased.

Table 11.32 Wiring distance

Wiring distance	Up to 50 m	Up to 100 m	Greater than 100 m
C6-02 [Carrier Frequency Selection]	1 to F (up to 15 kHz)	1 to 2 (up to 5 kHz), 7	1 (up to 2 kHz), 7

Note:

The maximum cable length is 100 m when using *A1-02 = 5 [PM Open Loop Vector Control]* or 6.

■ C6-03: Carrier Frequency Upper Limit

No. (Hex.)	Name	Description	Default (Range)
C6-03 (0225)	Carrier Frequency Upper Limit	<div style="display: flex; justify-content: space-between; font-size: small;"> V/f CL-V/f OLV CLV AOLV OLV/PM AOLV/PM CLV/PM EZOLV </div> <p>Sets the upper limit of the carrier frequency. This parameter can only be set when $C6-02 = F$ [Carrier Frequency Selection = User Defined (C6-03 to C6-05)].</p>	Determined by C6-02 (1.0 - 15.0 kHz)

Setting a Fixed User Defined Carrier Frequency

A carrier frequency between fixed selectable values that cannot be selected by C6-02 can be set to C6-03. The carrier frequency will be fixed to the value set to C6-03.

When $A1-02 = 0, 1$ [Control Method Selection = V/f Control, Closed Loop V/f Control], set $C6-03 = C6-04$ [Carrier Frequency Lower Limit] to fix the carrier frequency.

Setting a Variable Carrier Frequency in Accordance with the Output Frequency

When $A1-02 = 0, 1$, the carrier frequency can be set up to change linearly with the output frequency by setting C6-03, C6-04, and C6-05 [Carrier Freq Proportional Gain] as following figure.

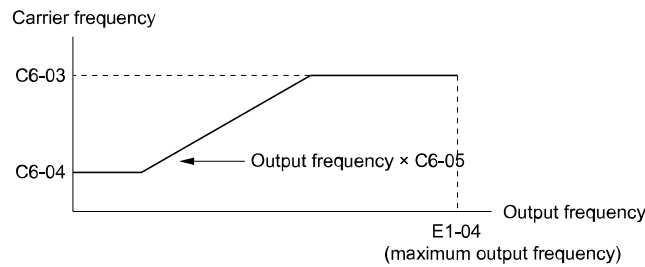

Figure 11.55 Setting a Variable Carrier Frequency in Accordance with the Output Frequency

Note:

- The setting of C6-04 is disabled when $C6-05 \leq 7$. The carrier frequency is fixed to the value set to C6-03.
- $oPE11$ [Carrier Frequency Setting Error] is detected when the following conditions are all satisfied at the same time.
 - $C6-05 \geq 6$
 - $C6-04 \geq C6-03$

■ C6-04: Carrier Frequency Lower Limit

No. (Hex.)	Name	Description	Default (Range)
C6-04 (0226)	Carrier Frequency Lower Limit	<div style="display: flex; justify-content: space-between; font-size: small;"> V/f CL-V/f OLV CLV AOLV OLV/PM AOLV/PM CLV/PM EZOLV </div> <p>Sets the lower limit of the carrier frequency. This parameter can only be set when $C6-02 = F$ [Carrier Frequency Selection = User Defined (C6-03 to C6-05)].</p>	Determined by C6-02 (1.0 - 15.0 kHz)

The carrier frequency can be set up to change linearly with the output frequency by setting C6-03 [Carrier Frequency Upper Limit], C6-04, and C6-05 Carrier Freq Proportional Gain].

Note:

- $oPE11$ [Carrier Frequency Setting Error] is detected when the following conditions are all satisfied at the same time.
 - $C6-04 \geq C6-03$
 - $C6-05 \geq 6$

■ C6-05: Carrier Freq Proportional Gain

No. (Hex.)	Name	Description	Default (Range)
C6-05 (0227)	Carrier Freq Proportional Gain	<div style="display: flex; justify-content: space-between; font-size: small;"> V/f CL-V/f OLV CLV AOLV OLV/PM AOLV/PM CLV/PM EZOLV </div> <p>Sets the proportional gain for the carrier frequency. This parameter can only be set when $C6-02 = F$ [Carrier Frequency Selection = User Defined (C6-03 to C6-05)].</p>	Determined by C6-02 (0 - 99)

The carrier frequency can be set up to change linearly with the output frequency by setting C6-03 [Carrier Frequency Upper Limit], C6-04 [Carrier Frequency Lower Limit], and C6-05.

■ C6-09: Carrier Frequency @ RotateTuning

No. (Hex.)	Name	Description	Default (Range)
C6-09 (022B)	Carrier Frequency @ RotateTuning	<div style="display: flex; justify-content: space-between; font-size: small;"> V/f CL-V/f OLV CLV AOLV OLV/PM AOLV/PM CLV/PM EZOLV </div> Selects the carrier frequency while performing Auto-Tuning. There is normally no need to change this parameter from the default value.	0 (0, 1)

When Auto-Tuning a high frequency motor or low impedance motor and the carrier frequency is set to a low level, *oC* [Overcurrent] may occur. To prevent *oC* from occurring, it may be helpful to set the carrier frequency to a high value before setting *C6-09* = 1.

The procedure to set the carrier frequency varies depending on the setting of *A1-02* [Control Method Selection].

- When *A1-02* = 2 to 4 [IOLV, CLV, or AOLV], set *C6-02* = F [Carrier Frequency Selection = User Defined] and then increase the value set to *C6-03* [Carrier Frequency Upper Limit].
- When *A1-02* = 5 to 7 [OLV/PM, AOLV/PM, or CLV/PM], increase the setting value of the carrier frequency using *C6-02*.

0 : 5 kHz

Note:

If *A1-02* = 5, 6, or 7, the carrier frequency is 2 kHz.

1 : use C6-03

Note:

If *A1-02* = 5, 6, or 7, the carrier frequency is the value set to *C6-02*.

11.5 d: Reference Settings

d parameters [References] set the frequency reference input method and dead band range. They also set torque control, field weakening, and field forcing functions.

WARNING! Sudden Movement Hazard. Always check the operation of any fast stop circuits after they are wired. Fast stop circuits are required to provide safe and quick shutdown of the drive. Prepare to initiate an emergency stop during the test run. Operating a drive with untested emergency circuits could result in death or serious injury.

WARNING! Crush Hazard. Do not use this drive in lifting applications without installing external safety circuitry to prevent accidental dropping of the load. The drive does not possess built-in load drop protection for lifting applications. Install electrical and/or mechanical safety circuit mechanisms independent of drive circuitry. Failure to comply could result in death or serious injury from falling loads.

◆ d1: Frequency Reference

The following block diagram shows the frequency reference input method, command source selection method and priority descriptions.

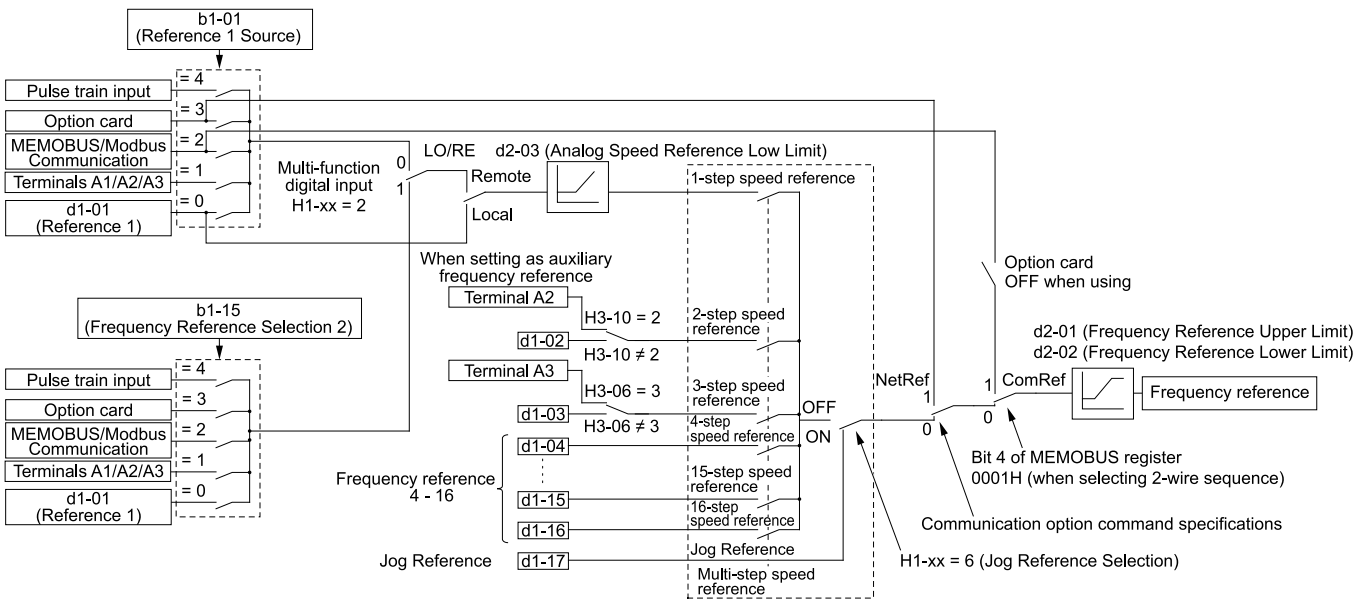

Figure 11.56 Frequency Reference Setting Hierarchy

■ Multi-Step Speed Operation

The drive has a multi-step speed operation function capable of assigning several frequency references in advance. Assign frequency references to *d1-xx*. Registered frequency references can be selected by combining with multi-function input signals from an external source. Select the frequency reference to change the motor speed in stages by turning ON/OFF the digital input. The user can switch the speed up to the maximum 17-step speed using the 16-step frequency reference and one Jog Frequency Reference (JOG command).

Note:

- Jog Frequency Reference (JOG command) overrides all other frequency references.
- The user can switch the frequency reference using the multi-function digital input even while the motor is running. The acceleration and deceleration times that are enabled at the time are applied.
- The default setting for Multi-Step Speed Reference 1 (master frequency reference) and Multi-Step Speed Reference 2 (auxiliary frequency reference) are the analog frequency reference. Also, voltage command input terminal A1 and current input terminal A2 for Multi-Step Speed Reference 1 (master frequency reference) are added internally by default. The drive uses Multi-Step Speed Reference 1 even if the signal is connected to either of the analog input terminals.

■ Setting Procedures for Multi-step Speed Operation

When Using an Analog Input as Reference 1 and 2

This section describes the procedures to configure the following examples.

- Multi-Step Speed 6 (6 types of frequency references)
- When setting the voltage input of analog inputs from terminals A1 and A3 to -10 V to +10 V

Procedure	Configuration Parameter	Task contents
1	Reference 1	<ol style="list-style-type: none"> 1. Sets $b1-01 = 1$ [Frequency Reference Selection 1 = Analog Input]. 2. Sets $H3-02 = 0$ [Terminal A1 Function Selection = Frequency Bias]. 3. Sets $H3-01 = 1$ [Terminal A1 Signal Level Select = 0-10V (BipolRef)].
2	Reference 2	<ol style="list-style-type: none"> 1. Sets $H3-06 = 2$ [Terminal A3 Function Selection = Auxiliary Frequency Reference 1]. 2. Sets $H3-05 = 1$ [Terminal A3 Signal Level Select = 0-10V (BipolRef)].
3	Signal type of analog input	Configure DIP switches S1-1 and S1-3 on the control circuit board to the V-side (voltage). Note: Set this before energizing the drive.
4	Reference 3	Sets the value of $d1-03$ [Reference 3].
5	Reference 4	Sets the value of $d1-04$ [Reference 4].
6	Reference 5	Sets the value of $d1-05$ [Reference 5].
7	Jog Reference	Sets $d1-17$ [Jog Reference] to the jog speed.
8	External digital input (3 inputs)	Set the Multi-Step Speed Reference 1 to 3 [$H1-xx = 3, 4, 5$] to one of the multi-function digital input terminals S1 to S8.
9	JOG command	Set the Jog Reference Selection [$H1-xx = 6$] to one of the multi-function digital input terminals S1 to S8.

When Performing Max. 17 Step Speed with All Digital Inputs

This section describes the procedure for setting the 17 step speeds (17 types of frequency references) without using an analog input.

Procedure	Configuration Parameter	Task contents
1	Reference 1	<ol style="list-style-type: none"> 1. Set $b1-01 = 0$ [Frequency Reference Selection 1 = Keypad]. 2. Sets the value of $d1-01$ [Reference 1].
2	Reference 2	<ol style="list-style-type: none"> 1. Sets $H3-06 = F$ [Terminal A3 Function Selection = Through Mode], and disables the analog reference. 2. Set $d1-02$ [Reference 2].
3	Reference 3	<ol style="list-style-type: none"> 1. Sets $H3-10 = F$ [Terminal A2 Function Selection = Through Mode], and disables the analog reference. 2. Set $d1-03$ [Reference 3].
4	Reference 4	Set $d1-04$ [Reference 4].
5	Reference 5 to 16	Sets the values of $d1-05$ to $d1-16$ [Reference 5 to 16] using the same procedure.
6	Jog Reference	Sets $d1-17$ [Jog Reference] to the jog speed.
7	External digital input (4 inputs)	Set Multi-Step Speed Reference 1 to 4 [$H1-xx = 3, 4, 5, 32$] to one of the multi-function digital input terminals S1 to S8.
8	JOG command	Set the Jog Reference Selection [$H1-xx = 6$] to one of the multi-function digital input terminals S1 to S8.

Multi-step Speed Operation Combinations

Refer to the following table and diagram for multi-step speed reference combinations. The selected frequency reference changes depending on the combination of digital input signals from an external source.

Table 11.33 Multi-step Speed Reference and Multi-function Digital Input Terminal Combinations

Related Parameters	Multi-Step Speed Reference 1 $H1-xx = 3$	Multi-Step Speed Reference 2 $H1-xx = 4$	Multi-Step Speed Reference 3 $H1-xx = 5$	Multi-Step Speed Reference 4 $H1-xx = 32$	Jog Reference $H1-xx = 6$
Reference 1 (set in $b1-01$)	OFF	OFF	OFF	OFF	OFF
Reference 2 ($d1-02$ or terminals A1, A2, A3)	ON	OFF	OFF	OFF	OFF
Reference 3 ($d1-03$ or terminals A1, A2, A3)	OFF	ON	OFF	OFF	OFF

11.5 d: Reference Settings

Related Parameters	Multi-Step Speed Reference 1 H1-xx = 3	Multi-Step Speed Reference 2 H1-xx = 4	Multi-Step Speed Reference 3 H1-xx = 5	Multi-Step Speed Reference 4 H1-xx = 32	Jog Reference H1-xx = 6
Reference 4 (d1-04)	ON	ON	OFF	OFF	OFF
Reference 5 (d1-05)	OFF	OFF	ON	OFF	OFF
Reference 6 (d1-06)	ON	OFF	ON	OFF	OFF
Reference 7 (d1-07)	OFF	ON	ON	OFF	OFF
Reference 8 (d1-08)	ON	ON	ON	OFF	OFF
Reference 9 (d1-09)	OFF	OFF	OFF	ON	OFF
Reference 10 (d1-10)	ON	OFF	OFF	ON	OFF
Reference 11 (d1-11)	OFF	ON	OFF	ON	OFF
Reference 12 (d1-12)	ON	ON	OFF	ON	OFF
Reference 13 (d1-13)	OFF	OFF	ON	ON	OFF
Reference 14 (d1-14)	ON	OFF	ON	ON	OFF
Reference 15 (d1-15)	OFF	ON	ON	ON	OFF
Reference 16 (d1-16)	ON	ON	ON	ON	OFF
Jog Reference (d1-17)*1	-	-	-	-	ON

*1 Jog Reference (JOG command) is given priority over all other frequency references.

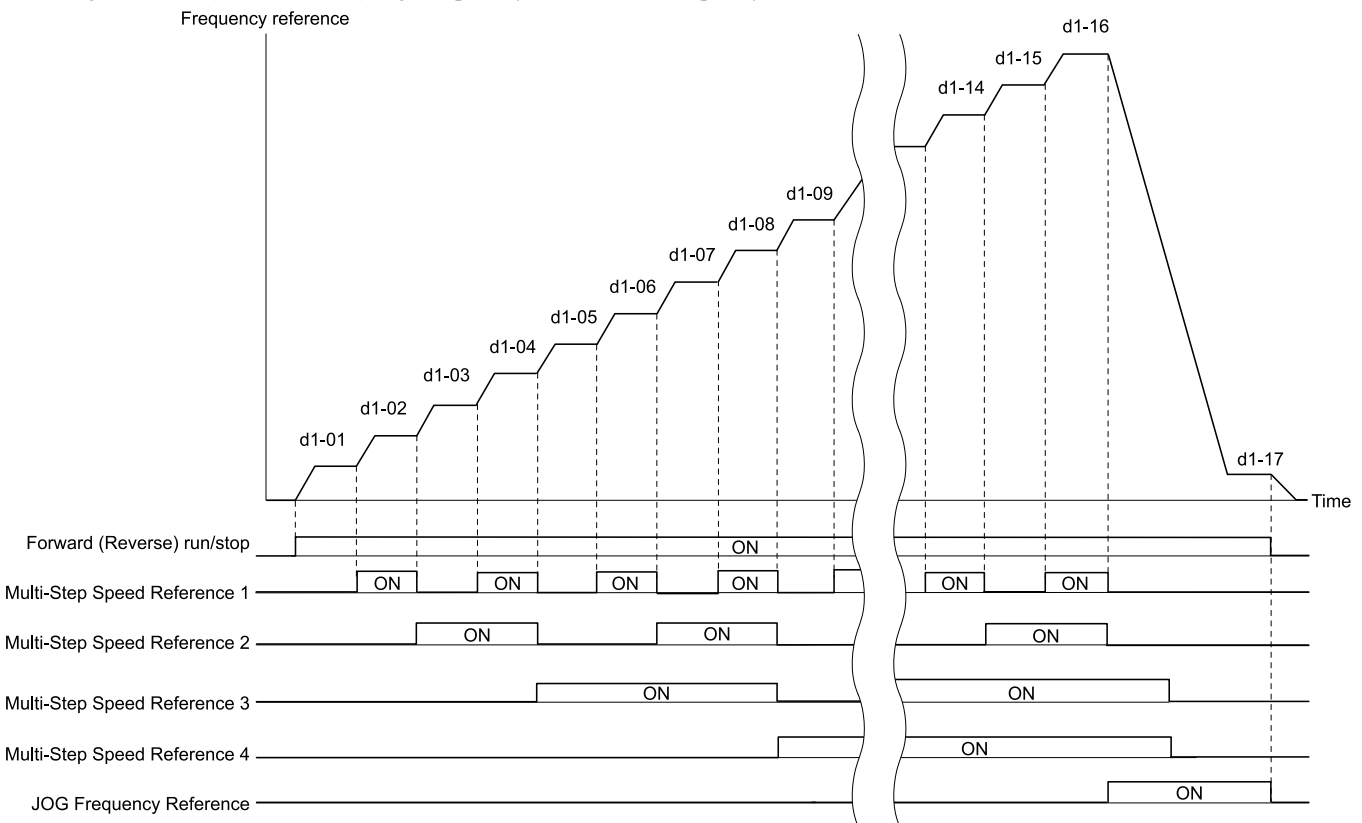

Figure 11.57 Time Chart for Multi-step Speed Reference/Jog Reference

■ d1-01: Reference 1

No. (Hex.)	Name	Description	Default (Range)
d1-01 (0280) RUN	Reference 1	V/f CL-V/f OLV CLV AOLV OLV/PM AOLV/PM CLV/PM EZOLV Sets the frequency reference in the unit set in o1-03 [Keypad Display Selection].	0.00 Hz (0.00 - 590.00 Hz)

Note:

- The upper limit value changes according to the value set in *E1-04* [Maximum Output Frequency] and *d2-01* [Frequency Reference Upper Limit]. Use the following formula to calculate the upper limit value.
Upper limit value = $(E1-04) \times (d2-01) / 100$
- The value set to *o1-03* [Keypad Display Selection] is changed to 1 [0.01% (100% = *E1-04*)] when *A1-02* = 6, 7 [Control Method Selection = PM Advanced Open Loop Vector, PM Closed Loop Vector Control].
- To set *d1-01* to 1-step speed parameter in a multi-step speed operation, set *b1-01* = 0 [Frequency Reference Selection 1 = Keypad].

■ d1-02: Reference 2

No. (Hex.)	Name	Description	Default (Range)
d1-02 (0281) RUN	Reference 2	<div style="display: flex; justify-content: space-between; font-size: 0.8em; font-weight: bold; background-color: #f0f0f0; padding: 2px;"> V/f CL-V/f OLV CLV AOLV OLV/PM AOLV/PM CLV/PM EZOLV </div> Sets the frequency reference in the unit set in <i>o1-03</i> [Keypad Display Selection].	0.00 Hz (0.00 - 590.00 Hz)

Note:

- The upper limit is determined by *E1-04* [Maximum Output Frequency] and *d2-01* [Frequency Reference Upper Limit].
- The value set to *o1-03* [Keypad Display Selection] is changed to 1 [0.01% (100% = *E1-04*)] when *A1-02* = 6, 7 [AOLV/PM, CLV/PM].
- To set *d1-02* to Multi-Step Speed 2, set all MFAI function selections [*H3-02*, *H3-06*, and *H3-10*] to any other value than 2 [Auxiliary Frequency Reference 1]. If the status is the default setting, set *H3-06* = F [Terminal A3 Function Selection = Through Mode].

■ d1-03: Reference 3

No. (Hex.)	Name	Description	Default (Range)
d1-03 (0282) RUN	Reference 3	<div style="display: flex; justify-content: space-between; font-size: 0.8em; font-weight: bold; background-color: #f0f0f0; padding: 2px;"> V/f CL-V/f OLV CLV AOLV OLV/PM AOLV/PM CLV/PM EZOLV </div> Sets the frequency reference in the unit set in <i>o1-03</i> [Keypad Display Selection].	0.00 Hz (0.00 - 590.00 Hz)

Note:

- The upper limit is determined by *E1-04* [Maximum Output Frequency] and *d2-01* [Frequency Reference Upper Limit].
- The value set to *o1-03* [Keypad Display Selection] is changed to 1 [0.01% (100% = *E1-04*)] when *A1-02* = 6, 7 [Control Method Selection = AOLV/PM, CLV/PM].
- To set *d1-03* to Multi-Step Speed 3, set all MFAI function selections [*H3-02*, *H3-06*, and *H3-10*] to any other value than 3 [Auxiliary Frequency Reference 2].

■ d1-04: Reference 4

No. (Hex.)	Name	Description	Default (Range)
d1-04 (0283) RUN	Reference 4	<div style="display: flex; justify-content: space-between; font-size: 0.8em; font-weight: bold; background-color: #f0f0f0; padding: 2px;"> V/f CL-V/f OLV CLV AOLV OLV/PM AOLV/PM CLV/PM EZOLV </div> Sets the frequency reference in the unit set in <i>o1-03</i> [Keypad Display Selection].	0.00 Hz (0.00 - 590.00 Hz)

Note:

- The upper limit is determined by *E1-04* [Maximum Output Frequency] and *d2-01* [Frequency Reference Upper Limit].
- The value set to *o1-03* [Keypad Display Selection] is changed to 1 [0.01% (100% = *E1-04*)] when *A1-02* = 6, 7 [AOLV/PM, CLV/PM].
- Parameter *d1-04* sets the frequency reference of Multi-Step Speed 4.

■ d1-05: Reference 5

No. (Hex.)	Name	Description	Default (Range)
d1-05 (0284) RUN	Reference 5	<div style="display: flex; justify-content: space-between; font-size: 0.8em; font-weight: bold; background-color: #f0f0f0; padding: 2px;"> V/f CL-V/f OLV CLV AOLV OLV/PM AOLV/PM CLV/PM EZOLV </div> Sets the frequency reference in the unit set in <i>o1-03</i> [Keypad Display Selection].	0.00 Hz (0.00 - 590.00 Hz)

Note:

- The upper limit is determined by *E1-04* [Maximum Output Frequency] and *d2-01* [Frequency Reference Upper Limit].
- The value set to *o1-03* [Keypad Display Selection] is changed to 1 [0.01% (100% = *E1-04*)] when *A1-02* = 6, 7 [Control Method Selection = AOLV/PM, CLV/PM].
- Parameter *d1-05* sets the frequency reference of Multi-Step Speed 5.

■ d1-06: Reference 6

No. (Hex.)	Name	Description	Default Setting (Range)
d1-06 (0285) RUN	Reference 6	<div style="display: flex; justify-content: space-between; font-size: 0.8em; font-weight: bold; margin-bottom: 5px;"> V/f CL-V/f OLV CLV AOLV OLV/PM AOLV/PM CLV/PM EZOLV </div> Sets the frequency reference in the unit set in <i>o1-03 [Keypad Display Selection]</i> .	0.00 Hz (0.00 - 590.00 Hz)

Note:

- The upper limit is determined by *E1-04 [Maximum Output Frequency]* and *d2-01 [Frequency Reference Upper Limit]*.
- The value set to *o1-03 [Keypad Display Selection]* is changed to 1 [0.01% (100% = *E1-04*)] when *A1-02 = 6, 7 [Control Method Selection = AOLV/PM, CLV/PM]*.
- Parameter *d1-06* sets the frequency reference of Multi-Step Speed 6.

■ d1-07: Reference 7

No. (Hex.)	Name	Description	Default (Range)
d1-07 (0286) RUN	Reference 7	<div style="display: flex; justify-content: space-between; font-size: 0.8em; font-weight: bold; margin-bottom: 5px;"> V/f CL-V/f OLV CLV AOLV OLV/PM AOLV/PM CLV/PM EZOLV </div> Sets the frequency reference in the unit set in <i>o1-03 [Keypad Display Selection]</i> .	0.00 Hz (0.00 - 590.00 Hz)

Note:

- The upper limit is determined by *E1-04 [Maximum Output Frequency]* and *d2-01 [Frequency Reference Upper Limit]*.
- The value set to *o1-03 [Keypad Display Selection]* is changed to 1 [0.01% (100% = *E1-04*)] when *A1-02 = 6, 7 [Control Method Selection = AOLV/PM, CLV/PM]*.
- Parameter *d1-07* sets the frequency reference of Multi-Step Speed 7.

■ d1-08: Reference 8

No. (Hex.)	Name	Description	Default (Range)
d1-08 (0287) RUN	Reference 8	<div style="display: flex; justify-content: space-between; font-size: 0.8em; font-weight: bold; margin-bottom: 5px;"> V/f CL-V/f OLV CLV AOLV OLV/PM AOLV/PM CLV/PM EZOLV </div> Sets the frequency reference in the unit set in <i>o1-03 [Keypad Display Selection]</i> .	0.00 Hz (0.00 - 590.00 Hz)

Note:

- The upper limit is determined by *E1-04 [Maximum Output Frequency]* and *d2-01 [Frequency Reference Upper Limit]*.
- The value set to *o1-03 [Keypad Display Selection]* is changed to 1 [0.01% (100% = *E1-04*)] when *A1-02 = 6, 7 [Control Method Selection = AOLV/PM, CLV/PM]*.
- Parameter *d1-08* sets the frequency reference of Multi-Step Speed 8.

■ d1-09: Reference 9

No. (Hex.)	Name	Description	Default (Range)
d1-09 (0288) RUN	Reference 9	<div style="display: flex; justify-content: space-between; font-size: 0.8em; font-weight: bold; margin-bottom: 5px;"> V/f CL-V/f OLV CLV AOLV OLV/PM AOLV/PM CLV/PM EZOLV </div> Sets the frequency reference in the unit set in <i>o1-03 [Keypad Display Selection]</i> .	0.00 Hz (0.00 - 590.00 Hz)

Note:

- The upper limit is determined by *E1-04 [Maximum Output Frequency]* and *d2-01 [Frequency Reference Upper Limit]*.
- The value set to *o1-03 [Keypad Display Selection]* is changed to 1 [0.01% (100% = *E1-04*)] when *A1-02 = 6, 7 [Control Method Selection = AOLV/PM, CLV/PM]*.
- Parameter *d1-09* sets the frequency reference of Multi-Step Speed 9.

■ d1-10: Reference 10

No. (Hex.)	Name	Description	Default (Range)
d1-10 (028B) RUN	Reference 10	<div style="display: flex; justify-content: space-between; font-size: 0.8em; font-weight: bold; margin-bottom: 5px;"> V/f CL-V/f OLV CLV AOLV OLV/PM AOLV/PM CLV/PM EZOLV </div> Sets the frequency reference in the unit set in <i>o1-03 [Keypad Display Selection]</i> .	0.00 Hz (0.00 - 590.00 Hz)

Note:

- The upper limit is determined by *E1-04 [Maximum Output Frequency]* and *d2-01 [Frequency Reference Upper Limit]*.
- The value set to *o1-03 [Keypad Display Selection]* is changed to 1 [0.01% (100% = *E1-04*)] when *A1-02 = 6, 7 [Control Method Selection = AOLV/PM, CLV/PM]*.
- Parameter *d1-10* sets the frequency reference of Multi-Step Speed 10.

■ d1-11: Reference 11

No. (Hex.)	Name	Description	Default (Range)
d1-11 (028C) RUN	Reference 11	V/f CL-V/f OLV CLV AOLV OLV/PM AOLV/PM CLV/PM EZOLV Sets the frequency reference in the unit set in <i>o1-03 [Keypad Display Selection]</i> .	0.00 Hz (0.00 - 590.00 Hz)

Note:

- The upper limit is determined by *E1-04 [Maximum Output Frequency]* and *d2-01 [Frequency Reference Upper Limit]*.
- The value set to *o1-03 [Keypad Display Selection]* is changed to 1 [0.01% (100% = *E1-04*)] when *A1-02 = 6, 7 [Control Method Selection = AOLV/PM, CLV/PM]*.
- Parameter *d1-11* sets the frequency reference of Multi-Step Speed 11.

■ d1-12: Reference 12

No. (Hex.)	Name	Description	Default (Range)
d1-12 (028D) RUN	Reference 12	V/f CL-V/f OLV CLV AOLV OLV/PM AOLV/PM CLV/PM EZOLV Sets the frequency reference in the unit set in <i>o1-03 [Keypad Display Selection]</i> .	0.00 Hz (0.00 - 590.00 Hz)

Note:

- The upper limit is determined by *E1-04 [Maximum Output Frequency]* and *d2-01 [Frequency Reference Upper Limit]*.
- The value set to *o1-03 [Keypad Display Selection]* is changed to 1 [0.01% (100% = *E1-04*)] when *A1-02 = 6, 7 [Control Method Selection = AOLV/PM, CLV/PM]*.
- Parameter *d1-12* sets the frequency reference of Multi-Step Speed 12.

■ d1-13: Reference 13

No. (Hex.)	Name	Description	Default (Range)
d1-13 (028E) RUN	Reference 13	V/f CL-V/f OLV CLV AOLV OLV/PM AOLV/PM CLV/PM EZOLV Sets the frequency reference in the unit set in <i>o1-03 [Keypad Display Selection]</i> .	0.00 Hz (0.00 - 590.00 Hz)

Note:

- The upper limit is determined by *E1-04 [Maximum Output Frequency]* and *d2-01 [Frequency Reference Upper Limit]*.
- The value set to *o1-03 [Keypad Display Selection]* is changed to 1 [0.01% (100% = *E1-04*)] when *A1-02 = 6, 7 [Control Method Selection = AOLV/PM, CLV/PM]*.
- Parameter *d1-13* sets the frequency reference of Multi-Step Speed 13.

■ d1-14: Reference 14

No. (Hex.)	Name	Description	Default (Range)
d1-14 (028F) RUN	Reference 14	V/f CL-V/f OLV CLV AOLV OLV/PM AOLV/PM CLV/PM EZOLV Sets the frequency reference in the unit set in <i>o1-03 [Keypad Display Selection]</i> .	0.00 Hz (0.00 - 590.00 Hz)

Note:

- The upper limit is determined by *E1-04 [Maximum Output Frequency]* and *d2-01 [Frequency Reference Upper Limit]*.
- The value set to *o1-03 [Keypad Display Selection]* is changed to 1 [0.01% (100% = *E1-04*)] when *A1-02 = 6, 7 [Control Method Selection = AOLV/PM, CLV/PM]*.
- Parameter *d1-14* sets the frequency reference of Multi-Step Speed 14.

■ **d1-15: Reference 15**

No. (Hex.)	Name	Description	Default (Range)
d1-15 (0290) RUN	Reference 15	V/f CL-V/f OLV CLV AOLV OLV/PM AOLV/PM CLV/PM EZOLV Sets the frequency reference in the unit set in <i>o1-03 [Keypad Display Selection]</i> .	0.00 Hz (0.00 - 590.00 Hz)

Note:

- The upper limit is determined by *E1-04 [Maximum Output Frequency]* and *d2-01 [Frequency Reference Upper Limit]*.
- The value set to *o1-03 [Keypad Display Selection]* is changed to 1 [0.01% (100% = *E1-04*)] when *A1-02 = 6, 7 [Control Method Selection = AOLV/PM, CLV/PM]*.
- Parameter *d1-15* sets the frequency reference of Multi-Step Speed 15.

■ **d1-16: Reference 16**

No. (Hex.)	Name	Description	Default (Range)
d1-16 (0291) RUN	Reference 16	V/f CL-V/f OLV CLV AOLV OLV/PM AOLV/PM CLV/PM EZOLV Sets the frequency reference in the unit set in <i>o1-03 [Keypad Display Selection]</i> .	0.00 Hz (0.00 - 590.00 Hz)

Note:

- The upper limit is determined by *E1-04 [Maximum Output Frequency]* and *d2-01 [Frequency Reference Upper Limit]*.
- The value set to *o1-03 [Keypad Display Selection]* is changed to 1 [0.01% (100% = *E1-04*)] when *A1-02 = 6, 7 [Control Method Selection = AOLV/PM, CLV/PM]*.
- Parameter *d1-16* sets the frequency reference of Multi-Step Speed 16.

■ **d1-17: Jog Reference**

No. (Hex.)	Name	Description	Default (Range)
d1-17 (0292) RUN	Jog Reference	V/f CL-V/f OLV CLV AOLV OLV/PM AOLV/PM CLV/PM EZOLV Sets the Jog frequency reference according to the units set in <i>o1-03 [Frequency Display Unit Selection]</i> . Set <i>H1-xx = 6 [Terminal Sx Function Selection = Jog Reference Selection]</i> to use the Jog frequency reference.	6.00 Hz (0.00 - 590.00 Hz)

Note:

- The upper limit is determined by *E1-04 [Maximum Output Frequency]* and *d2-01 [Frequency Reference Upper Limit]*.
- The value set to *o1-03 [Keypad Display Selection]* is changed to 1 [0.01% (100% = *E1-04*)] when *A1-02 = 6, 7 [Control Method Selection = AOLV/PM, CLV/PM]*.

◆ **d2: Reference Limits**

d2 parameters set the upper and lower frequency limits to control the motor speed. Apply these parameters to for example, run the motor at low-speed due to mechanical strength concerns, or if the motor should not be run at low speed because of lubrication issues with the gears and bearings.

The upper frequency limit is set in *d2-01 [Frequency Reference Upper Limit]* and the lower limit is set in *d2-02 [Frequency Reference Lower Limit]*.

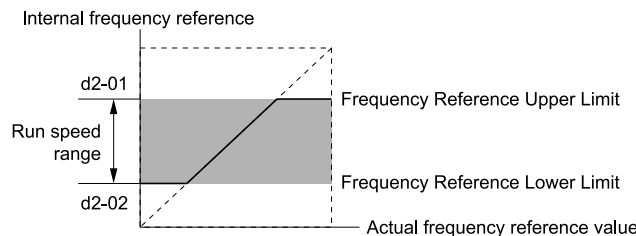

Figure 11.58 Upper and Lower Frequency Limits

■ d2-01: Frequency Reference Upper Limit

No. (Hex.)	Name	Description	Default (Range)
d2-01 (0289)	Frequency Reference Upper Limit	<div style="display: flex; justify-content: space-between; font-size: 0.8em; font-weight: bold; margin-bottom: 5px;"> V/f CL-V/f OLV CLV AOLV OLV/PM AOLV/PM CLV/PM EZOLV </div> Sets the maximum frequency reference as a percentage of <i>E1-04 [Maximum Output Frequency]</i> . This limit applies to all frequency references.	100.0% (0.0 - 110.0%)

The drive operates at the value set in *d2-01* even if the frequency reference exceeds the value set in *d2-01*.

■ d2-02: Frequency Reference Lower Limit

No. (Hex.)	Name	Description	Default (Range)
d2-02 (028A)	Frequency Reference Lower Limit	<div style="display: flex; justify-content: space-between; font-size: 0.8em; font-weight: bold; margin-bottom: 5px;"> V/f CL-V/f OLV CLV AOLV OLV/PM AOLV/PM CLV/PM EZOLV </div> Sets the minimum frequency reference as a percentage of <i>E1-04 [Maximum Output Frequency]</i> . This limit applies to all frequency references.	0.0% (0.0 - 110.0%)

The drive operates at the value set in *d2-02* even if the frequency reference falls below the value set in *d2-02*. The motor will accelerate up to *d2-02* after the Run command is switched ON and a lower frequency reference than *d2-02* has been entered.

■ d2-03: Analog Speed Reference Low Limit

No. (Hex.)	Name	Description	Default (Range)
d2-03 (0293)	Analog Speed Reference Low Limit	<div style="display: flex; justify-content: space-between; font-size: 0.8em; font-weight: bold; margin-bottom: 5px;"> V/f CL-V/f OLV CLV AOLV OLV/PM AOLV/PM CLV/PM EZOLV </div> Sets the lower limit of the master frequency reference (Multi-Step Speed 1) as a percentage of <i>E1-04 [Maximum Output Frequency]</i> .	0.0% (0.0 - 110.0%)

The lower limit of Jog reference, frequency reference for multi-step speed operation and the auxiliary frequency reference will not be adjusted.

The drive operates at the value set in *d2-03* even if the frequency reference falls below the value set in *d2-03*.

Note:

When lower limits are set to both parameters *d2-02 [Frequency Reference Lower Limit]* and *d2-03*, the drive uses the greater of those two values as the lower limit.

◆ d3: Jump Frequency

The Jump frequency is a function that sets the dead band to a certain frequency band. Performing variable speed operation of the machine that was running at a constant speed may make resonance. To run the machine avoiding resonance due to the natural frequency of the machinery mechanical system, perform a specific frequency band jump.

The drive can be programmed with three separate Jump frequencies. Sets *d3-01* to *d3-03 [Jump Frequencies]* to the median value for the jumped frequency and set *d3-04 [Jump Frequency Width]* to the Jump frequency width.

If a frequency reference was input that is the same as or close to the Jump frequency width, the frequency reference changes automatically.

The drive accelerates or decelerates the motor smoothly until the frequency reference falls outside the range of the Jump frequency band. The drive will use the active accel/decel time to pass through the specified dead band range. If the frequency reference falls outside the range of the Jump frequency band, switch to constant speed operation.

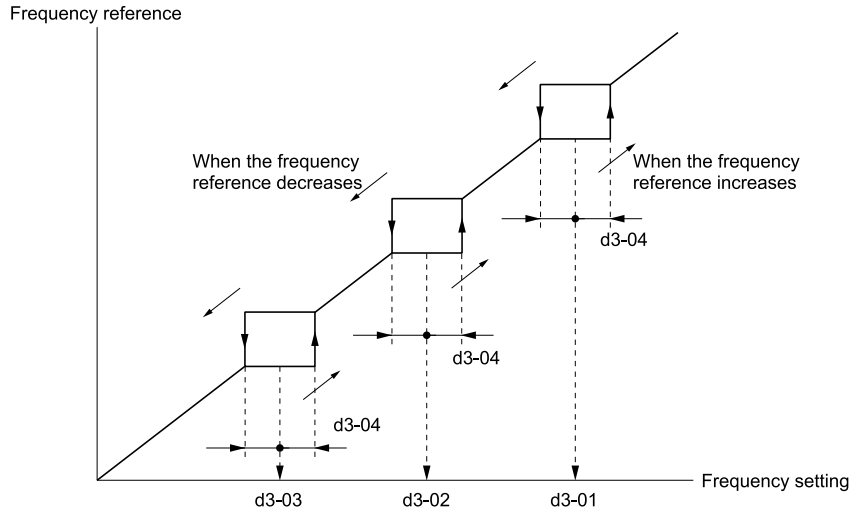

Figure 11.59 Jump Frequency

Note:

- When setting Jump Frequency 1 through 3, make sure that the parameters do not overlap.
- The frequency reference changes automatically when the drive is within the range of the Jump frequency. When Jump is executed, the output frequency does not change suddenly but changes smoothly according to the values set in C1-01 [Acceleration Time 1] and C1-02 [Deceleration Time 1].

■ **d3-01: Jump Frequency 1**

No. (Hex.)	Name	Description	Default (Range)
d3-01 (0294)	Jump Frequency 1	V/f CL-V/f OLV CLV AOLV OLV/PM AOLV/PM CLV/PM EZOLV Sets the median value of the specific frequency band that needs to be jumped.	0.0 Hz (Determined by A1-02)

Note:

Set this parameter to 0.0 Hz to disable the Jump frequency.

■ **d3-02: Jump Frequency 2**

No. (Hex.)	Name	Description	Default (Range)
d3-02 (0295)	Jump Frequency 2	V/f CL-V/f OLV CLV AOLV OLV/PM AOLV/PM CLV/PM EZOLV Sets the median value of the specific frequency band that needs to be jumped.	0.0 Hz (Determined by A1-02)

Note:

Set this parameter to 0.0 Hz to disable the Jump frequency.

■ **d3-03: Jump Frequency 3**

No. (Hex.)	Name	Description	Default (Range)
d3-03 (0296)	Jump Frequency 3	V/f CL-V/f OLV CLV AOLV OLV/PM AOLV/PM CLV/PM EZOLV Sets the median value of the specific frequency band that needs to be jumped.	0.0 Hz (Determined by A1-02)

Note:

Set this parameter to 0.0 Hz to disable the Jump frequency.

■ **d3-04: Jump Frequency Width**

No. (Hex.)	Name	Description	Default (Range)
d3-04 (0297)	Jump Frequency Width	V/f CL-V/f OLV CLV AOLV OLV/PM AOLV/PM CLV/PM EZOLV Sets the width of a specific frequency band that needs to be jumped.	1.0 Hz (Determined by A1-02)

◆ d4: Frequency Reference Hold and Up/Down 2 Function

d4 parameters set the Frequency Reference Hold function, the Up/Down and Up/Down 2 commands.

WARNING! Crush Hazard. Make sure that proper safety measures have been taken in hoist-type application to prevent the load from falling. Failure to do so may result in injury.

WARNING! Sudden Movement Hazard. If using the Baseblock command with hoist-type application, make sure the holding brake is closed when the Baseblock command is input and the drive shuts off its output. Failure to do so may result in the motor suddenly coasting when the Baseblock command is input, which may result in the load slipping or falling.

WARNING! Sudden Movement Hazard. When using a mechanical holding brake with the drive in a lifting application, close the brake when the drive output is cut off by a baseblock command triggered by one of the input terminals. Failure to comply will result in a slipping load from the motor suddenly coasting when the baseblock command is entered and may cause serious injury or death.

- **Frequency Reference Hold Function Command:** This acceleration/deceleration ramp hold command momentarily stops the acceleration/deceleration of the motor with a multi-function digital input, and continues operating the motor at the present output frequency at which the command reference was input. Acceleration/deceleration will resume when the acceleration/deceleration ramp hold command is switched OFF. With a crane for example, use the function in combination with 2-stage push button to stop acceleration and operate at low speed with one of the output frequencies.
- **Up/Down command:** The Up/Down command is a function to raise and lower the frequency reference by switching multi-function digital input ON/OFF. The Up/Down command overrides frequency references from the analog input terminal, pulse train input terminal and keypad.
- **Up/Down 2 command:** The Up/Down 2 command is a function to accelerate or decelerate by adding a preset bias value to the frequency reference. The Up/Down 2 command adds a bias value by switching the multi-function digital input ON/OFF.

■ d4-01: Freq Reference Retention Select

No. (Hex.)	Name	Description	Default (Range)
d4-01 (0298)	Freq Reference Retention Select	<div style="display: flex; gap: 5px;"> V/f CL-V/f OLV CLV AOLV OLV/PM AOLV/PM CLV/PM EZOLV </div> <p>Determines whether the frequency reference or the frequency bias (Up/Down 2) value is saved when the Stop command is entered or the power supply is shut down.</p>	0 (0, 1)

This parameter is available when *H1-xx [MFDI Function Select]* has been set to one of the following.

- *H1-xx = A [Accel/Decel Ramp Hold]*
- *H1-xx = 10/11 [Up/Down Command]*
- *H1-xx = 75/76 [Up/Down 2 Command]*

The Frequency Reference Hold function depends on which function it is combined with.

0 : Disabled

- **Acceleration/deceleration Ramp Hold**
The hold value will be reset to 0 Hz when the Stop command is entered or the drive is de-energized. The active frequency reference will be the value the drive uses when it restarts.
- **Up/Down Command**
The frequency reference value will be reset to 0 Hz when the Stop command is entered or the drive is de-energized. The drive will start from 0 Hz when it is restarted.
- **When combined with the Up/Down 2 Command**
The frequency bias is not saved when the Stop command is entered, or 5 s after the Up/Down 2 command has been released. The Up/Down 2 function will start with a bias of 0% when the drive is restarted.

1 : Enabled

- **Acceleration/deceleration Ramp Hold**
The last hold value will be saved when the Run command is cleared or when the drive is de-energized. The drive will use the saved value as the frequency reference when it restarts.

Note:

Make sure to continuously enable multi-function digital input terminal set for *Accel/Decel Ramp Hold [H1-xx = A]* when energizing the drive. If the digital input does not switch ON, the hold value is cleared and reset to 0 Hz.

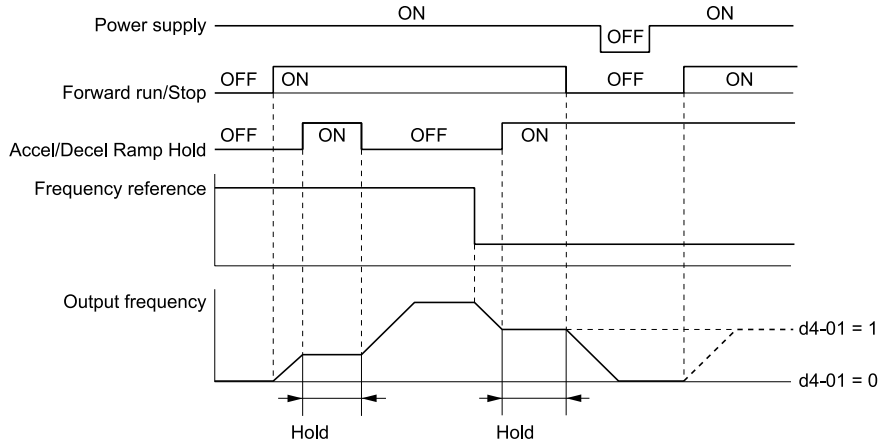

Figure 11.60 Frequency Reference Hold with Accel/Decel Hold Function

- **Up/Down Command**
The frequency reference value will be saved when the Run command is cleared or when the drive is de-energized. The drive will use the saved value as the frequency reference when it restarts.
- **Up/Down 2 Command with Frequency Reference from Keypad**
When a Run command is active and the Up/Down 2 command is released for longer than 5 s, the Up/Down 2 bias value is added to the frequency reference and then reset to 0. The frequency reference value to which the bias value was added is saved in the drive. This new frequency reference will be used to restart the drive after the Run command is cleared or after the drive is de-energized.

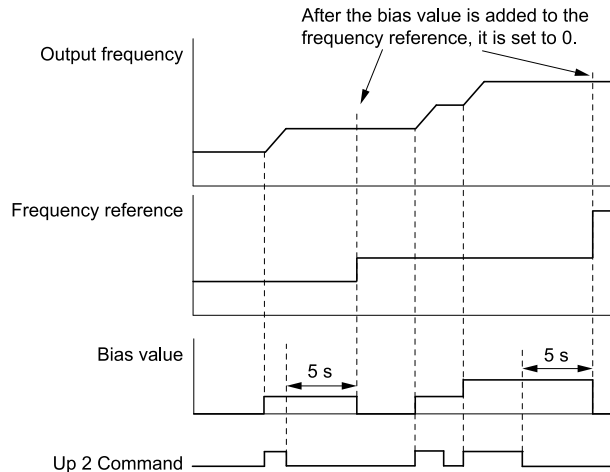

Figure 11.61 Up/Down 2 Example with Reference from Keypad and d4-01 = 1

- **Up/Down 2 Command with Frequency Reference from Input Sources Other Than the Keypad**
When a Run command is active and the Up/Down 2 command is released for longer than 5 s, the bias value will be saved in d4-06 [Frequency Ref Bias (Up/Down 2)]. The frequency reference + d4-06 is saved to the drive as a frequency reference value. This new frequency reference will be used to restart the drive after the Run command is cleared or after the drive is de-energized.

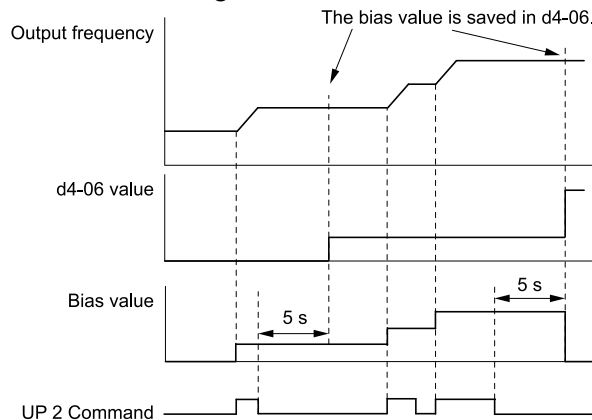

Figure 11.62 Up/Down 2 Example with Other Reference than Keypad and d4-01 = 1

Note:

To use the combination of the frequency reference hold function and the Up/Down 2 function, configure the Up/Down 2 upper limit [d4-08] and lower limit [d4-09] correctly.

Clearing the Saved Freq Reference Value

The way to clear the saved frequency reference value varies depending on which function is combined. Clear the values with any of the following methods.

- Releasing the input programmed for *Accel/Decel Ramp Hold* [H1-xx = A].
- Setting an Up or Down command while no Run command is active.
- Use the Up/Down 2 Command to set d4-06 = 0.0. Or, set d4-06 = 0.0 during stop.

■ **d4-03: Up/Down 2 Bias Level**

No. (Hex.)	Name	Description	Default (Range)
d4-03 (02AA) RUN	Up/Down 2 Bias Level	<div style="display: flex; justify-content: space-between; font-size: small;"> V/f CL-V/f OLV CLV AOLV OLV/PM AOLV/PM CLV/PM EZOLV </div> Sets the bias added to or subtracted from the frequency reference by the Up/Down 2 function.	0.00 Hz (0.00 - 99.99 Hz)

The operation depends on the set value:

• **Setting d4-03 = 0.00 Hz**

While *Up/Down 2 Command* [H1-xx = 75, 76] is ON, the bias value is increased or decreased using the accel/decel times determined by d4-04 [Up/Down 2 Ramp Selection].

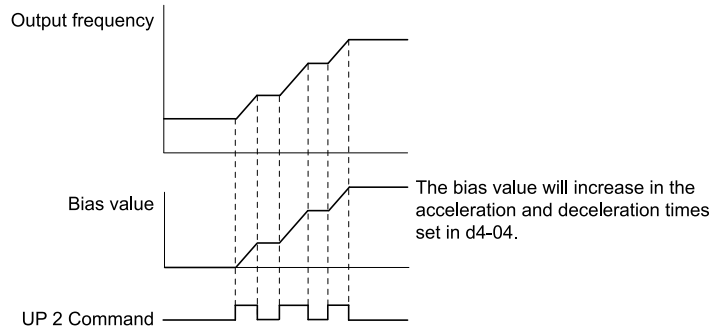

Figure 11.63 Up/Down 2 Bias when d4-03 = 0.00 Hz

• **Setting d4-03 ≠ 0.00 Hz**

Every time *Up/Down 2 Command* [H1-xx = 75, 76] is switched ON, the bias is increased or decreased in steps for the value set in d4-03. When the bias is increased or decreased, the acceleration and deceleration times set in d4-04 are applied.

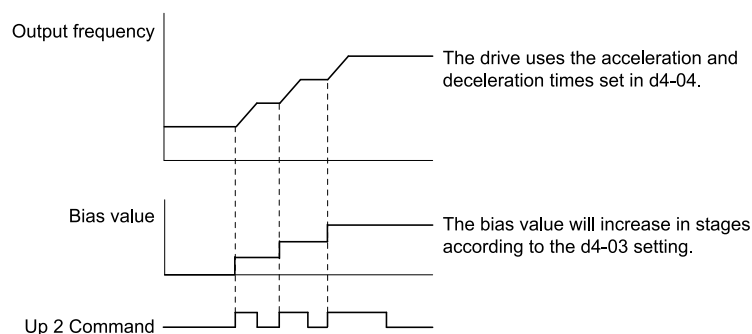

Figure 11.64 Up/Down 2 Bias when d4-03 ≠ 0.00 Hz

■ **d4-04: Up/Down 2 Ramp Selection**

No. (Hex.)	Name	Description	Default (Range)
d4-04 (02AB) RUN	Up/Down 2 Ramp Selection	<div style="display: flex; justify-content: space-between; font-size: small;"> V/f CL-V/f OLV CLV AOLV OLV/PM AOLV/PM CLV/PM EZOLV </div> Selects the acceleration and deceleration times to use when adding or subtracting the bias to/from the frequency reference when using the Up/Down 2 function.	0 (0, 1)

0 : Use selected Accel/Decel time

11.5 d: Reference Settings

Increase or decrease the bias by using the currently active acceleration and deceleration times.

1 : Use Accel/Decel Time 4

Increase or decrease the bias by using *C1-07 [Acceleration Time 4]* and *C1-08 [Deceleration Time 4]*.

■ d4-05: Up/Down 2 Bias Mode Selection

No. (Hex.)	Name	Description	Default (Range)
d4-05 (02AC) RUN	Up/Down 2 Bias Mode Selection	<div style="display: flex; justify-content: space-between; font-size: small;"> V/f CL-V/f OLV CLV AOLV OLV/PM AOLV/PM CLV/PM EZOLV </div> <p>Determines if the bias value is saved to the drive when <i>Up/Down 2 Command [H1-xx = 75, 76]</i> are both released or both enabled. This parameter is effective only when <i>d4-03 [Up/Down 2 Bias Level] = 0.00</i>.</p>	0 (0, 1)

0 : Hold bias @ no Up/Down selected

The bias value is held if both MFDI terminals set for *Up/Down 2 Command [H1-xx = 75, 76]* switch ON or OFF.

1 : 0 bias @ neither/both selected

The bias value is reset to 0 if both MFDI terminals set for *Up/Down 2 Command [H1-xx = 75, 76]* switch ON or OFF. Also, the drive accelerates and decelerates the motor to the selected output frequency using the acceleration and deceleration times set in *d4-04 [Up/Down 2 Ramp Selection]*.

■ d4-06: Frequency Ref Bias (Up/Down 2)

No. (Hex.)	Name	Description	Default Setting (Range)
d4-06 (02AD)	Frequency Ref Bias (Up/Down 2)	<div style="display: flex; justify-content: space-between; font-size: small;"> V/f CL-V/f OLV CLV AOLV OLV/PM AOLV/PM CLV/PM EZOLV </div> <p>Saves the bias value from the <i>Up/Down 2 Command</i> assuming that <i>E1-04 [Maximum Output Frequency]</i> is 100%.</p>	0.0% (-99.9 - +100.0%)

The function of *d4-06* depends on the Up/Down 2 function configuration.

Note:

Parameter *d4-06* is not normally used when a keypad sets the frequency reference.

- When *d4-01 = 0 [Freq Reference Retention Select = Disabled]* and the frequency reference is set by a source other than the keypad, the value set in *d4-06* is added to the frequency reference. If the value set in *d4-06* is a negative number, it is subtracted from the frequency reference.
- When *d4-01 = 1 [Enabled]* and the frequency reference is set by a source other than the keypad, the bias value adjusted with the Up/Down 2 command is stored in *d4-06* when 5 seconds have passed after releasing the Up/Down 2 command. If the value set in *d4-06* is added to or subtracted from the frequency reference.

Conditions that Reset or Disable d4-06

The bias value is reset and disabled in the following cases.

- *d4-01 = 0* was set and the Run command was cleared.
- *H1-xx = 75, 76 [MFDI Function Select = Up/Down 2 Command]* is not set.
- The frequency reference source has been changed.
This includes the switching of LOCAL/REMOTE and multi-step speed reference.
- The frequency reference value has been changed via the digital input.
- *d4-03 [Up/Down 2 Bias Level] = 0* and *d4-05 = 1 [Up/Down 2 Bias Mode Selection = 0 bias @ neither/both selected]* are set, and both MFDI terminals set for *Up/Down 2 Command [H1-xx = 75/76]* are ON or OFF.
- The value of *E1-04 [Maximum Output Frequency]* has been changed.

■ d4-07: Analog Freq Ref Fluctuate Limit

No. (Hex.)	Name	Description	Default (Range)
d4-07 (02AE) RUN	Analog Freq Ref Fluctuate Limit	<div style="display: flex; justify-content: space-between; font-size: small;"> V/f CL-V/f OLV CLV AOLV OLV/PM AOLV/PM CLV/PM EZOLV </div> <p>If the frequency reference changes for more than the level set to this parameter, then the bias value will be held. Parameter <i>E1-04 [Maximum Output Frequency]</i> is 100%.</p>	1.0% (0.1 - 100.0%)

Handles frequency reference changes while *Up/Down 2 Command [H1-xx = 75, 76]* is ON. If the frequency reference changes for more than the level set in *d4-07*, then the bias value will be held, and the drive will accelerate or decelerate following the frequency reference. When the frequency reference is reached, the bias hold is released and the bias follows the Up/Down 2 input commands.

Parameter *d4-07* is applicable only if the frequency reference is set by an analog or pulse input.

■ d4-08: Up/Down 2 Bias Upper Limit

No. (Hex.)	Name	Description	Default (Range)
d4-08 (02AF) RUN	Up/Down 2 Bias Upper Limit	V/f CL-V/f OLV CLV AOLV OLV/PM AOLV/PM CLV/PM EZOLV Sets the upper limit of the Up/Down 2 bias as a percentage of <i>E1-04</i> [Maximum Output Frequency].	100.0% (0.0 - 100.0%)

The set bias upper limit is saved in *d4-06* [Frequency Ref Bias (Up/Down 2)]. Set *d4-08* to an appropriate value before using the Up/Down 2 function.

Note:

When *d4-01* = 1 [Freq Reference Retention Select = Enabled] and *b1-01* = 0 [Frequency Reference Selection 1 = Keypad], the bias value will be added to the frequency reference if no Up/Down 2 command is received for 5 s, and will be reset to 0 afterwards. From that point, the bias can be increased up to the limit set in *d4-08* again.

■ d4-09: Up/Down 2 Bias Lower limit

No. (Hex.)	Name	Description	Default (Range)
d4-09 (02B0) RUN	Up/Down 2 Bias Lower limit	V/f CL-V/f OLV CLV AOLV OLV/PM AOLV/PM CLV/PM EZOLV Sets the lower limit of the Up/Down 2 bias as a percentage of <i>E1-04</i> [Maximum Output Frequency].	0.0% (-99.9 - 0.0%)

The set bias lower limit is saved in *d4-06* [Frequency Ref Bias (Up/Down 2)]. Set *d4-09* to an appropriate value before using the Up/Down 2 function.

Note:

When *d4-01* = 1 [Freq Reference Retention Select = Enabled] and *b1-01* = 0 [Frequency Reference Selection 1 = Keypad], the bias value will be added to the frequency reference if no Up/Down 2 command is received for 5 s. Then, the bias value will be reset to 0.

If the bias is increased using the Up 2 command, the frequency reference cannot be reduced with a Down 2 command when *d4-09* = 0. Set a negative lower limit in *d4-09* to allow speed reduction in this situation.

■ d4-10: Up/Down Freq Lower Limit Select

No. (Hex.)	Name	Description	Default Setting (Range)
d4-10 (02B6)	Up/Down Freq Lower Limit Select	V/f CL-V/f OLV CLV AOLV OLV/PM AOLV/PM CLV/PM EZOLV Selects how the lower frequency limit is set when using the Up/Down function.	0 (0, 1)

0 : d2-02 or Analog (larger level)

The higher value between *d2-02* [Frequency Reference Lower Limit] and an analog input programmed for Frequency Bias [*H3-02*, *H3-06*, *H3-10* = 0] determines the lower frequency reference limit.

Note:

When using External Reference 1/2 Selection [*H1-xx* = 2] to switch between the Up/Down function and an analog input as the reference source, the analog value becomes the lower reference limit when the Up/Down command is active. Set *d4-10* = 1 to make the Up/Down function independent of the analog input value.

1 : d2-02

The lower limit of the frequency reference can only be set with *d2-02*.

◆ d5: Torque Control

d5 parameters set the Torque Control function.

Torque Control is a function that controls the output torque of the motor. Torque Control can be used for roller drives, winders, unwinders, conveyors and other machinery that utilizes tension control and push/pull applications. When the machine side is offloaded suddenly when material runs out, Torque Control is used in conjunction with the speed limit function to keep the rotation speed of the motor from climbing.

Torque Control can be used when *A1-02* [Control Method Selection] is set to any of the following.

- 3 [Closed Loop Vector Control]
- 4 [Advanced OpenLoop Vector Control]

- 6 [PM Advanced Open Loop Vector]
- 7 [PM Closed Loop Vector Control]

To enable Torque Control, use any of the following methods.

- Set $d5-01 = 1$ [Torque Control Selection = Torque Control].
- Set $H1-xx = 71$ [Speed/Torque Control Switch] ON.

■ Torque Control Operation

The following diagram illustrates the working principle.

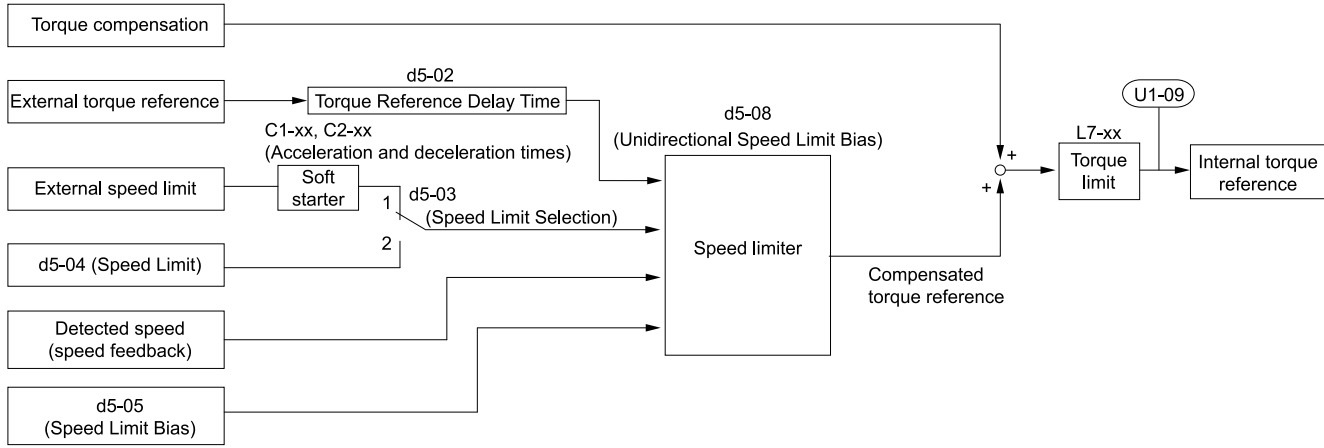

Figure 11.65 Torque Control Block Diagram

The externally input torque reference is the target value for the motor output torque. If the motor output torque and load torque are unbalanced during Torque Control, the motor accelerates or decelerates. To prevent operation beyond the speed limit, compensate the external torque reference value if the motor speed reaches the limit. The compensation value is calculated using the speed limit, speed feedback, and the speed limit bias.

If an external torque compensation value is input, it is added to the speed limit compensated torque reference value. The value calculated is limited by the settings of $L7-01$ through $L7-04$ [Torque Limit], and is then used as the internal torque reference. The torque reference calculated can be monitored using $U1-09$ [Torque Reference]. Since the torque limit values set in $L7-01$ to $L7-04$ have the top priority, the motor cannot run at a torque output higher than values set in $L7-01$ to $L7-04$ even if a higher external torque reference is set from an external source.

■ Setting the Torque Reference, Speed Limit, and Torque Compensation Values

Torque Control Input Value Selection

The following table lists the setting method for torque control input signals.

Configuration Parameter	Input methods for the signal	Parameter Settings	Notes
Torque Reference	Drive analog input terminals A1, A2, A3	<i>H3-02, H3-10, H3-06 = 13 [MFAI Function Select= Torque Reference / Torque Limit] *1</i>	The level of the set input signal should match the polarity of the external signals.
	Analog reference option cards AI-A3	<ul style="list-style-type: none"> <i>F2-01 = 0 [Analog Input Function Selection = 3 channel individual]</i> <i>H3-02, H3-10, and H3-06 = 13 *1</i> 	<i>H3-02, H3-10, or H3-06</i> settings are enabled for the option card input terminal. The level of the set input signal should match the polarity of the external signals.
	MEMOBUS register 0004H	<ul style="list-style-type: none"> <i>b1-01 = 2 [Frequency Reference Selection 1 = Memobus/Modbus Communications]</i> If register bit 2 of 000FH is set to 1, the torque reference and torque limit from register 0004H is enabled. 	-
	Communication option card	<ul style="list-style-type: none"> <i>b1-01 = 3 [Option PCB]</i> <i>F6-06 = 1 [Torque Reference/Limit by Comm = Enabled]</i> For details of the torque reference setting, refer to the manual of each communication option card.	-
Speed Limit	Frequency Reference Selection (Reference source selected with b1-01)	<i>d5-03 = 1 [Speed Limit Selection = Active frequency reference]</i> The speed limit is taken from the input selected as frequency reference source in <i>b1-01</i> or <i>b1-15 [Frequency Reference Selection 2]</i> . *1	The settings in <i>C1-01 to C1-08 [Acceleration/Deceleration Times]</i> and <i>C2-01 to C2-04 [S-Curve Time @ start/end of Accel/Decel]</i> are applied to the speed limit.
	d5-04 [Speed Limit]	<i>d5-03 = 2 [d5-04 setting]</i>	-
Torque Compensation	Drive analog input terminals A1, A2, A3	<i>H3-02, H3-10, or H3-06 = 14 [Torque Compensation] *1</i>	The level of the set input signal should match the polarity of the external signals.
	Analog reference option cards AI-A3	<ul style="list-style-type: none"> <i>F2-01 = 0</i> <i>H3-02, H3-10, or H3-06 = 14 *1</i> 	<i>H3-02, H3-10, or H3-06</i> settings are enabled for the option card input terminal. The level of the set input signal should match the polarity of the external signals.
	MEMOBUS register 0005H	<ul style="list-style-type: none"> <i>b1-01 = 2</i> If register bit 3 of 000FH is set to 1, the torque compensation from register 0005H is enabled. 	-
	Communication option card	<i>b1-01 = 3 [Option PCB]</i> Refer to the option card manual for details about setting the torque compensation.	-

*1 Sets analog input terminals A1, A2, and A3 to supply the speed limit, torque reference, or torque compensation. Setting the same function in A1 to A3 terminals using *H3-02, H3-10, or H3-06* will trigger operation error *oPE07 [MF Analog Input Selection Error]*.

Input Signal Polarity

The direction of motor rotation is determined by the positive and negative torque references that were input, but not determined by the direction of the Run command (forward/reverse). The internal torque reference depends on the positive and negative torque reference signal, and the direction of the Run command.

Table 11.34 Torque Control Signal Polarity

Run command direction	Torque reference signal polarity	Direction of motor rotation	Polarity of the internal torque reference [U1-09]
Forward run	+ (Positive)	Forward direction	+ (Positive)
	- (Negative)	Reverse direction	- (Negative)
Reverse run	+ (Positive)	Reverse direction	- (Negative)
	- (Negative)	Forward direction	+ (Positive)

11.5 d: Reference Settings

Note:

For Yaskawa motors, the forward run direction is the counter clockwise direction when viewed from the load shaft.

When using analog inputs, negative input values can be generated by:

- applying negative voltage input signals.
- using positive voltage input signals while setting the analog input bias to negative values.
- applying positive voltage input signals and using a digital input that is programmed for $H1-xx = 78$ [MFDI Function Select = Ex.Torque Ref Polarity Inversion].

When using MEMOBUS/Modbus communication or a communication option card, set the positive or negative signed torque reference.

When the level of the analog signal input is 0 V to 10 V, or 4 mA to 20 mA, the torque reference is the forward direction. To input a reverse direction for torque reference, use either of the following.

- Use a -10 V to 10 V voltage input
- Switch the polarity of the torque reference by setting the $H1-xx=78$ [MFDI Function Select = Ex.Torque Ref Polarity Inversion].

■ Speed Limit and Speed Limit Bias

The speed limit setting is read from the input selected in $d5-03$ [Speed Limit Selection]. A bias can be added to this speed limit using $d5-05$ [Speed Limit Bias]. Parameter $d5-08$ [Unidirectional Speed Limit Bias] determines how bias is applied to the speed limit.

The following table explains the relation between these settings.

Table 11.35 Speed Limit, Speed Bias and Speed Limit Priority Selection

Run command	Operating Conditions							
	Forward	Reverse	Forward	Reverse	Forward	Reverse	Forward	Reverse
Torque reference direction	+ (Positive)	+ (Positive)	- (Negative)	- (Negative)	- (Negative)	- (Negative)	+ (Positive)	+ (Positive)
Speed limit direction	+ (Positive)	- (Negative)	- (Negative)	+ (Positive)	+ (Positive)	- (Negative)	- (Negative)	+ (Positive)
Direction of motor rotation	Forward		Reverse		Forward		Reverse	
Generated torque (d5-08 = 0 [Disabled]) */								
Generated torque (d5-08 = 1 [Enabled]) */								
Application example	Wind up				Rewind			

*1 The Δn value is determined by the $C5$ parameter setting.

■ Indicating Operation at the Speed Limit

When the motor is within or exceeds the speed limit, the drive outputs a signal to the PLC or other such control devices and lets the user know that an error has occurred. Set any MFDO function selections [H2-01 to H2-04] to 32 [During Spd Limit inTorqueControl] to enable this function.

■ Switching Between Torque and Speed Control

Use a digital input to switch Torque Control and Speed Control. Set H1-xx = 71 [MFDI Function Select = Speed/Torque Control Switch] to enable this function.

When switching from Speed Control to Torque Control, the torque limit becomes the torque reference and the speed reference becomes the speed limit. When switching from Torque Control to Speed Control, the torque reference becomes the torque limit and the speed limit becomes the speed reference. When the application of delay time becomes necessary for switching between Speed Control and Torque Control, set d5-06 [Speed/Torque Changeover Time]. The reference value of the Torque Control and Speed Control when the switchover signal was input are maintained during this switch delay time. Change the reference values from an external control device within this delay time.

Note:

- Set d5-01 = 0 [Torque Control Selection = Speed Control] when switching between Torque Control and Speed Control. An oPE15 [Torque Control Setting Error] will be triggered if d5-01 = 1 [Torque Control] is set while H1-xx = 71 is set at the same time.
- If the Stop command is input, the delay time set in d5-06 will not be applied. In this case, Torque Control will immediately switch to Speed Control and ramp to stop.

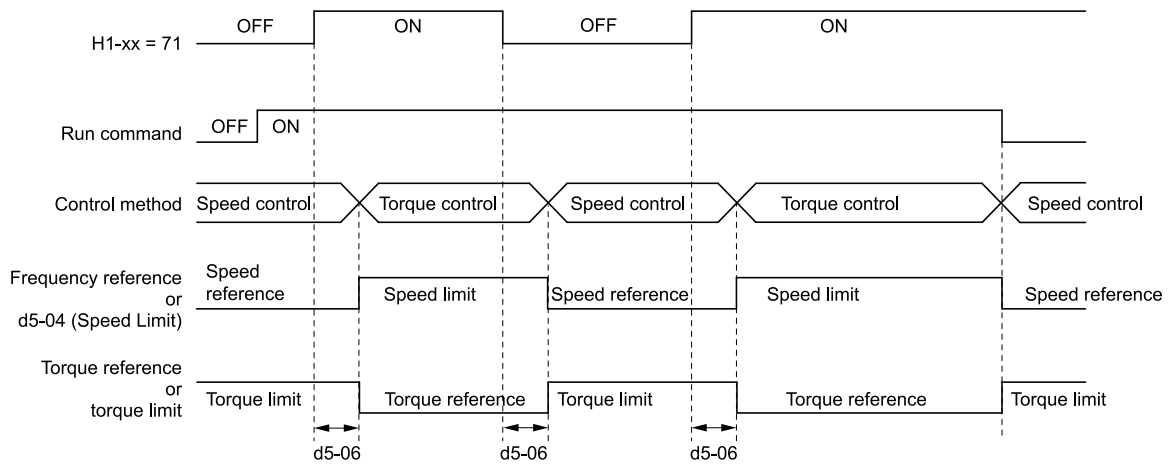

Figure 11.66 Speed/Torque Control Switching Time

■ d5-01: Torque Control Selection

No. (Hex.)	Name	Description	Default (Range)
d5-01 (029A)	Torque Control Selection	V/f CL-V/f OLV CLV AOLV OLV/PM AOLV/PM CLV/PM EZOLV Enables/disables Torque Control.	0 (0, 1)

0 : Speed Control

Speed Control is enabled. The drive controls the speed according to C5-01 to C5-07 [Speed Control (ASR) Setting Parameters].

Also use this setting when switching the Speed Control and Torque Control by setting H1-xx = 71 [MFDI Function Select = Speed/Torque Control Switch].

1 : Torque Control

Torque Control is always enabled.

■ d5-02: Torque Reference Delay Time

No. (Hex.)	Name	Description	Default (Range)
d5-02 (029B)	Torque Reference Delay Time	V/f CL-V/f OLV CLV AOLV OLV/PM AOLV/PM CLV/PM EZOLV Sets the primary delay time constant for the torque reference filter.	Determined by A1-02 (0 - 1000 ms)

11.5 d: Reference Settings

Eliminates oscillation resulting from an unstable torque reference signal by applying a primary delay filter to the torque reference signal. It is effective when removing noise from the torque reference signal, and when adjusting the responsiveness between host controllers.

Increase the setting value when oscillation occurs during Torque Control. However, if the setting value is too high, responsiveness becomes poor.

■ d5-03: Speed Limit Selection

No. (Hex.)	Name	Description	Default Setting (Range)
d5-03 (029C)	Speed Limit Selection	<div style="display: flex; justify-content: space-between; font-size: 0.8em;"> V/f CL-V/f OLV CLV AOLV OLV/PM AOLV/PM CLV/PM EZOLV </div> <p>Selects the speed limit method associated with torque control.</p>	1 (1, 2)

1 : Active frequency reference

The enabled frequency reference set in *b1-01* [Frequency Reference Selection 1] or *b1-15* [Frequency Reference Selection 2] will be the speed limit. Values set in *C1-01* to *C1-08* [Acceleration/Deceleration Times 1 - 4] and *C2-01* to *C2-04* [S-Curve Time @ start/end of Accel] are applied as speed limits.

2 : d5-04 setting

The speed limit is the value set in *d5-04*.

■ d5-04: Speed Limit

No. (Hex.)	Name	Description	Default Setting (Range)
d5-04 (029D)	Speed Limit	<div style="display: flex; justify-content: space-between; font-size: 0.8em;"> V/f CL-V/f OLV CLV AOLV OLV/PM AOLV/PM CLV/PM EZOLV </div> <p>Sets the speed limit during Torque Control as a percentage of the Maximum Output Frequency. This parameter is effective when <i>d5-03</i> = 2 [Speed Limit Selection = <i>d5-04</i> setting].</p>	0% (-120 - +120%)

The speed limit is + setting when it is in the same direction as the Run command. The speed limit is - setting when it is in the opposite direction as the Run command.

■ d5-05: Speed Limit Bias

No. (Hex.)	Name	Description	Default (Range)
d5-05 (029E)	Speed Limit Bias	<div style="display: flex; justify-content: space-between; font-size: 0.8em;"> V/f CL-V/f OLV CLV AOLV OLV/PM AOLV/PM CLV/PM EZOLV </div> <p>Sets a bias to the speed limit value as a percentage of E1-04 [Maximum Output Frequency].</p>	10% (0 - 120%)

Used to adjust the margin for the speed limit.

■ d5-06: Speed/Torque Changeover Time

No. (Hex.)	Name	Description	Default (Range)
d5-06 (029F)	Speed/Torque Changeover Time	<div style="display: flex; justify-content: space-between; font-size: 0.8em;"> V/f CL-V/f OLV CLV AOLV OLV/PM AOLV/PM CLV/PM EZOLV </div> <p>Sets the delay time for switching between Speed Control and Torque Control using the multi-function digital input terminal. This parameter is effective when <i>H1-xx</i> = 71 [MFDI Function Select = Speed/Torque Control Switch] has been set.</p>	0 ms (0 - 1000 ms)

The analog input (torque reference, speed limit value) holds at the value present at the time of Speed/Torque Control switchover within the time of the Speed/Torque Changeover Timer. During this time, complete the preparations for switchover with an external source.

■ d5-08: Unidirectional Speed Limit Bias

No. (Hex.)	Name	Description	Default (Range)
d5-08 (02B5)	Unidirectional Speed Limit Bias	<div style="display: flex; justify-content: space-between; font-size: 0.8em;"> V/f CL-V/f OLV CLV AOLV OLV/PM AOLV/PM CLV/PM EZOLV </div> <p>Selects the direction of the speed limit reference to which <i>Speed Limit Bias</i> [d5-05] applies.</p>	1 (0, 1)

0 : Disabled

The speed limit bias is applied in the speed limit direction and the opposite direction.

1 : Enabled

The speed limit bias is applied in the opposite direction of the speed limit only.

◆ d6: Field Weakening and Field Forcing

d6 parameters set the field weakening and field forcing functions.

The field weakening function is used to reduce the energy consumption of the motor. It reduces the output voltage of the drive to a predefined level. The function reduces the motor excitation current inversely proportional to speed in a constant output range, and works so that the induced voltage of the motor does not exceed the power supply voltage. Set $H1-xx = 63$ [*Field weakening*] ON to enable this function.

Note:

Use the Field Weakening function in constant light-load applications. To control the energy consumption of the motor under other load conditions, use the *b8 parameters* [*Energy Saving*].

The Field Forcing function compensates the delaying influence of the motor time constant when changing the excitation current reference and improves motor responsiveness. The function improves the development of the actual motor excitation current by using a high motor excitation current reference for drive stat-up only. Consequently, if the Field Forcing function is enabled, motor responsiveness will be better.

Note:

Field Forcing is ineffective during DC Injection Braking.

■ d6-01: Field Weakening Level

No. (Hex.)	Name	Description	Default (Range)
d6-01 (02A0)	Field Weakening Level	<div style="display: flex; gap: 5px;"> V/f CL-V/f OLV CLV AOLV OLV/PM AOLV/PM CLV/PM EZOLV </div> Sets the output voltage of the drive when the <i>Field weakening</i> [$H1-xx = 63$] is input as a percentage of the maximum output voltage.	80% (0 - 100%)

■ d6-02: Field Weakening Frequency Limit

No. (Hex.)	Name	Description	Default (Range)
d6-02 (02A1)	Field Weakening Frequency Limit	<div style="display: flex; gap: 5px;"> V/f CL-V/f OLV CLV AOLV OLV/PM AOLV/PM CLV/PM EZOLV </div> Sets the minimum output frequency at which field weakening can be activated.	0.0 Hz (0.0 - 590.0 Hz)

The field weakening command is enabled when the following conditions are both fulfilled.

- The output frequency is higher than or equal to the value set in *d6-02*.
- The speed agreement status is present.

■ d6-03: Field Forcing Selection

No. (Hex.)	Name	Description	Default Setting (Range)
d6-03 (02A2)	Field Forcing Selection	<div style="display: flex; gap: 5px;"> V/f CL-V/f OLV CLV AOLV OLV/PM AOLV/PM CLV/PM EZOLV </div> Enables or disables the field forcing function.	0 (0, 1)

0 : Disabled**1 : Enabled**

■ d6-06: Field Forcing Limit

No. (Hex.)	Name	Description	Default (Range)
d6-06 (02A5)	Field Forcing Limit	<div style="display: flex; gap: 5px;"> V/f CL-V/f OLV CLV AOLV OLV/PM AOLV/PM CLV/PM EZOLV </div> Sets the maximum level at which the Field Forcing function can boost the excitation current reference as a percentage of the motor no load current. Normally there is no need to change this setting.	400% (100 - 400%)

Note:

The field forcing function is disabled for DC Injection Braking.

◆ **d7: Offset Frequency**

Adds or subtracts the set frequency (Offset frequency) to/from the frequency reference using 3 digital signal inputs, and corrects the speed. Selects the Offset frequency using the terminal set in $H1-xx = 44$ to 46 [MFDI Function Select = Offset frequency 1 to 3]. The selected offset values are added together if multiple inputs are closed simultaneously.

The following diagram illustrates the Offset frequency function.

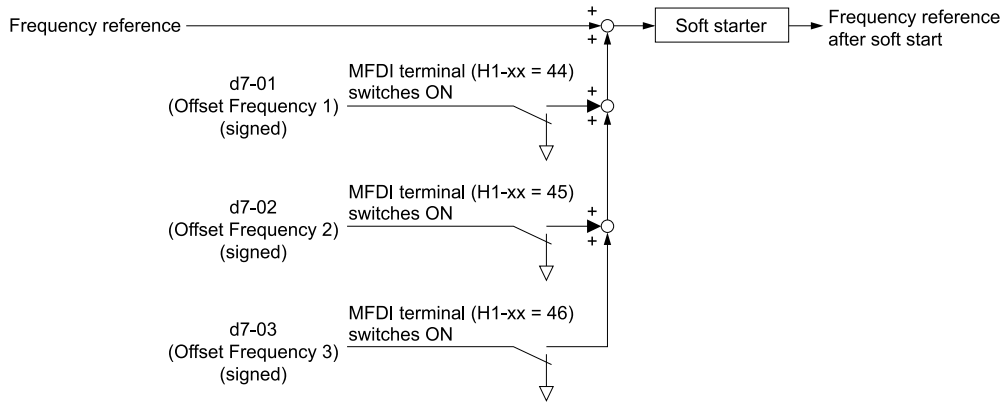

Figure 11.67 Offset Frequency Operation

■ **d7-01: Offset Frequency 1**

No. (Hex.)	Name	Description	Default (Range)
d7-01 (02B2) RUN	Offset Frequency 1	<p>V/f CL-V/f OLV CLV AOLV OLV/PM AOLV/PM CLV/PM EZOLV</p> <p>Adds or subtracts the set frequency to/from the frequency reference using $H1-xx = 44$ [MFDI Function Select = Offset frequency 1] as a percentage of the maximum output frequency.</p>	0.0% (-100.0 - +100.0%)

■ **d7-02: Offset Frequency 2**

No. (Hex.)	Name	Description	Default Setting (Range)
d7-02 (02B3) RUN	Offset Frequency 2	<p>V/f CL-V/f OLV CLV AOLV OLV/PM AOLV/PM CLV/PM EZOLV</p> <p>Adds or subtracts the set frequency to/from the frequency reference using $H1-xx = 45$ [MFDI Function Select = Offset frequency 2] as a percentage of the maximum output frequency.</p>	0.0% (-100.0 - +100.0%)

■ **d7-03: Offset Frequency 3**

No. (Hex.)	Name	Description	Default Setting (Range)
d7-03 (02B4) RUN	Offset Frequency 3	<p>V/f CL-V/f OLV CLV AOLV OLV/PM AOLV/PM CLV/PM EZOLV</p> <p>Adds or subtracts the set frequency to/from the frequency reference using $H1-xx = 46$ [MFDI Function Select = Offset frequency 3] as a percentage of the maximum output frequency.</p>	0.0% (-100.0 - +100.0%)

11.6 E: Motor Parameters

E parameters cover drive input voltage, V/f pattern, and motor parameters.

◆ E1: V/f Pattern for Motor 1

E1 parameters are used to set the drive input voltage and motor V/f characteristics. To switch drive operation from one motor to another motor, set the V/f characteristics for motor 1.

■ V/f Pattern Settings

The drive uses a V/f pattern to adjust the output voltage relative to the frequency reference.

This product has been preconfigured with 15 voltage/frequency (V/f) patterns. Use *E1-03 [V/f Pattern Selection]* to select the V/f pattern that is appropriate for the application.

Additionally, one custom V/f pattern is available. Set *E1-03 = F [Custom]* and then manually set parameters *E1-04 through E1-10*.

Table 11.36 Predefined V/f Patterns

Setting	Specification	Characteristic	Application
0	Constant Trq_50Hz base_50Hz max	Constant torque	For general purpose applications. This pattern is used when the load torque is constant without any rotation speed such as that used for linear conveyor systems.
1	Constant Trq_60Hz base_60Hz max		
2	Constant Trq_50Hz base_60Hz max		
3	Constant Trq_60Hz base_72Hz max		
4	Variable Trq_50Hz base_35% mid V	Variable torque	This pattern is used for torque loads proportional to 2 or 3 times the rotation speed, such as is the case with fans and pumps.
5	Variable Trq_50Hz base_50% mid V		
6	Variable Trq_60Hz base_35% mid V		
7	Variable Trq_60Hz base_50% mid V		
8	High Start Trq_50Hz base_125% V	High starting torque	This pattern is used when strong torque is required during startup.
9	High Start Trq_50Hz base_165% V		
A	High Start Trq_60Hz base_125% V		
B	High Start Trq_60Hz base_165% V		
C	High Freq_60Hz base_90Hz max	Constant output	This pattern is used to rotate motors at greater than 60 Hz. Output voltage is constant when operating at greater than 60 Hz.
D	High Freq_60Hz base_120Hz max		
E	High Freq_60Hz base_180Hz max		
F	Custom	Constant torque	Enables a custom V/f pattern by changing <i>E1-04 through E1-13 [V/f Pattern for Motor 1]</i> . The default settings for <i>E1-04 through E1-13</i> are equivalent to <i>Setting Value 1 [Constant Trq_60Hz base_60Hz max]</i> .

Note:

Be aware of the following points when manually setting V/f patterns.

- To set linear V/f characteristics at frequencies lower than that of E1-06, set E-07 = E1-09. In this case, the setting for E1-08 will be disregarded.
- Ensure that the five frequencies are set according to the following rules to prevent triggering oPE10 [V/f Data Setting Error];
 $E1-09 \leq E1-07 < E1-06 \leq E1-11 \leq E1-04$
- Setting E1-11 = 0 [Mid Point B Frequency = 0 Hz] disables E1-12 [Mid Point B Voltage]. Ensure that the four frequencies are set according to the following rules;
 $E1-09 \leq E1-07 < E1-06 \leq E1-04$
- Parameter E1-03 is not reset when the drive is initialized using A1-03.

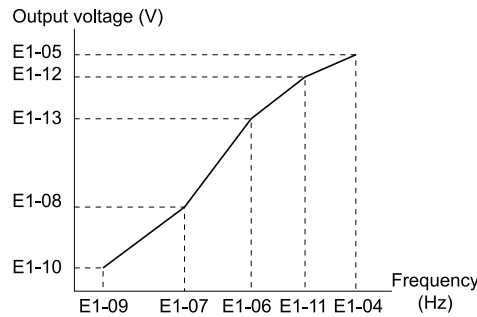

Figure 11.68 V/f Pattern

■ **E1-01: Input AC Supply Voltage**

No. (Hex.)	Name	Description	Default (Range)
E1-01 (0300)	Input AC Supply Voltage	V/f CL-V/f OLV CLV AOLV OLV/PM AOLV/PM CLV/PM EZOLV Sets the drive input voltage. Set this parameter to the nominal voltage of the AC power supply.	200 V Class: 200 V, 400 V: 400 V (200 V Class: 155 to 255 V, 400 V Class: 310 to 510 V)

NOTICE: Set parameter E1-01 [Input AC Supply Voltage] to match the input voltage of the drive. Drive input voltage (not motor voltage) must be set in E1-01 for the protective features to function properly. Failure to set the correct drive input voltage will result in improper drive operation.

Values Related to the Drive Input Voltage

The value set in E1-01 is the base value used for the motor protective functions listed in the following table. The detection level changes for some motor protective functions when using a 400 V class drive.

Voltage	E1-01 Setting	Approximate Values				
		ov Detection Level	BTR Operation Level (rr Detection Level) *1	L2-05 [Undervoltage Detect Level (Uv1)]	L2-11 [DC Bus Vol Setpoint during KEB]	L3-17 [DC Bus Reg Level]
200 V class	All settings	410 V	394 V	190 V	260 V	375 V
400 V class	Setting value ≥ 400 V	820 V	788 V	380 V	500 V	750 V
	Setting value < 400 V	820 V	788 V	350 V	460 V	750 V

*1 This is the protection function enabled in drives with a built-in braking transistor. Figures indicate the level that triggers the built-in braking transistor. Refer to “YASKAWA AC Drive 72060001 Series Option Braking Unit and Braking Resistor Unit Installation Manual (TOBPC72060001).”

■ **E1-03: V/f Pattern Selection**

No. (Hex.)	Name	Description	Default (Range)
E1-03 (0302)	V/f Pattern Selection	V/f CL-V/f OLV CLV AOLV OLV/PM AOLV/PM CLV/PM EZOLV Selects the V/f pattern for the drive and motor from 15 predefined patterns (settings: 0 through E) or creates a custom V/f pattern(setting: F).	F (Determined by A1-02)

Note:

- Setting 0 through E cannot be selected when $AI-02 = 2$ [Control Method Selection = Open Loop Vector Control].
- Select the appropriate V/f pattern in accordance with the application and usage environment. Setting an improper V/f pattern may result in low motor torque or increased current due to overexcitation.
- The setting value for $EI-03$ is not initialized by the initialize parameter [$AI-03$].

0 : Constant Trq_50Hz base_50Hz max

For general purpose applications. This pattern is used when the load torque is constant without any rotation speed such as that used for linear conveyor systems.

Note:

The voltage values in the figure represent those when using 200 V class drives. Double the values for 400 V class drives.

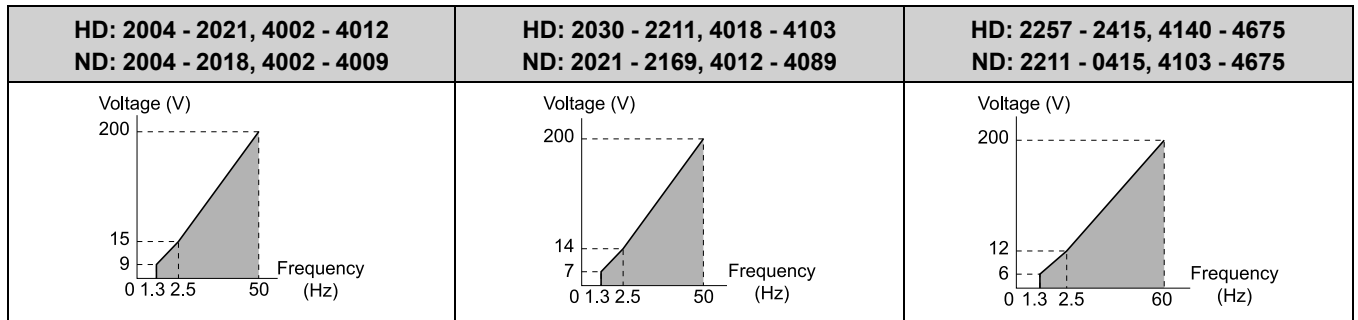

1 : Constant Trq_60Hz base_60Hz max

For general purpose applications. This pattern is used when the load torque is constant without any rotation speed such as that used for linear conveyor systems.

Note:

The voltage values in the figure represent those when using 200 V class drives. Double the values for 400 V class drives.

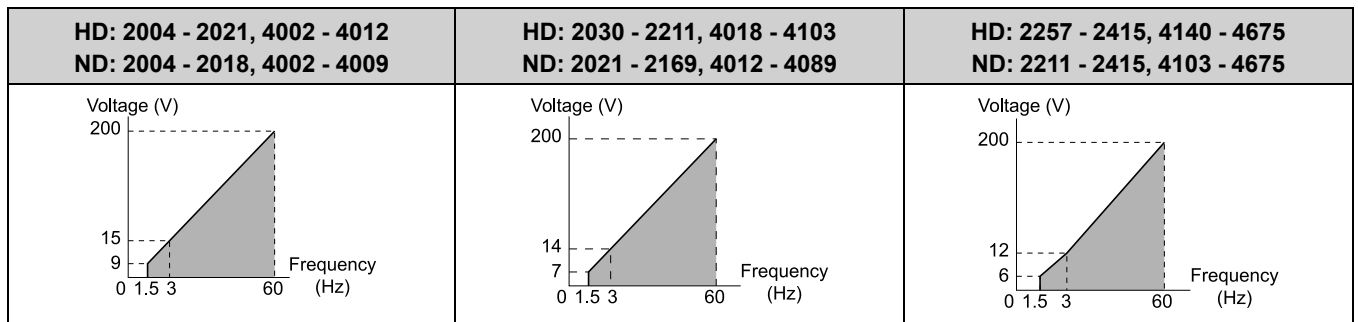

2 : Constant Trq_50Hz base_60Hz max

For general purpose applications. This pattern is used when the load torque is constant without any rotation speed such as that used for linear conveyor systems.

Note:

The voltage values in the figure represent those when using 200 V class drives. Double the values for 400 V class drives.

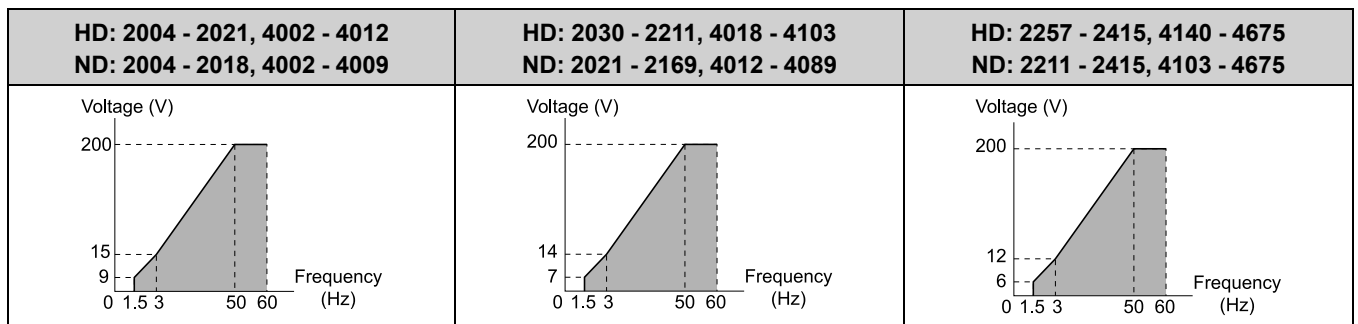

3 : Constant Trq_60Hz base_72Hz max

For general purpose applications. This pattern is used when the load torque is constant without any rotation speed such as that used for linear conveyor systems.

11.6 E: Motor Parameters

Note:

The voltage values in the figure represent those when using 200 V class drives. Double the values for 400 V class drives.

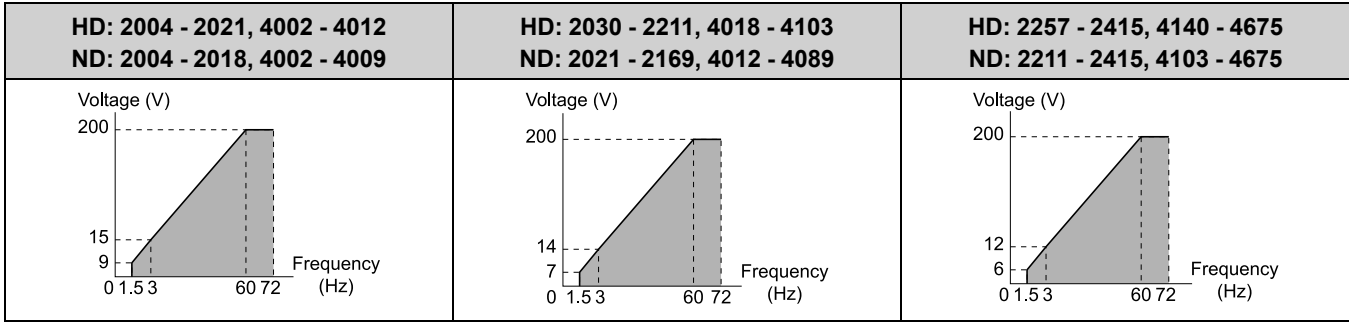

4 : Variable Trq_50Hz base_35% mid V

This derated torque characteristics pattern is used for torque loads proportional to three times the rotation speed, such as is the case with fans and pumps.

Note:

The voltage values in the figure represent those when using 200 V class drives. Double the values for 400 V class drives.

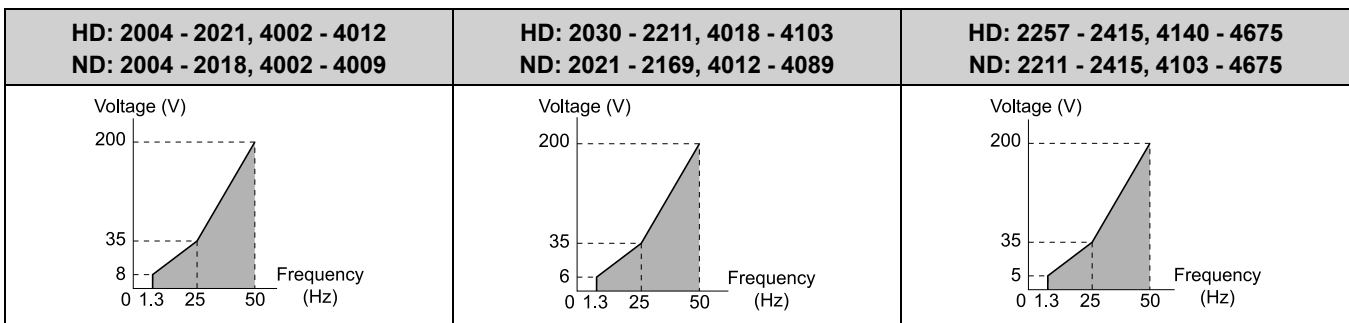

5 : Variable Trq_50Hz base_50% mid V

This derated torque characteristics pattern is used for torque loads proportional to two times the rotation speed, such as is the case with fans and pumps.

Note:

The voltage values in the figure represent those when using 200 V class drives. Double the values for 400 V class drives.

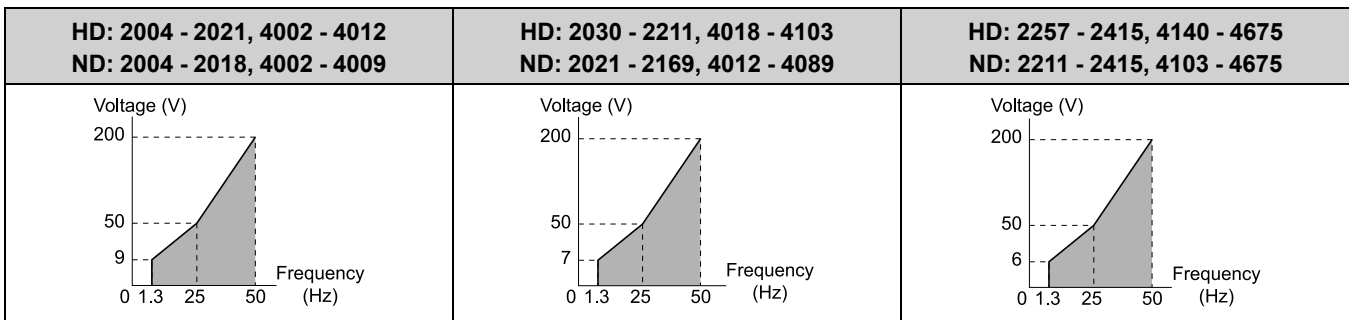

6 : Variable Trq_60Hz base_35% mid V

This derated torque characteristics pattern is used for torque loads proportional to three times the rotation speed, such as is the case with fans and pumps.

Note:

The voltage values in the figure represent those when using 200 V class drives. Double the values for 400 V class drives.

HD: 2004 - 2021, 4002 - 4012 ND: 2004 - 2018, 4002 - 4009	HD: 2030 - 2211, 4018 - 4103 ND: 2021 - 2169, 4012 - 4089	HD: 2257 - 2415, 4140 - 4675 ND: 2211 - 2415, 4103 - 4675

7 : Variable Trq_60Hz base_50% mid V

This derated torque characteristics pattern is used for torque loads proportional to two times the rotation speed, such as is the case with fans and pumps.

Note:

The voltage values in the figure represent those when using 200 V class drives. Double the values for 400 V class drives.

HD: 2004 - 2021, 4002 - 4012 ND: 2004 - 2018, 4002 - 4009	HD: 2030 - 2211, 4018 - 4103 ND: 2021 - 2169, 4012 - 4089	HD: 2257 - 2415, 4140 - 4675 ND: 2211 - 2415, 4103 - 4675

8 : High Start Trq_50Hz base_125% V

This pattern is used when moderate torque is required during startup.

Select this pattern only in the following circumstances.

- Wiring distance between the drive and motor is at least 150 m.
- An AC reactor is connected to the drive output.

Note:

The voltage values in the figure represent those when using 200 V class drives. Double the values for 400 V class drives.

HD: 2004 - 2021, 4002 - 4012 ND: 2004 - 2018, 4002 - 4009	HD: 2030 - 2211, 4018 - 4103 ND: 2021 - 2169, 4012 - 4089	HD: 2257 - 2415, 4140 - 4675 ND: 2211 - 2415, 4103 - 4675

9 : High Start Trq_50Hz base_165% V

This pattern is used when strong torque is required during startup.

Select this pattern only in the following circumstances.

- Wiring distance between the drive and motor is at least 150 m.
- An AC reactor is connected to the drive output.

Note:

The voltage values in the figure represent those when using 200 V class drives. Double the values for 400 V class drives.

11.6 E: Motor Parameters

HD: 2004 - 2021, 4002 - 4012 ND: 2004 - 2018, 4002 - 4009	HD: 2030 - 2211, 4018 - 4103 ND: 2021 - 2169, 4012 - 4089	HD: 2257 - 2415, 4140 - 4675 ND: 2211 - 2415, 4103 - 4675

A : High Start Trq_60Hz base_125% V

This pattern is used when moderate torque is required during startup.

Select this pattern only in the following circumstances.

- Wiring distance between the drive and motor is at least 150 m.
- An AC reactor is connected to the drive output.

Note:

The voltage values in the figure represent those when using 200 V class drives. Double the values for 400 V class drives.

HD: 2004 - 2021, 4002 - 4012 ND: 2004 - 2018, 4002 - 4009	HD: 2030 - 2211, 4018 - 4103 ND: 2021 - 2169, 4012 - 4089	HD: 2257 - 2415, 4140 - 4675 ND: 2211 - 2415, 4103 - 4675

B : High Start Trq_60Hz base_165% V

This pattern is used when strong torque is required during startup.

Select this pattern only in the following circumstances.

- Wiring distance between the drive and motor is at least 150 m.
- An AC reactor is connected to the drive output.

Note:

The voltage values in the figure represent those when using 200 V class drives. Double the values for 400 V class drives.

HD: 2004 - 2021, 4002 - 4012 ND: 2004 - 2018, 4002 - 4009	HD: 2030 - 2211, 4018 - 4103 ND: 2021 - 2169, 4012 - 4089	HD: 2257 - 2415, 4140 - 4675 ND: 2211 - 2415, 4103 - 4675

C : High Freq_60Hz base_90Hz max

This pattern is used to rotate motors at greater than 60 Hz. Output voltage is constant when operating at greater than 60 Hz.

Note:

The voltage values in the figure represent those when using 200 V class drives. Double the values for 400 V class drives.

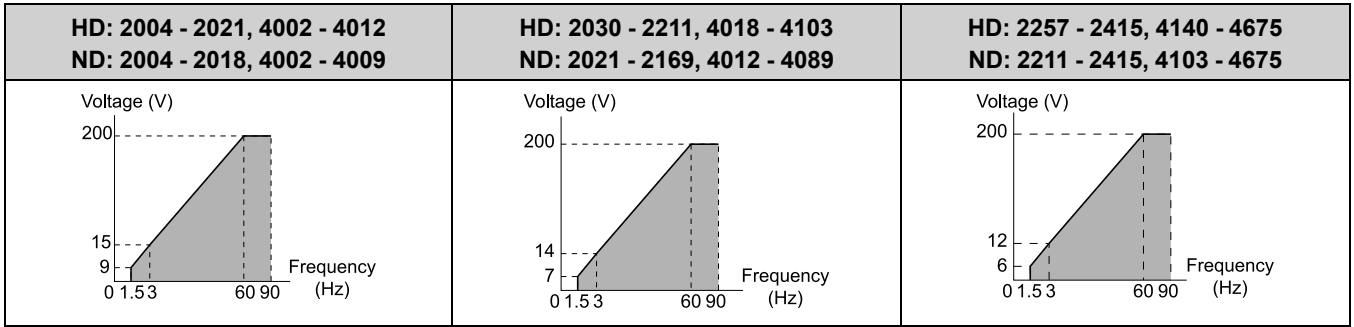

D : High Freq_60Hz base_120Hz max

This pattern is used to rotate motors at greater than 60 Hz. Output voltage is constant when operating at greater than 60 Hz.

Note:

The voltage values in the figure represent those when using 200 V class drives. Double the values for 400 V class drives.

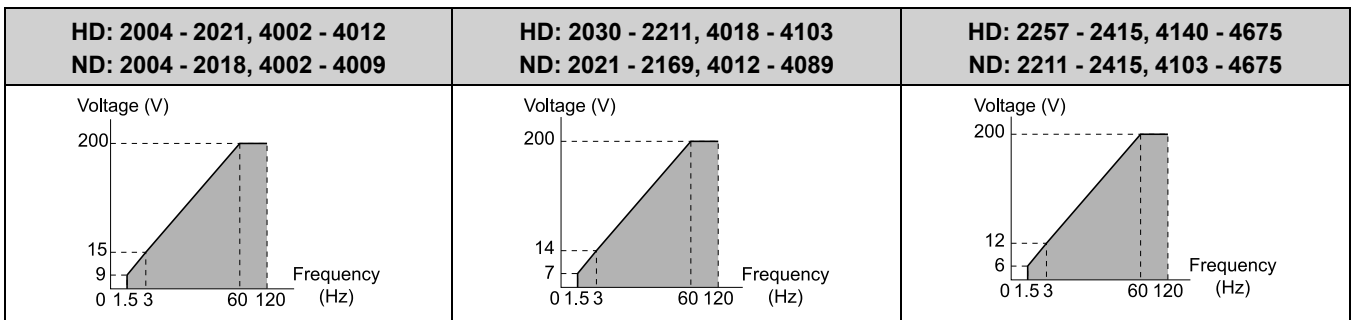

E : High Freq_60Hz base_180Hz max

This pattern is used to rotate motors at greater than 60 Hz. Output voltage is constant when operating at greater than 60 Hz.

Note:

The voltage values in the figure represent those when using 200 V class drives. Double the values for 400 V class drives.

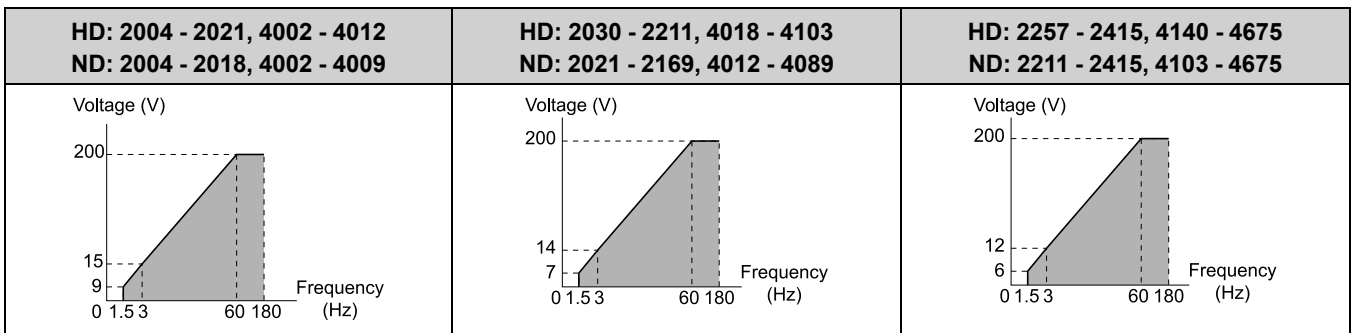

F : Custom

Enables a custom V/f pattern by changing E1-04 through E1-13 [V/f Pattern for Motor 1].

The default settings are equivalent to setting value 1 [Constant Trq_60Hz base_60Hz max].

■ **E1-04: Maximum Output Frequency**

No. (Hex.)	Name	Description	Default Setting (Range)
E1-04 (0303)	Maximum Output Frequency	V/f CL-V/f OLV CLV AOLV OLV/PM AOLV/PM CLV/PM EZOLV Sets the maximum output frequency for the V/f pattern.	Determined by A1-02 and E5-01 (Determined by A1-02 and E5-01)

■ E1-05: Maximum Output Voltage

No. (Hex.)	Name	Description	Default Setting (Range)
E1-05 (0304)	Maximum Output Voltage	V/f CL-V/f OLV CLV AOLV OLV/PM AOLV/PM CLV/PM EZOLV Sets the maximum voltage for the V/f pattern.	Determined by A1-02 (200 V Class: 0.0 - 255.0 V, 400 V Class: 0.0 - 510.0 V)

■ E1-06: Base Frequency

No. (Hex.)	Name	Description	Default Setting (Range)
E1-06 (0305)	Base Frequency	V/f CL-V/f OLV CLV AOLV OLV/PM AOLV/PM CLV/PM EZOLV Sets the base frequency for the V/f pattern.	Determined by A1-02 and E5-01 (0.0 to E1-04)

■ E1-07: Mid Point A Frequency

No. (Hex.)	Name	Description	Default Setting (Range)
E1-07 (0306)	Mid Point A Frequency	V/f CL-V/f OLV CLV AOLV OLV/PM AOLV/PM CLV/PM EZOLV Sets the middle output frequency.	Determined by A1-02 (0.0 to E-04)

■ E1-08: Mid Point A Voltage

No. (Hex.)	Name	Description	Default Setting (Range)
E1-08 (0307)	Mid Point A Voltage	V/f CL-V/f OLV CLV AOLV OLV/PM AOLV/PM CLV/PM EZOLV Sets the middle output frequency.	Determined by A1-02 (200 V Class: 0.0 to 255.0 V, 400 V Class: 0.0 to 510.0 V)

Note:

Default setting is determined by A1-02 [Control Method Selection], C6-01 [Normal / Heavy Duty Selection], and o2-04 [Drive Model Selection].

■ E1-09: Minimum Output Frequency

No. (Hex.)	Name	Description	Default Setting (Range)
E1-09 (0308)	Minimum Output Frequency	V/f CL-V/f OLV CLV AOLV OLV/PM AOLV/PM CLV/PM EZOLV Sets the minimum output frequency for the V/f pattern.	Determined by A1-02 and E5-01 (Determined by A1-02, E1-04, and E5-01)

■ E1-10: Minimum Output Voltage

No. (Hex.)	Name	Description	Default Setting (Range)
E1-10 (0309)	Minimum Output Voltage	V/f CL-V/f OLV CLV AOLV OLV/PM AOLV/PM CLV/PM EZOLV Sets the minimum output voltage.	Determined by A1-02 (200 V Class: 0.0 - 255.0 V, 400 V Class: 0.0 - 510.0 V)

■ E1-11: Mid Point B Frequency

No. (Hex.)	Name	Description	Default Setting (Range)
E1-11 (030A)	Mid Point B Frequency	V/f CL-V/f OLV CLV AOLV OLV/PM AOLV/PM CLV/PM EZOLV Configures the mid point B frequency.	0.0 Hz (0.0 to E-04)

Note:

Parameter *E1-11* is disabled when this parameter is set to *0.0*.

■ E1-12: Mid Point B Voltage

No. (Hex.)	Name	Description	Default Setting (Range)
E1-12 (030B)	Mid Point B Voltage	V/f CL-V/f OLV CLV AOLV OLV/PM AOLV/PM CLV/PM EZOLV Sets the mid point B voltage.	0.0 V (200 V Class: 0.0 - 255.0 V, 400 V Class: 0.0 - 510.0 V)

Note:

Parameter *E1-12* is disabled when this parameter is set to *0.0*.

■ E1-13: Base Voltage

No. (Hex.)	Name	Description	Default Setting (Range)
E1-13 (030C)	Base Voltage	V/f CL-V/f OLV CLV AOLV OLV/PM AOLV/PM CLV/PM EZOLV Sets the base voltage.	0.0 V (200 V Class: 0.0 - 255.0 V, 400 V Class: 0.0 - 510.0 V)

Note:

- The setting value of *E1-13* becomes the same value as that of *E1-05* [Maximum Output Voltage] after performing the Auto-Tuning process.
- When *E1-13* = *0.0*, use the value of *E1-05* to control the voltage.

◆ E2: Motor Parameters

E2 parameters [Motor Parameters] are used to set induction motor data. To switch drive operation from one motor to another motor, configure the first motor (motor 1).

Performing Auto-Tuning automatically sets the *E2 parameters* to the optimal values. If Auto-Tuning cannot be performed, set the *E2 parameters* manually.

Note:

If *A1-02* [Control Method Selection] is set to the following control modes, the keypad does not display *E2-xx*.

- 5 [PM Open Loop Vector Control]
- 6 [PM Advanced Open Loop Vector]
- 7 [PM Closed Loop Vector Control]
- 8 [EZ Open Loop Vector Control]

■ E2-01: Motor Rated Current (FLA)

No. (Hex.)	Name	Description	Default Setting (Range)
E2-01 (030E)	Motor Rated Current	V/f CL-V/f OLV CLV AOLV OLV/PM AOLV/PM CLV/PM EZOLV Sets the motor rated current in amps.	Determined by o2-04 and C6-01 (10% to 200% of the drive rated current)

Note:

- If parameter *E2-01* < *E2-03* [Motor No-Load Current] is set, oPE02 [Parameter Range Setting Error] will be detected.
- The units for the default setting and setting range vary depending on the model of the drive.
 - 2004 to 2042, 4002 to 4023: 0.01 A units
 - 2056 to 2415, 4031 to 4675: 0.1 A units

The value set in *E2-01* becomes the base value for motor protection, the torque limit, and torque control. Enter the motor rated current as written on the motor nameplate. The value of *E2-01* is automatically set to the value input for “Motor Rated Current” by the Auto-Tuning process.

■ E2-02: Motor Rated Slip

No. (Hex.)	Name	Description	Default (Range)
E2-02 (030F) RUN	Motor Rated Slip	V/f CL-V/f OLV CLV AOLV OLV/PM AOLV/PM CLV/PM EZOLV Sets the amount of motor rated slip.	Determined by o2-04 and C6-01 (0.000 - 20.000 Hz)

The value set in *E2-02* becomes the base slip compensation value. The drive sets this parameter during the Auto-Tuning process (Rotational Auto-Tuning and Stationary Auto-Tuning). If Auto-Tuning cannot be performed, calculate the motor rated slip using the information written on the motor nameplate and the formula below:

$$E2-02 = f - (n \times p) / 120$$

- f: Motor rated frequency (Hz)
- n: Rated motor speed (min^{-1} (r/min))
- p: Number of motor poles

■ E2-03: Motor No-Load Current

No. (Hex.)	Name	Description	Default (Range)
E2-03 (0310)	Motor No-Load Current	V/f CL-V/f OLV CLV AOLV OLV/PM AOLV/PM CLV/PM EZOLV Set the no-load current for the motor in amperes when operating at the rated frequency and the no-load voltage.	Determined by o2-04 and C6-01 (0 to E2-01)

Note:

The units for the default setting and setting range vary depending on the model of the drive.

- 2004 to 2042, 4002 to 4023: 0.01 A units
- 2056 to 2415, 4031 to 4726: 0.1 A units

The drive sets this parameter during the Auto-Tuning process (Rotational Auto-Tuning and Stationary Auto-Tuning). The motor no-load current listed in the motor test report can also be entered to E2-03 manually. Contact the motor manufacturer to receive a copy of the motor test report.

Note:

The default setting of the no-load current is for performance with a 4-pole motor recommended by Yaskawa.

■ E2-04: Motor Pole Count

No. (Hex.)	Name	Description	Default (Range)
E2-04 (0311)	Motor Pole Count	V/f CL-V/f OLV CLV AOLV OLV/PM AOLV/PM CLV/PM EZOLV Sets the number of motor poles.	4 (2 - 48)

The value of *E2-04* is automatically set to the value input for [Number of Motor Poles] by the Auto-Tuning process.

■ E2-05: Motor Line-to-Line Resistance

No. (Hex.)	Name	Description	Default (Range)
E2-05 (0312)	Motor Line-to-Line Resistance	V/f CL-V/f OLV CLV AOLV OLV/PM AOLV/PM CLV/PM EZOLV Sets the line-to-line resistance for motor stator windings.	Determined by o2-04 and C6-01 (0.000 - 65.000 Ω)

Note:

This value represents the motor line-to-line resistance. Be careful not to set this parameter with the single phase resistance.

If Auto-Tuning completes successfully, this value is automatically calculated. If Auto-Tuning cannot be executed, obtain a test report from the motor manufacturer. Use the information found on the motor nameplate with any of the following formulas to calculate the motor line-to-line resistance.

- E-type insulation: Multiply 0.92 times the resistance value (Ω) listed on the test report at 75 °C.
- B-type insulation: Multiply 0.92 times the resistance value (Ω) listed on the test report at 75 °C.
- F-type insulation: Multiply 0.87 times the resistance value (Ω) listed on the test report at 115 °C.

■ E2-06: Motor Leakage Inductance

No. (Hex.)	Name	Description	Default (Range)
E2-06 (0313)	Motor Leakage Inductance	<div style="display: flex; justify-content: space-between; font-size: 0.8em; font-weight: normal;"> V/f CL-V/f OLV CLV AOLV OLV/PM AOLV/PM CLV/PM EZOLV </div> Sets the voltage drop due to motor leakage inductance as a percentage of motor rated voltage while the motor is operating at the rated frequency and rated current.	Determined by o2-04 and C6-01 (0.0 - 40.0%)

This value is automatically set during Auto-Tuning (Rotational Auto-Tuning, Stationary Auto-Tuning).

Note:

The amount of voltage drop cannot normally be found on the motor nameplate. If the value of the motor leakage inductance is unknown, obtain a test report from the motor manufacturer.

■ E2-07: Motor Saturation Coefficient 1

No. (Hex.)	Name	Description	Default (Range)
E2-07 (0314)	Motor Saturation Coefficient 1	<div style="display: flex; justify-content: space-between; font-size: 0.8em; font-weight: normal;"> V/f CL-V/f OLV CLV AOLV OLV/PM AOLV/PM CLV/PM EZOLV </div> Sets the motor iron-core saturation coefficient at 50% of the magnetic flux.	0.50 (0.00 - 0.50)

Performing the Rotational Auto-Tuning configures this parameter with the automatically calculated value. This coefficient is used when operating with constant output.

■ E2-08: Motor Saturation Coefficient 2

No. (Hex.)	Name	Description	Default (Range)
E2-08 (0315)	Motor Saturation Coefficient 2	<div style="display: flex; justify-content: space-between; font-size: 0.8em; font-weight: normal;"> V/f CL-V/f OLV CLV AOLV OLV/PM AOLV/PM CLV/PM EZOLV </div> Sets the motor iron-core saturation coefficient at 75% of the magnetic flux.	0.75 (E2-07 to 0.75)

Performing the Rotational Auto-Tuning configures this parameter with the automatically calculated value. This coefficient is used when operating with constant output.

■ E2-09: Motor Mechanical Loss

No. (Hex.)	Name	Description	Default Setting (Range)
E2-09 (0316)	Motor Mechanical Loss	<div style="display: flex; justify-content: space-between; font-size: 0.8em; font-weight: normal;"> V/f CL-V/f OLV CLV AOLV OLV/PM AOLV/PM CLV/PM EZOLV </div> Configures the mechanical loss of the motor. The motor rated power (kW) is 100%. Normally there is no need to change this setting.	0.0% (0.0 - 10.0%)

Adjust this parameter in the following circumstances. The configured mechanical loss is added to the torque reference value as a torque compensation value.

- Torque loss due to motor bearing friction is significant.
- Torque loss of fans and pumps is significant.

■ E2-10: Motor Iron Loss

No. (Hex.)	Name	Description	Default (Range)
E2-10 (0317)	Motor Iron Loss	<div style="display: flex; justify-content: space-between; font-size: 0.8em; font-weight: normal;"> V/f CL-V/f OLV CLV AOLV OLV/PM AOLV/PM CLV/PM EZOLV </div> Sets the motor iron loss in watts.	Determined by o2-04 and C6-01 (0 - 65535 W)

■ E2-11: Motor Rated Power (kW)

No. (Hex.)	Name	Description	Default Setting (Range)
E2-11 (0318)	Motor Rated Power (kW)	<div style="display: flex; justify-content: space-between; font-size: 0.8em; font-weight: normal;"> V/f CL-V/f OLV CLV AOLV OLV/PM AOLV/PM CLV/PM EZOLV </div> Sets the motor rated power in 0.01 kW units. (1 HP = 0.746 kW)	Determined by o2-04 and C6-01 (0.00 - 650.00 kW)

The value of *E2-11* is automatically set to the value input for [Motor Rated Power] by the Auto-Tuning process.

Note:

The value appears in units of 300 kW when the maximum applicable motor output is less than 0.01 kW and appears in units of 300 kW when over 0.1 kW.

The maximum applicable motor output varies depending on C6-01 [Normal / Heavy Duty Selection].

◆ **E3: V/f Pattern for Motor 2**

E3 parameters [V/f Pattern for Motor 2] set the control mode and V/f pattern used for motor 2.

Note:

V/f preset patterns similar to those set with E1-03 [V/f Pattern Selection] are not available for E3 parameters. Use E3-04 [Motor 2 Maximum Output Frequency] through E3-10 [Motor 2 Minimum Output Voltage] to manually set the V/f pattern.

■ **Notes on Manually Setting V/f Patterns**

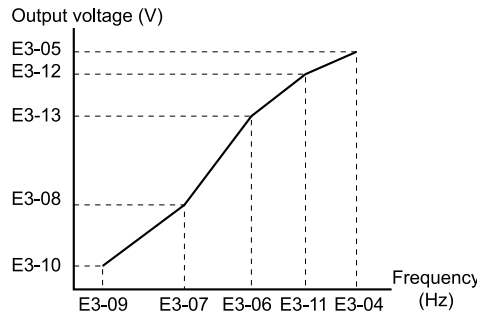

Figure 11.69 Motor 2 V/f Pattern Diagram

- To configure a linear V/f pattern at frequencies lower than E3-06 [Motor 2 Base Frequency], set E3-07 = E3-09 [Motor 2 Mid Point A Frequency = Motor 2 Minimum Output Frequency]. In this case, E1-08 [Mid Point A Voltage] is disregarded.
- Ensure that the five frequencies are set according to the following rules.
 $E3-09 \leq E3-07 < E3-06 \leq E3-11 \leq E3-04$ [Motor 2 Minimum Output Frequency ≤ Motor 2 Mid Point A Frequency < Motor 2 Base Frequency ≤ Motor 2 Mid Point B Frequency ≤ Motor 2 Maximum Output Frequency]
 Incorrect settings will trigger oPE10 [V/f Data Setting Error].
- The V/f pattern settings will be ignored when E3-11 = 0.0 Hz.
- The manually set values for E3-04 through E3-13 [Motor 2 Base Voltage] are reset to their default settings when the drive is initialized using A1-03 [Initialize Parameters].

■ **E3-01: Motor 2 Control Mode Selection**

No. (Hex.)	Name	Description	Default (Range)
E3-01 (0319)	Motor 2 Control Mode Selection	V/f CL-V/f OLV CLV AOLV OLV/PM AOLV/PM CLV/PM EZOLV Selects the control method for motor 2.	0 (0 - 3)

Note:

- Changing the motor 2 control mode selection changes the settings value of parameters dependent on E3-01 to the default settings.
- The protection operation of oL1 [Motor Overload] is determined by L1-01 [Motor Overload Protection Select] in the same way as Motor 1.
- This parameter is not reset when the drive is initialized using parameter A1-03 [Initialize Parameters].

0 : V/f Control

1 : Closed Loop V/f Control

2 : Open Loop Vector Control

3 : Closed Loop Vector Control

■ **E3-04: Motor 2 Maximum Output Frequency**

No. (Hex.)	Name	Description	Default Setting (Range)
E3-04 (031A)	Motor 2 Maximum Output Frequency	V/f CL-V/f OLV CLV AOLV OLV/PM AOLV/PM CLV/PM EZOLV Sets the maximum output frequency used for motor 2.	Determined by E3-01 (40.0 - 590.0 Hz)

■ E3-05: Motor 2 Maximum Output Voltage

No. (Hex.)	Name	Description	Default Setting (Range)
E3-05 (031B)	Motor 2 Maximum Output Voltage	V/f CL-V/f OLV CLV AOLV OLV/PM AOLV/PM CLV/PM EZOLV Sets the maximum output voltage used for motor 2.	Determined by E3-01 (200 V Class: 0.0 to 255.0 V, 400 V Class: 0.0 to 510.0 V)

■ E3-06: Motor 2 Base Frequency

No. (Hex.)	Name	Description	Default Setting (Range)
E3-06 (031C)	Motor 2 Base Frequency	V/f CL-V/f OLV CLV AOLV OLV/PM AOLV/PM CLV/PM EZOLV Sets the base frequency used for motor 2.	Determined by E3-01 (0.0 to E3-04)

■ E3-07: Motor 2 Mid Point A Frequency

No. (Hex.)	Name	Description	Default Setting (Range)
E3-07 (031D)	Motor 2 Mid Point A Frequency	V/f CL-V/f OLV CLV AOLV OLV/PM AOLV/PM CLV/PM EZOLV Sets the middle output frequency used for motor 2.	Determined by E3-01 (0.0 to E3-04)

■ E3-08: Motor 2 Mid Point A Voltage

No. (Hex.)	Name	Description	Default Setting (Range)
E3-08 (031E)	Motor 2 Mid Point A Voltage	V/f CL-V/f OLV CLV AOLV OLV/PM AOLV/PM CLV/PM EZOLV Sets the middle output frequency voltage used for motor 2.	Determined by E3-01 (200 V Class: 0.0 to 255.0 V, 400 V Class: 0.0 to 510.0 V)

■ E3-09: Motor 2 Minimum Output Frequency

No. (Hex.)	Name	Description	Default Setting (Range)
E3-09 (031F)	Motor 2 Minimum Output Frequency	V/f CL-V/f OLV CLV AOLV OLV/PM AOLV/PM CLV/PM EZOLV Sets the minimum output frequency used for motor 2.	Determined by E3-01 (0.0 to E3-04)

■ E3-10: Motor 2 Minimum Output Voltage

No. (Hex.)	Name	Description	Default Setting (Range)
E3-10 (0320)	Motor 2 Minimum Output Voltage	V/f CL-V/f OLV CLV AOLV OLV/PM AOLV/PM CLV/PM EZOLV Sets the minimum output voltage used for motor 2.	Determined by E3-01 (200 V Class: 0.0 to 255.0 V, 400 V Class: 0.0 to 510.0 V)

■ E3-11: Motor 2 Mid Point B Frequency

No. (Hex.)	Name	Description	Default Setting (Range)
E3-11 (0345)	Motor 2 Mid Point B Frequency	V/f CL-V/f OLV CLV AOLV OLV/PM AOLV/PM CLV/PM EZOLV Sets the mid point B frequency used for motor 2. Configure this parameter only when the V/f pattern for the constant output range needs to be adjusted. Normally there is no need to configure this setting.	0.0 Hz (0.0 to E3-04)

Note:

- Parameter *E3-11* is disabled when this parameter is set to *0.0*.
- This parameter is reset to the default value when the drive is initialized.

■ E3-12: Motor 2 Mid Point B Voltage

No. (Hex.)	Name	Description	Default Setting (Range)
E3-12 (0346)	Motor 2 Mid Point B Voltage	<div style="display: flex; justify-content: space-between; font-size: 0.8em; font-weight: normal;"> V/f CL-V/f OLV CLV AOLV OLV/PM AOLV/PM CLV/PM EZOLV </div> <p>Sets the mid point B voltage used for motor 2. Configure this parameter only when the V/f pattern for the constant output range needs to be adjusted. Normally there is no need to configure this setting.</p>	0.0 V (200 V Class: 0.0 - 255.0 V, 400 V Class: 0.0 - 510.0 V)

Note:

- This parameter is reset to the default value when the drive is initialized.
- Parameter E3-12 is disabled when this parameter is set to 0.0.
- The setting value is automatically changed when Auto-Tuning (rotational and stationary 1 or 2) is performed.

■ E3-13: Motor 2 Base Voltage

No. (Hex.)	Name	Description	Default Setting (Range)
E3-13 (0347)	Motor 2 Base Voltage	<div style="display: flex; justify-content: space-between; font-size: 0.8em; font-weight: normal;"> V/f CL-V/f OLV CLV AOLV OLV/PM AOLV/PM CLV/PM EZOLV </div> <p>Configures the base voltage used for motor 2. Configure this parameter only when the V/f pattern for the constant output range needs to be adjusted. Normally there is no need to configure this setting.</p>	0.0 V (200 V Class: 0.0 - 255.0 V, 400 V Class: 0.0 - 510.0 V)

Note:

- This parameter is reset to the default value when the drive is initialized.
- The setting value is automatically changed when Auto-Tuning (rotational and stationary 1 or 2) is performed.

◆ E4: Motor 2 Parameters

E4 parameters [Motor 2 Parameters] are used to set induction motor data. To switch drive operation from one motor to another motor, configure motor 2.

Performing Auto-Tuning automatically sets the E4 parameters to the optimal values. If Auto-Tuning cannot be performed, set the E4 parameters manually.

Note:

E3-xx and E4-xx appears when H1-xx = 16 [Terminal Sx Function Selection = Motor 2 Selection].

■ E4-01: Motor 2 Rated Current

No. (Hex.)	Name	Description	Default (Range)
E4-01 (0321)	Motor 2 Rated Current	<div style="display: flex; justify-content: space-between; font-size: 0.8em; font-weight: normal;"> V/f CL-V/f OLV CLV AOLV OLV/PM AOLV/PM CLV/PM EZOLV </div> <p>Sets the motor rated current for motor 2 in amperes.</p>	Determined by o2-04 and C6-01 (10% to 200% of the drive rated current)

Note:

- If E4-01 ≤ E4-03 [Motor 2 Rated No-Load Current] is set, oPE02 [Parameter Range Setting Error] will be detected.
- The default settings and setting ranges appear in the following units:
 -2004 to 2042, 4002 to 4023: 0.01 A units
 -2056 to 2415, 4031 to 4726: 0.1 A units

The value set for E4-01 becomes the reference value for motor protection, the torque limit, and torque control. Enter the motor rated current as written on the motor nameplate. The value of E4-01 is automatically set to the value input for [Motor Rated Current] by the Auto-Tuning process.

■ E4-02: Motor 2 Rated Slip

No. (Hex.)	Name	Description	Default Setting (Range)
E4-02 (0322) RUN	Motor 2 Rated Slip	<div style="display: flex; justify-content: space-between; font-size: 0.8em; font-weight: normal;"> V/f CL-V/f OLV CLV AOLV OLV/PM AOLV/PM CLV/PM EZOLV </div> <p>Sets the amount of motor 2 rated slip.</p>	Determined by o2-04 and C6-01 (0.000 - 20.000 Hz)

The value set in *E4-02* becomes the base slip compensation value. The drive sets this parameter during the Auto-Tuning process (Rotational Auto-Tuning and Stationary Auto-Tuning). If Auto-Tuning cannot be performed, calculate the motor rated slip using the information written on the motor nameplate and the formula below:

$$E4-02 = f - (n \times p) / 120$$

- f: Motor rated frequency (Hz)
- n: Rated motor speed (min^{-1} (r/min))
- p: Number of motor poles

■ E4-03: Motor 2 Rated No-Load Current

No. (Hex.)	Name	Description	Default Setting (Range)
E4-03 (0323)	Motor 2 Rated No-Load Current	V/f CL-V/f OLV CLV AOLV OLV/PM AOLV/PM CLV/PM EZOLV Sets the no-load current for motor 2 in amperes when operating at the rated frequency and the no-load voltage.	Determined by o2-04 and C6-01 (0 to E4-01)

Note:

The default settings and setting ranges appear in the following units:

- 2004 to 2042, 4002 to 4023: 0.01 A units
- 2056 to 2415, 4031 to 4726: 0.1 A units

The drive sets this parameter during the Auto-Tuning process (Rotational Auto-Tuning and Stationary Auto-Tuning). The motor no-load current listed in the motor test report can also be entered to E2-03 manually. Contact the motor manufacturer to receive a copy of the motor test report.

Note:

The default setting of the no-load current is for performance with a 4-pole motor recommended by Yaskawa.

■ E4-04: Motor 2 Motor Poles

No. (Hex.)	Name	Description	Default Setting (Range)
E4-04 (0324)	Motor 2 Motor Poles	V/f CL-V/f OLV CLV AOLV OLV/PM AOLV/PM CLV/PM EZOLV Sets the number of poles for motor 2.	4 (2 - 48)

The value of *E4-04* is automatically set to the value input for [Number of Motor Poles] by the Auto-Tuning process.

■ E4-05: Motor 2 Line-to-Line Resistance

No. (Hex.)	Name	Description	Default Setting (Range)
E4-05 (0325)	Motor 2 Line-to-Line Resistance	V/f CL-V/f OLV CLV AOLV OLV/PM AOLV/PM CLV/PM EZOLV Sets the line-to-line resistance for motor 2 stator windings.	Determined by o2-04 and C6-01 (0.000 - 65.000 Ω)

Note:

This value represents the line-to-line resistance for motor 2. Be careful not to set this parameter with the single phase resistance.

If Auto-Tuning completes successfully, this value is automatically calculated. If Auto-Tuning cannot be executed, obtain a test report from the motor manufacturer. Use the information found on the motor nameplate with any of the following formulas to calculate the motor line-to-line resistance.

- E-type insulation: Multiply 0.92 times the resistance value (Ω) listed on the test report at 75 °C.
- B-type insulation: Multiply 0.92 times the resistance value (Ω) listed on the test report at 75 °C.
- F-type insulation: Multiply 0.87 times the resistance value (Ω) listed on the test report at 115 °C.

■ E4-06: Motor 2 Leakage Inductance

No. (Hex.)	Name	Description	Default Setting (Range)
E4-06 (0326)	Motor 2 Leakage Inductance	V/f CL-V/f OLV CLV AOLV OLV/PM AOLV/PM CLV/PM EZOLV Sets the voltage drop due to motor 2 leakage inductance as a percentage of motor 2 rated voltage while the motor 2 is operating at the rated frequency and rated current.	Determined by o2-04 and C6-01 (0.0 - 40.0%)

This value is automatically set during Auto-Tuning (Rotational Auto-Tuning, Stationary Auto-Tuning).

Note:

The amount of voltage drop cannot normally be found on the motor nameplate. If the value of the motor 2 leakage inductance is unknown, obtain a test report from the motor manufacturer.

■ **E4-07: Motor2 Saturation Coefficient 1**

No. (Hex.)	Name	Description	Default Setting (Range)
E4-07 (0343)	Motor2 Saturation Coefficient 1	<div style="display: flex; justify-content: space-between; font-size: 0.8em; margin-bottom: 5px;"> V/f CL-V/f OLV CLV AOLV OLV/PM AOLV/PM CLV/PM EZOLV </div> Sets the motor 2 iron-core saturation coefficient at 50% of the magnetic flux.	0.50 (0.00 - 0.50)

Performing the Rotational Auto-Tuning configures this parameter with the automatically calculated value. This coefficient is used when operating with constant output.

■ **E4-08: Motor2 Saturation Coefficient 2**

No. (Hex.)	Name	Description	Default Setting (Range)
E4-08 (0344)	Motor 2 Saturation Coefficient 2	<div style="display: flex; justify-content: space-between; font-size: 0.8em; margin-bottom: 5px;"> V/f CL-V/f OLV CLV AOLV OLV/PM AOLV/PM CLV/PM EZOLV </div> Sets the motor 2 iron-core saturation coefficient at 75% of the magnetic flux.	0.75 (E4-07 to 0.75)

Performing the Rotational Auto-Tuning configures this parameter with the automatically calculated value. This value is used to operate the motor at constant output.

■ **E4-09: Motor 2 Mechanical Loss**

No. (Hex.)	Name	Description	Default Setting (Range)
E4-09 (033F)	Motor 2 Mechanical Loss	<div style="display: flex; justify-content: space-between; font-size: 0.8em; margin-bottom: 5px;"> V/f CL-V/f OLV CLV AOLV OLV/PM AOLV/PM CLV/PM EZOLV </div> Configures the mechanical loss of motor 2. The motor rated power (kW) is 100%. Normally there is no need to change this setting.	0.0% (0.0 - 10.0%)

Adjust this parameter in the following circumstances. The configured mechanical loss is added to the torque reference value as a torque compensation value.

- Torque loss due to motor bearing friction is significant.
- Torque loss of fans and pumps is significant.

■ **E4-10: Motor 2 Iron Loss**

No. (Hex.)	Name	Description	Default (Range)
E4-10 (0340)	Motor 2 Iron Loss	<div style="display: flex; justify-content: space-between; font-size: 0.8em; margin-bottom: 5px;"> V/f CL-V/f OLV CLV AOLV OLV/PM AOLV/PM CLV/PM EZOLV </div> Sets the motor iron loss for motor 2 in watts.	Determined by o2-04 and C6-01 (0 - 65535 W)

■ **E4-11: Motor 2 Rated Power**

No. (Hex.)	Name	Description	Default Setting (Range)
E4-11 (0327)	Motor 2 Rated Power	<div style="display: flex; justify-content: space-between; font-size: 0.8em; margin-bottom: 5px;"> V/f CL-V/f OLV CLV AOLV OLV/PM AOLV/PM CLV/PM EZOLV </div> Sets the motor 2 rated power in 0.01 kW. (1 HP = 0.746 kW)	Determined by o2-04 and C6-01 (0.00 - 650.00 kW)

The value of *E4-11* is automatically set to the value input for [Motor Rated Power] by the Auto-Tuning process.

Note:

The value appears in units of 300 kW when the maximum applicable motor output is less than 0.01 kW and appears in units of 300 kW when over 0.1 kW.

The maximum applicable motor output varies depending on C6-01 [*Normal / Heavy Duty Selection*].

◆ E5: PM Motor Settings

E5 parameters are used to set PM motor data.

Set *E5-01* to the motor code when using PM motors recommended by Yaskawa. *E5* and other related motor parameters will be automatically set to the optimal values.

Perform Auto-Tuning for all other PM motors. If information from motor nameplates or test reports is available, the *E5 parameters* can be manually entered.

Note:

- The keypad displays *E5-xx* only when *A1-02* = 5, 6, 7 [*Control Method Selection* = *OLV/PM*, *AOLV/PM*, *CLV/PM*].
- *E5-xx parameters* are not reset when the drive is initialized using parameter *A1-03* [*Initialize Parameters*].

■ E5-01: PM Motor Code Selection

No. (Hex.)	Name	Description	Default (Range)
E5-01 (0329)	PM Motor Code Selection	<div style="display: flex; justify-content: space-between; font-size: small;"> V/f CL-V/f OLV CLV AOLV OLV/PM AOLV/PM CLV/PM EZOLV </div> <p>When using Yaskawa motors, set the motor code for the PM motor being used. The drive automatically sets several parameters to appropriate values depending on the motor code.</p>	Determined by A1-02, o2-04, and C6-01 (0000 - FFFF)

Note:

- Manually enter the value indicated on the nameplate to *E5-xx* if an alarm or hunting occurs despite using a motor code.
- Set *E5-01* = *FFFF* when using a PM motor other than a Yaskawa SMRA, SSR1, or SST4 series.

The following figure explains the motor code setting.

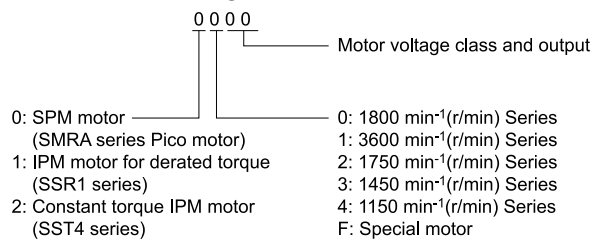

Figure 11.70 PM Motor Code

■ E5-02: PM Motor Rated Power (kW)

No. (Hex.)	Name	Description	Default Setting (Range)
E5-02 (032A)	Motor Rated Capacity	<div style="display: flex; justify-content: space-between; font-size: small;"> V/f CL-V/f OLV CLV AOLV OLV/PM AOLV/PM CLV/PM EZOLV </div> <p>Sets the rated power of PM motors.</p>	Determined by E5-01 (0.10 - 650.00 kW)

The value of *E5-02* is automatically set to the value input for [PM Motor Rated Power] by the Auto-Tuning process when the following types of Auto-Tuning processes are performed.

- PM Motor Parameter Settings
- PM Stationary Auto-Tuning
- PM Rotational Auto-Tuning

■ E5-03: PM Motor Rated Current (FLA)

No. (Hex.)	Name	Description	Default Setting (Range)
E5-03 (032B)	PM Motor Rated Current (FLA)	<div style="display: flex; justify-content: space-between; font-size: small;"> V/f CL-V/f OLV CLV AOLV OLV/PM AOLV/PM CLV/PM EZOLV </div> <p>Sets the motor rated current (FLA) for PM motors.</p>	Determined by E5-01 (10 to 200% of the drive rated current)

The value of *E5-03* is automatically set to the value input for [PM Motor Rated Current] by the Auto-Tuning process when the following types of Auto-Tuning processes are performed.

- PM Motor Parameter Settings
- PM Stationary Auto-Tuning
- PM StaTun for Stator Resistance

- PM Rotational Auto-Tuning

Note:

Display is in the following units:

- 2004 to 2042, 4002 to 4023: 0.01 A units

- 2056 to 2415, 4031 to 4675: 0.1 A units

■ E5-04: PM Motor Pole Count

No. (Hex.)	Name	Description	Default (Range)
E5-04 (032C)	PM Motor Pole Count	<div style="display: flex; justify-content: space-between; font-size: 0.8em;"> V/f CL-V/f OLV CLV AOLV OLV/PM AOLV/PM CLV/PM EZOLV </div> <p>Sets the number of PM motor poles.</p>	Determined by E5-01 (2 - 48)

The value of *E5-04* is automatically set to the value input for [Number of PM Motor Poles] by the Auto-Tuning process when the following types of Auto-Tuning processes are performed.

- PM Motor Parameter Settings
- PM Stationary Auto-Tuning
- PM Rotational Auto-Tuning

■ E5-05: PM Motor Resistance (ohms/phase)

No. (Hex.)	Name	Description	Default (Range)
E5-05 (032D)	PM Motor Resistance (ohms/phase)	<div style="display: flex; justify-content: space-between; font-size: 0.8em;"> V/f CL-V/f OLV CLV AOLV OLV/PM AOLV/PM CLV/PM EZOLV </div> <p>Sets the resistance per phase of the PM motors. Do not enter the line-to-line resistance into <i>E5-05</i> when measuring the resistance manually.</p>	Determined by E5-01 (0.000 - 65.000 Ω)

The value of *E5-05* is automatically set to the value input for [PM Motor Stator Resistance] by the Auto-Tuning process for PM motor parameter settings. Parameter *E5-05* is configured with the result of all other Auto-Tuning processes.

Note:

Do not haphazardly change the resulting settings of the Auto-Tuning process.

■ E5-06: PM d-axis Inductance (mH/phase)

No. (Hex.)	Name	Description	Default (Range)
E5-06 (032E)	PM d-axis Inductance (mH/phase)	<div style="display: flex; justify-content: space-between; font-size: 0.8em;"> V/f CL-V/f OLV CLV AOLV OLV/PM AOLV/PM CLV/PM EZOLV </div> <p>Sets the PM motor d-Axis inductance.</p>	Determined by E5-01 (0.00 - 300.00 mH)

The value of *E5-06* is automatically set to the value input for [PM Motor d-Axis Inductance] by the Auto-Tuning process for PM motor parameter settings. Parameter *E5-06* is configured with the result of all other Auto-Tuning processes.

Note:

Do not haphazardly change the resulting settings of the Auto-Tuning process.

■ E5-07: PM q-axis Inductance (mH/phase)

No. (Hex.)	Name	Description	Default (Range)
E5-07 (032F)	PM q-axis Inductance (mH/phase)	<div style="display: flex; justify-content: space-between; font-size: 0.8em;"> V/f CL-V/f OLV CLV AOLV OLV/PM AOLV/PM CLV/PM EZOLV </div> <p>Sets the PM motor q-Axis inductance.</p>	Determined by E5-01 (0.00 - 600.00 mH)

The value of *E5-07* is automatically set to the value input for [PM Motor q-Axis Inductance] by the Auto-Tuning process for PM motor parameter settings. Parameter *E5-07* is configured with the result of all other Auto-Tuning processes.

Note:

Do not haphazardly change the resulting settings of the Auto-Tuning process.

■ E5-09: PM Back-EMF Vpeak (mV/(rad/s))

No. (Hex.)	Name	Description	Default (Range)
E5-09 (0331)	PM Back-EMF Vpeak (mV/(rad/s))	V/f CL-V/f OLV CLV AOLV OLV/PM AOLV/PM CLV/PM EZOLV Sets the peak value of PM motor induced voltage in units of electrical angles.	Determined by E5-01 (0.0 - 2000.0 mV/(rad/s))

Set this parameter when using an IPM motor with derated torque (SSR1 series) or an IPM motor with constant torque (SST4 series).

Parameter *E5-09* is automatically set to the value input for [PM Motor Induced Voltage Const] in units of mV/(rad/s) by the Auto-Tuning process for PM motor parameter settings.

If *E5-01 = FFFF* is set, only set either *E5-09* or *E5-24 [PM Back-EMF L-L Vrms (mV/rpm)]* as the induced voltage constant.

Note:

Set *E5-24 = 0.0* when setting *E5-09*. If both *E5-09 = 0.0* and *E5-24 = 0.0* are set or neither of these parameters is set to *0.0*, *oPE08 [Parameter Selection Error]* is detected.

■ E5-11: Encoder Z-Pulse Offset

No. (Hex.)	Name	Description	Default Setting (Range)
E5-11 (0333)	Encoder Z-Pulse Offset	V/f CL-V/f OLV CLV AOLV OLV/PM AOLV/PM CLV/PM EZOLV Sets the encoder Z-pulse offset.	0.0 degrees (-180.0 - +180.0 degrees)

The value of *E5-11* is automatically set to the value input for “Encoder Z-Pulse Offset” by the PM motor parameter settings and the PM Stationary Auto-Tuning process. Parameter *E5-11* is configured with the result of the Z Pulse Offset Tuning or the Rotational Auto-Tuning process.

■ E5-24: PM Back-EMF L-L Vrms (mV/rpm)

No. (Hex.)	Name	Description	Default (Range)
E5-24 (0353)	PM Back-EMF L-L Vrms (mV/rpm)	V/f CL-V/f OLV CLV AOLV OLV/PM AOLV/PM CLV/PM EZOLV Sets the rms value for PM motor line voltage in units of mechanical angles.	Determined by E5-01 (0.0 - 6500.0 mV/min ⁻¹)

Set this parameter when using an SPM motor (SMRA Series Pico motor).

Parameter *E5-24* is automatically set to the value input for “PM Motor Induced Voltage Const” in units of mV/min⁻¹ by the Auto-Tuning process for PM motor parameter settings.

- Parameter *E5-24* is automatically set by performing the PM Stationary Auto-Tuning process.
- Parameter *E5-24* is configured with the result of the PM Rotational Auto-Tuning process.

If *E5-01 = FFFF* is set, only set either *E5-09 [PM Back-EMF Vpeak (mV/(rad/s))]* or *E5-24* as the induced voltage constant.

Note:

Set *E5-09 = 0.0* when setting *E5-24*. If both *E5-09 = 0.0* and *E5-24 = 0.0* are set, *oPE08 [Parameter Selection Error]* is detected. If neither *E5-09* or *E5-24* is set to *0.0*, *oPE08* is detected.

■ E5-25: Polarity Estimation Reversal

No. (Hex.)	Name	Description	Default Setting (Range)
E5-25 (035E)	Polarity Estimation Reversal	V/f CL-V/f OLV CLV AOLV OLV/PM AOLV/PM CLV/PM EZOLV Changes the polarity estimate used when estimating initial polarity. Normally there is no need to change this setting.	0 (0, 1)

Set this parameter to *1* when “Sd = 1” is included in the motor nameplate or test report for Yaskawa motors.

0 : Disabled

1 : Enabled

◆ E9: Motor Setting

E9 parameters are used to configure induction motors, PM motors, and SynRM motors. Configure these parameters only for derating torque applications in which a high level of responsiveness and accurate speed control are not required.

E9 parameters are automatically configured with values input by the Auto-Tuning process for motor parameter settings. *E9 parameters* can be manually configured when the EZ Tuning process cannot be performed.

■ E9-01: Motor Type Selection

No. (Hex.)	Name	Description	Default (Range)
E9-01 (11E4)	Motor Type Selection	<div style="display: flex; justify-content: space-between; font-size: small;"> V/f CL-V/f OLV CLV AOLV OLV/PM AOLV/PM CLV/PM EZOLV </div> Configures the motor type.	0 (0 to 2)

The value of *E9-01* is automatically set to the value input for [*Motor Type Selection*] by the EZ Tuning process.

0 : IM

1 : PM

2 : SynRM

■ E9-02: Maximum Speed

No. (Hex.)	Name	Description	Default Setting (Range)
E9-02 (11E5)	Motor Max Revolutions	<div style="display: flex; justify-content: space-between; font-size: small;"> V/f CL-V/f OLV CLV AOLV OLV/PM AOLV/PM CLV/PM EZOLV </div> Configures the max revolutions of the motor.	Determined by E9-01 (40.0 - 120.0 Hz)

Note:

The unit of measure changes depending on the setting of *o1-04* [*V/f Pattern Display Unit*].

The value of *E9-02* is automatically set to the value input for [*Motor Max Revolutions*] by the EZ Tuning process.

■ E9-03: Rated Speed

No. (Hex.)	Name	Description	Default Setting (Range)
E9-03 (11E6)	Rated Speed	<div style="display: flex; justify-content: space-between; font-size: small;"> V/f CL-V/f OLV CLV AOLV OLV/PM AOLV/PM CLV/PM EZOLV </div> Configures the rated rotation speed of the motor.	Determined by E9-01 (100 - 7200 min ⁻¹)

The value of *E9-03* is automatically set to the value input for [*Rated Speed*] by the EZ Tuning process.

Note:

Parameter *E9-03* appears when *E9-01* = 0 [*Motor Type Selection* = IM].

■ E9-04: Base Frequency

No. (Hex.)	Name	Description	Default Setting (Range)
E9-04 (11E7)	Base Frequency	<div style="display: flex; justify-content: space-between; font-size: small;"> V/f CL-V/f OLV CLV AOLV OLV/PM AOLV/PM CLV/PM EZOLV </div> Configures the rated frequency of the motor.	Determined by E9-01 (40.0 - 120.0 Hz)

Note:

The unit of measure changes depending on the setting of *o1-04* [*V/f Pattern Display Unit*].

The value of *E9-04* is automatically set to the value input for [Base Frequency] by the EZ Tuning process.

■ E9-05: Base Voltage

No. (Hex.)	Name	Description	Default Setting (Range)
E9-05 (11E8)	Base Voltage	<div style="display: flex; justify-content: space-between; font-size: 0.8em; margin-bottom: 5px;"> V/f CL-V/f OLV CLV AOLV OLV/PM AOLV/PM CLV/PM EZOLV </div> Configures the rated voltage of the motor.	Determined by E9-01 (200 V Class: 0.0 to 255.0 V, 400 V Class: 0.0 to 510.0 V)

The value of *E9-05* is automatically set to the value input for [*Base Voltage*] by the EZ Tuning process.

■ E9-06: Motor Rated Current

No. (Hex.)	Name	Description	Default Setting (Range)
E9-06 (11E9)	Motor Rated Current	<div style="display: flex; justify-content: space-between; font-size: 0.8em; margin-bottom: 5px;"> V/f CL-V/f OLV CLV AOLV OLV/PM AOLV/PM CLV/PM EZOLV </div> Sets the motor rated current in amperes.	Determined by E9-01 and o2-04 (10% to 200% of the drive rated current)

Note:

Values appear in the following units.

- 2004 to 2042, 4002 to 4023: 0.01 A units
- 2056 to 2415, 4031 to 4675: 0.1 A units

The setting value of *E9-06* is the reference value for motor protection. Enter the motor rated current as written on the motor nameplate. The value of *E9-06* is automatically set to the value input for [*Motor Rated Current*] by the Auto-Tuning process for motor parameter settings.

■ E9-07: Motor Rated Power (kW)

No. (Hex.)	Name	Description	Default Setting (Range)
E9-07 (11EA)	Motor Rated Power (kW)	<div style="display: flex; justify-content: space-between; font-size: 0.8em; margin-bottom: 5px;"> V/f CL-V/f OLV CLV AOLV OLV/PM AOLV/PM CLV/PM EZOLV </div> Sets the motor rated power in 0.01 kW. (1 HP = 0.746 kW)	Determined by E9-02 and o2-04 (0.00 - 650.00 kW)

The value of *E9-07* is automatically set to the value input for [*Motor Rated Power (kW)*] by the Auto-Tuning process for motor parameter settings.

Note:

The value appears in units of 300 kW when the maximum applicable motor output is less than 0.01 kW and appears in units of 300 kW when over 0.1 kW.

■ E9-08: Motor Pole Count

No. (Hex.)	Name	Description	Default Setting (Range)
E9-08 (11EB)	Motor Pole Count	<div style="display: flex; justify-content: space-between; font-size: 0.8em; margin-bottom: 5px;"> V/f CL-V/f OLV CLV AOLV OLV/PM AOLV/PM CLV/PM EZOLV </div> Sets the number of motor poles.	4 (2 to 48)

The value of *E9-08* is automatically set to the value input for [*Number of Motor Poles*] by the Auto-Tuning process for motor parameter settings.

■ E9-09: Motor Rated Slip

No. (Hex.)	Name	Description	Default Setting (Range)
E9-09 (11EC)	Motor Rated Slip	<div style="display: flex; justify-content: space-between; font-size: 0.8em; margin-bottom: 5px;"> V/f CL-V/f OLV CLV AOLV OLV/PM AOLV/PM CLV/PM EZOLV </div> Configures the motor rated slip.	0.0 Hz (0.0 - 20.0 Hz)

The setting value of *E9-09* is the slip compensation reference value.

Parameter *E9-09* is automatically calculated with the setting values of *E9-03*, *E9-04*, and *E9-08*. The value of *E9-09* is automatically set to the value input for [*Motor Rated Slip*] by the Auto-Tuning process for motor parameter

settings. Parameter *E9-09* is configured with the result of this automatic calculation when “Motor Rated Slip” is set to 0.

Note:

Parameter *E9-09* appears when *E9-01* = 0 [*Motor Type Selection* = *IM*].

■ **E9-10: Motor Line-to-Line Resistance**

No. (Hex.)	Name	Description	Default Setting (Range)
E9-10 (11ED)	Motor Line-to-Line Resistance	V/f CL-V/f OLV CLV AOLV OLV/PM AOLV/PM CLV/PM EZOLV Sets the line-to-line resistance for motor stator windings.	Determined by o2-04 (0.000 - 65.000 Ω)

Note:

This value represents the motor line-to-line resistance. Be careful not to set this parameter with the single phase resistance.

This parameter is automatically set by performing the Stationary Auto-Tuning for Line-to-Line Resistance process. If the Stationary Auto-Tuning for Line-to-Line Resistance process cannot be performed, obtain a test report from the motor manufacturer. Use the information found on the motor nameplate with any of the following formulas to calculate the motor line-to-line resistance.

- E-type insulation: Multiply 0.92 times the resistance value (Ω) listed on the test report at 75 °C.
- B-type insulation: Multiply 0.92 times the resistance value (Ω) listed on the test report at 75 °C.
- F-type insulation: Multiply 0.87 times the resistance value (Ω) listed on the test report at 115 °C.

11.7 F: Options

F parameters are used to set option cards, which function as interfaces for encoders, analog I/O, digital I/O, and fieldbus communication.

◆ F1: PG Speed Control Card Encoder

F1 parameters are used to set the operation of and protective function for the encoder option card. The following table lists the setting parameters available for each option card.

Refer to the instruction manual packaged with the encoder option card for more information on installing, wiring, and setting the encoder option cards.

WARNING! *Sudden Movement Hazard. Perform test runs and periodic inspections to ensure that command references are configured appropriately. Incorrect configuration of the command reference can cause unintended motor rotation, which may lead to equipment damage or injury.*

WARNING! *Sudden Movement Hazard. Conduct proper host controller safety design to prevent motors from running uncontrolled when there is a loss of speed feedback. The motor has a potential to run uncontrolled.*

Table 11.37 Encoder Option Card Setting Parameters

Setting Parameter	Encoder Option Card			
	PG-B3	PG-X3	PG-F3	PG-RT3
F1-01	x	x	x	-
F1-02	x	x	x	x
F1-03	x	x	x	x
F1-04	x	x	x	x
F1-05	x	x	x	x
F1-06	x	x	x	-
F1-08	x	x	x	x
F1-09	x	x	x	x
F1-10	x	x	x	x
F1-11	x	x	x	x
F1-12 *1	x	x	-	-
F1-13 *1	x	x	-	-
F1-14	x	x	x	x
F1-18	x	x	x	x
F1-19	x	x	x	x
F1-20	-	x	x	-
F1-21	x	x	-	-
F1-30	x	x	-	-
F1-31 *2	x	x	-	-
F1-32 *2	x	x	-	-
F1-33 *1 *2	x	x	-	-
F1-34 *1 *2	x	x	-	-
F1-35 *2	x	x	-	-
F1-36	-	x	-	-
F1-37 *2	x	x	-	-
F1-50	-	-	x	-
F1-51	-	-	x	-
F1-52	-	-	x	-
Number of cards that can be installed in a drive	2	2	1	1

11.7 F: Options

*1 Parameters set when using the Closed Loop V/f Control method.

*2 Parameters to set an option card connected to CN5-B.

■ F1-01: Encoder 1 Pulse Count (PPR)

No. (Hex.)	Name	Description	Default (Range)
F1-01 (0380)	PG 1 Pulses Per Revolution	<input type="checkbox"/> V/f <input checked="" type="checkbox"/> CL-V/f <input type="checkbox"/> OLV <input checked="" type="checkbox"/> CLV <input checked="" type="checkbox"/> AOLV <input type="checkbox"/> OLV/PM <input type="checkbox"/> AOLV/PM <input checked="" type="checkbox"/> CLV/PM <input type="checkbox"/> EZOLV Sets the number of output pulses per revolution of the encoder.	600 ppr (1 - 60000 ppr)

■ F1-02: PG Feedback Loss Selection

No. (Hex.)	Name	Description	Default Setting (Range)
F1-02 (0381)	PG Feedback Loss Selection	<input type="checkbox"/> V/f <input checked="" type="checkbox"/> CL-V/f <input type="checkbox"/> OLV <input checked="" type="checkbox"/> CLV <input checked="" type="checkbox"/> AOLV <input type="checkbox"/> OLV/PM <input type="checkbox"/> AOLV/PM <input checked="" type="checkbox"/> CLV/PM <input type="checkbox"/> EZOLV Selects the motor operation when <i>PGo</i> [PG Disconnect] is detected.	1 (0 - 4)

PGo is detected when the drive does not detect output pulses from the encoder for an amount of time longer than or equal to the value set in *F1-14* [PG Open-Circuit Detection Time].

Note:

- Faults such as *ov* [DB Bus Overvoltage] and *oC* [Overcurrent] may occur depending on the motor speed and load conditions.
- When using Advanced Open Loop Vector Control, this is enabled when *n4-72* = 1 [Encoder Option Select for Advanced Open Loop Vector Control = With PG].

0 : Ramp to stop

The drive ramps the motor to stop according to the deceleration time. The terminal turns on when *H2-xx* = *E* [MFDO Function Select = Fault] is set.

1 : Coast to stop

The drive shuts off output and the motor coasts to stop. The terminal turns on when *H2-xx* = *E*.

2 : Fast Stop (use C1-09)

The drive stops the motor using the deceleration time set in *C1-09* [Fast Stop Time]. The terminal turns on when *H2-xx* = *E*.

3 : Alarm only

PGo appears on the keypad, and operation continues. This setting is not normally used as the motor and machine is protected from damage.

4 : No alarm display

Operation continues without the display of *PGo* on the keypad. This setting is not normally used as the motor and machine is protected from damage.

■ F1-03: Operation Select at Overspeed

No. (Hex.)	Name	Description	Default Setting (Range)
F1-03 (0382)	Operation Select at Overspeed	<input type="checkbox"/> V/f <input checked="" type="checkbox"/> CL-V/f <input type="checkbox"/> OLV <input checked="" type="checkbox"/> CLV <input checked="" type="checkbox"/> AOLV <input type="checkbox"/> OLV/PM <input type="checkbox"/> AOLV/PM <input checked="" type="checkbox"/> CLV/PM <input type="checkbox"/> EZOLV Selects the motor operation when <i>oS</i> [Overspeed] is detected.	1 (0 - 3)

Detects *oS* when the motor speed exceeds the value set in *F1-08* [Overspeed Detection Level] for an amount of time longer than or equal to the value set in *F1-09* [Overspeed Detection Delay Time].

0 : Ramp to stop

The drive ramps the motor to stop according to the deceleration time. The terminal turns on when *H2-xx* = *E* [MFDO Function Select = Fault].

1 : Coast to stop

The drive shuts off output and the motor coasts to stop. The terminal turns on when *H2-xx* = *E*.

2 : Fast Stop (use C1-09)

The drive stops the motor using the deceleration time set in *C1-09* [Fast Stop Time]. The terminal turns on when *H2-xx* = *E*.

3 : Alarm only

oS appears on the keypad, and operation continues. This setting is not normally used as the motor and machine is protected from damage.

4 : No alarm display

Operation continues without the display of *oS* on the keypad. This setting is not normally used as the motor and machine is protected from damage.

Note:

When *A1-02 = 6* [Control Method Selection = PM Advanced Open Loop Vector], *F1-03 = 1* [Coast to stop] is automatically set and this setting value cannot be changed.

■ F1-04: Operation Selection at Deviation

No. (Hex.)	Name	Description	Default Setting (Range)
F1-04 (0383)	Operation Selection at Deviation	<div style="display: flex; gap: 5px;"> V/f CL-V/f OLV CLV AOLV OLV/PM AOLV/PM CLV/PM EZOLV </div> Selects the motor operation when <i>dEv</i> [Speed Deviation] is detected.	3 (0 - 3)

Detects *dEv* when the difference (speed deviation) between the frequency reference and the actual motor speed exceeds the value set in *F1-10* [Speed Deviation Detection Level] for an amount of time longer than or equal to the value set in *F1-11* [Speed Deviation Detect Delay Time].

0 : Ramp to stop

The drive ramps the motor to stop according to the deceleration time. The terminal turns on when *H2-xx = E* [MFDO Function Select = Fault].

1 : Coast to stop

The output shuts off and the motor coasts to stop. The terminal turns off when *H2-xx = E*.

2 : Fast Stop (use C1-09)

The drive stops the motor using the deceleration time set in *C1-09* [Fast Stop Time]. The terminal turns off when *H2-xx = E*.

3 : Alarm only

dEv appears on the keypad, and operation continues. This setting is not normally used as the motor and machine is protected from damage.

■ F1-05: PG 1 Rotation Selection

No. (Hex.)	Name	Description	Default Setting (Range)
F1-05 (0384)	PG 1 Rotation Selection	<div style="display: flex; gap: 5px;"> V/f CL-V/f OLV CLV AOLV OLV/PM AOLV/PM CLV/PM EZOLV </div> Selects the output sequence for phases A and B of the pulses output from the encoder, given that the motor is running forward.	Determined by A1-02 (0, 1)

Refer to the installation manual included with the option card for more information on how to confirm and set the encoder pulse output sequence.

0 : Pulse A leads

1 : Pulse B leads

■ F1-06: Encoder 1 Pulse Monitor Scaling

No. (Hex.)	Name	Description	Default Setting (Range)
F1-06 (0385)	PG1 Division Rate for Pulse Mon	<div style="display: flex; gap: 5px;"> V/f CL-V/f OLV CLV AOLV OLV/PM AOLV/PM CLV/PM EZOLV </div> Sets the dividing ratio for monitor signals output from the encoder option card.	001 (001 - 032, 102 - 132 (1 - 1/32))

The dividing ratio = $(1 + x)/yz$ when the setting value is a 3-digit value (xyz).

For example, the dividing ratio is 1/32 when *F1-06 = 032*.

Note:

The dividing ratio for the monitor signal is 1:1 when using a single-pulse encoder.

■ F1-08: Overspeed Detection Level

No. (Hex.)	Name	Description	Default Setting (Range)
F1-08 (0387)	Overspeed Detection Level	<div style="display: flex; justify-content: space-between; font-size: 0.8em; font-weight: normal;"> V/f CL-V/f OLV CLV AOLV OLV/PM AOLV/PM CLV/PM EZOLV </div> Sets the detection level of <i>oS</i> [Overspeed] as a percentage when the maximum output frequency is 100%.	115% (0 - 120%)

An *oS* is triggered when the motor speed exceeds the value set in *F1-08* for longer than the time set in *F1-09* [Overspeed Detection Delay Time].

■ F1-09: Overspeed Detection Delay Time

No. (Hex.)	Name	Description	Default Setting (Range)
F1-09 (0388)	Overspeed Detection Delay Time	<div style="display: flex; justify-content: space-between; font-size: 0.8em; font-weight: normal;"> V/f CL-V/f OLV CLV AOLV OLV/PM AOLV/PM CLV/PM EZOLV </div> Sets the detection time for <i>oS</i> [Overspeed].	Determined by A1-02 (0.0 - 2.0 s)

An *oS* is triggered when the motor speed exceeds the value set in *F1-08* [Overspeed Detection Level] for longer than the time set in *F1-09*.

■ F1-10: Speed Deviation Detection Level

No. (Hex.)	Name	Description	Default Setting (Range)
F1-10 (0389)	Speed Deviation Detection Level	<div style="display: flex; justify-content: space-between; font-size: 0.8em; font-weight: normal;"> V/f CL-V/f OLV CLV AOLV OLV/PM AOLV/PM CLV/PM EZOLV </div> Sets the detection level of <i>dEv</i> [Speed Deviation] as a percentage when the maximum output frequency is 100%.	10% (0 - 50%)

A *dEv* is triggered when the difference (speed deviation) between the frequency reference and the actual motor speed exceeds the value set in *F1-10* for longer than the time set in *F1-11* [Speed Deviation Detect DelayTime].

■ F1-11: Speed Deviation Detect DelayTime

No. (Hex.)	Name	Description	Default Setting (Range)
F1-11 (038A)	Speed Deviation Detect DelayTime	<div style="display: flex; justify-content: space-between; font-size: 0.8em; font-weight: normal;"> V/f CL-V/f OLV CLV AOLV OLV/PM AOLV/PM CLV/PM EZOLV </div> Sets the detection time for <i>dEv</i> [Speed Deviation].	0.5 s (0.0 - 10.0 s)

A *dEv* is triggered when the difference (speed deviation) between the frequency reference and the actual motor speed exceeds the value set in *F1-10* [Speed Deviation Detection Level] for longer than the time set in *F1-11*.

■ F1-12: Encoder 1 Gear Teeth 1

No. (Hex.)	Name	Description	Default Setting (Range)
F1-12 (038B)	PG 1 Gear Teeth 1	<div style="display: flex; justify-content: space-between; font-size: 0.8em; font-weight: normal;"> V/f CL-V/f OLV CLV AOLV OLV/PM AOLV/PM CLV/PM EZOLV </div> Sets the number of gear teeth (gear ratio) between the motor and encoder, in combination with <i>F1-13</i> [PG 1 Gear Teeth 2]. <i>F1-12</i> is set with the number of gear teeth for the motor side.	0 (0 - 1000)

The drive calculates the motor speed using the following expression when the number of gear teeth is set.

$$\text{Motor speed (min}^{-1} \text{ or r/min)} = \frac{\text{Number of pulses from the encoder} \times 60}{\text{F1-01}} \times \frac{\text{F1-13}}{\text{F1-12}}$$

Note:

The gear ratio is 1 when *F1-12* = 0 or *F1-13* = 0.

■ F1-13: Encoder 1 Gear Teeth 2

No. (Hex.)	Name	Description	Default Setting (Range)
F1-13 (038C)	PG 1 Gear Teeth 2	<div style="display: flex; justify-content: space-between; font-size: 0.8em; margin-bottom: 5px;"> V/f CL-V/f OLV CLV AOLV OLV/PM AOLV/PM CLV/PM EZOLV </div> Sets the number of gear teeth (gear ratio) between the motor and encoder, in combination with <i>F1-12 [PG 1 Gear Teeth 1]</i> . Parameter F1-13 is set with the number of gear teeth for the load side.	0 (0 - 1000)

The drive calculates the motor speed using the following expression when the number of gear teeth is set.

$$\text{Motor speed (min}^{-1} \text{ or r/min)} = \frac{\text{Number of pulses from the encoder} \times 60}{F1-01} \times \frac{F1-13}{F1-12}$$

Note:

The gear ratio is 1 when $F1-12 = 0$ or $F1-13 = 0$.

■ F1-14: Encoder Open-Circuit Detect Time

No. (Hex.)	Name	Description	Default Setting (Range)
F1-14 (038D)	PG Open-Circuit Detection Time	<div style="display: flex; justify-content: space-between; font-size: 0.8em; margin-bottom: 5px;"> V/f CL-V/f OLV CLV AOLV OLV/PM AOLV/PM CLV/PM EZOLV </div> Sets the detection time for <i>PGo [PG Disconnect]</i> .	2.0 s (0.0 - 10.0 s)

A *PGo* is triggered when the drive does not detect output pulses from the encoder for longer than the time set in *F1-14*.

Note:

Faults such as *ov [DB Bus Overvoltage]* and *oC [Overcurrent]* may occur depending on the motor speed and load conditions.

■ F1-18: Deviation 3 Detection Selection

No. (Hex.)	Name	Description	Default Setting (Range)
F1-18 (03AD)	Deviation 3 Detection Selection	<div style="display: flex; justify-content: space-between; font-size: 0.8em; margin-bottom: 5px;"> V/f CL-V/f OLV CLV AOLV OLV/PM AOLV/PM CLV/PM EZOLV </div> Sets the number of rotations to detect scenarios in which the torque reference and rate of acceleration are inverted, which function as the detection conditions for <i>dv3 [Inversion Detection]</i> .	10 (0 - 10)

A *dv3* is triggered when the following two conditions are detected simultaneously for the number of times set for *F1-18*.

- The torque reference and acceleration are in opposite directions. (for example, torque reference is in forward run and the acceleration is in a negative direction)
- Difference between the speed reference and the actual motor speed is greater than 30%.

Note:

- Reference the setting value for *E5-11 [Encoder Z-Pulse Offset]* and the $\delta\theta$ value found on the motor nameplate. A common cause for a *dv3* fault is the incorrect setting of *E5-11*.
- This function is disabled when $F1-18 = 0$.

■ F1-19: Deviation 4 Detection Selection

No. (Hex.)	Name	Description	Default Setting (Range)
F1-19 (03AE)	Deviation 4 Detection Selection	<div style="display: flex; justify-content: space-between; font-size: 0.8em; margin-bottom: 5px;"> V/f CL-V/f OLV CLV AOLV OLV/PM AOLV/PM CLV/PM EZOLV </div> Sets the number of pulses used to detect <i>dv4 [Inversion Prevention Detection]</i> .	128 (0 - 5000)

A *dv4 [Inversion Prevention Detection]* is triggered when the pulses in a reverse direction to the speed reference are input for longer than the time set in *F1-19*.

Note:

- Reference the value set in *E5-11 [Encoder Z-Pulse Offset]* and the $\delta\theta$ value found on the motor nameplate. A common cause for a *dv4* fault is the incorrect setting of *E5-11*.
- Set $F1-19 = 0$ when using a drive in an application in which the motor is rotated from the load side in the direction reverse to the speed reference.

■ F1-20: Encoder 1 PCB Disconnect Detect

No. (Hex.)	Name	Description	Default Setting (Range)
F1-20 (03B4)	PG Option PCB Disconnect Detect1	<div style="display: flex; justify-content: space-between; font-size: small;"> V/f CL-V/f OLV CLV AOLV OLV/PM AOLV/PM CLV/PM EZOLV </div> <p>Selects whether to enable or disable the disconnection detection function for the encoder connection cable regarding the PG-X3 and PG-F3. Detects <i>PGoH</i> [PG Hardware Fault] when $F1-20 = 1$.</p>	1 (0, 1)

0 : Disabled

1 : Enabled

■ F1-21: Encoder 1 Signal Selection

No. (Hex.)	Name	Description	Default Setting (Range)
F1-21 (03BC)	PG 1 Signal Selection	<div style="display: flex; justify-content: space-between; font-size: small;"> V/f CL-V/f OLV CLV AOLV OLV/PM AOLV/PM CLV/PM EZOLV </div> <p>Selects the type of pulse signal (channel) used for the encoder option card.</p>	0 (0, 1)

0 : A pulse detection

1 : AB pulse detection

■ F1-30: Motor 2 Encoder PCB Port Select

No. (Hex.)	Name	Description	Default Setting (Range)
F1-30 (03AA)	Motor 2 PG Option Port Selection	<div style="display: flex; justify-content: space-between; font-size: small;"> V/f CL-V/f OLV CLV AOLV OLV/PM AOLV/PM CLV/PM EZOLV </div> <p>Selects the connector used when the motor 2 encoder option card is mounted in the drive.</p>	1 (0, 1)

0 : CN5-C

Selects when the speed feedback from the encoder for motor 1 and motor 2 is received by one option card while such signals are switched externally.

1 : CN5-B

Selects when the speed feedback from the encoder for motor 1 and motor 2 is received by two encoder option cards independently.

■ F1-31: Encoder 2 Pulse Count (PPR)

No. (Hex.)	Name	Description	Default Setting (Range)
F1-31 (03B0)	PG 2 Pulses Per Revolution	<div style="display: flex; justify-content: space-between; font-size: small;"> V/f CL-V/f OLV CLV AOLV OLV/PM AOLV/PM CLV/PM EZOLV </div> <p>Sets the number of output pulses per revolution of the encoder. This parameter is for motor 2.</p>	600 ppr (1 - 60000 ppr)

■ F1-32: Encoder 2 Rotation Selection

No. (Hex.)	Name	Description	Default Setting (Range)
F1-32 (03B1)	PG 2 Rotation Selection	<div style="display: flex; justify-content: space-between; font-size: small;"> V/f CL-V/f OLV CLV AOLV OLV/PM AOLV/PM CLV/PM EZOLV </div> <p>Selects the output sequence for phases A and B of the pulses output from the encoder, given that the motor is running forward. This parameter is for motor 2.</p>	0 (0, 1)

Refer to the installation manual included with the option card for more information on how to confirm and set the encoder pulse output sequence.

0 : Pulse A leads

1 : Pulse B leads

■ F1-33: Encoder 2 Gear Teeth 1

No. (Hex.)	Name	Description	Default Setting (Range)
F1-33 (03B2)	PG 2 Gear Teeth 1	<div style="display: flex; justify-content: space-between; font-size: 0.8em; margin-bottom: 5px;"> V/f CL-V/f OLV CLV AOLV OLV/PM AOLV/PM CLV/PM EZOLV </div> Set the number of gear teeth (gear ratio) between the motor and encoder, in combination with <i>F1-34 [PG 2 Gear Teeth 2]</i> . <i>F1-33</i> is set with the number of gear teeth for the motor side. This parameter is for motor 2.	0 (0 - 1000)

The drive calculates the motor speed using the following expression when the number of gear teeth is set.

$$\text{Motor speed (min}^{-1} \text{ or r/min)} = \frac{\text{Number of pulses from the encoder} \times 60}{F1-31} \times \frac{F1-33}{F1-34}$$

Note:

The gear ratio is 1 when *F1-33* = 0 or *F1-34* = 0.

■ F1-34: Encoder 2 Gear Teeth 2

No. (Hex.)	Name	Description	Default Setting (Range)
F1-34 (03B3)	PG 2 Gear Teeth 2	<div style="display: flex; justify-content: space-between; font-size: 0.8em; margin-bottom: 5px;"> V/f CL-V/f OLV CLV AOLV OLV/PM AOLV/PM CLV/PM EZOLV </div> Sets the number of gear teeth (gear ratio) between the motor and encoder, in combination with <i>F1-33 [PG 2 Gear Teeth 1]</i> . <i>F1-34</i> is set with the number of gear teeth for the load side. This parameter is for motor 2.	0 (0 - 1000)

The drive calculates the motor speed using the following expression when the number of gear teeth is set.

$$\text{Motor speed (min}^{-1} \text{ or r/min)} = \frac{\text{Number of pulses from the encoder} \times 60}{F1-31} \times \frac{F1-33 \text{ (load-side PG gear teeth)}}{F1-34 \text{ (motor-side PG gear teeth)}}$$

Note:

The gear ratio is 1 when *F1-33* = 0 or *F1-34* = 0.

■ F1-35: Encoder 2 Pulse Monitor Scaling

No. (Hex.)	Name	Description	Default Setting (Range)
F1-35 (03BE)	PG2 Division Rate for Pulse Mon	<div style="display: flex; justify-content: space-between; font-size: 0.8em; margin-bottom: 5px;"> V/f CL-V/f OLV CLV AOLV OLV/PM AOLV/PM CLV/PM EZOLV </div> Sets the dividing ratio for monitor signals output from the encoder option card. This parameter is for motor 2.	001 (001 - 032, 102 - 132 (1 - 1/32))

The dividing ratio = (1 + x)/yz when the setting value is a 3-digit value (xyz).

For example, the dividing ratio is 1/32 when *F1-35* = 032.

Note:

The dividing ratio for the monitor signal is 1:1 when using a single-pulse encoder.

■ F1-36: Encoder 2 PCB Disconnect Detect

No. (Hex.)	Name	Description	Default Setting (Range)
F1-36 (03B5)	PG Option PCB Disconnect Detect2	<div style="display: flex; justify-content: space-between; font-size: 0.8em; margin-bottom: 5px;"> V/f CL-V/f OLV CLV AOLV OLV/PM AOLV/PM CLV/PM EZOLV </div> Selects whether to enable or disable the disconnection detection function for the encoder connection cable regarding the PG-X3. <i>PGoH [PG Hardware Fault]</i> is detected when this parameter is enabled. This parameter is for motor 2.	1 (0, 1)

0 : Disabled

1 : Enabled

■ F1-37: Encoder 2 Signal Selection

No. (Hex.)	Name	Description	Default Setting (Range)
F1-37 (03BD)	PG 2 Signal Selection	<div style="display: flex; justify-content: space-between; font-size: 0.8em; margin-bottom: 5px;"> V/f CL-V/f OLV CLV AOLV OLV/PM AOLV/PM CLV/PM EZOLV </div> Selects the type of pulse signal (channel) used for the encoder option card. This parameter is for motor 2.	0 (0, 1)

0 : A pulse detection

1 : AB pulse detection

■ F1-50: Encoder Selection

No. (Hex.)	Name	Description	Default Setting (Range)
F1-50 (03D2)	Encoder Selection	<div style="display: flex; justify-content: space-between; font-size: 0.8em; font-weight: normal;"> V/f CL-V/f OLV CLV AOLV OLV/PM AOLV/PM CLV/PM EZOLV </div> Selects the encoder connected to PG-F3.	0 (0 - 2)

0 : EnDat Sin/Cos

1 : EnDat SerialOnly

2 : Hiperface

■ F1-51: PGoH Detection Level

No. (Hex.)	Name	Description	Default Setting (Range)
F1-51 (03D3)	PGoH Detection Level	<div style="display: flex; justify-content: space-between; font-size: 0.8em; font-weight: normal;"> V/f CL-V/f OLV CLV AOLV OLV/PM AOLV/PM CLV/PM EZOLV </div> $\sqrt{\sin^2\theta + \cos^2\theta}$ Sets the detection level for PGoH [PG Hardware Fault] of PG-F3 as a percentage when XXX is 100%.	80% (1 - 100%)

PGoH is detected when the value of $\sqrt{\sin^2\theta + \cos^2\theta}$ falls below the level set in F1-51.

For expression $\sqrt{\sin^2\theta + \cos^2\theta}$, Sin θ represents the single-track (phase B) output from the encoder and Cos θ represents the single-track (phase A) output from the encoder.

Note:

This function is enabled when $F1-20 = 1$ [PG Hardware Disconnection Detection Selection = Enabled].

■ F1-52: Serial Encoder Communication bps

No. (Hex.)	Name	Description	Default Setting (Range)
F1-52 (03D4)	Serial Encoder Communication bps	<div style="display: flex; justify-content: space-between; font-size: 0.8em; font-weight: normal;"> V/f CL-V/f OLV CLV AOLV OLV/PM AOLV/PM CLV/PM EZOLV </div> Selects the speed of communication between the PG-F3 and serial encoder.	0 (0 - 2)

Note:

This function is enabled when $F1-50 = 1$ or 2 [Encoder Selection = EnDat SerialOnly or Hiperface].

0 : 1M/9600bps

1 : 500k/19200bps

2 : 1M/38400bps

◆ F2: Analog Input Option

F2 parameters are used to set the operation of the drive when using the analog input option card AI-A3. The AI-A3 card has 3 input terminals that accept voltages of -10 V to +10 V (20 k Ω) or currents of 4 mA to 20 mA (250 Ω). Installing the AI-A3 card into the drive enables the settings of highly precise analog references with high resolution.

Refer to the instruction manual packaged with the AI-A3 card for more information on installing, wiring, and setting the AI-A3 card.

WARNING! Sudden Movement Hazard. Perform test runs and periodic inspections to ensure that command references are configured appropriately. Incorrect configuration of the command reference can cause unintended motor rotation, which may lead to equipment damage or injury.

■ F2-01: Analog Input Function Selection

No. (Hex.)	Name	Description	Default (Range)
F2-01 (038F)	Analog Input Function Selection	<div style="display: flex; justify-content: space-between; font-size: 0.8em; font-weight: normal;"> V/f CL-V/f OLV CLV AOLV OLV/PM AOLV/PM CLV/PM EZOLV </div> Selects the input method for the analog reference used with AI-A3.	0 (0, 1)

Note:

When the AI-A3 card is not mounted in the drive, the functionality of analog input terminals A1 through A3 on the drive are enabled regardless of the setting of *F2-01*.

0 : 3 channel individual

To increase the accuracy of A/D conversion while using the functions for terminals A1 through A3 on the drive as they are, set *F2-01* = 0. Multi-function analog signal can be input from terminals V1 through V3 for AI-A3. The functions for terminals A1, A2, and A3 on the drive are redirected to terminals V1, V2, and V3 for AI-A3. Signals can be set to have negative numbers using gain and bias adjustments when current is input.

Note:

- To set inputs individually, set *b1-01* = 1 [Reference 1 Source = Analog Input].
- *oPE05* [Run Cmd/Freq Ref Source Sel Err] is detected when *F2-01* = 0 while *b1-01* = 3 [Option PCB].

The following block diagram illustrates the individual input of analog inputs. *H3-xx* parameters as illustrated in the following figure are used to select the function to input the analog reference received from the AI-A3 card and to adjust the gain and bias of these signals.

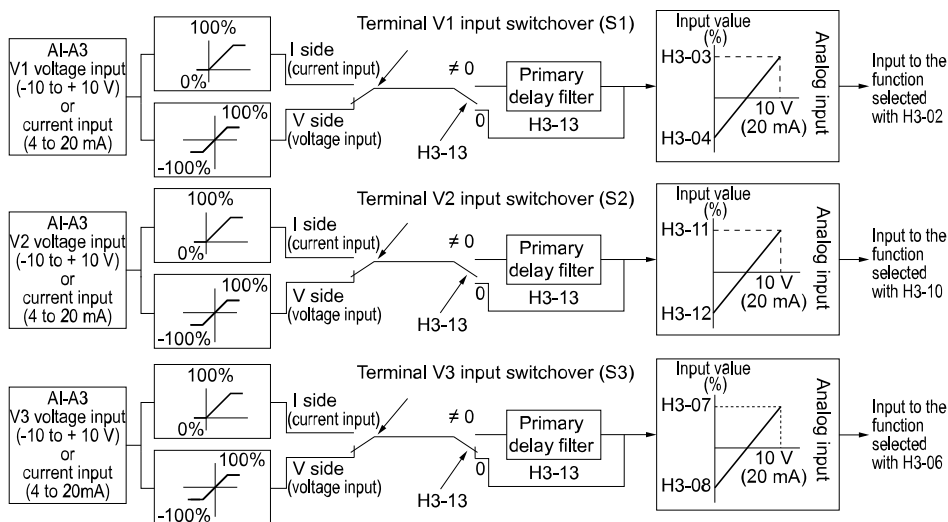

Figure 11.71 Analog Input Reference Individual Input Block Diagram

1 : 3 channel addition

To set addition input, set *b1-01* = 3 [Option PCB].

The frequency reference can be input directly. The resulting value of adding the input from terminals V1 through V3 becomes the frequency reference.

To use the AI-A3 card as addition input, set *F2-01* = 1.

The following block diagram illustrates addition input. Use *F2-02* [Analog Input Option Card Gain] and *F2-03* [Analog Input Option Card Bias] to adjust the analog reference gain and bias for addition input.

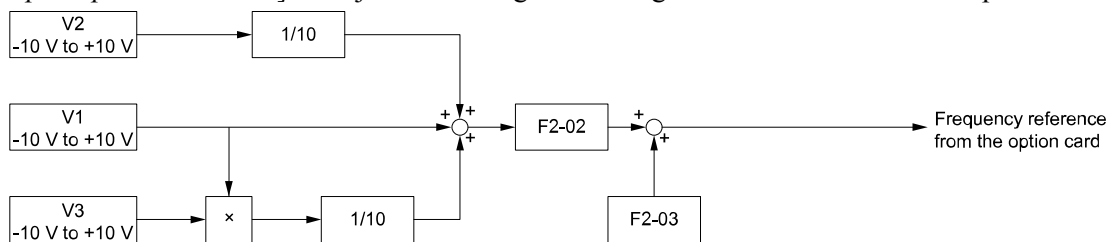

Figure 11.72 Analog Input Reference Addition Input Block Diagram

Adjust the Input State via *F2-02* and *F2-03*

The ratio (%) of the maximum output frequency output as the frequency reference when the bias set by *F2-03* is 0% is determined by the gain set by *F2-02* and the addition input value.

Note:

A voltage input of 10 V or a current input of 20 mA is the 100% value for each channel.

The ratio (%) of the maximum output frequency output as the frequency reference when the addition input value is 0% is determined by the bias set by *F2-03*.

Note:

A voltage input of 0 V or a current input of 4 mA is the 0% value for each channel.

- Example 1:
When the gain set by *F2-02* is 50%, the bias set by *F2-03* is 0%, and the addition input value is 100%, the frequency reference is 50% of the maximum output frequency. When the addition input is 200%, the frequency reference is 100% of the maximum output frequency.
- Example 2:
When the gain set by *F2-02* is 200%, the bias set by *F2-03* is 0%, and the addition input value is 50%, the frequency reference is equivalent to the maximum output frequency. The frequency reference will never be higher than the maximum output frequency even if the addition input value is set to 50% or higher.
- Example 3:
When the gain set by *F2-02* is 100%, the bias set by *F2-03* is 30%, and the addition input value is 0%, the frequency reference is 30% of the maximum output frequency. The frequency reference will be equivalent to the maximum output frequency if the addition input value is set to 70%. The frequency reference will never be higher than the maximum output frequency even if the addition input value is set to 70% or higher.

■ **F2-02: Analog Input Option Card Gain**

No. (Hex.)	Name	Description	Default Setting (Range)
F2-02 (0368) RUN	Analog Input Option Card Gain	<div style="display: flex; justify-content: space-between; font-size: small;"> V/f CL-V/f OLV CLV AOLV OLV/PM AOLV/PM CLV/PM EZOLV </div> Sets the analog reference gain as a percentage when the maximum output frequency is 100%.	100.0% (-999.9 - +999.9%)

Note:

This parameter is only enabled when *F2-01* = 1 [*Analog Input Function Selection* = 3 channel addition].

■ **F2-03: Analog Input Option Card Bias**

No. (Hex.)	Name	Description	Default Setting (Range)
F2-03 (0369) RUN	Analog Input Option Card Bias	<div style="display: flex; justify-content: space-between; font-size: small;"> V/f CL-V/f OLV CLV AOLV OLV/PM AOLV/PM CLV/PM EZOLV </div> Sets the analog reference bias as a percentage when the maximum output frequency is 100%.	0.0% (-999.9 - +999.9%)

Note:

This parameter is only enabled when *F2-01* = 1 [*Analog Input Function Selection* = 3 channel addition].

◆ **F3: Digital Input Option**

F3 parameters are used to set the type of input signal for use with the digital input option card DI-A3.

The frequency reference can be set with the following digital input when the DI-A3 card is mounted in a drive. Set *b1-01* = 3 [*Frequency Reference Selection 1* = Option PCB] to use this card as the frequency reference input. The input signal is isolated input of 24 Vdc and 8 mA.

- Binary, 16 bit/BCD, 4 digit input
- Binary, 12 bit/BCD, 3 digit input
- Binary, 8 bit/BCD, 2 digit input

The DI-A3 card can also be used as a multi-function digital input depending on the setting of *F3-01*.

WARNING! Sudden Movement Hazard. Perform test runs and periodic inspections to ensure that command references are configured appropriately. Incorrect configuration of the command reference can cause unintended motor rotation, which may lead to equipment damage or injury.

■ **Multi-function digital input for DI-A3**

Digital input option DI-A3 can be used as the multi-function input by configuring such that *F3-01* = 8 [*Digital Input Function Selection* = Multi-function Digital input]. To use this as the multi-function input, configure such that *b1-01* ≠ 3 [*Frequency Reference Selection 1* ≠ Option PCB].

Select the function for the DI-A3 terminals with *F3-10* through *F3-25* [*Terminal D0 Function Selection through Terminal DF Function Selection*].

Note:

- Refer to H1-xx “Multi-function Digital Input Setting Values” for more information on multi-function digital input setting values.
- Values 0 [3-Wire Sequence] and 20 through 2F [External fault] cannot be selected for F3-10 through F3-25.
- Configure such that F3-10 through F3-25 = F [Through Mode] when not using the DI-A3 multi-function input. Note that Through mode is not supported.
- Terminal Dx of the DI-A3 is read twice in accordance with the setting of b1-06 [Digital Input Reading].
- Configuring such that F3-01 = 8 when DI-A3 is the frequency reference source (b1-01 or b1-15 = 3 [Frequency Reference Selection 1/2 = Option PCB]) results in the detection of oPE05 [Run Cmd/Freq Ref Source Sel Err].
- The following functions can be used together with the DI-A3 multi-function input.
 - H1-40 through H1-42 [Extend MFDI 1 Function Selection through Extend MFDI 3 Function Selection]
 - H7-01 through H7-04 [Virtual MF Digital Inputs 1 through 4]

■ F3-01: Digital Input Function Selection

No. (Hex.)	Name	Description	Default (Range)
F3-01 (0390)	Digital Input Function Selection	<div style="display: flex; justify-content: space-between; font-size: small;"> V/f CL-V/f OLV CLV AOLV OLV/PM AOLV/PM CLV/PM EZOLV </div> Selects the data format of digital input signals. This parameter is enabled when o1-03 = 0 or 1 [Keypad Display Selection = 0.01 Hz or 0.01% (100% = E1-04)].	0 (0 - 8)

Note:

The DI-A3 input method is set to the BCD input method regardless of the setting of F3-01 when o1-03 = 2 or 3 [r/min or User-selected units]. In this scenario, the value set in o1-03 is used as the setting unit.

0 : BCD, 1% units

1 : BCD, 0.1% units

2 : BCD, 0.01% units

3 : BCD, 1 Hz units

4 : BCD, 0.1 Hz units

5 : BCD, 0.01 Hz units

6 : BCD (5-digit), 0.01 Hz

7 : Binary input

The setting unit and setting range vary depending on the value set in F3-03 [DI Data Length Selection].

- F3-03 = 0 [8 bit]: 100%/255 (-255 to +255)
- F3-03 = 1 [12 bit]: 100%/4095 (-4095 to +4095)
- F3-03 = 2 [16 bit]: 100%/30000 (-33000 to +33000)

8 : Multi-function Digital input

The DI-A3 card is also used as a multi-function digital input terminal.

■ F3-03: DI Data Length Selection

No. (Hex.)	Name	Description	Default Setting (Range)
F3-03 (03B9)	DI Data Length Selection	<div style="display: flex; justify-content: space-between; font-size: small;"> V/f CL-V/f OLV CLV AOLV OLV/PM AOLV/PM CLV/PM EZOLV </div> Selects the number of bits used to set the frequency reference with DI-A3.	2 (0 to 2)

0 : 8bit

1 : 12bit

2 : 16bit

Table 11.38 DI-A3 Terminal Function Selection

Terminal Block	Terminal Name	BCD, Signed [F3-01 = 0 to 5]						BCD, Unsigned [F3-01 = 6] *1		Binary, Signed [F3-01 = 7]		
		8 bit [F3-03 = 0]		12 bit [F3-03 = 1]		16 bit [F3-03 = 2]		8 bit [F3-03 = 0]	12 bit [F3-03 = 1]	16 bit [F3-03 = 2]		
TB2	D0	1 digit (0 to 9)	1	1 digit (0 to 9)	1	1 digit (0 to 9)	1	1 digit (0, 2, 4, 6, 8)	2	bit 0	bit 0	bit 0
	D1		2		2		2		4	bit 1	bit 1	bit 1
	D2		4		4		4		8	bit 2	bit 2	bit 2
	D3		8		8		8		2 digit (0 to 9)	1	bit 3	bit 3
	D4	2 digits (0 to 15) *2	1	2 digit (0 to 9)	1	2 digit (0 to 9)	1	2		bit 4	bit 4	bit 4
	D5		2		2		2	4		bit 5	bit 5	bit 5
	D6		4		4		4	8		bit 6	bit 6	bit 6
	D7		8		8		8	3 digits (0 to 9)	1	bit 7	bit 7	bit 7
TB3	D8	-	-	3 digits (0 to 15) *2	1	3 digits (0 to 9)	-		2	-	bit 8	bit 8
	D9	-	-		2		-		4	-	bit 9	bit 9
	DA	-	-		4		-		8	-	bit 10	bit 10
	DB	-	-		8		-	4 digits (0 to 9)	1	-	bit 11	bit 11
	DC	-	-	-	4 digits (0 to 15) *2	-	2		-	-	bit 12	
	DD	-	-	-		-	4		-	-	bit 13	
	DE	-	-	-		-	8		-	-	bit 14	
	DF	-	-	-		-	5 digit (0 to 3)	1	-	-	bit 15	
TB1	SI	SIGN (encoded) signal 0: Forward run, 1: Reverse run						2	SIGN (encoded) signal 0: Forward run, 1: Reverse run			
	SE	SET (loaded) signal 1: Loads the value set for D0 to DF and SI.										
	SP	Internal power supply: 24 V ± 5%										
	SC	Input signal common										
	SN	Internal power supply common: 0 V										
	SD	Cable sheath connection terminal (ungrounded)										
	FE	Cable sheath connection terminal (grounded)										

*1 The specific BCD setting [BCD (5-digit), 0.01 Hz] (F3-01 [Digital Input Function Selection] = 6) becomes enabled only when F3-03 = 2. This enables a frequency between 0.00 Hz to 399.8 Hz to be set by the BCD. Note that terminal SI is also used as for data bits. Negative commands cannot be input as encoding information (positive/negative) cannot be added to the data.

The minimum bit value for the first BCD digit is 2. For this reason, 0.02 Hz is the smallest setting unit available for this frequency setting. An oPE05 [Run Cmd/Freq Ref Source Sel Err] occurs when F3-03 ≠ 2 while F3-01 = 6.

*2 The most significant digit can be set to a value between 0 to 15 when using “BCD, Signed.” Other digits can be set to a value between 0 to 9.

■ F3-10: Terminal D0 Function Selection

No. (Hex.)	Name	Description	Default (Range)
F3-10 (0BE3)	Terminal D0 Function Selection	<div style="display: flex; justify-content: space-between; font-size: small;"> V/f CL-V/f OLV CLV AOLV OLV/PM AOLV/PM CLV/PM EZOLV </div> Selects the function for terminal D0 of the DI-A3 when F3-01 = 8 [Digital Input Function Selection = Multi-function Digital input].	F (1 - 19F)

■ F3-11: Terminal D1 Function Selection

No. (Hex.)	Name	Description	Default (Range)
F3-11 (0BE4)	Terminal D1 Function Selection	V/f CL-V/f OLV CLV AOLV OLV/PM AOLV/PM CLV/PM EZOLV Selects the function for terminal D1 of the DI-A3 when $F3-01 = 8$ [Digital Input Function Selection = Multi-function Digital input].	F (1 - 19F)

■ F3-12: Terminal D2 Function Selection

No. (Hex.)	Name	Description	Default (Range)
F3-12 (0BE5)	Terminal D2 Function Selection	V/f CL-V/f OLV CLV AOLV OLV/PM AOLV/PM CLV/PM EZOLV Selects the function for terminal D2 of the DI-A3 when $F3-01 = 8$ [Digital Input Function Selection = Multi-function Digital input].	F (1 - 19F)

■ F3-13: Terminal D3 Function Selection

No. (Hex.)	Name	Description	Default (Range)
F3-13 (0BE6)	Terminal D3 Function Selection	V/f CL-V/f OLV CLV AOLV OLV/PM AOLV/PM CLV/PM EZOLV Selects the function for terminal D3 of the DI-A3 when $F3-01 = 8$ [Digital Input Function Selection = Multi-function Digital input].	F (1 - 19F)

■ F3-14: Terminal D4 Function Selection

No. (Hex.)	Name	Description	Default (Range)
F3-14 (0BE7)	Terminal D4 Function Selection	V/f CL-V/f OLV CLV AOLV OLV/PM AOLV/PM CLV/PM EZOLV Selects the function for terminal D4 of the DI-A3 when $F3-01 = 8$ [Digital Input Function Selection = Multi-function Digital input].	F (1 - 19F)

■ F3-15: Terminal D5 Function Selection

No. (Hex.)	Name	Description	Default (Range)
F3-15 (0BE8)	Terminal D5 Function Selection	V/f CL-V/f OLV CLV AOLV OLV/PM AOLV/PM CLV/PM EZOLV Selects the function for terminal D5 of the DI-A3 when $F3-01 = 8$ [Digital Input Function Selection = Multi-function Digital input].	F (1 - 19F)

■ F3-16: Terminal D6 Function Selection

No. (Hex.)	Name	Description	Default (Range)
F3-16 (0BE9)	Terminal D6 Function Selection	V/f CL-V/f OLV CLV AOLV OLV/PM AOLV/PM CLV/PM EZOLV Selects the function for terminal D6 of the DI-A3 when $F3-01 = 8$ [Digital Input Function Selection = Multi-function Digital input].	F (1 - 19F)

■ F3-17: Terminal D7 Function Selection

No. (Hex.)	Name	Description	Default (Range)
F3-17 (0BEA)	Terminal D7 Function Selection	V/f CL-V/f OLV CLV AOLV OLV/PM AOLV/PM CLV/PM EZOLV Selects the function for terminal D7 of the DI-A3 when $F3-01 = 8$ [Digital Input Function Selection = Multi-function Digital input].	F (1 - 19F)

■ F3-18: Terminal D8 Function Selection

No. (Hex.)	Name	Description	Default (Range)
F3-18 (0BEB)	Terminal D8 Function Selection	V/f CL-V/f OLV CLV AOLV OLV/PM AOLV/PM CLV/PM EZOLV Selects the function for terminal D8 of the DI-A3 when $F3-01 = 8$ [Digital Input Function Selection = Multi-function Digital input].	F (1 - 19F)

■ F3-19: Terminal D9 Function Selection

No. (Hex.)	Name	Description	Default (Range)
F3-19 (0BEC)	Terminal D9 Function Selection	<div style="display: flex; justify-content: space-between; font-size: 0.8em; font-weight: bold; background-color: #f0f0f0; padding: 2px;"> V/f CL-V/f OLV CLV AOLV OLV/PM AOLV/PM CLV/PM EZOLV </div> Selects the function for terminal D9 of the DI-A3 when $F3-01 = 8$ [Digital Input Function Selection = Multi-function Digital input].	F (1 - 19F)

■ F3-20: Terminal DA Function Selection

No. (Hex.)	Name	Description	Default (Range)
F3-20 (0BED)	Terminal DA Function Selection	<div style="display: flex; justify-content: space-between; font-size: 0.8em; font-weight: bold; background-color: #f0f0f0; padding: 2px;"> V/f CL-V/f OLV CLV AOLV OLV/PM AOLV/PM CLV/PM EZOLV </div> Selects the function for terminal DA of the DI-A3 when $F3-01 = 8$ [Digital Input Function Selection = Multi-function Digital input].	F (1 - 19F)

■ F3-21: Terminal DB Function Selection

No. (Hex.)	Name	Description	Default (Range)
F3-21 (0BEE)	Terminal DB Function Selection	<div style="display: flex; justify-content: space-between; font-size: 0.8em; font-weight: bold; background-color: #f0f0f0; padding: 2px;"> V/f CL-V/f OLV CLV AOLV OLV/PM AOLV/PM CLV/PM EZOLV </div> Selects the function for terminal DB of the DI-A3 when $F3-01 = 8$ [Digital Input Function Selection = Multi-function Digital input].	F (1 - 19F)

■ F3-22: Terminal DC Function Selection

No. (Hex.)	Name	Description	Default (Range)
F3-22 (0BEF)	Terminal DC Function Selection	<div style="display: flex; justify-content: space-between; font-size: 0.8em; font-weight: bold; background-color: #f0f0f0; padding: 2px;"> V/f CL-V/f OLV CLV AOLV OLV/PM AOLV/PM CLV/PM EZOLV </div> Selects the function for terminal DC of the DI-A3 by when $F3-01 = 8$ [Digital Input Function Selection = Multi-function Digital input].	F (1 - 19F)

■ F3-23: Terminal DD Function Selection

No. (Hex.)	Name	Description	Default (Range)
F3-23 (0BF0)	Terminal DD Function Selection	<div style="display: flex; justify-content: space-between; font-size: 0.8em; font-weight: bold; background-color: #f0f0f0; padding: 2px;"> V/f CL-V/f OLV CLV AOLV OLV/PM AOLV/PM CLV/PM EZOLV </div> Selects the function for terminal DD of the DI-A3 when $F3-01 = 8$ [Digital Input Function Selection = Multi-function Digital input].	F (1 - 19F)

■ F3-24: Terminal DE Function Selection

No. (Hex.)	Name	Description	Default (Range)
F3-24 (0BF1)	Terminal DE Function Selection	<div style="display: flex; justify-content: space-between; font-size: 0.8em; font-weight: bold; background-color: #f0f0f0; padding: 2px;"> V/f CL-V/f OLV CLV AOLV OLV/PM AOLV/PM CLV/PM EZOLV </div> Selects the function for terminal DE of the DI-A3 when $F3-01 = 8$ [Digital Input Function Selection = Multi-function Digital input].	F (1 - 19F)

■ F3-25: Terminal DF Function Selection

No. (Hex.)	Name	Description	Default (Range)
F3-25 (0BF2)	Terminal DF Function Selection	<div style="display: flex; justify-content: space-between; font-size: 0.8em; font-weight: bold; background-color: #f0f0f0; padding: 2px;"> V/f CL-V/f OLV CLV AOLV OLV/PM AOLV/PM CLV/PM EZOLV </div> Selects the function for terminal DF of the DI-A3 when $F3-01 = 8$ [Digital Input Function Selection = Multi-function Digital input].	F (1 - 19F)

◆ F4: Analog Monitor Option

$F4$ parameters are used to set the operation of the drive when using the analog monitor option card AO-A3. The AO-A3 card has 2 output terminals (terminals V1 and V2) for signals with an Output resolution of 11 bits (1/2048) + encoding and that have an output voltage range of -10 V to +10 V. By installing the AO-A3 card to a

drive, analog signals which are used to monitor the output status of the drive (output frequency and output current) can be output.

Refer to the instruction manual packaged with the AO-A3 card for more information on installing, wiring, and setting the AO-A3 card.

Select monitor data to be output from terminals V1 and V2 on the AO-A3 card by the *U parameter* number. Enter the final three digits of *Ux-xx* as the setting value.

- Adjust output signal level of terminal V1 by using gain and bias

The output signal is adjustable while the drive is stopped. Use the following procedure to perform calibration.

1. View the value set to *F4-02 [Terminal V1 Monitor Gain]* on the keypad.
A voltage equal to 100% of the parameter being set in *F4-01 [Terminal V1 Monitor Selection]* will be output from terminal V1.
2. Adjust *F4-02* viewing the monitor connected to terminal V1.
3. View the value set to *F4-05 [Terminal V1 Monitor Bias]* on the keypad.
An analog signal equal to 0% of the parameter being set in *F4-01* will be output from terminal V1.
4. Adjust *F4-05* viewing the monitor connected to terminal V1.

- Adjust output signal level of terminal V2 by using gain and bias

The output signal is adjustable while the drive is stopped. Use the following procedure to perform calibration.

1. View the value set to *F4-04 [Terminal V2 Monitor Gain]* on the keypad.
The analog signal equal to 100% of the parameter being set in *F4-03 [Terminal V2 Monitor Selection]* will be output from terminal V2.
2. Adjust *F4-04* viewing the monitor connected to terminal V2.
3. View the value set to *F4-06 [Terminal V2 Monitor Bias]* on the keypad.
The analog signal equal to 0% of the parameter being set in *F4-03* will be output from terminal V2.
4. Adjust *F4-06* viewing the monitor connected to terminal V2.

■ F4-01: Terminal V1 Monitor Selection

No. (Hex.)	Name	Description	Default (Range)
F4-01 (0391)	Terminal V1 Monitor Selection	V/f CL-V/f OLV CLV AOLV OLV/PM AOLV/PM CLV/PM EZOLV Sets the number for monitor item of output from terminal V1.	102 (000 - 999)

Enter the final three digits of *Ux-xx [Monitors]* to determine which monitor data is output from the option card. For example, set *x-xx* to 102 to monitor *U1-02 [Output Frequency]*.

Note:

- Some monitors are only available in certain control methods.
- Set 000 or 031 when using the terminal in through mode. This setting can adjust the V1 terminal output from PLC via MEMOBUS/Modbus communications or a communications option.

■ F4-02: Terminal V1 Monitor Gain

No. (Hex.)	Name	Description	Default Setting (Range)
F4-02 (0392) RUN	Terminal V1 Monitor Gain	V/f CL-V/f OLV CLV AOLV OLV/PM AOLV/PM CLV/PM EZOLV Sets the gain of monitor signal output from terminal V1 as a percentage. Sets the voltage level output from terminal V1 to a 100% value of 10 V when a monitoring item is at 100% while an output of 0% for monitoring items is 0 V.	100.0% (-999.9 - +999.9%)

The maximum output voltage output from terminal V1 is ± 10 V. The signal level can be selected with *F4-07 [Terminal V1 Signal Level]*.

Setting example:

When set as follows, and the monitored output voltage is at 100% (drive rated current), the output voltage of terminal V1 is 5 V (50% of 10 V). Thus, the output current is 200% of the drive rated current when terminal V1 outputs a maximum voltage of 10 V.

- F4-01 [Terminal V1 Monitor Selection] = 102 (U1-02: Output Frequency)
- F4-02 = 50.0%
- F4-05 [Terminal V1 Monitor Bias] = 0.0%
- F4-07 = 0 (0 to 10 V)

■ F4-03: Terminal V2 Monitor Selection

No. (Hex.)	Name	Description	Default Setting (Range)
F4-03 (0393)	Terminal V2 Monitor Selection	<div style="display: flex; justify-content: space-between; font-size: 0.8em; font-weight: bold;"> V/f CL-V/f OLV CLV AOLV OLV/PM AOLV/PM CLV/PM EZOLV </div> Sets the number for monitor item of output from terminal V2.	103 (000 - 999)

Enter the final three digits of *Ux-xx [Monitors]* to determine which monitor data is output from the option card. For example, to monitor *U1-03 [Output Current]*, set a value of *103*.

Note:

- Some monitors are only available in certain control methods.
- Set *000* or *031* when using the terminal in through mode. The terminal V2 output level can be set from the PLC via MEMOBUS/Modbus or the communication option.

■ F4-04: Terminal V2 Monitor Gain

No. (Hex.)	Name	Description	Default Setting (Range)
F4-04 (0394) RUN	Terminal V2 Monitor Gain	<div style="display: flex; justify-content: space-between; font-size: 0.8em; font-weight: bold;"> V/f CL-V/f OLV CLV AOLV OLV/PM AOLV/PM CLV/PM EZOLV </div> Sets the gain of monitor signal output from terminal V2 as a percentage. Sets the voltage level output from terminal V2 to a 100% value of 10 V when a monitoring item is at 100% while an output of 0% for monitoring items is 0 V.	50.0% (-999.9 - +999.9%)

The maximum output voltage output from terminal V2 is ± 10 V. The signal level can be selected with *F4-08 [Terminal V2 Signal Level]*.

Setting example:

When set as follows, and the monitored output voltage is at 100% (drive rated current), the output voltage of terminal V2 is 5 V (50% of 10 V). Thus, the output current is 200% of the drive rated current when terminal V2 outputs a maximum voltage of 10 V.

- F4-03 [Terminal V2 Monitor Selection] = 103 (U1-03: Output Current)
- F4-04 = 50.0%
- F4-06 [Terminal V2 Monitor Bias] = 0.0%
- F4-08 = 0 (0 to 10 V)

■ F4-05: Terminal V1 Monitor Bias

No. (Hex.)	Name	Description	Default Setting (Range)
F4-05 (0395) RUN	Terminal V1 Monitor Bias	<div style="display: flex; justify-content: space-between; font-size: 0.8em; font-weight: bold;"> V/f CL-V/f OLV CLV AOLV OLV/PM AOLV/PM CLV/PM EZOLV </div> Sets the bias of monitor signal output from terminal V1 as a percentage. Sets the voltage level output from terminal V1 to a 100% value of 10 V when the output for monitoring items is 0%.	0.0% (-999.9 - +999.9%)

The maximum output voltage output from terminal V1 is ± 10 V. The signal level can be selected with *F4-07 [Terminal V1 Signal Level]*.

■ F4-06: Terminal V2 Monitor Bias

No. (Hex.)	Name	Description	Default Setting (Range)
F4-06 (0396) RUN	Terminal V2 Monitor Bias	<div style="display: flex; justify-content: space-between; font-size: 0.8em; font-weight: bold;"> V/f CL-V/f OLV CLV AOLV OLV/PM AOLV/PM CLV/PM EZOLV </div> Sets the bias of monitor signal output from terminal V2 as a percentage. Sets the voltage level output from terminal V2 to a 100% value of 10 V when the output for monitoring items is 0%.	0.0% (-999.9 - +999.9%)

The maximum output voltage output from terminal V2 is ± 10 V. The signal level can be selected with *F4-08 [Terminal V2 Signal Level]*.

■ F4-07: Terminal V1 Signal Level

No. (Hex.)	Name	Description	Default Setting (Range)
F4-07 (0397)	Terminal V1 Signal Level	V/f CL-V/f OLV CLV AOLV OLV/PM AOLV/PM CLV/PM EZOLV Selects the level of signals output from the MFAO terminal V1.	0 (0, 1)

0 : 0 to 10 V

1 : -10 to 10 V

■ F4-08: Terminal V2 Signal Level

No. (Hex.)	Name	Description	Default Setting (Range)
F4-08 (0398)	Terminal V2 Signal Level	V/f CL-V/f OLV CLV AOLV OLV/PM AOLV/PM CLV/PM EZOLV Selects the level of signals output from the MFAO terminal V2.	0 (0, 1)

0 : 0 to 10 V

1 : -10 to 10 V

◆ F5: Digital Output Option

F5 parameters are used to set output mode and function of output signals when using the digital output option card DO-A3.

When the DO-A3 card is installed to the drive, isolated digital signals used to monitor the drive operation status can be output.

- 6 points of photocoupler output (48 V, 50 mA or less)
- 2 points of relay contact output (250 Vac, 30 Vdc: 1 A or less)

Refer to the instruction manual packaged with the DO-A3 card for more information on installing, wiring, and setting the DO-A3 card.

■ Output Mode Selection via Parameters

Signal output from the *DO-A3 card* can be set as follows via *F5-09 [DO-A3 Output Mode Selection]*.

Table 11.39 Details of F5-09 and the DO-A3 Terminal Output

DO-A3 Terminal Block	DO-A3 Terminal Name	F5-09 = 0 [8 Channel Individual] (Default Setting)	F5-09 = 1 [Binary Code Output]	F5-09 = 2 [8 Channel Select(F5-01 to F5-08)]
TB1	M1-M2	Zero speed detection in progress	During run	Depending on the setting of F5-07 [Terminal M1-M2 Output Selection]
	M3-M4	During speed agreement	Minor fault (excluding bb [Baseblock])	Depending on the setting of F5-08 [Terminal M3-M4 Output Selection]
TB2	P1-PC	oC [Overcurrent], GF [Ground Fault]	Coded output Note: Refer to Table 11.40 for details.	Depending on the setting of F5-01 [Terminal P1-PC Output Selection]
	P2-PC	ov [Overvoltage]		Depending on the setting of F5-02 [Terminal P2-PC Output Selection]
	P3-PC	oL2 [Drive Overloaded] or oH2 [Drive Overheat Warning]		Depending on the setting of F5-03 [Terminal P3-PC Output Selection]
	P4-PC	Not used		Depending on the setting of F5-04 [Terminal P4-PC Output Selection]
	P5-PC	oS [Overspeed]	Zero speed detection in progress	Depending on the setting of F5-05 [Terminal P5-PC Output Selection]
	P6-PC	oH, oH1 [Heatsink Overheat] or oL1 [Motor Overload]	During speed agreement	Depending on the setting of F5-06 [Terminal P6-PC Output Selection]

Table 11.40 Binary Code Output [F5-09 = 1]

Coded Output (Binary)	Description	DO-A3 Terminal Block TB2			
		Terminal P1-PC	Terminal P2-PC	Terminal P3-PC	Terminal P4-PC
0	No fault	0	0	0	0
1	oC [Overcurrent], GF [Ground Fault]	1	0	0	0
2	ov [Overvoltage]	0	1	0	0
3	oL2 [Drive Overloaded]	1	1	0	0
4	oH, oH1 [Heatsink Overheat]	0	0	1	0
5	oS [Overspeed]	1	0	1	0
6	Not used	0	1	1	0
7	rr [Dynamic Braking Transistor], rH [Braking Resistor Overheat]	1	1	1	0
8	External fault [EF1 to EF8]	0	0	0	1
9	CPFxx, oFAxx, oFbxx, oFCxx [Drive Hardware Fault] ^{*1}	1	0	0	1
A	oL1 [Motor Overload]	0	1	0	1
B	Not used	1	1	0	1
C	Uv1, Uv2 [Undervoltage], Uv3 [SoftCharge Bypass Circuit Fault]	0	0	1	1
D	dEv [Speed Deviation]	1	0	1	1

Coded Output (Binary)	Description	DO-A3 Terminal Block TB2			
		Terminal P1-PC	Terminal P2-PC	Terminal P3-PC	Terminal P4-PC
E	PGo [PG Disconnect]	0	1	1	1
F	Not used	1	1	1	1

*1 The digits represented by xx vary depending on the type of fault that occurs.

■ Digital Output Card Selection

Refer to “H2: Multi-function Digital Output” for information on the functions that output from the terminals when $F5-09 = 2$ [DO-A3 Output Mode Selection]. Set the desired output items with $F5-01$ to $F5-08$.

No.	Name	Setting Range	Default
F5-01	Terminal P1-PC Output Selection	0 - 192	0: During Run
F5-02	Terminal P2-PC Output Selection	0 - 192	1: Zero Speed
F5-03	Terminal P3-PC Output Selection	0 - 192	2: Speed Agree 1
F5-04	Terminal P4-PC Output Selection	0 - 192	4: Frequency Detection 1
F5-05	Terminal P5-PC Output Selection	0 - 192	6: Drive Ready (READY)
F5-06	Terminal P6-PC Output Selection	0 - 192	37: During Frequency Output
F5-07	Terminal M1-M2 Output Selection	0 - 192	F: Not used
F5-08	Terminal M3-M4 Output Selection	0 - 192	F: Not used

■ F5-01: Terminal P1-PC Output Selection

No. (Hex.)	Name	Description	Default (Range)
F5-01 (0399)	Terminal P1-PC Output Selection	<div style="display: flex; justify-content: space-between; font-size: small;"> V/f CL-V/f OLV CLV AOLV OLV/PM AOLV/PM CLV/PM EZOLV </div> <p>The function output from terminal P1-PC on the DO-A3 card is selected by the MFDO setting value. This parameter is enabled when $F5-09 = 2$ [DO-A3 Output Mode Selection = 8 channel select(F5-01 to F5-08)].</p>	0 (0 - 1A7)

■ F5-02: Terminal P2-PC Output Selection

No. (Hex.)	Name	Description	Default Setting (Range)
F5-02 (039A)	Terminal P2-PC Output Selection	<div style="display: flex; justify-content: space-between; font-size: small;"> V/f CL-V/f OLV CLV AOLV OLV/PM AOLV/PM CLV/PM EZOLV </div> <p>The function output from terminal P2-PC on the DO-A3 card is selected by the MFDO setting value. This parameter is enabled when $F5-09 = 2$ [DO-A3 Output Mode Selection = 8 channel select(F5-01 to F5-08)].</p>	1 (0 - 1A7)

■ F5-03: Terminal P3-PC Output Selection

No. (Hex.)	Name	Description	Default Setting (Range)
F5-03 (039B)	Terminal P3-PC Output Selection	<div style="display: flex; justify-content: space-between; font-size: small;"> V/f CL-V/f OLV CLV AOLV OLV/PM AOLV/PM CLV/PM EZOLV </div> <p>The function output from terminal P3-PC on the DO-A3 card is selected by the MFDO setting value. This parameter is enabled when $F5-09 = 2$ [DO-A3 Output Mode Selection = 8 channel select(F5-01 to F5-08)].</p>	2 (0 - 1A7)

■ F5-04: Terminal P4-PC Output Selection

No. (Hex.)	Name	Description	Default Setting (Range)
F5-04 (039C)	Terminal P4-PC Output Selection	<div style="display: flex; justify-content: space-between; font-size: small;"> V/f CL-V/f OLV CLV AOLV OLV/PM AOLV/PM CLV/PM EZOLV </div> <p>The function output from terminal P4-PC on the DO-A3 card is selected by the MFDO setting value. This parameter is enabled when $F5-09 = 2$ [DO-A3 Output Mode Selection = 8 channel select(F5-01 to F5-08)].</p>	4 (0 - 1A7)

■ F5-05: Terminal P5-PC Output Selection

No. (Hex.)	Name	Description	Default Setting (Range)
F5-05 (039D)	Terminal P5-PC Output Selection	<div style="display: flex; justify-content: space-between; font-size: 0.8em; font-weight: bold;"> V/f CL-V/f OLV CLV AOLV OLV/IPM AOLV/IPM CLV/IPM EZOLV </div> <p>The function output from terminal P5-PC on the DO-A3 card is selected by the MFDO setting value. This parameter is enabled when $F5-09 = 2$ [<i>DO-A3 Output Mode Selection = 8 channel select(F5-01 to F5-08)</i>].</p>	6 (0 - 1A7)

■ F5-06: Terminal P6-PC Output Selection

No. (Hex.)	Name	Description	Default Setting (Range)
F5-06 (039E)	Terminal P6-PC Output Selection	<div style="display: flex; justify-content: space-between; font-size: 0.8em; font-weight: bold;"> V/f CL-V/f OLV CLV AOLV OLV/IPM AOLV/IPM CLV/IPM EZOLV </div> <p>The function output from terminal P6-PC on the DO-A3 card is selected by the MFDO setting value. This parameter is enabled when $F5-09 = 2$ [<i>DO-A3 Output Mode Selection = 8 channel select(F5-01 to F5-08)</i>].</p>	37 (0 - 1A7)

■ F5-07: Terminal M1-M2 Output Selection

No. (Hex.)	Name	Description	Default Setting (Range)
F5-07 (039F)	Terminal M1-M2 Output Selection	<div style="display: flex; justify-content: space-between; font-size: 0.8em; font-weight: bold;"> V/f CL-V/f OLV CLV AOLV OLV/IPM AOLV/IPM CLV/IPM EZOLV </div> <p>Selects the function output from terminal M3-M2 on the DO-A3 card by the setting value for the multi-function digital output. This parameter is enabled when $F5-09 = 2$ [<i>DO-A3 Output Mode Selection = 8 channel select(F5-01 to F5-08)</i>].</p>	F (0 - 1A7)

■ F5-08: Terminal M3-M4 Output Selection

No. (Hex.)	Name	Description	Default Setting (Range)
F5-08 (03A0)	Terminal M3-M4 Output Selection	<div style="display: flex; justify-content: space-between; font-size: 0.8em; font-weight: bold;"> V/f CL-V/f OLV CLV AOLV OLV/IPM AOLV/IPM CLV/IPM EZOLV </div> <p>Selects the function output from terminal M3-M4 on the DO-A3 card by the setting value for the multi-function digital output. This parameter is enabled when $F5-09 = 2$ [<i>DO-A3 Output Mode Selection = 8 channel select(F5-01 to F5-08)</i>].</p>	F (0 - 1A7)

■ F5-09: DO-A3 Output Mode Selection

No. (Hex.)	Name	Description	Default Setting (Range)
F5-09 (03A1)	DO-A3 Output Mode Selection	<div style="display: flex; justify-content: space-between; font-size: 0.8em; font-weight: bold;"> V/f CL-V/f OLV CLV AOLV OLV/IPM AOLV/IPM CLV/IPM EZOLV </div> <p>Selects the output mode of signals output from the DO-A3 card.</p>	0 (0 - 2)

Refer to [Table 11.39](#) for more information.

0 : 8 channel individual

1 : Binary code output

2 : 8 channel select(F5-01 to F5-08)

◆ F6, F7: Communication Options

F6 and *F7* parameters are used to set the basic communication settings and method of fault detection for the communication option card. The communication option card parameters include common option card parameters and communication protocol-specific parameters.

The following table lists the parameters that need to be set for each communication option card.

Refer to the technical manual for each communication option card for more information on installing, wiring, and configuring the details needed before starting communication.

WARNING! *Sudden Movement Hazard. Perform test runs and periodic inspections to ensure that command references are configured appropriately. Incorrect configuration of the command reference can cause unintended motor rotation, which may lead to equipment damage or injury.*

Table 11.41 Correspondence Between Communication Protocols and Parameters (SI-CB, SI-T3, SI-ET3, SI-P3, SI-S3, and SI-ES3)

Parameters	CC-Link SI-C3	MECHATRO LINK-II SI-T3	MECHATRO LINK-III SI-ET3	PROFIBUS-DP SI-P3	CANopen SI-S3	EtherCAT SI-ES3
F6-01 to F6-03	x	x	x	x	x	x
F6-04	x	-	-	-	-	-
F6-06 to F6-08	x	x	x	x	x	x
F6-10 and F6-11	x	-	-	-	-	-
F6-14	x	x	x	x	x	x
F6-16	x	x	x	x	x	x
F6-20 and F6-21	-	x	x	-	-	-
F6-22	-	x	-	-	-	-
F6-23 to F6-26	-	x	x	-	-	-
F6-30 to F6-32	-	-	-	x	-	-
F6-35 and F6-36	-	-	-	-	x	-
F6-45 to F6-49	-	-	-	-	-	-
F6-50 to F6-71	-	-	-	-	-	-
F7-01 to F7-15	-	-	-	-	-	-
F7-16	-	-	-	-	-	-
F7-17 to F7-42	-	-	-	-	-	-
F7-60 to F7-79	-	-	-	x	-	-

Table 11.42 Correspondence Between Communication Protocols and Parameters (SI-CB, SI-N3, SI-W3, SI-EM3, SI-EP3, and SI-EN3)

Parameters	DeviceNet SI-N3	LonWorks SI-W3	Modbus TCP/IP SI-EM3	PROFINET SI-EP3	EtherNet/IP SI-EN3
F6-01 to F6-03	x	x	x	x	x
F6-04	-	-	-	-	-
F6-06 to F6-08	x	x	x	x	x
F6-10 and F6-11	-	-	-	-	-
F6-14	x	x	x	x	x
F6-16	x	x	x	x	x
F6-20 and F6-21	-	-	-	-	-
F6-22	-	-	-	-	-
F6-23 to F6-26	-	-	-	-	-
F6-30 to F6-32	-	-	-	-	-
F6-35 and F6-36	-	-	-	-	-
F6-45 to F6-49	-	-	-	-	-
F6-50 to F6-71	x	-	-	-	-
F7-01 to F7-15	-	-	x	x	x
F7-16	-	-	x	-	-
F7-17 to F7-42	-	-	-	x	x
F7-60 to F7-79	-	-	-	-	-

■ F6-01: Communication Error Selection

No. (Hex.)	Name	Description	Default (Range)
F6-01 (03A2)	Communication Error Selection	<div style="display: flex; justify-content: space-between; font-size: 0.8em; font-weight: bold; margin-bottom: 5px;"> V/f CL-V/f OLV CLV AOLV OLV/PM AOLV/PM CLV/PM EZOLV </div> Selects the operation of the drive when <i>bUS</i> [Option Communication Error] is detected.	1 (0 - 5)

0 : Ramp to stop

The drive ramps the motor to stop according to the deceleration time. The terminal turns on when $H2-xx = E$ [MFDO Function Select = Fault] is set.

1 : Coast to stop

The drive shuts off output and the motor coasts to stop. The terminal turns on when $H2-xx = E$.

2 : Fast Stop (use C1-09)

The drive stops the motor using the deceleration time set in *C1-09* [Fast Stop Time]. The terminal turns on when $H2-xx = E$.

3 : Alarm only

bUS appears on the keypad, and operation continues in accordance with the current frequency reference.

Note:

Prepare safety protection equipment and systems such as fast stop switches separately.

4 : Alarm - run at *d1-04*

bUS appears on the keypad, and operation continues at the speed set in *d1-04* [Reference 4].

Note:

Prepare safety protection equipment and systems such as fast stop switches separately.

5 : Alarm - Ramp Stop

The motor is stopped during the deceleration time set in *C1-02* [Deceleration Time 1] when *bUS* issues are detected.

When the *bUS* state clears, acceleration starts to return to the previous frequency reference.

■ F6-02: Comm External Fault (EF0) Detect

No. (Hex.)	Name	Description	Default Setting (Range)
F6-02 (03A3)	Comm External Fault (EF0) Detect	<div style="display: flex; justify-content: space-between; font-size: 0.8em; font-weight: bold; margin-bottom: 5px;"> V/f CL-V/f OLV CLV AOLV OLV/PM AOLV/PM CLV/PM EZOLV </div> Selects the conditions at which <i>EF0</i> [Option Card External Fault] is detected.	0 (0, 1)

0 : Always detected

1 : Detection during run only

■ F6-03: Comm External Fault (EF0) Select

No. (Hex.)	Name	Description	Default Setting (Range)
F6-03 (03A4)	Comm External Fault (EF0) Select	<div style="display: flex; justify-content: space-between; font-size: 0.8em; font-weight: bold; margin-bottom: 5px;"> V/f CL-V/f OLV CLV AOLV OLV/PM AOLV/PM CLV/PM EZOLV </div> Selects the operation of the drive when <i>EF0</i> [Option Card External Fault] is detected.	1 (0 - 3)

0 : Ramp to stop

The drive ramps the motor to stop according to the deceleration time. The terminal turns on when $H2-xx = E$ [MFDO Function Select = Fault] is set.

1 : Coast to stop

The output shuts off and the motor coasts to stop. The terminal turns on when $H2-xx = E$.

2 : Fast Stop (use C1-09)

The drive stops the motor using the deceleration time set in *C1-09* [Fast Stop Time]. The terminal turns on when $H2-xx = E$.

3 : Alarm only

bUS appears on the keypad, and operation continues.

Note:

Prepare safety protection equipment and systems such as fast stop switches separately.

■ F6-04: bUS Error Detection Time

No. (Hex.)	Name	Description	Default Setting (Range)
F6-04 (03A5)	bUS Error Detection Time	<input type="checkbox"/> V/f <input type="checkbox"/> CL-V/f <input type="checkbox"/> OLV <input type="checkbox"/> CLV <input type="checkbox"/> AOLV <input type="checkbox"/> OLV/PM <input type="checkbox"/> AOLV/PM <input type="checkbox"/> CLV/PM <input type="checkbox"/> EZOLV Sets the delay time until <i>bUS</i> [Option Communication Error] issues are detected.	2.0 s (0.0 - 5.0 s)

Note:

The setting value changes to 0.0 s when the option card is mounted in the drive.

■ F6-06: Torque Reference/Limit by Comm

No. (Hex.)	Name	Description	Default Setting (Range)
F6-06 (03A7)	Torque Reference/Limit by Comm	<input type="checkbox"/> V/f <input type="checkbox"/> CL-V/f <input type="checkbox"/> OLV <input type="checkbox"/> CLV <input type="checkbox"/> AOLV <input type="checkbox"/> OLV/PM <input type="checkbox"/> AOLV/PM <input type="checkbox"/> CLV/PM <input type="checkbox"/> EZOLV Selects whether to enable or disable the torque reference and torque limit received from the communication option card.	0 (0, 1)

0 : Disabled

1 : Enabled

■ F6-07: Multi-Step Ref @ NetRef/ComRef

No. (Hex.)	Name	Description	Default Setting (Range)
F6-07 (03A8)	MultiStep Ref Priority Select	<input type="checkbox"/> V/f <input type="checkbox"/> CL-V/f <input type="checkbox"/> OLV <input type="checkbox"/> CLV <input type="checkbox"/> AOLV <input type="checkbox"/> OLV/PM <input type="checkbox"/> AOLV/PM <input type="checkbox"/> CLV/PM <input type="checkbox"/> EZOLV Selects whether to enable/disable the multi-step speed reference when NetRef (communication option card) or ComRef (MEMOBUS/Modbus communications) is selected as the frequency reference source.	0 (0, 1)

0 : MultiStep References Disabled

The multi-step speed reference (2-step speed to 16-step speed references) and the Jog Frequency Reference (JOG command) are disabled when NetRef or ComRef is selected as the frequency reference source.

1 : MultiStep References Enabled

The multi-step speed reference (2-step speed through 16-step speed references) and the Jog Frequency Reference (JOG command) are enabled, and the frequency reference can be changed when NetRef or ComRef is selected as the frequency reference source.

■ F6-08: Comm Parameter Reset @Initialize

No. (Hex.)	Name	Description	Default Setting (Range)
F6-08 (036A)	Comm Parameter Reset @Initialize	<input type="checkbox"/> V/f <input type="checkbox"/> CL-V/f <input type="checkbox"/> OLV <input type="checkbox"/> CLV <input type="checkbox"/> AOLV <input type="checkbox"/> OLV/PM <input type="checkbox"/> AOLV/PM <input type="checkbox"/> CLV/PM <input type="checkbox"/> EZOLV Selects whether or not to initialize <i>communication parameters</i> [F6-xx and F7-xx] when the drive is initialized by A1-03 [Initialize Parameters].	0 (0, 1)

Note:

The setting value of F6-08 is not changed when the drive is initialized by A1-03 when F6-08 = 1.

0 : No Reset - parameters retained

1 : Reset - back to factory default

■ F6-10: CC-Link Node Address

No. (Hex.)	Name	Description	Default Setting (Range)
F6-10 (03B6)	CC-Link Node Address	<input type="checkbox"/> V/f <input type="checkbox"/> CL-V/f <input type="checkbox"/> OLV <input type="checkbox"/> CLV <input type="checkbox"/> AOLV <input type="checkbox"/> OLV/PM <input type="checkbox"/> AOLV/PM <input type="checkbox"/> CLV/PM <input type="checkbox"/> EZOLV Sets the node address for CC-Link communication. The drive must be restarted when the setting is changed.	0 (0 - 64)

Note:

Set a node address that is unique. Do not set this parameter to a value of 0. If the parameter is set incorrectly, the L.ERR LED on the option card is lit, and the drive will detect the *AER* [Station Address Setting Error].

A total of 42 nodes can be connected if only the drive is connected. The following conditions must be satisfied when connecting devices other than drives.

- $\{(1 \times a) + (2 \times b) + (3 \times c) + (4 \times d)\} \leq 64$
(a: number of units that occupies 1 node, b: number of units that occupies 2 nodes, c: number of units that occupies 3 nodes, d: number of units that occupies 4 nodes)
- $\{(16 \times A) + (54 \times B) + (88 \times C)\} \leq 2304$
(A: number of remote I/O nodes (64 max.), B: number of remote device nodes (42 max.), C: number of local nodes (26 max.))

■ **F6-11: CC-Link Communication Speed**

No. (Hex.)	Name	Description	Default Setting (Range)
F6-11 (03B7)	CC-Link Communication Speed	<div style="display: flex; justify-content: space-between; font-size: 0.8em; font-weight: bold;"> V/f CL-V/f OLV CLV AOLV OLV/PM AOLV/PM CLV/PM EZOLV </div> Selects the communication speed for CC-Link communication. The drive must be restarted when the setting is changed.	0 (0 - 4)

- 0 : 156 kbps**
- 1 : 625 kbps**
- 2 : 2.5 Mbps**
- 3 : 5 Mbps**
- 4 : 10 Mbps**

■ **F6-14: BUS Error Auto Reset**

No. (Hex.)	Name	Description	Default Setting (Range)
F6-14 (03BB)	CC-Link bUS Error Auto Reset	<div style="display: flex; justify-content: space-between; font-size: 0.8em; font-weight: bold;"> V/f CL-V/f OLV CLV AOLV OLV/PM AOLV/PM CLV/PM EZOLV </div> Selects whether to enable or disable the automatic reset of <i>bUS</i> [Option Communication Error] issues.	0 (0, 1)

- 0 : Disabled**
- 1 : Enabled**

■ **F6-16: Gateway Mode**

No. (Hex.)	Name	Description	Default (Range)
F6-16 (0B8A)	Gateway Mode	<div style="display: flex; justify-content: space-between; font-size: 0.8em; font-weight: bold;"> V/f CL-V/f OLV CLV AOLV OLV/PM AOLV/PM CLV/PM EZOLV </div> Configures the operation mode of the gateway mode and the number of connected slave drives.	0 (0 to 4)

- 0 : Uses the drive as a slave drive or disables the gateway mode.**
- 1 : Uses the drive as a master drive (slave drives: 1).**
- 2 : Uses the drive as a master drive (slave drives: 2).**
- 3 : Uses the drive as a master drive (slave drives: 3).**
- 4 : Uses the drive as a master drive (slave drives: 4).**

The gateway mode performs communications processing to relay data from a drive equipped with the communication option to multiple drives not equipped with the communication option via the internal RS-485 communication function. This enables up to a maximum of 5 drives to be connected via fieldbus communication using only one communication option. The following commands and responses are exchanged between the controller (Host device), master drive (Drive 0), and the slave drives (Drive 1 through Drive 4).

- Commands: Run command and frequency reference
- Output frequency and drive status (running, faults)
- Reading and writing parameters
- Reading monitors

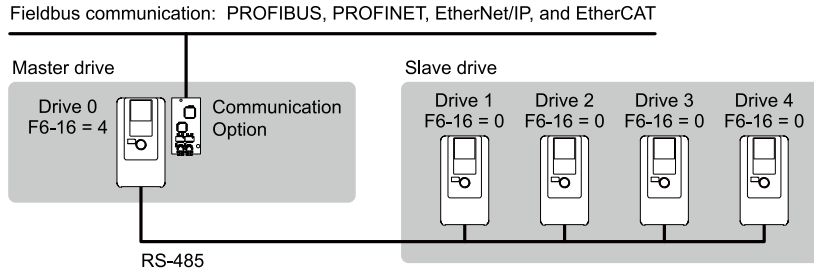

Note:

- Do not mount the communication option in slave drives when using the gateway mode.
- Doing so may disrupt synchronization of drive commands and responses.
- Response speed using the communication option is slower than when using point-to-point communications.
- Make sure H5-03 [Communication Parity Selection] is set to the same value on both the master drive and slave drives.

The following example illustrates the parameter settings when connecting four slave drives.

	F6-16 [Gateway Mode]	H5-01 [Station Address]	H5-02 [Communication Speed Selection]	H5-03 [Communication Parity Selection]	H5-06 [Drive Transmit Wait Time]	H5-09 [CE Detection Time]	b1-01 [Frequency Reference Selection 1]	b1-02 [Run Command Selection 1]
Drive0 (Master Drive)	1 - 4 *1	1F (Default value)	*2	*2	5 ms *3	At least 2.0 seconds *4	3 [Option PCB]	3 [Option PCB]
Drive1 (Slave Drive 1)	0	01	*2	*2	5 ms *3	At least 0.9 seconds *4	2 [MEMOBUS/Modbus Communications] *5	2 [MEMOBUS/Modbus Communications] *5
Drive2 (Slave Drive 2)	0	02	*2	*2	5 ms *3	At least 0.9 seconds *4	2 [MEMOBUS/Modbus Communications] *5	2 [MEMOBUS/Modbus Communications] *5
Drive3 (Slave Drive 3)	0	03	*2	*2	5 ms *3	At least 0.9 seconds *4	2 [MEMOBUS/Modbus Communications] *5	2 [MEMOBUS/Modbus Communications] *5
Drive4 (Slave Drive 4)	0	04	*2	*2	5 ms *3	At least 0.9 seconds *4	2 [MEMOBUS/Modbus Communications] *5	2 [MEMOBUS/Modbus Communications] *5

- *1 Configure the number of connected slave drives.
- *2 Make sure the communications speed and communications parity are set to the same value on both the master drive and slave drives.
- *3 Do not change the value of H5-06 from the default value to correctly detect the response timeout.
- *4 Set H5-09 to a value of at least 0.9 seconds. When configured such that H5-09 < 0.9, CE will be detected before the response timeout is detected.
- *5 Set the run command and frequency reference source on slave drives to MEMOBUS/Modbus communications.

Note:

- The master drive stops transmitting to the slave drives when timeouts or message errors occur consecutively for 10 times. Input the fault reset command to restart communication.
- If the access command is changed before the MEMOBUS/Modbus access completion flag turns on, the previous command may not be executed.

Special Register Specifications

Table 11.43 Command Data

Register No.	Description	
1	Command source update (15C5H)	
	This flag enables command updates.	
	bit 0	Drive 1 Update Command Enabled
	To input both the run command and frequency reference simultaneously, change the bit value from 0 to 1 after all commands have been written.	
	bit 1	Drive 2 Update Command Enabled
	bit 2	Drive 3 Update Command Enabled
	bit 3	Drive 4 Update Command Enabled
bit 4	Update Register Access Command Enabled	
bit 5 - F	Reserved	
2	Run Command (Drive 1) (15C6H)	
	bit 0	H5-12 = 0: FWD/Stop 0 = Stop 1 = Forward run
		H5-12 = 1: Run/Stop 0 = Stop 1 = Run
	bit 1	H5-12 = 0: REV/Stop 0 = Stop 1 = Reverse run
		H5-12 = 1: FWD/REV 0 = Forward run 1 = Reverse run
	bit 2	External fault
	bit 3	Fault Reset
	bit 4	ComRef
	bit 5	ComCtrl
	bit 6 - F	Reserved
3	Frequency Reference (Drive 1) (15C7H)	The unit of measure varies depending on the setting of o1-03.
4	Run Command (Drive 2) (15C8H)	
5	Frequency Reference (Drive 2) (15C9H)	
6	Run Command (Drive 3) (15CAH)	
7	Frequency Reference (Drive 3) (15CBH)	
8	Run Command (Drive 4) (15CCH)	
9	Frequency Reference (Drive 4) (15CDH)	

Register No.	Description	
10	Slave Address for Reg. Access + Read/Write (15CEH)	
	bit 0	Slave address 0: Broadcast Messages (MEMOBUS) 1: Drive 1
	bit 1	2: Drive 2
	bit 2	3: Drive 3
	bit 3	4: Drive 4 5: Broadcast Messages (run command and frequency reference)
	bit 4	0: Read, 1: Write
	bit 5 - F	Reserved
11	Register number (15CFH)	
12	Data (write register) (15D0H)	

Table 11.44 Monitor Data

Register No.	Description		
1	Command source update (15C5H)		
	bit 0	During run	
	bit 1	During Reverse Run	
	bit 2	Drive ready	
	bit 3	Fault	
	bit 4	Frequency Command Setting Fault	1: Upper/Lower Limit Fault
	bit 5	No response from slave	1: Response has timed out.
	bit 6	Communication Error	1: A fault has been detected from a slave.
	bit 7	No response from slave for 10 consecutive attempts.	1: Timeout has occurred for 10 consecutive times.
	bit 8	Communication fault has occurred for 10 consecutive times.	1: Fault has occurred from a slave for 10 consecutive times.
	bit 9	Receive broadcast command while drive is running	1: Drive operates in accordance with the broadcast message command.
	bit A	Communication error with master drive	1: Communication with the master will not be performed due to a communication error.
	bit B - D	Reserved	
	bit E	ComRef status	
bit F	ComCtrl status		
2	Output frequency or frequency reference (Drive Status Bit 4: ON) (Drive 1) (15E8) Drive Status Bit 4 = 0 [Output Frequency] Drive Status Bit 4 = 1 [Frequency Reference]	The unit of measure varies depending on the setting of o1-03.	
3	Drive Status (Drive 2) (15E9H)		
4	Output frequency or frequency reference (Drive Status Bit 4: ON) (Drive 2) (15EAH)		
5	Drive Status (Drive 3) (15EBH)		
6	Output frequency or frequency reference (Drive Status Bit 4: ON) (Drive 3) (15ECH)		
7	Drive Status (Drive 4) (15EDH)		
8	Output frequency or frequency reference (Drive Status Bit 4: ON) (Drive 4) (15EEH)		

Register No.	Description	
9	Slave Address for Reg. Access + During MEMOBUS process & ErrCode (15EFH)	
	bit 0	00H: MEMOBUS/Modbus Communication Complete
	bit 1	02H: Register number not registered
9	bit 2	21H: Upper/Lower Limit Fault
	bit 3	22H: Write Mode Error
	bit 4	23H: Write performed during occurrence of <i>Uv</i>
	bit 5	24H: Write performed while writing parameter settings
	bit 6	FFH: During MEMOBUS/Modbus Communication
	bit 7	
	bit 8	Slave address
	bit 9	0: MEMOBUS command ignored
9	bit A	1: Drive 1
		2: Drive 2
		4: Drive 3
		5: Drive 4
11	Register number (15F0H)	
12	Data (write register) (15F1H)	

■ **F6-20: MECHATROLINK Station Address**

No. (Hex.)	Name	Description	Default Setting (Range)
F6-20 (036B)	MECHATROLINK Station Address	<div style="display: flex; justify-content: space-between; font-size: small;"> V/f CL-V/f OLV CLV AOLV OLV/PM AOLV/PM CLV/PM EZOLV </div> <p>Sets the station address for MECHATROLINK communication. The drive must be restarted when the setting is changed.</p>	0021h (MECHATROLINK-II : 0020h - 003Fh , MECHATROLINK-III : 0003h - 00EFh)

Note:

- The setting range varies depending on the type of MECHATROLINK communication.
 - MECHATROLINK-II (SI-T3): 20 to 3F
 - MECHATROLINK-III (SI-ET3): 03 to EF
- Set a station address that is unique. If the parameter is set incorrectly, the ERR on the option card flashes, and the drive will detect the *AEr* [Station Address Setting Error].
- An *AEr* is triggered when the station address is set to either 20 or 3F.

■ **F6-21: MECHATROLINK Frame Size**

No. (Hex.)	Name	Description	Default Setting (Range)
F6-21 (036C)	MECHATROLINK Frame Size	<div style="display: flex; justify-content: space-between; font-size: small;"> V/f CL-V/f OLV CLV AOLV OLV/PM AOLV/PM CLV/PM EZOLV </div> <p>Sets the frame size for MECHATROLINK communication. The drive must be restarted when the setting is changed.</p>	0 (0, 1)

0 : 32-byte

1 : 17-byte

■ **F6-22: MECHATROLINK Link Speed**

No. (Hex.)	Name	Description	Default Setting (Range)
F6-22 (036D)	MECHATROLINK Link Speed	<div style="display: flex; justify-content: space-between; font-size: small;"> V/f CL-V/f OLV CLV AOLV OLV/PM AOLV/PM CLV/PM EZOLV </div> <p>Sets the communications speed for MECHATROLINK-II. The drive must be restarted when the setting is changed.</p>	0 (0, 1)

Note:

This parameter can only be used when the MECHATROLINK-II option is connected.

0 : 10 Mbps

1 : 4 Mbps

■ F6-23: MECHATROLINK Monitor Select (E)

No. (Hex.)	Name	Description	Default Setting (Range)
F6-23 (036E)	MECHATROLINK Monitor Select (E)	V/f CL-V/f OLV CLV AOLV OLV/PM AOLV/PM CLV/PM EZOLV Sets the MEMOBUS register used for the monitor functions of INV_CTL (drive operation control command) and INV_I/O (drive I/O control command). The drive must be restarted when the setting is changed.	0000h (0000h - FFFFh)

To enable the MEMOBUS register that is set with *F6-23*, set SEL_MON2/1 to 0EH or set SEL_MON 3/4 and SEL_MON 5/6 to 0EH. Bytes of the response data enable the MEMOBUS register content set with *F6-23*.

■ F6-24: MECHATROLINK Monitor Select (F)

No. (Hex.)	Name	Description	Default Setting (Range)
F6-24 (036F)	MECHATROLINK Monitor Select (F)	V/f CL-V/f OLV CLV AOLV OLV/PM AOLV/PM CLV/PM EZOLV Sets the MEMOBUS register used for the monitor functions of INV_CTL (drive operation control command) and INV_I/O (drive I/O control command). The drive must be restarted when the setting is changed.	0000h (0000h - FFFFh)

To enable the MEMOBUS register that is set with *F6-24*, set SEL_MON2/1 to 0FH or set SEL_MON3/4 and SEL_MON 5/6 to 0FH. Bytes of the response data enable the MEMOBUS register content set with *F6-24*.

■ F6-25: MECHATROLINK Watchdog Error Sel

No. (Hex.)	Name	Description	Default Setting (Range)
F6-25 (03C9)	MECHATROLINK Watchdog Error Sel	V/f CL-V/f OLV CLV AOLV OLV/PM AOLV/PM CLV/PM EZOLV Selects the motor operation when <i>E5</i> [MECHATROLINK Watchdog Timer Err] is detected.	1 (0 - 3)

0 : Ramp to stop

The drive ramps the motor to stop according to the deceleration time. The terminal turns on when *H2-xx = E* [MFDO Function Select = Fault] is set.

1 : Coast to stop

The drive shuts off output and the motor coasts to stop. The terminal turns on when *H2-xx = E*.

2 : Fast stop (use C1-09)

The drive stops the motor using the deceleration time set in *C1-09* [Fast Stop Time]. The terminal turns on when *H2-xx = E*.

3 : Alarm Only

E5 appears on the keypad, and the drive continues to operate.

Note:

Prepare safety protection equipment and systems such as fast stop switches separately.

■ F6-26: MECHATROLINK bUS Errors Detected

No. (Hex.)	Name	Description	Default Setting (Range)
F6-26 (03CA)	MECHATROLINK bUS Errors Detected	V/f CL-V/f OLV CLV AOLV OLV/PM AOLV/PM CLV/PM EZOLV <i>bUS</i> [Option Communication Error] is detected when the option card detects the <i>bUS</i> alarm for a number of times that exceeds the number set in <i>F6-26</i> .	2 times (2 to 10 times)

■ F6-30: PROFIBUS-DP Node Address

No. (Hex.)	Name	Description	Default Setting (Range)
F6-30 (03CB)	PROFIBUS-DP Node Address	V/f CL-V/f OLV CLV AOLV OLV/PM AOLV/PM CLV/PM EZOLV Sets the node address for PROFIBUS-DP communication. The drive must be restarted when the setting is changed.	0 (0 - 125)

Note:

- Set a node address that is unique. Do not set this parameter to a value of 0.
- Node addresses 0, 1, and 2 are normally reserved for control, maintenance, and device self-diagnosis.

■ F6-31: PROFIBUS-DP Clear Mode Selection

No. (Hex.)	Name	Description	Default Setting (Range)
F6-31 (03CC)	PROFIBUS-DP Clear Mode selection	V/f CL-V/f OLV CLV AOLV OLV/PM AOLV/PM CLV/PM EZOLV Selects the operation of the drive after the Clear mode command is received.	0 (0, 1)

0 : Reset

Resets the drive settings such as the frequency reference and I/O settings.

1 : Hold previous state

The drive holds the state before the command is received.

■ F6-32: PROFIBUS-DP Data Format Select

No. (Hex.)	Name	Description	Default Setting (Range)
F6-32 (03CD)	PROFIBUS-DP Data Format Select	V/f CL-V/f OLV CLV AOLV OLV/PM AOLV/PM CLV/PM EZOLV Selects the data format of PROFIBUS-DP communication. The drive must be restarted when the setting is changed.	0 (0 - 5)

Note:

The setting of *H5-11 [Communications ENTER Func Select]* determines whether the RAM enter is explicitly required or the RAM enter is executed automatically when writing parameters over network communication. When *F6-32 = 0, 1, or 2*, the RAM enter is not executed automatically regardless of the setting of *H5-11*.

0 : PPO Type

1 : Conventional

2 : PPO (bit0)

This function operates when both bit 0 and bit 4 in the register STW have values of 1 (operate). Refer to the PROFIBUS-DP communication technical manual for more information.

3 : PPO (Enter)

4 : Conv (Enter)

5 : PPO (bit0,Enter)

This function operates when both bit 0 and bit 4 in the register STW have values of 1 (operate). Refer to the PROFIBUS-DP communication technical manual for more information.

■ F6-35: CANopen Node ID Selection

No. (Hex.)	Name	Description	Default Setting (Range)
F6-35 (03D0)	CANopen Node ID Selection	V/f CL-V/f OLV CLV AOLV OLV/PM AOLV/PM CLV/PM EZOLV Sets the node address for CANopen communication. The drive must be restarted when the setting is changed.	0 (0 - 126)

Note:

Set a node address that is unique. Do not set this parameter to a value of 0. If the parameter is set incorrectly, the ERR on the option card flashes, and the drive will detect the *AEr [Station Address Setting Error]*.

■ F6-36: CANopen Communication Speed

No. (Hex.)	Name	Description	Default Setting (Range)
F6-36 (03D1)	CANopen Communication Speed	V/f CL-V/f OLV CLV AOLV OLV/PM AOLV/PM CLV/PM EZOLV Selects the communications speed for CANopen communication. The drive must be restarted when the setting is changed.	6 (0 - 8)

0 : Auto-detection

The drive detects the network communication speed and automatically adjusts the communications speed accordingly.

- 1 : 10 kbps
- 2 : 20 kbps
- 3 : 50 kbps
- 4 : 125 kbps
- 5 : 250 kbps
- 6 : 500 kbps
- 7 : 800 kbps
- 8 : 1 Mbps

■ F6-45: BACnet Node Address

No. (Hex.)	Name	Description	Default Setting (Range)
F6-45 (02FB)	BACnet Node Address	<input type="checkbox"/> V/f <input type="checkbox"/> CL-V/f <input type="checkbox"/> OLV <input type="checkbox"/> CLV <input type="checkbox"/> AOLV <input type="checkbox"/> OLV/PM <input type="checkbox"/> AOLV/PM <input type="checkbox"/> CLV/PM <input type="checkbox"/> EZOLV Sets the node address for BACnet communication.	1 (0 - 127)

■ F6-46: BACnet Baud Rate

No. (Hex.)	Name	Description	Default Setting (Range)
F6-46 (02FC)	BACnet Baud Rate	<input type="checkbox"/> V/f <input type="checkbox"/> CL-V/f <input type="checkbox"/> OLV <input type="checkbox"/> CLV <input type="checkbox"/> AOLV <input type="checkbox"/> OLV/PM <input type="checkbox"/> AOLV/PM <input type="checkbox"/> CLV/PM <input type="checkbox"/> EZOLV Sets the BACnet communications speed.	3 (0 - 8)

- 0 : 1200 bps
- 1 : 2400 bps
- 2 : 4800 bps
- 3 : 9600 bps
- 4 : 19.2 kbps
- 5 : 38.4 kbps
- 6 : 57.6 kbps
- 7 : 76.8 kbps
- 8 : 115.2 kbps

■ F6-47: Rx to Tx Wait Time

No. (Hex.)	Name	Description	Default Setting (Range)
F6-47 (02FD)	Rx to Tx Wait Time	<input type="checkbox"/> V/f <input type="checkbox"/> CL-V/f <input type="checkbox"/> OLV <input type="checkbox"/> CLV <input type="checkbox"/> AOLV <input type="checkbox"/> OLV/PM <input type="checkbox"/> AOLV/PM <input type="checkbox"/> CLV/PM <input type="checkbox"/> EZOLV Sets the wait time for reception and transmission of BACnet communication.	5 ms (5 - 65 ms)

■ F6-48: BACnet Device Object Identifier0

No. (Hex.)	Name	Description	Default Setting (Range)
F6-48 (02FE)	BACnet Device Object Identifier0	<input type="checkbox"/> V/f <input type="checkbox"/> CL-V/f <input type="checkbox"/> OLV <input type="checkbox"/> CLV <input type="checkbox"/> AOLV <input type="checkbox"/> OLV/PM <input type="checkbox"/> AOLV/PM <input type="checkbox"/> CLV/PM <input type="checkbox"/> EZOLV Sets the last word of addresses for BACnet communication.	0 (0 - FFFF)

■ F6-49: BACnet Device Object Identifier1

No. (Hex.)	Name	Description	Default Setting (Range)
F6-49 (02FF)	BACnet Device Object Identifier1	<input type="checkbox"/> V/f <input type="checkbox"/> CL-V/f <input type="checkbox"/> OLV <input type="checkbox"/> CLV <input type="checkbox"/> AOLV <input type="checkbox"/> OLV/PM <input type="checkbox"/> AOLV/PM <input type="checkbox"/> CLV/PM <input type="checkbox"/> EZOLV Sets the last word of addresses for BACnet communication.	0 (0 - 3F)

■ F6-50: DeviceNet MAC Address

No. (Hex.)	Name	Description	Default Setting (Range)
F6-50 (03C1)	DN MAC Address	<div style="display: flex; justify-content: space-between; font-size: 0.8em; font-weight: bold; margin-bottom: 5px;"> V/f CL-V/f OLV CLV AOLV OLV/PM AOLV/PM CLV/PM EZOLV </div> Sets the MAC address for DeviceNet communication. The drive must be restarted when the setting is changed.	0 (0 - 64)

Note:

Set a MAC address that is unique. Do not set this parameter to a value of 0. If the parameter is set incorrectly, the ERR on the option card flashes, and the drive will detect the *AEr* [Station Address Setting Error].

■ F6-51: DeviceNet Baud Rate

No. (Hex.)	Name	Description	Default Setting (Range)
F6-51 (03C2)	DN Baud Rate	<div style="display: flex; justify-content: space-between; font-size: 0.8em; font-weight: bold; margin-bottom: 5px;"> V/f CL-V/f OLV CLV AOLV OLV/PM AOLV/PM CLV/PM EZOLV </div> Selects the communications speed for DeviceNet communication. The drive must be restarted when the setting is changed.	0 (0 - 4)

0 : 125 kbps

1 : 250 kbps

2 : 500 kbps

3 : Adjustable from network

The communications speed is set by the controller.

4 : Detect automatically

The drive detects the network communication speed and automatically adjusts the communications speed accordingly.

■ F6-52: DeviceNet PCA Setting

No. (Hex.)	Name	Description	Default Setting (Range)
F6-52 (03C3)	DeviceNet PCA Setting	<div style="display: flex; justify-content: space-between; font-size: 0.8em; font-weight: bold; margin-bottom: 5px;"> V/f CL-V/f OLV CLV AOLV OLV/PM AOLV/PM CLV/PM EZOLV </div> Sets the format of data sent from the DeviceNet communication master to the drive.	21 (0 - 255)

Note:

The setting value will be reset to default settings if the combination of F6-52 [DeviceNet PCA Setting] and F6-53 [DeviceNet PPA Setting] is not correct.

■ F6-53: DeviceNet PPA Setting

No. (Hex.)	Name	Description	Default Setting (Range)
F6-53 (03C4)	DeviceNet PPA Setting	<div style="display: flex; justify-content: space-between; font-size: 0.8em; font-weight: bold; margin-bottom: 5px;"> V/f CL-V/f OLV CLV AOLV OLV/PM AOLV/PM CLV/PM EZOLV </div> Sets the format of data sent from the drive to the DeviceNet communication master.	71 (0 - 255)

Note:

The setting value will be reset to default settings if the combination of F6-52 [DeviceNet PCA Setting] and F6-53 [DeviceNet PPA Setting] is not correct.

■ F6-54: DeviceNet Idle Fault Detection

No. (Hex.)	Name	Description	Default Setting (Range)
F6-54 (03C5)	DN Idle Flt Det	<div style="display: flex; justify-content: space-between; font-size: 0.8em; font-weight: bold; margin-bottom: 5px;"> V/f CL-V/f OLV CLV AOLV OLV/PM AOLV/PM CLV/PM EZOLV </div> Selects whether or not to detect issues of <i>EF0</i> [Option Card External Fault] when data is not received from the DeviceNet master.	0 (0 - 4)

0 : Enabled

1 : Disabled, no fault detection

An *EF0* is not detected.

■ F6-55: DeviceNet BAUD RATE MEM

No. (Hex.)	Name	Description	Default Setting (Range)
F6-55 (03C6)	DN BAUD RATE MEM	<div style="display: flex; justify-content: space-between; font-size: 0.8em; font-weight: bold;"> V/f CL-V/f OLV CLV AOLV OLV/PM AOLV/PM CLV/PM EZOLV </div> <p>This parameter is used to enable confirmation of the currently valid communications speed for DeviceNet communication via the keypad. This parameter is used for monitoring only.</p>	0 (0 - 2)

0 : 125 kbps

1 : 250 kbps

2 : 500 kbps

■ F6-56: DeviceNet Speed Scaling

No. (Hex.)	Name	Description	Default Setting (Range)
F6-56 (03D7)	DeviceNet Speed Scaling	<div style="display: flex; justify-content: space-between; font-size: 0.8em; font-weight: bold;"> V/f CL-V/f OLV CLV AOLV OLV/PM AOLV/PM CLV/PM EZOLV </div> <p>Sets the speed scale for DeviceNet communication.</p>	0 (-15 - +15)

■ F6-57: DeviceNet Current Scaling

No. (Hex.)	Name	Description	Default Setting (Range)
F6-57 (03D8)	DeviceNet Current Scaling	<div style="display: flex; justify-content: space-between; font-size: 0.8em; font-weight: bold;"> V/f CL-V/f OLV CLV AOLV OLV/PM AOLV/PM CLV/PM EZOLV </div> <p>Sets the current scale of the DeviceNet communication master.</p>	0 (-15 - +15)

■ F6-58: DeviceNet Torque Scaling

No. (Hex.)	Name	Description	Default Setting (Range)
F6-58 (03D9)	DeviceNet Torque Scaling	<div style="display: flex; justify-content: space-between; font-size: 0.8em; font-weight: bold;"> V/f CL-V/f OLV CLV AOLV OLV/PM AOLV/PM CLV/PM EZOLV </div> <p>Sets the torque scale of the DeviceNet communication master.</p>	0 (-15 - +15)

■ F6-59: DeviceNet Power Scaling

No. (Hex.)	Name	Description	Default Setting (Range)
F6-59 (03DA)	DeviceNet Power Scaling	<div style="display: flex; justify-content: space-between; font-size: 0.8em; font-weight: bold;"> V/f CL-V/f OLV CLV AOLV OLV/PM AOLV/PM CLV/PM EZOLV </div> <p>Sets the power scale of the DeviceNet communication master.</p>	0 (-15 - +15)

■ F6-60: DeviceNet Voltage Scaling

No. (Hex.)	Name	Description	Default Setting (Range)
F6-60 (03DB)	DeviceNet Voltage Scaling	<div style="display: flex; justify-content: space-between; font-size: 0.8em; font-weight: bold;"> V/f CL-V/f OLV CLV AOLV OLV/PM AOLV/PM CLV/PM EZOLV </div> <p>Sets the voltage scale of the DeviceNet communication master.</p>	0 (-15 - +15)

■ F6-61: DeviceNet Time Scaling

No. (Hex.)	Name	Description	Default Setting (Range)
F6-61 (03DC)	DeviceNet Time Scaling	<div style="display: flex; justify-content: space-between; font-size: 0.8em; font-weight: bold;"> V/f CL-V/f OLV CLV AOLV OLV/PM AOLV/PM CLV/PM EZOLV </div> <p>Sets the time scale of the DeviceNet communication master.</p>	0 (-15 - +15)

■ F6-62: DeviceNet Heartbeat Interval

No. (Hex.)	Name	Description	Default Setting (Range)
F6-62 (03DD)	DeviceNet Heartbeat Interval	V/f CL-V/f OLV CLV AOLV OLV/PM AOLV/PM CLV/PM EZOLV Sets the Heart Beat for DeviceNet communication. A setting of 0 disables the Heart Beat function.	0 (0 - 10)

■ F6-63: DeviceNet Network MAC ID

No. (Hex.)	Name	Description	Default Setting (Range)
F6-63 (03DE)	DeviceNet Network MAC ID	V/f CL-V/f OLV CLV AOLV OLV/PM AOLV/PM CLV/PM EZOLV This parameter is used to enable confirmation of the currently valid MAC address for DeviceNet communication via the keypad. This parameter is used for monitoring only.	0 (0 - 63)

■ F6-64 to F6-67: Dynamic Out Assembly 109 Param1 to 4

No. (Hex.)	Name	Description	Default Setting (Range)
F6-64 through F6-67 (03DF to 03E2)	Dynamic Output Assembly 109 Programmable Output 1 through 4	V/f CL-V/f OLV CLV AOLV OLV/PM AOLV/PM CLV/PM EZOLV Sets the Configurable Output 1 through 4 written to the MEMOBUS register.	0000h (0000h - FFFFh)

■ F6-68 to F6-71: Dynamic In Assembly 159 Param 1 to 4

No. (Hex.)	Name	Description	Default Setting (Range)
F6-68 through F6-71 (03E3, 03E4, 03C7, and 03C8)	Dynamic Input Assembly 159 Programmable Input 1 to 4	V/f CL-V/f OLV CLV AOLV OLV/PM AOLV/PM CLV/PM EZOLV Sets the Configurable Input 1 through 4 loaded from the MEMOBUS register.	0000h (0000h - FFFFh)

■ F6-72: PowerLink Node Address

No. (Hex.)	Name	Description	Default Setting (Range)
F6-72 (081B)	PowerLink Node Address	V/f CL-V/f OLV CLV AOLV OLV/PM AOLV/PM CLV/PM EZOLV Sets the node ID for PowerLink communication.	0 (0 - 255)

■ F7-01: IP Address 1

No. (Hex.)	Name	Description	Default (Range)
F7-01 (03E5)	IP Address 1	V/f CL-V/f OLV CLV AOLV OLV/PM AOLV/PM CLV/PM EZOLV Sets the IP Address of the device used to connect to the network. Sets the first octet. The drive must be restarted when the setting is changed.	192 (0 to 255)

Note:

- Set the IP Address using F7-01 to F7-04 [IP Address 4] when F7-13 = 0 [Address Mode at Startup = Static]. Set an IP Addresses that is unique.
- Be sure to set F7-01 to F7-12 when F7-13 = 0.

■ F7-02: IP Address 2

No. (Hex.)	Name	Description	Default Setting (Range)
F7-02 (03E6)	IP Address 2	V/f CL-V/f OLV CLV AOLV OLV/PM AOLV/PM CLV/PM EZOLV Sets the IP Address of the device used to connect to the network. Sets the second octet. The drive must be restarted when the setting is changed.	168 (0 to 255)

Note:

- Set the IP Address using *F7-01 to F7-04 [IP Address 1 to IP Address 4]* when *F7-13 = 0 [Address Mode at Startup = Static]*. Set an IP Addresses that is unique.
- Be sure to set *F7-01 to F7-12* when *F7-13 = 0*.

■ F7-03: IP Address 3

No. (Hex.)	Name	Description	Default Setting (Range)
F7-03 (03E7)	IP Address 3	V/f CL-V/f OLV CLV AOLV OLV/PM AOLV/PM CLV/PM EZOLV Sets the IP Address of the device used to connect to the network. Sets the third octet. The drive must be restarted when the setting is changed.	1 (0 to 255)

Note:

- Set the IP Address using *F7-01 to F7-04 [IP Address 1 to IP Address 4]* when *F7-13 = 0 [Address Mode at Startup = Static]*. Set an IP Addresses that is unique.
- Be sure to set *F7-01 to F7-12* when *F7-13 = 0*.

■ F7-04: IP Address 4

No. (Hex.)	Name	Description	Default Setting (Range)
F7-04 (03E8)	IP Address 4	V/f CL-V/f OLV CLV AOLV OLV/PM AOLV/PM CLV/PM EZOLV Sets the IP Address of the device used to connect to the network. Sets the fourth octet. The drive must be restarted when the setting is changed.	20 (0 to 255)

Note:

- Set the IP Address using *F7-01 to F7-04 [IP Address 1 to IP Address 4]* when *F7-13 = 0 [Address Mode at Startup = Static]*. Set an IP Addresses that is unique.
- Be sure to set *F7-01 to F7-12* when *F7-13 = 0*.

■ F7-05: Subnet Mask 1

No. (Hex.)	Name	Description	Default Setting (Range)
F7-05 (03E9)	Subnet Mask 1	V/f CL-V/f OLV CLV AOLV OLV/PM AOLV/PM CLV/PM EZOLV Sets the subnet mask of the connected network. Sets the first octet.	255 (0 to 255)

Note:

Be sure to set this parameter when *F7-13 = 0 [Address Mode at Startup = Static]*.

■ F7-06: Subnet Mask 2

No. (Hex.)	Name	Description	Default Setting (Range)
F7-06 (03EA)	Subnet Mask 2	V/f CL-V/f OLV CLV AOLV OLV/PM AOLV/PM CLV/PM EZOLV Sets the subnet mask of the connected network. Sets the second octet.	255 (0 to 255)

Note:

Be sure to set this parameter when *F7-13 = 0 [Address Mode at Startup = Static]*.

■ F7-07: Subnet Mask 3

No. (Hex.)	Name	Description	Default Setting (Range)
F7-07 (03EB)	Subnet Mask 3	V/f CL-V/f OLV CLV AOLV OLV/PM AOLV/PM CLV/PM EZOLV Sets the subnet mask of the connected network. Sets the third octet.	255 (0 to 255)

Note:

Be sure to set this parameter when *F7-13 = 0 [Address Mode at Startup = Static]*.

■ F7-08: Subnet Mask 4

No. (Hex.)	Name	Description	Default Setting (Range)
F7-08 (03EC)	Subnet Mask 4	V/f CL-V/f OLV CLV AOLV OLV/PM AOLV/PM CLV/PM EZOLV Sets the subnet mask of the connected network. Sets the fourth octet.	0 (0 to 255)

Note:

Be sure to set this parameter when $F7-13 = 0$ [Address Mode at Startup = Static].

■ F7-09: Gateway Address 1

No. (Hex.)	Name	Description	Default Setting (Range)
F7-09 (03ED)	Gateway Address 1	V/f CL-V/f OLV CLV AOLV OLV/PM AOLV/PM CLV/PM EZOLV Sets the Gateway address for the connected network. Sets the first octet.	192 (0 to 255)

Note:

Be sure to set this parameter when $F7-13 = 0$ [Address Mode at Startup = Static].

■ F7-10: Gateway Address 2

No. (Hex.)	Name	Description	Default Setting (Range)
F7-10 (03EE)	Gateway Address 2	V/f CL-V/f OLV CLV AOLV OLV/PM AOLV/PM CLV/PM EZOLV Sets the Gateway address for the connected network. Sets the second octet.	168 (0 to 255)

Note:

Be sure to set this parameter when $F7-13 = 0$ [Address Mode at Startup = Static].

■ F7-11: Gateway Address 3

No. (Hex.)	Name	Description	Default Setting (Range)
F7-11 (03EF)	Gateway Address 3	V/f CL-V/f OLV CLV AOLV OLV/PM AOLV/PM CLV/PM EZOLV Sets the Gateway address for the connected network. Sets the third octet.	1 (0 to 255)

Note:

Be sure to set this parameter when $F7-13 = 0$ [Address Mode at Startup = Static].

■ F7-12: Gateway Address 4

No. (Hex.)	Name	Description	Default Setting (Range)
F7-12 (03F0)	Gateway Address 4	V/f CL-V/f OLV CLV AOLV OLV/PM AOLV/PM CLV/PM EZOLV Sets the Gateway address for the connected network. Sets the fourth octet.	1 (0 to 255)

Note:

Be sure to set this parameter when $F7-13 = 0$ [Address Mode at Startup = Static].

■ F7-13: Address Mode at Startup

No. (Hex.)	Name	Description	Default Setting (Range)
F7-13 (03F1)	Address Mode at Startup	V/f CL-V/f OLV CLV AOLV OLV/PM AOLV/PM CLV/PM EZOLV Selects the method to set addresses for option cards.	2 (0 - 2)

0 : Static

1 : BOOTP

2 : DHCP

Note:

- The following setting values are available when using the PROFINET communication option card (SI-EP3).
0: Static
2: DCP
- Parameters F7-01 to F7-12 [IP Address 1 = Gateway Address 4] must be configured when F7-13 = 0. Set an IP Addresses that is unique.

■ F7-14: Duplex Mode Selection

No. (Hex.)	Name	Description	Default Setting (Range)
F7-14 (03F2)	Duplex Mode Selection	<div style="display: flex; justify-content: space-between; font-size: 0.8em;"> V/f CL-V/f OLV CLV AOLV OLV/PM AOLV/PM CLV/PM EZOLV </div> Selects the setting method for the duplex mode.	1 (0 - 8)

0 : Auto/Auto

1 : Half/Half

2 : Full/Full

■ F7-15: Communication Speed Selection

No. (Hex.)	Name	Description	Default Setting (Range)
F7-15 (03F3)	Communication Speed Selection	<div style="display: flex; justify-content: space-between; font-size: 0.8em;"> V/f CL-V/f OLV CLV AOLV OLV/PM AOLV/PM CLV/PM EZOLV </div> Sets the communications speed.	10 (10, 102)

10 : 10/10 Mbps

102 : 100/100 Mbps

Note:

Set F7-15 when F7-14 = 0 or 2 [Duplex Mode Selection = Auto/Auto or Full/Full].

■ F7-16: Timeout Value

No. (Hex.)	Name	Description	Default Setting (Range)
F7-16 (03F4)	Timeout Value	<div style="display: flex; justify-content: space-between; font-size: 0.8em;"> V/f CL-V/f OLV CLV AOLV OLV/PM AOLV/PM CLV/PM EZOLV </div> Sets the detection time of the timeout value for communications in increments of 0.1 s.	0.0 s (0.0 to 30.0 s)

Note:

A value of 0 disables the connection time out.

■ F7-17: EtherNet/IP Speed Scaling Factor

No. (Hex.)	Name	Description	Default Setting (Range)
F7-17 (03F5)	EtherNet/IP Speed Scaling Factor	<div style="display: flex; justify-content: space-between; font-size: 0.8em;"> V/f CL-V/f OLV CLV AOLV OLV/PM AOLV/PM CLV/PM EZOLV </div> Sets the scaling factor for the speed monitor for the EtherNet/IP object with the Class ID 2AH.	0 (-15 to 15)

■ F7-18: EtherNet/IP Current Scale Factor

No. (Hex.)	Name	Description	Default Setting (Range)
F7-18 (03F6)	EtherNet/IP Current Scale Factor	<div style="display: flex; justify-content: space-between; font-size: 0.8em;"> V/f CL-V/f OLV CLV AOLV OLV/PM AOLV/PM CLV/PM EZOLV </div> Sets the scaling factor for the output current monitor for the EtherNet/IP object with the Class ID 2AH.	0 (-15 to 15)

■ F7-19: EtherNet/IP Torque Scale Factor

No. (Hex.)	Name	Description	Default Setting (Range)
F7-19 (03F7)	EtherNet/IP Torque Scale Factor	V/f CL-V/f OLV CLV AOLV OLV/PM AOLV/PM CLV/PM EZOLV Sets the scaling factor for the torque monitor for the EtherNet/IP object with the Class ID 2AH.	0 (-15 to 15)

■ F7-20: EtherNet/IP Power Scaling Factor

No. (Hex.)	Name	Description	Default Setting (Range)
F7-20 (03F8)	EtherNet/IP Power Scaling Factor	V/f CL-V/f OLV CLV AOLV OLV/PM AOLV/PM CLV/PM EZOLV Sets the scaling factor for the power monitor for the EtherNet/IP object with the Class ID 2AH.	0 (-15 to 15)

■ F7-21: EtherNet/IP Voltage Scale Factor

No. (Hex.)	Name	Description	Default Setting (Range)
F7-21 (03F9)	EtherNet/IP Voltage Scale Factor	V/f CL-V/f OLV CLV AOLV OLV/PM AOLV/PM CLV/PM EZOLV Sets the scaling factor for the voltage monitor for the EtherNet/IP object with the Class ID 2AH.	0 (-15 to 15)

■ F7-22: EtherNet/IP Time Scaling

No. (Hex.)	Name	Description	Default Setting (Range)
F7-22 (03FA)	EtherNet/IP Time Scaling	V/f CL-V/f OLV CLV AOLV OLV/PM AOLV/PM CLV/PM EZOLV Sets the scaling factor for the time monitor for the EtherNet/IP object with the Class ID 2AH.	0 (-15 to 15)

■ F7-23 to F7-32: Dynamic Out Assembly 115 Param 1 to 10

No. (Hex.)	Name	Description	Default Setting (Range)
F7-23 through F7-27 (03FB - 03FF) F7-28 through F7-32 (0370 - 0374)	Dynamic Out Assembly 115 Param 1 through 10	V/f CL-V/f OLV CLV AOLV OLV/PM AOLV/PM CLV/PM EZOLV Used for setting the Output Assembly 116. The values received from the Output Assembly 116 are written to the MEMOBUS/Modbus address register stored for each parameter. When the MEMOBUS/Modbus address is 0, the values received from the Output Assembly 116 are not written to the registers.	0

■ F7-33 to F7-42: Dynamic In Assembly 165 Param 1 to 10

No. (Hex.)	Name	Description	Default Setting (Range)
F7-33 through F7-42 (0375 - 037E)	Dynamic In Assembly 165 Param 1 through 10	V/f CL-V/f OLV CLV AOLV OLV/PM AOLV/PM CLV/PM EZOLV Used for setting the input assembly 166. The values sent to the input assembly 166 are loaded from the MEMOBUS/Modbus address register stored for each parameter. When the MEMOBUS/Modbus address is 0, the value sent to the input assembly 166 is not defined, and so the default register value for the option card is returned.	0

■ F7-60: PZD1 Write

No. (Hex.)	Name	Description	Default Setting (Range)
F7-60 (0780)	PZD1 Write	V/f CL-V/f OLV CLV AOLV OLV/PM AOLV/PM CLV/PM EZOLV Sets the MEMOBUS/Modbus address for PZD1 (PPO output). PZD1 (PPO output) functions as the STW when F7-60 = 0, 1, or 2.	0

■ F7-61: PZD2 Write

No. (Hex.)	Name	Description	Default Setting (Range)
F7-61 (0781)	PZD2 Write	<div style="display: flex; justify-content: space-between; font-size: 0.8em; font-weight: bold; background-color: #f0f0f0; padding: 2px;"> V/f CL-V/f OLV CLV AOLV OLV/PM AOLV/PM CLV/PM EZOLV </div> <p>Sets the MEMOBUS/Modbus address for PZD2 (PPO output). PZD2 (PPO output) functions as the HSW when $F7-61 = 0, 1, \text{ or } 2$.</p>	0

■ F7-62: PZD3 Write

No. (Hex.)	Name	Description	Default Setting (Range)
F7-62 (0782)	PZD3 Write	<div style="display: flex; justify-content: space-between; font-size: 0.8em; font-weight: bold; background-color: #f0f0f0; padding: 2px;"> V/f CL-V/f OLV CLV AOLV OLV/PM AOLV/PM CLV/PM EZOLV </div> <p>Sets the MEMOBUS/Modbus address for PZD3 (PPO output). When $F7-62 = 0, 1, \text{ or } 2$, the write operation to the MEMOBUS/Modbus register performed by the PZD3 (PPO output) is disabled.</p>	0

■ F7-63: PZD4 Write

No. (Hex.)	Name	Description	Default Setting (Range)
F7-63 (0783)	PZD4 Write	<div style="display: flex; justify-content: space-between; font-size: 0.8em; font-weight: bold; background-color: #f0f0f0; padding: 2px;"> V/f CL-V/f OLV CLV AOLV OLV/PM AOLV/PM CLV/PM EZOLV </div> <p>Sets the MEMOBUS/Modbus address for PZD4 (PPO output). When $F7-63 = 0, 1, \text{ or } 2$, the write operation to the MEMOBUS/Modbus register performed by the PZD4 (PPO output) is disabled.</p>	0

■ F7-64: PZD5 Write

No. (Hex.)	Name	Description	Default Setting (Range)
F7-64 (0784)	PZD5 Write	<div style="display: flex; justify-content: space-between; font-size: 0.8em; font-weight: bold; background-color: #f0f0f0; padding: 2px;"> V/f CL-V/f OLV CLV AOLV OLV/PM AOLV/PM CLV/PM EZOLV </div> <p>Sets the MEMOBUS/Modbus address for PZD5 (PPO output). When $F7-64 = 0, 1, \text{ or } 2$, the write operation to the MEMOBUS/Modbus register performed by the PZD5 (PPO output) is disabled.</p>	0

■ F7-65: PZD6 Write

No. (Hex.)	Name	Description	Default Setting (Range)
F7-65 (0785)	PZD6 Write	<div style="display: flex; justify-content: space-between; font-size: 0.8em; font-weight: bold; background-color: #f0f0f0; padding: 2px;"> V/f CL-V/f OLV CLV AOLV OLV/PM AOLV/PM CLV/PM EZOLV </div> <p>Sets the MEMOBUS/Modbus address for PZD6 (PPO output). When $F7-65 = 0, 1, \text{ or } 2$, the write operation to the MEMOBUS/Modbus register performed by the PZD6 (PPO output) is disabled.</p>	0

■ F7-66: PZD7 Write

No. (Hex.)	Name	Description	Default Setting (Range)
F7-66 (0786)	PZD7 Write	<div style="display: flex; justify-content: space-between; font-size: 0.8em; font-weight: bold; background-color: #f0f0f0; padding: 2px;"> V/f CL-V/f OLV CLV AOLV OLV/PM AOLV/PM CLV/PM EZOLV </div> <p>Sets the MEMOBUS/Modbus address for PZD7 (PPO output). When $F7-66 = 0, 1, \text{ or } 2$, the write operation to the MEMOBUS register performed by the PZD7 (PPO output) is disabled.</p>	0

■ F7-67: PZD8 Write

No. (Hex.)	Name	Description	Default Setting (Range)
F7-67 (0787)	PZD8 Write	<div style="display: flex; justify-content: space-between; font-size: 0.8em; font-weight: bold; background-color: #f0f0f0; padding: 2px;"> V/f CL-V/f OLV CLV AOLV OLV/PM AOLV/PM CLV/PM EZOLV </div> <p>Sets the MEMOBUS/Modbus address for PZD8 (PPO output). Setting $F7-67 = 0, 1, \text{ or } 2$ disables the PZD8 Write.</p>	0

■ F7-68: PZD9 Write

No. (Hex.)	Name	Description	Default Setting (Range)
F7-68 (0788)	PZD9 Write	<p>V/f CL-V/f OLV CLV AOLV OLV/PM AOLV/PM CLV/PM EZOLV</p> <p>Sets the MEMOBUS/Modbus address for PZD9 (PPO output). When <i>F7-68 = 0, 1, or 2</i>, the write operation to the MEMOBUS/Modbus register performed by the PZD9 (PPO output) is disabled.</p>	0

■ F7-69: PZD10 Write

No. (Hex.)	Name	Description	Default Setting (Range)
F7-69 (0789)	PZD10 Write	<p>V/f CL-V/f OLV CLV AOLV OLV/PM AOLV/PM CLV/PM EZOLV</p> <p>Sets the MEMOBUS/Modbus address for PZD10 (PPO output). When <i>F7-69 = 0, 1, or 2</i>, the write operation to the MEMOBUS/Modbus register performed by the PZD10 (PPO output) is disabled.</p>	0

■ F7-70: PZD1 Read

No. (Hex.)	Name	Description	Default Setting (Range)
F7-70 (078A)	PZD1 Read	<p>V/f CL-V/f OLV CLV AOLV OLV/PM AOLV/PM CLV/PM EZOLV</p> <p>Sets the MEMOBUS/Modbus address for PZD1 (PPO Read). PZD1 (PPO input) functions as the ZSW when <i>F7-70 = 0</i>.</p>	0

■ F7-71: PZD2 Read

No. (Hex.)	Name	Description	Default Setting (Range)
F7-71 (078B)	PZD2 Read	<p>V/f CL-V/f OLV CLV AOLV OLV/PM AOLV/PM CLV/PM EZOLV</p> <p>Sets the MEMOBUS/Modbus address for PZD2 (PPO Read). PZD2 (PPO input) functions as the HIW when <i>F7-71 = 0</i>.</p>	0

■ F7-72: PZD3 Read

No. (Hex.)	Name	Description	Default Setting (Range)
F7-72 (078C)	PZD3 Read	<p>V/f CL-V/f OLV CLV AOLV OLV/PM AOLV/PM CLV/PM EZOLV</p> <p>Sets the MEMOBUS/Modbus address for PZD3 (PPO Read). When <i>F7-72 = 0</i>, the load operation from the MEMOBUS/Modbus register performed by the PZD3 (PPO input) is disabled.</p>	0

■ F7-73: PZD4 Read

No. (Hex.)	Name	Description	Default Setting (Range)
F7-73 (078D)	PZD4 Read	<p>V/f CL-V/f OLV CLV AOLV OLV/PM AOLV/PM CLV/PM EZOLV</p> <p>Sets the MEMOBUS/Modbus address for PZD4 (PPO Read). When <i>F7-73 = 0</i>, the load operation from the MEMOBUS register performed by the PZD4 (PPO input) is disabled.</p>	0

■ F7-74: PZD5 Read

No. (Hex.)	Name	Description	Default Setting (Range)
F7-74 (078E)	PZD5 Read	<p>V/f CL-V/f OLV CLV AOLV OLV/PM AOLV/PM CLV/PM EZOLV</p> <p>Sets the MEMOBUS/Modbus address for PZD5 (PPO Read). When <i>F7-74 = 0</i>, the load operation from the MEMOBUS/Modbus register performed by the PZD5 (PPO input) is disabled.</p>	0

■ F7-75: PZD6 Read

No. (Hex.)	Name	Description	Default Setting (Range)
F7-75 (078F)	PZD6 Read	<div style="display: flex; justify-content: space-between; font-size: small; font-weight: bold;"> V/f CL-V/f OLV CLV AOLV OLV/PM AOLV/PM CLV/PM EZOLV </div> <p>Sets the MEMOBUS/Modbus address for PZD6 (PPO Read). When $F7-75 = 0$, the load operation from the MEMOBUS/Modbus register performed by the PZD6 (PPO input) is disabled.</p>	0

■ F7-76: PZD7 Read

No. (Hex.)	Name	Description	Default Setting (Range)
F7-76 (0790)	PZD7 Read	<div style="display: flex; justify-content: space-between; font-size: small; font-weight: bold;"> V/f CL-V/f OLV CLV AOLV OLV/PM AOLV/PM CLV/PM EZOLV </div> <p>Sets the MEMOBUS/Modbus address for PZD7 (PPO Read). When $F7-76 = 0$, the load operation from the MEMOBUS register performed by the PZD7 (PPO input) is disabled.</p>	0

■ F7-77: PZD8 Read

No. (Hex.)	Name	Description	Default Setting (Range)
F7-77 (0791)	PZD8 Read	<div style="display: flex; justify-content: space-between; font-size: small; font-weight: bold;"> V/f CL-V/f OLV CLV AOLV OLV/PM AOLV/PM CLV/PM EZOLV </div> <p>Sets the MEMOBUS/Modbus address for PZD8 (PPO Read). When $F7-77 = 0$, the load operation from the MEMOBUS/Modbus register performed by the PZD8 (PPO input) is disabled.</p>	0

■ F7-78: PZD9 Read

No. (Hex.)	Name	Description	Default Setting (Range)
F7-78 (0792)	PZD9 Read	<div style="display: flex; justify-content: space-between; font-size: small; font-weight: bold;"> V/f CL-V/f OLV CLV AOLV OLV/PM AOLV/PM CLV/PM EZOLV </div> <p>Sets the MEMOBUS/Modbus address for PZD9 (PPO Read). When $F7-78 = 0$, the load operation from the MEMOBUS/Modbus register performed by the PZD9 (PPO input) is disabled.</p>	0

■ F7-79: PZD10 Read

No. (Hex.)	Name	Description	Default Setting (Range)
F7-79 (0793)	PZD10 Read	<div style="display: flex; justify-content: space-between; font-size: small; font-weight: bold;"> V/f CL-V/f OLV CLV AOLV OLV/PM AOLV/PM CLV/PM EZOLV </div> <p>Sets the MEMOBUS/Modbus address for PZD10 (PPO Read). When $F7-79 = 0$, the load operation from the MEMOBUS/Modbus register performed by the PZD10 (PPO input) is disabled.</p>	0

11.8 H: Terminal Functions

H parameters are used to assign functions to external input and output terminals.

◆ H1: Multi-function digital input

H1 Parameters set the MFDI terminal functions.

■ H1-01 to H1-08 Terminal S1 to S8 Function Select

The drive has eight MFDI terminals. Refer to the following table for drive default settings and functions.

No.	Name	Default Setting	Function
H1-01	Terminal S1 Function Selection	40(F) ^{*1}	Forward Run Command (2-Wire Seq)
H1-02	Terminal S2 Function Selection	41(F) ^{*1}	Reverse Run Command (2-Wire Seq)
H1-03	Terminal S3 Function Selection	24	External fault (N.O., detection always enabled, coast to stop)
H1-04	Terminal S4 Function Selection	14	Fault Reset
H1-05	Terminal S5 Function Selection	3(0) ^{*1}	Multi-Step Speed Reference 1
H1-06	Terminal S6 Function Selection	4(3) ^{*1}	Multi-Step Speed Reference 2
H1-07	Terminal S7 Function Selection	6(4) ^{*1}	Jog Reference Selection
H1-08	Terminal S8 Function Selection	8	Baseblock Command (N.O.)

*1 The value in parentheses indicate the default setting when initialized with *A1-03 = 3330* [*Initialize Parameters = 3-Wire initialization*].

Refer to the following table and use *H1-xx* [*MFDI Function Select*] to set the function.

Table 11.45 Multi-Function Digital Input Setting Values

Setting	Function	Setting	Function
0 ^{*1}	3-Wire Sequence	15 ^{*1}	Fast Stop (N.O.)
1	LOCAL/REMOTE Selection	16	Motor 2 Selection
2	External Reference 1/2 Selection	17 ^{*1}	Fast Stop (N.C.)
3	Multi-Step Speed Reference 1	18	Timer Function Input
4	Multi-Step Speed Reference 2	19	PID Disable
5	Multi-Step Speed Reference 3	1A	Accel/Decel Time Selection 2
6	Jog Reference Selection	1B	Program Lockout
7	Accel/Decel Time Selection 1	1E	Reference Sample Hold
8 ^{*1}	Baseblock Command (N.O.)	20 through 2F ^{*1}	External Fault
9 ^{*1}	Baseblock Command (N.C.)	30	PID Integral Reset
A	Accel/Decel Ramp Hold	31	PID Integral Hold
B	oH2 [Drive Overheat Warning]	32	Multi-Step Speed Reference 4
C	Analog Terminal Input Selection	34	PID Soft Starter Cancel
D	PG Encoder Disable	35	PID Input Level Selection
E	ASR Integral Reset	3E	PID Setpoint Selection 1
F	Through Mode	3F	PID Setpoint Selection 2
10	Up Command	40 ^{*1}	Forward Run Command (2-Wire Seq)
11	Down Command	41 ^{*1}	Reverse Run Command (2-Wire Seq)
12 ^{*1}	Forward Jog	42 ^{*1}	Run Command (2-Wire Sequence 2)
13 ^{*1}	Reverse Jog	43 ^{*1}	FWD/REV Command (2-Wire Seq 2)
14	Fault Reset	44	Offset Frequency 1

Setting	Function	Setting	Function
45	Offset Frequency 2	75	Up 2 Command
46	Offset Frequency 3	76	Up 2 Command
47	Node Setup	77	ASR Gain Switch
60	DC Injection Braking Command	78	Ex.Torque Ref Polarity Inversion
61	External Speed Search Command 1: Maximum Output Frequency	7A *1	KEB Ride-Thru 2 (N.C.)
62	External Speed Search Command 2: Set Frequency Reference	7B *1	KEB Ride-Thru 2 (N.O.)
63	Field Weakening	7C *1	Short Circuit Braking (N.O.)
65 *1	KEB Ride-Thru 1 (N.C.)	7D *1	Short Circuit Braking (N.C.)
66 *1	KEB Ride-Thru 1 (N.O.)	7E	FWD/REV Detect (V/f w/ simplePG)
67	Communications Test Mode	90 to 97 *1	DriveWorksEZ Digital Inputs 1 to 8
68	High-Slip Braking	9F	DriveWorksEZ Disable
6A	Drive Enable	1xx	0 to 9F Input Inversion Performs input inversion on the function of the selected MFDI. Input two digits 00 to 9F in place of the two Xs in 1xx to select the function that will undergo input inversion.
71	Speed/Torque Control Switch		
72	Zero Servo		

*1 Input inversion is not available.

■ H1-01: Terminal S1 Function Select

No. (Hex.)	Name	Description	Default (Range)
H1-01 (0438)	Terminal S1 Function Select	V/f CL-V/f OLV CLV AOLV OLV/PM AOLV/PM CLV/PM EZOLV Selects a function assigned to the MFDI terminal S1.	40 (1-19F)

Note:

When *Initialization* [A1-03 = 3330] has been performed for a 3-wire sequence, the default setting is F.

■ H1-02: Terminal S2 Function Select

No. (Hex.)	Name	Description	Default Setting (Range)
H1-02 (0439)	Terminal S2 Function Select	V/f CL-V/f OLV CLV AOLV OLV/PM AOLV/PM CLV/PM EZOLV Selects a function assigned to the MFDI terminal S2.	41 (1 - 19F)

Note:

When *Initialization* [A1-03 = 3330] has been performed for a 3-wire sequence, the default setting is F.

■ H1-03: Terminal S3 Function Select

No. (Hex.)	Name	Description	Default Setting (Range)
H1-03 (0400)	Terminal S3 Function Select	V/f CL-V/f OLV CLV AOLV OLV/PM AOLV/PM CLV/PM EZOLV Selects a function assigned to the MFDI terminal S3.	24 (0 - 19F)

■ H1-04: Terminal S4 Function Select

No. (Hex.)	Name	Description	Default Setting (Range)
H1-04 (0401)	Terminal S4 Function Select	V/f CL-V/f OLV CLV AOLV OLV/PM AOLV/PM CLV/PM EZOLV Selects a function assigned to the MFDI terminal S4.	14 (0 - 19F)

■ H1-05: Terminal S5 Function Select

No. (Hex.)	Name	Description	Default Setting (Range)
H1-05 (0402)	Terminal S5 Function Select	V/f CL-V/f OLV CLV AOLV OLV/PM AOLV/PM CLV/PM EZOLV Selects a function assigned to the MFDI terminal S5.	3 (0 - 19F)

Note:

When *Initialization* [A1-03 = 3330] has been performed for a 3-wire sequence, the default setting is 0.

■ H1-06: Terminal S6 Function Select

No. (Hex.)	Name	Description	Default Setting (Range)
H1-06 (0403)	Terminal S6 Function Select	V/f CL-V/f OLV CLV AOLV OLV/PM AOLV/PM CLV/PM EZOLV Selects a function assigned to the MFDI terminal S6.	4 (0 - 19F)

Note:

When *Initialization* [A1-03 = 3330] has been performed for a 3-wire sequence, the default setting is 3.

■ H1-07: Terminal S7 Function Select

No. (Hex.)	Name	Description	Default Setting (Range)
H1-07 (0404)	Terminal S7 Function Select	V/f CL-V/f OLV CLV AOLV OLV/PM AOLV/PM CLV/PM EZOLV Selects a function assigned to the MFDI terminal S7.	6 (0 - 19F)

Note:

When *Initialization* [A1-03 = 3330] has been performed for a 3-wire sequence, the default setting is 4.

■ H1-08: Terminal S8 Function Select

No. (Hex.)	Name	Description	Default Setting (Range)
H1-08 (0405)	Terminal S8 Function Select	V/f CL-V/f OLV CLV AOLV OLV/PM AOLV/PM CLV/PM EZOLV Selects a function assigned to the MFDI terminal S8.	8 (0 - 19F)

■ H1-21: Terminal S1 Function Select 2

No. (Hex.)	Name	Description	Default Setting (Range)
H1-21 (0B70)	Terminal S1 Function Select 2	V/f CL-V/f OLV CLV AOLV OLV/PM AOLV/PM CLV/PM EZOLV Selects the 2nd function for the MFDI terminal S1.	F (1 - 19F)

Operates the function assigned to *H1-01* [Terminal S1 Function Select] and the function assigned to *H1-21* simultaneously if the MFDI terminal S1 is turned ON.

When *F* is assigned as the setting value, the function will be disabled.

■ H1-22: Terminal S2 Function Select 2

No. (Hex.)	Name	Description	Default Setting (Range)
H1-22 (0B71)	Terminal S2 Function Select 2	V/f CL-V/f OLV CLV AOLV OLV/PM AOLV/PM CLV/PM EZOLV Selects the 2nd function for the MFDI terminal S2.	F (1 - 19F)

Operates the function assigned to *H1-02* [Terminal S2 Function Select] and the function assigned to *H1-22* simultaneously if the MFDI terminal S2 is turned ON.

When *F* is assigned as the setting value, the function will be disabled.

■ H1-23: Terminal S3 Function Select 2

No. (Hex.)	Name	Description	Default Setting (Range)
H1-23 (0B72)	Terminal S3 Function Select 2	V/f CL-V/f OLV CLV AOLV OLV/PM AOLV/PM CLV/PM EZOLV Selects the 2nd function for the MFDI terminal S3.	F (1 - 19F)

Operates the function assigned to *H1-03 [Terminal S3 Function Select]* and the function assigned to *H1-23* simultaneously if the MFDI terminal S3 is turned ON.

When *F* is assigned as the setting value, the function will be disabled.

■ H1-24: Terminal S4 Function Select 2

No. (Hex.)	Name	Description	Default Setting (Range)
H1-24 (0B73)	Terminal S4 Function Select 2	V/f CL-V/f OLV CLV AOLV OLV/PM AOLV/PM CLV/PM EZOLV Selects the 2nd function for the MFDI terminal S4.	F (1 - 19F)

Operates the function assigned to *H1-04 [Terminal S4 Function Select]* and the function assigned to *H1-24* simultaneously if the MFDI terminal S4 is turned ON.

When *F* is assigned as the setting value, the function will be disabled.

■ H1-25: Terminal S5 Function Select 2

No. (Hex.)	Name	Description	Default Setting (Range)
H1-25 (0B74)	Terminal S5 Function Select 2	V/f CL-V/f OLV CLV AOLV OLV/PM AOLV/PM CLV/PM EZOLV Selects the 2nd function for the MFDI terminal S5.	F (1 - 19F)

Operates the function assigned to *H1-05 [Terminal S5 Function Select]* and the function assigned to *H1-25* simultaneously if the MFDI terminal S5 is turned ON.

When *F* is assigned as the setting value, the function will be disabled.

■ H1-26: Terminal S6 Function Select 2

No. (Hex.)	Name	Description	Default Setting (Range)
H1-26 (0B75)	Terminal S6 Function Select 2	V/f CL-V/f OLV CLV AOLV OLV/PM AOLV/PM CLV/PM EZOLV Selects the 2nd function for the MFDI terminal S6.	F (1 - 19F)

Operates the function assigned to *H1-06 [Terminal S6 Function Select]* and the function assigned to *H1-26* simultaneously if the MFDI terminal S6 is turned ON.

When *F* is assigned as the setting value, the function will be disabled.

■ H1-27: Terminal S7 Function Select 2

No. (Hex.)	Name	Description	Default Setting (Range)
H1-27 (0B76)	Terminal S7 Function Select 2	V/f CL-V/f OLV CLV AOLV OLV/PM AOLV/PM CLV/PM EZOLV Selects the 2nd function for the MFDI terminal S7.	F (1 - 19F)

Operates the function assigned to *H1-07 [Terminal S7 Function Select]* and the function assigned to *H1-27* simultaneously if the MFDI terminal S7 is turned ON.

When *F* is assigned as the setting value, the function will be disabled.

■ H1-28: Terminal S8 Function Select 2

No. (Hex.)	Name	Description	Default Setting (Range)
H1-28 (0B77)	Terminal S8 Function Select 2	V/f CL-V/f OLV CLV AOLV OLV/PM AOLV/PM CLV/PM EZOLV Selects the 2nd function for the MFDI terminal S8.	F (1 - 19F)

Operates the function assigned to *H1-08 [Terminal S8 Function Select]* and the function assigned to *H1-28* simultaneously if the MFDI terminal S8 is turned ON.

When *F* is assigned as the setting value, the function will be disabled.

■ **MEMOBUS/Modbus Multi-Function Digital Input 1 to 3 Functions Selection**

The function for the MFDI can be assigned to MEMOBUS register *bit 0 to 2* of [*15C0(Hex.)*]. Select the function with *H1-40 to H1-42 [Extend MFDI Function Selection]*.

Note:

- Refer to H1-xx “MFDI setting values” for the setting values of the MFDI.
- 0 [*3-Wire Sequence*] and 20 to 2F [*External fault*] cannot be assigned in *H1-40 to H1-42*.
- When *H1-40 to H1-42* are not used, set *H1-40 to H1-42 = F [Through Mode]*.
- Multi-function input for digital input option D1-A3 cannot be used simultaneously with function selection for MEMOBUS/Modbus MFDI 1 to 3.

■ **H1-40: Extend MFDI1 Function Selection**

No. (Hex.)	Name	Description	Default Setting (Range)
H1-40 (0B54)	Extend MFDI1 Function Selection	V/f CL-V/f OLV CLV AOLV OLV/PM AOLV/PM CLV/PM EZOLV Selects MFDI function assigned to <i>bit 0</i> of the MEMOBUS register <i>15C0 (Hex.)</i> .	F (1 - 19F)

■ **H1-41: Extend MFDI2 Function Selection**

No. (Hex.)	Name	Description	Default Setting (Range)
H1-41 (0B55)	Extend MFDI2 Function Selection	V/f CL-V/f OLV CLV AOLV OLV/PM AOLV/PM CLV/PM EZOLV Selects MFDI function assigned to <i>bit 1</i> of the MEMOBUS register <i>15C0 (Hex.)</i> .	F (1 - 19F)

■ **H1-42: Extend MFDI3 Function Selection**

No. (Hex.)	Name	Description	Default Setting (Range)
H1-42 (0B56)	Extend MFDI3 Function Selection	V/f CL-V/f OLV CLV AOLV OLV/PM AOLV/PM CLV/PM EZOLV Selects MFDI function assigned to <i>bit 2</i> of the MEMOBUS register <i>15C0 (Hex.)</i> .	F (1 - 19F)

◆ **Multi-Function Digital Input Setting Values**

Selects a function set with *H1-01 to H1-08*.

■ **0: 3-Wire Sequence**

Setting	Function	Description
0	3-Wire Sequence	V/f CL-V/f OLV CLV AOLV OLV/PM AOLV/PM CLV/PM EZOLV Selects the direction of motor rotation for 3-wire sequence.

If the 3-wire sequence is set to any other terminal than MFDI terminals S1 and S2, these terminals will be the input terminals for Forward run/Reverse run command. Terminals S1 and S2 will be automatically set to Run command (RUN) and Stop command (STOP) respectively.

The drive rotates the motor if terminal S1 (Run command) is turned ON for 1 ms or more. The drive stops if terminal S2 (Stop command) is switched OFF. When terminal Sx that is set in 3-wire sequence is switched OFF, the drive will operate in the forward direction, and when it is switched ON, the drive will operate in the reverse direction.

WARNING! Sudden Movement Hazard. Set the multi-function input terminal parameters before closing the wiring for the control circuit. Improper sequencing of run/stop circuitry could cause death or serious injury from moving equipment.

WARNING! Sudden Movement Hazard. When using a 3-Wire sequence, set the drive to 3-Wire sequence and set *b1-17 = 0 [Run Command at Power Up = Disregard Existing RUN Command]* before wiring the control terminals so the drive will not accept a Run command at power up. The motor may rotate in reverse when the drive is powered up if the drive is wired for a 3-wire sequence but set up for a 2-wire sequence (default) and *b1-17 = 1 [Accept Existing RUN Command]*. Failure to comply could cause death or serious injury from moving equipment.

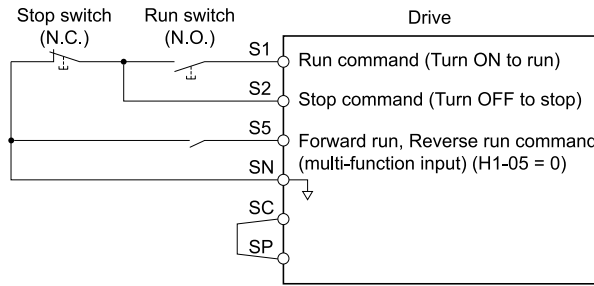

Figure 11.73 3-Wire Sequence Wiring Example

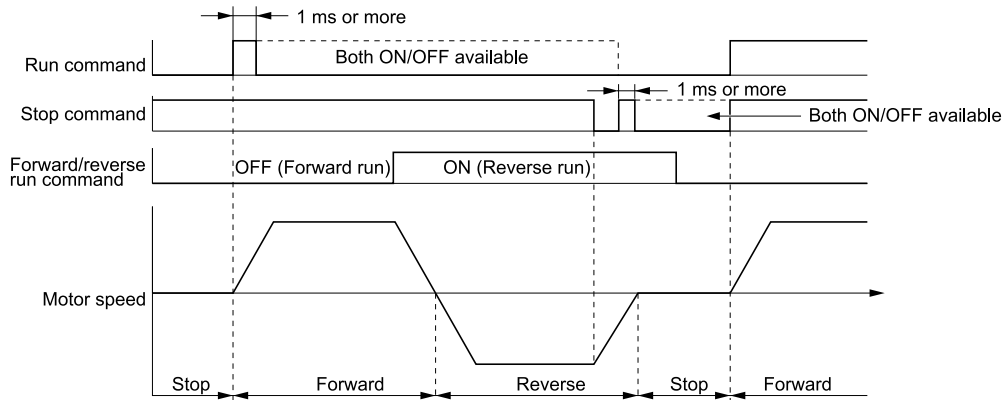



Figure 11.74 3-Wire Sequence Time Chart

Note:

- Turn the terminal ON for 1 ms or more to input the Run command.
- The default setting for *b1-17* [Run Command at Power Up] is 0 [Disregard existing RUN command]. The protective function activates

and the  will flash quickly if the Run command was enabled when the power was energized. Depending on the application, set *b1-17* = 1 [Accept existing RUN command] if run is permitted.

■ **1: LOCAL/REMOTE Selection**

Setting	Function	Description
1	LOCAL/REMOTE Selection	 Switches drive control between the keypad (LOCAL) and an external source (REMOTE).

Note:

- When the LOCAL/REMOTE selection has been set from the multi-function input terminal, the LOCAL/REMOTE Selection key on the keypad will be disabled.

 will be lit when Local Mode is selected.

- When the Run command is ON, it is not possible to switch between Local Mode and Remote Mode.

ON : LOCAL

A mode in which the keypad is used as the Frequency reference source and Run command source

OFF : REMOTE

An operation mode in which frequency reference and Run command settings can be set in *b1-01*, *b1-02* [Frequency Reference Selection 1/2] or *b1-15*, *b1-16* [Run Command Selection 1/2]

■ **2: External Reference 1/2 Selection**

Setting	Function	Description
2	External Reference 1/2 Selection	 Switches between the Run command source 1/2 and Reference command source 1/2 when in REMOTE mode.

Note:

When a Run command is being input, switching between reference sources is not permitted.

ON : *b1-15* = [Frequency Reference Selection 2], *b1-16* [Run Command Selection 2]

OFF : *b1-01* = [Frequency Reference Selection 1], *b1-02* [Run Command Selection 1]

■ 3: Multi-Step Speed Reference 1

Setting	Function	Description
3	Multi-Step Speed Reference 1	<div style="display: flex; justify-content: space-between; align-items: center;"> V/f CL-V/f OLV CLV AOLV OLV/PM AOLV/PM CLV/PM EZOLV </div> <p>Switches <i>d1-01</i> to <i>d1-08</i> [Multi-Step Speed Reference] using a combination of multi-step speed references 1, 2 and 3.</p>

Note:

Refer to the “Setting Procedures for Multi-step Speed Operation” of the d-parameter for details.

■ 4: Multi-Step Speed Reference 2

Setting	Function	Description
4	Multi-Step Speed Reference 2	<div style="display: flex; justify-content: space-between; align-items: center;"> V/f CL-V/f OLV CLV AOLV OLV/PM AOLV/PM CLV/PM EZOLV </div> <p>Switches <i>d1-01</i> to <i>d1-08</i> [Multi-Step Speed Reference] using a combination of multi-step speed references 1, 2 and 3.</p>

Note:

Refer to the “Setting Procedures for Multi-step Speed Operation” of the d-parameter for details.

■ 5: Multi-Step Speed Reference 3

Setting	Function	Description
5	Multi-Step Speed Reference 3	<div style="display: flex; justify-content: space-between; align-items: center;"> V/f CL-V/f OLV CLV AOLV OLV/PM AOLV/PM CLV/PM EZOLV </div> <p>Switches <i>d1-01</i> to <i>d1-08</i> [Multi-Step Speed Reference] using a combination of multi-step speed references 1, 2 and 3.</p>

Note:

Refer to the “Setting Procedures for Multi-step Speed Operation” of the d-parameter for details.

■ 6: Jog Reference Selection

Setting	Function	Description
6	Jog Reference Selection	<div style="display: flex; justify-content: space-between; align-items: center;"> V/f CL-V/f OLV CLV AOLV OLV/PM AOLV/PM CLV/PM EZOLV </div> <p>Enables the Jog Reference (JOG command) that was set <i>ind1-17</i>. The Jog Reference (JOG command) overrides even References 1 to 16 (<i>d1-01</i> to <i>d1-16</i>).</p>

■ 7: Accel/decel Time Selection 1

Setting	Function	Description
7	Accel/decel Time Selection 1	<div style="display: flex; justify-content: space-between; align-items: center;"> V/f CL-V/f OLV CLV AOLV OLV/PM AOLV/PM CLV/PM EZOLV </div> <p>Switches between <i>C1-01</i>, <i>C1-02</i> [Acceleration/Deceleration Time 1] and <i>C1-03</i>, <i>C1-04</i> [Acceleration/Deceleration Time 2].</p>

Note:

Refer to “C1: Accel & Decel Time” for details.

■ 8: Baseblock Command (N.O.)

Setting	Function	Description
8	Baseblock Command (N.O.)	<div style="display: flex; justify-content: space-between; align-items: center;"> V/f CL-V/f OLV CLV AOLV OLV/PM AOLV/PM CLV/PM EZOLV </div> <p>If a baseblock command (N.O.) is input, the drive output will stop and the motor will coast to stop.</p>

The keypad flashes *bb* [Baseblock]. If the baseblock command is canceled when the Run command is ON, the drive restarts the motor utilizing the speed search function.

WARNING! Sudden Movement Hazard. If using the Baseblock command with hoist-type application, make sure the holding brake is closed when the Baseblock command is input and the drive shuts off its output. Failure to do so may result in the motor suddenly coasting when the Baseblock command is input, which may result in the load slipping or falling.

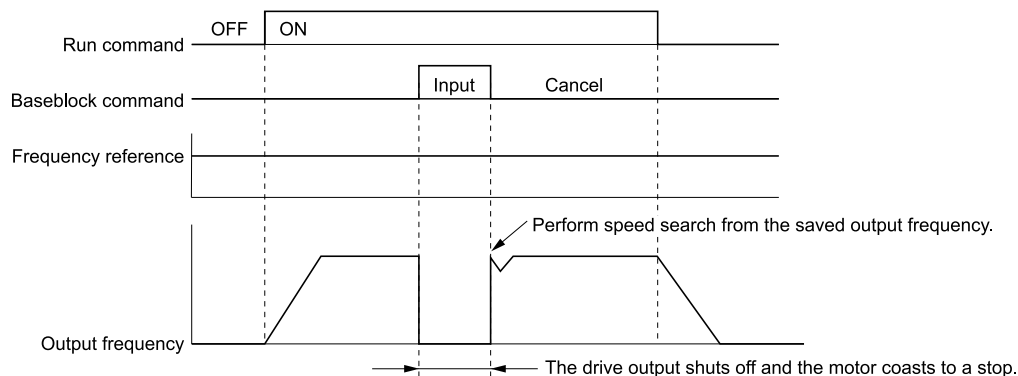

Figure 11.75 Baseblock Command Time Chart

ON : Baseblock (drive output stop)

OFF : Normal operation

■ **9: Baseblock Command (N.C.)**

Setting	Function	Description
9	Baseblock Command (N.C.)	V/f CL-V/f OLV CLV AOLV OLV/PM AOLV/PM CLV/PM EZOLV If a baseblock command (N.C.) is input (turned OFF), the drive output will stop and the motor will coast to stop.

The keypad flashes *bb* [Baseblock]. If the baseblock command is canceled when the Run command is ON, the drive restarts the motor utilizing the speed search function.

ON : Normal operation

OFF : Baseblock (drive output stop)

WARNING! Sudden Movement Hazard. If using the Baseblock command with hoist-type application, make sure the holding brake is closed when the Baseblock command is input and the drive shuts off its output. Failure to do so may result in the motor suddenly coasting when the Baseblock command is input, which may result in the load slipping or falling.

■ **A: Accel/Decel Ramp Hold**

Setting	Function	Description
A	Accel/Decel Ramp Hold	V/f CL-V/f OLV CLV AOLV OLV/PM AOLV/PM CLV/PM EZOLV Momentarily pauses motor acceleration and deceleration when the terminal is turned ON, retains the output frequency that was stored in the drive at the time of the pause, and restarts motor operation.

If the terminal is turned OFF, the drive restarts acceleration and deceleration.

When $d4-01 = 1$ [Freq Reference Retention Select = Enabled], if the acceleration/deceleration ramp hold terminal is ON, the drive will store the output frequency in memory. While the acceleration/deceleration ramp hold command is ON, the drive will restart the motor at this output frequency even if the drive experiences a run stop or momentary power loss.

Note:

Refer to “d4-01: Freq Reference Retention Select” for details.

■ **B: Drive Overheat Alarm (oH2)**

Setting	Function	Description
B	Drive Overheat Alarm (oH2)	V/f CL-V/f OLV CLV AOLV OLV/PM AOLV/PM CLV/PM EZOLV If the terminal is turned ON, the keypad flashes an <i>oH2</i> [Drive Overheat Warning] minor fault message. The fault does not affect drive operation.

■ **C: Analog Terminal Input Selection**

Setting	Function	Description
C	Analog Terminal Input Selection	V/f CL-V/f OLV CLV AOLV OLV/PM AOLV/PM CLV/PM EZOLV Enables and disables the terminal selected with the <i>H3-14</i> [Analog Input Term Enable Select] function.

ON : Terminal selected with H3-14 is enabled

OFF : Terminal selected with H3-14 is disabled**■ D: PG Encoder Disable**

Setting	Function	Description
D	PG Encoder Disable	<div style="display: flex; justify-content: space-between; font-size: small;"> V/f CL-V/f OLV CLV AOLV OLV/PM AOLV/PM CLV/PM EZOLV </div> <p>Disregards feedback control from the encoder and runs V/f Control run if the terminal is turned ON. Controls the motor speed using feedback from the encoder if the terminal is turned OFF.</p>

ON : Speed feedback control disable (V/f Control)**OFF : Speed feedback control enable (Closed Loop V/f Control)****■ E: ASR Integral Reset**

Setting	Function	Description
E	ASR Integral Reset	<div style="display: flex; justify-content: space-between; font-size: small;"> V/f CL-V/f OLV CLV AOLV OLV/PM AOLV/PM CLV/PM EZOLV </div> <p>Resets the integral value and switches the speed control loop between PI control and P control.</p>

ON : P control**OFF : PI control****■ F: Through Mode**

Setting	Function	Description
F	Through Mode	<div style="display: flex; justify-content: space-between; font-size: small;"> V/f CL-V/f OLV CLV AOLV OLV/PM AOLV/PM CLV/PM EZOLV </div> <p>Set when a terminal is not used or when using a terminal in through mode.</p>

The through mode is a function that uses the signal input to the terminal as a digital input for the upper sequence via a communication option or MEMOBUS/Modbus communications. This input signal does not affect drive operation.

■ 10: Up Command

Setting	Function	Description
10	Up Command	<div style="display: flex; justify-content: space-between; font-size: small;"> V/f CL-V/f OLV CLV AOLV OLV/PM AOLV/PM CLV/PM EZOLV </div> <p>It is paired with setting value 11 (Down command). When using the Up command and Down command, the user can raise and lower the frequency reference of the drive using two push buttons.</p>

ON : Raises the frequency reference.**OFF : Holds the current frequency reference.****Note:**

- If only one of either the Up command or Down command has been set, *oPE03 [Multi-Function Input Setting Err]* will be detected.
- If two or more of the following functions have been allocated at the same time, *oPE03* occurs.
 - Up/Down command
 - Accel/Decel Ramp Hold
 - Reference sample hold
 - Offset Frequency 1, 2, 3 addition
 - Up/Down 2 Command
- The Up/Down command can be used when the keypad is in REMOTE mode or *b1-01 ≠ 0 [Frequency Reference Selection 1 ≠ Keypad]*.
- The Up/Down command does not function when switching to parameter *b1-15 [Frequency Reference Selection 2]* using *External Reference 1/2 Selection [H1-xx = 2]*.

If the Up command is input, the frequency reference increases, and if Down command is input, the frequency reference decreases.

Up and Down command has priority over all other frequency references. When the Up/Down command is enabled, the following frequency references will be disregarded.

- Frequency reference from Keypad [*b1-01 = 0*]
- Frequency reference from Analog Input [*b1-01 = 1*]
- Frequency reference from Pulse Train Input [*b1-01 = 4*]

The table below shows the Up and Down commands with their corresponding operation.

Table 11.46 Up Command and Down Command

Command status		Drive operation
Up command (10)	Down command (11)	
OFF	OFF	Holds the current frequency reference.
ON	OFF	Raises the frequency reference.
OFF	ON	Lowers the frequency reference.
ON	ON	Holds the current frequency reference.

Combine Frequency Reference Hold Functions and Up/Down Commands

- When the Run command is cleared, or when the drive is restarted when $d4-01 = 0$ [*Freq Reference Retention Function = Disabled*], the Up/Down command will reset to 0.
- When parameter $d4-01 = 1$ [*Enabled*], the drive saves the frequency reference set during the Up/Down command. If the Run command is cycled or the drive is restarted, the drive stores the frequency reference value and restarts the motor at this frequency value. After the Run command is cleared, turn ON the terminal set for the Up command or Down command to reset the stored reference value to 0.

Note:

Refer to “d4-01: Freq Reference Retention Select” for details.

Combining Upper/Lower Limits of the Frequency Reference and the Up/Down Commands

Set the upper limit value of the frequency reference to $d2-01$ [*Frequency Reference Upper Limit*].

The lower limit value of the frequency reference can be set with analog input or $ind2-02$ [*Frequency Reference Lower Limit*]. The configurable values differ depending on the setting for $d4-10$ [*Up/Down Freq Lower Limit Select*]. When the Run command is executed, the lower limits of the frequency reference are as follows.

- When the lower limit of the frequency reference is set only for $d2-02$, the drive accelerates the motor up to the lower limit value of the frequency reference at the same time the Run command is input.
- When the lower limit of the frequency reference is set only for analog input, the drive accelerates the motor up to the lower limit value of the frequency reference when the Run command, and Up command or Down command for the drive is enabled. When only the Run command is enabled, the motor does not start.
- When the following conditions are present, the drive accelerates the motor up to $d2-02$ setting value if the Run command is input. When the motor has accelerated to the setting value of $d2-02$, if the Up/Down command is enabled, the motor accelerates to the lower limit value of the analog input.
 - The lower limit value of the frequency reference is set for both the analog input and $d2-02$
 - The lower limit value of the analog input is higher than the setting value of $d2-02$

Note:

Refer to “d4-10: Up/Down Freq Lower Limit Select” for details.

The following time chart shows an example of how Up/Down command operates. In this example, the lower limit value of the frequency reference is set in $d2-02$. The time chart when *Freq Reference Retention Select* [$d4-01$] is enabled and disabled is shown below.

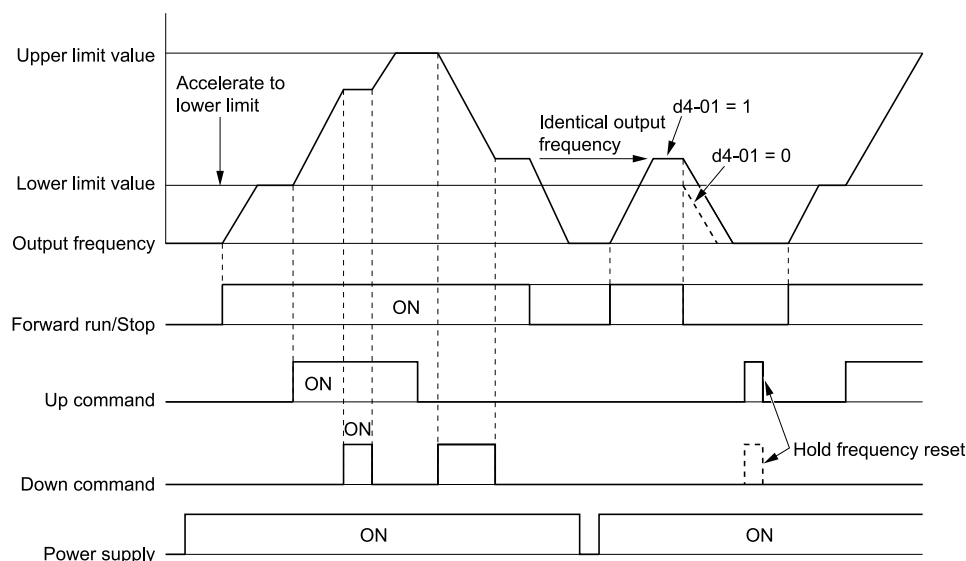

Figure 11.76 Up/Down Command Time Chart

■ 11: Down Command

Setting	Function	Description
11	Down Command	<div style="display: flex; justify-content: space-between; font-size: small;"> V/f CL-V/f OLV CLV AOLV OLV/PM AOLV/PM CLV/PM EZOLV </div> <p>It is paired with setting value 10 (Up command). When using the Up command and Down command, the user can raise and lower the frequency reference of the drive using two push buttons.</p>

ON : Lowers the frequency reference.

OFF : Holds the current frequency reference.

Note:

- If only one of either the Up command or Down command has been set, *oPE03 [Multi-Function Input Setting Err]* will be detected.
- If two or more of the following functions have been allocated at the same time, *oPE03* occurs.
 - Up/Down command
 - Accel/Decel Ramp Hold
 - Reference sample hold
 - Offset Frequency 1, 2, 3 addition
 - Up/Down 2 Command
- The Up/Down command can be used when the keypad is in REMOTE mode or *b1-01 ≠ 0 [Frequency Reference Selection 1 ≠ Keypad]*.
- The Up/Down command does not function when switching to parameter *b1-15 [Frequency Reference Selection 2]* using *External Reference 1/2 Selection [H1-xx = 2]*.

If the Up command is input, the frequency reference increases, and if Down command is input, the frequency reference decreases.

Up and Down command has priority over all other frequency references. When the Up/Down command is enabled, the following frequency references will be disregarded.

- Frequency reference from Keypad [*b1-01 = 0*]
- Frequency reference from Analog Input [*b1-01 = 1*]
- Frequency reference from Pulse Train Input [*b1-01 = 4*]

■ 12: Forward Jog

Setting	Function	Description
12	Forward Jog	<div style="display: flex; justify-content: space-between; font-size: small;"> V/f CL-V/f OLV CLV AOLV OLV/PM AOLV/PM CLV/PM EZOLV </div> <p>Inputting the Forward JOG command runs the motor in the forward direction at the jog frequency set in <i>d1-17 [Jog Reference]</i>.</p>

Note:

- There is no need to input the Run command.
- The Forward JOG command has priority over all other frequency references.
- The drive performs ramp to stop when the Forward JOG and Reverse JOG commands have been turned ON at the same time for 500 ms or more.

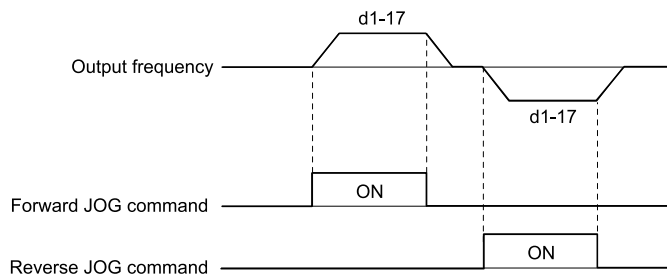

Figure 11.77 JOG Operation Pattern

■ 13: Reverse Jog

Setting	Function	Description
13	Reverse Jog	<div style="display: flex; justify-content: space-between; font-size: small;"> V/f CL-V/f OLV CLV AOLV OLV/PM AOLV/PM CLV/PM EZOLV </div> <p>Inputting the Reverse JOG command reverses the motor at the jog frequency set in <i>d1-17 [Jog Reference]</i>.</p>

Note:

- There is no need to input the Run command.
- The Reverse JOG command has priority over all other frequency references.
- The drive performs ramp to stop when the Forward JOG and Reverse JOG commands have been turned ON at the same time for 500 ms or more.

■ 14: Fault Reset

Setting	Function	Description
14	Fault Reset	<div style="display: flex; justify-content: space-between; font-size: small;"> V/f CL-V/f OLV CLV AOLV OLV/PM AOLV/PM CLV/PM EZOLV </div> <p>When the terminal is ON while the Run command is inactive, the fault currently detected by the drive will be reset.</p>

When a fault is detected, the drive turns ON the fault relay output and shuts off the output. The motor coasts to stop.

When a fault is detected for which the stopping method can be selected, apply the selected Stopping Method.

Then press the  (RESET) on the keypad to turn the Run command OFF, or reset the fault by setting the fault reset terminal ON.

Note:

The fault reset signal is disregarded when the Run command is enabled. Remove the Run command before attempting to clear a fault situation.

■ 15: Fast Stop (N.O.)

Setting	Function	Description
15	Fast Stop (N.O.)	<div style="display: flex; justify-content: space-between; font-size: small;"> V/f CL-V/f OLV CLV AOLV OLV/PM AOLV/PM CLV/PM EZOLV </div> <p>When Fast Stop (N.O.) is input while the drive is running, the drive performs ramp to stop in a deceleration time configured with C1-09 [Fast Stop Time].</p>

The drive will not restart the motor after fast stop input has been canceled until the following conditions are met.

- The motor is completely stopped.
- The Run command is canceled.
- The fast stop command is canceled.

Note:

- Set 17 (Fast Stop (N.C.)) to input the emergency stop command using the N.C. switch.
- Refer to “C1-09: Fast Stop Time” for details.

NOTICE: Rapid deceleration can trigger an overvoltage fault. Set an appropriate Fast Stop time in C1-09 [Fast Stop Time] to avoid this uncontrolled motor state and to ensure that the motor stops quickly and safely. The drive output shuts off when faulted and the motor coasts.

■ 16: Motor 2 Selection

Setting	Function	Description
16	Motor 2 Selection	<div style="display: flex; justify-content: space-between; font-size: small;"> V/f CL-V/f OLV CLV AOLV OLV/PM AOLV/PM CLV/PM EZOLV </div> <p>Switches between motors 1 and 2. Switch between motors when they are stopped.</p>

The user can switch between 2 induction motors using an external input, and operate them. The drive saves the control methods, V/f patterns, and motor parameters of the 2 motors, and optimizes control of them both.

ON : Selects motor 2

OFF : Selects motor 1

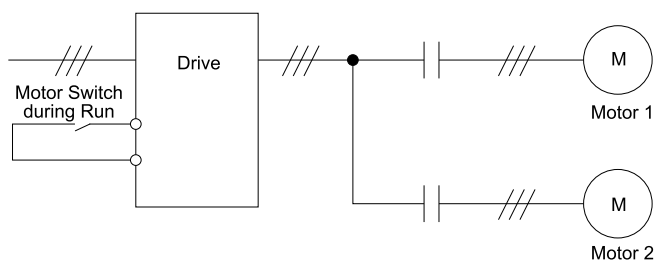

If motor 2 is selected, the parameters used by the drive are switched to the motor 2 parameters.

Table 11.47 Switch Parameters for Switching from Motor 1 to Motor 2

Parameters	Motor 2 Selection	
	OFF (Motor 1)	ON (Motor 2)
C1-xx [Accel & Decel Time]	C1-01 to C1-04	C1-05 to C1-08
C3-xx [Slip Compensation]	C3-01 to C3-04	C3-21 to C3-24
C4-xx [Torque Compensation]	C4-01	C4-07
C5-xx [Automatic Speed Regulator (ASR)]	C5-01 to C5-08, C5-12, C5-17, C5-18	C5-21 to C5-28, C5-32, C5-37, C5-38
E1-xx, E3-xx [V/f Patterns] E2-xx, E-4xx [Motor Parameters]	E1-xx, E2-xx	E3-xx, E4-xx
F1-xx [number of PG pulses per revolution]	F1-01 to F1-21	F1-02 to F1-04, F1-08 to F1-11, F1-14, F1-31 to F1-37

Note:

- When the 2 motors are used, a protective function set in L1-01 [Motor Overload Protection Select] is applied to both motors.
- Motors 1 and 2 cannot be switched while during run. Any attempt to switch the motors while they are running will produce a rUn error.
- The wait time for switchover is 500 ms when switching between encoder motors. It is 200 ms for other control methods. After the motors are switched, input a Run command after waiting over these times.

■ 17: Fast Stop (N.C.)

Setting	Function	Description
17	Fast Stop (N.C.)	<div style="display: flex; justify-content: space-between; font-size: small;"> V/f CL-V/f OLV CLV AOLV OLV/PM AOLV/PM CLV/PM EZOLV </div> <p>When Fast Stop (N.C.) is input while the drive is running, the drive performs ramp to stop in a deceleration time configured with C1-09 [Fast Stop Time].</p>

The drive will not restart the motor after fast stop input has been canceled until the following conditions are met.

- The motor is completely stopped.
- The Run command is canceled.
- The fast stop command is canceled.

Note:

- Set 15 (Fast Stop (N.O.)) to input the emergency stop command using the N.O. switch.
- Refer to “C1-09: Fast Stop Time” for details.

NOTICE: Rapid deceleration can trigger an overvoltage fault. Set an appropriate Fast Stop time in C1-09 [Fast Stop Time] to avoid this uncontrolled motor state and to ensure that the motor stops quickly and safely. The drive output shuts off when faulted and the motor coasts.

The following time chart shows an example of how fast stop operates.

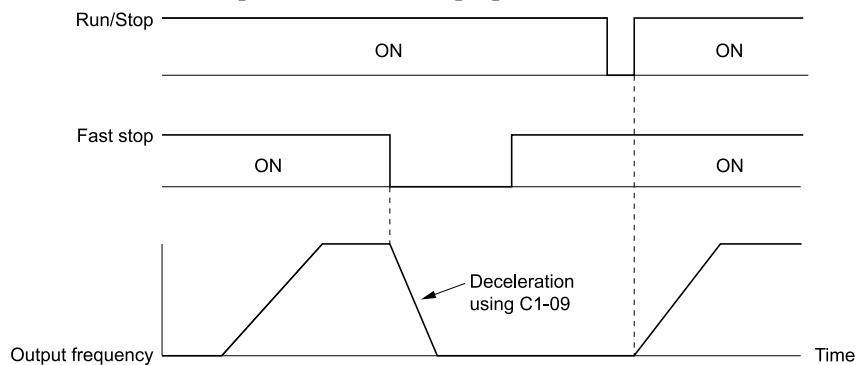

Figure 11.78 Fast Stop Time Chart

■ 18: Timer Function Input

Setting	Function	Description
18	Timer Function Input	<div style="display: flex; justify-content: space-between; font-size: small;"> V/f CL-V/f OLV CLV AOLV OLV/PM AOLV/PM CLV/PM EZOLV </div> <p>Used as the input terminal for the timer function. It is paired with <i>Timer Output</i> [H2-xx = 12].</p>

Note:

Refer to “b4: Timer Function” for details.

■ 19: PID Disable

Setting	Function	Description
19	PID Disable	<div style="display: flex; justify-content: space-between; font-size: small;"> V/f CL-V/f OLV CLV AOLV OLV/PM AOLV/PM CLV/PM EZOLV </div> <p>Disables PID control using an external input when $b5-01 = 1$ to 8 [PID Function Setting = Enabled].</p>

ON : PID control disabled

OFF : PID control enabled

■ 1A: Accel/Decel Time Selection 2

Setting	Function	Description
1A	Accel/Decel Time Selection 2	<div style="display: flex; justify-content: space-between; font-size: small;"> V/f CL-V/f OLV CLV AOLV OLV/PM AOLV/PM CLV/PM EZOLV </div> <p>It is used in combination with the <i>Accel/decel Time Selection 1</i> [$H1-xx = 7$]. Switches between $C1-01$ to $C1-08$ [Acceleration and Deceleration Times 1 to 4].</p>

Note:

Refer to “C1: Accel & Decel Time” for details.

■ 1B: Program Lockout

Setting	Function	Description
1B	Program Lockout	<div style="display: flex; justify-content: space-between; font-size: small;"> V/f CL-V/f OLV CLV AOLV OLV/PM AOLV/PM CLV/PM EZOLV </div> <p>The following parameter setting values can be changed when the terminal set for program lockout is ON. When the terminal is OFF, the setting values of parameters cannot be changed.</p>

The user can still view parameter setting values when the terminal is *OFF* [Parameters Cannot be Edited].

ON : Program Lockout

OFF : Parameter Write Prohibit

■ 1E: Reference sample hold

Setting	Function	Description
1E	Reference sample hold	<div style="display: flex; justify-content: space-between; font-size: small;"> V/f CL-V/f OLV CLV AOLV OLV/PM AOLV/PM CLV/PM EZOLV </div> <p>The analog frequency reference input via terminal A1, A2 or A3 will be sampled and operation will continue at that frequency.</p>

This function takes a sample of the analog frequency reference at the point in time 100 ms has passed since the terminal was turned ON, and holds the sample. If the sample/hold command is re-input, the function takes another sample of the analog frequency reference and holds it. If the power is shut off, the analog frequency that was saved via sampling will be erased and the frequency reference will be reset to 0.

The following illustration shows an example of how the function operates.

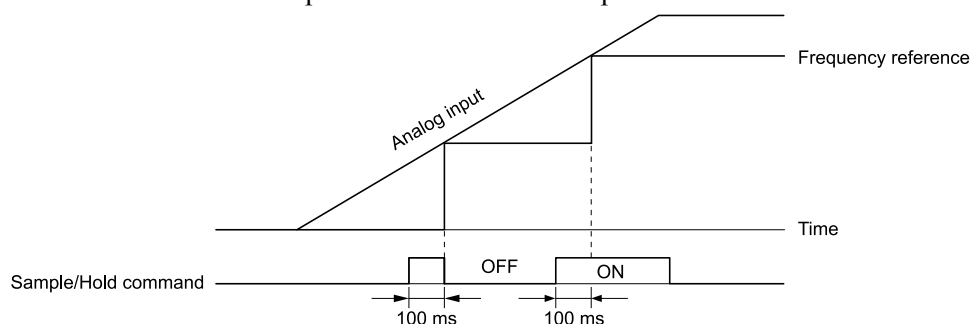

Figure 11.79 Reference sample hold

The Reference sample hold function cannot be set at the same time as the following functions. Setting them at the same time will trigger *oPE03* [Multi-Function Input Setting Err].

- $H1-xx = A$ [Accel/Decel Ramp Hold]
- $H1-xx = 10, 11$ [Up Command, Down Command]
- $H1-xx = 44$ to 46 [Offset frequency]
- $H1-xx = 75, 76$ [Up 2 Command, Down 2 Command]

■ 20 to 2F: External fault

Setting	Function	Description
20 to 2F	External fault	<div style="display: flex; justify-content: space-between; font-size: small;"> V/f CL-V/f OLV CLV AOLV OLV/PM AOLV/PM CLV/PM EZOLV </div> <p>Selects the drive operation that was active at the time the failure or fault was detected in the external device connected to the drive from any of the patterns between 20 to 2F.</p>

EFx [External fault (terminal S1)] is displayed on the keypad when external fault is input. The keypad will display EFx where x is the number of the terminal (terminal Sx) to which the external fault signal is input. For example, when an external fault signal is input to terminal S3, EF3 will be displayed on the keypad.

Select the value set in HI-xx from a combination of the following three conditions.

- Signal input method from peripheral devices
- External fault detection method
- Motor stopping method (operates after an external fault is detected)

The following table shows the relationship between the combination of conditions and the value set to HI-xx.

Table 11.48 Stopping Method upon Detection of External Fault

Setting	Signal input method from peripheral devices ^{*1}		External fault detection method ^{*2}		Stopping Method			
	N.O.	N.C.	Detection always enabled	Detection during run only	Ramp to Stop (fault)	Coast to Stop (fault)	Fast Stop (fault)	Continuous Operation (minor fault)
20	x	-	x	-	x	-	-	-
21	-	x	x	-	x	-	-	-
22	x	-	-	x	x	-	-	-
23	-	x	-	x	x	-	-	-
24	x	-	x	-	-	x	-	-
25	-	x	x	-	-	x	-	-
26	x	-	-	x	-	x	-	-
27	-	x	-	x	-	x	-	-
28	x	-	x	-	-	-	x	-
29	-	x	x	-	-	-	x	-
2A	x	-	-	x	-	-	x	-
2B	-	x	-	x	-	-	x	-
2C	x	-	x	-	-	-	-	x
2D	-	x	x	-	-	-	-	x
2E	x	-	-	x	-	-	-	x
2F	-	x	-	x	-	-	-	x

*1 Determine whether fault detection for the input signal method is either N.O. (external fault when switched ON) or N.C. (external fault when turned OFF).

*2 Decide whether detection for the fault detection method should be enabled only during run or always detected.

■ 30: PID integral reset

Setting	Function	Description
30	PID integral reset	<div style="display: flex; justify-content: space-between; font-size: small;"> V/f CL-V/f OLV CLV AOLV OLV/PM AOLV/PM CLV/PM EZOLV </div> <p>Resets the value of the PID control integral to 0 while the terminal is ON, and holds the value.</p>

Note:

Refer to “PID control block diagram” for details.

■ 31: PID integral hold

Setting	Function	Description
31	PID integral hold	<div style="display: flex; justify-content: space-between; gap: 5px;"> V/f CL-V/f OLV CLV AOLV OLV/PM AOLV/PM CLV/PM EZOLV </div> <p>This function force holds the integral value of the PID control as long as the terminal is ON.</p>

If the input terminal is turned OFF, PID control restarts the integral.

Note:

Refer to “PID control block diagram” for details.

■ 32: Multi-Step Speed Reference 4

Setting	Function	Description
32	Multi-Step Speed Reference 4	<div style="display: flex; justify-content: space-between; gap: 5px;"> V/f CL-V/f OLV CLV AOLV OLV/PM AOLV/PM CLV/PM EZOLV </div> <p>Switches <i>d1-09</i> to <i>d1-16</i> [Reference 9 to 16] using a combination of multi-step speed references 1, 2 and 3.</p>

Note:

Refer to “Setting procedure for the multi-step speed operation” for details.

■ 34: PID soft starter cancel

Setting	Function	Description
34	PID soft starter cancel	<div style="display: flex; justify-content: space-between; gap: 5px;"> V/f CL-V/f OLV CLV AOLV OLV/PM AOLV/PM CLV/PM EZOLV </div> <p>Enables or disables the PID soft starter.</p>

ON : Disabled

Disables *b5-17* [PID Accel/Decel Time].

OFF : Enabled

Enables *b5-17* [PID Accel/Decel Time].

Note:

Refer to “PID control block diagram” for details.

■ 35: PID input level selection

Setting	Function	Description
35	PID input level selection	<div style="display: flex; justify-content: space-between; gap: 5px;"> V/f CL-V/f OLV CLV AOLV OLV/PM AOLV/PM CLV/PM EZOLV </div> <p>Switches the PID input level (polarity) by turning the terminal on and off.</p>

Note:

Refer to “PID control block diagram” for details.

■ 3E: PID Setpoint Selection 1

Setting	Function	Description
3E	PID Setpoint Selection 1	<div style="display: flex; justify-content: space-between; gap: 5px;"> V/f CL-V/f OLV CLV AOLV OLV/PM AOLV/PM CLV/PM EZOLV </div> <p>It is used in combination with <i>PID Setpoint Selection 2</i> [<i>H1-xx = 3F</i>]. Switches the PID setpoint to <i>b5-58</i> to <i>b5-60</i> [PID setpoint2 to 4].</p>

Refer to “b5-58 to b5-60: PID setpoint2 to 4” for details.

■ 3F: PID Setpoint Selection 2

Setting	Function	Description
3F	PID Setpoint Selection 2	<div style="display: flex; justify-content: space-between; gap: 5px;"> V/f CL-V/f OLV CLV AOLV OLV/PM AOLV/PM CLV/PM EZOLV </div> <p>It is used in combination with <i>PID Setpoint Selection 1</i> [<i>H1-xx = 3E</i>]. Switches the PID setpoint to <i>b5-58</i> to <i>b5-60</i> [PID setpoint2 to 4].</p>

Refer to “b5-58 to b5-60: PID setpoint2 to 4” for details.

■ 40: Forward Run Command (2-Wire Seq)

Setting	Function	Description
40	Forward Run Command (2-Wire Seq)	V/f CL-V/f OLV CLV AOLV OLV/PM AOLV/PM CLV/PM EZOLV Inputs the Forward run command for 2-wire sequence 1. Use it paired with the <i>Reverse Run Command (2-Wire Seq)</i> [H1-xx = 41].

ON : Forward Run

OFF : Run Stop

Note:

- When the both Forward run command and Reverse run command terminals have been turned ON, the drive detects *EF [FWD/REV Run Command Input Error]* (minor fault), and the motor ramps to stop.
- The Forward run/Reverse run command is set to terminals S1 and S2 when the drive is initialized using a 2-wire sequence.
- Simultaneous use with H1-xx = 42, 43 [*Run Command/FWD/REV Command (2-Wire Seq 2)*] is not possible.

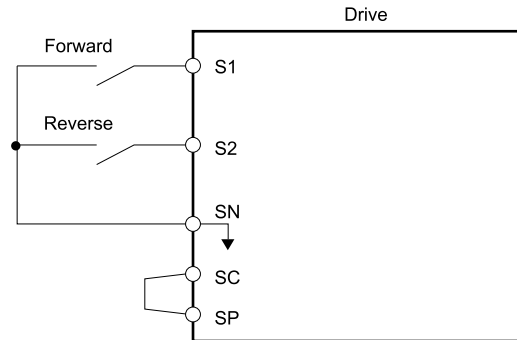

Figure 11.80 2-Wire Sequence Wiring Example

■ 41: Reverse Run Command (2-Wire Seq)

Setting	Function	Description
41	Reverse Run Command (2-Wire Seq)	V/f CL-V/f OLV CLV AOLV OLV/PM AOLV/PM CLV/PM EZOLV Inputs the Reverse run command for 2-wire sequence 1. Use it paired with the <i>Forward Run Command (2-Wire Seq)</i> [H1-xx = 40].

ON : Reverse Run

OFF : Run Stop

Note:

- When the both Forward run command and Reverse run command terminals have been turned ON, the drive detects *EF [FWD/REV Run Command Input Error]* (minor fault), and the motor ramps to stop.
- The Reverse run command is set to terminal S2 when the drive is initialized using a 2-wire sequence.
- Simultaneous use with H1-xx = 42, 43 [*Run Command/FWD/REV Command (2-Wire Seq 2)*] is not possible.

■ 42: Run Command (2-Wire Sequence 2)

Setting	Function	Description
42	Run Command (2-Wire Sequence 2)	V/f CL-V/f OLV CLV AOLV OLV/PM AOLV/PM CLV/PM EZOLV Inputs the Run command for 2-wire sequence 2. Use it paired with the <i>FWD/REV Command (2-Wire Seq 2)</i> [H1-xx = 43].

ON : Run

OFF : Stop

Note:

Run Command (2-Wire Sequence 2) cannot be used at the same time as *Forward/Reverse Run Command (2-Wire Seq)* [H1-xx = 40, 41].

■ 43: FWD/REV Command (2-Wire Seq 2)

Setting	Function	Description
43	FWD/REV Command (2-Wire Seq 2)	V/f CL-V/f OLV CLV AOLV OLV/PM AOLV/PM CLV/PM EZOLV Selects the direction of motor rotation for 2-wire sequence 2. Use it paired with the <i>Run Command (2-Wire Sequence 2)</i> [H1-xx = 42].

ON : Reverse**OFF : Forward****Note:**

- The motor will not rotate by only turning this signal ON and OFF. Input the Run command.
- FWD/REV Command (2-Wire Seq 2) cannot be used at the same time as *Forward/Reverse Run Command (2-Wire Seq) [H1-xx = 40, 41]*.

■ 44: Offset frequency 1

Setting	Function	Description
44	Offset frequency 1	V/f CL-V/f OLV CLV AOLV OLV/PM AOLV/PM CLV/PM EZOLV Adds the offset frequency set in <i>d7-01</i> to the frequency reference. when the terminal is turned ON.

Note:

Refer to “d7: Offset Frequency” for details.

■ 45: Offset frequency 2

Setting	Function	Description
45	Offset frequency 2	V/f CL-V/f OLV CLV AOLV OLV/PM AOLV/PM CLV/PM EZOLV Adds the offset frequency set in <i>d7-02</i> to the frequency reference. when the terminal is turned ON.

Note:

Refer to “d7: Offset Frequency” for details.

■ 46: Offset frequency 3

Setting	Function	Description
46	Offset frequency 3	V/f CL-V/f OLV CLV AOLV OLV/PM AOLV/PM CLV/PM EZOLV Adds the offset frequency set in <i>d7-03</i> to the frequency reference. when the terminal is turned ON.

Note:

Refer to “d7: Offset Frequency” for details.

■ 47: Node Setup

Setting	Function	Description
47	Node Setup	V/f CL-V/f OLV CLV AOLV OLV/PM AOLV/PM CLV/PM EZOLV When the CANopen communication option is utilized, the Node Setup function (a function for setting the drive node address from the host controller) is enabled.

■ 60: DC Injection Braking command

Setting	Function	Description
60	DC Injection Braking command	V/f CL-V/f OLV CLV AOLV OLV/PM AOLV/PM CLV/PM EZOLV If the DC Injection Braking command is input when the drive is performing stopping operation, DC Injection Braking is applied to stop the motor.

DC Injection Braking cancels if the Run command or JOG command are input.

The following time chart shows the DC Injection Braking function.

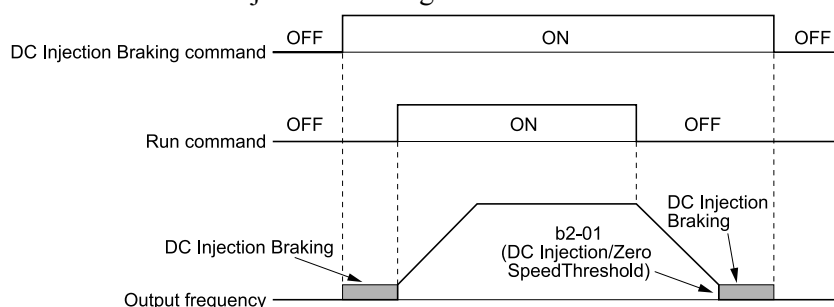

Figure 11.81 DC Injection Braking Time Chart

Note:

- This function enables only when the induction motor is used for $A1-02 = 8$ [Control Method Selection = EZ Open Loop Vector Control].
- Refer to “b2: DC Circuit Braking” for details.

■ **61: External Speed Search command 1**

Setting	Function	Description
61	External Speed Search command 1	<div style="display: flex; justify-content: space-between; align-items: center;"> V/f CL-V/f OLV CLV AOLV OLV/PM AOLV/PM CLV/PM EZOLV </div> Executes speed search using an external reference even when $b3-01 = 0$ [Speed Search Selection at Start = Disabled].

When the terminal is turned ON for $b3-24 = 2$ [Speed Search Method Selection = Current Detection 2], the drive starts speed search from the maximum output frequency.

Note:

- If both $H1-xx = 61$ and 62 are set simultaneously, $oPE03$ [Multi-Function Input Setting Err] is detected. Set the external speed search command for only 1 or 2.
- Refer to “b3: Speed Search” for details.

■ **62: External Speed Search command 2**

Setting	Function	Description
62	External Speed Search command 2	<div style="display: flex; justify-content: space-between; align-items: center;"> V/f CL-V/f OLV CLV AOLV OLV/PM AOLV/PM CLV/PM EZOLV </div> Executes speed search using an external reference even when $b3-01 = 0$ [Speed Search Selection at Start = Disabled].

When the terminal is turned ON for $b3-24 = 2$ [Speed Search Method Selection = Current Detection 2], the drive starts speed search from the frequency reference.

Note:

- If both $H1-xx = 61$ and 62 are set simultaneously, $oPE03$ [Multi-Function Input Setting Err] is detected. Set the external speed search command for only 1 or 2.
- Refer to “b3: Speed Search” for details.

■ **63: Field weakening**

Setting	Function	Description
63	Field weakening	<div style="display: flex; justify-content: space-between; align-items: center;"> V/f CL-V/f OLV CLV AOLV OLV/PM AOLV/PM CLV/PM EZOLV </div> This function issues the commands of Field Weakening Level and Field Weakening Frequency Limit set in $d6-01$ and $d6-02$ when the input terminal is turned ON

Note:

Refer to “d6: Field Weak & Field Force” for details.

■ **65: KEB Ride-Thru 1 (N.C.)**

Setting	Function	Description
65	KEB Ride-Thru 1 (N.C.)	<div style="display: flex; justify-content: space-between; align-items: center;"> V/f CL-V/f OLV CLV AOLV OLV/PM AOLV/PM CLV/PM EZOLV </div> Switches the KEB1 function between enable and disable via the KEB Ride-Thru 1 (N.C.).

ON : Normal operation

OFF : Deceleration during momentary power loss

When KEB Ride-Thru 1 is enabled, set $L2-29$ [KEB Method Selection]. The drive operates with the KEB method that was selected.

Note:

- If *KEB Ride-Thru 1* [$H1-xx = 65, 66$] and *KEB Ride-Thru 2* [$H1-xx = 7A, 7B$] are set simultaneously, $oPE03$ [Multi-Function Input Setting Err] is detected.
- Refer to “KEB Ride-Thru function” for details.

■ **66: KEB Ride-Thru 1 (N.O.)**

Setting	Function	Description
66	KEB Ride-Thru 1 (N.O.)	<div style="display: flex; justify-content: space-between; align-items: center;"> V/f CL-V/f OLV CLV AOLV OLV/PM AOLV/PM CLV/PM EZOLV </div> Switches the KEB1 function between enable and disable via the KEB Ride-Thru 1 (N.O.).

ON : Deceleration during momentary power loss

OFF : Normal operation

When KEB Ride-Thru 1 is enabled, set *L2-29 [KEB Method Selection]*. The drive operates with the KEB method that was selected.

Note:

- If *KEB Ride-Thru 1 [H1-xx = 65, 66]* and *KEB Ride-Thru 2 [H1-xx = 7A, 7B]* are set simultaneously, *oPE03 [Multi-Function Input Setting Err]* is detected.
- Refer to “KEB Ride-Thru function” for details.

67: Communications test mode

Setting	Function	Description
67	Communications test mode	V/f CL-V/f OLV CLV AOLV OLV/PM AOLV/PM CLV/PM EZOLV Performs self-diagnosis on the RS-485 serial communications operation.

Self-Diagnostics function connects the transmission terminal of the control terminal block with the reception terminal and transmits the data that the drive has sent, checking whether the drive is able to communicate normally.

Note:

Refer to MEMOBUS/Modbus communications “Self-Diagnostics” for the self-diagnostics procedure.

68: High Slip Braking (HSB)

Setting	Function	Description
68	High Slip Braking (HSB)	V/f CL-V/f OLV CLV AOLV OLV/PM AOLV/PM CLV/PM EZOLV Stops the motor using high-slip braking.

Note:

- When restarting the drive after performing high-slip braking, ensure that the drive completely stops the motor and clear the high-slip braking input.
- Refer to “n3: High Slip/Overex Braking” for details.

6A: Drive Enable

Setting	Function	Description
6A	Drive Enable	V/f CL-V/f OLV CLV AOLV OLV/PM AOLV/PM CLV/PM EZOLV The keypad displays <i>dnE [Drive Enabled]</i> when the terminal is turned OFF and the Run command will not be accepted.

When the Run command is input in the drive prior to turning On the terminal assigned for Drive Enable, the drive will not operate until the Run command is re-input. When the drive is operating, if the terminal that is assigned for Drive Enable has been turned OFF, the drive stops the motor using the method set in *b1-03 [Stopping Method Selection]*.

ON : Run command is accepted.

OFF : Run command is disabled. When the drive is running, it stops according to *b1-03* setting.

71: Speed/Torque Control Switch

Setting	Function	Description
71	Speed/Torque Control Switch	V/f CL-V/f OLV CLV AOLV OLV/PM AOLV/PM CLV/PM EZOLV Switches between torque and speed control.

ON : Torque control

OFF : Speed control

Note:

Set *d5-01 = 0 [Torque Control Selection = Speed Control]* when this function is enabled.

Input the Speed/Torque Control Switchover Time

The user can set the time it takes for control to switchover after the speed/torque control switchover signal is input in *d5-06 [Speed/Torque Changeover Time]* using units of milliseconds. The three analog inputs hold at the values present at the time the speed/torque control switchover signal is changed within the time of *d5-06*. Complete the signal switchover with an external source within this time.

Note:

Refer to “Switch Speed Control and Torque Control” for details.

■ **72: Zero Servo**

Setting	Function	Description
72	Zero Servo	<div style="display: flex; justify-content: space-between; font-size: small;"> V/f CL-V/f OLV CLV AOLV OLV/PM AOLV/PM CLV/PM EZOLV </div> <p>Holds the motor when it is stopped.</p>

Holds the motor when it is stopped even though an external force is applied or an analog reference is offset.

Note:

- Refer to “b9: Zero Servo” for details.

- Leave the Run command ON when using the Zero Servo function. Zero servo stops the motor and it loses power if the Run command is turned OFF.

■ **75: Up 2 Command**

Setting	Function	Description
75	Up 2 Command	<div style="display: flex; justify-content: space-between; font-size: small;"> V/f CL-V/f OLV CLV AOLV OLV/PM AOLV/PM CLV/PM EZOLV </div> <p>Accelerates the motor by increasing the frequency reference bias value when the terminal is turned ON. Always set the Up2 command and Down 2 command as a pair.</p>

If the input terminal set for the Up 2 Command is turned ON, the bias increases, and if the terminal set for the Down 2 Command is turned ON, the bias decreases. When both commands are turned ON or OFF, the frequency reference is held. The following table describes the relationship between operation of the Up/Down 2 Command and *d4-01*, *d4-03*, *d4-05*.

Note:

- When the Up2/Down2 function is used, set the optimal bias limit value using *d4-08* and *d4-09* [*Up/Down 2 Bias Upper Limit/Lower Limit (Up/Down 2)*].

- Refer to “d4: FreqRef Hold&Up/Down Func” for details.

Table 11.49 Up 2 Command, Down 2 Command

Function	Frequency reference source	d4-03	d4-05	d4-01	Operation	Storing the frequency reference or frequency bias
1	Multi-step speed reference	0.00	0	0	<ul style="list-style-type: none"> The drive accelerates the motor while the Up 2 command is turned ON. (increases the bias value) The drive decelerates the motor while the Down 2 command is turned ON. (reduces the bias value) When the Up 2 command or Down 2 command are not inputted, or when both commands are enabled, the drive holds the output frequency. (holds the bias value) Resets the bias if the frequency changes. In any other state, the drive operates following the frequency reference. 	Not stored.
2				1		When the bias value and frequency reference are constant within 5 seconds after frequency reference hold starts, the bias value will be added to the enabled frequency reference and then it will be reset.
3				-		Not stored.
4	Multi-step speed reference	> 0	-	0	<ul style="list-style-type: none"> The drive accelerates the motor up to "Freq Reference + d4-03" while the Up 2 command is turned ON. (the bias value increases up to the value set in d4-03) If the Down2 command is enabled, the drive decelerates the motor to "Freq Reference - d4-03." (the bias value reduces to the value set in d4-03) When the Up 2 command or Down 2 command are not inputted, or when both commands are enabled, the drive holds the output frequency. (holds the bias value) Resets the bias if the frequency changes. In any other state, the drive operates following the frequency reference. 	Not stored.
5				1		When the bias value and frequency reference are constant within 5 seconds after frequency reference hold starts, the bias value will be added to the enabled frequency reference and then it will be reset.
6	Others (Analog input, transmission)	0	0	0	<ul style="list-style-type: none"> The drive accelerates the motor while the Up 2 command is turned ON. (increases the bias value) The drive decelerates the motor while the Down 2 command is turned ON. (reduces the bias value) When the Up 2 command or Down 2 command are not inputted, or when both commands are enabled, the drive holds the output frequency (holds the bias value) During acceleration or deceleration, when the frequency reference is changed to a value other than that set in d4-07, the drive holds the bias value until the output frequency and the actual frequency reference match (speed agreement). 	Not stored.
7				1		When the bias value is constant within 5 seconds after frequency reference hold starts, the bias value being held is stored in d4-06. Rewriting the frequency reference is not possible. Only the bias value is stored.

Function	Frequency reference source	d4-03	d4-05	d4-01	Operation	Storing the frequency reference or frequency bias
8	Others (Analog input, transmission)	0	1	-	<ul style="list-style-type: none"> The drive accelerates the motor while the Up 2 command is turned ON. (increases the bias value) The drive decelerates the motor while the Down 2 command is turned ON. (reduces the bias value) In any other state, the drive operates following the frequency reference. 	Not stored.
9		> 0	-	0	<ul style="list-style-type: none"> The drive accelerates the motor up to "Freq Reference + d4-03" while the Up 2 command is turned ON. (the bias value increases up to the value set in d4-03) The drive decelerates the motor up to "Freq Reference + d4-03" while the Down 2 command is turned ON. (the bias value reduces to the value set in d4-03) During acceleration or deceleration, when the frequency reference is changed to a value other than that set in d4-07, the drive holds the bias value until the output frequency and the actual frequency reference match (speed agreement). 	Not stored.
10				1		When the bias value is constant within 5 seconds after frequency reference hold starts, the bias value being held is stored in d4-06. Rewriting the frequency reference is not possible. Only the bias value is stored.

■ 76: Down 2 Command

Setting	Function	Description
76	Down 2 Command	<div style="display: flex; justify-content: space-between; align-items: center;"> V/f CL-V/f OLV CLV AOLV OLV/PM AOLV/PM CLV/PM EZOLV </div> <p>Decelerates the motor by reducing the frequency reference bias value when the terminal is turned ON. Always set the Up2 command and Down 2 command as a pair.</p>

If the input terminal set for the Up 2 Command is turned ON, the bias increases, and if the terminal set for the Down 2 Command is turned ON, the bias decreases. When both commands are turned ON or OFF, the frequency reference is held.

Note:

- When the Up2/Down2 function is used, set the optimal bias limit value using d4-08 and d4-09 [Up/Down 2 Bias Upper Limit/Lower Limit (Up/Down 2)].
- Refer to "d4: FreqRef Hold&Up/Down Func" for details.

■ 77: ASR Gain Switch

Setting	Function	Description
77	ASR Gain Switch	<div style="display: flex; justify-content: space-between; align-items: center;"> V/f CL-V/f OLV CLV AOLV OLV/PM AOLV/PM CLV/PM EZOLV </div> <p>Switches the ASR proportional gain set in C5-01 [ASR Proportional Gain 1] and C5-03 [ASR Proportional Gain 1/2].</p>

ON : C5-03

Switches the proportional gain to C5-03 [ASR Proportional Gain 2].

OFF : C5-01

Switches the proportional gain to C5-01 [ASR Proportional Gain 1].

Note:

Refer to "C5: Automatic Speed Regulator (ASR)" for details.

■ 78: Ex.Torque Ref Polarity Inversion

Setting	Function	Description
78	Ex.Torque Ref Polarity Inversion	<div style="display: flex; justify-content: space-between; align-items: center;"> V/f CL-V/f OLV CLV AOLV OLV/PM AOLV/PM CLV/PM EZOLV </div> <p>Switches the rotation direction of the external torque reference.</p>

ON : External torque reference reverse direction

OFF : External torque reference forward direction

■ 7A: KEB Ride-Thru 2 (N.C.)

Setting	Function	Description
7A	KEB Ride-Thru 2 (N.C.)	<div style="display: flex; justify-content: space-between; align-items: center;"> V/f CL-V/f OLV CLV AOLV OLV/PM AOLV/PM CLV/PM EZOLV </div> <p>Switches the KEB 2 Ride-Thru function between enable and disable via the KEB Ride-Thru 2 (N.C.).</p>

ON : Normal operation

OFF : Deceleration during momentary power loss

When KEB Ride-Thru 2 is input, KEB operation is performed using Single Drive KEB Ride-Thru 2 regardless of L2-29 [KEB Method Selection].

Note:

- If KEB Ride-Thru 1 [H1-xx = 65, 66] and KEB Ride-Thru 2 [H1-xx = 7A, 7B] are set simultaneously, oPE03 [Multi-Function Input Setting Err] is detected.
- Refer to “KEB Ride-Thru function” for details.

■ 7B: KEB Ride-Thru 2 (N.O.)

Setting	Function	Description
7B	KEB Ride-Thru 2 (N.O.)	<div style="display: flex; justify-content: space-between; align-items: center;"> V/f CL-V/f OLV CLV AOLV OLV/PM AOLV/PM CLV/PM EZOLV </div> <p>Switches the KEB 2 Ride-Thru function between enable and disable via the KEB Ride-Thru 2 (N.O.).</p>

ON : Deceleration during momentary power loss

OFF : Normal operation

When KEB Ride-Thru 2 is input, KEB operation is performed using Single Drive KEB Ride-Thru 2 regardless of L2-29 [KEB Method Selection].

Note:

- If KEB Ride-Thru 1 [H1-xx = 65, 66] and KEB Ride-Thru 2 [H1-xx = 7A, 7B] are set simultaneously, oPE03 [Multi-Function Input Setting Err] is detected.
- Refer to “KEB Ride-Thru function” for details.

■ 7C: Short Circuit Braking (N.O.)

Setting	Function	Description
7C	Short Circuit Braking (N.O.)	<div style="display: flex; justify-content: space-between; align-items: center;"> V/f CL-V/f OLV CLV AOLV OLV/PM AOLV/PM CLV/PM EZOLV </div> <p>Enables and disables Short Circuit Braking. (N.O.)</p>

When the three-phase PM motor short circuits, the drive generates braking torque in the spinning motor. It stops motor rotation, uses a motor fan and also prevents the inertial spinning of the motor due to external forces.

Note:

- This function enables only when the PM motor is used for A1-02 = 8 [Control Method Selection = EZ Open Loop Vector Control].
- Refer to “b2: DC Circuit Braking” for details.

ON : Short Circuit Braking is enabled.

OFF : Normal operation

■ 7D: Short Circuit Braking (N.C.)

Setting	Function	Description
7D	Short Circuit Braking (N.C.)	<div style="display: flex; justify-content: space-between; align-items: center;"> V/f CL-V/f OLV CLV AOLV OLV/PM AOLV/PM CLV/PM EZOLV </div> <p>Enables and disables Short Circuit Braking. (N.C.)</p>

When the three-phase PM motor short circuits, the drive generates braking torque in the spinning motor. It stops motor rotation, uses a motor fan and also prevents the inertial spinning of the motor due to external forces.

Note:

- This function enables only when the PM motor is used for A1-02 = 8 [Control Method Selection = EZ Open Loop Vector Control].
- Refer to “b2: DC Circuit Braking” for details.

ON : Normal operation

OFF : Short Circuit Braking is enabled.

■ **7E: FWD/REV Detect (V/f w/ simplePG)**

Setting	Function	Description
7E	FWD/REV Detect (V/f w/ simplePG)	V/f CL-V/f OLV CLV AOLV OLV/PM AOLV/PM CLV/PM EZOLV Allows the rotation direction of the motor to be set when $F1-21, F1-37 = 0$ [Encoder Option Function Selection = A pulse detection] for Simple Closed Loop V/f Control method and Closed Loop V/f Control method.

ON : Reverse

Recognizes if the motor is rotating in the reverse direction.

OFF : Forward

Recognizes if the motor is rotating in the forward direction.

■ **90 to 97: DriveWorksEZ Digital Inputs 1 to 8**

Setting	Function	Description
90 to 97	DriveWorksEZ Digital Inputs 1 to 8	V/f CL-V/f OLV CLV AOLV OLV/PM AOLV/PM CLV/PM EZOLV A setting parameter for digital inputs used with DriveWorksEZ. Refer to the DriveWorksEZ Online Manual for more details.

Note:

The setting values 90 to 97 cannot be set for inversion input.

■ **9F: DriveWorksEZ Disable**

Setting	Function	Description
9F	DriveWorksEZ Disable	V/f CL-V/f OLV CLV AOLV OLV/PM AOLV/PM CLV/PM EZOLV Enables and disables the DriveWorksEZ program that is saved in the drive.

Note:

This function can only be used when $A1-07 = 2$ [DriveWorksEZ Function Selection = Digital input].

ON : Disabled

OFF : Enabled

◆ **H2: Multi-function digital output**

H2 parameters are used to configure MFDO terminals.

■ **H2-01 through H2-04 Function selection for terminals M1-M2, M3-M4, P1-C1, and P2-C2**

This product is equipped with four MFDO terminals. The following table lists the functions according to the default settings.

No.	Name	Default Setting	Function
H2-01	Terminal M1-M2 Function Select (contact)	0	During Run
H2-02	Terminal M3-M4 Function Select (contact)	1	Zero Speed
H2-03	Terminal P1-PC Function Select (open-collector)	2	Speed Agree 1
H2-04	Terminal P1-PC Function Select (open-collector)	F	Through Mode

Refer to the following table when configuring H2-xx [MFDO Function Select].

Table 11.50 MFDO setting value

Setting	Function	Setting	Function
0	During Run	3	User-set Speed Agree 1
1	Zero Speed	4	Frequency Detection 1
2	Speed Agree 1	5	Frequency Detection 2

Setting	Function	Setting	Function
6	Drive Ready	33	Zero Servo Complete
7	DC Bus Undervoltage	37	During Frequency Output
8	During Baseblock (N.O.)	38	Drive Enabled
9	Frequency Reference Source	39	Watt Hour Pulse Output
A	Run Command Source	3C	LOCAL/REMOTE Status
B	Torque Detection 1 (N.O.)	3D	During Speed Search
C	Frequency Reference Loss	3E	PID Feedback Low
D	Braking Resistor Fault	3F	PID Feedback High
E	Fault	4A	During KEB Ride-Thru
F	Through Mode	4B	During Short Circuit Braking
10	Minor Fault	4C	During Fast Stop
11	Fault Reset Command Active	4D	oH Pre-Alarm Time Limit
12	Timer Output	4E *1	Braking Transistor Fault (rr)
13	Speed Agree 2	4F *1	Braking Resistor Overheat (oH)
14	User-set Speed Agree 2	60	Internal Cooling Fan Alarm
15	Frequency Detection 3	61	RotorPosition Detection Complete
16	Frequency Detection 4	62	MEMOBUS Register 1 (H2-07&H2-08)
17	Torque Detection 1 (N.C.)	63	MEMOBUS Register 2 (H2-09&H2-10)
18	Torque Detection 2 (N.O.)	65	Standby output
19	Torque Detection 2 (N.C.)	66	Comparator1
1A	During Reverse	67	Comparator2
1B	During Baseblock (N.C.)	69	External Power 24V Supply
1C	Motor 2 Selection	90	DriveWorksEZ Digital Outputs 1
1D	During Regeneration	91	DriveWorksEZ Digital Outputs 2
1E	Restart Enabled	92	DriveWorksEZ Digital Outputs 3
1F	Motor Overload Alarm (oL1)	100 to 192	Inverse output of 0 through 92 Generates inverse output of the function for the selected MFDO. Selects the function for which to generate inverse output with the last two digits (00 through 9F) of 1xx.
20	Drive Overheat Pre-Alarm (oH)		
22	Mechanical Weakening Detection		
2F	Maintenance Period		
30	During Torque Limit		
31	During speed limit		
32	During Spd Limit inTorqueControl		

*1 This parameter cannot be configured on models 2169 through 2415 and 4089 through 4675.

■ Extend MFDI1 through 3 Function Selection

Multi-function output functions can be assigned to *bit 0 through bit 2 [Extend MFDI1 through 3 Function Selection]* of MEMOBUS register 15E0 (Hex.). Select the function with *H2-40 through H2-42 [Extend MFDI1 through 3 Function Selection]*.



Figure 11.82 Functional Block Diagram of MEMOBUS Multi-function Output

Table 11.51 MEMOBUS MFDO Registers

Register No. (Hex.)	Name	
15E0	bit0	MEMOBUS MFDO 1
	bit1	MEMOBUS MFDO 2
	bit2	MEMOBUS MFDO 3

Note:

- Refer to H2-xx “MFDO Setting Values” for more information on MFDO setting values.
- Configure such that H2-40 through H2-42 = F when not assigning functions to these outputs.

Output of Logical Calculation Results of MFDO

This enables the logical calculation results of two MFDOs to be output to one MFDO terminal.

Selects the function of the output signal for which logical operations are performed with H2-60, H2-63, H2-66, and H2-69 [Digital Output 1 Secondary Func through Digital Output 4 Secondary Func].

Selects the logical operation with H2-61, H2-64, H2-67, and H2-70 [Digital Output 1 Logical Operation through Digital Output 4 Logical Operation].

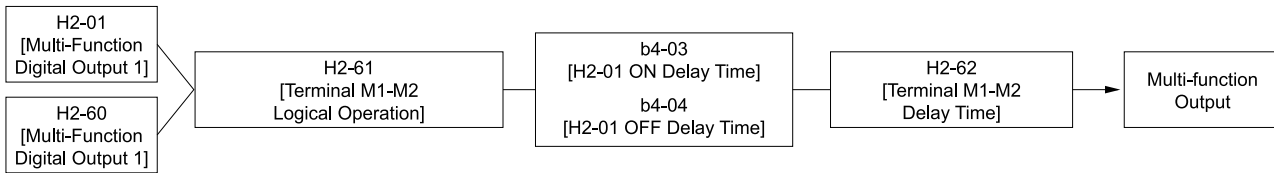

Figure 11.83 Functional Block Diagram of Logical Operation Output for MFDO 1

Table 11.52 MFDO Logical Operation Table

Logical operation selection	Logical operation expression	Logical operation notation
H2-61, H2-64, H2-67, and H2-70		
0	A=1 and B=0	
1	A=1 or B=0	
2	A=0 or B=0	
3	A=B=0	
4	A=B	A=B
5	A != B	
6	AND(A, B)	
7	OR(A, B)	
8	-	On

Note:

- Configuration of H2-01 = 1xx [Inverse Output of xx] cannot be selected when using the function to output logical calculation results. oPE02 [Parameter Range Setting Error] appears.
- Values 0 [3-Wire Sequence] and 20 through 2F [External fault] cannot be selected for H2-60, H2-63, H2-66, and H2-69.
- Configure such that H2-60, H2-63, H2-66, and H2-69 = F when not using the terminal. However, the through mode function is not supported.

◆ H2 MFDO Parameters

■ H2-01: Terminal M1-M2 Function Select

No. (Hex.)	Name	Description	Default (Range)
H2-01 (040B)	Term M1-M2 Function Selection	V/f CL-V/f OLV CLV AOLV OLV/PM AOLV/PM CLV/PM EZOLV Selects the function assigned to MFDO terminal M1-M2.	0 (0 - 1A7)

Note:

Set this parameter to *F* when not using the terminal or to use the terminal in through mode.

■ H2-02: Terminal M3-M4 Function Select

No. (Hex.)	Name	Description	Default Setting (Range)
H2-02 (040C)	Term M3-M4 Function Selection	V/f CL-V/f OLV CLV AOLV OLV/PM AOLV/PM CLV/PM EZOLV Selects the function assigned to MFDO terminal M3-M4.	1 (0 - 1A7)

Note:

Set this parameter to *F* when not using the terminal or to use the terminal in through mode.

■ H2-03: Terminal P1-PC Function Select

No. (Hex.)	Name	Description	Default Setting (Range)
H2-03 (040D)	Terminal P1-PC Function Select	V/f CL-V/f OLV CLV AOLV OLV/PM AOLV/PM CLV/PM EZOLV Selects the function assigned to MFDO terminal P1-C1.	2 (0 - 1A7)

Note:

Set this parameter to *F* when not using the terminal or to use the terminal in through mode.

■ H2-04: Terminal P2-PC Function Select

No. (Hex.)	Name	Description	Default Setting (Range)
H2-04 (040E)	Terminal P2-PC Function Select	V/f CL-V/f OLV CLV AOLV OLV/PM AOLV/PM CLV/PM EZOLV Selects the function assigned to MFDO terminal P2-C2.	F (0 - 1A7)

Note:

Set this parameter to *F* when not using the terminal or to use the terminal in through mode.

■ H2-06: Watt Hour Output Unit Selection

No. (Hex.)	Name	Description	Default Setting (Range)
H2-06 (0437)	Watt Hour Output Unit Selection	V/f CL-V/f OLV CLV AOLV OLV/PM AOLV/PM CLV/PM EZOLV Configures the output signal unit when <i>H2-01 through H2-04 = 39 [MFDO Function Select = Watt Hour Pulse Output]</i> is selected.	0 (0 - 4)

This output is input to the Watt hour meter or PLC via a 200 ms pulse signal. Each pulse is output by the kWh unit selected by *H2-06*.

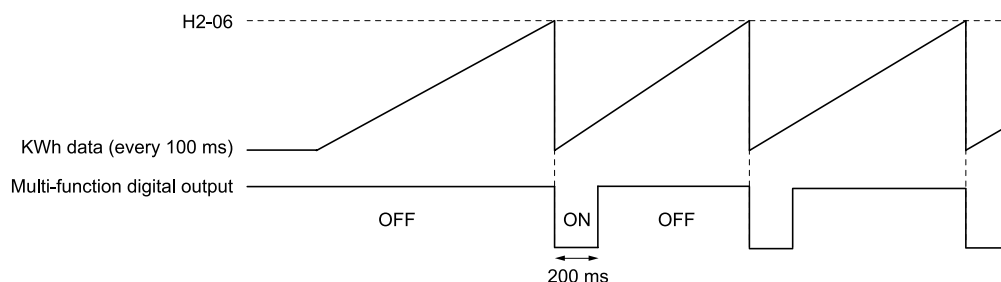

Figure 11.84 Example MFDO when Configured for Watt Hours

Note:

- Watt hours are not counted when the power value is a negative value (regenerative state).
- Stores the Watt hours while the control power supply to the drive is operating. The Watt hour count is reset when the control power is cut due to a momentary power loss or other reason.

0 : 0.1 kWh units

1 : 1 kWh units

2 : 10 kWh units

3 : 100 kWh units

4 : 1000 kWh units

■ **H2-07: MEMOBUS Register1 Address Select**

No. (Hex.)	Name	Description	Default Setting (Range)
H2-07 (0B3A)	MEMOBUS Register1 Address Select	<div style="display: flex; justify-content: space-between; font-size: 0.8em; font-weight: bold;"> V/f CL-V/f OLV CLV AOLV OLV/PM AOLV/PM CLV/PM EZOLV </div> Configures the address of the MEMOBUS/Modbus register output to the MFDO terminal.	0001 (0001 - 1FFF)

Configures *H2-07* with the address of the register that is output to *MEMOBUS Register 1 (H2-07&H2-08) [H2-01 through H2-04 = 62]* and configures *H2-08* with the bit.

■ **H2-08: MEMOBUS Register 1 Bit Select**

No. (Hex.)	Name	Description	Default Setting (Range)
H2-08 (0B3B)	MEMOBUS Register 1 Bit Select	<div style="display: flex; justify-content: space-between; font-size: 0.8em; font-weight: bold;"> V/f CL-V/f OLV CLV AOLV OLV/PM AOLV/PM CLV/PM EZOLV </div> Configures the bit of the MEMOBUS/Modbus register output to the MFDO terminal.	0000 (0000 - FFFF)

Configures *H2-07* with the address of the register that is output to *MEMOBUS Register 1 (H2-07&H2-08) [H2-01 through H2-04 = 62]* and configures *H2-08* with the bit.

■ **H2-09: MEMOBUS Register2 Address Select**

No. (Hex.)	Name	Description	Default Setting (Range)
H2-09 (0B3C)	MEMOBUS Register2 Address Select	<div style="display: flex; justify-content: space-between; font-size: 0.8em; font-weight: bold;"> V/f CL-V/f OLV CLV AOLV OLV/PM AOLV/PM CLV/PM EZOLV </div> Configures the address of the MEMOBUS/Modbus register output to the MFDO terminal.	0001 (0001 - 1FFF)

Configures *H2-09* with the address of the register that is output to *MEMOBUS Register 1 (H2-07&H2-08) [H2-01 through H2-04 = 63]* and configures *H2-10* with the bit.

■ **H2-10: MEMOBUS Register 2 Bit Select**

No. (Hex.)	Name	Description	Default Setting (Range)
H2-10 (0B3D)	MEMOBUS Register 2 Bit Select	<div style="display: flex; justify-content: space-between; font-size: 0.8em; font-weight: bold;"> V/f CL-V/f OLV CLV AOLV OLV/PM AOLV/PM CLV/PM EZOLV </div> Configures the bit of the MEMOBUS/Modbus register output to the MFDO terminal.	0000 (0000 - FFFF)

Configures *H2-09* with the address of the register that is output to *MEMOBUS Register 1 (H2-07&H2-08) [H2-01 through H2-04 = 63]* and configures *H2-10* with the bit.

■ **H2-20: Comparator 1 Monitor Selection**

No. (Hex.)	Name	Description	Default Setting (Range)
H2-20 (1540)	Comparator 1 Monitor Selection	<div style="display: flex; justify-content: space-between; font-size: 0.8em; font-weight: bold;"> V/f CL-V/f OLV CLV AOLV OLV/PM AOLV/PM CLV/PM EZOLV </div> Configures the monitor number for comparator 1. Configure the <i>x-xx</i> portion of <i>Ux-xx [Monitor]</i> . For example, set <i>x-xx</i> to <i>102</i> to monitor <i>U1-02 [Output Frequency]</i> .	102 (000 - 999)

Note:

- Refer to $H2-xx = 66$ and 67 [Multi-Function Digital Out Function Select = Comparator1 and Comparator 2] for more information on the comparator function.
- The configurable monitor varies depending on the control method.

■ H2-21: Comparator 1 Lower Limit

No. (Hex.)	Name	Description	Default Setting (Range)
H2-21 (1541)	Comparator 1 Lower Limit	V/f CL-V/f OLV CLV AOLV OLV/PM AOLV/PM CLV/PM EZOLV Configures the lower limit detection level for comparator 1 on the basis that the full scale analog output for the monitor number selected with $H2-20$ [Comparator 1 Monitor Selection] is the 100% value.	0.0% (0.0 - 300.0%)

Note:

Refer to $H2-xx = 66$ and 67 [Multi-Function Digital Out Function Select = Comparator1 and Comparator 2] for more information on the comparator function.

■ H2-22: Comparator 1 Upper Limit

No. (Hex.)	Name	Description	Default Setting (Range)
H2-22 (1542)	Comparator 1 Upper Limit	V/f CL-V/f OLV CLV AOLV OLV/PM AOLV/PM CLV/PM EZOLV Configures the upper limit detection level for comparator 1 on the basis that the full scale analog output for the monitor number selected with $H2-20$ [Comparator 1 Monitor Selection] is the 100% value.	0.0% (0.0 - 300.0%)

Note:

Refer to $H2-xx = 66$ and 67 [Multi-Function Digital Out Function Select = Comparator1 and Comparator 2] for more information on the comparator function.

■ H2-23: Comparator 1 Hysteresis

No. (Hex.)	Name	Description	Default Setting (Range)
H2-23 (1543)	Comparator 1 Hysteresis	V/f CL-V/f OLV CLV AOLV OLV/PM AOLV/PM CLV/PM EZOLV Configures the hysteresis level for comparator 1 on the basis that the full scale analog output for the monitor number selected with $H2-20$ [Comparator 1 Monitor Selection] is the 100% value.	0.0% (0.0 - 10.0%)

Note:

Refer to $H2-xx = 66$ and 67 [Multi-Function Digital Out Function Select = Comparator1 and Comparator 2] for more information on the comparator function.

■ H2-24: Comparator 1 On-Delay Time

No. (Hex.)	Name	Description	Default Setting (Range)
H2-24 (1544)	Comparator 1 On-Delay Time	V/f CL-V/f OLV CLV AOLV OLV/PM AOLV/PM CLV/PM EZOLV Configures the comparator 1 on delay time.	0.0 s (0.0 - 600.0 s)

Note:

Refer to $H2-xx = 66$ and 67 [Multi-Function Digital Out Function Select = Comparator1 and Comparator 2] for more information on the comparator function.

■ H2-25: Comparator 1 Off-Delay Time

No. (Hex.)	Name	Description	Default Setting (Range)
H2-25 (1545)	Comparator 1 Off-Delay Time	V/f CL-V/f OLV CLV AOLV OLV/PM AOLV/PM CLV/PM EZOLV Configures the comparator 1 off delay time.	0.0 s (0.0 - 600.0 s)

Note:

Refer to $H2-xx = 66$ and 67 [Multi-Function Digital Out Function Select = Comparator1 and Comparator 2] for more information on the comparator function.

■ H2-26: Comparator 2 Monitor Selection

No. (Hex.)	Name	Description	Default Setting (Range)
H2-26 (1546)	Comparator 2 Monitor Selection	<div style="display: flex; justify-content: space-between; font-size: 0.8em; font-weight: bold; margin-bottom: 5px;"> V/f CL-V/f OLV CLV AOLV OLV/PM AOLV/PM CLV/PM EZOLV </div> Configures the monitor number for comparator 2. Configure the <i>x-xx</i> portion of <i>Ux-xx [Monitor]</i> . For example, to monitor <i>U1-03 [Output Current]</i> , set a value of <i>103</i> .	103 (000 - 999)

Note:

- The configurable monitor varies depending on the control method.
- Set this parameter to *000* or *031* to use in through mode. The terminal output level from the PLC via MEMOBUS/Modbus communications or the communication option can be configured.
- Refer to *H2-xx = 66 and 67 [Multi-Function Digital Out Function Select = Comparator1 and Comparator 2]* for more information on the comparator function.

■ H2-27: Comparator 2 Lower Limit

No. (Hex.)	Name	Description	Default Setting (Range)
H2-27 (1547)	Comparator 2 Lower Limit	<div style="display: flex; justify-content: space-between; font-size: 0.8em; font-weight: bold; margin-bottom: 5px;"> V/f CL-V/f OLV CLV AOLV OLV/PM AOLV/PM CLV/PM EZOLV </div> Configures the lower limit detection level for comparator 2 on the basis that the full scale analog output for the monitor number selected with <i>H2-26 [Comparator 2 Monitor Selection]</i> is the 100% value.	0.0% (0.0 - 300.0%)

Note:

Refer to *H2-xx = 66 and 67 [Multi-Function Digital Out Function Select = Comparator1 and Comparator 2]* for more information on the comparator function.

■ H2-28: Comparator 2 Upper Limit

No. (Hex.)	Name	Description	Default Setting (Range)
H2-28 (1548)	Comparator 2 Upper Limit	<div style="display: flex; justify-content: space-between; font-size: 0.8em; font-weight: bold; margin-bottom: 5px;"> V/f CL-V/f OLV CLV AOLV OLV/PM AOLV/PM CLV/PM EZOLV </div> Configures the upper limit detection level for comparator 2 on the basis that the full scale analog output for the monitor number selected with <i>H2-26 [Comparator 2 Monitor Selection]</i> is the 100% value.	0.0% (0.0 - 300.0%)

Note:

Refer to *H2-xx = 66 and 67 [Multi-Function Digital Out Function Select = Comparator1 and Comparator 2]* for more information on the comparator function.

■ H2-29: Comparator 2 Hysteresis

No. (Hex.)	Name	Description	Default Setting (Range)
H2-29 (1549)	Comparator 2 Hysteresis	<div style="display: flex; justify-content: space-between; font-size: 0.8em; font-weight: bold; margin-bottom: 5px;"> V/f CL-V/f OLV CLV AOLV OLV/PM AOLV/PM CLV/PM EZOLV </div> Configures the hysteresis level for comparator 2 on the basis that the full scale analog output for the monitor number selected with <i>H2-26 [Comparator 2 Monitor Selection]</i> is the 100% value.	0.0% (0.0 - 10.0%)

Note:

Refer to *H2-xx = 66 and 67 [Multi-Function Digital Out Function Select = Comparator1 and Comparator 2]* for more information on the comparator function.

■ H2-30: Comparator 2 On-Delay Time

No. (Hex.)	Name	Description	Default Setting (Range)
H2-30 (154A)	Comparator 2 On-Delay Time	<div style="display: flex; justify-content: space-between; font-size: 0.8em; font-weight: bold; margin-bottom: 5px;"> V/f CL-V/f OLV CLV AOLV OLV/PM AOLV/PM CLV/PM EZOLV </div> Configures the time for the monitor number configured with <i>H2-26 [Comparator 2 Monitor Selection]</i> .	0.0 s (0.0 - 6000.0 s)

Note:

Refer to *H2-xx = 66 and 67 [Multi-Function Digital Out Function Select = Comparator1 and Comparator 2]* for more information on the comparator function.

■ H2-31: Comparator 2 Off-Delay Time

No. (Hex.)	Name	Description	Default Setting (Range)
H2-31 (154B)	Comparator 2 Off-Delay Time	V/f CL-V/f OLV CLV AOLV OLV/PM AOLV/PM CLV/PM EZOLV Configures the time for the monitor number configured with H2-26 [Comparator 2 Monitor Selection].	0.0 s (0.0 - 600.0 s)

Note:

Refer to H2-xx = 66 and 67 [Multi-Function Digital Out Function Select = Comparator1 and Comparator 2] for more information on the comparator function.

■ H2-40: Extend MFDI1 Function Selection

No. (Hex.)	Name	Description	Default Setting (Range)
H2-40 (0B58)	Extend MFDI1 Function Selection	V/f CL-V/f OLV CLV AOLV OLV/PM AOLV/PM CLV/PM EZOLV Configures the MFDO assigned to bit 0 of MEMOBUS register 15E0 (Hex.).	F (0 - 1A7)

■ H2-41: Extend MFDI2 Function Selection

No. (Hex.)	Name	Description	Default Setting (Range)
H2-41 (0B59)	Extend MFDI2 Function Selection	V/f CL-V/f OLV CLV AOLV OLV/PM AOLV/PM CLV/PM EZOLV Configures the MFDO assigned to bit 1 of MEMOBUS register 15E0 (Hex.).	F (0 - 1A7)

■ H2-42: Extend MFDI3 Function Selection

No. (Hex.)	Name	Description	Default Setting (Range)
H2-42 (0B5A)	Extend MFDI3 Function Selection	V/f CL-V/f OLV CLV AOLV OLV/PM AOLV/PM CLV/PM EZOLV Configures the MFDO assigned to bit 2 of MEMOBUS register 15E0 (Hex.).	F (0 - 1A7)

■ H2-60: Terminal M1-M2 Function B Select

No. (Hex.)	Name	Description	Default Setting (Range)
H2-60 (1B46)	Terminal M1-M2 Function B Select	V/f CL-V/f OLV CLV AOLV OLV/PM AOLV/PM CLV/PM EZOLV Selects the second function for terminal M1-M2. The logical calculation results of the terminals assigned to functions by H2-01 [Terminal M1-M2 Function Select] is output.	F (0 - A7)

■ H2-61: Terminal M1-M2 Logical Operation

No. (Hex.)	Name	Description	Default Setting (Range)
H2-61 (1B47)	Terminal M1-M2 Logical Operation	V/f CL-V/f OLV CLV AOLV OLV/PM AOLV/PM CLV/PM EZOLV Selects the logical operation for the two functions selected by H2-01 [Terminal M1-M2 Function Select] and H2-60 [Terminal M1-M2 Function B Select].	0 (0 - 8)

Note:

Refer to [Output of Logical Calculation Results of MFDO on page 778](#) for more information on the relationship between parameter settings and logical operations.

■ H2-62: Terminal M1-M2 Delay Time

No. (Hex.)	Name	Description	Default Setting (Range)
H2-62 (1B48)	Terminal M1-M2 Delay Time	V/f CL-V/f OLV CLV AOLV OLV/PM AOLV/PM CLV/PM EZOLV Configures the minimum on time used to output the logical calculation results from terminal M1-M2.	0.1 s (0.0 - 25.0 s)

■ H2-63: Terminal M3-M4 Function B Select

No. (Hex.)	Name	Description	Default Setting (Range)
H2-63 (1B49)	Terminal M3-M4 Function B Select	<div style="display: flex; justify-content: space-between; font-size: 0.8em; font-weight: bold; margin-bottom: 5px;"> V/f CL-V/f OLV CLV AOLV OLV/PM AOLV/PM CLV/PM EZOLV </div> Selects the second function for terminal M3-M4. The logical calculation results of the terminals assigned to functions by H2-02 [Terminal M3-M4 Function Select] is output.	F (0 - A7)

■ H2-64: Terminal M3-M4 Logical Operation

No. (Hex.)	Name	Description	Default Setting (Range)
H2-64 (1B4A)	Terminal M3-M4 Logical Operation	<div style="display: flex; justify-content: space-between; font-size: 0.8em; font-weight: bold; margin-bottom: 5px;"> V/f CL-V/f OLV CLV AOLV OLV/PM AOLV/PM CLV/PM EZOLV </div> Selects the logical operation for the two functions selected by H2-02 [Terminal M3-M4 Function Select] and H2-63 [Terminal M3-M4 Function B Select].	0 (0 - 8)

Note:

Refer to [Output of Logical Calculation Results of MFDO on page 778](#) for more information on the relationship between parameter settings and logical operations.

■ H2-65: Terminal M3-M4 Delay Time

No. (Hex.)	Name	Description	Default Setting (Range)
H2-65 (1B4B)	Terminal M3-M4 Delay Time	<div style="display: flex; justify-content: space-between; font-size: 0.8em; font-weight: bold; margin-bottom: 5px;"> V/f CL-V/f OLV CLV AOLV OLV/PM AOLV/PM CLV/PM EZOLV </div> Configures the minimum on time used to output the logical calculation results from terminal M3-M4.	0.1 s (0.0 - 25.0 s)

■ H2-66: Terminal M5-M6 Function B Select

No. (Hex.)	Name	Description	Default Setting (Range)
H2-66 (1B4C)	Terminal M5-M6 Function B Select	<div style="display: flex; justify-content: space-between; font-size: 0.8em; font-weight: bold; margin-bottom: 5px;"> V/f CL-V/f OLV CLV AOLV OLV/PM AOLV/PM CLV/PM EZOLV </div> Selects the second function for terminal P1-C1. The logical calculation results of the terminals assigned to functions by H2-03 [Terminal P1-PC Function Select] is output.	F (0 - A7)

■ H2-67: Terminal M5-M6 Logical Operation

No. (Hex.)	Name	Description	Default Setting (Range)
H2-67 (1B4D)	Terminal M5-M6 Logical Operation	<div style="display: flex; justify-content: space-between; font-size: 0.8em; font-weight: bold; margin-bottom: 5px;"> V/f CL-V/f OLV CLV AOLV OLV/PM AOLV/PM CLV/PM EZOLV </div> Selects the logical operation for the two functions selected by H2-03 [Terminal P1-PC Function Select] and H2-66 [Terminal M5-M6 Function B Select].	0 (0 - 8)

Note:

Refer to [Output of Logical Calculation Results of MFDO on page 778](#) for more information on the relationship between parameter settings and logical operations.

■ H2-68: Terminal M5-M6 Delay Time

No. (Hex.)	Name	Description	Default Setting (Range)
H2-68 (1B4E)	Terminal M5-M6 Delay Time	<div style="display: flex; justify-content: space-between; font-size: 0.8em; font-weight: bold; margin-bottom: 5px;"> V/f CL-V/f OLV CLV AOLV OLV/PM AOLV/PM CLV/PM EZOLV </div> Configures the minimum on time used to output the logical calculation results from terminal P1-C1.	0.1 s (0.0 - 25.0 s)

■ H2-69: Digital Output4 Secondary Func

No. (Hex.)	Name	Description	Default Setting (Range)
H2-69 (1B4F)	Digital Output4 Secondary Func	<div style="display: flex; justify-content: space-between; font-size: 0.8em; font-weight: bold; margin-bottom: 5px;"> V/f CL-V/f OLV CLV AOLV OLV/PM AOLV/PM CLV/PM EZOLV </div> Selects the second function for terminal P2-C2. The logical calculation results of the terminals assigned to functions by H2-04 [Terminal P2-PC Function Select] is output.	F (0 - A7)

■ H2-70: DigitalOutput4 Logical Operation

No. (Hex.)	Name	Description	Default Setting (Range)
H2-70 (11F9)	DigitalOutput4 Logical Operation	<div style="display: flex; justify-content: space-between; font-size: 0.8em; font-weight: bold; margin-bottom: 5px;"> V/f CL-V/f OLV CLV AOLV OLV/PM AOLV/PM CLV/PM EZOLV </div> Selects the logical operation for the two functions selected by H2-04 [Terminal P2-PC Function Select] and H2-69 [Digital Output4 Secondary Func].	0 (0 - 8)

Note:

Refer to *Output of Logical Calculation Results of MFDO on page 778* for more information on the relationship between parameter settings and logical operations.

■ H2-71: Digital Output 4 Delay Time

No. (Hex.)	Name	Description	Default Setting (Range)
H2-71 (11FA)	Digital Output 4 Delay Time	<div style="display: flex; justify-content: space-between; font-size: 0.8em; font-weight: bold; margin-bottom: 5px;"> V/f CL-V/f OLV CLV AOLV OLV/PM AOLV/PM CLV/PM EZOLV </div> Configures the minimum on time used to output the logical calculation results from terminal P2-C2.	0.1 s (0.0 - 25.0 s)

■ H2-72: Digital Output 5 Secondary Func

No. (Hex.)	Name	Description	Default Setting (Range)
H2-72 (11FB)	Digital Output 5 Secondary Func	<div style="display: flex; justify-content: space-between; font-size: 0.8em; font-weight: bold; margin-bottom: 5px;"> V/f CL-V/f OLV CLV AOLV OLV/PM AOLV/PM CLV/PM EZOLV </div> Selects the second function for terminal M1-M2. The logical calculation results of the terminals assigned to functions by H2-01 [Terminal M1-M2 Function Select] is output.	F (0 - A7)

■ H2-73: DigitalOutput5 Logical Operation

No. (Hex.)	Name	Description	Default Setting (Range)
H2-73 (11FC)	DigitalOutput5 Logical Operation	<div style="display: flex; justify-content: space-between; font-size: 0.8em; font-weight: bold; margin-bottom: 5px;"> V/f CL-V/f OLV CLV AOLV OLV/PM AOLV/PM CLV/PM EZOLV </div> Selects the logical operation for the two functions selected by H2-01 [Multi-Function Digital Output 1] and H2-72 [Digital Output 5 Secondary Func].	0 (0 - 8)

Note:

Refer to *Output of Logical Calculation Results of MFDO on page 778* for more information on the relationship between parameter settings and logical operations.

■ H2-74: Digital Output 5 Delay Time

No. (Hex.)	Name	Description	Default Setting (Range)
H2-74 (11FD)	Digital Output 5 Delay Time	<div style="display: flex; justify-content: space-between; font-size: 0.8em; font-weight: bold; margin-bottom: 5px;"> V/f CL-V/f OLV CLV AOLV OLV/PM AOLV/PM CLV/PM EZOLV </div> Configures the minimum on time used to output the logical calculation results from terminal M1-M2.	0.1 s (0.0 - 25.0 s)

◆ MFDO Setting Value

Selects the function configured to MFDO.

■ 0: During Run

Setting	Function	Description
0	During Run	<div style="display: flex; justify-content: space-between; font-size: small;"> V/f CL-V/f OLV CLV AOLV OLV/PM AOLV/PM CLV/PM EZOLV </div> <p>The terminal turns on when the Run command is input or the drive is outputting voltage.</p>

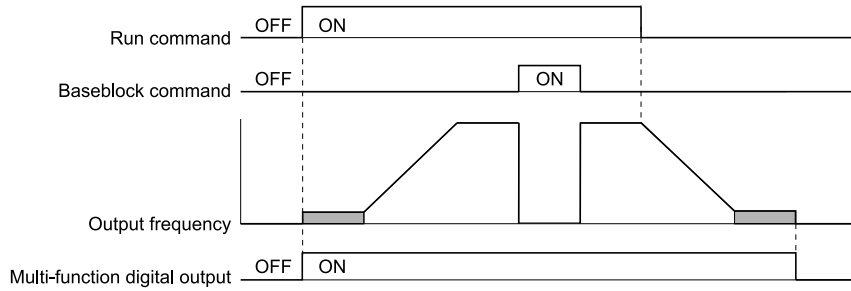

Figure 11.85 Drive Running Time Chart

ON : Drive is running

The Run command is input, the drive is decelerating, or the DC injection braking is operating.

OFF : Drive is stopping

■ 1: Zero Speed

Setting	Function	Description
1	Zero Speed	<div style="display: flex; justify-content: space-between; font-size: small;"> V/f CL-V/f OLV CLV AOLV OLV/PM AOLV/PM CLV/PM EZOLV </div> <p>The terminal turns on when the output frequency drops below the value of <i>E1-09</i> [Minimum Output Frequency] or <i>b2-01</i> [DC Injection/Zero Speed Threshold].</p>

Note:

The parameter used as the reference is determined by the setting of *A1-02* [Control Method Selection].

A1-02 Settings	Description	Parameter used as the reference
0	V/f Control	<i>E1-09</i>
1	Closed Loop V/f Control	<i>E1-09</i>
2	Open Loop Vector Control	<i>b2-01</i>
3	Closed Loop Vector Control	<i>E1-09</i>
4	Advanced OpenLoop Vector Control	<i>E1-09</i>
5	PM Open Loop Vector Control	<i>E1-09</i>
6	PM Advanced Open Loop Vector	<i>E1-09</i>
7	PM Closed Loop Vector Control	<i>b2-01</i>
8	EZ Open Loop Vector Control	<i>E1-09</i>

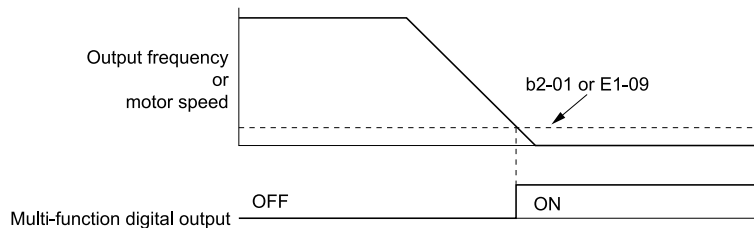

Figure 11.86 Zero Speed Time Chart

ON : The output frequency is less than the value of *E1-09* or *b2-01*.

OFF : The output frequency is the value of *E1-09* or more, or *b2-01* or more.

2: Speed Agree 1

Setting	Function	Description
2	Speed Agree 1	<div style="display: flex; justify-content: space-between; font-size: small; font-weight: bold;"> V/f CL-V/f OLV CLV AOLV OLV/PM AOLV/PM CLV/PM EZOLV </div> <p>The terminal turns on when the output frequency is within the range of the frequency reference $\pm L4-02$ [Speed Agree Detection Width].</p>

Note:

- The detection function operates regardless of the direction of motor rotation.
- When using Closed Loop Vector Control, the motor speed is used as the reference.

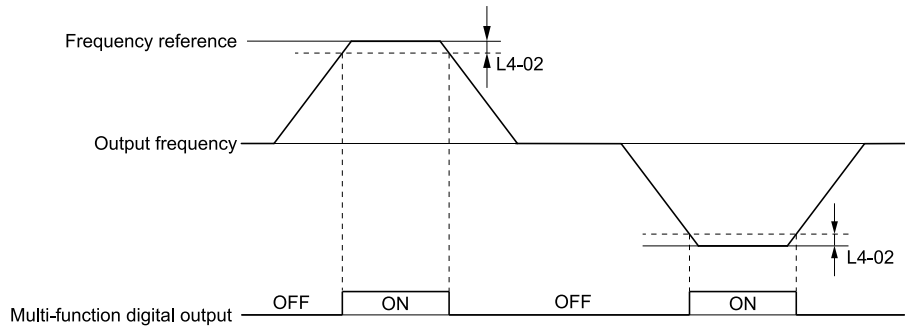

Figure 11.87 Speed Agree 1 Time Chart

ON : The output frequency is within the range of “frequency reference $\pm L4-02$.”

OFF : The output frequency does not match the frequency reference even though the drive is running.

3: User-set Speed Agree 1

Setting	Function	Description
3	User-set Speed Agree 1	<div style="display: flex; justify-content: space-between; font-size: small; font-weight: bold;"> V/f CL-V/f OLV CLV AOLV OLV/PM AOLV/PM CLV/PM EZOLV </div> <p>The terminal turns on when the output frequency is within the range of $L4-01$ [Speed Agree Detection Level] $\pm L4-02$ [Speed Agree Detection Width] and within the range of the frequency reference $\pm L4-02$.</p>

Note:

- The detection function operates regardless of the direction of motor rotation. The value of $L4-01$ is used as the forward/reverse detection level.
- When using Closed Loop Vector Control, the motor speed is used as the reference.

ON : The output frequency is within the range as defined by the result of “ $L4-01 \pm L4-02$ ” and the range of frequency reference $\pm L4-02$.

OFF : The output frequency is not within the range of “ $L4-01 \pm L4-02$ ” or the range of frequency reference $\pm L4-02$.

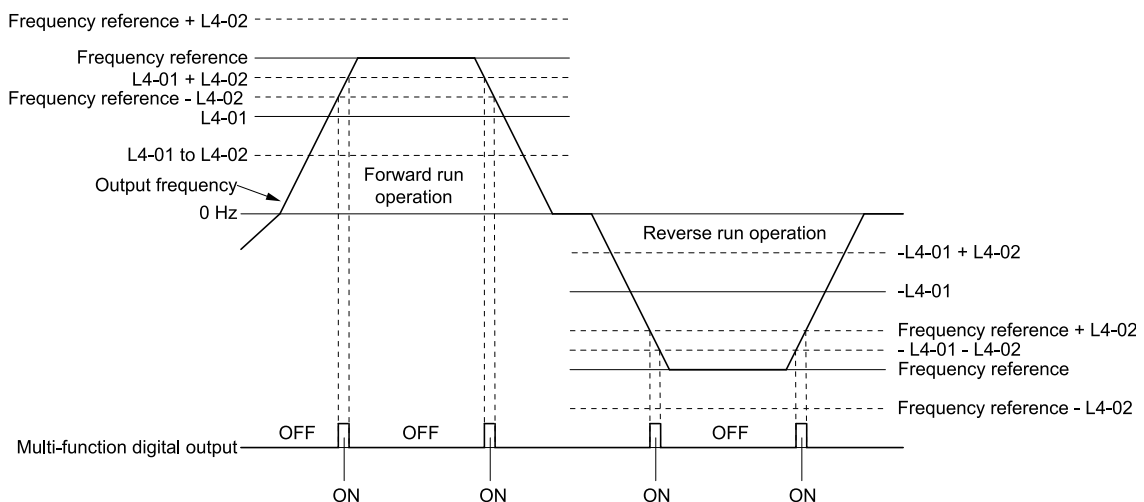

Figure 11.88 User-defined Speed Agree 1 Time Chart

4: Frequency Detection 1

Setting	Function	Description
4	Frequency Detection 1	<div style="display: flex; justify-content: space-between; font-size: small;"> V/f CL-V/f OLV CLV AOLV OLV/PM AOLV/PM CLV/PM EZOLV </div> <p>The terminal turns on when the output frequency is higher than the value of $L4-01$ [Speed Agree Detection Level] + $L4-02$ [Speed Agree Detection Width]. After the terminal turns off, the terminal continues to remain off until the output frequency reaches the level set with $L4-01$.</p>

Note:

- The detection function operates regardless of the direction of motor rotation. The value of $L4-01$ is used as the forward/reverse detection level.
- When using Closed Loop Vector Control, the motor speed is used as the reference.

ON : The output frequency is less than the value of $L4-01$ or does not exceed the value of $L4-01 + L4-02$.

OFF : The output frequency exceeds the value of $L4-01 + L4-02$.

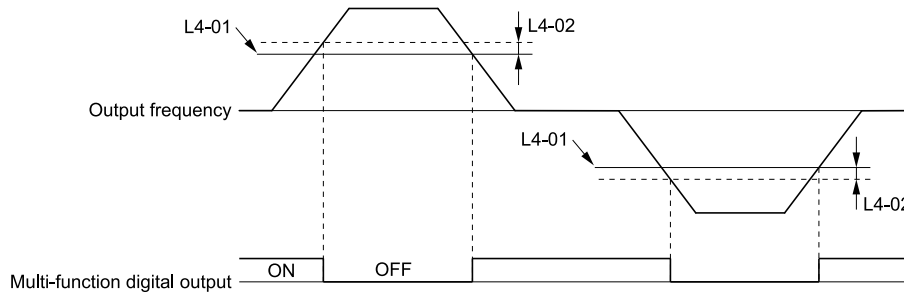

Figure 11.89 Frequency Detection 1 Time Chart

Note:

This time chart represents the result of the configuration when $L4-07 = 1$ [Speed Agree Detection Selection = Detection always enabled]. The default setting of $L4-07$ is 0 [No detection during baseblock]. When the speed agreement detection selection is set to No detection during baseblock, the terminal is off when the drive has cut output.

5: Frequency Detection 2

Setting	Function	Description
5	Frequency Detection 2	<div style="display: flex; justify-content: space-between; font-size: small;"> V/f CL-V/f OLV CLV AOLV OLV/PM AOLV/PM CLV/PM EZOLV </div> <p>The terminal turns on when the output frequency is higher than the setting value of $L4-01$ [Speed Agree Detection Level]. After the terminal turns on, the terminal continues to stay on until the output frequency reaches the value of $L4-01 - L4-02$.</p>

Note:

- The detection function operates regardless of the direction of motor rotation. The value of $L4-01$ is used as the forward/reverse detection level.
- When using Closed Loop Vector Control, the motor speed is used as the reference.

ON : The output frequency exceeds the value of $L4-01$.

OFF : The output frequency is less than the value of " $L4-01 - L4-02$," or it does not exceed the value of $L4-01$.

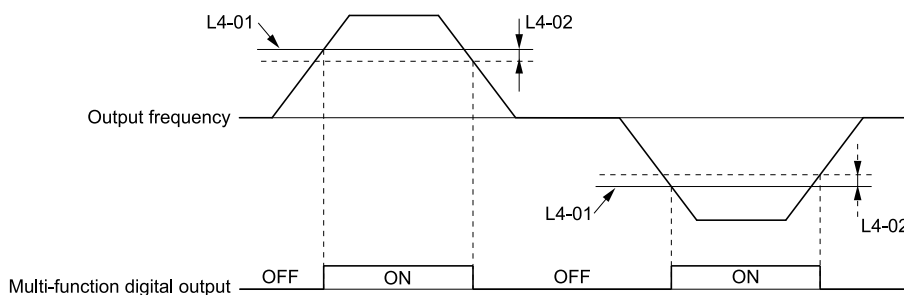

Figure 11.90 Frequency Detection 2 Time Chart

6: Drive Ready

Setting	Function	Description
6	Drive Ready	<div style="display: flex; justify-content: space-between; font-size: small;"> V/f CL-V/f OLV CLV AOLV OLV/PM AOLV/PM CLV/PM EZOLV </div> <p>The terminal turns on when the drive is in the ready state and the drive is running.</p>

The terminal turns off under the following circumstances.

- When the power supply is shut off
- During a fault
- When there is problem with the control power supply
- When the drive cannot operate even though a Run command is input due to a parameter configuration error
- When a fault such as overvoltage or undervoltage is triggered as soon as the Run command is turned on
- When the drive is in the Programming mode and will not accept a Run command even when entered

■ 7: DC Bus Undervoltage

Setting	Function	Description
7	DC Bus Undervoltage	V/f CL-V/f OLV CLV AOLV OLV/PM AOLV/PM CLV/PM EZOLV The terminal turns on when the DC bus voltage or control circuit power supply drops below the voltage set with <i>L2-05</i> [<i>Undervoltage Detect Level (Uv1)</i>]. The terminal also turns on when the DC bus voltage experiences a fault.

ON : The DC bus voltage has dropped below the setting value of *L2-05*.

OFF : The DC bus voltage exceeds the setting value of *L2-05*.

■ 8: During Baseblock (N.O.)

Setting	Function	Description
8	During Baseblock (N.O.)	V/f CL-V/f OLV CLV AOLV OLV/PM AOLV/PM CLV/PM EZOLV The terminal turns on during baseblock. When the drive is in the baseblock state, the drive output transistor stops switching, and the DC bus voltage is not output.

ON : During baseblock

OFF : The drive is not in the baseblock state.

■ 9: Frequency Reference Source

Setting	Function	Description
9	Frequency Reference Source	V/f CL-V/f OLV CLV AOLV OLV/PM AOLV/PM CLV/PM EZOLV Displays the frequency reference source that is currently selected.

ON : The keypad is the frequency reference source.

OFF : Either *b1-01* or *b1-15* [*Frequency Reference Selection 1 or 2*] is the frequency reference source.

■ A: Run Command Source

Setting	Function	Description
A	Run Command Source	V/f CL-V/f OLV CLV AOLV OLV/PM AOLV/PM CLV/PM EZOLV Displays the Run command source that is currently selected.

ON : The keypad is the Run command source.

OFF : Either *b1-02* or *b1-16* [*Run Command Selection 1 or 2*] is the Run command source.

■ B: Torque Detection 1 (N.O.)

Setting	Function	Description
B	Torque Detection 1 (N.O.)	V/f CL-V/f OLV CLV AOLV OLV/PM AOLV/PM CLV/PM EZOLV The terminal turns on when an overtorque/undertorque situation is detected.

ON : The output current/torque exceeds the torque value set with *L6-02* [*Torque Detection Level 1*], or the level has dropped and remained in this state longer than the time set with *L6-03* [*Torque Detection Time 1*].

Note:

- When configured such that *L6-01* ≥ 5 , detection is performed when the state in which the output current/torque is less than the detection level of *L6-02* remains longer than the time set with *L6-03*.
- Refer to "L6: Torque Detection" for more information.

■ C: Frequency Reference Loss

Setting	Function	Description
C	Frequency Reference Loss	<div style="display: flex; justify-content: space-between; font-size: 0.8em; font-weight: bold;"> V/f CL-V/f OLV CLV AOLV OLV/PM AOLV/PM CLV/PM EZOLV </div> <p>The terminal turns on when a loss of frequency reference is detected.</p>

Note:

Refer to “L4-05: FreqReference Loss Detect Select” for more information.

■ D: Braking Resistor Fault

Setting	Function	Description
D	Braking Resistor Fault	<div style="display: flex; justify-content: space-between; font-size: 0.8em; font-weight: bold;"> V/f CL-V/f OLV CLV AOLV OLV/PM AOLV/PM CLV/PM EZOLV </div> <p>The terminal turns on when the mounting type braking resistor is overheating or the braking transistor is experiencing a fault.</p>

■ E: Fault

Setting	Function	Description
E	Fault	<div style="display: flex; justify-content: space-between; font-size: 0.8em; font-weight: bold;"> V/f CL-V/f OLV CLV AOLV OLV/PM AOLV/PM CLV/PM EZOLV </div> <p>The terminal turns on when the drive experiences a fault.</p>

Note:

Parameters *CPF00* and *CPF01* [Control Circuit Error] are excluded.

■ F: Through Mode

Setting	Function	Description
F	Through Mode	<div style="display: flex; justify-content: space-between; font-size: 0.8em; font-weight: bold;"> V/f CL-V/f OLV CLV AOLV OLV/PM AOLV/PM CLV/PM EZOLV </div> <p>Use this setting when terminals are not used or to use terminals in through mode. This can be used as the PLC contact output via MEMOBUS/Modbus or the communication option. This signal does not function as long as signals from the PLC are not configured.</p>

■ 10: Minor Fault

Setting	Function	Description
10	Minor Fault	<div style="display: flex; justify-content: space-between; font-size: 0.8em; font-weight: bold;"> V/f CL-V/f OLV CLV AOLV OLV/PM AOLV/PM CLV/PM EZOLV </div> <p>The terminal turns on when the drive experiences a minor fault.</p>

■ 11: Fault Reset Command Active

Setting	Function	Description
11	Fault Reset Command Active	<div style="display: flex; justify-content: space-between; font-size: 0.8em; font-weight: bold;"> V/f CL-V/f OLV CLV AOLV OLV/PM AOLV/PM CLV/PM EZOLV </div> <p>The terminal turns on when the drive receives the reset command from the control circuit terminal, serial communications, or the communication option.</p>

■ 12: Timer Output

Setting	Function	Description
12	Timer Output	<div style="display: flex; justify-content: space-between; font-size: 0.8em; font-weight: bold;"> V/f CL-V/f OLV CLV AOLV OLV/PM AOLV/PM CLV/PM EZOLV </div> <p>This is configured when the timer function is used as an output terminal.</p>

Note:

Refer to “b4: Timer Function” for more information.

■ 13: Speed Agree 2

Setting	Function	Description
13	Speed Agree 2	<div style="display: flex; justify-content: space-between; font-size: 0.8em; font-weight: bold;"> V/f CL-V/f OLV CLV AOLV OLV/PM AOLV/PM CLV/PM EZOLV </div> <p>The terminal turns on when the output frequency is within the range of the frequency reference \pm L4-04 [Speed Agree Detection Width (+/-)].</p>

Note:

- The detection function operates regardless of the direction of motor rotation.
- The motor speed is used as the reference when using Closed Loop Vector Control or Closed Loop Vector Control for PM.

ON : The output frequency is within the range of “frequency reference $\pm L4-04$.”
OFF : The output frequency is not within the range of “frequency reference $\pm L4-04$.”

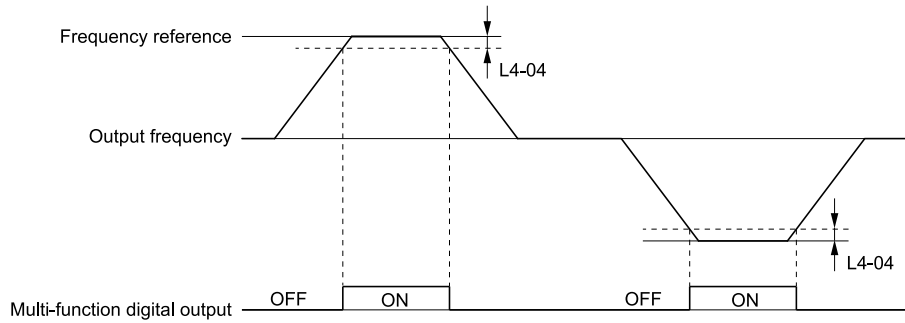

Figure 11.91 Speed Agree 2 Time Chart

■ 14: User-set Speed Agree 2

Setting	Function	Description
14	User-set Speed Agree 2	<div style="display: flex; justify-content: space-between; font-size: small;"> V/f CL-V/f OLV CLV AOLV OLV/PM AOLV/PM CLV/PM EZOLV </div> <p>The terminal turns on when the output frequency is within the range of $L4-03$ [Speed Agree Detect Level (+/-)] \pm $L4-04$ [Speed Agree Detect Width (+/-)] and within the range of the frequency reference $\pm L4-04$.</p>

Note:

- The detection level configured with $L4-03$ is a signed value. Detections only occur one specific orientation.
- The motor speed is used as the reference when using Closed Loop Vector Control or Closed Loop Vector Control for PM.

ON : The output frequency is within the range of “ $L4-03 \pm L4-04$ ” and the range of the frequency reference $\pm L4-04$.

OFF : The output frequency is not within the range of “ $L4-03 \pm L4-04$ ” or the range of frequency reference $\pm L4-04$.

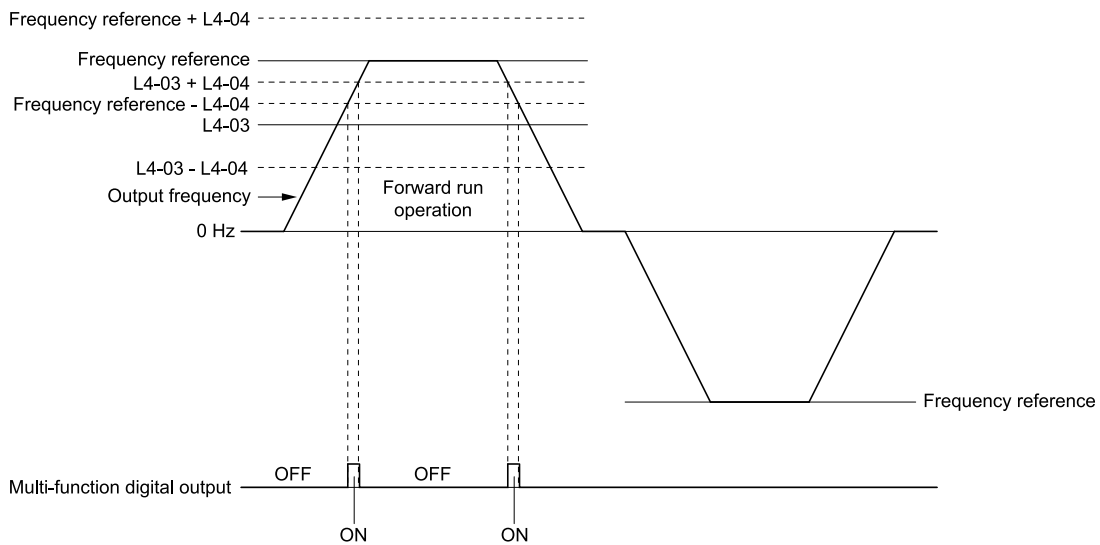

Figure 11.92 Example of User-set Speed Agree 2 (L4-03 is positive)

■ 15: Frequency Detection 3

Setting	Function	Description
15	Frequency Detection 3	<div style="display: flex; justify-content: space-between; font-size: small;"> V/f CL-V/f OLV CLV AOLV OLV/PM AOLV/PM CLV/PM EZOLV </div> <p>The terminal turns off when the output frequency is higher than the value of “$L4-03$ [Speed Agree Detect Level (+/-)] + $L4-04$ [Speed Agree Detect Width (+/-)].” After the terminal turns off, the terminal continues to remain off until the output frequency reaches the level set with $L4-03$.</p>

Note:

- The detection level configured with $L4-03$ is a signed value. Detections only occur one specific orientation.
- The motor speed is used as the reference when using Closed Loop Vector Control or Closed Loop Vector Control for PM.

ON : The output frequency is less than the value of $L4-03$ or does not exceed the value of $L4-03 + L4-04$.

OFF : The output frequency exceeds the value of $L4-03 + L4-04$.

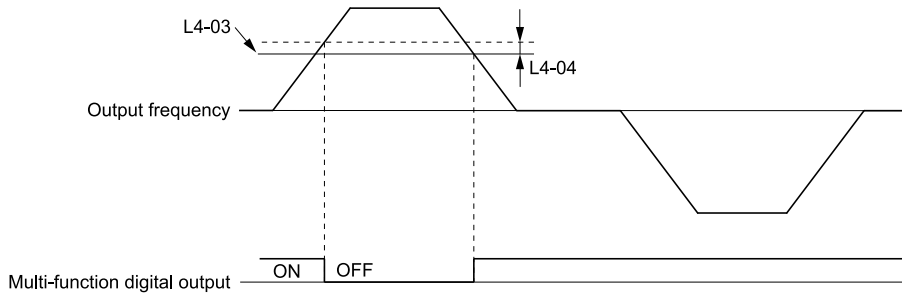

Figure 11.93 Example of Frequency Detection 3 (value of L4-03 is positive)

Note:

This time chart represents the result of the configuration when $L4-07 = 1$ [Speed Agree Detection Selection = Detection always enabled]. The default setting of $L4-07$ is 0 [No detection during baseblock]. When the speed agreement detection selection is set to No detection during baseblock, the terminal is off when the drive has cut output.

■ 16: Frequency Detection 4

Setting	Function	Description
16	Frequency Detection 4	<div style="display: flex; justify-content: space-between; font-size: small;"> V/f CL-V/f OLV CLV AOLV OLV/PM AOLV/PM CLV/PM EZOLV </div> <p>The terminal turns on when the output frequency is higher than the value of $L4-03$ [Speed Agree Detect Level (+/-)]. After the terminal turns on, the terminal continues to stay on until the output frequency reaches the value of $L4-03 - L4-04$.</p>

Note:

- The detection level configured with $L4-03$ is a signed value, and so detections only occur one specific orientation.
- When using Closed Loop Vector Control, the motor speed is used as the reference.

ON : The output frequency exceeds the value of $L4-03$.

OFF : The output frequency is less than the value of “ $L4-03 - L4-04$,” or it does not exceed the value of $L4-03$.

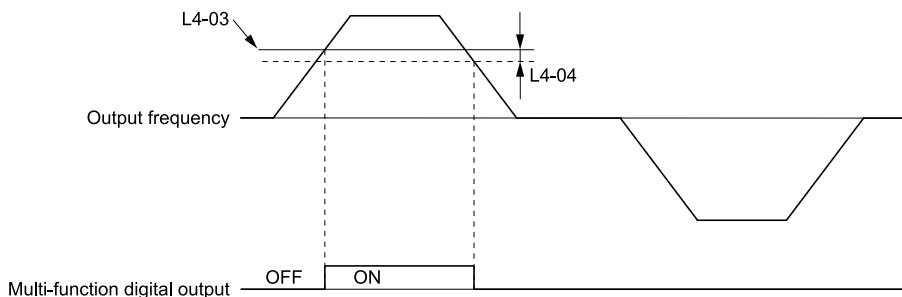

Figure 11.94 Example of Frequency Detection 4 (value of L4-03 is positive)

■ 17: Torque Detection 1 (N.C.)

Setting	Function	Description
17	Torque Detection 1 (N.C.)	<div style="display: flex; justify-content: space-between; font-size: small;"> V/f CL-V/f OLV CLV AOLV OLV/PM AOLV/PM CLV/PM EZOLV </div> <p>The terminal turns off when an overtorque/undertorque situation is detected.</p>

Configure the torque detection with parameter $L6$ [Torque Detection].

OFF : The output current/torque exceeds the torque value set with $L6-02$ [Torque Detection Level 1], or the level has dropped and remained in this state longer than the time set with $L6-03$ [Torque Detection Time 1].

Note:

- When configured such that $L6-01 \geq 5$, detection is performed when the state in which the output current/torque is less than the detection level of $L6-02$ remains longer than the time set with $L6-03$.
- Refer to “L6: Torque Detection” for more information.

■ 18: Torque Detection 2 (N.O.)

Setting	Function	Description
18	Torque Detection 2 (N.O.)	V/f CL-V/f OLV CLV AOLV OLV/PM AOLV/PM CLV/PM EZOLV The terminal turns on when an overtorque/undertorque situation is detected.

Configure the torque detection with parameter *L6* [Torque Detection].

ON : The output current/torque exceeds the torque value set with *L6-05* [Torque Detection Level 2], or the level has dropped and remained in this state longer than the time set with *L6-06* [Torque Detection Time 2].

Note:

- When configured such that $L6-04 \geq 5$, the state in which the output current/torque is less than the detection level of *L6-05* is detected when the time set with *L6-06* has elapsed.
- Refer to “L6: Torque Detection” for more information.

■ 19: Torque Detection 2 (N.C.)

Setting	Function	Description
19	Torque Detection 2 (N.C.)	V/f CL-V/f OLV CLV AOLV OLV/PM AOLV/PM CLV/PM EZOLV The terminal turns off when an overtorque/undertorque situation is detected.

Configure the torque detection with parameter *L6* [Torque Detection].

OFF : The output current/torque exceeds the torque value set with *L6-05* [Torque Detection Level 2], or the level has dropped and remained in this state longer than the time set with *L6-06* [Torque Detection Time 2].

Note:

- When configured such that $L6-04 \geq 5$, the state in which the output current/torque is less than the detection level of *L6-05* is detected when the time set with *L6-06* has elapsed.
- Refer to “L6: Torque Detection” for more information.

■ 1A: During Reverse

Setting	Function	Description
1A	During Reverse	V/f CL-V/f OLV CLV AOLV OLV/PM AOLV/PM CLV/PM EZOLV The terminal turns on when the motor runs in reverse.

ON : The motor is running in reverse.

OFF : The motor is running forward or is stopped.

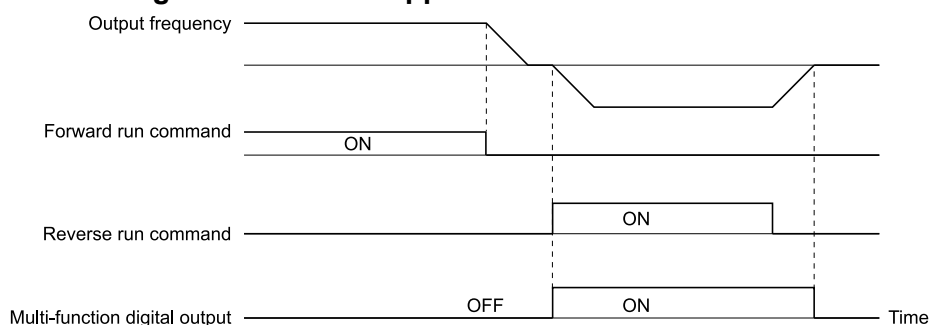

Figure 11.95 Reverse Operation Output Time Chart

■ 1B: During Baseblock (N.C.)

Setting	Function	Description
1B	During Baseblock (N.C.)	V/f CL-V/f OLV CLV AOLV OLV/PM AOLV/PM CLV/PM EZOLV The terminal turns off during baseblock. When the drive is in the baseblock state, the drive output transistor stops switching, and the DC bus voltage is not output.

ON : The drive is not in the baseblock state.

OFF : During baseblock

■ **1C: Motor 2 Selection**

Setting	Function	Description
1C	Motor 2 Selection	<div style="display: flex; justify-content: space-between; font-size: 0.8em; font-weight: bold;"> V/f CL-V/f OLV CLV AOLV OLV/PM AOLV/PM CLV/PM EZOLV </div> <p>The terminal turns on when motor 2 is selected.</p>

ON : Motor 2 Selection

OFF : Motor 1 Selection

■ **1D: During Regeneration**

Setting	Function	Description
1D	During Regeneration	<div style="display: flex; justify-content: space-between; font-size: 0.8em; font-weight: bold;"> V/f CL-V/f OLV CLV AOLV OLV/PM AOLV/PM CLV/PM EZOLV </div> <p>The terminal turns on when the motor is regenerating.</p>

ON : Motor is regenerating.

OFF : Motor is operating or stopped.

■ **1E: Restart Enabled**

Setting	Function	Description
1E	Restart Enabled	<div style="display: flex; justify-content: space-between; font-size: 0.8em; font-weight: bold;"> V/f CL-V/f OLV CLV AOLV OLV/PM AOLV/PM CLV/PM EZOLV </div> <p>The terminal turns on when a fault that can be restarted occurs and the Auto Restart function is attempting to operate.</p>

The terminal turns off when a fault is automatically reset by the Auto Restart function. The terminal turns off when the Auto Restart function detects the fault again since Auto Restart function cannot function any longer due to number of attempts set with *L5-01 [Number of Auto Restart Attempts]* being reached.

Note:

Refer to “L5: Fault Restart” for more information.

■ **1F: Motor Overload Alarm (oL1)**

Setting	Function	Description
1F	Motor Overload Alarm (oL1)	<div style="display: flex; justify-content: space-between; font-size: 0.8em; font-weight: bold;"> V/f CL-V/f OLV CLV AOLV OLV/PM AOLV/PM CLV/PM EZOLV </div> <p>The terminal turns on when the electronic thermal protector value of the motor overload protective function reaches at least 90% of the detection level.</p>

Note:

Refer to “L1-01: Motor Overload Protection Select” for more information.

■ **20: Drive Overheat Pre-Alarm (oH)**

Setting	Function	Description
20	Drive Overheat Pre-Alarm (oH)	<div style="display: flex; justify-content: space-between; font-size: 0.8em; font-weight: bold;"> V/f CL-V/f OLV CLV AOLV OLV/PM AOLV/PM CLV/PM EZOLV </div> <p>The terminal turns on when the drive heatsink temperature reaches the level set with <i>L8-02 [Overheat Alarm Level]</i>.</p>

Note:

Refer to “L8-02: Overheat Alarm Level” for more information.

■ **21: EDM**

Setting	Function	Description
21	EDM	<div style="display: flex; justify-content: space-between; font-size: 0.8em; font-weight: bold;"> V/f CL-V/f OLV CLV AOLV OLV/PM AOLV/PM CLV/PM EZOLV </div> <p>The terminal turns on (safety stop state) when the safety circuit and safety diagnosis circuit is not experiencing a failure and when both terminals H1-HC and H2-HC are off (released).</p>

Note:

EDM = External Device Monitor

ON : Safety stop state

Both terminal H1-HC and H2-HC have been turned off, or released (safety stop state).

OFF : Safety circuit fault or RUN/READY

Either terminal H1-HC or H2-HC has been turned off, or released (safety circuit fault), or both of these terminals are on, or have short circuited (RUN/READY).

■ 22: Mechanical Weakening Detection

Setting	Function	Description
22	Mechanical Weakening Detection	<div style="display: flex; justify-content: space-between; align-items: center;"> V/f CL-V/f OLV CLV AOLV OLV/PM AOLV/PM CLV/PM EZOLV </div> <p>The terminal turns on when mechanical weakening is detected.</p>

Note:

Refer to “Mechanical Weakening Detection Function” for more information.

■ 2F: Maintenance Period

Setting	Function	Description
2F	Maintenance Period	<div style="display: flex; justify-content: space-between; align-items: center;"> V/f CL-V/f OLV CLV AOLV OLV/PM AOLV/PM CLV/PM EZOLV </div> <p>The terminal turns on when consumables reach the estimated maintenance period.</p>

Provides notification of the maintenance period for the following items.

- IGBT
- Cooling fan
- Capacitor
- Soft charge bypass relay

Note:

Refer to “Alarm Outputs for Maintenance Monitors” for more information.

■ 30: During Torque Limit

Setting	Function	Description
30	During Torque Limit	<div style="display: flex; justify-content: space-between; align-items: center;"> V/f CL-V/f OLV CLV AOLV OLV/PM AOLV/PM CLV/PM EZOLV </div> <p>The terminal turns on when the torque reference reaches the torque limit configured with <i>L7 parameters, H3-02, H3-06, or H3-10 [Multi-Function Analog In]</i>.</p>

Note:

Refer to “L7: Torque Limit” for more information.

■ 31: During Speed Limit

Setting	Function	Description
31	During speed limit	<div style="display: flex; justify-content: space-between; align-items: center;"> V/f CL-V/f OLV CLV AOLV OLV/PM AOLV/PM CLV/PM EZOLV </div> <p>The terminal turns on when the speed limit is active.</p>

The frequency limit activates and the terminal turns on under the following conditions.

- Frequency reference is at least the value of *d2-01 [Frequency Reference Upper Limit]*
- Frequency reference is the same as or lower than *d2-02 [Frequency Reference Lower Limit]* or *d2-03 [Analog Speed Reference Low Limit]*.
- Frequency reference is the same as or lower than *E1-09 [Minimum Output Frequency]* when *b1-05 = 1, 2, or 3 [Operation Below Minimum Freq = Baseblock (motor coasts), Operate at minimum frequency, or Operate at zero speed]*.
- Frequency reference is the same as or less than *Output Freq Lower Limit Level (H3-xx [Terminal A1 Function Selection through Terminal A3 Function Selection] = 9)* via analog input.

■ 32: During Spd Limit inTorqueControl

Setting	Function	Description
32	During Spd Limit inTorqueControl	<div style="display: flex; justify-content: space-between; align-items: center;"> V/f CL-V/f OLV CLV AOLV OLV/PM AOLV/PM CLV/PM EZOLV </div> <p>The motor accelerates in forward or reverse when torque control is enabled and the torque reference externally input is disproportionate to the load. The output terminal turns on when this speed is restricted to no higher than a constant speed and the motor speed is at the speed limit. Stopped operation is excluded.</p>

Note:

Refer to “d5-03: Speed Limit Selection” for more information.

■ 33: Zero Servo Complete

Setting	Function	Description
33	Zero Servo Complete	<div style="display: flex; justify-content: space-between; font-size: small;"> V/f CL-V/f OLV CLV AOLV OLV/PM AOLV/PM CLV/PM EZOLV </div> <p>The terminal turns on when positioning within the range defined by <i>b9-02 [Zero Servo Completion Width]</i> completes after the input of the Zero-Servo command.</p>

Note:

Refer to “b9: Zero Servo” for more information.

■ 37: During Frequency Output

Setting	Function	Description
37	During Frequency Output	<div style="display: flex; justify-content: space-between; font-size: small;"> V/f CL-V/f OLV CLV AOLV OLV/PM AOLV/PM CLV/PM EZOLV </div> <p>The terminal turns on when the drive outputs frequency.</p>

ON : The drive outputs frequency.

OFF : The drive does not output frequency.

Note:

The terminal turns off in any of the following circumstances.

- During Stop
- During baseblock
- During DC Injection Braking (initial excitation)
- During Short Circuit Braking

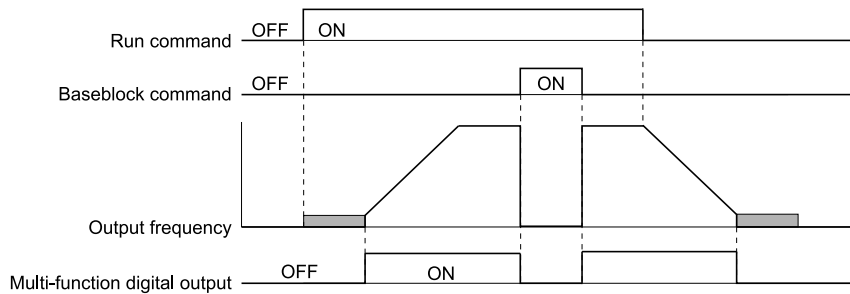

Figure 11.96 Active Frequency Output Time Chart

■ 38: Drive Enabled

Setting	Function	Description
38	Drive Enabled	<div style="display: flex; justify-content: space-between; font-size: small;"> V/f CL-V/f OLV CLV AOLV OLV/PM AOLV/PM CLV/PM EZOLV </div> <p>This terminal turns on when the terminal allocated to <i>H1-xx = 6A [Drive Enable]</i> is turned on.</p>

■ 39: Watt Hour Pulse Output

Setting	Function	Description
39	Watt Hour Pulse Output	<div style="display: flex; justify-content: space-between; font-size: small;"> V/f CL-V/f OLV CLV AOLV OLV/PM AOLV/PM CLV/PM EZOLV </div> <p>Outputs the pulse that represents the watt hours.</p>

Note:

Refer to “H2-06: Watt Hour Output Unit Selection” for more information.

■ 3C: LOCAL/REMOTE Status

Setting	Function	Description
3C	LOCAL/REMOTE Status	<div style="display: flex; justify-content: space-between; font-size: small;"> V/f CL-V/f OLV CLV AOLV OLV/PM AOLV/PM CLV/PM EZOLV </div> <p>The terminal turns on when the Run command source or frequency reference source is LOCAL.</p>

ON : LOCAL

The keypad is the Run command source or the frequency reference source.

OFF : REMOTE

The Run command source or frequency reference source is an external source selected with *b1-01 [Frequency Reference Selection 1]*, *b1-02 [Run Command Selection 1]*, *b1-15 [Frequency Reference Selection 2]*, or *b1-16 [Run Command Selection 2]*.

■ 3D: During Speed Search

Setting	Function	Description
3D	During Speed Search	V/f CL-V/f OLV CLV AOLV OLV/PM AOLV/PM CLV/PM EZOLV The terminal turns on when speed search is executing.

Note:

Refer to “b3: Speed Search” for more information.

■ 3E: PID Feedback Low

Setting	Function	Description
3E	PID Feedback Low	V/f CL-V/f OLV CLV AOLV OLV/PM AOLV/PM CLV/PM EZOLV The terminal turns on when <i>FbL [PID Feedback Loss]</i> is detected.

FbL [PID Feedback Loss] is detected when the PID feedback value falls below the setting value of *b5-13 [PID Feedback Loss Detection Lvl]* for a time exceeding the setting value of *b5-14 [PID Feedback Loss Detection Time]*.

Note:

Refer to “PID Feedback Loss Detection” for more information.

■ 3F: PID Feedback High

Setting	Function	Description
3F	PID Feedback High	V/f CL-V/f OLV CLV AOLV OLV/PM AOLV/PM CLV/PM EZOLV The terminal turns on when <i>FbH [Excessive PID Feedback]</i> is detected.

FbH [Excessive PID Feedback] is detected when the PID feedback value exceeds the setting value of *b5-36 [PID Feedback High Detection Lvl]* for a time exceeding the setting value of *b5-37 [PID Feedback High Detection Time]*.

Note:

Refer to “PID Feedback Loss Detection” for more information.

■ 4A: During KEB Ride-Thru

Setting	Function	Description
4A	During KEB Ride-Thru	V/f CL-V/f OLV CLV AOLV OLV/PM AOLV/PM CLV/PM EZOLV The terminal turns on while the KEB Ride-Thru function is being executed.

Note:

Refer to “KEB Ride-Thru function” for more information.

■ 4B: During Short Circuit Braking

Setting	Function	Description
4B	During Short Circuit Braking	V/f CL-V/f OLV CLV AOLV OLV/PM AOLV/PM CLV/PM EZOLV The terminal turns on during Short Circuit Braking.

Note:

- This function is enabled only when using PM motors while *A1-02 = 8 [Control Method Selection = EZ Open Loop Vector Control]*.
- Refer to “b2: DC Circuit Braking” for more information.

■ 4C: During Fast Stop

Setting	Function	Description
4C	During Fast Stop	V/f CL-V/f OLV CLV AOLV OLV/PM AOLV/PM CLV/PM EZOLV The terminal turns on when the fast stop is active.

■ 4D: oH Pre-Alarm Time Limit

Setting	Function	Description
4D	oH Pre-Alarm Time Limit	<div style="display: flex; justify-content: space-between; font-size: small;"> V/f CL-V/f OLV CLV AOLV OLV/PM AOLV/PM CLV/PM EZOLV </div> <p>The terminal turns on when $L8-03 = 4$ [Overheat Pre-Alarm Ope Selection = Run@L8-19 Rate] and oH [Heatsink Overheat] does not clear even after the drive diminishes the frequency for 10 cycles.</p>

Note:

Refer to "L8-03: Overheat Pre-Alarm Ope Selection" for more information.

■ 4E: Braking Transistor Fault (rr)

Setting	Function	Description
4E	Braking Transistor Fault (rr)	<div style="display: flex; justify-content: space-between; font-size: small;"> V/f CL-V/f OLV CLV AOLV OLV/PM AOLV/PM CLV/PM EZOLV </div> <p>The terminal turns on when the braking transistor integrated into the drive overheats and rr [Dynamic Braking Transistor] is detected.</p>

■ 4F: Braking Resistor Overheat (oH)

Setting	Function	Description
4F	Braking Resistor Overheat (oH)	<div style="display: flex; justify-content: space-between; font-size: small;"> V/f CL-V/f OLV CLV AOLV OLV/PM AOLV/PM CLV/PM EZOLV </div> <p>The terminal turns on when the braking resistor overheats and rH [Braking Resistor Overheat] is detected.</p>

The braking resistor overheats when the deceleration time is short and the motor regeneration energy is significant.

■ 60: Internal Cooling Fan Alarm

Setting	Function	Description
60	Internal Cooling Fan Alarm	<div style="display: flex; justify-content: space-between; font-size: small;"> V/f CL-V/f OLV CLV AOLV OLV/PM AOLV/PM CLV/PM EZOLV </div> <p>The terminal turns on when a failure is detected in the cooling fan inside the drive.</p>

■ 61: RotorPosition Detection Complete

Setting	Function	Description
61	RotorPosition Detection Complete	<div style="display: flex; justify-content: space-between; font-size: small;"> V/f CL-V/f OLV CLV AOLV OLV/PM AOLV/PM CLV/PM EZOLV </div> <p>The terminal turns on when the Run command is input into the drive and the drive detects the motor magnetic pole position of the PM motor.</p>

■ 62: MEMOBUS Register 1 (H2-07&H2-08)

Setting	Function	Description
62	MEMOBUS Register 1 (H2-07&H2-08)	<div style="display: flex; justify-content: space-between; font-size: small;"> V/f CL-V/f OLV CLV AOLV OLV/PM AOLV/PM CLV/PM EZOLV </div> <p>The terminal turns on when the bit specified by H2-07 turns on regarding the MEMOBUS register address configured with H2-08.</p>

■ 63: MEMOBUS Register 2 (H2-09&H2-10)

Setting	Function	Description
63	MEMOBUS Register 2 (H2-09&H2-10)	<div style="display: flex; justify-content: space-between; font-size: small;"> V/f CL-V/f OLV CLV AOLV OLV/PM AOLV/PM CLV/PM EZOLV </div> <p>The terminal turns on when the bit specified by H2-10 turns on regarding the MEMOBUS register address configured with H2-09.</p>

■ 65: Standby output

Setting	Function	Description
65	Standby output	<div style="display: flex; justify-content: space-between; font-size: small;"> V/f CL-V/f OLV CLV AOLV OLV/PM AOLV/PM CLV/PM EZOLV </div> <p>The terminal turns off after the drive stops operating and the time set with b8-51 [Standby Mode Wait Time] elapses.</p>

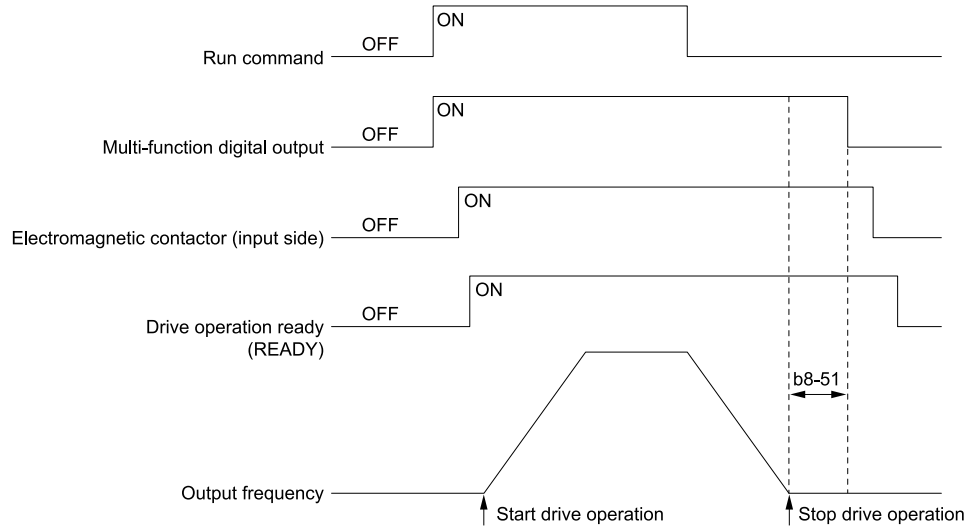

ON : The Run command turns on and the magnetic contactor on the input side turns off.
OFF : The Run command turns off and the drive stops operating. Then, the magnetic contactor on the input side turns off after the time set with *b8-51 [Standby Mode Wait Time]* elapses.

■ **66: Comparator1**

Setting	Function	Description
66	Comparator1	<div style="display: flex; justify-content: space-between; font-size: small;"> V/f CL-V/f OLV CLV AOLV OLV/PM AOLV/PM CLV/PM EZOLV </div> <p>The monitor value configured with <i>H2-20</i> is on while within range of the time configured with <i>H2-24</i> and the values of <i>H2-21</i> and <i>H2-22</i> are within range.</p>

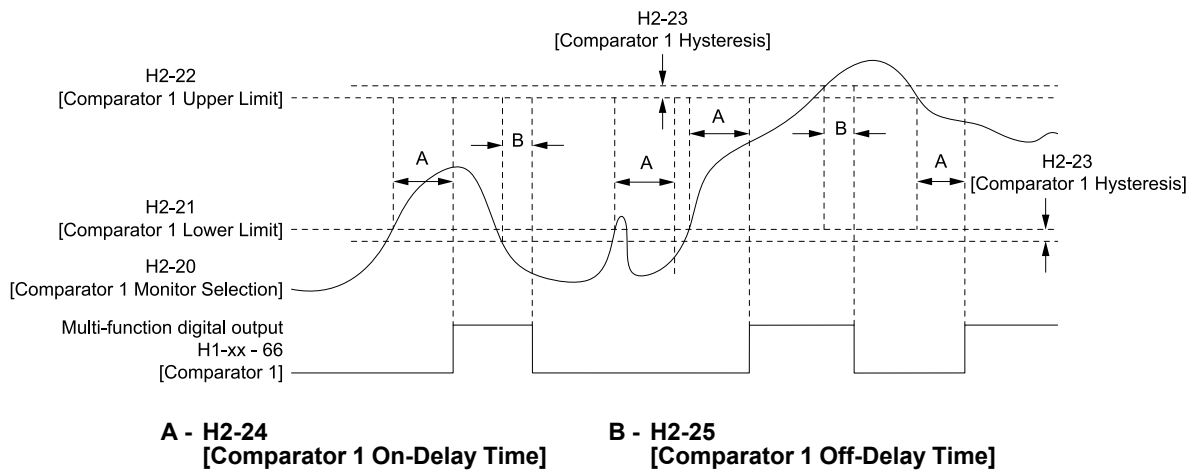

Figure 11.97 Comparator 1 Output Time Chart

Note:

The monitors configured with *H2-20* are compared as absolute values.

■ **67: Comparator2**

Setting	Function	Description
67	Comparator2	<div style="display: flex; justify-content: space-between; font-size: small;"> V/f CL-V/f OLV CLV AOLV OLV/PM AOLV/PM CLV/PM EZOLV </div> <p>The monitor value configured with <i>H2-26</i> is on while within range of the time configured with <i>H2-30</i> and the values of <i>H2-27</i> and <i>H2-28</i> are within range.</p>

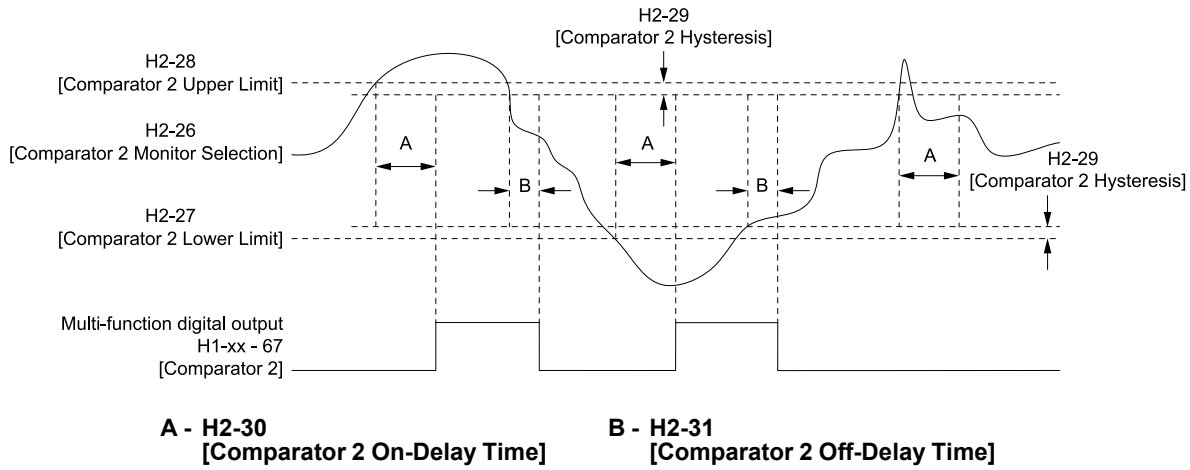

Figure 11.98 Comparator 2 Output Time Chart

Note:

The monitors configured with H2-26 are compared as absolute values.

■ **69: External Power 24V Supply**

Setting	Function	Description
69	External Power 24V Supply	V/f CL-V/f OLV CLV AOLV OLV/PM AOLV/PM CLV/PM EZOLV The terminal turns on when an external 24V power supply is provided between terminal PS-AC.

ON : Power is supplied by an external 24V power supply.

OFF : Power is not supplied by an external 24V power supply.

■ **90 through 92: DriveWorksEZ Digital Outputs 1 through 3**

Setting	Function	Description
90 - 92	DriveWorksEZ Digital Outputs 1 through 3	V/f CL-V/f OLV CLV AOLV OLV/PM AOLV/PM CLV/PM EZOLV Configures the digital output used by DriveWorksEZ. Refer to the DriveWorksEZ online manual for more information.

■ **100 through 1A7: Inverse Output of 0 through A7**

Setting	Function	Description
100 through 1A7	Inverse output of 0 through A7	V/f CL-V/f OLV CLV AOLV OLV/PM AOLV/PM CLV/PM EZOLV Generates inverse output of the function for the selected MFDO. Selects the function for which to generate inverse output with the last two digits of 1xx.

For example, configure such that H2-xx = 10E to generate inverse output of E [Fault].

◆ **H3: Multi-Function Analog In**

WARNING! Sudden Movement Hazard. Perform test runs and periodic inspections to ensure that command references are configured appropriately. Incorrect configuration of the command reference can cause unintended motor rotation, which may lead to equipment damage or injury.

Drives have three analog input terminals, which are named terminals A1, A2, and A3. H3 parameters are used to select the functions configured to these analog input terminals and to adjust signal levels.

The following table lists the functions that can be configured to analog input terminals. Use H3-02, H3-06, and H3-10 [MFAI Function Select] to configure functions.

Table 11.53 MFAI Setting Values

Setting	Function	Setting	Function
0	Frequency Bias	4	Output Voltage Bias
1	Frequency Gain	5	Accel/Decel Time Gain
2	Auxiliary Frequency Reference 1	6	DC Injection Braking Current
3	Auxiliary Frequency Reference 2	7	Overtorque/Undertorque DetectLvl

Setting	Function	Setting	Function
8	Stall Prevention Level DuringRun	12	Regenerative Torque Limit
9	Output Freq Lower Limit Level	13	Torque Reference / Torque Limit
B	PID Feedback	14	Torque Compensation
C	PID Setpoint	15	General Torque Limit
D	Frequency Bias	16	Differential PID Feedback
E	Motor Temperature (PTC input)	1F	Through Mode
F	Through Mode	30	DriveWorksEZ analog input 1
10	Forward Torque Limit	31	DriveWorksEZ analog input 2
11	Reverse Torque Limit	32	DriveWorksEZ analog input 3

Note:

All analog input scaling is adjusted using gain and bias. Configure the gain and bias values appropriately.

■ Example Analog Input Settings

- The function set for terminal A1 is set with *Frequency Bias* [$H3-02 = 0$], the gain is 200% [$H3-03 = 200.0$], and the bias is 0% [$H3-04 = 0.0$].
The frequency reference will be at 200% when a signal of 10 V is input.
The frequency reference will be at 100% when a signal of 5 V is input. As the drive output at this time is restricted by $E1-04$ [*Maximum Output Frequency*], the frequency reference will be at 100% when a signal of 5 V or more is input.

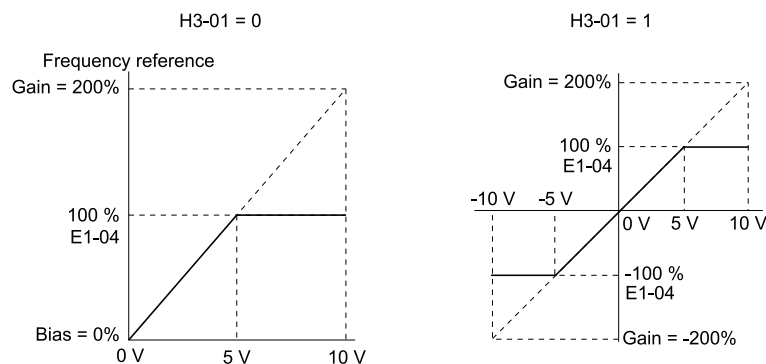

Figure 11.99 Freq Reference When the Analog Input Gain Setting Is Adjusted

- The function set for terminal A1 is set with *Frequency Bias* [$H3-02 = 0$], the gain is 100% [$H3-03 = 100.0$], and the bias is -25% [$H3-04 = -25.0$].
The frequency reference will be at -25% when a signal of 0 V is input.
When $H3-01 = 0$ [*Terminal A1 Signal Level Select = 0 to 10 V*] is set, the frequency reference will be at 0% when a signal of 0 to 2 V is input. The frequency reference will be at 0 to 100% when a signal of 2 to 10 V is input.
Signals of both positive and negative polarities are enabled when $H3-01 = 1$ [*-10 to +10 V*] is set, and so the motor rotates in reverse when a signal of 0 to 2 V is input.

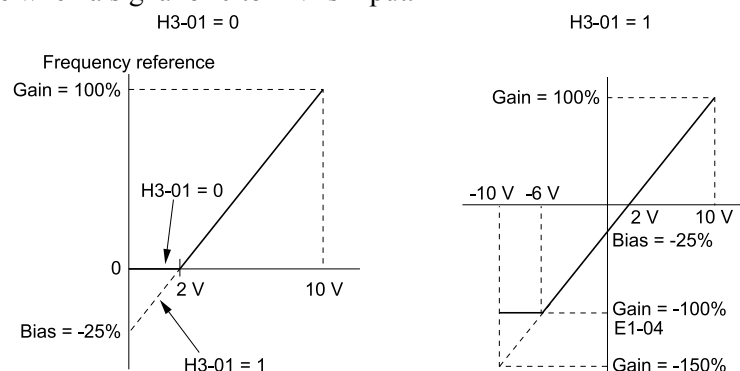

Figure 11.100 Frequency Reference When Negative Number Bias Is Configured

MEMOBUS Multi-Function AI1 to 3 Function Selection

Allows the MFAI function to be assigned to MEMOBUS register 15C1 to 15C3 (Hex.) [MEMOBUS Multi-Function AI1 to AI3 Command]. Select the function with H3-40 to H3-42 [Extend MFAI1 to MFAI3 function selection] and set the input filter with H3-43 [Filter time for MFAI].

Table 11.54 MEMOBUS Multi-Function AI Command Register

Register No. (Hex.)	Name	Setting Range *1	Parameters
15C1	MEMOBUS Multi-Function AI1 Command	-32767 - 32767	H3-40
15C2	MEMOBUS Multi-Function AI2 Command	-32767 - 32767	H3-41
15C3	MEMOBUS Multi-Function AI3 Command	-32767 - 32767	H3-42

*1 Set as 100%= 4096.

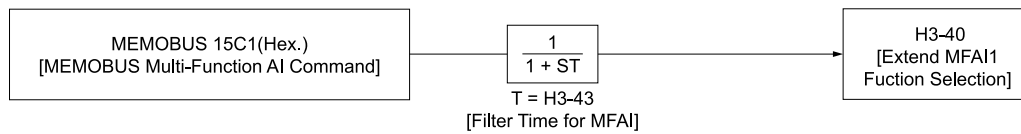

Figure 11.101 Functional Block Diagram for MEMOBUS Multi-Function AI Command 1

Note:

- Refer to H3-xx “MFAI Setting Values” for the analog input setting values.
- Set H3-40 to H3-42 = F when not using the terminal. The through mode function is not supported.
- The following MFAI terminals cannot be selected with H3-40 to H3-42.

H3-xx Setting Value	Function
0	Frequency Bias
1	Frequency Gain
2	Auxiliary Frequency Reference 1
3	Auxiliary Frequency Reference 2
30	DriveWorksEZ Analog Input 1
31	DriveWorksEZ Analog Input 2
32	DriveWorksEZ Analog Input 3

H3: MFAI Parameters

H3-01: Terminal A1 Signal Level Select

No. (Hex.)	Name	Description	Default (Range)
H3-01 (0410)	Terminal A1 Signal Level Select	<input type="checkbox"/> V/f <input type="checkbox"/> CL-V/f <input type="checkbox"/> OLV <input type="checkbox"/> CLV <input type="checkbox"/> AOLV <input type="checkbox"/> OLV/PM <input type="checkbox"/> AOLV/PM <input type="checkbox"/> CLV/PM <input type="checkbox"/> EZOLV	0 (0 - 3)

0 : 0-10V (LowLim=0)

The voltage signal is 0 Vdc to 10 Vdc. The minimum input level is limited to 0%, so that a negative input signal due to gain and bias settings will be read as 0%.

1 : 0-10V (BipolRef)

The voltage signal is 0 Vdc to 10 Vdc. Signals of both positive and negative polarities are enabled. When this setting is used as the frequency reference, the motor runs reverse when the Forward run command is input, or runs forward when the Reverse run signal is input, while the signal is a negative number due to gain and bias.

2 : 4-20 mA

The current signal is 4 mA to 20 mA. The minimum input level is limited to 0%, so that a negative input signal due to gain and bias settings will be read as 0%.

3 : 0-20 mA

The current signal is 0 mA to 20 mA. The minimum input level is limited to 0%, so that a negative input signal due to gain and bias settings will be read as 0%.

Note:

When $H3-01 = 0, 1$, set DIP switch S1-1 to the V side (voltage). When $H3-01 = 2, 3$, set DIP switch S1-1 to the I side (current). The default setting is the V side (voltage).

■ H3-02: Terminal A1 Function Selection

No. (Hex.)	Name	Description	Default Setting (Range)
H3-02 (0434)	Terminal A1 Function Selection	V/f CL-V/f OLV CLV AOLV OLV/PM AOLV/PM CLV/PM EZOLV Selects a function assigned to the MFAI terminal A1.	0 (0 - 32)

■ H3-03: Terminal A1 Gain Setting

No. (Hex.)	Name	Description	Default Setting (Range)
H3-03 (0411) RUN	Terminal A1 Gain Setting	V/f CL-V/f OLV CLV AOLV OLV/PM AOLV/PM CLV/PM EZOLV Sets the gain for the analog signal input to the MFAI terminal A1.	100.0% (-999.9 - +999.9%)

This parameter sets the reference amount for the function set for terminal A1 as a percentage when 10 V (or 20 mA) is input.

Use *H3-03* and *H3-04* [*Terminal A1 Bias Setting*] to adjust the characteristics of the analog input signal to terminal A1.

■ H3-04: Terminal A1 Bias Setting

No. (Hex.)	Name	Description	Default Setting (Range)
H3-04 (0412) RUN	Terminal A1 Bias Setting	V/f CL-V/f OLV CLV AOLV OLV/PM AOLV/PM CLV/PM EZOLV Sets the bias of the analog signal to be input to the MFAI terminal A1.	0.0% (-999.9 - +999.9%)

Parameter H3-04 sets the bias for the function set for terminal A1 as a percentage when 0 V (4 mA or 0 mA) is input.

Use *H3-03* [*Terminal A1 Gain Setting*] and *H3-04* to adjust the characteristics of the analog input signal to terminal A1.

■ H3-05: Terminal A3 Signal Level Select

No. (Hex.)	Name	Description	Default Setting (Range)
H3-05 (0413)	Terminal A3 Signal Level Select	V/f CL-V/f OLV CLV AOLV OLV/PM AOLV/PM CLV/PM EZOLV Selects the input signal level for MFAI terminal A3.	0 (0 - 3)

0 : 0-10V (LowLim=0)

The voltage signal is 0 Vdc to 10 Vdc. The minimum input level is limited to 0%, so that a negative input signal due to gain and bias settings will be read as 0%.

1 : 0-10V (BipolRef)

The voltage signal is 0 Vdc to 10 Vdc. Signals of both positive and negative polarities are enabled. When this setting is used as the frequency reference, the motor runs reverse when the Forward run command is input, or runs forward when the Reverse run signal is input, while the signal is a negative number due to gain and bias.

2 : 4-20 mA

The current signal is 4 mA to 20 mA. The minimum input level is limited to 0%, so that a negative input signal due to gain and bias settings will be read as 0%.

3 : 0-20 mA

11.8 H: Terminal Functions

The current signal is 0 mA to 20 mA. The minimum input level is limited to 0%, so that a negative input signal due to gain and bias settings will be read as 0%.

Note:

When $H3-05 = 0, 1$, set DIP switch S1-3 to the V side (voltage). When $H3-05 = 2, 3$, set DIP switch S1-3 to the I side (current). The default setting is the V side (voltage).

■ H3-06: Terminal A3 Function Selection

No. (Hex.)	Name	Description	Default Setting (Range)
H3-06 (0414)	Terminal A3 Function Selection	V/f CL-V/f OLV CLV AOLV OLV/PM AOLV/PM CLV/PM EZOLV Selects the function to be set for the MFAI terminal A3.	2 (0 - 32)

Note:

When using terminal A3 as the PTC input terminal, set $H3-06 = E$ [Motor Temperature (PTC input)], set DIP switch S4 to the PTC side, and set DIP switch S1-3 to the V side.

■ H3-07: Terminal A3 Gain Setting

No. (Hex.)	Name	Description	Default Setting (Range)
H3-07 (0415) RUN	Terminal A3 Gain Setting	V/f CL-V/f OLV CLV AOLV OLV/PM AOLV/PM CLV/PM EZOLV Sets the gain of the analog signal to be input to the MFAI terminal A3.	100.0% (-999.9 - +999.9%)

Parameter H3-07 sets the reference amount for the function set for terminal A3 as a percentage when 10 V (or 20 mA) is input.

Use $H3-07$ and $H3-08$ [Terminal A3 Bias Setting] to adjust the characteristics of the analog input signal to terminal A3.

■ H3-08: Terminal A3 Bias Setting

No. (Hex.)	Name	Description	Default Setting (Range)
H3-08 (0416) RUN	Terminal A3 Bias Setting	V/f CL-V/f OLV CLV AOLV OLV/PM AOLV/PM CLV/PM EZOLV Sets the bias of the analog signal to be input to the MFAI terminal A3.	0.0% (-999.9 - +999.9%)

This parameter sets the bias for the function set for terminal A3 as a percentage when 0 V (4 mA or 0 mA) is input.

Use $H3-07$ [Terminal A3 Gain Setting] and $H3-08$ to adjust the characteristics of the analog input signal to terminal A3.

■ H3-09: Terminal A2 Signal Level Select

No. (Hex.)	Name	Description	Default Setting (Range)
H3-09 (0417)	Terminal A2 Signal Level Select	V/f CL-V/f OLV CLV AOLV OLV/PM AOLV/PM CLV/PM EZOLV Selects the input signal level for MFAI terminal A2.	2 (0 - 3)

0 : 0-10V (LowLim=0)

The voltage signal is 0 Vdc to 10 Vdc. The minimum input level is limited to 0%, so that a negative input signal due to gain and bias settings will be read as 0%.

1 : 0-10V (BipolRef)

The voltage signal is 0 Vdc to 10 Vdc. Signals of both positive and negative polarities are enabled. When this setting is used as the frequency reference, the motor runs reverse when the Forward run command is input, or runs forward when the Reverse run signal is input, while the signal is a negative number due to gain and bias.

2 : 4-20mA

The current signal is 4 mA to 20 mA. The minimum input level is limited to 0%, so that a negative input signal due to gain and bias settings will be read as 0%.

3 : 0-20mA

The current signal is 0 mA to 20 mA. The minimum input level is limited to 0%, so that a negative input signal due to gain and bias settings will be read as 0%.

Note:

When $H3-09 = 0, 1$, set DIP switch S1-2 to the V side (voltage). When $H3-09 = 2, 3$, set DIP switch S1-2 to the I side (current). The default setting is the I side (current).

■ H3-10: Terminal A2 Function Selection

No. (Hex.)	Name	Description	Default Setting (Range)
H3-10 (0418)	Terminal A2 Function Selection	V/f CL-V/f OLV CLV AOLV OLV/PM AOLV/PM CLV/PM EZOLV Selects a function set to the MFAI terminal A2.	0 (0 - 32)

■ H3-11: Terminal A2 Gain Setting

No. (Hex.)	Name	Description	Default Setting (Range)
H3-11 (0419) RUN	Terminal A2 Gain Setting	V/f CL-V/f OLV CLV AOLV OLV/PM AOLV/PM CLV/PM EZOLV Sets the gain of the analog signal to be input to the MFAI terminal A2.	100.0% (-999.9 - +999.9%)

Parameter H3-03 sets the reference amount for the function set for terminal A2 as a percentage when 10 V (or 20 mA) is input.

Use *H3-11 and H3-12 [Terminal A2 Bias Setting]* to adjust the characteristics of the analog input signal to terminal A2.

■ H3-12: Terminal A2 Bias Setting

No. (Hex.)	Name	Description	Default Setting (Range)
H3-12 (041A) RUN	Terminal A2 Bias Setting	V/f CL-V/f OLV CLV AOLV OLV/PM AOLV/PM CLV/PM EZOLV Sets the bias of the analog signal to be input to the MFAI terminal A2.	0.0% (-999.9 - +999.9%)

This parameter sets the bias for the function set for terminal A2 as a percentage when 0 V (4 mA or 0 mA) is input.

Use *H3-11 [Terminal A2 Gain Setting]* and *H3-12* to adjust the characteristics of the analog input signal to terminal A2.

■ H3-13: Analog Input Filter Time Constant

No. (Hex.)	Name	Description	Default Setting (Range)
H3-13 (041B)	Analog Input Filter Time Constant	V/f CL-V/f OLV CLV AOLV OLV/PM AOLV/PM CLV/PM EZOLV Sets the time constant when applying a primary delay filter to the MFAI terminal.	0.03 s (0.00 - 2.00 s)

Applying the primary delay filter to the analog input enables an analog input signal without high-frequency noise components to be obtained. An analog input filter prevents erratic drive control. Drive operation becomes more stable as the programmed time becomes longer, but it also becomes less responsive to rapidly changing analog signals.

■ H3-14: Analog Input Term Enable Select

No. (Hex.)	Name	Description	Default Setting (Range)
H3-14 (041C)	Analog Input Terminal Enable Sel	V/f CL-V/f OLV CLV AOLV OLV/PM AOLV/PM CLV/PM EZOLV Selects the enabled terminal Sx when $H1-xx = C$ [<i>Terminal Sx Function Selection = Analog Terminal Enable Selection</i>] is ON. Also selects the disabled terminal Sx when the input is OFF.	7 (1 - 7)

The terminals not set as the target are not influenced by input signals.

1 : Terminal A1 only

2 : Terminal A2 only

3 : Terminals A1 and A2 only

4 : Terminal A3 only

5 : Terminals A1 and A3

6 : Terminals A2 and A3

7 : All terminals enabled

Note:

- Only the analog input terminal selected with H3-14 is affected by the ON/OFF operation of the terminal Sx as set with *Analog Terminal Input Selection* [H1-xx = C].
- When not H1-xx = C, the functions set to terminals A1 to A3 will be enabled all of the time.

■ H3-16: Terminal A1 Offset

No. (Hex.)	Name	Description	Default Setting (Range)
H3-16 (02F0)	Terminal A1 Offset	<div style="display: flex; justify-content: space-between; font-size: 0.8em; font-weight: bold; margin-bottom: 5px;"> V/f CL-V/f OLV CLV AOLV OLV/IPM AOLV/IPM CLV/IPM EZOLV </div> Sets the offset level for the analog signal input to terminal A1. Normally there is no need to change this setting.	0 (-500 - +500)

Adds the offset value for the analog input value. For voltage input, sets the offset when a signal of 0 V is input. For current input, sets the offset when a signal of 4 mA [H3-01 = 2] or 0 mA [H3-01 = 3] is input.

■ H3-17: Terminal A2 Offset

No. (Hex.)	Name	Description	Default Setting (Range)
H3-17 (02F1)	Terminal A2 Offset	<div style="display: flex; justify-content: space-between; font-size: 0.8em; font-weight: bold; margin-bottom: 5px;"> V/f CL-V/f OLV CLV AOLV OLV/IPM AOLV/IPM CLV/IPM EZOLV </div> Sets the offset level for analog signals input to terminal A2. Normally there is no need to change this setting.	0 (-500 - +500)

Adds the offset value for the analog input value. For voltage input, sets the offset when a signal of 0 V is input. For current input, sets the offset when a signal of 4 mA [H3-09 = 2] or 0 mA [H3-09 = 3] is input.

■ H3-18: Terminal A3 Offset

No. (Hex.)	Name	Description	Default Setting (Range)
H3-18 (02F2)	Terminal A3 Offset	<div style="display: flex; justify-content: space-between; font-size: 0.8em; font-weight: bold; margin-bottom: 5px;"> V/f CL-V/f OLV CLV AOLV OLV/IPM AOLV/IPM CLV/IPM EZOLV </div> Sets the offset level for analog signals input to terminal A3. Normally there is no need to change this setting.	0 (-500 - +500)

Adds the offset value for the analog input value. For voltage input, sets the offset when a signal of 0 V is input. For current input, sets the offset when a signal of 4 mA [H3-05 = 2] or 0 mA [H3-05 = 3] is input.

■ H3-40: Extend MFAI1 Function Selection

No. (Hex.)	Name	Description	Default Setting (Range)
H3-40 (0B5C)	Extend MFAI1 Function Selection	<div style="display: flex; justify-content: space-between; font-size: 0.8em; font-weight: bold; margin-bottom: 5px;"> V/f CL-V/f OLV CLV AOLV OLV/IPM AOLV/IPM CLV/IPM EZOLV </div> Selects the MEMOBUS AI1 function.	F (4 - 2F)

The MFAI function can be used from the MEMOBUS/Modbus communications. Sets the desired function in H3-40. Sets the input for the function in MEMOBUS/Modbus register 15C1. Refer to H3-xx “MFAI Setting Values” for the setting values.

■ H3-41: Extend MFAI2 Function Selection

No. (Hex.)	Name	Description	Default Setting (Range)
H3-41 (0B5F)	Extend MFAI2 Function Selection	<div style="display: flex; justify-content: space-between; font-size: 0.8em; font-weight: bold; margin-bottom: 5px;"> V/f CL-V/f OLV CLV AOLV OLV/IPM AOLV/IPM CLV/IPM EZOLV </div> Selects the MEMOBUS AI2 function.	F (4 - 2F)

Refer to H3-xx “MFAI Setting Values” for the setting values.

■ H3-42: Extend MFAI3 Function Selection

No. (Hex.)	Name	Description	Default Setting (Range)
H3-42 (0B62)	Extend MFAI3 Function Selection	V/f CL-V/f OLV CLV AOLV OLV/PM AOLV/PM CLV/PM EZOLV Selects the MEMOBUS AI3 function.	F (4 - 2F)

Refer to H3-xx “MFAI Setting Values” for the setting values.

■ H3-43: Filter Time for MFAI

No. (Hex.)	Name	Description	Default Setting (Range)
H3-43 (117F)	Filter Time for MFAI	V/f CL-V/f OLV CLV AOLV OLV/PM AOLV/PM CLV/PM EZOLV Sets the time constant when applying a primary delay filter to the MEMOBUS analog input terminal.	0.00 s (0.00 to 2.00 s)

◆ Multi-Function Analog Input Terminal Settings

The following section describes the functions set with *H3-02*, *H3-06*, and *H3-10*.

■ 0: Frequency Bias

Setting	Function	Description
0	Frequency BiasMaster frequency reference	V/f CL-V/f OLV CLV AOLV OLV/PM AOLV/PM CLV/PM EZOLV The input value from the analog input terminal set with this function becomes the master frequency reference.

- The configuration can be duplicated to multiple analog input terminals A1 through A3. When multiple analog input terminals is set with the master frequency reference, the sum value becomes the frequency bias.
- When using this function to set the analog input value as the master frequency reference, set $b1-01 = 1$ [*Frequency Reference Selection 1 = Analog Input*]. This setting value is the default value for both terminals A1 and A2.
- The frequency reference is the sum of the input values for both terminals A1 and A2 when they are used simultaneously. For example, when a 20% bias is input to terminal A2 while a frequency reference of 50% is input from terminal A1, the calculated frequency reference will be 70% of the maximum output frequency.

■ 1: Frequency Gain

Setting	Function	Description
1	Frequency Gain	V/f CL-V/f OLV CLV AOLV OLV/PM AOLV/PM CLV/PM EZOLV The input value from the analog input terminal set with this function is multiplied by the analog frequency reference.

(Ex.) When a 50% frequency gain is input to terminal A2 while a frequency reference of 80% is input from terminal A1 and the frequency gain is set to terminal 2, the calculated frequency reference will be 40% of the maximum output frequency.

■ 2: Auxiliary Frequency Reference 1

Setting	Function	Description
2	Auxiliary Frequency Reference 1	V/f CL-V/f OLV CLV AOLV OLV/PM AOLV/PM CLV/PM EZOLV When Reference 2 is selected via multi-step speed reference, the command reference (Auxiliary Frequency Reference 1) from the analog input terminal set with this setting is enabled. Set $E1-04$ [<i>Maximum Output Frequency</i>] as 100%.

■ 3: Auxiliary Frequency Reference 2

Setting	Function	Description
3	Auxiliary Frequency Reference 2	V/f CL-V/f OLV CLV AOLV OLV/PM AOLV/PM CLV/PM EZOLV When Reference 3 is selected via multi-step speed reference, the command reference (Auxiliary Frequency Reference 2) from the analog input terminal set with this setting is enabled. Set $E1-04$ [<i>Maximum Output Frequency</i>] as 100%.

4: Output Voltage Bias

Setting	Function	Description
4	Output Voltage Bias	<div style="display: flex; justify-content: space-between; font-size: small;"> V/f CL-V/f OLV CLV AOLV OLV/PM AOLV/PM CLV/PM EZOLV </div> Set this parameter to input a bias signal that amplifies the output voltage.

The gain (%) for the MFAI terminals A1, A2, and A3 is 100% of the voltage class standard, which is 200 V for 200 V class drives and 400 V for 400 V class drives. The bias (%) for MFAI terminals A1, A2, and A3 is 100% of the voltage configured for E1-05 [Maximum Output Voltage].

Note:

The gain for each of terminals A1, A2, and A3 is configured independently with H3-03 [Terminal A1 Gain Setting], H3-11 [Terminal A2 Gain Setting], and H3-07 [Terminal A3 Gain Setting]. The bias for each of terminals A1, A2, and A3 is configured independently with H3-04 [Terminal A1 Bias Setting], H3-12 [Terminal A2 Bias Setting], and H3-08 [Terminal A3 Bias Setting].

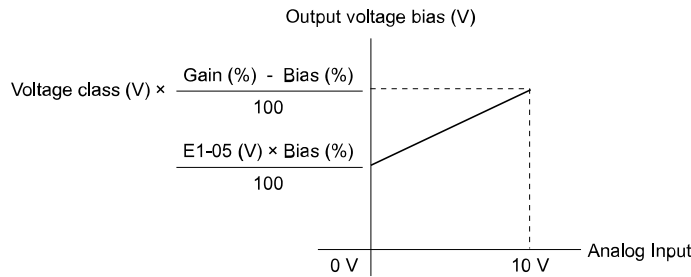

Figure 11.102 Output Voltage Bias via Analog Input

5: Accel/Decel Time Gain

Setting	Function	Description
5	Accel/Decel Time Gain	<div style="display: flex; justify-content: space-between; font-size: small;"> V/f CL-V/f OLV CLV AOLV OLV/PM AOLV/PM CLV/PM EZOLV </div> Inputs the signal that adjusts the gain used for C1-01 through C1-08 [Accel & Decel Time 1 through 4] assuming that the full scale analog signal (10 V or 20 mA) is 100%.

The acceleration time when C1-01 [Acceleration Time 1] is enabled is as follows.

$$\text{Acceleration Time 1} = \text{Setting value of C1-01} \times \text{acceleration and deceleration time gain} / 100$$

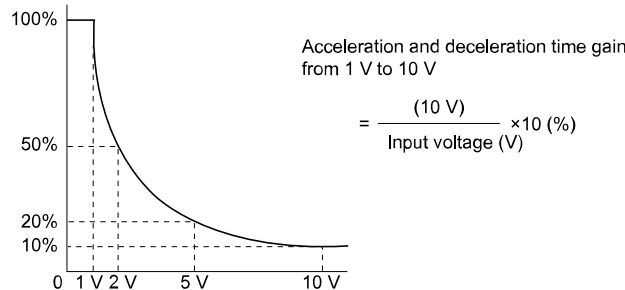

Figure 11.103 Acceleration/Deceleration Time Gain via Analog Input

6: DC Injection Braking Current

Setting	Function	Description
6	DC Injection Braking Current	<div style="display: flex; justify-content: space-between; font-size: small;"> V/f CL-V/f OLV CLV AOLV OLV/PM AOLV/PM CLV/PM EZOLV </div> Inputs the signal that adjusts the current level used for DC Injection Braking assuming that the drive rated output current is 100%.

Note:

Configuring this function disables the setting value of b2-02 [DC Injection Braking Current].

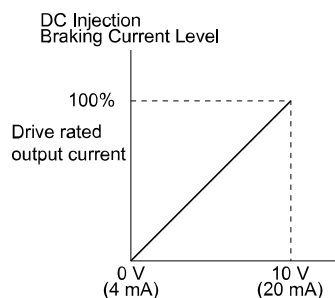

Figure 11.104 DC Injection Braking Current via Analog Input

■ 7: Overtorque/Undertorque DetectLvl

Setting	Function	Description
7	Overtorque/Undertorque DetectLvl	<div style="display: flex; justify-content: space-between; font-size: small;"> V/f CL-V/f OLV CLV AOLV OLV/PM AOLV/PM CLV/PM EZOLV </div> Inputs the signal that adjusts the overtorque/undertorque detection level.

The drive rated current is 100% when A1-02 = 0, 1, 5 [Control Method Selection = V/f Control, Closed Loop V/f Control, PM Open Loop Vector Control] is set. The motor rated current is 100% when A1-02 = 2, 3, 4, 6, 7, 8 [Open Loop Vector Control, Closed Loop Vector Control, Advanced OpenLoop Vector Control, PM Advanced Open Loop Vector, PM Closed Loop Vector Control, or EZ Open Loop Vector Control] is set.

Note:

Use this function in conjunction with L6-01 [Torque Detection Selection 1]. This parameter functions in place of L6-02 [Torque Detection Level 1].

■ 8: Stall Prevention Level DuringRun

Setting	Function	Description
8	Stall Prevention Level DuringRun	<div style="display: flex; justify-content: space-between; font-size: small;"> V/f CL-V/f OLV CLV AOLV OLV/PM AOLV/PM CLV/PM EZOLV </div> Inputs the signal that adjusts the stall prevention level during run assuming that the drive rated current is 100%.

Note:

The valid stall prevention level during run is the lower value of the analog input value for the MFAI terminal and the setting value for L3-06 [Stall Prevent Level during Run].

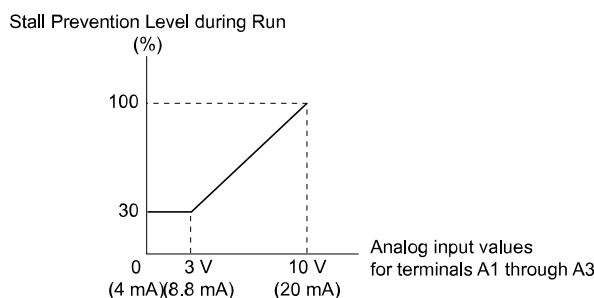

Figure 11.105 Stall Prevention Level during Run via Analog Input

■ 9: Output Freq Lower Limit Level

Setting	Function	Description
9	Output Freq Lower Limit Level	<div style="display: flex; justify-content: space-between; font-size: small;"> V/f CL-V/f OLV CLV AOLV OLV/PM AOLV/PM CLV/PM EZOLV </div> Inputs the signal that adjusts the output frequency lower limit level assuming that E1-04 [Maximum Output Frequency] is 100%.

■ B: PID Feedback

Setting	Function	Description
B	PID Feedback	<div style="display: flex; justify-content: space-between; font-size: small;"> V/f CL-V/f OLV CLV AOLV OLV/PM AOLV/PM CLV/PM EZOLV </div> Inputs the PID feedback value.

Sets the current PID feedback value when the 10 V (or 20 mA) analog signal is input as 100%.

Set *b5-01 = 1 through 8 [PID Function Setting = Enabled]* when using this function.

■ **C: PID Setpoint**

Setting	Function	Description
C	PID Setpoint	V/f CL-V/f OLV CLV AOLV OLV/PM AOLV/PM CLV/PM EZOLV Inputs the PID setpoint.

Sets the current PID feedback value when the 10 V (or 20 mA) analog signal is input as 100%.

Set *b5-01 = 1 through 8 [PID Function Setting = Enabled]* when using this function.

Note:

Configuring this function disables the frequency reference set with *b1-01 [Frequency Reference Selection 1]*.

■ **D: Frequency Bias**

Setting	Function	Description
D	Frequency Bias	V/f CL-V/f OLV CLV AOLV OLV/PM AOLV/PM CLV/PM EZOLV Inputs the bias value added to the frequency reference assuming that <i>E1-04 [Maximum Output Frequency]</i> is 100%.

The input value from the analog input terminal set with this function is added to the frequency reference as the bias value. Note that this function is disabled when *d1-xx* is selected as the frequency reference.

■ **E: Motor Temperature (PTC input)**

Setting	Function	Description
E	Motor Temperature (PTC input)	V/f CL-V/f OLV CLV AOLV OLV/PM AOLV/PM CLV/PM EZOLV Uses the motor Positive Temperature Coefficient (PLC) thermistor to protect the motor from heat on the basis that the current value at the time the 10 V (or 20 mA) analog signal is input is 100%.

- The Positive Temperature Coefficient (PLC) thermistor can be used as an auxiliary or alternative detection function for issues of drive *oL1 [Motor Overload]* to help protect motors from heat. If the PTC input signal exceeds the overload alarm level, *oH3 [Motor Overheating Alarm]* flashes on the keypad.
- The motor is stopped in accordance with the method selected by *L1-03* when *oH3* is detected and in accordance with the method selected by *L1-04* when *oH4* is detected. Set *L1-05* when false detections of motor overheating issues occur.

■ **F: Through Mode**

Setting	Function	Description
F	Through Mode	V/f CL-V/f OLV CLV AOLV OLV/PM AOLV/PM CLV/PM EZOLV Use this setting when terminals are not used or to use terminals in through mode.

If a terminal not in use is set to F, the signal input to the terminal can be used as PLC analog signal input via MEMOBUS/Modbus communications or the communication option. This input signal does not affect drive operation. This functions the same as 1F (Through Mode).

■ **10: Forward Torque Limit**

Setting	Function	Description
10	Forward Torque Limit	V/f CL-V/f OLV CLV AOLV OLV/PM AOLV/PM CLV/PM EZOLV Inputs the forward torque limit assuming that the motor rated torque is 100%.

DANGER! Sudden Movement Hazard. Set torque limits appropriately for applications such elevators. If torque limits are not set appropriately, the vertical axis can fall due to insufficient motor torque, which may damage equipment and cause injury.

Torque Limit Configuration Method

Set torque limits using one of the following methods.

- Individually set the 4 torque limit quadrants using *L7-01 through L7-04 [Torque Limit]*.
- Individually set the 4 torque limit quadrants via MFAI. Set *H3-02, H3-06, or H3-10 [MFAI Function Select]* to 10, 11, or 12 [*Forward/Reverse/Regenerative Torque Limit*].
- Set all 4 torque limit quadrants commonly via MFAI. Set *H3-02, H3-06, or H3-10* to 15 [*General Torque Limit*].

The following figure illustrates the configuration method for each quadrant.

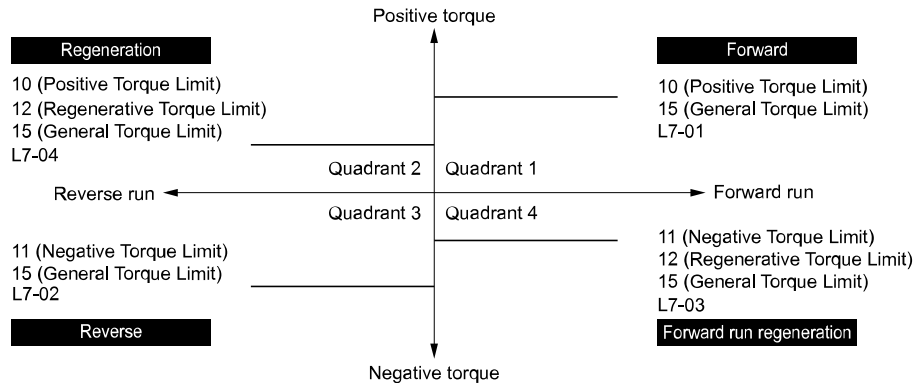

Figure 11.106 Torque Limits and Analog Input Settings Parameters

Note:

- The lower torque limit is enabled when using both L7-01 through L7-04 and analog inputs to set torque limits for the same quadrant. As in the following example of parameter settings, the torque limit for quadrant 1 is 130% and the torque limit for quadrants 2, 3, and 4 is 150%.
Settings: L7-01 = 130%; L7-02 through L7-04 = 200%; and MFAI torque limit = 150%
- Maximum output torque is limited by the output current of the drive. Torque is limited to 150% of the rated output current for HD and to 120% of the rated output current for ND. The actual output torque cannot exceed the limits of the drive rated output current even if the torque limit is set to a high value.

Be aware of the following points when using drives in applications in which the vertical axis may fall.

- Configure drives and motors appropriately.
- Configure parameters correctly.
- Parameter setting values may be changed after performing Auto-Tuning.
- Design the system that can prevent the vertical axis from falling if the drive fails.

The following figure illustrates the relationship between torque limits via parameters and torque limits via analog input.

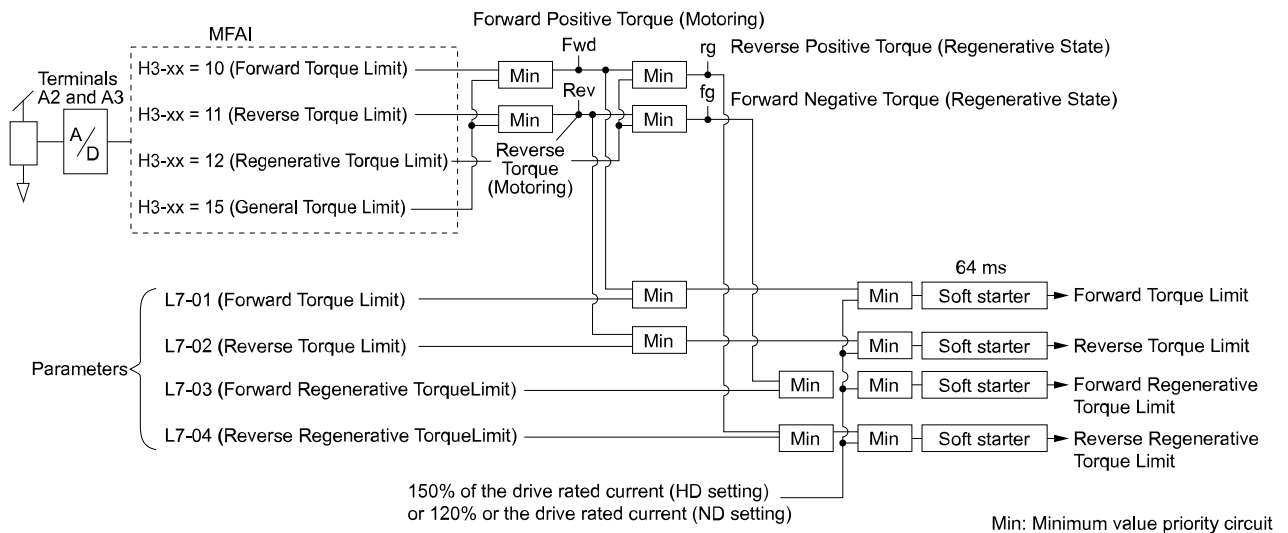

Figure 11.107 Torque Limits via Parameters and Analog Inputs

■ 11: Reverse Torque Limit

Setting	Function	Description
11	Reverse Torque Limit	V/f CL-V/f OLV CLV AOLV OLV/PM AOLV/PM CLV/PM EZOLV Inputs the load torque limit assuming that the motor rated torque is 100%.

Note:

The lower torque limit is enabled when using both L7-01 through L7-04 and analog inputs to set torque limits for the same quadrant.

■ **12: Regenerative Torque Limit**

Setting	Function	Description
12	Regenerative Torque Limit	<input type="checkbox"/> V/f <input type="checkbox"/> CL-V/f <input checked="" type="checkbox"/> OLV <input checked="" type="checkbox"/> CLV <input type="checkbox"/> AOLV <input type="checkbox"/> OLV/PM <input type="checkbox"/> AOLV/PM <input type="checkbox"/> CLV/PM <input type="checkbox"/> EZOLV Inputs the regenerative torque limit assuming that the motor rated torque is 100%.

Note:

The lower torque limit is enabled when using both L7-01 through L7-04 and analog inputs to set torque limits for the same quadrant.

■ **13: Torque Reference / Torque Limit**

Setting	Function	Description
13	Torque Reference / Torque Limit	<input type="checkbox"/> V/f <input type="checkbox"/> CL-V/f <input type="checkbox"/> OLV <input checked="" type="checkbox"/> CLV <input type="checkbox"/> AOLV <input type="checkbox"/> OLV/PM <input type="checkbox"/> AOLV/PM <input type="checkbox"/> CLV/PM <input type="checkbox"/> EZOLV Inputs the torque reference assuming that the motor rated torque is 100%. This parameter operates as the torque limit for speed control.

Note:

The lower torque limit is enabled when using both L7-01 through L7-04 and analog inputs to set torque limits for the same quadrant.

■ **14: Torque Compensation**

Setting	Function	Description
14	Torque Compensation	<input type="checkbox"/> V/f <input type="checkbox"/> CL-V/f <input type="checkbox"/> OLV <input checked="" type="checkbox"/> CLV <input type="checkbox"/> AOLV <input type="checkbox"/> OLV/PM <input type="checkbox"/> AOLV/PM <input type="checkbox"/> CLV/PM <input type="checkbox"/> EZOLV Inputs the torque compensation value assuming that the motor rated torque is 100%.

■ **15: General Torque Limit**

Setting	Function	Description
15	General Torque Limit	<input type="checkbox"/> V/f <input type="checkbox"/> CL-V/f <input checked="" type="checkbox"/> OLV <input checked="" type="checkbox"/> CLV <input type="checkbox"/> AOLV <input type="checkbox"/> OLV/PM <input type="checkbox"/> AOLV/PM <input type="checkbox"/> CLV/PM <input type="checkbox"/> EZOLV Inputs the torque limit common to all quadrants for forward, reverse, and regenerative operation assuming that the motor rated torque is 100%.

■ **16: Differential PID Feedback**

Setting	Function	Description
16	Differential PID Feedback	<input type="checkbox"/> V/f <input type="checkbox"/> CL-V/f <input type="checkbox"/> OLV <input checked="" type="checkbox"/> CLV <input type="checkbox"/> AOLV <input type="checkbox"/> OLV/PM <input type="checkbox"/> AOLV/PM <input type="checkbox"/> CLV/PM <input type="checkbox"/> EZOLV Inputs the PID differential feedback value assuming that the full scale analog signal (10 V or 20 mA) is 100%.

Calculates the PID input from the deviation between the PID feedback and the differential feedback value signals.

■ **1F: Through Mode**

Setting	Function	Description
1F	Through Mode	<input type="checkbox"/> V/f <input type="checkbox"/> CL-V/f <input type="checkbox"/> OLV <input checked="" type="checkbox"/> CLV <input type="checkbox"/> AOLV <input type="checkbox"/> OLV/PM <input type="checkbox"/> AOLV/PM <input type="checkbox"/> CLV/PM <input type="checkbox"/> EZOLV Use this setting when terminals are not used or to use terminals in through mode.

If a terminal not used is set to 1F, the signal input to the terminal can be used as PLC analog signal input via MEMOBUS/Modbus communications or the communication option. This input signal does not affect drive operation. This functions the same as F (Through Mode).

■ **30: DriveWorksEZ analog input 1**

Setting	Function	Description
30	DriveWorksEZ analog input 1	<input type="checkbox"/> V/f <input type="checkbox"/> CL-V/f <input type="checkbox"/> OLV <input checked="" type="checkbox"/> CLV <input type="checkbox"/> AOLV <input type="checkbox"/> OLV/PM <input type="checkbox"/> AOLV/PM <input type="checkbox"/> CLV/PM <input type="checkbox"/> EZOLV Used with DriveWorksEZ. Refer to the DriveWorksEZ Online Manual for more information.

■ **31: DriveWorksEZ analog input 2**

Setting	Function	Description
31	DriveWorksEZ analog input 2	<input type="checkbox"/> V/f <input type="checkbox"/> CL-V/f <input type="checkbox"/> OLV <input checked="" type="checkbox"/> CLV <input type="checkbox"/> AOLV <input type="checkbox"/> OLV/PM <input type="checkbox"/> AOLV/PM <input type="checkbox"/> CLV/PM <input type="checkbox"/> EZOLV Used with DriveWorksEZ. Refer to the DriveWorksEZ Online Manual for more information.

■ 32: DriveWorksEZ analog input 3

Setting	Function	Description
32	DriveWorksEZ analog input 3	<div style="display: flex; justify-content: space-between; font-size: small;"> V/f CL-V/f OLV CLV AOLV OLV/PM AOLV/PM CLV/PM EZOLV </div> Used with DriveWorksEZ. Refer to the DriveWorksEZ Online Manual for more information.

◆ H4: Analog Outputs

H4 parameters set the drive analog monitors. These parameters select monitor parameters, adjust gain and bias, and select output signal levels.

■ Calibration of Meters Connected to Multi-function Analog Output Terminals FM and AM

Meters connected to terminals FM and AM can be calibrated using *H4-02*, *H4-03*, *H4-05*, and *H4-06* [*FM/AM Analog Output Gain/Bias*].

No.	Name	Setting Range	Default Setting
H4-02	FM Analog Output Gain	-999.9 - 999.9%	100.0%
H4-03	FM Analog Output Bias	-999.9 - 999.9%	0.0%
H4-05	AM Analog Output Gain	-999.9 - 999.9%	50.0%
H4-06	AM Analog Output Bias	-999.9 - 999.9%	0.0%
H4-07	MFAO Term FM Signal Level Select	0: 0-10 VDC 1: -10 +10 VDC 2: 4-20 mA	0
H4-08	MFAO Term AM Signal Level Select	0: 0-10 VDC 1: -10 +10 VDC 2: 4-20 mA	0

The following diagram illustrates the gain and bias.

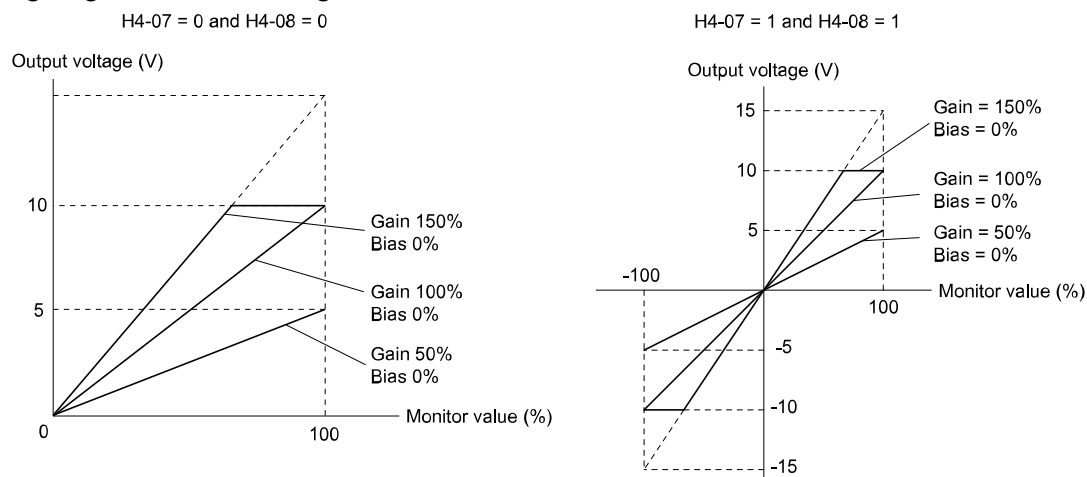

Figure 11.108 Analog Output Gain/Bias Configuration Example 1

For example, when the parameter value configured to analog output is 0 and a 3 V signal is output to terminal FM, *H4-03* [*FM Analog Output Bias*] is set to 30%.

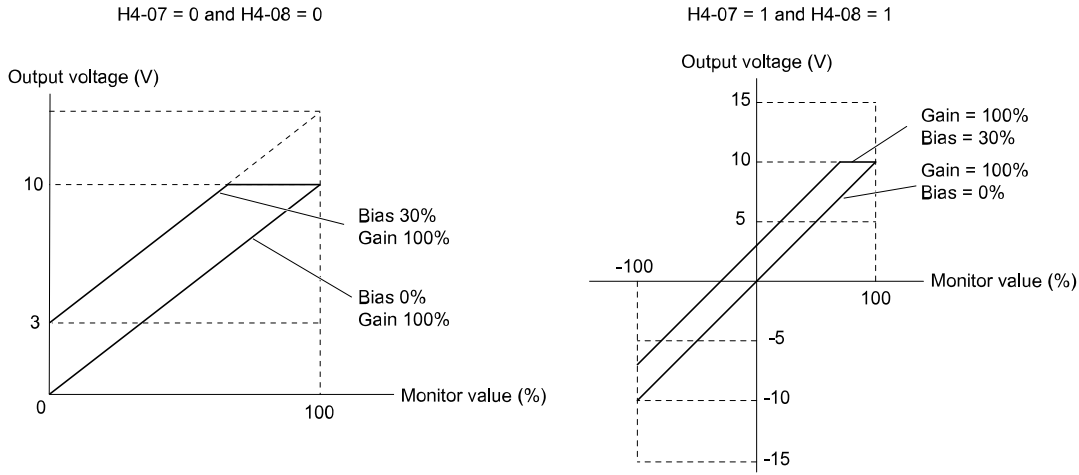

Figure 11.109 Analog Output Gain/Bias Configuration Example 2

Calibrate Terminal FM

Meters can be calibrated when the drive is stopped. Use the following procedure to perform calibration.

1. Show *H4-02 [FM Analog Output Gain]* on the keypad.
The analog signal at the time when the monitor item selected with *H4-01 [MFAO Terminal FM Monitor Select]* is 100% is output from terminal FM.
2. Adjust *H4-02* while referencing the meter scale connected to terminal FM.
3. Show *H4-03 [FM Analog Output Bias]* on the keypad.
The analog signal at the time when the monitor item selected with *H4-01* is 0% is output from terminal FM.
4. Adjust *H4-03* while referencing the meter scale connected to terminal FM.

Calibrate Terminal AM

Meters can be calibrated when the drive is stopped. Use the following procedure to perform calibration.

1. Show *H4-05 [AM Analog Output Gain]* on the keypad.
The analog signal at the time when the monitor item selected with *H4-04 [MFAO Terminal AM Monitor Select]* is 100% is output from terminal AM.
2. Adjust *H4-05* while referencing the meter scale connected to terminal AM.
3. Show *H4-06 [AM Analog Output Bias]* on the keypad.
The analog signal at the time when the monitor item selected with *H4-04* is 0% is output from terminal AM.
4. Adjust *H4-06* while referencing the meter scale connected to terminal AM.

■ **H4-01: MFAO Terminal FM Monitor Select**

No. (Hex.)	Name	Description	Default (Range)
H4-01 (041D)	Terminal FM Analog Output Select	V/f CL-V/f OLV CLV AOLV OLV/IPM AOLV/IPM CLV/IPM EZOLV Sets the monitoring number to be output from multi-function analog output terminal FM.	102 (000 - 999)

Note:

- The configurable monitor data varies depending on the control mode.
- Set this parameter to *000* or *031* to use in through mode. The terminal FM output level from the PLC via MEMOBUS/Modbus or the communication option can be configured.

■ **H4-02: FM Analog Output Gain**

No. (Hex.)	Name	Description	Default Setting (Range)
H4-02 (041E) RUN	Terminal FM Analog Output Gain	V/f CL-V/f OLV CLV AOLV OLV/IPM AOLV/IPM CLV/IPM EZOLV Sets the gain of the monitoring signal that is output from the MFAO terminal FM as a percentage. Set the terminal FM output signal level when an output of 0% for monitoring items is 0 V (or 4 mA) and when an output for monitoring items is 100%, and sets 10 V (or 20 mA) as 100%.	100.0% (-999.9 - 999.9%)

The analog signal output from the FM terminal is a maximum of ±10 V (or 20 mA). The signal level can be selected with *H4-07 [MFAO Term FM Signal Level Select]*.

■ H4-03: FM Analog Output Bias

No. (Hex.)	Name	Description	Default Setting (Range)
H4-03 (041F) RUN	Terminal FM Analog Output Bias	<div style="display: flex; justify-content: space-between; font-size: 0.8em; font-weight: bold; margin-bottom: 5px;"> V/f CL-V/f OLV CLV AOLV OLV/PM AOLV/PM CLV/PM EZOLV </div> Sets the bias of the monitoring signal that is output from the MFAO terminal FM as a percentage. Set the level of the analog signal output from the FM terminal at 10 V (or 20 mA) as 100% when an output for monitoring items is 0%.	0.0% (-999.9 - 999.9%)

The analog signal output from the FM terminal is a maximum of ± 10 V (or 20 mA). The signal level can be selected with *H4-07 [MFAO Term FM Signal Level Select]*.

■ H4-04: MFAO Terminal AM Monitor Select

No. (Hex.)	Name	Description	Default (Range)
H4-04 (0420)	Terminal AM Analog Output Select	<div style="display: flex; justify-content: space-between; font-size: 0.8em; font-weight: bold; margin-bottom: 5px;"> V/f CL-V/f OLV CLV AOLV OLV/PM AOLV/PM CLV/PM EZOLV </div> Sets the monitoring number to be output from the MFAO terminal AM.	103 (000 - 999)

Note:

- The configurable monitor data varies depending on the control mode.
- Set this parameter to *000* or *031* to use in through mode. The terminal AM output level can be set from the PLC via MEMOBUS/Modbus or the communication option.

■ H4-05: AM Analog Output Gain

No. (Hex.)	Name	Description	Default Setting (Range)
H4-05 (0421) RUN	Terminal AM Analog Output Gain	<div style="display: flex; justify-content: space-between; font-size: 0.8em; font-weight: bold; margin-bottom: 5px;"> V/f CL-V/f OLV CLV AOLV OLV/PM AOLV/PM CLV/PM EZOLV </div> Sets the gain of the monitor signal that is output from the MFAO terminal AM as a percentage. Sets the level of the analog signal output from the AM terminal when an output of 0% for monitoring items is 0 V (or 4 mA) and when an output for monitoring items is 100%, and sets 10 V (or 20 mA) as 100%.	50.0% (-999.9 - 999.9%)

The analog signal output from the AM terminal is a maximum of ± 10 V (or 20 mA). The signal level can be selected with *H4-08 [MFAO Term AM Signal Level Select]*.

Example settings:

When the output current of a monitoring item is 100% (drive rated current) in the following example, the voltage of AM terminal outputs at 5 V (50% of 10 V). Consequently, the output current at the time the AM terminal outputs a maximum voltage of 10 V will be 200% of the drive rated current.

- *H4-04 = 103 [MFAO Terminal AM Monitor Select = Output Current]*
- *H4-05 = 50.0%*
- *H4-06 = 0.0% [AM Analog Output Bias = 0.0%]*
- *H4-08 = 0 [0 to 10 V]*

■ H4-06: AM Analog Output Bias

No. (Hex.)	Name	Description	Default Setting (Range)
H4-06 (0422) RUN	Terminal AM Analog Output Bias	<div style="display: flex; justify-content: space-between; font-size: 0.8em; font-weight: bold; margin-bottom: 5px;"> V/f CL-V/f OLV CLV AOLV OLV/PM AOLV/PM CLV/PM EZOLV </div> Sets the bias of the monitoring signal that is output from the MFAO terminal AM as a percentage. Set the level of the analog signal output from the AM terminal at 10 V (or 20 mA) as 100% when an output for monitoring items is 0%.	0.0% (-999.9 - 999.9%)

The analog signal output from the AM terminal is a maximum of ± 10 V (or 20 mA). The signal level can be selected with *H4-08 [MFAO Term AM Signal Level Select]*.

■ H4-07: MFAO Term FM Signal Level Select

No. (Hex.)	Name	Description	Default (Range)
H4-07 (0423)	Terminal FM Signal Level Select	V/f CL-V/f OLV CLV AOLV OLV/PM AOLV/PM CLV/PM EZOLV Selects the output signal level from the MFAO terminal FM.	0 (0 - 2)

Note:

Set jumper S5 on the control circuit terminal block accordingly when changing these parameters.

0 : 0-10 VDC

1 : -10 +10 VDC

2 : 4-20 mA

■ H4-08: MFAO Term AM Signal Level Select

No. (Hex.)	Name	Description	Default (Range)
H4-08 (0424)	Terminal AM Signal Level Select	V/f CL-V/f OLV CLV AOLV OLV/PM AOLV/PM CLV/PM EZOLV Selects the signal level output from the MFAO terminal AM.	0 (0 - 2)

Note:

Set jumper S5 on the control circuit terminal block accordingly when changing these parameters.

0 : 0-10 VDC

1 : -10 +10 VDC

2 : 4-20 mA

■ H4-20: Output Power Monitor Level

No. (Hex.)	Name	Description	Default Setting (Range)
H4-20 (0B53)	Output power monitor level	V/f CL-V/f OLV CLV AOLV OLV/PM AOLV/PM CLV/PM EZOLV Sets the level at 10 V when U1-08 [Output Power] executes analog output.	0.00 kW (0.00 - 650.00 kW)

Note:

- When H4-20 = 0.00 kW, the output power monitor 10 V level = motor rated power (kW). It is determined by the A1-02 [Control Method Selection] setting.
 - A1-02 = 0, 1 [V/f Control, Closed Loop V/f Control]: E2-11 [Motor Rated Power (kW)]
 - A1-02 = 2, 3, 4 [Open Loop Vector Control, Closed Loop Vector Control, Advanced Open Loop Vector Control]: E2-11 [Motor Rated Power (kW)]
 - A1-02 = 5, 6, 7 [PM Open Loop Vector Control, PM Advanced Open Loop Vector, PM Closed Loop Vector Control]: E5-02 [PM Motor Rated Capacity]
 - A1-02 = 8 [EZ Open Loop Vector Control]: E9-07 [Mtr Rated Power]

◆ H5: Memobus/Modbus Communication

H5 parameters are used to configure the drive to use MEMOBUS/Modbus communications.

Serial communication with programmable controllers (PLC) can be performed using the MEMOBUS/Modbus protocol over the RS-485 port (terminals D+ and D-) built into the drive.

■ H5-01: Drive Node Address

No. (Hex.)	Name	Description	Default (Range)
H5-01 (0425)	Drive Node Address	V/f CL-V/f OLV CLV AOLV OLV/PM AOLV/PM CLV/PM EZOLV Sets the communication slave address for drives.	1FH (0 - FFH)

Note:

- Restart the drive to enable the settings.
- Setting the parameter to 0 will cause the drive to stop responding to MEMOBUS/Modbus communications.

The drive must be configured with a slave address to enable the drive to communicate with the controller (master) over MEMOBUS/Modbus communications. Set H5-01 to any value other than 0.

Configure a unique slave address that does not conflict with other slave devices.

■ H5-02: Communication Speed Selection

No. (Hex.)	Name	Description	Default (Range)
H5-02 (0426)	Communication Speed Selection	<div style="display: flex; justify-content: space-between; font-size: 8px; font-weight: bold;"> V/f CL-V/f OLV CLV AOLV OLV/PM AOLV/PM CLV/PM EZOLV </div> Selects the communications speed for MEMOBUS/Modbus communications.	3 (0 - 8)

Note:

Restart the drive to enable the settings.

0 : 1200 bps

1 : 2400 bps

2 : 4800 bps

3 : 9600 bps

4 : 19.2 kbps

5 : 38.4 kbps

6 : 57.6 kbps

7 : 76.8 kbps

8 : 115.2 kbps

■ H5-03: Communication Parity Selection

No. (Hex.)	Name	Description	Default (Range)
H5-03 (0427)	Communication Parity Selection	<div style="display: flex; justify-content: space-between; font-size: 8px; font-weight: bold;"> V/f CL-V/f OLV CLV AOLV OLV/PM AOLV/PM CLV/PM EZOLV </div> Selects the communications parity used for MEMOBUS/Modbus communications.	0 (0 - 2)

Note:

Restart the drive to enable the settings.

0 : No parity

1 : Even parity

2 : Odd parity

■ H5-04: Stopping Method after Com Error

No. (Hex.)	Name	Description	Default (Range)
H5-04 (0428)	Stopping Method after Com Error	<div style="display: flex; justify-content: space-between; font-size: 8px; font-weight: bold;"> V/f CL-V/f OLV CLV AOLV OLV/PM AOLV/PM CLV/PM EZOLV </div> Selects the motor Stopping Method when <i>CE</i> [MEMOBUS/Modbus Communication Err] issues are detected.	3 (0 - 3)

0 : Ramp to stop

The drive ramps the motor to stop according to the deceleration time. The terminal turns on when $H2-xx = E$ [MFDO Function Select = Fault] is set.

1 : Coast to stop

The drive shuts off output and the motor coasts to stop. The terminal turns on when $H2-xx = E$.

2 : Fast Stop (use C1-09)

The drive stops the motor using the deceleration time set in *C1-09* [Fast Stop Time]. The terminal turns on when $H2-xx = E$.

3 : Alarm only

CE appears on the keypad, and operation continues.

■ **H5-05: Comm Fault Detection Select**

No. (Hex.)	Name	Description	Default (Range)
H5-05 (0429)	Comm Fault Detection Select	<div style="display: flex; justify-content: space-between; font-size: small;"> V/f CL-V/f OLV CLV AOLV OLV/PM AOLV/PM CLV/PM EZOLV </div> Selects whether to detect <i>CE</i> [MEMOBUS/Modbus Communication Err] issues during MEMOBUS/Modbus communications.	1 (0, 1)

A CE error is detected if the drive does not receive any data from the master during the time configured with H5-09 [CE Detection Time].

0 : Disabled

Does not perform CE detection. The drive continues operation.

1 : Enabled

Performs CE detection. If a CE error is detected, operation is performed in accordance with the setting of H5-04 [Stopping Method after Com Error].

■ **H5-06: Drive Transmit Wait Time**

No. (Hex.)	Name	Description	Default (Range)
H5-06 (042A)	Drive Transmit Wait Time	<div style="display: flex; justify-content: space-between; font-size: small;"> V/f CL-V/f OLV CLV AOLV OLV/PM AOLV/PM CLV/PM EZOLV </div> Sets the time to wait to send a response message after the drive receives a command message from the master.	5 ms (0 - 65 ms)

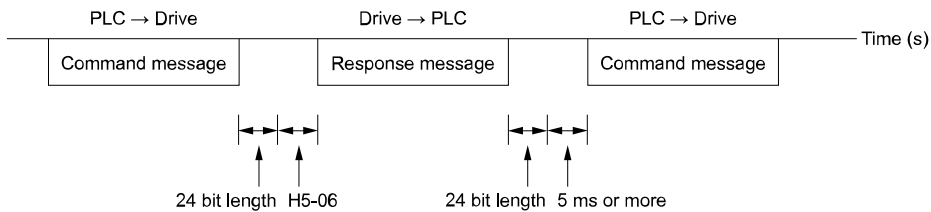

Figure 11.110 Drive Transmit Wait Time

■ **H5-09: CE Detection Time**

No. (Hex.)	Name	Description	Default (Range)
H5-09 (0435)	CE Detection Time	<div style="display: flex; justify-content: space-between; font-size: small;"> V/f CL-V/f OLV CLV AOLV OLV/PM AOLV/PM CLV/PM EZOLV </div> Sets the detection time for <i>CE</i> [MEMOBUS/Modbus Communication Err] issues when communication is disrupted.	2.0 s (0.0 - 10.0 s)

■ **H5-10: Unit Sel forMEMOBUS/Modbus 0025H**

No. (Hex.)	Name	Description	Default (Range)
H5-10 (0436)	Unit Sel forMEMOBUS/Modbus 0025H	<div style="display: flex; justify-content: space-between; font-size: small;"> V/f CL-V/f OLV CLV AOLV OLV/PM AOLV/PM CLV/PM EZOLV </div> Selects the unit of measure used for the MEMOBUS/Modbus communications monitor register 0025H (output voltage reference monitor).	0 (0, 1)

0 : 0.1 V units

1 : 1 V units

■ **H5-11: Communications ENTER Func Select**

No. (Hex.)	Name	Description	Default (Range)
H5-11 (043C)	Communications ENTER Func Select	<div style="display: flex; justify-content: space-between; font-size: small;"> V/f CL-V/f OLV CLV AOLV OLV/PM AOLV/PM CLV/PM EZOLV </div> Selects whether or not the Enter command is required to change parameters via MEMOBUS/Modbus communications.	0 (0, 1)

0 : Enter Required

The Enter command is required to enable changes to parameters. Input the Enter command after making all parameter changes.

1 : No EnterRequired

Changes to parameters are enabled immediately without the need to input the Enter command.

■ H5-12: Run Command Method Selection

No. (Hex.)	Name	Description	Default (Range)
H5-12 (043D)	Run Command Method Selection	V/f CL-V/f OLV CLV AOLV OLV/PM AOLV/PM CLV/PM EZOLV Selects the input method for the Run command when <i>b1-02</i> or <i>b1-16</i> [Run Command Selection] are set to 2 [MEMOBUS/Modbus Communications].	0 (0, 1)

0 : FWD/Stop, REV/Stop

Bit 0 in command data 0001H of the MEMOBUS register is used in the motor forward Run command (bit 0 = 1) and the stop command (bit 0 = 0). Bit 1 is used in the motor reverse Run command (bit 1 = 1) and the stop command (bit 1 = 0).

1 : Run/Stop, FWD/REV

Bit 0 in command data 0001H of the MEMOBUS register is used in the motor Run command (bit 0 = 1) and the stop command (bit 0 = 0). Bit 1 is used in the direction of motor rotation command (Forward run (bit1 = 0) or Reverse run (bit 1 = 1)).

■ H5-17: Busy Enter Selection

No. (Hex.)	Name	Description	Default Setting (Range)
H5-17 (11A1)	Busy Enter Selection	V/f CL-V/f OLV CLV AOLV OLV/PM AOLV/PM CLV/PM EZOLV Selects the operation when the EEPROM write command is output without EEPROM write available. Normally there is no need to change this setting.	0 (0, 1)

0 : Cannot write into EEPROM

1 : Write in RAM only

■ H5-18: MtrSpd Monitor T

No. (Hex.)	Name	Description	Default (Range)
H5-18 (11A2)	MtrSpd Monitor T	V/f CL-V/f OLV CLV AOLV OLV/PM AOLV/PM CLV/PM EZOLV Sets the filter time constant used when monitoring the motor speed during MEMOBUS/Modbus communications or use of the communication option.	0 ms (0 - 100 ms)

Sets the filter time constant used when monitoring the output frequency or motor speed during MEMOBUS/Modbus communications or use of the communication option.

The following are the corresponding MEMOBUS registers.

- 003EH (Output Frequency)
- 003FH (Output Frequency)
- 0044H (*U1-05*: Motor Speed)
- 00ACH (*U1-05*: Motor Speed)
- 00ADH (*U1-05*: Motor Speed)

■ H5-20: Comm. Parameters Activation Sel

No. (Hex.)	Name	Description	Default (Range)
H5-20 (0B57)	Comm. Parameters Activation Sel	V/f CL-V/f OLV CLV AOLV OLV/PM AOLV/PM CLV/PM EZOLV Updated MEMOBUS/Modbus communications parameters can take effect immediately after the update.	0 (0, 1)

0 : Enabled when the drive is restarted.

1 : Enabled as soon as the setting value is changed.

Note:

- The setting automatically returns to $H5-20 = 0$ after MEMOBUS/Modbus communications parameter changes are enabled.
- The setting values of the following parameters are enabled.
 - H5-01 [Drive Node Address]
 - H5-02 [Communication Speed Selection]
 - H5-03 [Communication Parity Selection]
 - H5-06 [Drive Transmit Wait Time]

◆ **H6: Pulse Train Input/Output**

H6 parameters set the drive pulse train input and pulse train monitor. These parameters select input and monitor parameters and adjust the pulse train frequency.

A pulse train signal with a maximum single pulse of 32 kHz can be input to the drive input terminal RP. The pulse train signal can be used as the frequency reference, PID feedback value, PID setpoint value, and speed feedback for V/f Control mode.

A pulse train signal with a maximum frequency of 32 kHz can be output from the drive output terminal MP as the monitor value. Both sinking mode and sourcing mode are supported.

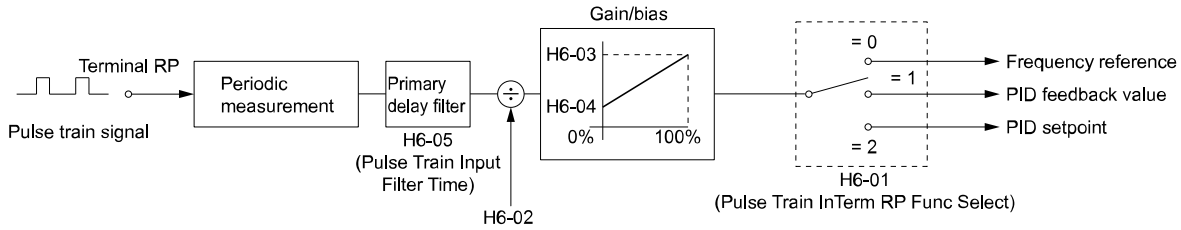

Figure 11.111 Pulse Train Input Block Diagram

■ **H6-01: PulseTrain InTerm RP Func Select**

No. (Hex.)	Name	Description	Default (Range)
H6-01 (042C)	PulseTrain InTerm RP Func Select	V/f CL-V/f OLV CLV AOLV OLV/IPM AOLV/IPM CLV/IPM EZOLV Selects a function of the pulse train input terminal RP.	0 (0 - 3)

0 : Frequency reference

The drive inputs the frequency reference received from terminal RP when $b1-01$ [Frequency Reference Selection 1] or $b1-15$ [Frequency Reference Selection 2] is set to 4 [Pulse Train Input].

1 : PID feedback value

The drive inputs the PID control feedback value received from terminal RP.

2 : PID setpoint value

The drive inputs the PID control target value received from terminal RP.

3 : PG Feedback

Simple encoder feedback is enabled when V/f Control Mode is selected.

Speed control accuracy is improved by using motor speed feedback. The drive compares the frequency reference with the motor speed feedback received from the encoder, and compensates for motor slip using the ASR function. Note that the direction of motor rotation cannot be detected via input terminal RP used for the simple encoder. Configure direction of motor rotation detection via another method.

The following diagram illustrates the method to detect the direction of motor rotation.

- Use MFDI
 - Set the MFDI $H1-xx = 7E$ [FWD/REV Detect (V/f w/ simplePG)]. The drive recognizes that when the configured terminal is on, the motor operates in reverse, and that when the terminal is off, the motor operates in Forward run.
 - An encoder that outputs 2-tracks (phase A, B) is used to detect the direction of motor rotation.
- Use the frequency reference
 - When the MFDI is not used, the Forward/Reverse run command is recognized as the direction of motor rotation.

The following block diagram illustrates speed control under the Simple Closed Loop V/f Mode.

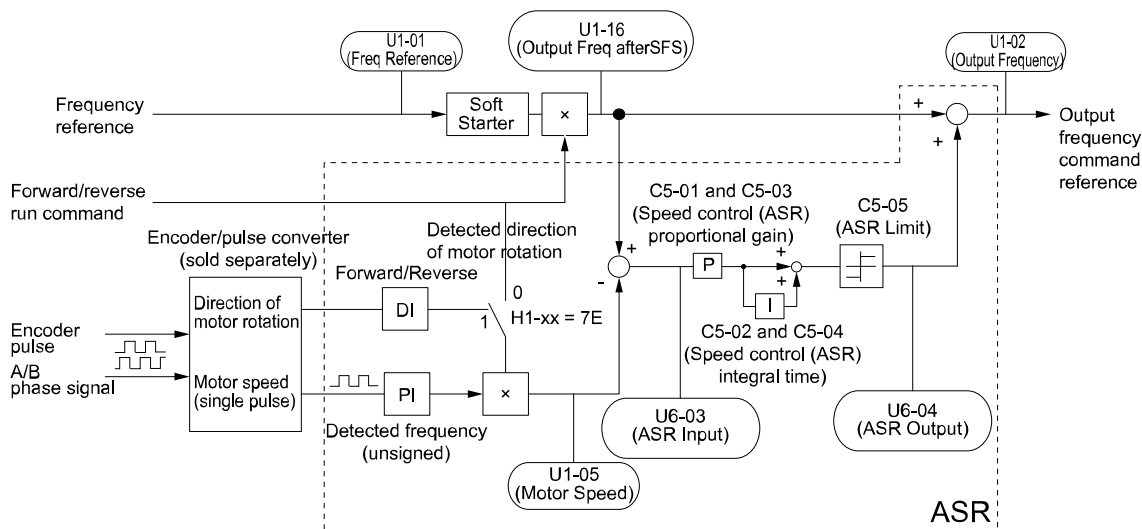

Figure 11.112 Simple Closed Loop Speed Control Block Diagram

Enable Simple Closed Loop V/f Mode

1. Connect the encoder output pulse wiring to terminal RP.
2. Set $A1-02 = 0$ [Control Method Selection = V/f Control].
3. Set $H6-01 = 3$.
4. Set $H6-02$ [Pulse Train Input Scaling] to the speed feedback (pulse train input signal) frequency at the time when the frequency reference is 100%. Confirm that $H6-04$ [Pulse Train Input Bias] is 0% and $H6-03$ [Pulse Train Input Gain] is 100%.
5. Select the detection method for the direction of motor rotation. Set $H1-xx$ to $7E$ when using an MFDI.
6. Set $C5$ parameters related to ASR gain and integral time to adjust responsiveness.

Note:

- $C5$ parameters appear when $A1-02 = 0$ and $H6-01 = 3$.
- The simple Closed Loop V/f Control mode cannot be used in conjunction with the Motor Switch function.

H6-02: Pulse Train Input Scaling

No. (Hex.)	Name	Description	Default (Range)
H6-02 (042D) RUN	Pulse Train Input Scaling	<div style="display: flex; gap: 5px;"> V/f CL-V/f OLV CLV AOLV OLV/PM AOLV/PM CLV/PM EZOLV </div> Sets the frequency of the pulse train input signal used when the item selected with $H6-01$ [PulseTrain InTerm RP Func Select] is input at 100%.	1440 Hz (100 - 32000 Hz)

H6-03: Pulse Train Input Gain

No. (Hex.)	Name	Description	Default (Range)
H6-03 (042E) RUN	Pulse Train Input Gain	<div style="display: flex; gap: 5px;"> V/f CL-V/f OLV CLV AOLV OLV/PM AOLV/PM CLV/PM EZOLV </div> Sets the gain used when the item configured with $H6-01$ [PulseTrain InTerm RP Func Select] is input to terminal RP.	100.0% (0.0 - 1000.0%)

H6-04: Pulse Train Input Bias

No. (Hex.)	Name	Description	Default (Range)
H6-04 (042F) RUN	Pulse Train Input Bias	<div style="display: flex; gap: 5px;"> V/f CL-V/f OLV CLV AOLV OLV/PM AOLV/PM CLV/PM EZOLV </div> Sets the bias used when the item configured with $H6-01$ [PulseTrain InTerm RP Func Select] is input to terminal RP. Sets a value at the time when the pulse train is 0 Hz.	0.0% (-100.0 - 100.0%)

■ H6-05: Pulse Train Input Filter Time

No. (Hex.)	Name	Description	Default (Range)
H6-05 (0430) RUN	Pulse Train Input Filter Time	V/f CL-V/f OLV CLV AOLV OLV/PM AOLV/PM CLV/PM EZOLV Sets the primary delay filter time constant for the pulse train input.	0.10 s (0.00 – 2.00 s)

■ H6-06: Pulse Train Monitor Selection

No. (Hex.)	Name	Description	Default (Range)
H6-06 (0431) RUN	Pulse Train Monitor Selection	V/f CL-V/f OLV CLV AOLV OLV/PM AOLV/PM CLV/PM EZOLV Selects a function for the pulse train monitor output terminal MP. Inputs the “x-xx” portion of the <i>Ux-xx</i> parameter to be monitored.	102 (000, 031, 101, 102, 105, 116, 501, 502, and 801 through 809)

Note:

Set this parameter to 000 or 031 when the terminal MP is not used or used in through mode.

When using the pulse train monitor, connect peripheral devices in accordance with the following load conditions. Incorrect connections may cause characteristic insufficiency or mechanical damage.

- Use the pulse train monitor as sourcing output

Output Voltage VRL(V)	Load impedance (kΩ)
5 V or higher	1.5 kΩ or greater
8 V or higher	4.0 kΩ or greater
10 V or higher	10 kΩ or greater

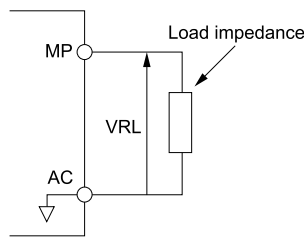

Figure 11.113 Circuit Diagram When Used as the Sourcing Output

- Using the pulse train monitor as the sinking input

External power supply (V)	12 VDC ± 10%, 15 VDC ± 10%
Sinking current (mA)	16 mA or less

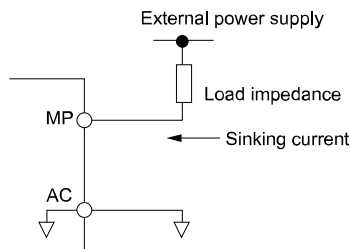

Figure 11.114 Circuit Diagram When Used as the Sinking Input

■ H6-07: Pulse Train Monitor Scaling

No. (Hex.)	Name	Description	Default (Range)
H6-07 (0432) RUN	Pulse Train Monitor Scaling	V/f CL-V/f OLV CLV AOLV OLV/PM AOLV/PM CLV/PM EZOLV Sets the frequency of the pulse train output signal used when the item selected with H6-06 [Pulse Train Monitor Selection] is output at 100%.	1440 Hz (0 - 32000 Hz)

The pulse train output terminal MP outputs the same frequency as the drive output frequency when $H6-06 = 102$ [*Pulse Train Monitor Selection = Output Frequency*] and $H6-07 = 0$.

■ H6-08: Pulse Train Input Min Frequency

No. (Hex.)	Name	Description	Default (Range)
H6-08 (043F)	Pulse Train Input Min Frequency	V/f CL-V/f OLV CLV AOLV OLV/PM AOLV/PM CLV/PM EZOLV Sets the minimum frequency of the pulse train signal detectable by terminal RP in units of 0.1 Hz.	0.5 Hz (0.1 - 1000.0 Hz)

- If a pulse train frequency that is less than the setting value of $H6-08$ is input, the pulse train input appears as 0.0 Hz.
- This parameter is enabled when $H6-01$ [*PulseTrain InTerm RP Func Select*] is set to 0 [*Frequency reference*], 1 [*PID feedback value*], or 2 [*PID setpoint value*].
- The setting of $F1-14$ [*PG Open-Circuit Detection Time*] is applied to the minimum frequency when $H6-01 = 3$ [*PG Feedback*] is set.

◆ H7: Virtual Multi-Function I/O

The virtual I/O function performs the following.

- Inputs the result of the output from the MFDO terminal to the MFDI terminal without external wiring.
- Inputs the result of the output from the MFAO terminal to the MFAI terminal without external wiring.

WARNING! Safety measures when restarting the machine. Make sure to confirm the setting values for virtual input and output function parameters before performing drive test runs. Using the drive before confirming these settings and operation may result in injury due to unexpected operation of the drive. Virtual input and output functions may have different default settings and operation even though the input and output terminals are not wired as the drive input and output terminals are virtually wired internally.

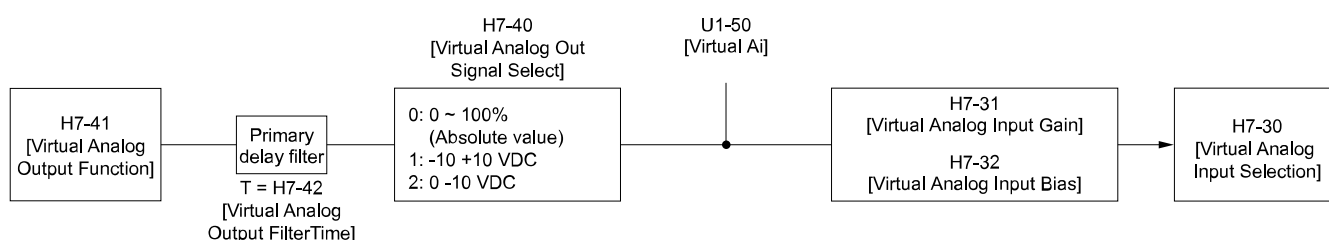

Figure 11.115 Virtual Analog I/O Functional Block Diagram

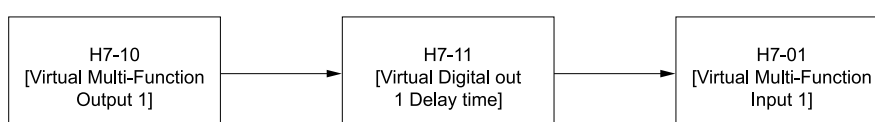

Figure 11.116 Virtual Digital I/O Functional Block Diagram

Note:

- Refer to H1-xx "MFDI Setting Values" for more information on the virtual digital input setting values.
- Refer to H2-xx "MFDO Setting Values" for more information on the virtual digital output setting values.
- Refer to H3-xx "MFAI Setting Values" for more information on the virtual analog input setting values.
- Refer to H4-xx "MFAO Setting Values" for more information on the virtual analog output setting values.
- 0 [*3-Wire Sequence*] and 20 to 2F [*External fault*] cannot be selected in $H7-01$ to $H7-04$ [*Virtual MF Digital input 1 to 4*].
- If the terminal is not used, set $H7-01$ to $H7-04 = F$. However, the through mode function is not supported.
- The virtual I/O function selection and the multi-function input for DI-A3 cannot be used simultaneously.

■ H7-00: Virtual MFIO Selection

No. (Hex.)	Name	Description	Default (Range)
H7-00 (116F)	Virtual MFIO selection	V/f CL-V/f OLV CLV AOLV OLV/PM AOLV/PM CLV/PM EZOLV Enables or disables the virtual I/O function. If enable is not set, the virtual I/O function will not operate.	0 (0, 1)

0 : Disabled

1 : Enabled

■ H7-01: Virtual Multi-Function Input 1

No. (Hex.)	Name	Description	Default Setting (Range)
H7-01 (1185)	Virtual Multi-Function Input 1	<div style="display: flex; justify-content: space-between; gap: 5px;"> V/f CL-V/f OLV CLV AOLV OLV/PM AOLV/PM CLV/PM EZOLV </div> Selects the function that enters the virtual input selected with the <i>H7-10</i> [Virtual Multi-Function Output 1].	F (0 - 19F)

■ H7-02: Virtual Multi-Function Input 2

No. (Hex.)	Name	Description	Default Setting (Range)
H7-02 (1186)	Virtual Multi-Function Input 2	<div style="display: flex; justify-content: space-between; gap: 5px;"> V/f CL-V/f OLV CLV AOLV OLV/PM AOLV/PM CLV/PM EZOLV </div> Selects the function that enters the virtual input selected with the <i>H7-12</i> [Virtual Multi-Function Output 2].	F (0 - 19F)

■ H7-03: Virtual Multi-Function Input 3

No. (Hex.)	Name	Description	Default Setting (Range)
H7-03 (1187)	Virtual Multi-Function Input 3	<div style="display: flex; justify-content: space-between; gap: 5px;"> V/f CL-V/f OLV CLV AOLV OLV/PM AOLV/PM CLV/PM EZOLV </div> Selects the function that enters the virtual input selected with <i>H7-14</i> [Virtual Multi-Function Output 3].	F (0 - 19F)

■ H7-04: Virtual Multi-Function Input 4

No. (Hex.)	Name	Description	Default Setting (Range)
H7-04 (1188)	Virtual Multi-Function Input 4	<div style="display: flex; justify-content: space-between; gap: 5px;"> V/f CL-V/f OLV CLV AOLV OLV/PM AOLV/PM CLV/PM EZOLV </div> Selects the function that enters the virtual input selected with the <i>H7-16</i> [Virtual Multi-Function Output 4].	F (0 - 19F)

■ H7-10: Virtual Multi-Function Output 1

No. (Hex.)	Name	Description	Default Setting (Range)
H7-10 (11A4)	Virtual Multi-Function Output 1	<div style="display: flex; justify-content: space-between; gap: 5px;"> V/f CL-V/f OLV CLV AOLV OLV/PM AOLV/PM CLV/PM EZOLV </div> Selects the function for virtual digital output 1.	F (0 - 1A7)

■ H7-11: Virtual Output 1 Delay Time

No. (Hex.)	Name	Description	Default Setting (Range)
H7-11 (11A5)	Virtual Output 1 Delay Time	<div style="display: flex; justify-content: space-between; gap: 5px;"> V/f CL-V/f OLV CLV AOLV OLV/PM AOLV/PM CLV/PM EZOLV </div> Sets the minimum ON time for virtual digital output 1.	0.1 s (0.0 - 25.0 s)

■ H7-12: Virtual Multi-Function Output 2

No. (Hex.)	Name	Description	Default Setting (Range)
H7-12 (11A6)	Virtual Multi-Function Output 2	<div style="display: flex; justify-content: space-between; gap: 5px;"> V/f CL-V/f OLV CLV AOLV OLV/PM AOLV/PM CLV/PM EZOLV </div> Selects the function for virtual digital output 2.	F (0 - 1A7)

■ H7-13: Virtual Output 2 Delay Time

No. (Hex.)	Name	Description	Default Setting (Range)
H7-13 (11A7)	Virtual Output 2 Delay Time	V/f CL-V/f OLV CLV AOLV OLV/PM AOLV/PM CLV/PM EZOLV Sets the minimum ON time for virtual digital output 2.	0.1 s (0.0 - 25.0 s)

■ H7-14: Virtual Multi-Function Output 3

No. (Hex.)	Name	Description	Default Setting (Range)
H7-14 (11A8)	Virtual Multi-Function Output 3	V/f CL-V/f OLV CLV AOLV OLV/PM AOLV/PM CLV/PM EZOLV Selects the function for virtual digital output 3.	F (0 - 1A7)

■ H7-15: Virtual Output 3 Delay Time

No. (Hex.)	Name	Description	Default Setting (Range)
H7-15 (11A9)	Virtual Output 3 Delay Time	V/f CL-V/f OLV CLV AOLV OLV/PM AOLV/PM CLV/PM EZOLV Sets the minimum ON time for virtual digital output 3.	0.1 s (0.0 - 25.0 s)

■ H7-16: Virtual Multi-Function Output 4

No. (Hex.)	Name	Description	Default Setting (Range)
H7-16 (11AA)	Virtual Multi-Function Output 4	V/f CL-V/f OLV CLV AOLV OLV/PM AOLV/PM CLV/PM EZOLV Selects the function for virtual digital output 4.	F (0 - 1A7)

■ H7-17: Virtual Output 4 Delay Time

No. (Hex.)	Name	Description	Default Setting (Range)
H7-17 (11AB)	Virtual Output 4 Delay Time	V/f CL-V/f OLV CLV AOLV OLV/PM AOLV/PM CLV/PM EZOLV Sets the minimum ON time for virtual digital output 4.	0.1 s (0.0 - 25.0 s)

■ H7-30: Virtual Analog Input Selection

No. (Hex.)	Name	Description	Default Setting (Range)
H7-30 (1177)	Virtual Analog Input Selection	V/f CL-V/f OLV CLV AOLV OLV/PM AOLV/PM CLV/PM EZOLV Sets the virtual analog input function.	F (0 - 41)

■ H7-31: Virtual Analog Input Gain

No. (Hex.)	Name	Description	Default Setting (Range)
H7-31 (1178) RUN	Virtual Analog Input Gain	V/f CL-V/f OLV CLV AOLV OLV/PM AOLV/PM CLV/PM EZOLV Sets the virtual analog input gain.	100.0% (-999.9 - 999.9%)

■ H7-32: Virtual Analog Input Bias

No. (Hex.)	Name	Description	Default Setting (Range)
H7-32 (1179) RUN	Virtual Analog Input Bias	V/f CL-V/f OLV CLV AOLV OLV/PM AOLV/PM CLV/PM EZOLV Sets the virtual analog input bias.	0.0% (-999.9 - 999.9%)

■ H7-40: Virtual Analog Out Signal Select

No. (Hex.)	Name	Description	Default Setting (Range)
H7-40 (1163)	Virtual Analog Out Signal Select	V/f CL-V/f OLV CLV AOLV OLV/PM AOLV/PM CLV/PM EZOLV Selects the signal level of the virtual analog output.	0 (0 - 2)

0 : 0 ~ 100%(Absolute value)

1 : -10 +10 VDC

2 : 0-10 VDC

■ H7-41: Virtual Analog Output Function

No. (Hex.)	Name	Description	Default Setting (Range)
H7-41 (1164)	Virtual Analog Output Function	V/f CL-V/f OLV CLV AOLV OLV/PM AOLV/PM CLV/PM EZOLV Sets the monitoring number to be output from the virtual analog output. Set the x-xx portion of the monitoring parameter $Ux-xx$. For example, set x-xx to 102 to monitor $U1-02$ [Output Frequency].	102 (0 - 999)

■ H7-42: Virtual Analog Output FilterTime

No. (Hex.)	Name	Description	Default Setting (Range)
H7-42 (1165)	Virtual Analog Output FilterTime	V/f CL-V/f OLV CLV AOLV OLV/PM AOLV/PM CLV/PM EZOLV Sets the time constant for a primary filter of the virtual analog output.	0.00 s (0.00 to 2.00 s)

11.9 L: Protection Function

L parameters set the following functions.

- Motor Overload Protection
- Operation During Momentary Power Loss
- Stall Prevention
- Speed Detection
- Auto Restart
- Detection of Overtorque/Undertorque
- Torque Limit
- Hardware Protection

◆ L1: Motor Protection

L1 parameters set the motor overload protection function.

■ Motor Protection Using Positive Temperature Coefficient (PTC) Thermistors

The motor is protected from overheating through the use of temperature resistance characteristics of three PTCs thermistors that are built into the motor stator winding.

The PTC thermistors must exhibit the characteristics in motor 1 phase as illustrated in the following graph.

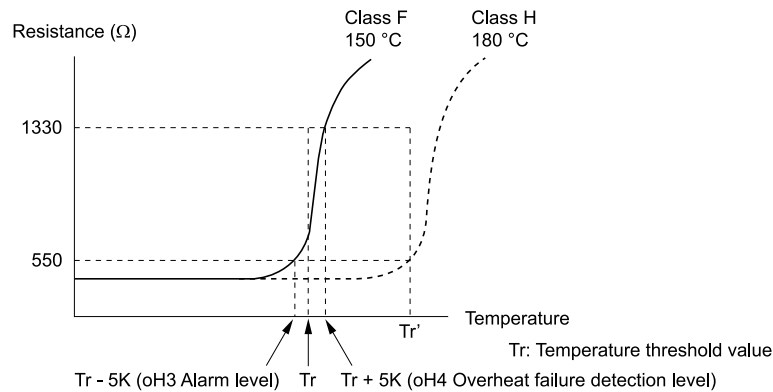

Figure 11.117 PTC Thermistor Temperature and Resistance

When the PTC input signal input to the drive exceeds the overload alarm level, *oH3* [*Motor Overheat Alarm (PTC Input)*] flashes on the keypad. The drive continues the operation selected in *L1-03* [*Motor OH Alarm Operation Select*].

The overheat fault level triggers *anoH4* [*Motor Overheat Fault (PTC Input)*] fault, and outputs a fault signal. The drive outputs a fault signal, and stops the motor using the stop method selected in *L1-04* [*Motor OH Fault Operation Select*].

Note:

PTC is an acronym for Positive Temperature Coefficient.

The following figure illustrates the configuration procedure when terminal A3 is used.

1. Connect the PTC thermistor input from the motor to analog input terminal A3 on the drive.

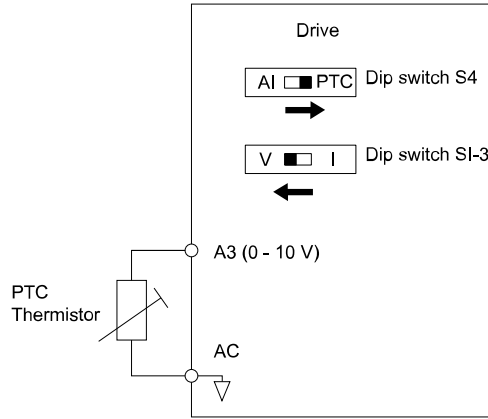

Figure 11.118 Connection of a Motor PTC

2. Set the drive DIP switch S1-3 to V (voltage) and set DIP switch S4 to PTC.
3. Set the following MFAI terminals.
 - Set H3-05 = 0 [Terminal A3 Signal Level Select = 0-10V (LowLim=0)].
 - Set H3-06 = E [Terminal A3 Function Selection = Motor Temperature (PTC input)].
4. Set the following L1 parameters.
 - L1-03 [Motor OH Alarm Operation Select]
 - L1-04 [Motor OH Fault Operation Select]
 - L1-05 [Motor Temp Input Filter Time]

■ L1-01: Motor Overload Protection Select

No. (Hex.)	Name	Description	Default Setting (Range)
L1-01 (0480)	Motor Overload (oL1) Protection	<div style="display: flex; justify-content: space-between; font-size: small;"> V/f CL-V/f OLV CLV AOLV OLV/PM AOLV/PM CLV/PM EZOLV </div> Enables or disables the motor overload protection using electronic thermal protectors.	Determined by A1-02 (0 - 6)

Enables or disables the motor overload protection using electronic thermal protectors.

Cooling capability varies depending on the speed control range of the motor. Select motor protection using an electronic thermal protector that matches the allowable load characteristics of the motor being used.

The drive has overload protection for the motor using an electronic thermal protector. The electronic thermal protector of the drive calculates motor overload tolerance based on output current, output frequency, motor thermal characteristics, and time characteristics to provide overload protection for the motor. The drive triggers an oL1 [Motor Overload] and shuts off the drive output when the drive detects motor overload.

It is also possible to set a motor overload alarm. Set H2-01 = 1F [Terminal M1-M2 Function Selection = Motor overload alarm (oL1)] to set a motor overload alarm. When the motor overload level rises above 90% of the oL1 detection level, the output terminal switches ON and triggers an overload alarm.

Note:

Set L1-01 = 1 to 6 [Enabled] to enable motor protection when operating a single motor. External thermal relays are not necessary in such cases.

0 : Disabled

Disable motor protection when motor overload protection is not required or when the drive is operating more than one motor.

The following diagram shows an example of the circuit configuration when connecting multiple motors to a single drive.

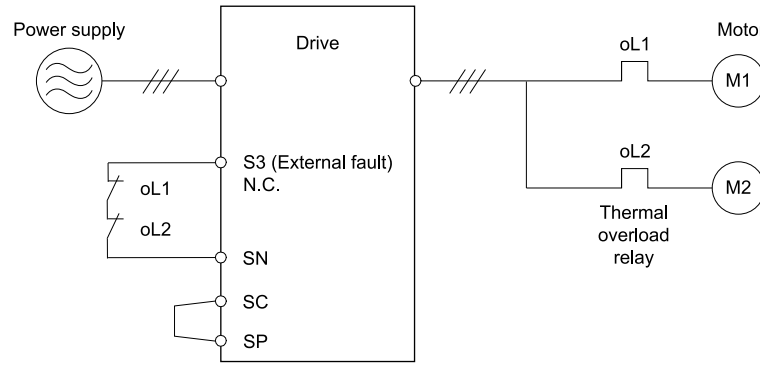

Figure 11.119 Protection Circuit Configuration when Connecting Multiple Motors to Single Drive

NOTICE: The motor cannot be protected by electronic thermal protection when one drive is running two or more motors simultaneously or the motor has a rated current significantly larger than that of standard motors (underwater motors, for example). Add thermal relays to each motor after setting L1-01 = 0 [Motor Overload Protection Select = Disabled] and configure circuits to protect each motor. The motor may fail if handled improperly.

1 : Variable Torque

Use this setting for general-purpose motors with a base frequency of 60 Hz.

The motor has less cooling capability in the low speed range because the cooling fan slows down and there is lower overload tolerance as the speed drops. The trigger point for the electronic thermal protector changes according to the overload tolerance characteristics of the motor. This provides motor overheat protection from low speed to high speed across the entire speed range.

Load tolerance	Cooling Ability	Overload Characteristics (at 100% motor load)
	<p>Motor designed to operate from line power. The motor has maximum cooling capability when operating at a 60 Hz base frequency.</p>	<p>The drive detects oL1 when operating at frequencies lower than 60 Hz. The drive triggers a fault relay output and the motor coasts to stop.</p>

2 : Constant Torque 10:1 Speed Range

Use this setting for drive dedicated motors with a speed range for constant torque of 1:10.

The speed control for this motor is 10% to 100% when at 100% load. Operating slower than 10% speed at 100% load will trigger motor overload.

Load tolerance	Cooling Ability	Overload Characteristics (at 100% motor load)
	<p>This motor is designed to withstand increasing temperature during continuous operation even in the low speed range (10% base frequency).</p>	<p>The motor operates continuously at 10% to 100% base frequency.</p>

3 : Constant Torque 100:1 SpeedRange

Use this setting for vector motors with a speed range for constant torque of 1:100.

11.9 L: Protection Function

The speed control for this motor is 1 % to 100% when at 100% load. Operating slower than 1% speed at 100% load will trigger motor overload.

Load tolerance	Cooling Ability	Overload Characteristics (at 100% motor load)
	<p>This motor is designed to withstand increasing temperature during continuous operation even in the low speed range (1% base frequency).</p>	<p>The motor operates continuously at 1% to 100% base frequency. Motor overload is triggered when operating slower than 1% speed at 100% load.</p>

4 : PM Variable Torque

Use this setting for PM motors with derated torque characteristics.

The motor has less cooling capability in the low speed range because the cooling fan slows down and there is lower overload tolerance as the speed drops. The trigger point for the electronic thermal protector changes according to the overload tolerance characteristics of the motor. This provides motor overheat protection from low speed to high speed across the entire speed range.

Load tolerance	Cooling Ability	Overload Characteristics (at 100% motor load)
	<p>This motor is designed to withstand increasing temperature during continuous operation at both rated speed and rated torque.</p>	<p>The drive detects <i>oL1</i> when the motor operates continuously at lower speed than rated rotation speed at over 100% torque. The drive triggers a fault relay output and the motor coasts to stop.</p>

5 : PM Constant Torque

Use this setting with a PM motor for constant torque that has a speed range for constant torque of 1:500.

The speed control for this motor is 0.2% to 100% when at 100% load. Operating slower than 0.2% speed at 100% load will trigger motor overload.

Load tolerance	Cooling Ability	Overload Characteristics (at 100% motor load)
	<p>This motor is designed to withstand increasing temperature during continuous operation even in the low speed range (0.2% base frequency).</p>	<p>The motor operates continuously at 0.2% to 100% rated speed. Motor overload is triggered when operating slower than 0.2% speed at 100% load.</p>

6 : Variable Torque (50Hz)

Use this setting for general-purpose motors with a base frequency of 50 Hz.

The motor has less cooling capability in the low speed range because the cooling fan slows down and there is lower overload tolerance as the speed drops. The trigger point for the electronic thermal protector changes according to the overload tolerance characteristics of the motor. This provides motor overheat protection from low speed to high speed across the entire speed range.

Load tolerance	Cooling Ability	Overload Characteristics (at 100% motor load)
	<p>This motor is designed to operate using commercial line power. The motor has maximum cooling capability when operating at a 50 Hz base frequency.</p>	<p>The drive detects <i>oLI</i> when operating at frequencies lower than commercial line power. The drive triggers a fault relay output and the motor coasts to stop.</p>

■ **L1-02: Motor Overload Protection Time**

No. (Hex.)	Name	Description	Default Setting (Range)
L1-02 (0481)	Motor Overload (oLI) Protection	V/f CL-V/f OLV CLV AOLV OLV/PM AOLV/PM CLV/PM EZOLV Sets the operation time for the electronic thermal protector of the drive to protect the motor. Normally there is no need to change this setting.	1.0 min (0.1 - 5.0 min)

Set the overload tolerance time to the length of time that the motor is allowed to operate at 150% load from continuous operation at 100% load.

The default setting triggers the electronic thermal protector after the motor operates at 150% load continuously for 1 minute after continuous operation at 100% load (hot start).

The following diagram is an example of the electronic thermal protector operation time. Motor overload protection operates in the range between a cold start and a hot start.

This example shows a general-purpose motor operating at the base frequency with *L1-02* set to 1.0 min.

- Cold start
Shows the motor protection operation time characteristics when the overload occurs immediately after starting operation from a complete stop.
- Hot start
Shows the motor protection operation time characteristics when overload occurs from continuous operation below the motor rated current.

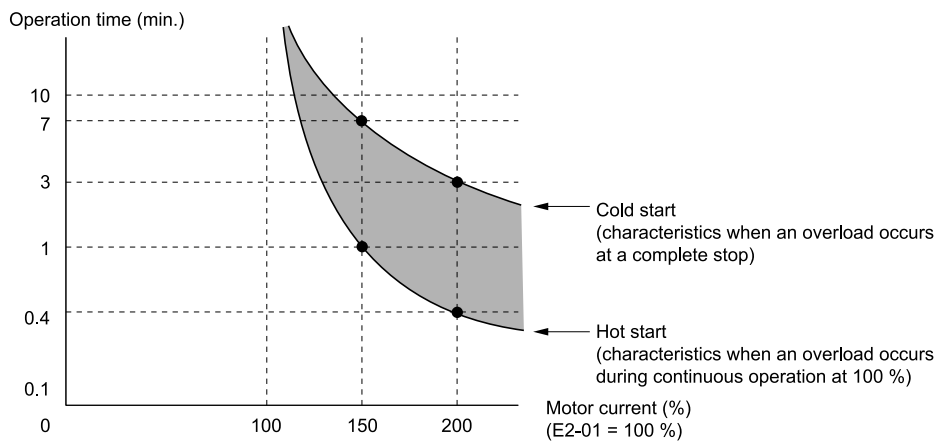

Figure 11.120 Protection Operation Time for a General-purpose Motor at Rated Output Frequency

■ **L1-03: Motor OH Alarm Operation Select**

No. (Hex.)	Name	Description	Default Setting (Range)
L1-03 (0482)	Motor OH Alarm Operation Select	V/f CL-V/f OLV CLV AOLV OLV/PM AOLV/PM CLV/PM EZOLV Selects the drive operation when the PTC input signal input into the drive reaches the detection level of <i>oH3</i> [Motor Overheat Alarm].	3 (0 - 3)

0 : Ramp to stop

The drive ramps the motor to stop according to the deceleration time. Fault relay output terminal MA-MC will turn on, and MB-MC will turn off.

1 : Coast to stop

The drive shuts off output and the motor coasts to stop. Fault relay output terminal MA-MC will turn on, and MB-MC will turn off.

2 : Fast Stop

The drive stops the motor using the deceleration time set in *C1-09 [Fast Stop Time]*. Fault relay output terminal MA-MC will turn on, and MB-MC will turn off.

3 : Alarm only

oH3 appears on the keypad, and operation continues.

■ L1-04: Motor OH Fault Operation Select

No. (Hex.)	Name	Description	Default Setting (Range)
L1-04 (0483)	Motor OH Fault Operation Select	<div style="display: flex; justify-content: space-between; font-size: small;"> V/f CL-V/f OLV CLV AOLV OLV/PM AOLV/PM CLV/PM EZOLV </div> <p>Selects the drive operation when the PTC input signal input into the drive reaches the detection level of <i>oH4 [Motor Overheat Failure]</i>.</p>	1 (0 - 2)

0 : Ramp to stop

The drive ramps the motor to stop according to the deceleration time. Fault relay output terminal MA-MC will turn on, and MB-MC will turn off.

1 : Coast to stop

The drive shuts off output and the motor coasts to stop. Fault relay output terminal MA-MC will turn on, and MB-MC will turn off.

2 : Fast Stop

The drive stops the motor using the deceleration time set in *C1-09 [Fast Stop Time]*. Fault relay output terminal MA-MC will turn on, and MB-MC will turn off.

■ L1-05: Motor Temp Input Filter Time

No. (Hex.)	Name	Description	Default (Range)
L1-05 (0484)	Motor Temp Input Filter Time	<div style="display: flex; justify-content: space-between; font-size: small;"> V/f CL-V/f OLV CLV AOLV OLV/PM AOLV/PM CLV/PM EZOLV </div> <p>Sets the primary delay time constant for the PTC input signal input to the drive. This parameter is used to prevent accidental detections of motor overheat fault.</p>	0.20 s (0.00 - 10.00 s)

■ L1-08: oL1 Current Level

No. (Hex.)	Name	Description	Default (Range)
L1-08 (1103)	oL1 Current Level	<div style="display: flex; justify-content: space-between; font-size: small;"> V/f CL-V/f OLV CLV AOLV OLV/PM AOLV/PM CLV/PM EZOLV </div> <p>Sets the reference current for motor thermal overload detection for motor 1 in amperes.</p>	0.0 A (0.0 A or 10% to 150% of the drive rated current)

When L1-08 = 0.0 A, the motor overload protection is detected on the basis of *E2-01 [Motor Rated Current (FLA)]*. In PM control mode, the overload protection is detected on the basis of *E5-03 [PM Motor Rated Current (FLA)]*.

When *L1-08* ≠ 0.0 A, the set value is used as the reference for motor overload protection.

Note:

- Display is in the following units:
 - 2004 to 2042, 4002 to 4023: 0.01 A units
 - 2056 to 2415, 4031 to 4675: 0.1 A units
- Cannot be set to a value smaller than 10% of drive rated current when the current level is set to a value greater than 0.0 A.

■ L1-09: oL1 Current Level for Motor 2

No. (Hex.)	Name	Description	Default Setting (Range)
L1-09 (1104)	oL1 Current Level for Motor 2	<div style="display: flex; justify-content: space-between; font-size: 0.8em; font-weight: bold;"> V/f CL-V/f OLV CLV AOLV OLV/PM AOLV/PM CLV/PM EZOLV </div> <p>Sets the current value used as the reference for detecting the motor overload state regarding the motor 2 electronic thermal protector.</p>	0.0 A (0.0 A or 10 to 150% of the drive rated current)

When L1-09 = 0.0 A, *E4-01 [Motor 2 Rated Current]* is used as the reference for motor overload protection.

When $L1-09 \neq 0.0 A$, the motor overload protection is detected on the basis of the set value.

Note:

- Display is in the following units:
–2004 to 2042, 4002 to 4023: 0.01 A units
–2056 to 2415, 4031 to 4675: 0.1 A units
- Cannot be set to a value smaller than 10% of drive rated current when the current level is set to a value greater than 0.0 A.

■ L1-13: Cont Electrothermal Ope Select

No. (Hex.)	Name	Description	Default (Range)
L1-13 (046D)	Cont Electrothermal Ope Select	<div style="display: flex; justify-content: space-between; font-size: 0.8em; font-weight: bold;"> V/f CL-V/f OLV CLV AOLV OLV/PM AOLV/PM CLV/PM EZOLV </div> <p>Selects whether to retain the current electronic thermal protector value when the power supply is interrupted.</p>	1 (0, 1)

0 : Disabled

1 : Enabled

Selects if the calculation of the motor overload is restarted when the drive is energized again.

◆ L2: Momentary Power Loss Ride-Thru

L2 parameters set the drive operation during momentary power loss and the KEB Ride-Thru function method of operation.

■ KEB Ride-Thru Function

KEB is an acronym for Kinetic Energy Backup. The drive quickly decelerates the motor when the drive detects a power loss or momentary power loss. The drive uses regenerative energy generated from the motor to keep the main circuit operating. Operation returns to the state before the power loss if power is restored during motor deceleration. The KEB Ride-Thru function differs from other functions for continuous operation. The motor will ramp to stop (not coast to stop) when the drive detects momentary power loss. This function is suitable for applications in which it is desirable to prevent materials from running out, such as control for film and fiber lines. The KEB Ride-Thru function has 4 methods of operation. Select the method in *L2-29 [KEB Method Selection]*.

When using the KEB Ride-Thru function with one drive, set $L2-29 = 0, 1$ [*Single Drive KEB Ride-Thru 1, Single Drive KEB Ride-Thru 2*].

If deceleration in coordination with multiple drives is required, such as with textile machinery line systems, set $L2-29 = 2, 3$ [*System KEB Ride-Thru 1, System KEB Ride-Thru 2*].

Table 11.55 KEB Ride-Thru Function Operation Method

L2-29	KEB Method Selection	Operation	Configuration Precautions
0	Single Drive KEB Ride-Thru 1	The drive uses regenerative energy from the motor to keep the DC bus voltage at the level set to L2-11 [DC Bus Vol Setpoint during KEB] while adjusting the rate of deceleration. The KEB operation continues while the deceleration rate is adjusted in accordance with the setting of C1-09 [Fast Stop Time].	<ul style="list-style-type: none"> Set C1-09 appropriately so that <i>Uv1</i> [DC Bus Undervoltage] or <i>ov</i> [DC Bus Overvoltage] does not occur. Decrease the value set in C1-09 if <i>Uv1</i> is detected during the KEB operation. Increase the value set in C1-09 if <i>ov</i> is detected during the KEB operation.
1	Single Drive KEB Ride-Thru 2	The drive uses information about the inertia of the connected machinery to determine the deceleration rate necessary to keep the DC bus voltage at the level set in parameter L2-11. The resulting deceleration time is calculated based on the system inertia and cannot be adjusted.	<ul style="list-style-type: none"> Increase the setting value of L3-20 [DC Bus Voltage Adjustment Gain] and L3-21 [Accel/Decel Rate Calculate Gain] if <i>Uv1</i> is detected during the KEB operation. Decrease the setting value of L3-20 and L3-21 if <i>ov</i> is detected during the KEB operation.
2	System KEB Ride-Thru 1	The drive does not monitor the DC bus voltage. The drive decelerates at the KEB deceleration time set to L2-06. Set the time required to decelerate from the current frequency reference to 0 Hz in L2-06. Multiple drives can decelerate while keeping the speed ratio constant between those drives..	Use the dynamic braking option with System KEB Ride-Thru 1.
3	System KEB Ride-Thru 2	The drive decelerates based on the KEB deceleration time set to L2-06 while monitoring the DC bus voltage. If the voltage level rises, the drive briefly holds the frequency to prevent an <i>ov</i> before continuing to decelerate.	Use System KEB Ride-Thru 2 when the dynamic braking option cannot be used.

■ KEB Ride Thru Start

When L2-01 = 3, 4, 5 [Momentary Power Loss Ope Select = KEB Mode, KEB Stop Mode, KEB Decel to Stp], the drive starts the KEB operation immediately after a momentary power loss is detected. KEB Ride-Thru will be activated if one of the following conditions becomes true:

- KEB Ride-Thru 1 set for the MFDI terminal becomes enabled (terminal is off when *HI-xx* = 65 or terminal is on when *HI-xx* = 66).
The drive starts KEB operation using the mode selected L2-29 [KEB Method Selection].
- KEB Ride-Thru 2 set for the MFDI terminal becomes enabled (terminal is off when *HI-xx* = 7A or terminal is ON when *HI-xx* = 7B).
The drive automatically starts Single KEB Ride-Thru 2, disregarding the setting of L2-29.
- The DC bus voltage fell below the level specified in L2-05 [Undervoltage Detect Level (*Uv1*)].
The KEB operation will start as specified in L2-29.

Note:

Attempting to simultaneously assign KEB Ride-Thru 1 and 2 to the MFDI terminals will trigger an *oPE03* [Multi-Function Input Setting Err].

In the following example, the drive detects that the DC bus voltage has dropped below the level set in L2-05 and starts the KEB operation. If the power is restored while the KEB is operating, the drive continues KEB operation as long as the KEB Ride-Thru is input even after the time set in L2-10 [KEB Detect Time (Min KEB Time)] has elapsed. The motor reaccelerates once the KEB Ride-Thru is canceled.

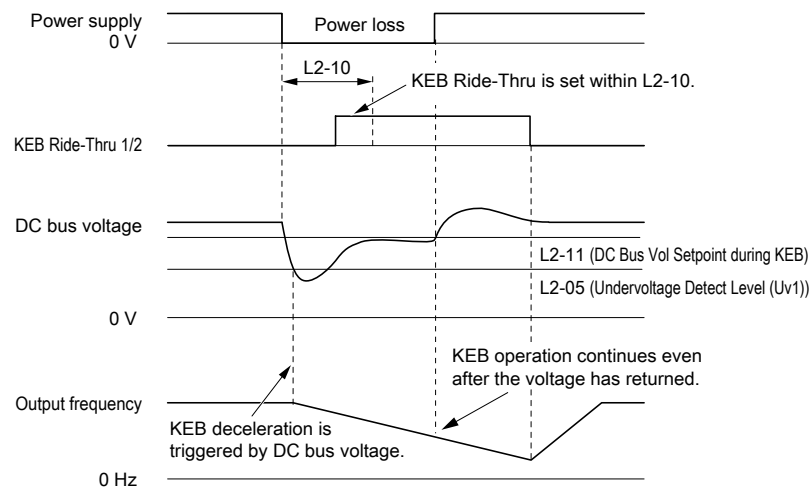

Figure 11.121 KEB Operation via KEB Ride-Thru Input

■ KEB Ride Thru End Detection

The KEB function end detection depends on the setting of parameter $L2-01$ and whether a digital input programmed for KEB is used.

Cancel KEB Operation by Using the Momentary Power Loss Ride-Thru Time

The following example illustrates an example when the configuration is as follows.

- $L2-01 = 3$ [*Momentary Power Loss Ope Select = KEB Mode*] is set.
- KEB Ride-Thru is not used.

The drive starts deceleration via KEB operation. The drive stops the KEB operation once the time set in $L2-10$ [*KEB Detect Time (Min KEB Time)*] elapses and then reaccelerates the motor until the frequency reference value used before the power loss is reached.

When the DC bus voltage still is not restored within the time set in $L2-02$ [*Momentary Power Loss Ride-Thru Time*], $Uv1$ [*DC Bus Undervoltage*] is detected, and the drive shuts off its output.

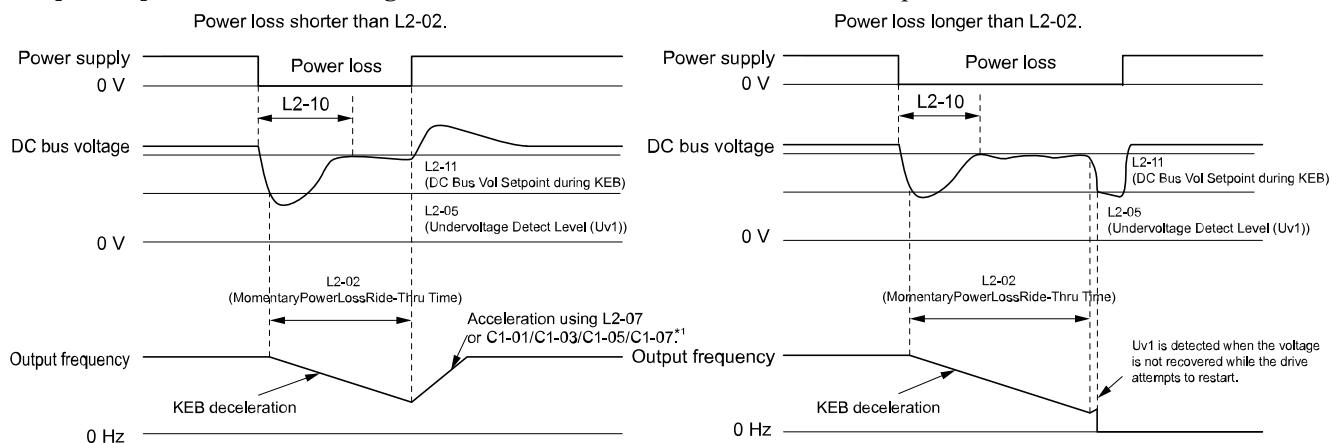

Figure 11.122 Cancel the KEB Operation after the Momentary Power Loss Ride-Thru Time Elapses without Using the KEB Ride-Thru

*1 When setting $L2-07 = 0.00$ [*KEB Acceleration Time = 0.00 s*], the drive reaccelerates in accordance with the valid *Acceleration Time* [$C1-01$, $C1-03$, $C1-05$, $C1-07$], and normal operation resumes.

Cancel KEB Operation by Using the Momentary Power Loss Ride-Thru Time and KEB Ride-Thru

The following example illustrates an example when the configuration is as follows.

- $L2-01 = 3$ is set.
- Use *KEB Ride-Thru 1* [$H1-xx = 65, 66$] or *KEB Ride-Thru 2* [$H1-xx = 7A, 7B$].

The drive starts deceleration via KEB operation. After decelerating for the time set in parameter $L2-10$, the drive checks the DC bus voltage and the status of the digital input terminal set for KEB Ride-Thru. If the DC bus voltage is still below the level set in $L2-11$ [*DC Bus Vol Setpoint during KEB*] or if the KEB digital input is still active, KEB deceleration continues. If the voltage level has risen above the value set to $L2-11$, then normal operation is resumed. The motor is accelerated to the frequency reference value used before the power loss, and

normal operation resumes. A $Uv1$ is detected once the time set in $L2-02$ elapses. If the KEB Ride-Thru is canceled, the motor accelerates again, and normal operation resumes.

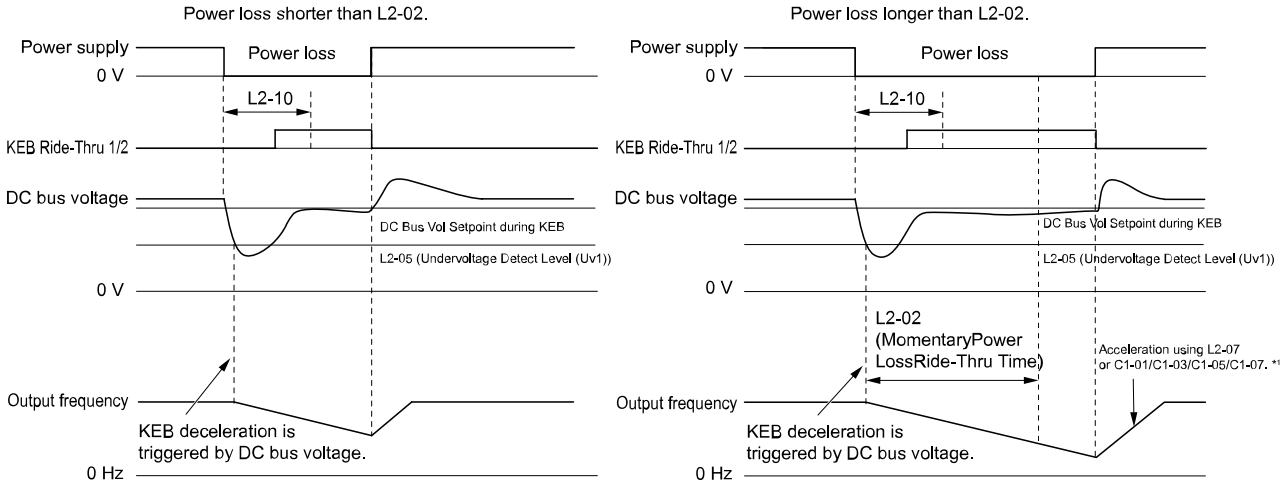

Figure 11.123 Cancel KEB Operation by Using the Momentary Power Loss Ride-Thru Time and KEB Ride-Thru

*1 When setting $L2-07 = 0.00$, the drive reaccelerates in accordance with the valid *Acceleration Time* [$C1-01$, $C1-03$, $C1-05$, $C1-07$], and normal operation resumes.

Cancel KEB Operation if Restoration of Power Occurs while the Control Power (Power Supply to the Control Board) is Maintained

The following example illustrates an example when the configuration is as follows.

- $L2-01 = 4$ [*KEB Stop Mode*] is set.
- KEB Ride-Thru is not used.

The drive starts deceleration via KEB operation. After decelerating for the time set to parameter $L2-10$, the drive checks the DC bus voltage level. Deceleration continues if the DC bus voltage is lower than the level set in $L2-11$ using the KEB Ride-Thru function. Normal operation resumes when the DC bus voltage rises above the value of $L2-11$. The motor is accelerated to the frequency reference value used before the power loss, and normal operation resumes.

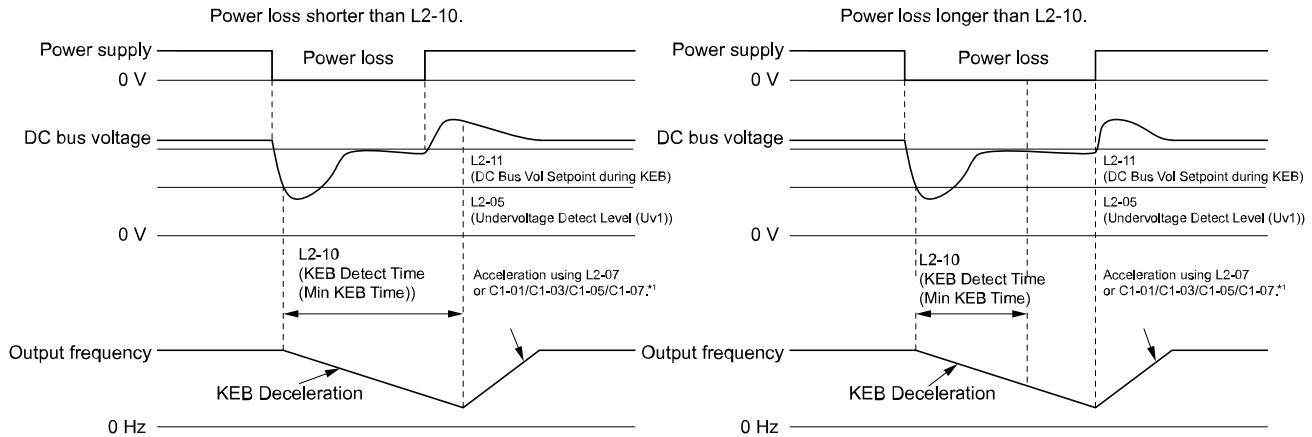

Figure 11.124 Cancel KEB Operation without Using the KEB Ride-Thru if Restoration of Power Occurs while the Control Power (Power Supply to the Control Board) is Maintained

*1 When setting $L2-07 = 0.00$, the drive reaccelerates in accordance with the valid *Acceleration Time* [$C1-01$, $C1-03$, $C1-05$, $C1-07$], and normal operation resumes.

Cancel KEB Operation Using the KEB Ride-Thru if Restoration of Power Occurs while the Control Power (Power Supply to the Control Board) is Maintained

The following example illustrates an example when the configuration is as follows.

- $L2-01 = 4$ is set.
- Use *KEB Ride-Thru 1* [$H1-xx = 65, 66$] or *KEB Ride-Thru 2* [$H1-xx = 7A, 7B$].

The drive starts deceleration via KEB operation. When the motor decelerates for the time set in $L2-10$, the drive checks the DC bus voltage and the status of the digital input set for KEB Ride-Thru. Deceleration continues if the DC bus voltage is still below the level set in $L2-11$, or if the digital input assigned to KEB Ride-Thru is still active. If the voltage level has risen above the value set to $L2-11$, then normal operation is resumed. The motor is

accelerated to the frequency reference value used before the power loss, and normal operation resumes. Deceleration continues using the KEB Ride-Thru function as long as the KEB Ride-Thru continues to be input after the time set in L2-02 elapses. If the KEB Ride-Thru is canceled, the motor accelerates again, and normal operation resumes.

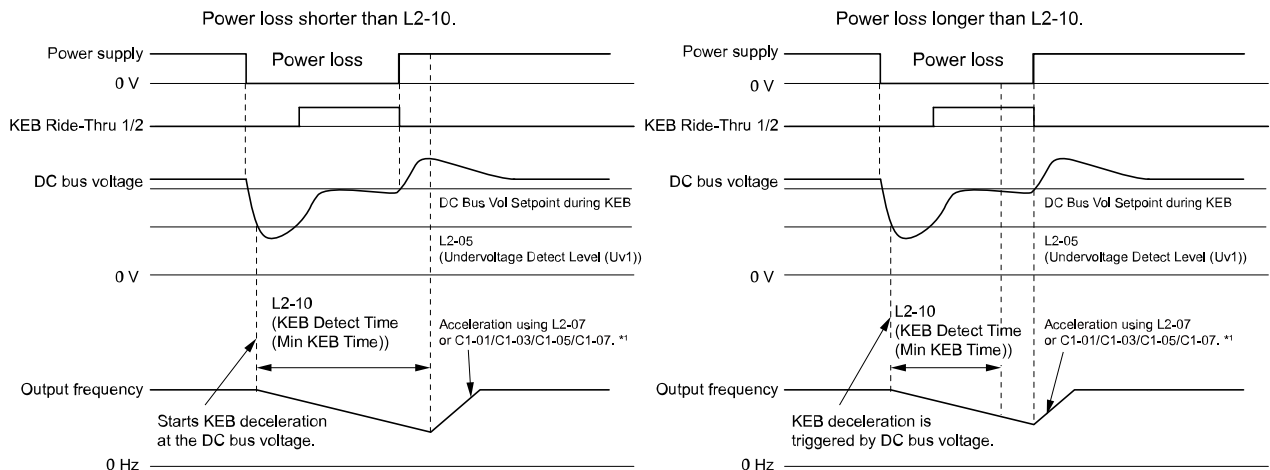

Figure 11.125 Cancel KEB Operation Using the KEB Ride-Thru if Restoration of Power Occurs while the Control Power (Power Supply to the Control Board) is Maintained

*1 When setting L2-07 = 0.00, the drive reaccelerates in accordance with the valid Acceleration Time [C1-01, C1-03, C1-05, C1-07], and normal operation resumes.

KEB Operation when L2-01 = 5 [KEB Decel to Stp]

The drive starts deceleration via KEB operation. The drive will continue to decelerate until the motor comes to the minimum output frequency or a complete stop. Deceleration continues even if power is restored during deceleration. The motor cannot restart if the run command is not input.

KEB Operation Wiring Example

The following figure illustrates an example to trigger the KEB Ride-Thru at power loss using an undervoltage relay. When a power loss occurs, the undervoltage relay triggers KEB Ride-Thru [H1-06 = 65, 66, 7A, 7B] at terminal S6.

Note:

- Note that using System KEB Ride-Thru requires an additional dynamic braking option. If the Run command is shut off, the drive will not accelerate back to speed when the power is restored.
- A dynamic braking option is required to use System KEB Ride-Thru 1 [L2-29 = 2].

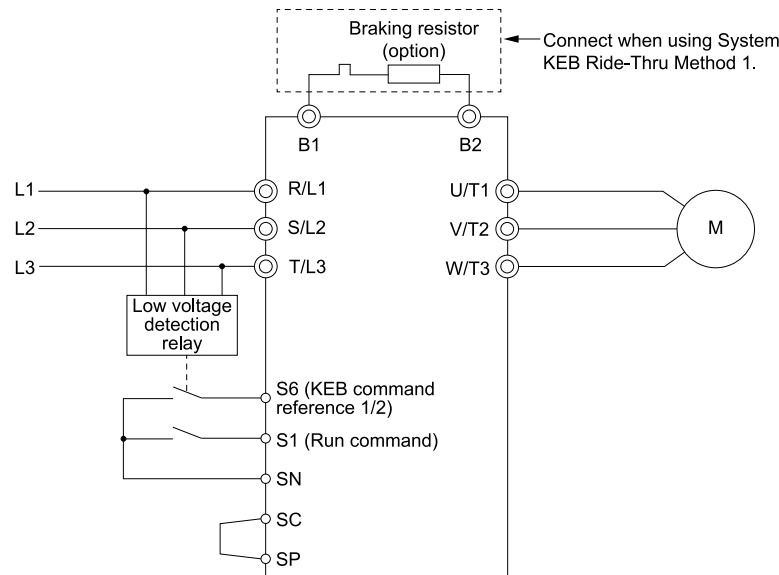

Figure 11.126 KEB Function Wiring Example

■ Parameters for KEB Ride-Thru

The following table lists the parameters used to adjust the KEB Ride-Thru function. Parameter settings vary depending on the KEB method selected by L2-29 [KEB Method Selection].

Table 11.56 Parameters for KEB Ride-Thru

No.	Name	Configuring Settings	L2-29 [KEB Method Selection]			
			0	1	2	3
C1-09	Fast Stop Time	<ul style="list-style-type: none"> Increase if an <i>ov</i> [DC Bus Overvoltage] occurs during KEB deceleration. Decrease if an <i>Uv1</i> [DC Bus Undervoltage] occurs during KEB deceleration. 	x	-	-	-
C2-03	S-Curve Time @ start of Decel	<ul style="list-style-type: none"> Lengthen the setting if <i>ov</i> is detected immediately after deceleration starts via KEB operation. Shorten if <i>Uv1</i> occurs immediately after KEB Ride-Thru is triggered. 	x	-	x	x
L2-05	Undervoltage Detect Level (Uv1)	Increase if a <i>Uv1</i> occurs at KEB operation start to let the drive detect power loss more quickly.	x	x	x	x
L2-06	KEB Deceleration Time	<ul style="list-style-type: none"> Increase if an <i>ov</i> occurs during KEB deceleration. Decrease if an <i>Uv1</i> fault occurs during KEB deceleration. 	-	-	x	x
L2-07	KEB Acceleration Time	Adjust to the desired acceleration time for the frequency to return to the frequency reference value used before a power loss after the KEB operation is canceled. When setting L2-07 = 0, standard acceleration times set to C1-01, C1-03, C1-05, and C1-07 [Acceleration Time] are used.	x	x	x	x
L2-08	Frequency Gain at KEB Start	<ul style="list-style-type: none"> Decrease if an <i>ov</i> operation starts. Increase if an <i>Uv1</i> occurs immediately after KEB operation starts. 	x	-	x	x
L2-10	KEB Detect Time (Min KEB Time)	<ul style="list-style-type: none"> Using KEB Ride-Thru Increase when a digital input is set for KEB Ride-Thru and an <i>Uv1</i> occurs after power was lost because the device controlling the input does not react quickly enough. Not Using KEB Ride-Thru If the DC bus voltage overshoots after KEB Ride-Thru begins, increase L2-10 to longer than the overshoot. 	x	x	x	x
L2-11	DC Bus Vol Setpoint during KEB	<ul style="list-style-type: none"> Single Drive KEB Ride-Thru 2 Set to approximately 1.22 times the input voltage. Single Drive KEB Ride-Thru 1, System KEB Ride-Thru 1, or System KEB Ride-Thru 2 Set to approximately 1.4 times the input voltage. 	x	x	x	x
L3-20	DC Bus Voltage Adjustment Gain	<ul style="list-style-type: none"> Increase this setting in steps of 0.1 if <i>ov</i> or <i>Uv1</i> occurs at the beginning of deceleration. Reduce if torque ripple occurs during deceleration while executing KEB Ride-Thru. 	-	x	-	-
L3-21	Accel/Decel Rate Calculate Gain	Reduce L3-21 in steps of 0.05 if there is a fairly large speed or current ripple. Note: Decreasing this setting too much can cause a slow DC bus voltage control response, and may lead to problems with <i>ov</i> or <i>Uv1</i> .	-	x	-	-
L3-24	Motor Accel Time for Inertia Cal	Set the motor acceleration time to the maximum frequency at the motor rated torque.	-	x	-	-
L3-25	Load Inertia Ratio	Set the load/inertia ratio between motor inertia and machine inertia.	-	x	-	-

■ L2-01: Momentary Power Loss Ope Select

No. (Hex.)	Name	Description	Default (Range)
L2-01 (0485)	Momentary Power Loss Ope Select	V/f CL-V/f OLV CLV AOLV OLV/PM AOLV/PM CLV/PM EZOLV Selects the drive operation performed when a momentary power loss occurs.	0 (0 - 5)

The occurrence of a momentary power loss is detected when the drive DC bus voltage is lower than the value set in *L2-05 [Undervoltage Detect Level (Uv1)]*.

0 : Disabled

Uv1 [DC Bus Undervoltage] is detected when a momentary power loss occurs.

If power is not restored within 15 ms, a *Uv1* is triggered and the drive shuts off the output. The motor coasts to stop.

1 : Enbl with Timer

The drive restarts if the power returns within the time set to *L2-02 [MomentaryPowerLossRide-Thru Time]*. *Uv1* is detected If power is not restored within the time set to *L2-02*.

The drive briefly shuts off its output after a power loss. If the power returns within the time set to *L2-02*, the drive will perform Speed Search and attempt to resume operation.

If the DC bus voltage continues at a state less than or equal to the detection level of *Uv1* for at least the time set in *L2-02*, *Uv1* is detected and the drive outputs a fault signal.

Note:

- The time required for the drive to restart after power is restored varies depending on the drive capacity.
- The upper limit of the possible momentary power loss Ride-Thru time varies depending on the drive model.

2 : Enbl whl CPU act

The drive restarts if the power returns and the drive control circuit has power. This will not trigger a *Uv1*.

When a momentary power loss occurs, the drive output will be shut off. If the power returns and the drive control circuit has power, the drive will attempt to perform Speed Search and resume the operation. This will not trigger a *Uv1*. This function enables longer support for power loss than using *L2-01 = 1*.

3 : KEB Mode

Uv1 is detected when power is not restored within the time set in *L2-02*.

When a momentary power loss is detected, the drive decelerates using regenerative energy from the motor via the KEB operation. When power is restored within the time set in *L2-02*, the drive accelerates the motor again to the frequency reference value used before the power loss. If the power does not return within the time set to *L2-02* elapses, *Uv1* is detected, and the drive output will shut off. The type of KEB operation is determined by the *L2-29 [KEB Method Selection]*.

4 : KEB Stop Mode

The drive restarts if the power returns and the drive control circuit has power.

The drive decelerates using regenerative energy from the motor until the power returns and then restarts when a momentary power loss is detected. When power is restored during deceleration, the drive accelerates the motor again to the frequency reference value used before the power loss. If the motor comes to a stop before the power returns, the drive loses control power and the drive output shuts off. A *Uv1* is not triggered when power is restored while power to the CPU in the drive is maintained. The type of KEB operation is determined by *L2-29*.

5 : KEB Decel to Stp

Deceleration still continues after power is restored until the motor completely stops.

The drive ramps to stop using the regenerative energy from the motor when a momentary power loss is detected. Even if the power is restored, the drive will continue to decelerate until the motor comes to a complete stop. After the power is restored, the drive ramps to stop using the selected deceleration time. The type of KEB operation is determined by the *L2-29*.

Note:

Be aware of the following points when setting *L2-01*.

- A Momentary Power Loss Unit is available to allow for a longer momentary power loss ride through time in models 2004 to 2056 and models 4002 to 4031. A Momentary Power Loss Unit makes it possible to continue running the drive after up to two seconds of power loss.
- When setting *L2-01 = 1 to 4*, keep the magnetic contactor between the motor and the drive closed and the control signal retained as long as the drive performs KEB operation
- When *L2-01 = 1 to 5*, *Uv [DC Bus Undervoltage]* will flash on the keypad while the drive is attempting to recover from a momentary power loss. A fault signal is not output at this time.
- When using a magnetic contactor between the motor and the drive, keep the magnetic contactor closed as long as the drive performs KEB operation or attempts to restart with Speed Search.
- Keep the Run command active during KEB operation. The drive cannot accelerate back to the frequency reference when the power returns.
- When setting *L2-01 = 3 to 5*, a *Uv1* is triggered if the control power supply voltage falls below the CPU operation level during KEB Ride-Thru.

■ L2-02: MomentaryPowerLossRide-Thru Time

No. (Hex.)	Name	Description	Default (Range)
L2-02 (0486)	MomentaryPowerLossRide-Thru Time	V/f CL-V/f OLV CLV AOLV OLV/PM AOLV/PM CLV/PM EZOLV Sets the maximum time allowed to ride through a power loss until the drive restart is compensated.	Determined by o2-04 and C6-01 (0.0 - 25.5 s)

This function is valid when $L2-01 = 1, 3$ [*Momentary Power Loss Ope Select = Enbl with Timer, KEB Mode*]. If power loss operation exceeds this time $Uv1$ [*DC Bus Undervoltage*] is detected, and the drive shuts off its output. The motor coasts to stop.

Note:

- The amount of time the drive is capable of recovering after a power loss is determined by the capacity of the drive.
- Drive capacity determines the upper limit of the possible momentary power loss Ride-Thru time.

■ L2-03: Momentary Power Loss Min BB Time

No. (Hex.)	Name	Description	Default (Range)
L2-03 (0487)	Momentary Power Loss Min BB Time	V/f CL-V/f OLV CLV AOLV OLV/PM AOLV/PM CLV/PM EZOLV Sets the minimum baseblock time when power is restored following a momentary power loss.	Determined by o2-04 and C6-01 (0.1 - 5.0 s)

Sets the time for the drive waits for the residual voltage in the motor to dissipate in approximation to the secondary circuit time constant of the motor. Increase this setting if an *oC* [*Overcurrent*] or *ov* [*DC Bus Overvoltage*] occurs at the beginning of Speed Search, after a power loss, or during DC Injection Braking.

■ L2-04: MomentPowLossVolRecoveryRampTime

No. (Hex.)	Name	Description	Default Setting (Range)
L2-04 (0488)	MomentPowLossVolRecoveryRampTime	V/f CL-V/f OLV CLV AOLV OLV/PM AOLV/PM CLV/PM EZOLV Sets the time for the drive output voltage to return to normal voltage after completion of speed searches.	Determined by o2-04 and C6-01 (0.0 - 5.0 s)

Sets the time for voltage to recover from 0V to the value set in $E1-05$ [*Maximum Output Voltage*].

■ L2-05: Undervoltage Detect Level (Uv1)

No. (Hex.)	Name	Description	Default (Range)
L2-05 (0489)	Undervoltage Detect Level (Uv1)	V/f CL-V/f OLV CLV AOLV OLV/PM AOLV/PM CLV/PM EZOLV Determines the voltage at which a $Uv1$ [<i>DC Bus Undervoltage</i>] fault is triggered or at which the KEB function is activated. Normally there is no need to change this setting.	Determined by E1-01 (Determined by E1-01)

Note:

- Install an AC reactor option on the input side of the power supply when setting undervoltage detection level below the default value to prevent damage to drive circuitry.
- $Uv1$ are likely to be detected during operation of the KEB Ride-Thru if the low voltage detection level approaches the lower limit value of $L2-05$. Do not set the value too low when using the KEB Ride-Thru function.

■ L2-06: KEB Deceleration Time

No. (Hex.)	Name	Description	Default Setting (Range)
L2-06 (048A)	KEB Deceleration Time	V/f CL-V/f OLV CLV AOLV OLV/PM AOLV/PM CLV/PM EZOLV Sets the deceleration time during KEB operation used to reduce the maximum output frequency to 0.	0.0 s (0.0 to 6,000.0 s)

This function is enabled when $L2-29 = 2$ or 3 [*KEB Method Selection = System KEB Ride-Thru 1 or System KEB Ride-Thru 2*].

Sets the deceleration time required to decelerate from the frequency reference to 0 Hz when a momentary power loss is detected. Decrease the deceleration time if an $Uv1$ [*DC Bus Undervoltage*] fault occurs during KEB operation. Increase the deceleration time when *ov* [*Overvoltage*] faults are detected.

- $L2-06 = 0$

Parameter $C1-09$ [Fast Stop Time] is automatically reduced to the base value so that the DC bus voltage does not fall below the low voltage detection level. The setting of $L2-02$ [Momentary Power Loss Ride-Thru Time] is ignored in this case.

- $L2-06 \neq 0$

As illustrated in the following figure, the frequency reference decelerates until it reaches the KEB frequency level in accordance with the deceleration rate of $L2-06$ and then returns to the original frequency reference in accordance with $C1-01$ [Acceleration Time 1]. The KEB frequency level is determined by the setting value of the KEB frequency rate as per the following expression.

KEB frequency level = Output frequency before power loss $\times (1 - (L2-02) / (L2-06))$

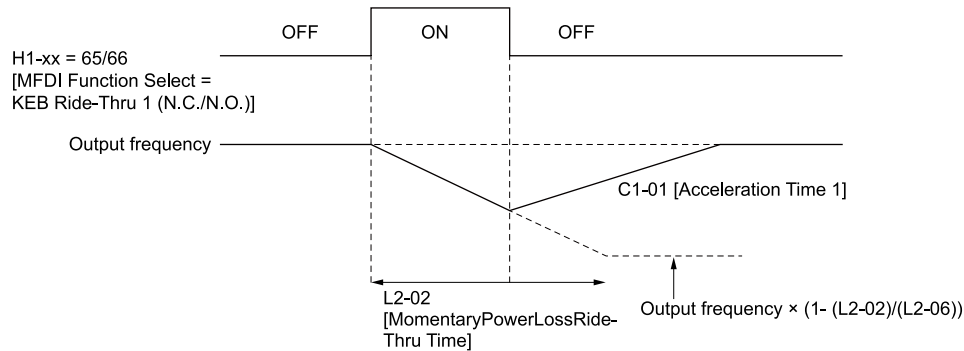

■ L2-07: KEB Acceleration Time

No. (Hex.)	Name	Description	Default Setting (Range)
L2-07 (048B)	KEB Acceleration Time	<input type="checkbox"/> V/f <input type="checkbox"/> CL-V/f <input type="checkbox"/> OLV <input type="checkbox"/> CLV <input type="checkbox"/> AOLV <input type="checkbox"/> OLV/PM <input type="checkbox"/> AOLV/PM <input type="checkbox"/> CLV/PM <input type="checkbox"/> EZOLV Sets the acceleration time used for the frequency to return to the frequency reference in effect before a power loss after the KEB operation is canceled.	0.0 s (0.0 to 6000.0 s)

Setting $L2-07$ to 0.00 seconds disables the function. The currently valid acceleration time [$C1-01$, $C1-03$, $C1-05$, and $C1-07$] is used for reacceleration after KEB operation completes.

■ L2-08: Frequency Gain at KEB Start

No. (Hex.)	Name	Description	Default Setting (Range)
L2-08 (048C)	Frequency Gain at KEB Start	<input type="checkbox"/> V/f <input type="checkbox"/> CL-V/f <input type="checkbox"/> OLV <input type="checkbox"/> CLV <input type="checkbox"/> AOLV <input type="checkbox"/> OLV/PM <input type="checkbox"/> AOLV/PM <input type="checkbox"/> CLV/PM <input type="checkbox"/> EZOLV Sets the amount of output frequency reduction used when KEB operation starts, as a percentage of the motor rated slip before KEB operation startup.	100% (0 - 300%)

Reduces the output frequency in steps to quickly set the motor to a regenerative state. Calculate the value using the following expression.

Output frequency reduction = Motor rated slip before KEB operation $\times (L2-08/100) \times 2$

■ L2-09: KEB Minimum Frequency Level

No. (Hex.)	Name	Description	Default Setting (Range)
L2-09 (048D)	KEB Minimum Frequency Level	<input type="checkbox"/> V/f <input type="checkbox"/> CL-V/f <input type="checkbox"/> OLV <input type="checkbox"/> CLV <input type="checkbox"/> AOLV <input type="checkbox"/> OLV/PM <input type="checkbox"/> AOLV/PM <input type="checkbox"/> CLV/PM <input type="checkbox"/> EZOLV Sets the amount of output frequency reduction used when KEB operation starts, as a percentage of the motor rated slip.	20% (0 - 100%)

The amount of decrease is determined by the following conditions.

- Motor rated slip $\times (L2-09/100)$
- The larger value between the value calculated with $L2-08$ and the value calculated with $L2-09$

■ L2-10: KEB Detect Time (Min KEB Time)

No. (Hex.)	Name	Description	Default Setting (Range)
L2-10 (048E)	KEB Detect Time (Min KEB Time)	<div style="display: flex; justify-content: space-between; font-size: 0.8em; font-weight: bold;"> V/f CL-V/f OLV CLV AOLV OLV/PM AOLV/PM CLV/PM EZOLV </div> Sets the minimum duration to operate the KEB after a momentary power loss is detected.	50 ms (0 - 25500 ms)

If the power is restored while the KEB is operating, the drive continues KEB operation until the time set with *L2-10* elapses. When the DC bus voltage falls below the setting level of *L2-05* [*Undervoltage Detect Level (Uv1)*] in any of the following circumstances, KEB operation continues until the time set with *L2-10* elapses.

- When *L2-01* = 3 [*Momentary Power Loss Ope Select = KEB Mode*].
- When *L2-01* = 4 [*KEB Stop Mode*].
- When *L2-01* = 5 [*KEB Decel to Stp*].
- *KEB Ride-Thru 1/2* [*H1-xx = 65, 66, 7A, or 7B*] is input into the drive.

If the KEB Ride-Thru is input, KEB operation continues after the time set with *L2-10* elapses. The motor reaccelerates once the KEB Ride-Thru is canceled. If the KEB Ride-Thru is not input during the time set with *L2-10*, acceleration occurs until the frequency reference before power was lost is reached for the currently valid acceleration time.

When *L2-01* = 3, 4, or 5, reacceleration occurs after the time set with *L2-10* elapses if the DC bus voltage is at least the value of *L2-11* [*DC Bus Vol Setpoint during KEB*]. KEB operation continues after the time set with *L2-10* elapses if the DC bus voltage has not reached the setting value of *L2-11*.

Note:

- Increase the setting value of *L2-10* when *L2-01* = 0, 1, or 2 [*Disabled, Enabled, or Enabled when CPU is Running*]. Set *L2-10* to cancel KEB operation when the KEB Ride-Thru is not input.
- Setting *L2-10* to 0 ms disables the function of *L2-10*.

■ L2-11: DC Bus Vol Setpoint during KEB

No. (Hex.)	Name	Description	Default Setting (Range)
L2-11 (0461)	DC Bus Vol Setpoint during KEB	<div style="display: flex; justify-content: space-between; font-size: 0.8em; font-weight: bold;"> V/f CL-V/f OLV CLV AOLV OLV/PM AOLV/PM CLV/PM EZOLV </div> Sets the target value used to control the DC bus voltage to a constant level in Single Drive KEB Ride-Thru 2. Sets the DC bus voltage level used to complete the KEB operation for all other KEB methods.	Determined by E1-01 (Determined by E1-01)

■ L2-29: KEB Method Selection

No. (Hex.)	Name	Description	Default Setting (Range)
L2-29 (0475)	KEB Method Selection	<div style="display: flex; justify-content: space-between; font-size: 0.8em; font-weight: bold;"> V/f CL-V/f OLV CLV AOLV OLV/PM AOLV/PM CLV/PM EZOLV </div> Selects the operation mode of the KEB function.	0 (0 - 3)

The KEB function operates if *L2-01* = 3, 4, or 5 [*Momentary Power Loss Ope Select = KEB Mode, KEB Stop Mode, or KEB Decel to Stp*] or *KEB Ride-Thru 1/2* [*H1-xx = 65, 66, 7A, or 7B*].

0 : Single Drive KEB Ride-Thru 1

The drive uses regenerative energy from the motor to maintain the DC bus voltage at the level set with *L2-11* [*DC Bus Vol Setpoint during KEB*] while monitoring the DC bus voltage.

The KEB operation continues while the deceleration rate varies in accordance with the setting of *C1-09* [*Fast Stop Time*].

Note:

- Decrease the setting value of *C1-09* if *Uv1* [*DC Bus Undervoltage*] is detected during the KEB operation.
- Increase the setting value of *C1-09* if *ov* [*Overvoltage*] is detected during the KEB operation.

1 : Single Drive KEB Ride-Thru 2

KEB operation is performed while the deceleration rate is automatically calculated to ensure that the main circuit electrical energy and main current voltage from motor regenerative energy is equal to *L2-11* [*DC Bus Vol Setpoint during KEB*].

2 : System KEB Ride-Thru 1

The drive decelerates based on the KEB deceleration time set to *L2-06* without monitoring the DC bus voltage.

Set *L2-06* to the time necessary to decelerate from the frequency reference to 0 Hz when a momentary power loss is detected. Deceleration can be performed while maintaining constant deceleration rates for multiple drives.

Note:

Doing so may cause *ov* faults to occur. Use the dynamic braking option with System KEB Ride-Thru 1.

3 : System KEB Ride-Thru 2

The drive performs deceleration over the deceleration time set in *L2-06* while monitoring the DC bus voltage. If the DC bus voltage rises, the frequency is momentarily held steady to prevent an *ov* issue while deceleration continues.

Note:

Use System KEB Ride-Thru 2 when the dynamic braking option cannot be used.

■ L2-30: KEB Zero Speed Operation

No. (Hex.)	Name	Description	Default Setting (Range)
L2-30 (045E)	KEB Zero Speed Operation	<div style="display: flex; justify-content: space-between; font-size: small;"> V/f CL-V/f OLV CLV AOLV OLV/PM AOLV/PM CLV/PM EZOLV </div> <p>Selects the operation when the output frequency drops below the zero level (DC braking injection starting frequency) during <i>KEB deceleration</i> when <i>L2-01 = 3 to 5</i> [<i>Momentary Power Loss Ope Select = KEB Mode, KEB Stop Mode, or KEB Decel to Stp</i>].</p>	0 (0, 1)

0 : Baseblock

1 : DC/SC Braking

Performs DC injection braking and short circuit braking in accordance with *b2-04* [*DC Inject Braking Time at Stop*] and *b2-13* [*Short Circuit Brake Time @ Start*].

■ L2-31: KEB Start Voltage Offset Level

No. (Hex.)	Name	Description	Default Setting (Range)
L2-31 (045D)	KEB Start Voltage Offset Level	<div style="display: flex; justify-content: space-between; font-size: small;"> V/f CL-V/f OLV CLV AOLV OLV/PM AOLV/PM CLV/PM EZOLV </div> <p>Configures the KEB start voltage offset.</p>	Determined by A1-02 (200 V Class: 0 - 100 V, 400 V Class: 0 - 200 V)

The KEB start voltage is calculated with the following expression.

$$\text{KEB start voltage} = L2-05 [\text{Undervoltage Detect Level (Uv1)}] + L2-31$$

◆ L3: Stall Prevention

L3 parameters set the Stall Prevention function and overvoltage suppression function.

■ Stall Prevention

The motor may experience excessive slip because it cannot keep up with the frequency reference when the load is too high or acceleration and deceleration times are too short. If the motor stalls during acceleration, current increases in accordance with the increase in slip, which causes an *oC* [*Overcurrent*], *oL2* [*Drive Overloaded*], or *oL1* [*Motor Overload*] and the drive to stop. If the motor stalls during deceleration, it can cause excessive regenerative power to flow back into the DC bus capacitors, and eventually cause the drive to fault out from *ov* [*DC Bus Overvoltage*] to be detected and the drive to stop.

The stall prevention function prevents the motor from stalling and while allowing the motor to reach the desired speed without requiring the user to change the acceleration or deceleration time settings. The stall prevention function can be set separately for acceleration, operating at constant speeds, and deceleration.

■ Overvoltage Suppression Function

Suppresses *ov* by decreasing the regenerative torque limit and slightly increasing the output frequency when the DC bus voltage rises. This function can drive loads with cyclic regenerative operation, such as a punch press or other applications that involve repetitive crank movements. Set *L3-11 = 1* [*OV Suppression Function Select = Enabled*] when using this function.

The regenerative torque limit and the output frequency are adjusted during overvoltage suppression so that the DC bus voltage does not exceed the level set to *L3-17* [*DC Bus Reg Level*].

Set the following parameters as necessary when using the overvoltage suppression function.

- L3-20 [DC Bus Voltage Adjustment Gain]
- L3-21 [Accel/Decel Rate Calculate Gain]
- L3-24 [Motor Accel Time for Inertia Cal]
- L3-25 [Load Inertia Ratio]

Note:

- The motor speed will exceed the frequency reference when overvoltage suppression is triggered. Do not use overvoltage suppression for applications that require a perfect match between the frequency reference and the motor speed.
- Set L3-11 = 0 [Disabled] when using a braking resistor.
- The overvoltage suppression function is enabled only when operating just below the maximum frequency. Overvoltage suppression does not increase the output frequency beyond the maximum frequency. After confirming the motor and machine specifications as necessary depending on the application, increase the maximum frequency.
- *ov* may still occur if there is a sudden increase to a regenerative load.

■ **L3-01: Stall Prevent Select during Accel**

No. (Hex.)	Name	Description	Default (Range)
L3-01 (048F)	Stall Prevent Select duringAccel	<div style="display: flex; justify-content: space-between; font-size: small;"> V/f CL-V/f OLV CLV AOLV OLV/PM AOLV/PM CLV/PM EZOLV </div> Selects the method of the Stall Prevention During Acceleration function.	1 (0 to 3)

Note:

The setting range is between 0 and 1 when A1-02 = 5 [Control Method Selection = PM Open Loop Vector Control].

Stall prevention during acceleration prevents the stalling and stopping of motors when *oC* [Overcurrent], *oL2* [Drive Overloaded], or *oL1* [Motor Overload] is detected in cases of significant loads applied during acceleration or sudden acceleration times regarding load inertia are set.

0 : Disabled

The Stall Prevention function does not operate during acceleration, and acceleration occurs for the set acceleration time. If the acceleration time is too short, the motor does completely accelerate during the set time, which causes *oL1* or *oL2* to be detected and the motor to stop.

1 : Enabled

The Stall Prevention During Acceleration function is enabled. Operation varies depending on the selected control mode.

• **V/f Control Mode, Open Loop Vector Control, or EZ Open Loop Vector Control**

The drive stops acceleration once the output current exceeds the value set in L3-02 [Stall Prevent Level during Accel]. The drive starts acceleration again once the output current falls below the value set in L3-02 - 15%. The Stall Prevention function level automatically falls for constant output ranges.

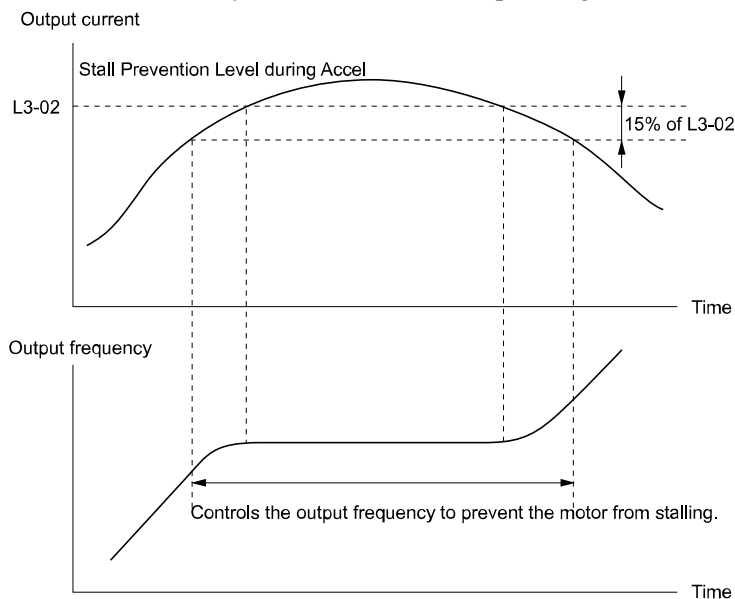

Figure 11.127 Stall Prevention During Acceleration when Using Induction Motors

• **Open Loop Vector Control for PM**

The drive stops acceleration once the output current exceeds the value set in L3-02. Deceleration starts in accordance with the value set in L3-22 [Dec Time at Stall Prevent during Acc] once the time set in L3-27 [Stall Prevention Detection Time] elapses while the output current is at least the value set in L3-02. Deceleration is stopped once the output current falls below the value set in L3-02 - 15%. Acceleration starts again after the time set in L3-27 elapses.

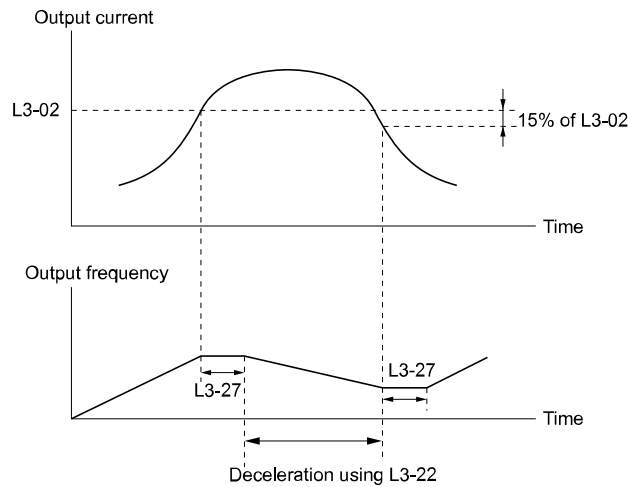

Figure 11.128 Stall Prevention During Acceleration Function under Open Loop Vector Control for PM

2 : Automatic Decel Reduction

The setting value for the acceleration time is ignored, and acceleration starts in the minimum amount of time. The acceleration rate is automatically adjusted so that the output current does not exceed the value set in L3-02.

3 : General Purpose w/ DB resistor

This function limits the output current with the value set for L3-02 and automatically adjusts the acceleration rate. The acceleration rate is automatically adjusted when the load (output current) increases and exceeds the current limit level during acceleration.

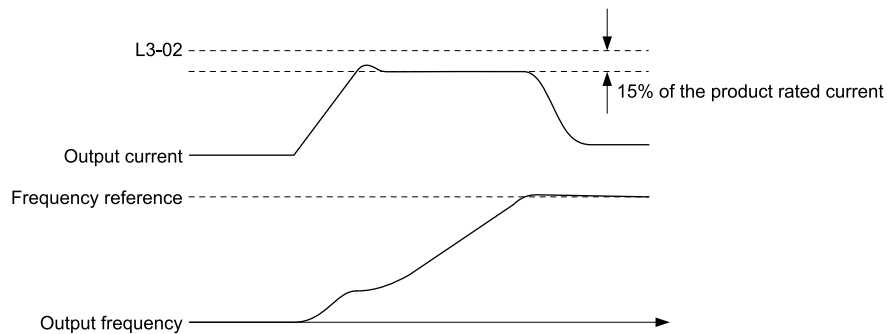

Figure 11.129 Current Limit Acceleration

■ L3-02: Stall Prevent Level during Accel

No. (Hex.)	Name	Description	Default (Range)
L3-02 (0490)	Stall Prevent Level during Accel	<div style="display: flex; justify-content: space-between; font-size: small;"> V/f CL-V/f OLV CLV AOLV OLV/PM AOLV/PM CLV/PM EZOLV </div> <p>Sets the output current level used when the Stall Prevention function is enabled during acceleration, as a percentage of the drive rated output current.</p>	Determined by C6-01 and L8-38 (0 - 150%)

Note:

- The upper limit and default for this setting is determined by C6-01 [Normal / Heavy Duty Selection] and L8-38 [Carrier Frequency Reduction].
- Lower the setting value if stalling occurs when using a motor that is relatively small compared to the drive.
- Also set L3-03 [Stall Prevent Limit during Accel] when operating the motor in the constant power range.

■ **L3-03: Stall Prevent Limit during Accel**

No. (Hex.)	Name	Description	Default (Range)
L3-03 (0491)	Stall Prevent Limit during Accel	V/f CL-V/f OLV CLV AOLV OLV/PM AOLV/PM CLV/PM EZOLV Sets the lower limit for the stall prevention level during acceleration used for constant output ranges, as a percentage of the drive rated output current.	50% (0 - 100%)

The stall prevention level set in *L3-02 [Stall Prevent Level during Accel]* is automatically reduced when the motor is running within the constant output range. Parameter *L3-03* is the limit value used to prevent the stall prevention level during constant output ranges to fall below the minimum required level.

Note:

The function to automatically reduce the stall prevention level does not operate when *L3-01 = 3 [Stall Prevent Select during Accel = Lim Mode]*.

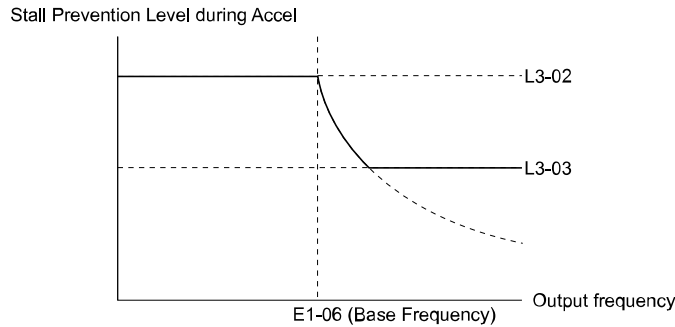

Figure 11.130 Stall Prevent Level during Accel/Limit

■ **L3-04: Decel Stall Prevention Selection**

No. (Hex.)	Name	Description	Default Setting (Range)
L3-04 (0492)	Stall Prevention during Decel	V/f CL-V/f OLV CLV AOLV OLV/PM AOLV/PM CLV/PM EZOLV Selects the type of Stall Prevention during deceleration.	1 (0 to Determined by A1-05)

Note:

Use setting 0 or 3 in combination with a Dynamic Braking Resistor or other dynamic braking options. If this parameter is set to a value other than 0 or 3, the Decel Stall Prevention function has priority, and the dynamic braking option will not function.

Stall Prevention during deceleration controls the deceleration based on the DC bus voltage and prevents an *ov* [DC Bus Overvoltage] caused by high inertia or rapid deceleration.

0 : Disabled

The drive decelerates according to the set deceleration time. With a rapid deceleration, an *ov* may occur.

Note:

Connect the dynamic braking option to the drive if an *ov* occurs. Set *L3-04 = 3* if an *ov* occurs while operating with the dynamic braking option with *A1-02 = 0* or *2 [Control Method Selection = V/f Control, Open Loop Vector Control]* and *L3-04 = 0*.

1 : General Purpose

The drive decelerates according to the set deceleration time. The drive pauses deceleration when the DC bus voltage exceeds the Stall Prevention level and then continues deceleration when the DC bus voltage drops below that level. The drive resumes deceleration at the set deceleration time once the DC bus voltage drops below the stall prevention level. Using Stall Prevention repeatedly helps prevent detections of an *ov* even when the deceleration time is set shorter than the drive is normally capable of handling.

Note:

The Decel Stall Prevention function will extend the deceleration time to reach stop, so that the deceleration time will be longer than what has been set. This function is not appropriate for applications such as conveyors, where the precision of the stop position is extremely important. Consider using a dynamic braking option instead in such applications.

The DC bus voltage level for Stall Prevention depends on the input voltage setting of *E1-01 [Input AC Supply Voltage]*.

Table 11.57 Decel Stall Prevention Level

Drive Input Voltage	Decel Stall Prevention Level
200 V class	377 V
400 V class	754 V

The following figure illustrates the function of Stall Prevention during deceleration.

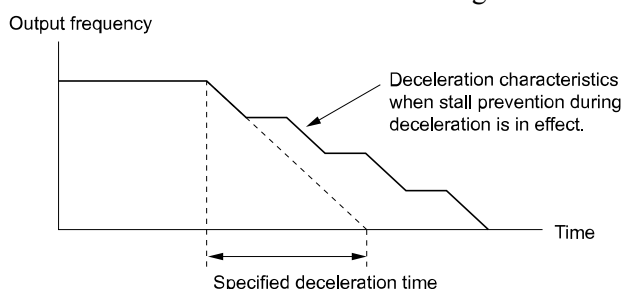

Figure 11.131 Decel Stall Prevention Operation

2 : Automatic Decel Reduction

The drive adjusts the deceleration rate so the DC bus voltage is kept at the level set to *L3-17 [DC Bus Reg Level]*. This produces the shortest possible deceleration time while protecting the motor from stalling. The selected deceleration time is disregarded and the achievable deceleration time cannot be smaller than 1/10 of the set deceleration time.

This function uses the following parameters for adjusting the deceleration rate:

- *L3-20 [DC Bus Voltage Adjustment Gain]*
- *L3-21 [Accel/Decel Rate Calculate Gain]*
- *L3-24 [Motor Accel Time for Inertia Cal]*
- *L3-25 [Load Inertia Ratio]*

Note:

The deceleration time is not constant. Use dynamic braking options instead and set *L3-04 t = 0* in applications where stopping accuracy is a concern. Set *L3-04 = 3* if an *ov* occurs.

3 : General Purpose w/ DB resistor

This setting requires a dynamic braking resistor. Enables the Stall Prevention function while using a dynamic braking resistor.

4 : Overexcitation/High Flux

Enables Overexcitation Deceleration 1. Enables deceleration times shorter than that when *L3-04 = 0*.

Note:

- A long overexcitation time and frequent repetitions of deceleration can trigger *oLI [Motor Overload]*. If an *oLI* is detected, either shorten the deceleration time or install a braking resistor to the drive.
- The deceleration time during Overexcitation Deceleration varies depending on the motor characteristics and machine inertia. Adjust the levels set by *n3-13 [Overexcitation Deceleration Gain]* and *n3-23 [Overexcitation Operation Select]*. Refer to “n3: High Slip Braking (HSB), Overexcitation Deceleration” for details.

5 : Overexcitation/High Flux 2

Enables Overexcitation/High Flux 2. This function shortens the achievable deceleration time more than by using Overexcitation/High Flux.

The drive slows down the motor while trying to maintain the DC bus voltage at the level set to *L3-17*.

Lower the values set in *n3-13* and *n3-21* if an *oLI* is detected. Increase the value set in *C1-02*, *C1-04*, *C1-06*, and *C1-08 [Deceleration Time]* if an *ov* is detected.

Note:

- While Overexcitation/High Flux 2 is operating, both Hunting Prevention in V/f Control and Speed Control using torque limit in OLV Control are disabled.
- Refer to “n3: High Slip Braking (HSB), Overexcitation Deceleration” for details.

■ L3-05: Stall Prevent Select during Run

No. (Hex.)	Name	Description	Default Setting (Range)
L3-05 (0493)	Stall Prevent Select during Run	V/f CL-V/f OLV CLV AOLV OLV/PM AOLV/PM CLV/PM EZOLV Enables or disables the Stall Prevention During Run function.	Determined by A1-02 (0 to Determined by A1-02)

Stall Prevention function during run prevents the motor from stalling by automatically reducing the speed when an *oL1* [Motor Overload] occurs while the motor is running at constant speed.

Note:

Stall Prevention function during run is disabled when the output frequency is 6 Hz or lower regardless of the setting of L3-05 and L3-06 [Stall Prevent Level during Run] if the output frequency falls below 6 Hz.

0 : Disabled

Drive runs at the set frequency reference. A heavy load may cause the motor to stall and trip the drive with an *oC* [Overcurrent] or *oLI*.

1 : Decel time 1

The drive will decelerate for the time set in C1-02 [Deceleration Time 1]. If the current exceeds the Stall Prevention level set in L3-06. When the current level drops below "L3-06 setting value - 2%" for 100 ms, drive accelerates again for the acceleration time valid at that time until the set frequency is reached.

2 : Decel time 2

This setting functions in the same manner as setting 1. If the Stall Prevention function is enabled, the drive decelerates with the value set in C1-04 [Deceleration Time 2].

■ L3-06: Stall Prevent Level during Run

No. (Hex.)	Name	Description	Default (Range)
L3-06 (0494)	Stall Prevent Level during Run	V/f CL-V/f OLV CLV AOLV OLV/PM AOLV/PM CLV/PM EZOLV Sets the current level to trigger Stall Prevention during run. A setting of 100% is equal to the drive rated current.	Determined by C6-01 and L8-38 (30 - 150%)

Note:

- This parameter is valid if L3-05 = 1, 2 [Stall Prevent Select during Run = Decel time 1, Decel time 2].
- The upper limit and default for this setting is determined by C6-01 [Normal / Heavy Duty Selection] and L8-38 [Carrier Frequency Reduction].
- Depending on the setting of L3-23 [CHP Stall P Selection] the level is automatically reduced in the constant power range.

Change the Stall Prevent Level during Run using Analog Input

When H3-xx = 8 [MFAI Function Select = Stall Prevention Level DuringRun], the stall prevention level during run can be changed via the input gain and bias settings for terminals A1, A2, and A3.

If both the input level for terminals A1, A2, and A3 [H3-xx = 8] and L3-06 are set, the smaller value is the effective Stall Prevent Level during Run.

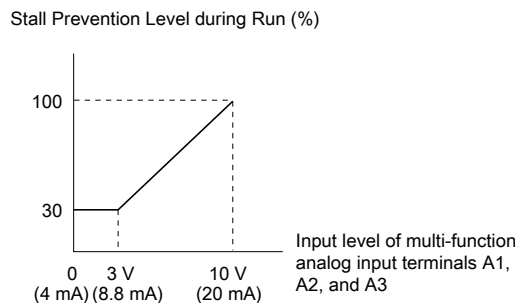

Figure 11.132 Stall Prevention Level during Run using Analog Input

■ L3-11: OV Suppression Function Select

No. (Hex.)	Name	Description	Default (Range)
L3-11 (04C7)	OV Suppression Function Select	V/f CL-V/f OLV CLV AOLV OLV/PM AOLV/PM CLV/PM EZOLV Enables or disables the overvoltage suppression function.	0 (0, 1)

0 : Disabled

The regenerative torque limit and the output frequency are not adjusted. An *ov* [DC Bus Overvoltage] may be detected when regenerative loads are applied. Use this setting if the dynamic braking options are installed.

1 : Enabled

When the DC bus voltage rises due to regenerative load, an *ov* is prevented by decreasing the regenerative torque limit and increasing the output frequency.

■ L3-17: DC Bus Reg Level

No. (Hex.)	Name	Description	Default Setting (Range)
L3-17 (0462)	DC Bus Reg Level	V/f CL-V/f OLV CLV AOLV OLV/PM AOLV/PM CLV/PM EZOLV Set the target value for the DC bus voltage used when the overvoltage suppression function and the Decel Stall Prevention function (Intelligent Stall Prevention) are running.	200 V Class: 375 V, 400 V Class: 750 V (200 V Class: 150 - 400 V, 400 V Class: 300 - 800 V)

Note:

This value is initialized when *E1-01* [Input AC Supply Voltage] is changed.

Sets this parameter for any of the following circumstances.

- *L3-11* = 1 [OV Suppression Function Select = Enabled].
- *L3-04* = 2 [Decel Stall Prevention Selection = Automatic Decel Reduction].

■ L3-20: DC Bus Voltage Adjustment Gain

No. (Hex.)	Name	Description	Default Setting (Range)
L3-20 (0465)	DC Bus Voltage Adjustment Gain	V/f CL-V/f OLV CLV AOLV OLV/PM AOLV/PM CLV/PM EZOLV Sets the proportional gain used to control the DC bus voltage.	Determined by A1-02 (0.00 - 5.00)

This parameter is enabled when any of the following settings are made.

- *L2-29* = 1 [KEB Method Selection = Single Drive KEB Ride-Thru 2]
- *L3-04* = 2 [Decel Stall Prevention Selection = Automatic Decel Reduction]
- *L3-11* = 1 [OV Suppression Function Select = Enabled]
- *H1-xx* = 7A or 7B [MFDI Function Select = KEB Ride-Thru 2 (N.O./N.C.)]

Note:

- If faults such as *ov* [Overvoltage] and *Uv1* [DC Bus Undervoltage] occur when deceleration is started due to the stall prevention during deceleration function when *L2-29* = 1, *H1-xx* = 7A or 7B, or *L3-04* = 2, gradually increase the setting value in increments of 0.1. Speed or current ripples become significant if the setting value is too high.
- Gradually increase the setting value in increments of 0.1 when *ov* issues occur due to sudden increases in regenerative load while *L3-11* = 1. Speed or current ripples become significant if the setting value is too high.

■ L3-21: Accel/Decel Rate Calculate Gain

No. (Hex.)	Name	Description	Default Setting (Range)
L3-21 (0466)	Accel/Decel Rate Calculate Gain	V/f CL-V/f OLV CLV AOLV OLV/PM AOLV/PM CLV/PM EZOLV Sets the proportional gain used to calculate acceleration and deceleration rates.	Determined by A1-02 (0.10 - 10.00)

This parameter is enabled when any of the following settings are made.

- *L2-29* = 1 [KEB Method Selection = Single Drive KEB Ride-Thru 2]
- *L3-04* = 2 [Decel Stall Prevention Selection = Automatic Decel Reduction]
- *L3-11* = 1 [OV Suppression Function Select = Enabled]
- *H1-xx* = 7A or 7B [MFDI Function Select = KEB Ride-Thru 2 (N.O./N.C.)]

Note:

- If the velocity or current ripples are significant while the stall prevention during deceleration function is operating, and the drive is set such that $L2-29 = 1$, $H1-xx = 7A$ or $7B$, or $L3-04 = 2$, gradually reduce the setting value in increments of 0.05. Reduce the setting value of $L3-21$ if *ov* [Overvoltage] or *oC* [Overcurrent] issues occur. If the gain is reduced too significantly, delay in control could develop in the DC bus voltage or the actual deceleration time could be longer than the optimal deceleration time.
- Gradually increase the setting value in increments of 0.1 when *ov* issues occur due to sudden increases in regenerative load while $L3-11 = 1$. Gradually reduce the setting value in increments of 0.05 if speed ripples are significant.

■ **L3-22: DecTime atStallPrevent duringAcc**

No. (Hex.)	Name	Description	Default (Range)
L3-22 (04F9)	DecTime atStallPrevent duringAcc	<div style="display: flex; justify-content: space-between; font-size: 0.8em; margin-bottom: 5px;"> V/f CL-V/f OLV CLV AOLV OLV/PM AOLV/PM CLV/PM EZOLV </div> Sets the brief deceleration time used when stalling occurs while accelerating a PM motor. This function is valid when $L3-01 = 1$ [Stall Prevent Select duringAccel = General Purpose].	0.0 s (0.0 - 6000.0 s)

When set to 0.0 s, this function is disabled. Decelerates in the deceleration time valid at the time when a motor stall occurs.

■ **L3-23: CHP Stall P Selection**

No. (Hex.)	Name	Description	Default (Range)
L3-23 (04FD)	CHP Stall P Selection	<div style="display: flex; justify-content: space-between; font-size: 0.8em; margin-bottom: 5px;"> V/f CL-V/f OLV CLV AOLV OLV/PM AOLV/PM CLV/PM EZOLV </div> Selects whether to automatically diminish the Stall Prevent Level during Run for constant output ranges.	0 (0, 1)

0 : Level set in L3-06

The level set in $L3-06$ [Stall Prevent Level during Run] is used throughout the entire speed range.

1 : Automatic Reduction

The Stall Prevention level during run is reduced in the constant power range. The lower limit will be 40% of $L3-06$.

■ **L3-24: Motor Accel Time for Inertia Cal**

No. (Hex.)	Name	Description	Default Setting (Range)
L3-24 (046E)	Motor Accel Time for Inertia Cal	<div style="display: flex; justify-content: space-between; font-size: 0.8em; margin-bottom: 5px;"> V/f CL-V/f OLV CLV AOLV OLV/PM AOLV/PM CLV/PM EZOLV </div> Sets the motor acceleration time taken to reach the maximum frequency at the motor rated torque for single drive motors that are stopped.	Determined by o2-04, C6-01, E2-11, and E5-01 (0.001 - 10.000 s)

This parameter is enabled when any of the following settings are made.

- $L2-29 = 1$ [KEB Method Selection = Single Drive KEB Ride-Thru 2]
- $L3-04 = 2$ [Decel Stall Prevention Selection = Automatic Decel Reduction]
- $L3-11 = 1$ [OV Suppression Function Select = Enabled]
- $H1-xx = 7A$ or $7B$ [MFDI Function Select = KEB Ride-Thru 2 (N.O./N.C.)]

Note:

The value of Yaskawa standard motors (4 poles) is automatically set to the value of $L3-24$ when the setting of $E2-11$ [Motor Rated Power (kW)] is changed by the Auto-Tuning process. When using PM motors, the setting value of $L3-24$ is changed in accordance with the setting of $E5-01$ [PM Motor Code Selection].

Automatic Adjustment of Parameters

Execute the Inertia Tuning process when $A1-02 = 3$ or 7 [Control Method Selection = Closed Loop Vector Control or PM Closed Loop Vector Control]. Parameters are automatically adjusted.

Manual Parameter Input

Derive the motor acceleration time using the following expression.

$$L3-24 = \frac{2\pi \cdot J_{\text{Motor}} \cdot n_{\text{rated}}}{60 \cdot T_{\text{rated}}}$$

- J_{Motor} = Moment of inertia of motor (kg m²)
- n_{rated} = Motor rated speed (min⁻¹, r/min)

- $T_{\text{rated}} = \text{Motor rated torque (N}\cdot\text{m)}$

The rated torque is calculated using the following expression.

$$T_{\text{rated}} = \frac{60 \cdot P_{\text{Motor}} \cdot 10^3}{2\pi \cdot n_{\text{rated}}}$$

P_{Motor} = Motor Rated Power (kW)

■ L3-25: Load Inertia Ratio

No. (Hex.)	Name	Description	Default Setting (Range)
L3-25 (046F)	Load Inertia Ratio	<input checked="" type="checkbox"/> V/f <input checked="" type="checkbox"/> CL-V/f <input type="checkbox"/> OLV <input type="checkbox"/> CLV <input type="checkbox"/> AOLV <input type="checkbox"/> OLV/PM <input type="checkbox"/> AOLV/PM <input type="checkbox"/> CLV/PM <input type="checkbox"/> EZOLV Sets the ratio between motor inertia and machine inertia.	1.0 (1.0 - 1000.0)

This parameter is enabled when any of the following settings are made.

- $L2-29 = 1$ [*KEB Method Selection = Single Drive KEB Ride-Thru 2*]
- $L3-04 = 2$ [*Decel Stall Prevention Selection = Automatic Decel Reduction*]
- $L3-11 = 1$ [*OV Suppression Function Select = Enabled*]
- $H1-xx = 7A$ or $7B$ [*MFDI Function Select = KEB Ride-Thru 2 (N.O./N.C.)*]

Note:

If this value is not set correctly when $L2-29 = 1$, $H1-xx = 7A$ or $7B$, or $L3-11 = 1$, current ripples could become significant causing faults such as *ov* [*Overvoltage*], *Uv1* [*DC Bus Undervoltage*], and *oC* [*Overcurrent*] to be detected.

Automatic Adjustment of Parameters

Execute the Inertia Tuning process when $A1-02 = 3$ or 7 [*Control Method Selection = Closed Loop Vector Control or PM Closed Loop Vector Control*]. Parameters are automatically adjusted.

Manual Parameter Input

The load inertia ratio is calculated using the following expression.

$$\text{Load inertia ratio} = \frac{\text{Machine inertia (Motor shaft conversion value)}}{\text{Motor inertia}}$$

■ L3-26: Additional DC Bus Capacitors

No. (Hex.)	Name	Description	Default Setting (Range)
L3-26 (0455)	Additional DC Bus Capacitors	<input checked="" type="checkbox"/> V/f <input checked="" type="checkbox"/> CL-V/f <input type="checkbox"/> OLV <input type="checkbox"/> CLV <input type="checkbox"/> AOLV <input type="checkbox"/> OLV/PM <input type="checkbox"/> AOLV/PM <input type="checkbox"/> CLV/PM <input type="checkbox"/> EZOLV Sets the capacity for external main circuit capacitors. Normally there is no need to change this setting. Set this parameter when using the KEB Ride-Thru function.	0 μF (0 to 65000 μF)

■ L3-27: Stall Prevention Detection Time

No. (Hex.)	Name	Description	Default (Range)
L3-27 (0456)	Stall Prevention Detection Time	<input checked="" type="checkbox"/> V/f <input checked="" type="checkbox"/> CL-V/f <input type="checkbox"/> OLV <input type="checkbox"/> CLV <input type="checkbox"/> AOLV <input type="checkbox"/> OLV/PM <input type="checkbox"/> AOLV/PM <input type="checkbox"/> CLV/PM <input type="checkbox"/> EZOLV Sets a delay time from when the Stall Prevention level is reached and the actual Stall Prevention function is activated.	50 ms (0 - 5000 ms)

■ L3-34: Torque Limit Delay Time

No. (Hex.)	Name	Description	Default Setting (Range)
L3-34 (016F)	Torque Limit Delay Time	<input checked="" type="checkbox"/> V/f <input checked="" type="checkbox"/> CL-V/f <input type="checkbox"/> OLV <input type="checkbox"/> CLV <input type="checkbox"/> AOLV <input type="checkbox"/> OLV/PM <input type="checkbox"/> AOLV/PM <input type="checkbox"/> CLV/PM <input type="checkbox"/> EZOLV Sets the filter time constant in units of seconds used to return the torque limit to its original value while the KEB operation is executing under Single Drive KEB Ride-Thru mode.	Determined by A1-02 (0.000 - 1.000 s)

Increase the setting value in increments of 0.010 when vibration occurs during operation of Single Drive KEB Ride-Thru 2.

Note:

The Single Drive KEB Ride-Thru 2 mode operates when $L2-29 = 1$ [*KEB Method Selection = Single Drive KEB Ride-Thru 2*] and $H1-xx = 7A$ or $7B$ [*Terminal Sx Function Selection = KEB Ride-Thru 2 (N.C./N.O.)*].

■ **L3-35: IntDecSpdAgrWdth**

No. (Hex.)	Name	Description	Default Setting (Range)
L3-35 (0747)	IntDecSpdAgrWdth	<div style="display: flex; justify-content: space-between; font-size: small;"> V/f CL-V/f OLV CLV AOLV OLV/PM AOLV/PM CLV/PM EZOLV </div> <p>Sets the width for speed agreement when $L3-04 = 2$ [<i>Decel Stall Prevention Selection = Automatic Decel Reduction</i>]. Normally there is no need to change this setting.</p>	0.00 Hz (0.00 - 1.00 Hz)

Set this parameter when hunting occurs while using a frequency reference via analog input.

■ **L3-36: VibraSuppressionGain duringAccel**

No. (Hex.)	Name	Description	Default Setting (Range)
L3-36 (11D0)	VibraSuppression Gain duringAccel	<div style="display: flex; justify-content: space-between; font-size: small;"> V/f CL-V/f OLV CLV AOLV OLV/PM AOLV/PM CLV/PM EZOLV </div> <p>Sets the gain used to suppress current or motor speed hunting during operation when $L3-01 = 3$ [<i>Stall Prevent Select during Accel = ILim Mode</i>]. Normally there is no need to change this setting.</p>	Determined by A1-02 (0.0 - 100.0)

Increase the setting value when output current vibrates during acceleration.

Note:

This function is enabled when $L3-01 = 3$ [*Stall Prevent Limit during Accel = ILim Mode*].

■ **L3-37: Current Limit P Gain duringAccel**

No. (Hex.)	Name	Description	Default Setting (Range)
L3-37 (11D1)	Current Limit P Gain duringAccel	<div style="display: flex; justify-content: space-between; font-size: small;"> V/f CL-V/f OLV CLV AOLV OLV/PM AOLV/PM CLV/PM EZOLV </div> <p>Suppresses current hunting during acceleration. Normally there is no need to change this setting.</p>	5 ms (0 - 100 ms)

Note:

This function is enabled when $L3-01 = 3$ [*Stall Prevent Limit during Accel = ILim Mode*].

■ **L3-38: Current Limit I Time duringAccel**

No. (Hex.)	Name	Description	Default Setting (Range)
L3-38 (11D2)	Current Limit I Time duringAccel	<div style="display: flex; justify-content: space-between; font-size: small;"> V/f CL-V/f OLV CLV AOLV OLV/PM AOLV/PM CLV/PM EZOLV </div> <p>Suppresses the hunting and overshooting of current that occurs when stalling occurs during acceleration. Normally there is no need to change this setting.</p>	10.0 (0.0 - 100.0)

Note:

This function is enabled when $L3-01 = 3$ [*Stall Prevent Limit during Accel = ILim Mode*].

■ **L3-39: Response Time Constant for Current-limited Acceleration**

No. (Hex.)	Name	Description	Default Setting (Range)
L3-39 (11D3)	CurlimIntegTimeCon duringAcc/Dec	<div style="display: flex; justify-content: space-between; font-size: small;"> V/f CL-V/f OLV CLV AOLV OLV/PM AOLV/PM CLV/PM EZOLV </div> <p>Sets the time constant used to adjust the acceleration rate when $L3-01 = 3$ [<i>Stall Prevent Limit during Accel = ILim Mode</i>]. Normally there is no need to change this setting.</p>	100.0 ms (1.0 - 1000.0 ms)

Note:

This function is enabled when $L3-01 = 3$ [*Stall Prevent Limit during Accel = ILim Mode*].

■ L3-40: CurlimMaxScurveSel duringAcc/Dec

No. (Hex.)	Name	Description	Default Setting (Range)
L3-40 (11D4)	CurlimMaxScurveSel duringAcc/Dec	V/f CL-V/f OLV CLV AOLV OLV/PM AOLV/PM CLV/PM EZOLV Selects whether to enable or disable the optimal S-curve characteristic used for current -limited acceleration.	0 (0, 1)

Optimally adjusts and operates the motor acceleration rate used for startup. Enabling this parameter stabilizes acceleration but may cause the acceleration time to be longer than the set time. Set this parameter when faults such as *oC* [*Overcurrent*] occur immediately after acceleration starts.

0 : Disabled

1 : Enabled

Note:

This function is enabled when *L3-01* = 3 [*Stall Prevent Limit during Accel = ILim Mode*].

◆ L4: Speed Detection

L4 parameters set the output of signals such as frequency agree and speed detection to the MFDO terminals. The motor speed is detected when using CLV or CLV/PM.

■ L4-01: Speed Agree Detection Level

No. (Hex.)	Name	Description	Default (Range)
L4-01 (0499)	Speed Agree Detection Level	V/f CL-V/f OLV CLV AOLV OLV/PM AOLV/PM CLV/PM EZOLV Sets the speed agree detection level or the motor speed detection level.	Determined by A1-02 (Determined by A1-02)

Sets the speed detection level or motor speed detection level when *H2-01* to *H2-04* = 2, 3, 4, 5 [*MFDO Function Select = Speed Agree 1, User-set Speed Agree 1, Frequency Detection 1, Frequency Detection 2*].

■ L4-02: Speed Agree Detection Width

No. (Hex.)	Name	Description	Default (Range)
L4-02 (049A)	Speed Agree Detection Width	V/f CL-V/f OLV CLV AOLV OLV/PM AOLV/PM CLV/PM EZOLV Sets the speed agree detection width or motor speed detection width.	Determined by A1-02 (Determined by A1-02)

Sets the speed detection width or motor speed detection width when *H2-01* to *H2-04* = 2, 3, 4, 5 [*MFDO Function Select = Speed Agree 1, User-set Speed Agree 1, Frequency Detection 1, Frequency Detection 2*].

■ L4-03: Speed Agree Detect Level (+/-)

No. (Hex.)	Name	Description	Default (Range)
L4-03 (049B)	Speed Agree Detect Level (+/-)	V/f CL-V/f OLV CLV AOLV OLV/PM AOLV/PM CLV/PM EZOLV Sets the speed agree detection level or the motor speed detection level.	Determined by A1-02 (Determined by A1-02)

Sets the speed detection level or motor speed detection level when *H2-01* to *H2-04* = 13, 14, 15, 16 [*MFDO Function Select = Speed Agree 2, User-set Speed Agree 2, Frequency Detection 3, Frequency Detection 4*].

■ L4-04: Speed Agree Detect Width (+/-)

No. (Hex.)	Name	Description	Default (Range)
L4-04 (049C)	Speed Agree Detect Width (+/-)	V/f CL-V/f OLV CLV AOLV OLV/PM AOLV/PM CLV/PM EZOLV Sets the speed agree detection width or motor speed detection width.	Determined by A1-02 (Determined by A1-02)

Sets the speed detection width or motor speed detection width when $H2-01$ to $H2-04 = 13, 14, 15, 16$ [MFDO Function Select = Speed Agree 2, User-set Speed Agree 2, Frequency Detection 3, Frequency Detection 4].

■ L4-05: FreqReference Loss Detect Select

No. (Hex.)	Name	Description	Default (Range)
L4-05 (049D)	FreqReference Loss Detect Select	V/f CL-V/f OLV CLV AOLV OLV/PM AOLV/PM CLV/PM EZOLV Selects the operation when a loss of the frequency reference is detected.	0 (0, 1)

Enables the detection of a loss of an analog frequency reference when the frequency reference is input from the MFAI terminals (A1, A2, and A3). Set $H2-01$ to $H2-04 = C$ [MFDO Function Select = Frequency Reference Loss] to enable this function.

Frequency reference loss is detected when the frequency reference drops below 10% within 400 ms.

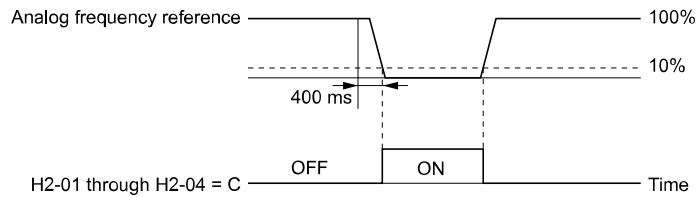

Figure 11.133 Detection of Frequency Reference Loss

0 : Stop

The drive follows the frequency reference and stops the motor.

1 : Run@L4-06PrevRef

The drive will continue operation at the frequency reference value set to $L4-06$ [FreqReference at Reference Loss]. When the external frequency reference value is restored, the operation is continued with the frequency reference.

■ L4-06: FreqReference at Reference Loss

No. (Hex.)	Name	Description	Default (Range)
L4-06 (04C2)	FreqReference at Reference Loss	V/f CL-V/f OLV CLV AOLV OLV/PM AOLV/PM CLV/PM EZOLV Sets the frequency reference as a percentage that is applicable when not stopping the drive so that it continues to operate after a loss of the frequency reference value is detected. The value is set as a percentage of the frequency reference before the loss was detected.	80.0% (0.0 - 100.0%)

This parameter is enabled when $L4-05 = 1$ [FreqReference Loss Detect Select = Run@L4-06PrevRef].

■ L4-07: Speed Agree Detection Selection

No. (Hex.)	Name	Description	Default (Range)
L4-07 (0470)	Speed Agree Detection Selection	V/f CL-V/f OLV CLV AOLV OLV/PM AOLV/PM CLV/PM EZOLV Selects the condition for activating speed detection.	0 (0, 1)

0 : No detection during baseblock

Detects the frequency while the drive is operating. The frequency is not detected when the drive shuts off its output.

1 : Detection always enabled

◆ L5: Auto Restart

The Auto Restart function attempts to keep machines from stopping when a transient fault is detected.

The drive can perform a self-diagnostic check and resume the operation after a fault has occurred. If the cause of the fault has disappeared, the drive restarts by first performing Speed Search instead of stopping. A fault history is not recorded. Use $L5-02$ [AutoRestartFaultOutputOpeSelect] to select the operation of fault relay signals during Auto Restart operation.

Sets whether to execute Auto restart and the number of attempts to perform within a set time. Drive output is shut off and operation stops if the number of Auto Restart attempts exceeds the set value during the set time. In such cases, resolve the cause of the fault and manually restart the drive.

DANGER! Sudden Movement Hazard. Never use the fault restart function so that the drive restarts the application after a fault occurs in hoist or lifting applications. Failure to comply may result in death or serious injury.

The drive can execute the Auto Restart function when the following faults occur.

Table 11.58 List of Faults during which Auto Restart is Available

Fault	Name	Fault	Name
GF	Ground Fault	ov	DC Bus Overvoltage
LF	Output Phase Loss	PF	Input Phase Loss
oC	Overcurrent	rH	Mounted Braking Resistor Overheating
oH1	Overheat 1 (Heatsink Overheat)	rr	Dynamic Braking Transistor
oL1	Motor Overload	Uv1	Undervoltage ^{*1}
oL2	Drive Overloaded	STPo	Pull-Out Detection
oL3	Overtorque Detection 1		
oL4	Overtorque Detection 2		

*1 Uv1 is the target for the fault retry process when configured such that L2-01 = 1, 2, 3, or 4 [Momentary Power Loss Ope Select = Enbl with Timer, Enbl whl CPU act, KEB Mode, or KEB Stop Mode].

■ L5-01: Number of Auto Restart Attempts

No. (Hex.)	Name	Description	Default (Range)
L5-01 (049E)	Number of Auto Restart Attempts	<p>V/f CL-V/f OLV CLV AOLV OLV/PM AOLV/PM CLV/PM EZOLV</p> <p>Sets the number of that can be automatically performed by the drive. Sets the number of Auto Restart operations that the drive may attempt to restart itself.</p>	0 (0 - 10 times)

The number of Auto Restart attempts is reset to 0 in the following situations.

- The drive operates normally for 10 minutes following a fault restart.
- A fault is cleared manually after protective functions are triggered.
- The power supply is cycled.

■ L5-02: AutoRestartFaultOutputOpeSelect

No. (Hex.)	Name	Description	Default (Range)
L5-02 (049F)	AutoRestartFaultOutputOpeSelect	<p>V/f CL-V/f OLV CLV AOLV OLV/PM AOLV/PM CLV/PM EZOLV</p> <p>Selects whether to output signals to the MFDO terminal set for Fault [H2-xx = E] while the drive is executing Auto restart.</p>	0 (0, 1)

0 : Fault output not active

1 : Fault output active

■ L5-04: Auto Restart Interval Time

No. (Hex.)	Name	Description	Default (Range)
L5-04 (046C)	Auto Restart Interval Time	<p>V/f CL-V/f OLV CLV AOLV OLV/PM AOLV/PM CLV/PM EZOLV</p> <p>Sets the time interval between each Auto Restart process. This function is enabled when L5-05 = 1 [Auto Restart Operation Selection = Use L5-04 Time].</p>	10.0 s (0.5 - 600.0 s)

■ L5-05: Auto Restart Operation Selection

No. (Hex.)	Name	Description	Default (Range)
L5-05 (0467)	Auto Restart Operation Selection	<div style="display: flex; justify-content: space-between; font-size: small;"> V/f CL-V/f OLV CLV AOLV OLV/PM AOLV/PM CLV/PM EZOLV </div> Selects the count method for the Auto Restart operation.	0 (0, 1)

0 : Continuous

Counts the number of successful fault resets via Auto Restart.

Once this count exceeds the value set in *L5-01*, a fault is output on the keypad, a fault signal is output, and the motor coasts to stop.

1 : Use L5-04 Time

Counts the number of executed fault resets via Auto Restart, whether successful or not. The Auto Restart process is repeated in intervals as set by *L5-04* [*Auto Restart Interval Time*].

Once this count exceeds the value set in *L5-01*, a fault is output on the keypad, a fault signal is output, and the motor coasts to stop.

◆ L6: Detection of Overtorque/Undertorque

The overtorque/undertorque detection function is used to protect machinery and loads.

Overtorque is the state in which an excessive load is placed on the machine. When the motor current or output torque reaches or exceeds the overtorque detection level and this state continues for at least the overtorque detection time, an alarm is output, and the drive shuts off the output.

Undertorque is the state in which loads have suddenly decreased. When the motor current or output torque reaches or falls below the undertorque detection level and this state continues for at least the undertorque detection time, an alarm is output, and the drive shuts off the output.

The undertorque detection function can be used to detect the following states.

- Machine belt cuts
- Abnormal operation of the electromagnetic contactor on the drive output side
- Clogged output side air filters in fans and blowers
- Damage to blade tips and breakage of string

Note:

Drives may stop during overtorque conditions due to *oC* [*Overcurrent*] or *oLI* [*Motor Overload*] occurs. To prevent the drive from stopping, use torque detection to indicate an overload situation to the controller before *oC* or *oLI* are detected by the drive. As with undertorque conditions, use this function to detect issues that occur in the application.

■ Parameter Settings

The two overtorque/undertorque detection functions can be set individually with this device. Set the parameters in accordance with the following table.

Table 11.59 Overtorque/Undertorque Detection Settings Parameters

Configuration Parameter	Overtorque/Undertorque Detection 1	Overtorque/Undertorque Detection 2
MFDO Function Select	H2-01, H2-02, H2-03, and H2-04 = B	H2-01, H2-02, H2-03, H2-04 = 18
<ul style="list-style-type: none"> • Terminals M1-M2 • Terminals M3-M4 • Terminals P1-C1 • Terminals P2-C2 	N.O.: Turned on when detected	N.O.: Turned on when detected
	H2-01, H2-02, H2-03, H2-04 = 17	H2-01, H2-02, H2-03, H2-04 = 19
	N.C.: Turned off when detected	N.C.: Turned off when detected
Detection conditions and selection of operation after detection	L6-01	L6-04
Detection Level	L6-02	L6-05
	Analog Input Terminal *1 H3-xx = 7	-
Detection Time	L6-03	L6-06

*1 The torque detection level can also be supplied by an analog input terminal. Set *H3-xx = 7* [*MFAI Function Select = Overtorque/Undertorque DetectLvl*] to enable this function. If both *L6-02* and *H3-xx = 7* are set, the analog input has priority and the setting of *L6-02* is disabled.

The detection level for the analog input terminals cannot be set with Overtorque/Undertorque Detection 2.

Note:

The current level (100% of the drive rated output current) is used for the detection of overtorque/undertorque under V/f Control. The motor torque (100% of the motor rated torque) is used for the detection of overtorque/undertorque under vector control. If the mechanical weakening detection function is enabled, the overtorque/undertorque detection level under all control modes is the current level (100% of the drive rated output current).

■ Detection of Overtorque/Undertorque Time Chart

Overtorque Detection Time Chart

When using Overtorque/Undertorque Detection 1, overtorque is detected when the motor current or motor torque is at least the detection level set to *L6-02 [Torque Detection Level 1]* continues for at least the time set to *L6-03 [Torque Detection Time 1]*. The operation after detection is set in *L6-01 [Torque Detection Selection 1]*.

Set *L6-05 [Torque Detection Level 2]*, *L6-06 [Torque Detection Time 2]*, and *L6-04 [Torque Detection Selection 2]* if using Overtorque/Undertorque Detection 2.

Set the terminal that outputs the alarm in *H2-01 to H2-04 [MFDO Function Select]*.

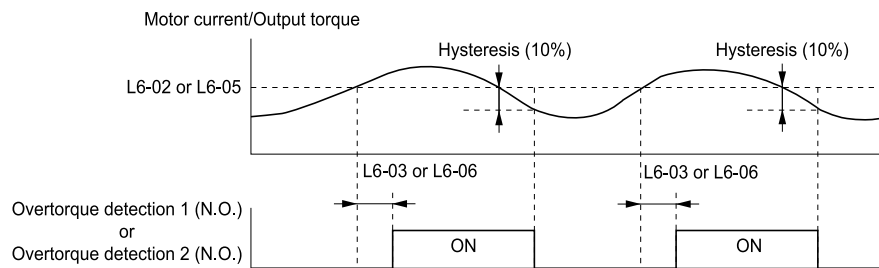

Figure 11.134 Overtorque Detection Time Chart

Note:

A hysteresis of approximately 10% of the drive rated output current or the motor rated torque is applied to the overtorque/undertorque detection function.

Undertorque Detection Time Chart

When using Overtorque/Undertorque Detection 1, undertorque is detected if the motor current or motor torque continues to be less than or equal to the detection level set in *L6-02* for at least the time set in *L6-03*. The operation after detection is set in *L6-01*.

Set the operation in *L6-05*, *L6-06*, and *L6-0* to use Overtorque/Undertorque Detection 2.

Set the terminal that outputs an alarm in *H2-01 to H2-04*.

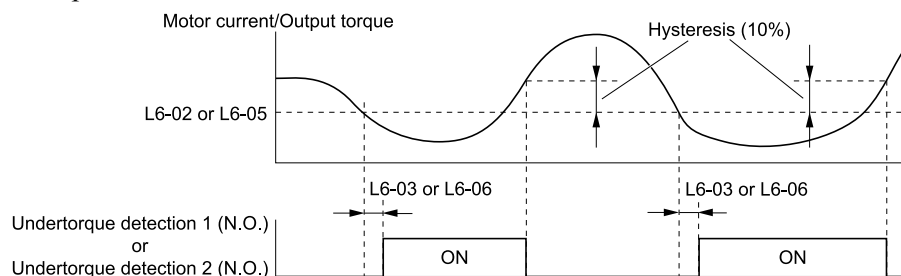

Figure 11.135 Undertorque Detection Time Chart

Note:

A hysteresis of approximately 10% of the drive rated output current or the motor rated torque is applied to the overtorque/undertorque detection function.

■ Mechanical Deterioration Detection Function

Mechanical Weakening Detection detects the mechanical weakening of a machine that leads to overtorque or undertorque situations on the basis of motor speed and drive cumulative operation time.

The function is activated in the drive when the drive cumulative operation time exceeds the time set to *L6-11 [MechanicalWeakeningDetectSrtTime]*. The drive cumulative operation time can be monitored via *U4-01 [Cumulative Ope Time]*.

Parameter Settings

Mechanical Weakening Detection is detected when an overtorque or undertorque occurs during the speed range set in *L6-08 [Mechanical Weakening Detect Ope]* and *L6-09 [MechanicalWeakeningDetectSpdLvl]* for a time that

lasts at least as long as the setting of L6-10 [Mechanical Weakening Detect Time]. The drive detects oL5 [Mechanical Weakening Detection 1] or UL5 [Mechanical Weakening Detection 2] by using L6-01 to L6-03 [Torque Detection 1 Setting Parameter]. The operation after detection is set in L6-08.

The terminal that outputs the fault is set in H2-01 to H2-04 [MFDO Function Select].

Table 11.60 Mechanical Weakening Detection Settings Parameters

Configuration Parameter		Mechanical Deterioration Detection
MFDO Function Select	<ul style="list-style-type: none"> • Terminals M1-M2 • Terminals M3-M4 • Terminals P1-C1 • Terminals P2-C2 	H2-01, H2-02, H2-03, H2-04 = 22
Operation Selection after Detection		L6-08
Detection Start Time		L6-11
Speed Range	Detection Criteria	L6-08
	Detection Level	L6-09
	Detection Time	L6-10
Overtorque	Detection Criteria	L6-01
	Detection Level	L6-02
	Detection Time	L6-03

■ **L6-01: Torque Detection Selection 1**

No. (Hex.)	Name	Description	Default (Range)
L6-01 (04A1)	Torque Detection Selection 1	<div style="display: flex; gap: 5px;"> V/f CL-V/f OLV CLV AOLV OLV/PM AOLV/PM CLV/PM EZOLV </div> <p>Selects the speed range at which overtorque/undertorque is detected and the operation of drives (operation status) after detection.</p>	0 (0 - 8)

Overtorque is detected when the motor current or output torque continues to be at least the level set in L6-02 [Torque Detection Level 1] for at least the time set in L6-03 [Torque Detection Time 1]. Undertorque is detected when the motor current or output torque continues to be lower than or equal to the level set in L6-02 for at least the time set in L6-03.

0 : Disabled

Detection of overtorque and undertorque is not performed.

1 : OL Alm at SpdAgr

Overtorque is detected only when the output frequency matches the frequency reference. Detection does not occur during acceleration/deceleration. oL3 [Overtorque Detection 1] is output, but operation continues after detection.

2 : OL Alm dur RUN

Detection of overtorque is constantly performed when the run command is enabled. oL3 is output, but operation continues after detection.

3 : OL Fit at SpdAgr

Overtorque is detected only when the output frequency matches the frequency reference. Detection does not occur during acceleration/deceleration. oL3 is output after detection, and operation stops.

4 : OL Fit dur RUN

Detection of overtorque is constantly performed when the run command is enabled. oL3 is output after detection, and operation stops.

5 : UL Alm at SpdAgr

Undertorque is detected only when the output frequency matches the frequency reference. Detection does not occur during acceleration/deceleration. UL3 [Undertorque Detection 1] is output, but operation continues after detection.

6 : UL Alm dur RUN

Detection of undertorque is constantly performed when the run command is enabled. UL3 is output, but operation continues after detection.

7 : UL Flt at SpdAgr

Undertorque is detected only when the output frequency matches the frequency reference. Detection does not occur during acceleration/deceleration. *UL3* is output after detection, and operation stops.

8 : UL Flt dur RUN

Detection of undertorque is constantly performed when the run command is enabled. *UL3* is output after detection, and operation stops.

■ L6-02: Torque Detection Level 1

No. (Hex.)	Name	Description	Default Setting (Range)
L6-02 (04A2)	Torque Detection Level 1	<div style="display: flex; gap: 5px;"> V/f CL-V/f OLV CLV AOLV OLV/PM AOLV/PM CLV/PM EZOLV </div> <p>Sets the detection level for Overtorque/Undertorque Detection 1. This parameter is set on the basis of the drive rated output current as the 100% value when using V/f Control. This parameter is set on the basis of the motor rated torque as the 100% value when using vector control.</p>	150% (0 - 300%)

Note:

- Set the torque detection level as a percentage of the drive rated output current in all control methods to set the mechanical weakening detection level.
- The torque detection level can also be supplied by an analog input terminal. Set *H3-xx = 7* [*MFAI Function Select = Overtorque/Undertorque DetectLvl*] to enable this function. If both *L6-02* and *H3-xx = 7* are set, the analog input has priority and the setting of *L6-02* is disabled.

■ L6-03: Torque Detection Time 1

No. (Hex.)	Name	Description	Default Setting (Range)
L6-03 (04A3)	Torque Detection Time 1	<div style="display: flex; gap: 5px;"> V/f CL-V/f OLV CLV AOLV OLV/PM AOLV/PM CLV/PM EZOLV </div> <p>Sets the detection time for Overtorque/Undertorque Detection 1.</p>	0.1 s (0.0 - 10.0 s)

■ L6-04: Torque Detection Selection 2

No. (Hex.)	Name	Description	Default Setting (Range)
L6-04 (04A4)	Torque Detection Selection 2	<div style="display: flex; gap: 5px;"> V/f CL-V/f OLV CLV AOLV OLV/PM AOLV/PM CLV/PM EZOLV </div> <p>Selects the speed range at which overtorque/undertorque is detected and the operation of drives (operation status) after detection.</p>	0 (0 - 8)

Overtorque is detected when the motor current or output torque continues to be at least the level set in *L6-05* [*Torque Detection Level 2*] for at least the time set in *L6-06* [*Torque Detection Time 2*]. Undertorque is detected when the motor current or output torque continues to be lower than or equal to the level set in *L6-05* for at least the time set in *L6-06*.

0 : Disabled

Detection of overtorque and undertorque is not performed.

1 : OL Alm at SpdAgr

Overtorque is detected only when the output frequency matches the frequency reference. Detection does not occur during acceleration/deceleration. *oL4* [*Overtorque Detection 2*] is output, but operation continues after detection.

2 : OL Alm dur RUN

Detection of overtorque is constantly performed when the run command is enabled. *oL4* is output, but operation continues after detection.

3 : OL Flt at SpdAgr

Overtorque is detected only when the output frequency matches the frequency reference. Detection does not occur during acceleration/deceleration. *oL4* is output after detection, and operation stops.

4 : OL Flt dur RUN

Detection of overtorque is constantly performed when the run command is enabled. *oL4* is output after detection, and operation stops.

5 : UL Alm at SpdAgr

Undertorque is detected only when the output frequency matches the frequency reference. Detection does not occur during acceleration/deceleration. *UL4* [Undertorque Detection 2] is output, but operation continues after detection.

6 : UL Alm dur RUN

Detection of undertorque is constantly performed when the run command is enabled. *UL4* is output, but operation continues after detection.

7 : UL Flt at SpdAgr

Undertorque is detected only when the output frequency matches the frequency reference. Detection does not occur during acceleration/deceleration. *UL4* is output after detection, and operation stops.

8 : UL Flt dur RUN

Detection of undertorque is constantly performed when the run command is enabled. *UL4* is output after detection, and operation stops.

■ **L6-05: Torque Detection Level 2**

No. (Hex.)	Name	Description	Default Setting (Range)
L6-05 (04A5)	Torque Detection Level 2	V/f CL-V/f OLV CLV AOLV OLV/PM AOLV/PM CLV/PM EZOLV Sets the detection level for Overtorque/Undertorque Detection 2. This parameter is set on the basis of the drive rated output current as the 100% value when using V/f Control. This parameter is set on the basis of the motor rated torque as the 100% value when using vector control.	150% (0 - 300%)

Note:

The detection level for the analog input terminal cannot be set by Overtorque/Undertorque Detection 2.

■ **L6-06: Torque Detection Time 2**

No. (Hex.)	Name	Description	Default Setting (Range)
L6-06 (04A6)	Torque Detection Time 2	V/f CL-V/f OLV CLV AOLV OLV/PM AOLV/PM CLV/PM EZOLV Sets the detection time for Overtorque/Undertorque Detection 2.	0.1 s (0.0 - 10.0 s)

■ **L6-08: Mechanical Weakening Detect Ope**

No. (Hex.)	Name	Description	Default Setting (Range)
L6-08 (0468)	Mechanical Weakening Detect Ope	V/f CL-V/f OLV CLV AOLV OLV/PM AOLV/PM CLV/PM EZOLV Selects the speed range at which mechanical deterioration is detected and the operation of drives (operation status) after detection.	0 (0 - 8)

Mechanical weakening via overtorque or undertorque is detected in accordance with the criteria set in *L6-08 to L6-11* [Mechanical Deterioration Detection Settings Parameters]. Overtorque/undertorque detection criteria is set in *L6-01 to L6-03* [Torque Detection 1 Settings Parameters]. Note that the drive operation selection as set by *L6-01* [Torque Detection Selection 1] is disabled.

0 : Disabled

Mechanical weakening detection is not performed.

1 : Alm Spd>L6-09

Mechanical weakening is detected when the speed (signed) is more than or equal to the value set in *L6-09* [MechanicalWeakeningDetectSpdLvl]. *oL5* [Mechanical Weakening Detection 1] is output, but operation continues after detection.

2 : Alm [Spd]>L6-09

Mechanical weakening is detected when the speed (absolute value) is more than or equal to the value set in *L6-09*. *oL5* is output, but operation continues after detection.

3 : Flt Spd>L6-09

Mechanical weakening is detected when the speed (signed) is more than or equal to the value set in *L6-09*. *oL5* is output after detection, and operation stops.

4 : Flt [Spd]>L6-09

Mechanical weakening is detected when the speed (absolute value) is more than or equal to the value set in L6-09. oL5 is output after detection, and operation stops.

5 : Alm Spd<L6-09

Mechanical weakening is detected when the speed (signed) is less than or equal to the value set in L6-09. UL5 [Mechanical Weakening Detection 2] is output, but operation continues after detection.

6 : Alm [Spd]<L6-09

Mechanical weakening is detected when the speed (absolute value) is less than or equal to the value set in L6-09. UL5 is output, but operation continues after detection.

7 : Flt Spd<L6-09

Mechanical weakening is detected when the speed (signed) is less than or equal to the value set in L6-09. UL5 is output after detection, and operation stops.

8 : Flt [Spd]<L6-09

Mechanical weakening is detected when the speed (absolute value) is less than or equal to the value set in L6-09. UL5 is output after detection, and operation stops.

■ L6-09: MechanicalWeakeningDetectSpdLvl

No. (Hex.)	Name	Description	Default Setting (Range)
L6-09 (0469)	MechanicalWeakeningDetectSpdLvl	<div style="display: flex; justify-content: space-between; font-size: small;"> V/f CL-V/f OLV CLV AOLV OLV/PM AOLV/PM CLV/PM EZOLV </div> <p>On the basis that E1-04 [Maximum Output Frequency] is the 100% value, this parameter sets the speed level at which the mechanical deterioration detection function operated as a percentage.</p>	110.0% (-110.0 - 110.0%)

Overtorque/undertorque detection criteria is set in L6-01 to L6-03 [Torque Detection 1 Settings Parameters].

The setting value of L6-09 is recognized as the absolute value when L6-08 = 2, 4, 6, 8 [Mechanical Weakening Detect Ope = Speed : unsigned]. This value is processed as a positive number even if L6-09 is set to a negative number.

■ L6-10: Mechanical Weakening Detect Time

No. (Hex.)	Name	Description	Default Setting (Range)
L6-10 (046A)	Mechanical Weakening Detect Time	<div style="display: flex; justify-content: space-between; font-size: small;"> V/f CL-V/f OLV CLV AOLV OLV/PM AOLV/PM CLV/PM EZOLV </div> <p>Sets the time for mechanical deterioration detection.</p>	0.1 s (0.0 - 10.0 s)

Detects mechanical weakening when the detection criteria selected with L6-08 [Mechanical Weakening Detect Ope] continues for at least the time set in L6-10.

■ L6-11: MechanicalWeakeningDetectSrtTime

No. (Hex.)	Name	Description	Default Setting (Range)
L6-11 (046B)	MechanicalWeakeningDetectSrtTime	<div style="display: flex; justify-content: space-between; font-size: small;"> V/f CL-V/f OLV CLV AOLV OLV/PM AOLV/PM CLV/PM EZOLV </div> <p>Sets the time at which mechanical deterioration detection is started using the cumulative operation time of the drive as a trigger.</p>	0 h (0 - 65535 h)

The mechanical weakening detection function executes when the cumulative operation time of the drive exceeds the value set in L6-11. The drive cumulative operation time can be monitored by U4-01 [Cumulative Ope Time].

◆ L7: Torque Limit

The torque limit function limits torque generated by the motor to a constant amount by limiting the internal torque reference for the drive. This function is used to keep torque applied to loads and the generation of regenerative torque below a specific amount. This function protects machinery and improves reliability of continuous operation. Torque limits can be set individually for the four quadrants, which include torque direction (motoring/regeneration) and direction of motor rotation (forward/reverse). When the torque reference value reaches the set torque limit, the MFDO terminal set for *During Torque Limit* [H2-xx = 30] turns ON.

Note:

- Maximum output torque is limited by the drive output current. Torque is limited to 150% of the rated output current for Heavy Duty Rating (HD) and to 120% of the rated output current for Normal Duty Rating (ND). The actual output torque will not exceed the limits of the drive rated output current even if the torque limit is set to a high value.
- When using torque limits for lifting applications, do not lower the torque limit value too much. When the torque limit function is triggered, falls and slipping rollbacks may occur due to sudden acceleration stops and stalls of the motor.

■ Configuring Settings

Set torque limits using one of the following methods.

- Individually set the four torque limit quadrants using *L7-01 to L7-04 [Torque Limit]*.
- Individually set the four torque limit quadrants via MFAI. Set *H3-02, H3-06, H3-10 = 10, 11, 12 [MFAI Function Select = Forward/Reverse/Regenerative Torque Limit]*.
- Set all four torque limit quadrants commonly via MFAI. Set *H3-02, H3-06, H3-10 = 15 [General Torque Limit]*.
- Set all four torque limit quadrants commonly by the communication option.

The following figure illustrates the configuration method for each quadrant.

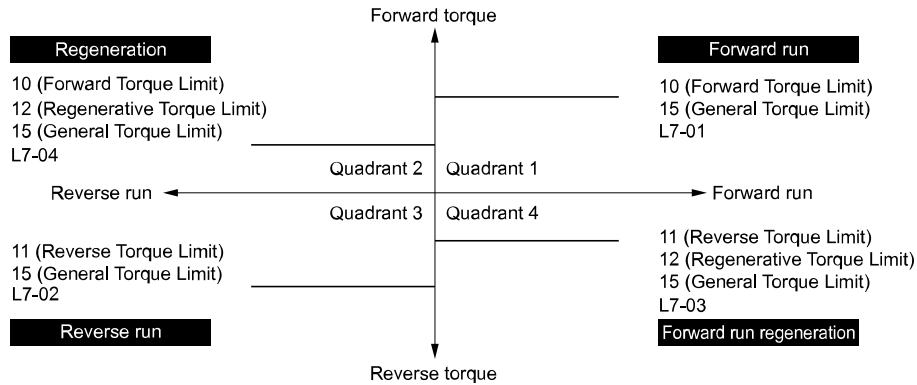

Figure 11.136 Torque Limits and Analog Input Settings Parameters

Note:

The lower value is enabled when both *L7-01 to L7-04* and either analog inputs or communication option torque limits set torque limits for the same quadrant.

As in the following example of parameter settings, the torque limit for quadrant 1 is 130% and the torque limit for quadrants 2, 3, and 4 is 150%.

Settings: *L7-01 = 130%, L7-02, L7-03, L7-04 = 200%, MFAI torque limit = 150%*

■ L7-01: Forward Torque Limit

No. (Hex.)	Name	Description	Default (Range)
L7-01 (04A7) RUN	Forward Torque Limit	<input type="checkbox"/> V/f <input type="checkbox"/> CL-V/f <input checked="" type="checkbox"/> OLV <input checked="" type="checkbox"/> CLV <input type="checkbox"/> AOLV <input type="checkbox"/> OLV/PM <input type="checkbox"/> AOLV/PM <input type="checkbox"/> CLV/PM <input type="checkbox"/> EZOLV On the basis that the motor rated torque is the 100% value, this parameter sets the torque limit value for forward motoring as a percentage.	200% (0 - 300%)

Note:

- The smallest set torque limit is enabled when sets *H3-02, H3-06, or H3-10 = 10, 15 [MFAI Function Select = Forward Torque Limit, General Torque Limit]*, or when torque limits are set with the communication option.
- When increasing the setting value, when the drive capacity is greater than or equal to the motor output. Note that issues of *oC [Drive Overcurrent]* may occur if the setting value is too high.
- Note that the motor may stall if the setting is too low when used with significant loads.

■ L7-02: Reverse Torque Limit

No. (Hex.)	Name	Description	Default (Range)
L7-02 (04A8) RUN	Reverse Torque Limit	<input type="checkbox"/> V/f <input type="checkbox"/> CL-V/f <input checked="" type="checkbox"/> OLV <input checked="" type="checkbox"/> CLV <input type="checkbox"/> AOLV <input type="checkbox"/> OLV/PM <input type="checkbox"/> AOLV/PM <input type="checkbox"/> CLV/PM <input type="checkbox"/> EZOLV Sets the torque limit value for reversed motoring as a percentage of the motor rated torque.	200% (0 - 300%)

Note:

- The smallest set torque limit is enabled when $H3-02$, $H3-06$, or $H3-10 = 11, 15$ [MFAI Function Select = Reverse Torque Limit, General Torque Limit], or when torque limits are set with the communication option.
- When increasing the setting value, when the drive capacity is greater than or equal to the motor output. Note that issues of oC [Drive Overcurrent] may occur if the setting value is too high.
- Note that the motor may stall if the setting is too low when used with significant loads.

■ L7-03: Forward Regenerative TorqueLimit

No. (Hex.)	Name	Description	Default (Range)
L7-03 (04A9) RUN	Forward Regenerative TorqueLimit	<input type="checkbox"/> V/f <input type="checkbox"/> CL-V/f <input checked="" type="checkbox"/> OLV <input type="checkbox"/> CLV <input type="checkbox"/> AOLV <input type="checkbox"/> OLV/PM <input type="checkbox"/> AOLV/PM <input type="checkbox"/> CLV/PM <input type="checkbox"/> EZOLV Sets the torque limit value for forward regenerative states as a percentage of the motor rated torque.	200% (0 - 300%)

Note:

- The smallest set torque limit is enabled when $H3-02$, $H3-06$, or $H3-10 = 11, 12, 15$ [MFAI Function Select = Reverse Torque Limit, Regenerative Torque Limit, General Torque Limit] or when torque limits are set with the communication option.
- When increasing the setting value, when the drive capacity is greater than or equal to the motor output. Note that issues of oC [Drive Overcurrent] may occur if the setting value is too high.
- Note that the motor may stall if the setting is too low when used with significant loads.

■ L7-04: Reverse Regenerative TorqueLimit

No. (Hex.)	Name	Description	Default (Range)
L7-04 (04AA) RUN	Reverse Regenerative TorqueLimit	<input type="checkbox"/> V/f <input type="checkbox"/> CL-V/f <input checked="" type="checkbox"/> OLV <input type="checkbox"/> CLV <input type="checkbox"/> AOLV <input type="checkbox"/> OLV/PM <input type="checkbox"/> AOLV/PM <input type="checkbox"/> CLV/PM <input type="checkbox"/> EZOLV Sets the torque limit value for reversed regenerative states as a percentage of the motor rated torque.	200% (0 - 300%)

Note:

- The smallest set torque limit is enabled when sets $H3-02$, $H3-06$, or $H3-10 = 10, 12, 15$ [MFAI Function Select = Forward Torque Limit, Regenerative Torque Limit, General Torque Limit], or when torque limits are set with the communication option.
- When increasing the setting value, when the drive capacity is greater than or equal to the motor output. Note that issues of oC [Drive Overcurrent] may occur if the setting value is too high.
- Note that the motor may stall if the setting is too low when used with significant loads.

■ L7-06: TorqueLimitIntegralTime Constant

No. (Hex.)	Name	Description	Default (Range)
L7-06 (04AC)	TorqueLimitIntegral Time Constant	<input type="checkbox"/> V/f <input type="checkbox"/> CL-V/f <input checked="" type="checkbox"/> OLV <input type="checkbox"/> CLV <input type="checkbox"/> AOLV <input type="checkbox"/> OLV/PM <input type="checkbox"/> AOLV/PM <input type="checkbox"/> CLV/PM <input type="checkbox"/> EZOLV Sets the integral time constant for the torque limit function.	200 ms (5 - 10000 ms)

Decrease the setting value to improve torque limit responsiveness when using torque limits when $L7-07 = 1$ [Forward Torque Limit = I-ctrl @ Acc/Dec].

Increase the setting value if hunting issues occur when torque limits are active.

■ L7-07: TrqLimContMethodSelduringAcc/Dec

No. (Hex.)	Name	Description	Default (Range)
L7-07 (04C9)	TrqLimContMethod SelduringAcc/Dec	<input type="checkbox"/> V/f <input type="checkbox"/> CL-V/f <input checked="" type="checkbox"/> OLV <input type="checkbox"/> CLV <input type="checkbox"/> AOLV <input type="checkbox"/> OLV/PM <input type="checkbox"/> AOLV/PM <input type="checkbox"/> CLV/PM <input type="checkbox"/> EZOLV Selects the function of torque limit during acceleration and deceleration.	0 (0, 1)

0 : P-ctrl @ Acc/Dec

The torque limit function works with proportional control during acceleration and deceleration, and switches to integral control at constant speed. Use this setting when accelerating or decelerating to the desired speed has priority over the torque limit during speed changes.

1 : I-ctrl @ Acc/Dec

The torque limit function always uses integral control. Use this setting when a highly accurate torque limit is required such as with winding machines, even during speed changes.

Prioritizing torque limit may produce the following effects.

11.9 L: Protection Function

- Acceleration and deceleration times take longer.
- Motor speed does not reach the frequency reference value during run at constant speed.

■ L7-16: Torque Limit Process at Start

No. (Hex.)	Name	Description	Default (Range)
L7-16 (044D)	Torque Limit Process at Start	<input type="checkbox"/> V/f <input type="checkbox"/> CL-V/f <input checked="" type="checkbox"/> OLV <input checked="" type="checkbox"/> CLV <input type="checkbox"/> AOLV <input type="checkbox"/> OLV/PM <input type="checkbox"/> AOLV/PM <input type="checkbox"/> CLV/PM <input type="checkbox"/> EZOLV Assigns a time filter to allow the torque limit to build at start.	1 (0, 1)

0 : Disabled

Torque limit is created at start without a delay time.

Disable this setting to maximize the response time when the application requires sudden acceleration or deceleration at start.

1 : Enabled

A delay time of 64 ms is added to allow the torque limit to build at start.

■ L7-35: Regeneration Torque Limit during Low Frequency Operation

No. (Hex.)	Name	Description	Default Setting (Range)
L7-35 (1B57)	DeratingTrqLimFor LowFreq&Regratn	<input type="checkbox"/> V/f <input type="checkbox"/> CL-V/f <input type="checkbox"/> OLV <input type="checkbox"/> CLV <input checked="" type="checkbox"/> AOLV <input type="checkbox"/> OLV/PM <input type="checkbox"/> AOLV/PM <input type="checkbox"/> CLV/PM <input type="checkbox"/> EZOLV Sets the torque limit used during low-speed regeneration. Normally there is no need to change this setting.	50.00% (0.00 - 200.00%)

Reduces the regenerative torque limit to the level set with *L7-35* when using low frequencies such that the output frequency is less than *L7-36* [*Ope Freq Band for Derating Trq Lim Torque Limit*]. Torque limits are not reduced during ramp to stop operation. Decrease the setting of *L7-35* when *oC* [*Overcurrent*] issues occur while a regenerative load is input and the speed reference is constant.

Note:

- Reduce the setting value of *L7-35* in increments of 10.00% and reduce the setting value of *L7-36* in increments of 2.00 Hz when faults occur during regenerative loads at low speed.
- Setting values that are too high can cause faults.
- The torque limit reduction function does not operate when *L7-35* is set with a value larger than *L7-03* [*Forward Regenerative TorqueLimit*] or *L7-04* [*Reverse Regenerative TorqueLimit*].
- The motor may rotate slightly faster than the reference when a regenerative load is input at low speeds while *L7-35* is set to a low value.

■ L7-36: Ope Freq band for deratingTrqLim

No. (Hex.)	Name	Description	Default Setting (Range)
L7-36 (1B58)	Ope Freq band for deratingTrqLim	<input type="checkbox"/> V/f <input type="checkbox"/> CL-V/f <input type="checkbox"/> OLV <input type="checkbox"/> CLV <input checked="" type="checkbox"/> AOLV <input type="checkbox"/> OLV/PM <input type="checkbox"/> AOLV/PM <input type="checkbox"/> CLV/PM <input type="checkbox"/> EZOLV Sets the frequency width at which <i>L7-35</i> [<i>Derating Trq Lim For Low Freq & Regeneration</i>] operates.	6.00 Hz (0.00 - 30.00 Hz)

Increase the setting value when *oC* [*Overcurrent*] faults are detected while regenerative loads are connected at low speed. Reduces the torque limit in accordance with the setting of *L7-35* within a range of $0 \leq$ output frequency $< L7-36$. When the torque limit gradually changes in accordance with the output frequency until the output frequency = *L7-36*, the value explicitly changes to the settings of *L7-03* [*Forward Regenerative TorqueLimit*] and *L7-04* [*Reverse Regenerative TorqueLimit*].

Note:

The motor rotates faster than the reference speed when a regenerative load is input while *L7-36* is set to a large value. Do not set the value any higher than necessary.

◆ L8: Drive Protection

L8 parameters set protective functions that prevent faults such as overheating, phase loss, and ground faults.

■ L8-01: Internal DB Resistor Protect Sel

No. (Hex.)	Name	Description	Default (Range)
L8-01 (04AD)	Internal DB Resistor Protect Sel	<div style="display: flex; justify-content: space-between; font-size: 0.8em; font-weight: bold;"> V/f CL-V/f OLV CLV AOLV OLV/PM AOLV/PM CLV/PM EZOLV </div> Enabled braking resistor protection of the when using an optional heatsink mounted braking resistor (ERF type, 3% ED).	0 (0, 1)

0 : Not Provided

Disables braking resistor protection. Use this setting for any dynamic braking option other than the Yaskawa ERF-type resistor.

1 : Provided

Enables protection for Yaskawa ERF-type resistors.

Note:

Set $L8-01 = 1$ and $H2-01$ to $H2-04 = D$ [MFDO Function Select = Braking Resistor Fault]. Use a sequence that shuts the power OFF by using MFDO.

■ L8-02: Overheat Alarm Level

No. (Hex.)	Name	Description	Default (Range)
L8-02 (04AE)	Overheat Alarm Level	<div style="display: flex; justify-content: space-between; font-size: 0.8em; font-weight: bold;"> V/f CL-V/f OLV CLV AOLV OLV/PM AOLV/PM CLV/PM EZOLV </div> Sets the <i>oH</i> detection level in temperature.	Determined by o2-04 and C6-01 (50 - 150 °C)

The alarm is output when the heatsink temperature exceeds the temperature set in $L8-02$. To enable this function, set one of $H2-01$ to $H2-04$ [MFDO Function Select] to 20 [Drive Overheat Pre-Alarm (*oH*)].

If the temperature reaches the overheat fault level, the drive will trigger an *oH1* [Heatsink Overheat] fault and stop operation.

■ L8-03: Overheat Pre-Alarm Ope Selection

No. (Hex.)	Name	Description	Default (Range)
L8-03 (04AF)	Overheat Pre-Alarm Ope Selection	<div style="display: flex; justify-content: space-between; font-size: 0.8em; font-weight: bold;"> V/f CL-V/f OLV CLV AOLV OLV/PM AOLV/PM CLV/PM EZOLV </div> Sets the operation of drives when an <i>oH</i> alarm is detected.	3 (0 - 4)

0 : Ramp to Stop

The drive ramps the motor to stop according to the deceleration time. The terminal turns on when $H2-xx = E$ [MFDO Function Select = Fault] is set.

1 : Coast to Stop

The drive shuts off output and the motor coasts to stop. The terminal turns on when $H2-xx = E$.

2 : Fast-Stop

The drive stops the motor using the deceleration time set with C1-09 [Fast Stop Time]. The terminal turns on when $H2-xx = E$.

3 : Alarm Only

oH appears on the keypad, and operation continues.

4 : Run@L8-19 Rate

The drive performs deceleration to the level set in $L8-19$ [Freq Reduct Rate During OH Pre-Alarm] and continues operation. *oH* flashes on the keypad.

The drive performs deceleration again if the overheat alarm is still on after 10 seconds have elapsed. The drive continues to perform deceleration every 10 seconds while the alarm continues to be output. If the overheat alarm is still output after the drive performs deceleration 10 times, the output terminal set by *oH Pre-Alarm Time Limit* [$H2-01$ to $H2-04 = 4D$] turns on. When the overheat alarm stops being output during deceleration, the drive performs acceleration until the frequency reference valid prior to this overheat alarm output being turned off is reached. The following diagram illustrates the output of the overheat alarm and the drive operation at a diminished output frequency.

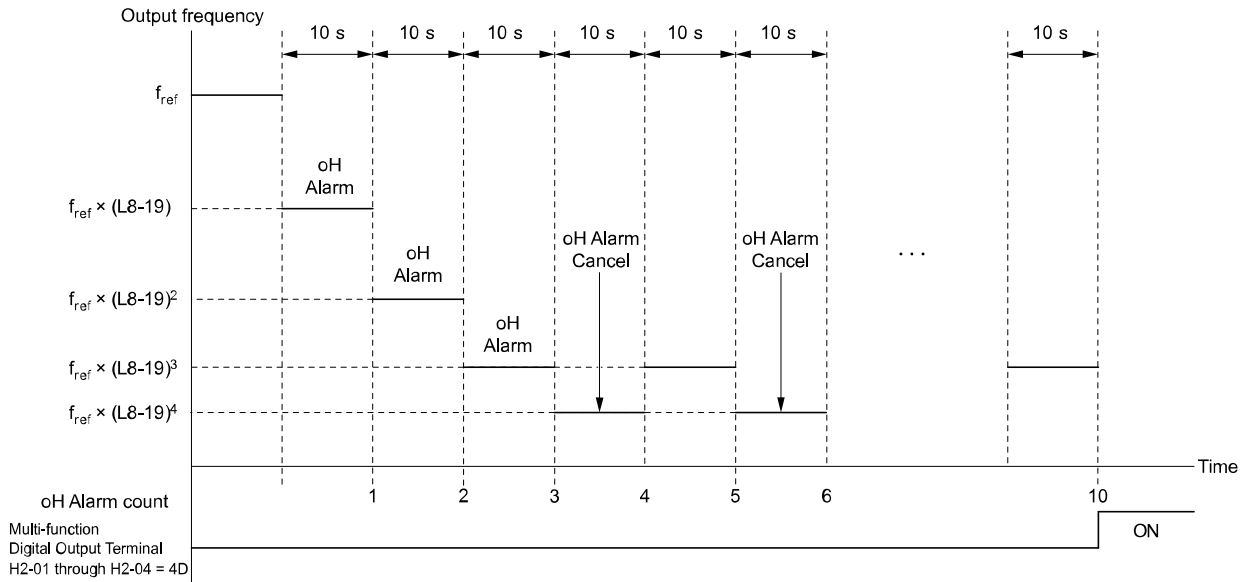

Figure 11.137 Drive Operation at a Diminished Output Frequency when the Overheat Alarm is Output

■ **L8-05: Input Phase Loss Protect Select**

No. (Hex.)	Name	Description	Default Setting (Range)
L8-05 (04B1)	Input Phase Loss Protect Select	<input type="checkbox"/> V/f <input type="checkbox"/> CL-V/f <input type="checkbox"/> OLV <input type="checkbox"/> CLV <input type="checkbox"/> AOLV <input type="checkbox"/> OLV/PM <input type="checkbox"/> AOLV/PM <input type="checkbox"/> CLV/PM <input type="checkbox"/> EZOLV Enables or disables input phase loss detection.	0 (0, 1)

0 : Disabled

1 : Enabled

Detects input phase loss by measuring ripples in DC bus voltage.

Input phase loss is detected when power supply phase loss occurs or the main circuit capacitor deteriorates, which causes *PF [Input Phase Loss]* to appear on the keypad.

Disable the input power supply phase loss detection function in the following circumstances.

- During deceleration
- The run command is not input
- The output current is less than 30% of the drive rated current

■ **L8-07: Output Phase Loss Protect Select**

No. (Hex.)	Name	Description	Default (Range)
L8-07 (04B3)	Output Phase Loss Protect Select	<input type="checkbox"/> V/f <input type="checkbox"/> CL-V/f <input type="checkbox"/> OLV <input type="checkbox"/> CLV <input type="checkbox"/> AOLV <input type="checkbox"/> OLV/PM <input type="checkbox"/> AOLV/PM <input type="checkbox"/> CLV/PM <input type="checkbox"/> EZOLV Enables or disables the output phase loss detection. Output phase loss detection is triggered when the output current falls below 5% of the drive rated current.	0 (0 - 2)

Note:

Output phase loss detection can mistakenly be triggered in the following situations. Disable output phase loss protection.

- The motor rated current is very small compared to the drive rating.
- Operates PM motors with light loads.

0 : Disabled

1 : 1PH Loss Det

An *LF [Output Phase Loss]* is triggered when one output phase is lost.

The output shuts off and the motor coasts to stop.

2 : 2/3PH Loss Det

An *LF [Output Phase Loss]* is triggered when two or more output phases are lost.

The output shuts off and the motor coasts to stop.

■ L8-09: Output Ground Fault DetectSelect

No. (Hex.)	Name	Description	Default Setting (Range)
L8-09 (04B5)	Output Ground Fault DetectSelect	V/f CL-V/f OLV CLV AOLV OLV/PM AOLV/PM CLV/PM EZOLV Enables or disables ground fault protection.	Determined by o2-04 (0, 1)

0 : Disabled

Ground faults are not detected.

1 : Enabled

GF [Ground Fault] is triggered when high leakage current or a ground short circuit occurs in one or two output phases.

Note:

If the ground path impedance is low, motors may stop due to detections of an *oC* [Overcurrent], a *SC* [Out Short Circuit or IGBT Fault], or an *ov* [DC Bus Overvoltage].

■ L8-10: Heatsink Cooling Fan Ope Select

No. (Hex.)	Name	Description	Default (Range)
L8-10 (04B6)	Heatsink Cooling Fan Ope Select	V/f CL-V/f OLV CLV AOLV OLV/PM AOLV/PM CLV/PM EZOLV Selects the heatsink cooling fan operation.	0 (0 - 2)

0 : Dur Run (OffDly)

The fan is switched on when a Run command is active.

The cooling fan stops after the delay time set to *L8-11* [HeatsinkCoolingFan Off DelayTime] elapses after releasing the Run command. This setting extends the fan lifetime.

1 : Always On

The fan runs when power is supplied to the drive.

2 : Fan ON in heating of Drive

The fan runs when drive main circuit overheat is detected.

■ L8-11: HeatsinkCoolingFan Off DelayTime

No. (Hex.)	Name	Description	Default Setting (Range)
L8-11 (04B7)	HeatsinkCoolingFan Off DelayTime	V/f CL-V/f OLV CLV AOLV OLV/PM AOLV/PM CLV/PM EZOLV Sets the delay time that occurs before the cooling fan is stopped after the run command is canceled when <i>L8-10</i> = 0 [Heatsink Cooling Fan Ope Select = Dur Run (OffDly)].	60 s (0 - 300 s)

■ L8-12: Ambient Temperature Setting

No. (Hex.)	Name	Description	Default (Range)
L8-12 (04B8)	Ambient Temperature Setting	V/f CL-V/f OLV CLV AOLV OLV/PM AOLV/PM CLV/PM EZOLV Sets the ambient temperature of the area where the drive is installed.	40 °C (-10 to 50 °C)

The drive rated current is automatically adjusted to the optimal value in accordance with the set temperature. Set the ambient temperature of the area where the drive is installed to a value greater than the drive rating.

■ L8-15: oL2 Characteristics Sel atLowSpd

No. (Hex.)	Name	Description	Default (Range)
L8-15 (04BB)	oL2 Characteristics Sel atLowSpd	V/f CL-V/f OLV CLV AOLV OLV/PM AOLV/PM CLV/PM EZOLV Selects whether the drive overload capability is reduced at low speeds to prevent <i>oL2</i> [Drive Overloaded] to protect the main circuit transistor in the drive during low speed operation (at 6 Hz or less).	1 (0, 1)

Note:

Contact Yaskawa or your nearest sales representative for consultation before disabling this function at low speeds. Frequent operation of drives under conditions of high output current in low speed ranges may shorten the service life of the drive IGBT due to heat stress.

0 : Disabled

The overload protection level is not reduced.

1 : Enabled

The overload protection level is automatically reduced when *oL2* is detected during low speed operation.

At zero speed, the overload is derated by 50%.

■ **L8-18: Software Current Limit Selection**

No. (Hex.)	Name	Description	Default Setting (Range)
L8-18 (04BE)	Software Current Limit Selection	<div style="display: flex; justify-content: space-between; font-size: small;"> V/f CL-V/f OLV CLV AOLV OLV/PM AOLV/PM CLV/PM EZOLV </div> <p>Enables or disables the software current limit selection used to protect the main circuit transistor from significant current.</p>	0 (0, 1)

0 : Disabled

The output voltage is not limited when the output current reaches the software current limit value.

Note:

The drive may detect an *oC* [*Overcurrent*] when loads are particularly heavy or the acceleration time is particularly short.

1 : Enabled

The drive reduces output voltage to reduce output current when the output current reaches the software current limit value.

The drive starts normal operation when the output current lowers to the software current limit level.

■ **L8-19: FreqReductRateDuringOH Pre-Alarm**

No. (Hex.)	Name	Description	Default (Range)
L8-19 (04BF)	FreqReductRateDurin gOH Pre-Alarm	<div style="display: flex; justify-content: space-between; font-size: small;"> V/f CL-V/f OLV CLV AOLV OLV/PM AOLV/PM CLV/PM EZOLV </div> <p>Sets the ratio at which the frequency reference is derated when the <i>oH</i> alarm is output.</p>	0.8 (0.1 to 0.9)

Enabled when both of the following conditions are satisfied.

- *L8-03 = 4* [*Overheat Pre-Alarm Ope Selection = Run@L8-19 Rate*] is set
- *oH* alarm is output

■ **L8-20: CF/STPo Fault Detection Select**

No. (Hex.)	Name	Description	Default Setting (Range)
L8-20 (04C0)	CF SELECT	<div style="display: flex; justify-content: space-between; font-size: small;"> V/f CL-V/f OLV CLV AOLV OLV/PM AOLV/PM CLV/PM EZOLV </div> <p>Selects the operation when <i>CF</i> faults are detected when <i>A1-02 = 4</i> [<i>Control Method Selection = Advanced OpenLoop Vector Control</i>].</p>	1 (0 - 2)

CF is detected when the state in which operation cannot be stopped continues even though the stop command has been input.

0 : Detection disabled

1 : Detects *CF* [*Control Fault*], and then the drive coasts to stop.

2 : Detects *CF* [*Control Fault*], and then the drive stops DC injection braking.

The DC injection braking is stopped in accordance with the setting value of *b2-03* [*DC Inject Braking Time at Start*].

Note:

- Control is unstable if the Rotational Auto-Tuning process is not executed when *A1-02 = 4*. In such cases, *CF* issues may be detected when ramping to stop. If a *CF* fault is detected, check whether or not the Rotational Auto-Tuning process was executed. In addition, perform the Line-to-Line Resistance Tuning process.
- Depending on load conditions, operation may not stop and *CF* issues may be detected if the stop command is input while the motor is rotating on the load side while using torque control via a setting of *A1-02 = 4*. Confirm that the Rotational Auto-Tuning and Line-to-Line Resistance Tuning processes were performed correctly and then set *L8-20 = 0*.

■ L8-27: Overcurrent Detection Gain

No. (Hex.)	Name	Description	Default (Range)
L8-27 (04DD)	Overcurrent Detection Gain	<input type="checkbox"/> V/f <input type="checkbox"/> CL-V/f <input type="checkbox"/> OLV <input type="checkbox"/> CLV <input type="checkbox"/> AOLV <input checked="" type="checkbox"/> OLV/PM <input checked="" type="checkbox"/> AOLV/PM <input checked="" type="checkbox"/> CLV/PM <input checked="" type="checkbox"/> EZOLV Sets the PM motor overcurrent detection level as a percentage of the motor rated current value.	300.0% (0.0 - 400.0%)

When the drive rated current is considerably higher than the motor rated current, PM motor magnets may demagnetize when current flows at the drive overcurrent detection level. To prevent motor demagnetization, the overcurrent detection level is adjusted when set to a low value.

Note:

The overcurrent detection function detects whichever of the following values is lower.

- Drive overcurrent level
- Motor rated current \times L8-27 / 100

■ L8-29: Current Unbalance Detect (LF2)

No. (Hex.)	Name	Description	Default Setting (Range)
L8-29 (04DF)	Current Unbalance Detect (LF2)	<input type="checkbox"/> V/f <input type="checkbox"/> CL-V/f <input type="checkbox"/> OLV <input type="checkbox"/> CLV <input type="checkbox"/> AOLV <input checked="" type="checkbox"/> OLV/PM <input checked="" type="checkbox"/> AOLV/PM <input checked="" type="checkbox"/> CLV/PM <input checked="" type="checkbox"/> EZOLV Enables or disables the detection of LF2.	1 (0, 1)

This function protects PM motors. Current unbalance can heat a PM motor and demagnetize the magnets. LF2 is detected when the current is in an unbalanced state, which stops the motor to prevent motor damage.

0 : Disabled

1 : Enabled

■ L8-31: LF2 Detection Time

No. (Hex.)	Name	Description	Default Setting (Range)
L8-31 (04E1)	LF2 Detection Time	<input type="checkbox"/> V/f <input type="checkbox"/> CL-V/f <input type="checkbox"/> OLV <input type="checkbox"/> CLV <input type="checkbox"/> AOLV <input checked="" type="checkbox"/> OLV/PM <input checked="" type="checkbox"/> AOLV/PM <input checked="" type="checkbox"/> CLV/PM <input checked="" type="checkbox"/> EZOLV Sets the LF2 [Output Current Imbalance] detection time.	3 (1 to 100)

LF2 faults are detected when the output current is imbalanced longer than the time set with L8-31.

Note:

- Parameter L8-31 is enabled when L8-29 = 1 [Current Unbalance Detect (LF2) = Enabled].
- When misdetections of LF2 occur, increase the setting value of L8-31 in increments of 5 to make adjustments.
- Parameter L8-31 appears only when E9-01 = 1 [Motor Type Selection = PM] under EZ Open Loop Vector Control.

■ L8-32: Cooling Fan Failure Selection

No. (Hex.)	Name	Description	Default Setting (Range)
L8-32 (04E2)	Cooling Fan Failure Selection	<input type="checkbox"/> V/f <input type="checkbox"/> CL-V/f <input type="checkbox"/> OLV <input type="checkbox"/> CLV <input type="checkbox"/> AOLV <input checked="" type="checkbox"/> OLV/PM <input checked="" type="checkbox"/> AOLV/PM <input checked="" type="checkbox"/> CLV/PM <input checked="" type="checkbox"/> EZOLV Selects the drive operation when FAn [Internal Agitating Fan Fault] occurs.	1 (0 to 4)

0 : Ramp to Stop

The drive ramps the motor to stop according to the deceleration time. The terminal turns on when H2-xx = E [MFDO Function Select = Fault] is set.

1 : Coast to Stop

The drive shuts off output and the motor coasts to stop. The terminal turns on when H2-xx = E.

2 : Fast-Stop

The drive stops the motor using the deceleration time set with C1-09 [Fast Stop Time]. The terminal turns on when H2-xx = E.

3 : Alarm Only

FAn appears on the keypad, and the drive continues operating. The terminal turns on when H2-xx = 10 [MFDO Function Select = Minor Fault].

4 : Run@L8-19 Rate

The drive performs deceleration to the level set in L8-19 [Freq Reduct Rate During OH Pre-Alarm] and continues operation. FAn flashes on the keypad. Refer to “L8-03: Overheat Pre-Alarm Ope Selection” for more information on drive derating operation.

■ L8-35: Installation Method Selection

No. (Hex.)	Name	Description	Default Setting (Range)
L8-35 (04EC)	Installation Method Selection	<div style="display: flex; justify-content: space-between; font-size: small;"> V/f CL-V/f OLV CLV AOLV OLV/PM AOLV/PM CLV/PM EZOLV </div> Selects the type of drive installation.	Determined by o2-04 (0 - 3)

Note:

- This parameter is not initialized by A1-03 [Initialize Parameters].
- The value is preset to the appropriate value when the drive is shipped. Change the value only when using Side-by-Side installation or when mounting a standard drive with the heatsink outside the enclosure panel.

The overload protection detection level for the drive is automatically adjusted to the optimal value in accordance with the setting value. Change this setting when drives are installed Side-by-Side or when mounting a standard drive with the heatsink outside the enclosure panel.

0 : IP20/Open-Chassis enclosure

Select this setting when installing the IP20 open type enclosure drive.

Ensure that there is at least 30 mm of space between drives or between the drive and side of the enclosure panel.

1 : Side-by-Side mounting

Select this setting when multiple drives are installed Side-by-Side.

When installing drives Side-by-Side, the minimum space between drives can be as small as 2 mm.

2 : IP20/UL Type 1/IP55

Select this setting when installing UL Type 1 enclosed wall-mounted type drives or IP55 drives.

3 : Finless/Fin Ext

Select this setting when installing finless type drives or when the cooling fin (heatsink) is external to the enclosure panel.

■ L8-38: Carrier Frequency Reduction

No. (Hex.)	Name	Description	Default (Range)
L8-38 (04EF)	Carrier Frequency Reduction	<div style="display: flex; justify-content: space-between; font-size: small;"> V/f CL-V/f OLV CLV AOLV OLV/PM AOLV/PM CLV/PM EZOLV </div> Selects the operation of the carrier frequency reduction function. The carrier frequency is reduced when the output current exceeds a specific level.	Determined by A1-02, C6-01, and o2-04 (0 - 2)

As lowering the carrier frequency raises the overload tolerance, the overload capacity is increases temporarily for oL2 [Drive Overloaded], allowing the drive to run through transient load peaks without tripping.

0 : Disabled

No carrier frequency reduction at high current.

1 : Enabled below 6 Hz

The carrier frequency is reduced at speeds below 6 Hz when the current exceeds 100% of the drive rated current.

The drive returns to the normal carrier frequency when the current falls below 88% or the output frequency exceeds 7 Hz.

2 : Enabled for the EntireSpeedRange

The carrier frequency is reduced at the following speeds:

- Output current is at least 100% of the drive rated current while the frequency reference is lower than 6 Hz.
- Output current is at least 109% of the drive rated current while ND rating is selected and the frequency reference is 7 or more Hz.
- Output current is at least 112% of the drive rated current while HD rating is selected and the frequency reference is 7 or more Hz.

The drive uses the delay time set in L8-40 [CarrierFreqReduct Off DelayTime] and a hysteresis of 12% when switching the carrier frequency back to the set value.

■ L8-40: CarrierFreqReduct Off DelayTime

No. (Hex.)	Name	Description	Default (Range)
L8-40 (04F1)	CarrierFreqReduct Off DelayTime	<input type="checkbox"/> V/f <input type="checkbox"/> CL-V/f <input type="checkbox"/> OLV <input type="checkbox"/> CLV <input type="checkbox"/> AOLV <input type="checkbox"/> OLV/PM <input type="checkbox"/> AOLV/PM <input type="checkbox"/> CLV/PM <input type="checkbox"/> EZOLV Sets the time (off delay time) taken for the automatically reduced carrier frequency to return to the state before the reduction.	Determined by A1-02 (0.00 - 2.00 s)

When *L8-40* is set to a value other than 0.00, the carrier frequency reduction function is enabled during startup. The carrier frequency is automatically reduced when operation starts. After the time set in *L8-40* elapses, the carrier frequency returns to the value set in *C6-02* [*Carrier Frequency Selection*].

When *L8-38* = 1, 2 [*Carrier Frequency Reduction = Enabled*], *L8-40* is also applied as the time taken for the carrier frequency to return to its configured value after being reduced.

■ L8-41: High Current Alarm Selection

No. (Hex.)	Name	Description	Default (Range)
L8-41 (04F2)	High Current Alarm Selection	<input type="checkbox"/> V/f <input type="checkbox"/> CL-V/f <input type="checkbox"/> OLV <input type="checkbox"/> CLV <input type="checkbox"/> AOLV <input type="checkbox"/> OLV/PM <input type="checkbox"/> AOLV/PM <input type="checkbox"/> CLV/PM <input type="checkbox"/> EZOLV Triggers an <i>HCA</i> [<i>Current Alarm</i>] when the output current exceeds 150% of the drive rated current.	0 (0, 1)

0 : Disabled

An *HCA* is not detected.

1 : Enabled

An *HCA* is triggered when the output current exceeds 150% of the drive rated current.

The MFDO terminal set for an alarm [*H2-01 to H2-04* = 10] turns on.

■ L8-51: STPo I Detection Level

No. (Hex.)	Name	Description	Default Setting (Range)
L8-51 (0471)	STPo I Detection Level	<input type="checkbox"/> V/f <input type="checkbox"/> CL-V/f <input type="checkbox"/> OLV <input type="checkbox"/> CLV <input type="checkbox"/> AOLV <input type="checkbox"/> OLV/PM <input type="checkbox"/> AOLV/PM <input type="checkbox"/> CLV/PM <input type="checkbox"/> EZOLV Sets the <i>STPo</i> [<i>Desynchronization Error</i>] on the basis of the output current.	0.0% (0.0 - 300.0%)

Note:

The detection level is automatically calculated when *L8-51* = 0.

■ L8-52: STPo Integration Level

No. (Hex.)	Name	Description	Default Setting (Range)
L8-52 (0472)	STPo Integration Level	<input type="checkbox"/> V/f <input type="checkbox"/> CL-V/f <input type="checkbox"/> OLV <input type="checkbox"/> CLV <input type="checkbox"/> AOLV <input type="checkbox"/> OLV/PM <input type="checkbox"/> AOLV/PM <input type="checkbox"/> CLV/PM <input type="checkbox"/> EZOLV Sets the detection level for <i>STPo</i> [<i>Desynchronization Error</i>] on the basis of the ACR integral value.	1.0 (0.1 - 2.0)

■ L8-53: STPo Integration Time

No. (Hex.)	Name	Description	Default Setting (Range)
L8-53 (0473)	STPo Integration Time	<input type="checkbox"/> V/f <input type="checkbox"/> CL-V/f <input type="checkbox"/> OLV <input type="checkbox"/> CLV <input type="checkbox"/> AOLV <input type="checkbox"/> OLV/PM <input type="checkbox"/> AOLV/PM <input type="checkbox"/> CLV/PM <input type="checkbox"/> EZOLV Sets the time until <i>STPo</i> is detected after the value of <i>L8-51</i> [<i>STPo I Detection Level</i>] is exceeded.	1.0 s (1.0 - 10.0 s)

■ L8-54: STPo Id Diff Detection

No. (Hex.)	Name	Description	Default Setting (Range)
L8-54 (0474)	STPo Id Diff Detection	<input type="checkbox"/> V/f <input type="checkbox"/> CL-V/f <input type="checkbox"/> OLV <input type="checkbox"/> CLV <input type="checkbox"/> AOLV <input type="checkbox"/> OLV/PM <input type="checkbox"/> AOLV/PM <input type="checkbox"/> CLV/PM <input type="checkbox"/> EZOLV Enables or disables the Id deviation detection function for <i>STPo</i> [<i>Desynchronization Error</i>].	1 (0, 1)

0 : Disabled

1 : Enabled

■ L8-55: InternalBrakingTransistorProtect

No. (Hex.)	Name	Description	Default (Range)
L8-55 (045F)	InternalBrakingTransistorProtect	<div style="display: flex; justify-content: space-between; font-size: 0.8em; font-weight: normal;"> V/f CL-V/f OLV CLV AOLV OLV/PM AOLV/PM CLV/PM EZOLV </div> Enables or disables protection for the internal braking transistor.	1 (0, 1)

0 : Disable

Disables braking transistor protection.

Use this setting in the following situation. Enabling the braking transistor in the following situations may cause an *rF [Braking Resistor Fault]*.

- When using a regenerative converter, such as the D1000.
- When using a regenerative unit, such as the R1000.
- When connecting braking resistor options to the drive, such as CDBR units.
- When using no internal braking transistor.

1 : Protection enabled

Protects internal braking transistor when using a braking transistor or optional braking resistors.

The following models have a built-in braking transistor .

- 2004 to 2138
- 4002 to 4168

■ L8-56: Stl Act Time

No. (Hex.)	Name	Description	Default Setting (Range)
L8-56 (047D)	Stl Act Time	<div style="display: flex; justify-content: space-between; font-size: 0.8em; font-weight: normal;"> V/f CL-V/f OLV CLV AOLV OLV/PM AOLV/PM CLV/PM EZOLV </div> Sets the time that the acceleration stall prevention function can continue to operate, after which the <i>STPo [Desynchronization Error]</i> is detected.	5000 ms (100 - 5000 ms)

Note:

If the set time for *L8-56* is too low, *STPo* misdetections may occur. If the set time for *L8-56* is too high, *STPo* detection may stop functioning.

■ L8-57: Stl Retry Count

No. (Hex.)	Name	Description	Default Setting (Range)
L8-57 (047E)	Stl Retry Count	<div style="display: flex; justify-content: space-between; font-size: 0.8em; font-weight: normal;"> V/f CL-V/f OLV CLV AOLV OLV/PM AOLV/PM CLV/PM EZOLV </div> Sets the number of times the acceleration stall prevention function can operate until speeds match, after which the <i>STPo "Desynchronization Error"</i> is detected.	10 times (1 to 10 times)

Note:

If the number of operations for *L8-57* is too low, *STPo* misdetections may occur. If the number of operations for *L8-57* is too high, *STPo* detection may stop functioning.

■ L8-90: STPo Detection Level

No. (Hex.)	Name	Description	Default Setting (Range)
L8-90 (0175)	STPo Detection Level	<div style="display: flex; justify-content: space-between; font-size: 0.8em; font-weight: normal;"> V/f CL-V/f OLV CLV AOLV OLV/PM AOLV/PM CLV/PM EZOLV </div> <i>STPo [Desynchronization Error]</i> is detected when the control fault reaches the detection level of <i>L8-90</i> .	Determined by A1-02 (0 to 5000 times)

This function detects the desynchronization state of PM motors.

Desynchronization due to motor locks cannot be detected when the frequency reference is low during startup while the motor is locked. If fault detection is necessary in environments with potential for startups in these conditions, set the control fault detection level to enable detection of desynchronization due to motor locking. Increase the setting in increments of 5.

■ L8-93: LSo Detection Time at Low Speed

No. (Hex.)	Name	Description	Default Setting (Range)
L8-93 (073C)	LSo Detection Time at Low Speed	V/f CL-V/f OLV CLV AOLV OLV/PM AOLV/PM CLV/PM EZOLV Sets the time before baseblock is executed after <i>LSo</i> [<i>LSo Fault</i>] is detected.	1.0 s (0.0 - 10.0 s)

Setting this parameter to 0.0 seconds disables detection low speed desynchronization.

■ L8-94: LSo Detection Level at Low Speed

No. (Hex.)	Name	Description	Default Setting (Range)
L8-94 (073D)	LSo Detection Level at Low Speed	V/f CL-V/f OLV CLV AOLV OLV/PM AOLV/PM CLV/PM EZOLV Sets the detection level for <i>LSo</i> [<i>LSo Fault</i>] as a percentage of <i>E1-04</i> [<i>Maximum Output Frequency</i>].	3% (0 - 10%)

■ L8-95: Average LSo Freq at Low Speed

No. (Hex.)	Name	Description	Default Setting (Range)
L8-95 (077F)	Average LSo Freq at Low Speed	V/f CL-V/f OLV CLV AOLV OLV/PM AOLV/PM CLV/PM EZOLV Sets the average count of <i>LSo</i> [<i>LSo Fault</i>] detections.	10 times (1 to 50 times)

◆ L9: Drive Protection 2

L9 parameters are used to configure the protection function used to detect cooling fan faults.

■ L9-16: FAn1 Detection Time

No. (Hex.)	Name	Description	Default (Range)
L9-16 (11DC)	FAn1 Detection Time	V/f CL-V/f OLV CLV AOLV OLV/PM AOLV/PM CLV/PM EZOLV Sets the detection time for <i>FAn1</i> [<i>Drive Cooling Fan Failure</i>]. Do not change the value of this parameter unless absolutely necessary.	4.0 s (0.0 to 30.0 s)

11.10 n: Special Adjustment

n parameters are used to set the following functions.

- Hunting prevention function
- High-slip braking
- Motor line-to-line resistance online tuning
- Fine tune the parameters that adjust motor control

◆ n1: Hunting Prevention Function

Hunting Prevention prevents the drive from hunting as a result of low inertia or operating with light load. Hunting often occurs with a high carrier frequency and an output frequency below 30 Hz.

■ n1-01: Hunting Prevention Selection

No. (Hex.)	Name	Description	Default (Range)
n1-01 (0580)	Hunting Prevention Selection	V/f CL-V/f OLV CLV AOLV OLV/PM AOLV/PM CLV/PM EZOLV Enables or disables the hunting prevention function.	1 (0 - 2)

Disable this function to prioritize responsiveness over motor vibration reduction.

If hunting occurs, or when a high carrier frequency or SwingPWM is being used, greater suppression of hunting can be obtained by selecting $n1-01 = 2$.

0 : Disabled

1 : Enabled

2 : Enable (High carry)

■ n1-02 Hunting Prevention Gain Setting

No. (Hex.)	Name	Description	Default Setting (Range)
n1-02 (0581)	Hunting Prevention Gain Setting	V/f CL-V/f OLV CLV AOLV OLV/PM AOLV/PM CLV/PM EZOLV Adjusts the behavior of the hunting prevention function. Normally there is no need to configure this setting.	1.00 (0.00 - 2.50)

Adjust this parameter in the following circumstances.

- With settings of $n1-01 = 1, 2$ [*Hunting Prevention Selection = Enabled, Enable (High carry)*]: If oscillation occurs when operating a motor with a light load, increase the setting value in increments of 0.1.
- With settings of $n1-01 = 1, 2$, if the motor stalls: Reduce the setting value in increments of 0.1.

■ n1-03: Hunting Prevention Time Constant

No. (Hex.)	Name	Description	Default Setting (Range)
n1-03 (0582)	Hunting Prevention Time Constant	V/f CL-V/f OLV CLV AOLV OLV/PM AOLV/PM CLV/PM EZOLV Adjusts the responsiveness (primary delay time constant) of the hunting prevention function. Normally there is no need to configure this setting.	Determined by o2-04 (0 - 500 ms)

Adjust this parameter in the following circumstances.

- Load inertia is great: Increase the setting value. However, response will be slower if the setting value is too high. Also, since the frequency is low, oscillation will occur.
- Oscillation occurs at low frequencies: Reduce the setting value.

■ n1-05: Hunting Prevention Gain while in Rev

No. (Hex.)	Name	Description	Default Setting (Range)
n1-05 (0530)	Hunting Prevention Gain while in Rev	V/f CL-V/f OLV CLV AOLV OLV/PM AOLV/PM CLV/PM EZOLV Adjusts the behavior of the hunting prevention function. Used to adjust Reverse run. Normally there is no need to configure this setting.	0.00 (0.00 - 2.50)

Note:

With a setting of $n1-05 = 0$, the value set in $n1-02$ [*Hunting Prevention Gain Setting*] will be effective even when the motor rotates in reverse.

Adjust this parameter in the following circumstances.

- With settings of $n1-01 = 1, 2$ [*Hunting Prevention Selection = Enabled, Enable (High carry)*]: If oscillation occurs when operating a motor with a light load, increase the setting value in increments of 0.1.
- With settings of $n1-01 = 1, 2$, if the motor stalls: Reduce the setting value in increments of 0.1.

■ n1-08: Leak cur antivib

No. (Hex.)	Name	Description	Default Setting (Range)
n1-08 (1105)	Leak cur antivib	<div style="display: flex; justify-content: space-between; font-size: 0.8em; font-weight: bold; margin-bottom: 5px;"> V/f CL-V/f OLV CLV AOLV OLV/PM AOLV/PM CLV/PM EZOLV </div> Selects the method of suppressing motor vibration caused by leakage current. Normally there is no need to configure this setting.	0 (0, 1)

0 : Method1

1 : Method2

Note:

The $n1-08 = 1$ setting is effective in suppressing motor vibrations due to leakage current when the wiring distance is long.

■ n1-13: DC Bus Stabilization Control

No. (Hex.)	Name	Description	Default Setting (Range)
n1-13 (1B59)	DC Bus Stabilization Control	<div style="display: flex; justify-content: space-between; font-size: 0.8em; font-weight: bold; margin-bottom: 5px;"> V/f CL-V/f OLV CLV AOLV OLV/PM AOLV/PM CLV/PM EZOLV </div> Enables or disables the oscillation suppression function for the DC bus voltage.	0 (0, 1)

0 : Disabled

1 : Enabled

Note:

Set $n1-13 = 1$ when the DC bus voltage does not stabilize with light loads and *ov* [*Overvoltage*] is detected.

■ n1-14: DC Bus Stabilization Time

No. (Hex.)	Name	Description	Default Setting (Range)
n1-14 (1B5A)	DC Bus Stabilization Time	<div style="display: flex; justify-content: space-between; font-size: 0.8em; font-weight: bold; margin-bottom: 5px;"> V/f CL-V/f OLV CLV AOLV OLV/PM AOLV/PM CLV/PM EZOLV </div> With a setting of $n1-13 = 1$ [<i>DC Bus Stabilization Control = Enabled</i>], adjustments that address a lack of oscillation suppression capability with respect to the DC bus voltage can be made.	100.0 ms (50.0 - 500.0 ms)

Note:

To adjust, increase $n1-14$ in increments of 100 ms.

■ n1-15: Voltage Calibration Select

No. (Hex.)	Name	Description	Default Setting (Range)
n1-15 (0BF8)	Voltage Calibration Select	<div style="display: flex; justify-content: space-between; font-size: 0.8em; font-weight: bold; margin-bottom: 5px;"> V/f CL-V/f OLV CLV AOLV OLV/PM AOLV/PM CLV/PM EZOLV </div> Selects the calibration method to be used for the suppression of torque/current ripple.	1 (0 - 2)

This calibration function allows for the suppression of a motor's torque ripple. Normally there is no need to change this setting.

0 : Calibration Invalid

1 : Calibrate only 1 time

2 : Calibrate every time

■ n1-16: High carry Hunt Prev Gain

No. (Hex.)	Name	Description	Default Setting (Range)
n1-16 (0BFB)	High carry Hunt Prev Gain	<div style="display: flex; justify-content: space-between; font-size: 0.8em; margin-bottom: 5px;"> V/f CL-V/f OLV CLV AOLV OLV/PM AOLV/PM CLV/PM EZOLV </div> Adjusts the behavior of the hunting prevention function. This is most effective when a high carrier frequency has been set. Normally there is no need to configure this setting.	0.50 (0.00 - 2.50)

Effective with a setting of $n1-01 = 2$ [Hunting Prevention Selection = Enable (High carry)].

If the motor oscillates, set $n1-01 = 2$. If there is no discernible effect, increase $n1-16$ in increments of 0.2.

■ n1-17: Hunt Prev Time

No. (Hex.)	Name	Description	Default Setting (Range)
n1-17 (0BFC)	Hunt Prev Time	<div style="display: flex; justify-content: space-between; font-size: 0.8em; margin-bottom: 5px;"> V/f CL-V/f OLV CLV AOLV OLV/PM AOLV/PM CLV/PM EZOLV </div> Adjusts the responsiveness of the hunting prevention function. Normally there is no need to configure this setting.	500 ms (0 - 1000 ms)

When set to $n1-01 = 2$ [Hunting Prevention Selection = Enable (High carry)], if the motor stalls when the load changes, increase the value set in $n1-17$ in increments of 100 ms.

If hunting cannot be suppressed even when set to $n1-01 = 2$, increase the value set in $n1-17$ in increments of 100 ms.

◆ n2: Speed Feedback Detection Control (AFR) Tuning

The speed feedback detection reduction function (or AFR: Automatic Frequency Regulator) helps achieve speed stability when a load is suddenly applied or removed.

Note:

Perform either of the following procedures before changing $n2-xx$.

- Set the motor parameters and V/f pattern correctly.
- Perform Rotational Auto-Tuning.

■ n2-01: SpdFeedbackDetectCtr (AFR) Gain

No. (Hex.)	Name	Description	Default (Range)
n2-01 (0584)	SpdFeedbackDetectCtr (AFR) Gain	<div style="display: flex; justify-content: space-between; font-size: 0.8em; margin-bottom: 5px;"> V/f CL-V/f OLV CLV AOLV OLV/PM AOLV/PM CLV/PM EZOLV </div> This parameter sets the gain of the AFR function as a magnification value. Normally there is no need to change this setting.	1.00 (0.00 - 10.00)

Adjust in the following situations.

- If hunting or oscillation occurs under light loads, increase the setting value in steps of 0.05 while checking the response.
- When torque is insufficient under heavy loads or to improve torque or speed responsiveness, decrease the setting value in steps of 0.05 while checking the response.

■ n2-02: SpdFeedbackDetCtr(AFR)TimeConst1

No. (Hex.)	Name	Description	Default Setting (Range)
n2-02 (0585)	SpdFeedbackDetCtr (AFR)TimeConst1	<div style="display: flex; justify-content: space-between; font-size: 0.8em; margin-bottom: 5px;"> V/f CL-V/f OLV CLV AOLV OLV/PM AOLV/PM CLV/PM EZOLV </div> This parameter sets the time constant that determines the rate of change for the AFR function. Normally there is no need to change this setting.	50 ms (0 - 2000 ms)

Adjust in the following situations.

- If hunting or oscillation occurs under light loads, increase the setting value in steps of 50 ms while checking the response. Increase the setting value in steps of 50 ms while checking the response when the load inertia is significant.
- When torque is insufficient under heavy loads or to improve torque or speed responsiveness, decrease the setting value in steps of 10 ms while checking the response.

Note:

- Set $n2-02 \leq n2-03$ [*SpdFeedbackDetCtr(AFR)TimeConst2*]. Setting $n2-02 > n2-03$ causes *oPE08 [Parameter Selection Error]*
- When changing the value set in $n2-02$, also change the value set in $C4-02$ [*Torque Compensation Delay Time*] according to the same ratio.

■ n2-03: SpdFeedbackDetCtr(AFR)TimeConst2

No. (Hex.)	Name	Description	Default Setting (Range)
n2-03 (0586)	SpdFeedbackDetCtr(AFR)TimeConst2	<div style="display: flex; justify-content: space-between; font-size: small;"> V/f CL-V/f OLV CLV AOLV OLV/PM AOLV/PM CLV/PM EZOLV </div> <p>This parameter sets the time constant that determines the variation in speed of the AFR function. Use this parameter when performing speed searches or regeneration. Normally there is no need to change this setting.</p>	750 ms (0 - 2000 ms)

Adjust in the following situations.

- Increase the setting value in steps of 50 ms if *ov [Overvoltage]* occur when acceleration ends under high-inertia loads.
Increase the setting value in steps of 50 ms when *ov* occurs while loads suddenly change.
- Decrease the setting value in steps of 10 ms while checking responsiveness to improve responsiveness of torque and speed.

Note:

- Set $n2-03$ so that it is larger than the value set in $n2-02$ [*SpdFeedbackDetCtr(AFR)TimeConst1*]. Setting $n2-02$ higher than $n2-03$ will trigger an *oPE08 [Parameter Selection Error]*.
- When the value set in $n2-03$ is changed, also change the value set in $C4-06$ [*Motor 2 Torque Comp Delay Time*] according to the same ratio.

◆ n3: High Slip Braking (HSB) and Overexcitation Braking

$n3$ parameters are used to configure the High Slip Braking and Overexcitation Deceleration.

■ High-Slip Braking

High slip braking is used to quickly decelerate motors without connecting braking resistors to the drive.

This enables motors to be stopped more quickly than with normal ramp to stop processes. This function is optimal for applications in which motors are stopped infrequently such as the fast stop function for high-inertia loads. Braking starts when the multi-function digital input for which *High Slip Braking (HSB) [H1-xx = 68]* is set is turned on.

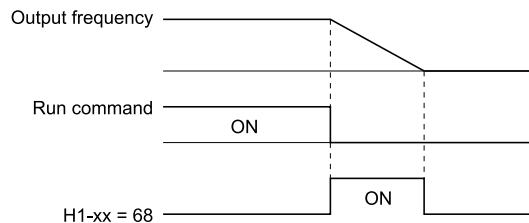

Figure 11.138 High Slip Braking Time Chart

High slip braking is effective with induction motors. High slip braking is enabled when parameter $A1-02$ [*Control Method Selection*] is set to any of the following.

- 0 [V/f Control]
- 1 [Closed Loop V/f Control]

Principles of Operation

HSB significantly decreases the frequency supplied to the motor simultaneously with the start of deceleration to increase motor slip. A significant amount of current flows through the motor to increase the motor loss, and the motor decelerates while the motor windings consumes the generated regenerative energy.

Motor current is maintained at a constant level during deceleration to prevent overvoltage and perform automatic braking while maintaining a level of slip that creates the maximum amount of deceleration torque.

High Slip Braking Usage Precautions

- Do not use the high slip braking function for the following applications.
 - Frequent deceleration
 - Deceleration time variance when performing high slip braking

- Continuous regenerative loads
- Reacceleration is required during deceleration
- Motor loss increases during the high slip braking process. Use this function under conditions of duty time factors of 5% ED or less and braking times of 90 seconds or less. Braking time varies depending on the load inertia and motor characteristics.
- The configured deceleration time is ignored during the high slip braking process. To stop motors in accordance with the configured deceleration time, set $L3-04 = 4$ [*Decel Stall Prevention Selection = Overexcitation/High Flux*].
- High slip braking cannot be used to perform deceleration at user-defined speeds. To perform deceleration at user-defined speeds, use the overexcitation deceleration function.
- Motors cannot be reaccelerated during the high slip braking process until the motor has stopped completely and the Run command is input again.
- High slip braking and the KEB Ride-Thru function cannot be used simultaneously. If both functions are enabled, $oPE03$ [*Multi-Function Input Setting Err*] is detected.

■ Overexcitation Deceleration

Overexcitation deceleration is used to quickly decelerate motors without connecting braking resistors to the drive. Overexcitation deceleration enables motors to be stopped more quickly than with normal ramp to stop processes. Overexcitation deceleration generates significant braking torque through motor overexcitation by increasing excitation current during deceleration.

The deceleration time can be adjusted for overexcitation deceleration by specifying the deceleration speed. Reacceleration of motors can also be performed during deceleration. Entering the Run command during overexcitation deceleration cancels overexcitation deceleration and the drive reaccelerates to the specified speed. To enable this function, set $L3-04 = 4, 5$ [*Decel Stall Prevention Selection = Overexcitation/High Flux, Overexcitation/High Flux 2*].

When $L3-04 = 4$, motors decelerate for the currently valid deceleration time [$C1-02$, $C1-04$, $C1-06$, or $C1-08$]. Increase the deceleration time when ov [*Overvoltage*] occurs.

When $L3-04 = 5$, the drive decelerates using the [$C1-02$, $C1-04$, $C1-06$, or $C1-08$] while adjusting the deceleration rate to keep the DC bus voltage at the level set to $L3-17$ [*DC Bus Reg Level*]. The actual stopping time will be longer or shorter than the set deceleration time depending on the motor characteristics and the load inertia.

Notes on Overexcitation Deceleration

- Do not use Overexcitation Deceleration in combination with a braking resistor option.
- Do not use Overexcitation Deceleration for the following applications. Connect a braking resistor to the drive instead of using Overexcitation Deceleration.
 - Frequent repetition of sudden decelerations
 - Continuous regenerative loads
 - Low inertia machines
 - Machines that have no tolerance for torque ripples
- Motor loss increases during overexcitation deceleration. Use this function under conditions of duty time factors of 5% ED or less and braking times of 90 s or less. Braking time varies depending on the load inertia and motor characteristics.
- Overexcitation deceleration can be used with OLV control and CLV control, but cannot provide as significant effect as V/f Control because it needs to secure torque accuracy.
- The following functions are disabled during braking using Overexcitation Deceleration 2, depending on the control mode combined.
 - Hunting Prevention Function (V/f Control Mode)
 - Torque Limit Speed Control (Open Loop Vector Control Mode)

■ n3-01: HSB Deceleration Frequency Width

No. (Hex.)	Name	Description	Default (Range)
n3-01 (0588)	HSB Deceleration Frequency Width	<div style="display: flex; justify-content: space-between; font-size: 0.8em; font-weight: bold;"> V/f CL-V/f OLV CLV AOLV OLV/PM AOLV/PM CLV/PM EZOLV </div> <p>Sets the amount by which the output frequency is to be lowered during high-slip braking, as a percentage of <i>E1-04 [Maximum Output Frequency]</i>, which represents the 100% value.</p>	5% (1 - 20%)

Set a high value if detection of *ov [DC Bus Overvoltage]* during high-slip braking is desired.

■ n3-02: High-Slip Braking Current Limit

No. (Hex.)	Name	Description	Default Setting (Range)
n3-02 (0589)	High-Slip Braking Current Limit	<div style="display: flex; justify-content: space-between; font-size: 0.8em; font-weight: bold;"> V/f CL-V/f OLV CLV AOLV OLV/PM AOLV/PM CLV/PM EZOLV </div> <p>Sets the maximum current output during high-slip braking as a percentage of <i>E2-01 [Motor Rated Current (FLA)]</i>, which represents the 100% value. Set the current suppression so that the drive's overload tolerance is not exceeded.</p>	Determined by C6-01, L8-38 (0 - 200%)

When the setting value for current suppression is reduced, the deceleration time is extended.

- Set a low value if detection of *ov [DC Bus Overvoltage]* during high-slip braking is desired.
- If the motor current increases during high-slip braking, reduce the setting value to prevent burn damage in the motor.
- The drive's overload tolerance is 150% for Heavy Duty Rating (HD), and 110% for Normal Duty Rating (ND).

■ n3-03: HSB Dwell Time at Stop

No. (Hex.)	Name	Description	Default Setting (Range)
n3-03 (058A)	HSB Dwell Time at Stop	<div style="display: flex; justify-content: space-between; font-size: 0.8em; font-weight: bold;"> V/f CL-V/f OLV CLV AOLV OLV/PM AOLV/PM CLV/PM EZOLV </div> <p>This sets the dwell time, a period of time in which the motor has slowed down and runs at a steady speed, which occurs when the high-slip braking is nearing completion. For a predetermined amount of time only, the actual output frequency will be held at the minimum output frequency that was set for <i>E1-09</i>.</p>	1.0 s (0.0 - 10.0 s)

Increase the setting value if the inertia is excessive, or when the motor is coasting to a stop after high-slip braking has completed. If the setting value is too low, the motor may rotate slightly even after the high-slip braking has completed, due to the machine inertia.

■ n3-04: High-Slip Braking Overload Time

No. (Hex.)	Name	Description	Default Setting (Range)
n3-04 (058B)	High-Slip Braking Overload Time	<div style="display: flex; justify-content: space-between; font-size: 0.8em; font-weight: bold;"> V/f CL-V/f OLV CLV AOLV OLV/PM AOLV/PM CLV/PM EZOLV </div> <p>Sets the time used for detection of <i>oL7 [Motor Overload Protection During High Slip Braking]</i>, which is implemented at times when for some reason the output frequency did not change during high-slip braking. Normally there is no need to configure this setting.</p>	40 s (30 - 1200 s)

When the motor is being turned by the force at the load side, or an excessive amount of load inertia is connected to the motor, *oL7* is detected.

The current flowing to the motor as a result of the load causes overheating, which can lead to the burn damage of the motor. Set this to prevent burn damage to the motor.

■ n3-13: Overexcitation Deceleration Gain

No. (Hex.)	Name	Description	Default Setting (Range)
n3-13 (0531)	Overexcitation Deceleration Gain	<div style="display: flex; justify-content: space-between; font-size: 0.8em; font-weight: bold;"> V/f CL-V/f OLV CLV AOLV OLV/PM AOLV/PM CLV/PM EZOLV </div> <p>The overexcitation level is determined by multiplying the gain set by this parameter with the V/f pattern output value during overexcitation deceleration.</p>	1.10 (1.00 - 1.40)

The V/f pattern output value returns to normal levels after the motor stops or accelerates again to the frequency reference speed.

The optimal value of this parameter varies depending on the flux saturation characteristics of the motor.

- Gradually increase the value set to *n3-13* to 1.25 or 1.30 to improve the braking power of Overexcitation Deceleration. However, if the gain is excessive, the motor can experience flux saturation, causing a significant amount of current to flow. This may lengthen the deceleration time.
- Reduce the setting value if flux saturation causes overcurrent. Increasing the setting value may cause *oC* [Overcurrent], *oL1* [Motor Overload], and *oL2* [Drive Overloaded]. Reducing the value set to *n3-21* [High-SlipSuppression Current Lvl] can also prevent *oC* and *oL*.
- Repetitive use of overexcitation deceleration or extended periods of using the overexcitation deceleration function can cause internal motor temperatures to rise. Reduce the setting value in such circumstances.
- Increase the deceleration time setting when *ov* [Overvoltage] occurs.

■ **n3-14: HarmInj@HiFlxBrk**

No. (Hex.)	Name	Description	Default Setting (Range)
n3-14 (0532)	HarmInj@HiFlxBrk	<div style="display: flex; justify-content: space-between; font-size: small;"> V/f CL-V/f OLV CLV AOLV OLV/PM AOLV/PM CLV/PM EZOLV </div> Enables or disables the function that injects harmonic signals during overexcitation deceleration.	0 (0, 1)

Enable *n3-14* to set a shorter time for the deceleration time.

Note:

- Since motor loss increases, motors for which use of overexcitation deceleration is frequently repeated are exposed to the risk of burn damage.
- With a setting of *n3-14* = 1, the motor may emit a significant amount of excitation sound during overexcitation deceleration. If the large excitation sound is unacceptable, disable the function by setting *n3-14* = 0.

0 : Disabled

1 : Enabled

Harmonic signals are injected at the time of overexcitation deceleration. Since motor loss increases, the deceleration time can be reduced.

■ **n3-21: High-SlipSuppression Current Lvl**

No. (Hex.)	Name	Description	Default Setting (Range)
n3-21 (0579)	High-SlipSuppression Current Lvl	<div style="display: flex; justify-content: space-between; font-size: small;"> V/f CL-V/f OLV CLV AOLV OLV/PM AOLV/PM CLV/PM EZOLV </div> This sets, as a percentage value, the upper limit of the current suppressed at the time of overexcitation deceleration, taking the drive rated current as a value of 100%.	100% (0 - 150%)

If the motor current exceeds the value set to *n3-21* during Overexcitation Deceleration due to flux saturation, the drive automatically reduces the overexcitation gain. Reduce the setting value if *oC* [Overcurrent], *oL1* [Motor Overload], or *oL2* [Drive Overloaded] occur during overexcitation deceleration.

Reduce the setting value when repetitive or long overexcitation deceleration causes motor overheat.

■ **n3-23: Overexcitation Operation Select**

No. (Hex.)	Name	Description	Default Setting (Range)
n3-23 (057B)	Overexcitation Operation Select	<div style="display: flex; justify-content: space-between; font-size: small;"> V/f CL-V/f OLV CLV AOLV OLV/PM AOLV/PM CLV/PM EZOLV </div> This parameter selects the direction of motor rotation of motors for which overexcitation operation is applied.	0 (0 - 2)

0 : Enabled in both directions

1 : Enabled only when rotating FWD

2 : Enabled only when in REV

Note:

When *n3-23* = 1, 2, overexcitation is enabled only in the direction of motor rotation in which a regenerative load is applied. *ov* [Overvoltage] can be suppressed by increased motor loss.

◆ n4: Adv Vect Tune

The following explains how to make special adjustments for *Advanced OpenLoop Vector Control* [$A1-02 = 4$].

- First, perform Rotational Auto-Tuning.
- Operation that fluctuates around zero speed cannot be carried out when there is a load. For applications of this sort, set $A1-02 = 3$ [*Open Loop Vector Control*].
- The tolerance of regenerative torque at low speeds is diminished. If regenerative torque is required in the low speed range, set $A1-02 = 3$.
- This cannot be used for elevators or similar applications. There is a risk that the load could slip.

■ n4-60: Motoring Low Speed Comp Gain

No. (Hex.)	Name	Description	Default (Range)
n4-60 (1B80)	Motoring Low Speed Comp Gain	<div style="display: flex; justify-content: space-between; font-size: 0.8em; margin-bottom: 5px;"> V/f CL-V/f OLV CLV AOLV OLV/PM AOLV/PM CLV/PM EZOLV </div> This compensation gain improves the control characteristics for motoring loads in the low speed range.	100.0% (50.0 - 200.0%)

Note:

- To improve torque accuracy in the motoring direction when running at low speeds, either perform only Stationary Auto-Tuning for Line-to-Line Resistance, or increase the value of $n4-60$ in 5% increments. The suggested setting is 100% to 120%.
- If the output frequency fluctuates when running at low speeds, stationary Auto-Tuning for Line-to-Line Resistance only should be performed. If there is no improvement, increase $n4-60$ in increments of 10%. The suggested setting is 50% to 100%.

■ n4-61: Low Speed Comp Frequency Level

No. (Hex.)	Name	Description	Default Setting (Range)
n4-61 (1B81)	Low Speed Comp Frequency Level	<div style="display: flex; justify-content: space-between; font-size: 0.8em; margin-bottom: 5px;"> V/f CL-V/f OLV CLV AOLV OLV/PM AOLV/PM CLV/PM EZOLV </div> Set a frequency that enables the settings for $n4-60$ [<i>Motoring Low Speed Comp Gain</i>], $n4-62$ [<i>Low Speed compensation Gain</i>]. When the output frequency < $n4-61$, torque compensation is carried out in accordance with the settings for $n4-60$, $n4-62$. Normally there is no need to change this setting.	6.00 Hz (0.50 - 12.00 Hz)

■ n4-62: Regen Low Speed Comp Gain

No. (Hex.)	Name	Description	Default Setting (Range)
n4-62 (1B82)	Regen Low Speed Comp Gain	<div style="display: flex; justify-content: space-between; font-size: 0.8em; margin-bottom: 5px;"> V/f CL-V/f OLV CLV AOLV OLV/PM AOLV/PM CLV/PM EZOLV </div> This compensation gain improves the control characteristics for regenerative loads in the low speed range.	100.0% (50.0 - 200.0%)

Note:

If no regenerative load is applied when running at low speeds, stationary Auto-Tuning for Line-to-Line Resistance only should be performed. If there is no improvement, increase $n4-62$ in increments of 5%. The suggested setting is 100% to 150%. If set extremely high, CF [*Control Fault*] may be detected at the time of stop.

■ n4-63: SpdEstimationResponseForHighFreq

No. (Hex.)	Name	Description	Default Setting (Range)
n4-63 (1B83)	SpdEstimationResponseForHighFreq	<div style="display: flex; justify-content: space-between; font-size: 0.8em; margin-bottom: 5px;"> V/f CL-V/f OLV CLV AOLV OLV/PM AOLV/PM CLV/PM EZOLV </div> In high speed ranges, where the output frequency is $\geq n4-67$ [<i>SwitchingFreq for Estimation gain</i>], this adjusts the responsiveness of the speed estimation.	60.0 (0.1 - 150.0)

When an improvement in the response of speed estimation is desired, or when the motor speed oscillates, or when there is a significant amount of torque ripple, increase the setting value in 10.0 increments. If no improvement is obtained, reduce the setting value in 10.0 increments.

Note:

Before adjusting $n4-63$, $n4-64$ [*SpdEstimationResponse for Low Freq*], $n4-65$ [*FluxEstimationResponseForHighFrg*], $n4-66$ [*FluxEstimationResponseForLowFrg*], carry out rotational Auto-Tuning.

■ n4-64: SpdEstimationResponse forLowFreq

No. (Hex.)	Name	Description	Default Setting (Range)
n4-64 (1B84)	SpdEstimationResponse forLowFreq	<div style="display: flex; justify-content: space-between; font-size: small;"> V/f CL-V/f OLV CLV AOLV OLV/PM AOLV/PM CLV/PM EZOLV </div> <p>In low speed ranges, where $0 \leq$ the output frequency, which is $< n4-67$ [SwitchingFreq forEstimation gain], this adjusts the responsiveness of the speed estimation.</p>	60.0 (0.1 - 150.0)

When an improvement in the response of speed estimation is desired, or when the motor speed oscillates, or when there is a significant amount of torque ripple, increase the setting value in 10.0 increments. If no improvement is obtained, reduce the setting value in 10.0 increments.

Note:

Before adjusting *n4-63* [SpdEstimationResponseForHighFreq], *n4-64*, *n4-65* [FluxEstimationResponseForHighFreq], *n4-66* [FluxEstimationResponseForLowFreq], carry out rotational Auto-Tuning.

■ n4-65: FluxEstimationResponseForHighFrq

No. (Hex.)	Name	Description	Default Setting (Range)
n4-65 (1B85)	FluxEstimationResponseForHighFrq	<div style="display: flex; justify-content: space-between; font-size: small;"> V/f CL-V/f OLV CLV AOLV OLV/PM AOLV/PM CLV/PM EZOLV </div> <p>In high speed ranges, where the output frequency is $\geq n4-67$ [SwitchingFreq forEstimation gain], this adjusts the responsiveness of the magnetic flux estimation. Normally there is no need to change this setting.</p>	0.90 (0.50 - 1.50)

if, under no-load conditions, *oS* [Overspeed] is detected, or if for any other reason the speed does not stabilize within the high speed range, adjust the setting value up or down in increments of 0.05.

■ n4-66: FluxEstimationResponseForLowFreq

No. (Hex.)	Name	Description	Default Setting (Range)
n4-66 (1B86)	FluxEstimationResponseForLowFreq	<div style="display: flex; justify-content: space-between; font-size: small;"> V/f CL-V/f OLV CLV AOLV OLV/PM AOLV/PM CLV/PM EZOLV </div> <p>In low speed ranges, where $0 \leq$ the output frequency, which is $< n4-67$ [SwitchingFreq forEstimation gain], this adjusts the responsiveness of the magnetic flux estimation. Normally there is no need to change this setting.</p>	0.90 (0.50 - 1.50)

if, under no-load conditions, *oS* [Overspeed] is detected, or if for any other reason the speed does not stabilize within the low speed range, adjust the setting value up or down in increments of 0.05.

■ n4-67: SwitchingFreq forEstimation gain

No. (Hex.)	Name	Description	Default Setting (Range)
n4-67 (1B87)	SwitchingFreq forEstimation gain	<div style="display: flex; justify-content: space-between; font-size: small;"> V/f CL-V/f OLV CLV AOLV OLV/PM AOLV/PM CLV/PM EZOLV </div> <p>Set the switching frequency for estimation gain for each of the following: <i>n4-63</i> [SpdEstimationResponseForHighFreq], <i>n4-64</i> [SpdEstimationResponse forLowFreq], <i>n4-65</i> [FluxEstimationResponseForHighFrq], and <i>n4-66</i> [FluxEstimationResponseForLowFreq]. Normally there is no need to change this setting.</p>	6.00 Hz (0.00 to E1-04)

If the output frequency is greater than *n4-67*, *n4-63* and *n4-65* are selected. If the output frequency is less than *n4-67*, *n4-64* and *n4-66* are selected.

■ n4-68: FilterTimeConst forSpdEstimation

No. (Hex.)	Name	Description	Default Setting (Range)
n4-68 (1B88)	FilterTimeConst forSpdEstimation	<div style="display: flex; justify-content: space-between; font-size: small;"> V/f CL-V/f OLV CLV AOLV OLV/PM AOLV/PM CLV/PM EZOLV </div> <p>Sets the primary delay time constant for the speed estimation value. Normally there is no need to change this setting.</p>	0.001 s (0.001 - 0.010 s)

If the motor speed oscillates in the high speed range, set the value to 0.010 s.

■ n4-69: Response of Flux loop

No. (Hex.)	Name	Description	Default Setting (Range)
n4-69 (1B89)	Response of Flux loop	<div style="display: flex; justify-content: space-between; font-size: 0.8em; margin-bottom: 5px;"> V/f CL-V/f OLV CLV AOLV OLV/PM AOLV/PM CLV/PM EZOLV </div> Stabilizes motor vibrations through unified control of magnetic flux.	1.00 (0.00 - 60.00)

If step-out occurs when the load changes, reduce the setting value in 1.00 increments.

Note:

If motor speed is reduced with heavy loads, increase *n4-69* in increments of 1.00. If there is no improvement, increase *n4-74 [Limit of Flux loop]* in increments of 20%.

■ n4-70: Speed Command Comp @ Low Freq

No. (Hex.)	Name	Description	Default Setting (Range)
n4-70 (1B8A)	Speed Command Comp @ Low Freq	<div style="display: flex; justify-content: space-between; font-size: 0.8em; margin-bottom: 5px;"> V/f CL-V/f OLV CLV AOLV OLV/PM AOLV/PM CLV/PM EZOLV </div> Adjust this to improve stability when running at low speeds. Normally there is no need to change this setting.	0.60 Hz (0.00 - 1.50 Hz)

This function improves control stability when writing at low speeds. Increase the setting in 0.3 Hz increments at the time of low-speed references with no load.

Note:

Although the stability of speed references for low speeds is improved when *n4-70* is increased, it can sometimes negatively impact speed control accuracy.

■ n4-72: PG Mode

No. (Hex.)	Name	Description	Default Setting (Range)
n4-72 (1B8C)	PG Mode	<div style="display: flex; justify-content: space-between; font-size: 0.8em; margin-bottom: 5px;"> V/f CL-V/f OLV CLV AOLV OLV/PM AOLV/PM CLV/PM EZOLV </div> Select whether an encoder option is to be connected or not when set to <i>A1-02 = 4 [Control Method Selection = Advanced OpenLoop Vector Control]</i> .	0 (0, 1)

Even when using Advanced Open Loop Vector Control, an encoder option (PG-B3 or PG-X3) can be connected. Through combining the use of an encoder option, an even higher level of precision over control of the speed can be obtained.

Note:

- When running machinery using an encoder option together with Advanced Open Loop Vector Control, specialized tuning of the drive may be necessary. Ordinarily, a setting of *A1-02 = 3 [Control Method Selection = Closed Loop Vector Control]* should be used when using an encoder option.
- When set to *n4-72 = 1*, the number of PG pulses should be set for *F1-01 [PG 1 Pulses Per Revolution]*.

0 : WithOut PG

1 : With PG

■ n4-73: PGO ret ope

No. (Hex.)	Name	Description	Default Setting (Range)
n4-73 (1B8D)	PGO ret ope	<div style="display: flex; justify-content: space-between; font-size: 0.8em; margin-bottom: 5px;"> V/f CL-V/f OLV CLV AOLV OLV/PM AOLV/PM CLV/PM EZOLV </div> If the encoder is disconnected, this determines whether the drive is to restart in the WithOut PG mode, or is to restart in the With PG mode.	0 (0, 1)

This function is effective when *A1-02 = 4 [Control Method Selection = Advanced OpenLoop Vector Control]* and *n4-72 = 1 [PG Mode = With PG]* have been set.

The action to take upon detection of encoder disconnection is set with *F1-02 [PG Feedback Loss Selection]*. *n4-73* determines whether the drive is to start up in the WithOut PG mode, or is to start up in the With PG mode, after *PGo [PG Disconnect]* is detected.

Note:

n4-73 is effective only when using an encoder option PG-B3. When using the PG-X3, there is no need to set *n4-73*.

If *PGo* is detected, de-energize the drive and inspect the wiring for the encoder.

0 : WithOut PG

1 : With PG

■ n4-74: Limit of Flux loop

No. (Hex.)	Name	Description	Default Setting (Range)
n4-74 (1B8E)	Limit of Flux loop	<div style="display: flex; justify-content: space-between; font-size: small;"> V/f CL-V/f OLV CLV AOLV OLV/PM AOLV/PM CLV/PM EZOLV </div> Sets the control level for flux loop control output.	160% (100 to 500%)

Increase the setting value in 20% increments when the torque is insufficient due to loads of at least 100%. Note that if the setting is too high, overexcitation could occur causing the motor generate heat.

◆ n5: Feed Forward Control

Feed forward control improves responsiveness of acceleration and deceleration in accordance with the speed reference.

Increasing the values set in C5-01 and C5-03 [ASR Proportional Gain] is effective in applying feed forward control to machines with low rigidity for which hunting and vibration are likely to occur or to machines with significant inertia. Applying this function while using CLV control also helps prevent overshooting. Refer to Figure 11.139 for details. Refer to Figure 11.140 for more information on parameters related to feed forward control.

Feed forward control is enabled when A1-02 [Control Method Selection] is set to any of the following.

- 3: Closed Loop Vector Control
- 4: Advanced OpenLoop Vector Control
- 6: PM Advanced Open Loop Vector
- 7: PM Closed Loop Vector Control

Note:

- Responsiveness cannot be improved with feed forward control for applications in which loads are applied externally during run at constant speed.
- When using the Droop control function, set n5-01 = 0 [Feed Forward Control Selection = Disabled].
- Feed forward control cannot be used with motor 2.

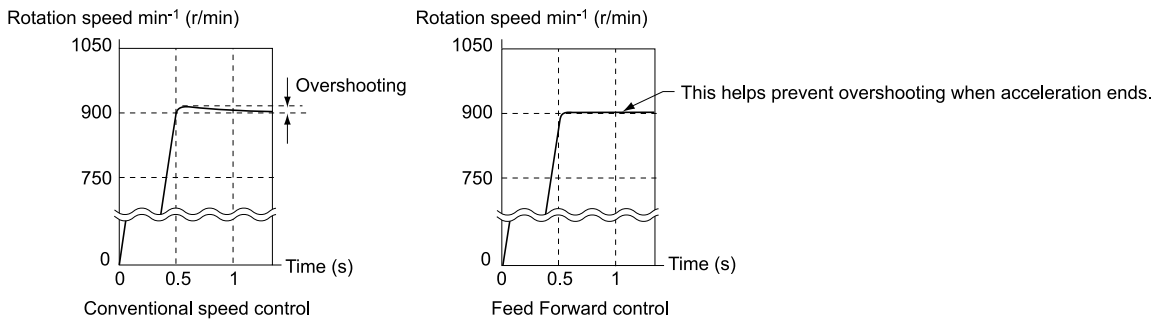

Figure 11.139 Suppress Overshooting with Feed Forward Control

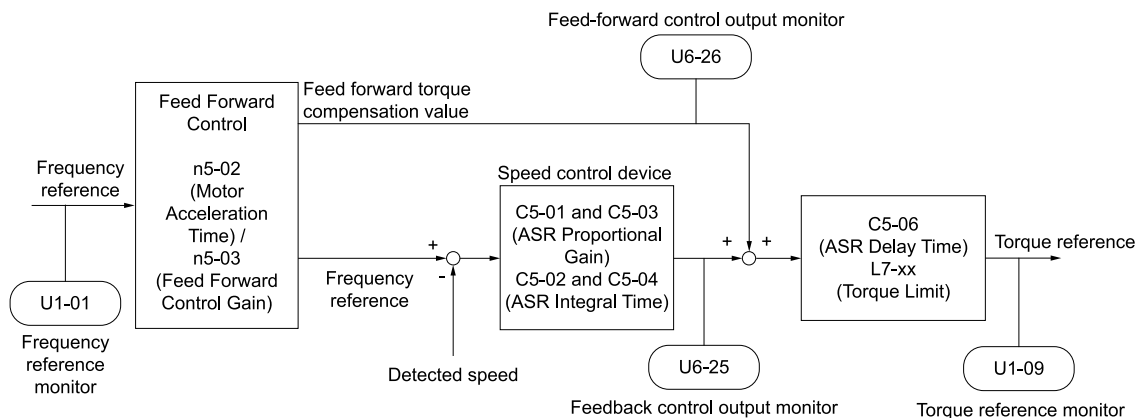

Figure 11.140 Configure Feed Forward Control

■ Preparation Before Executing Feed Forward Control

Perform any of the following procedures before executing feed forward control.

- Run Auto-Tuning to set motor parameters.
When Auto-Tuning cannot be performed, manually set motor parameters using the information found on the motor nameplate or test reports. Set the *E2 parameters* for induction motors. Set the *E5 parameters* for PM motors.
- Set *C5 parameters* [*Automatic Speed Regulator (ASR)*] individually to adjust the speed control loop (ASR).
- Perform Inertia Tuning if a motor can be connected to a machine and rotated when running Auto-Tuning. Parameters related to Feed Forward control are automatically adjusted when Inertia Tuning is carried out.
- If Inertia Tuning cannot be performed, refer to [Figure 11.140](#) and set the parameters related to feed forward control individually.

■ n5-01: Feedforward Control Selection

No. (Hex.)	Name	Description	Default (Range)
n5-01 (05B0)	Feedforward Control Selection	<div style="display: flex; justify-content: space-between; font-size: small;"> V/f CL-V/f OLV CLV AOLV OLV/PM AOLV/PM CLV/PM EZOLV </div> Enables and disables the Feedforward function.	0 (0, 1)

0 : Disabled

1 : Enabled

■ n5-02: Motor Acceleration Time

No. (Hex.)	Name	Description	Default (Range)
n5-02 (05B1)	Motor Acceleration Time	<div style="display: flex; justify-content: space-between; font-size: small;"> V/f CL-V/f OLV CLV AOLV OLV/PM AOLV/PM CLV/PM EZOLV </div> Set the time required for the motor to accelerate from the stopped state to the maximum frequency when using a single motor at the rated torque. The motor acceleration time is automatically set by Inertia Tuning.	Determined by C6-01, E5-01, and o2-04 (0.001 - 10.000 s)

If Inertia Tuning process cannot be performed, calculate the motor acceleration time as illustrated below or measure the motor acceleration time and set *n5-02* to this value.

Calculate the Motor Acceleration Time

Derive the motor acceleration time using the following expression.

$$n5-02 = \frac{2\pi \cdot J_{\text{Motor}} \cdot n_{\text{rated}}}{60 \cdot T_{\text{rated}}}$$

- J_{Motor} = Moment of inertia of motor (kg m²)
- n_{rated} = Motor rated speed (min⁻¹, r/min)
- T_{rated} = Motor rated torque (N m)

The motor acceleration time can also be derived using the following calculation expression.

$$n5-02 = \frac{4\pi \cdot J_{\text{Motor}} \cdot f_{\text{rated}}}{p \cdot T_{\text{rated}}}$$

- f_{rated} = Motor rated frequency (Hz)
- p = Number of motor poles

Calculate the Motor Acceleration Time

Use the following procedure to calculate the motor acceleration time.

1. Select a control method via *A1-02* [*Control Method Selection*].
2. Disconnect the motor and load.
3. Run Auto-Tuning to set motor parameters.
When Auto-Tuning cannot be performed, manually set motor parameters using the information found on the motor nameplate or test reports. Set the *E2 parameters* for induction motors. Set the *E5 parameters* for PM motors.
4. Set *C5 parameters* [*Automatic Speed Regulator (ASR)*].
5. Set *C1-01* [*Acceleration Time 1*] = 0.
6. Set *L7-01* [*Forward Torque Limit*] to 100%.

7. Set the frequency reference to the same value as the motor rated speed.
8. Measure the time taken by the motor to reach the rated speed.
Display *UI-05 [Motor Speed]* on the keypad and enter the Run command (forward run).
9. Stop the motor.
10. Set *n5-02* to the actual measured motor acceleration time value.

Reset all parameters changed to measure the motor acceleration time to the previous setting values.

■ **n5-03: Feed Forward Control Gain**

No. (Hex.)	Name	Description	Default (Range)
n5-03 (05B2)	Feedforward Control Gain	<div style="display: flex; justify-content: space-between; font-size: small;"> V/f CL-V/f OLV CLV AOLV OLV/PM AOLV/PM CLV/PM EZOLV </div> <p>This parameter sets the ratio between load inertia and motor inertia. The Feedforward Control Gain value is automatically set by Inertia Tuning.</p>	1.00 (0.00 - 100.00)

Set this parameter in accordance with the following procedure when Inertia Tuning cannot be performed.

Set *n5-02 [Motor Acceleration Time]* beforehand.

1. Connect the motor and load.
2. Set *CI-01 [Acceleration Time 1] = 0*.
3. Set the expected test run torque limit levels using parameters *L7-01 through L7-04 [Torque Limit]*.
4. Set the frequency reference in accordance with the high speed range of the machine.
5. Measure the time taken by the motor to reach the command reference speed.
Display *UI-05 [Motor Speed]* on the keypad and enter the Run command.
6. Stop the motor.
7. Substitute the retrieved values in the following expression, and set *n5-03* to the value derived from the expression.

$$n5-03 = \frac{t_{\text{accel}} \cdot T_{\text{Lim_Test}} \cdot f_{\text{rated}}}{n5-02 \cdot f_{\text{ref_Test}} \cdot 100} - 1$$

- t_{accel} = Acceleration time (s)
- f_{rated} = Motor rated frequency (Hz)
- $T_{\text{Lim_Test}}$ = Test run torque limit (%)
- $f_{\text{ref_Test}}$ = Test run frequency reference (Hz)

Note:

Machinery accelerates suddenly. This should never be carried out with respect to machinery that must not be suddenly accelerated.

Reset all parameters changed to measure the motor acceleration time to the previous setting values.

Note:

- Increase the value set in *n5-03* when response to the speed reference is slow.
- Reduce the value set in *n5-03* in the following circumstances.
 - The actual speed is overshooting.
 - A negative torque reference is output when acceleration ends.

■ **n5-04: Spd Response F**

No. (Hex.)	Name	Description	Default Setting (Range)
n5-04 (05B3) RUN	Spd Response F	<div style="display: flex; justify-content: space-between; font-size: small;"> V/f CL-V/f OLV CLV AOLV OLV/PM AOLV/PM CLV/PM EZOLV </div> <p>Sets the response frequency for the speed reference in increments of 0.01 Hz. Normally there is no need to configure this setting.</p>	Determined by A1-02 (0.00 - 500.00 Hz)

If *n5-03 [Feed Forward Control Gain]* is set incorrectly, the response will worsen beyond the set frequency.

◆ **n6: Online Tuning**

n6 parameters are used to set the online tuning function for motor line-to-line resistance.

The Online Tuning for motor line-to-line resistance is used to prevent degradation of speed control accuracy due to motor temperature fluctuation and motor stalls due to insufficient torque.

■ n6-01: Online Tuning Selection

No. (Hex.)	Name	Description	Default (Range)
n6-01 (0570)	Online Tuning Selection	<div style="display: flex; justify-content: space-between; font-size: small;"> V/f CL-V/f OLV CLV AOLV OLV/PM AOLV/PM CLV/PM EZOLV </div> Selects the type of motor data Online Tuning uses for OLV control.	0 (0 - 2)

0 : Disabled

1 : Line-to-line resistance tuning

The drive adjusts the motor line-to-line resistance during run. This procedure is effective for speed values up to 6 Hz and improves the overload capacity in the low speed range by adjusting the value set for the motor resistance.

2 : Voltage Adjustm

The drive adjusts the output voltage during run to improve overload tolerance and minimize the effects of high temperatures on speed accuracy.

Note:

Setting 2 is enabled only when $b8-01 = 0$ [Energy Saving Control Selection = Disabled].

■ n6-05: Online Tuning Gain

No. (Hex.)	Name	Description	Default Setting (Range)
n6-05 (05C7)	Online Tuning Gain	<div style="display: flex; justify-content: space-between; font-size: small;"> V/f CL-V/f OLV CLV AOLV OLV/PM AOLV/PM CLV/PM EZOLV </div> Sets the compensation gain when set to $n6-01 = 2$ [Online Tuning Selection = Voltage Adjustm]. Normally there is no need to configure this setting.	1.0 (0.1 - 50.0)

When using motors with a large secondary circuit time constant, reduce the setting value.

If $oL1$ [Motor Overload] is detected, increase the setting value in 0.1 increments.

■ n6-11: online resister tuning

No. (Hex.)	Name	Description	Default Setting (Range)
n6-11 (1B56)	online resister tuning	<div style="display: flex; justify-content: space-between; font-size: small;"> V/f CL-V/f OLV CLV AOLV OLV/PM AOLV/PM CLV/PM EZOLV </div> Adjusts the responsiveness for online resister tuning. To be enabled, the value should be set to approximately 1.000. This is disabled if the value is set to 0.	0.000 (0.000 - 1.000)

◆ n7: EZ Drive

The $n7$ parameters provide special adjustments for EZ Open Loop Vector Control.

■ n7-01: Flux Estimation Cut-off Freq

No. (Hex.)	Name	Description	Default (Range)
n7-01 (3111)	Flux Estimation Cut-off Freq	<div style="display: flex; justify-content: space-between; font-size: small;"> V/f CL-V/f OLV CLV AOLV OLV/PM AOLV/PM CLV/PM EZOLV </div> Sets the oscillation suppression gain for the low speed range.	1.0 (0.1 - 10.0)

Note:

- If oscillation occurs in the low speed range, either lengthen the acceleration time, or raise the setting value in 0.5 increments.
- To obtain starting torque by means of the setting for $C4-01$ [Torque Compensation Gain], reduce the setting value in 0.3 increments.

■ n7-05: Torque Control Response Gain

No. (Hex.)	Name	Description	Default Setting (Range)
n7-05 (3115)	Torque Control Response Gain	<div style="display: flex; justify-content: space-between; font-size: small;"> V/f CL-V/f OLV CLV AOLV OLV/PM AOLV/PM CLV/PM EZOLV </div> Sets the response gain relative to load changes.	100 (10 - 1000)

Note:

To improve tracking with respect to load changes, increase the setting value in increments of 5. If oscillation occurs during load changes reduce the setting value in increments of 5.

■ **n7-07: PLL response 1**

No. (Hex.)	Name	Description	Default Setting (Range)
n7-07 (3117)	PLL response 1	<div style="display: flex; justify-content: space-between; font-size: 0.8em; margin-bottom: 5px;"> V/f CL-V/f OLV CLV AOLV OLV/PM AOLV/PM CLV/PM EZOLV </div> Sets the speed calculation gain during normal operation. Normally there is no need to change this setting.	15.0 Hz (1.0 - 50.0 Hz)

■ **n7-08: PLL response 2**

No. (Hex.)	Name	Description	Default Setting (Range)
n7-08 (3118)	PLL response 2	<div style="display: flex; justify-content: space-between; font-size: 0.8em; margin-bottom: 5px;"> V/f CL-V/f OLV CLV AOLV OLV/PM AOLV/PM CLV/PM EZOLV </div> Sets the speed calculation gain during a speed search.	25.0 Hz (1.0 - 50.0 Hz)

Note:

When the setting value is increased, a speed search of a motor rotating at a high frequency can be performed. However, if the setting value is too high, the calculated speed will oscillate and a restart will fail. In such cases reduce the setting value.

■ **n7-10: Sensorless Switchover StartSpeed**

No. (Hex.)	Name	Description	Default Setting (Range)
n7-10 (311A)	Sensorless Switchover StartSpeed	<div style="display: flex; justify-content: space-between; font-size: 0.8em; margin-bottom: 5px;"> V/f CL-V/f OLV CLV AOLV OLV/PM AOLV/PM CLV/PM EZOLV </div> The speed range within which pull-in current commands are enabled is set as a proportion relative to the rated frequency.	10.0% (0.0 - 100.0%)

Note:

- The value set in *n8-51 [Accel / Decel Pull-In Current]* is enabled with speeds that do not exceed the value set in *n7-10*. The value set in *b8-01 [Energy Saving Control Selection]* is enabled with speeds higher than the value set in *n7-10*.
- If a significant amount of oscillation occurs when running at low-speeds, increase the setting value.
- Reduce the setting value when priority is to be placed on energy-saving measures in the low speed range.

■ **n7-17: Resistance TemperatureCorrection**

No. (Hex.)	Name	Description	Default Setting (Range)
n7-17 (3122)	Resistance TemperatureCorrection	<div style="display: flex; justify-content: space-between; font-size: 0.8em; margin-bottom: 5px;"> V/f CL-V/f OLV CLV AOLV OLV/PM AOLV/PM CLV/PM EZOLV </div> Selects the function for compensating for changes in the motor resistance value caused by temperature fluctuations.	1 (0 - 2)

0 : Invalid

1 : Valid (Only 1 time)

2 : Valid (Every time)

Note:

- With the settings *n7-17 = 1, 2*, there could be some delay before startup because of the adjustment time.
- With the settings *n7-17 = 1, 2*, the line-to-line resistance value of *E9-10 [Motor Line-to-Line Resistance]* may be set.
- Set *n7-17 = 2* if the temperature state is likely to change at startup.
- To shorten the startup time, set *n7-17 = 0*, then perform line-to-line resistance tuning.
- If startup from the coasting state can be expected, set *n7-17 = 0*, then perform line-to-line resistance tuning.

◆ **n8: PM Motor Control Tuning**

n8 parameters are used to make adjustments when controlling PM motors.

■ **n8-01: Init Rotor Position Est Current**

No. (Hex.)	Name	Description	Default (Range)
n8-01 (0540)	Init Rotor Position Est Current	<div style="display: flex; justify-content: space-between; font-size: 0.8em; margin-bottom: 5px;"> V/f CL-V/f OLV CLV AOLV OLV/PM AOLV/PM CLV/PM EZOLV </div> Sets, as a percentage, the Initial Rotor Position Estimated Current, taking the <i>E5-03 [Motor Rated Current (FLA)]</i> as the 100% value. Normally there is no need to change this setting.	50% (0 - 100%)

The Initial Rotor Position Estimated Current is the current used to detect the initial position of rotors. If the motor nameplate has an “Si” item, set the value found there.

■ n8-02: Pole Attraction Current

No. (Hex.)	Name	Description	Default Setting (Range)
n8-02 (0541)	Pole Attraction Current	<div style="display: flex; justify-content: space-between; font-size: 0.8em; margin-bottom: 5px;"> V/f CL-V/f OLV CLV AOLV OLV/PM AOLV/PM CLV/PM EZOLV </div> Sets the current at the time of polar attraction as a percentage of the motor rated current, which is deemed to be 100%. Normally there is no need to change this setting.	80% (0 - 150%)

The polar pull-in current is the current used to attract the rotor upon completion of detection of the initial rotor position. When the value set in *n8-02* is increased, the starting torque also increases.

- If the motor does not track properly at the time of the polar attraction, increase the value in increments of 10%. If the value is set too high, *oL2 [Drive Overloaded]* may be detected.
- If the motor oscillates at the time of the polar attraction, reduce the value in increments of 10%.

Note:

This is effective when set to *A1-02 = 7 [Control Method Selection = PM Closed Loop Vector Control]* and carrying out Rotational Auto-Tuning or Z Pulse Offset Tuning.

■ n8-03: Current Starting Time

No. (Hex.)	Name	Description	Default Setting (Range)
n8-03 (0542)	Current Starting Time	<div style="display: flex; justify-content: space-between; font-size: 0.8em; margin-bottom: 5px;"> V/f CL-V/f OLV CLV AOLV OLV/PM AOLV/PM CLV/PM EZOLV </div> Sets the amount for the Current Starting Time, which is used when carrying out Z Pulse Offset Tuning. Normally there is no need to change this setting.	1.5 s (1.5 - 5.0 s)

Sets the time that the pull-in current is to start when detecting the motor magnetic pole of the rotors.

Note:

If the motor oscillates at the time of the polar attraction, increase the value in increments of 0.5 s. If the value is set too high, *oL2 [Drive Overloaded]* may be detected.

■ n8-04: Polar Attraction Time

No. (Hex.)	Name	Description	Default Setting (Range)
n8-04 (0543)	Polar Attraction Time	<div style="display: flex; justify-content: space-between; font-size: 0.8em; margin-bottom: 5px;"> V/f CL-V/f OLV CLV AOLV OLV/PM AOLV/PM CLV/PM EZOLV </div> Sets the amount for the Polar Attraction Time, which is used when carrying out Z Pulse Offset Tuning. Normally there is no need to change this setting.	1.5 s (1.5 - 5.0 s)

Sets the amount of time that the pull-in current is to flow when detecting the motor magnetic pole of the rotors.

Note:

If the motor oscillates at the time of the polar attraction, increase the value in increments of 0.5 s. If the value is set too high, *oL2 [Drive Overloaded]* may be detected.

■ n8-11: Induction Volt Estimation Gain 2

No. (Hex.)	Name	Description	Default Setting (Range)
n8-11 (054A)	Induction Volt Estimation Gain 2	<div style="display: flex; justify-content: space-between; font-size: 0.8em; margin-bottom: 5px;"> V/f CL-V/f OLV CLV AOLV OLV/PM AOLV/PM CLV/PM EZOLV </div> Sets the gain for speed estimation. Normally there is no need to change this setting.	Determined by n8-72 (0.0 - 1000.0)

Note:

At the default settings, with a setting of *n8-72 = 0 [Speed Estimation Method Select = Conventional method]*, this will be 50.0. With a setting of *n8-72 = 1 [Speed Estimation Method Select = A1000 method]*, this will be 30.0.

■ n8-14: Polarity Compensation Gain 3

No. (Hex.)	Name	Description	Default Setting (Range)
n8-14 (054D)	Polarity Compensation Gain 3	<div style="display: flex; justify-content: space-between; font-size: 0.8em; margin-bottom: 5px;"> V/f CL-V/f OLV CLV AOLV OLV/PM AOLV/PM CLV/PM EZOLV </div> Sets the gain for speed estimation. Normally there is no need to change this setting.	1.000 (0.000 - 10.000)

■ n8-15: Polarity Compensation Gain 4

No. (Hex.)	Name	Description	Default Setting (Range)
n8-15 (054E)	Polarity Compensation Gain 4	<div style="display: flex; justify-content: space-between; font-size: 0.8em; margin-bottom: 5px;"> V/f CL-V/f OLV CLV AOLV OLV/PM AOLV/PM CLV/PM EZOLV </div> Sets the gain for speed estimation. Normally there is no need to change this setting.	0.500 (0.000 - 10.000)

■ n8-21: Motor Ke Gain

No. (Hex.)	Name	Description	Default Setting (Range)
n8-21 (0554)	Motor Ke Gain	<div style="display: flex; justify-content: space-between; font-size: 0.8em; margin-bottom: 5px;"> V/f CL-V/f OLV CLV AOLV OLV/PM AOLV/PM CLV/PM EZOLV </div> Sets the gain for speed estimation. Normally there is no need to change this setting.	0.90 (0.80 - 1.00)

■ n8-35: InitRotorPosition Detect Select

No. (Hex.)	Name	Description	Default Setting (Range)
n8-35 (0562)	InitRotorPosition Detect Select	<div style="display: flex; justify-content: space-between; font-size: 0.8em; margin-bottom: 5px;"> V/f CL-V/f OLV CLV AOLV OLV/PM AOLV/PM CLV/PM EZOLV </div> Selects how the rotor position is detected at start.	Determined by A1-02 (0 - 2)

When $A1-02 = 7$ [Control Method Selection = PM Closed Loop Vector Control] is set, the initial motor magnetic pole detection operates for the first instance after the power supply is turned on. After that, rotor position is calculated from the encoder signal and saved until the drive is switched off.

0 : Pull-In

Starts the rotor with pull-in current.

1 : High frequency injection

High frequency is injected to detect the rotor position. Using this setting may cause significant excitation sound when motors start.

2 : Pulse injection

Inputs the pulse signal to the motor to detect the position of the rotor.

Note:

- Select a value of 0 if using SPM motors. Values between 0 to 2 can be selected if using IPM motors.
- Always carry out a prior evaluation of the drive and machinery combination being used for the application when setting $n8-35 = 1$ or 2 . The motor may rotate in the direction that is opposite that of the direction of the Run command if the polarity direction is detected mistakenly.

■ n8-36: InjectionSignalFreqForInductTurn

No. (Hex.)	Name	Description	Default Setting (Range)
n8-36 (0563)	InjectionSignalFreq ForInductTurn	<div style="display: flex; justify-content: space-between; font-size: 0.8em; margin-bottom: 5px;"> V/f CL-V/f OLV CLV AOLV OLV/PM AOLV/PM CLV/PM EZOLV </div> Sets the injection frequency for high frequency injection.	500 Hz (200 - 5000 Hz)

Calculated automatically when PM Rotational Auto-Tuning or PM Stationary Auto-Tuning is carried out.

■ n8-37: High Freq Injection Amplitude

No. (Hex.)	Name	Description	Default Setting (Range)
n8-37 (0564)	High Freq Injection Amplitude	<div style="display: flex; justify-content: space-between; font-size: 0.8em; margin-bottom: 5px;"> V/f CL-V/f OLV CLV AOLV OLV/PM AOLV/PM CLV/PM EZOLV </div> Considering 200 V to be the 100% value with a 200 V class unit, and 400 V to be 100% with a 400 V class unit, set the high frequency injection amplitude as a percentage value. Normally there is no need to change this setting.	20.0% (0.0 - 50.0%)

This parameter is enabled when $n8-57 = 1$ [*High Frequency Injection = Enabled*] is set. Set automatically when Stationary Auto-Tuning or Rotational Auto-Tuning is carried out.

Note:

When changes are made to C6-02 [*Carrier Frequency Selection*], the setting for n8-37 is automatically initialized. After selecting the carrier frequency to be used, perform Auto-Tuning.

■ n8-41: HFI Overlap Pole Detection Pgain

No. (Hex.)	Name	Description	Default Setting (Range)
n8-41 (0568)	HFI Overlap Pole Detection Pgain	<div style="display: flex; justify-content: space-between; font-size: 0.8em; margin-bottom: 5px;"> V/f CL-V/f OLV CLV AOLV OLV/PM AOLV/PM CLV/PM EZOLV </div> Sets the speed estimation response for high frequency injection. Normally there is no need to change this setting.	3.0 (1.0 - 100.0)

Note:

Effective when $n8-57 = 1$ [*High Frequency Injection = Enabled*] or $n8-35 = 1$ [*InitRotorPosition Detect Select = High frequency injection*].

■ n8-42: HFI Overlap Pole Detection iTime

No. (Hex.)	Name	Description	Default Setting (Range)
n8-42 (0569)	HFI Overlap Pole Detection iTime	<div style="display: flex; justify-content: space-between; font-size: 0.8em; margin-bottom: 5px;"> V/f CL-V/f OLV CLV AOLV OLV/PM AOLV/PM CLV/PM EZOLV </div> Sets the oscillation suppression gain of the speed estimation for high frequency injection. Normally there is no need to change this setting.	1.0 (0.1 - 5.0)

Note:

Effective when $n8-57 = 1$ [*High Frequency Injection = Enabled*] or $n8-35 = 1$ [*InitRotorPosition Detect Select = High frequency injection*].

■ n8-45: Spd Feedback Detect Control Gain

No. (Hex.)	Name	Description	Default (Range)
n8-45 (0538)	Spd Feedback Detect Control Gain	<div style="display: flex; justify-content: space-between; font-size: 0.8em; margin-bottom: 5px;"> V/f CL-V/f OLV CLV AOLV OLV/PM AOLV/PM CLV/PM EZOLV </div> Sets the internal speed feedback detection reduction unit gain as a magnification value. Normally there is no need to change this setting.	0.80 (0.00 - 10.00)

Adjust in the following situations.

- Increase the setting value in steps of 0.05 when vibration or hunting occurs.
- Decrease the setting value in steps of 0.05 while checking response when the responsiveness of torque and speed is poor.

■ n8-47: Pull-InCurCompensationTime Const

No. (Hex.)	Name	Description	Default (Range)
n8-47 (053A)	Pull-InCurCompensationTime Const	<div style="display: flex; justify-content: space-between; font-size: 0.8em; margin-bottom: 5px;"> V/f CL-V/f OLV CLV AOLV OLV/PM AOLV/PM CLV/PM EZOLV </div> Sets the time constant used to match the pull-in current reference value with the actual current value. Normally there is no need to change this setting.	5.0 s (0.0 - 100.0 s)

Adjust in the following situations.

- Increase the setting when it takes too long for the reference value of the pull-in current to match the target value.
- Decrease this setting value in steps of 0.2 if hunting or vibration occur.
- Decrease the setting value in steps of 0.2 if the motor stalls during run at constant speed.

■ n8-48: Pull-In Current (for PM Motors)

No. (Hex.)	Name	Description	Default Setting (Range)
n8-48 (053B)	Pull-In Current (for PM Motors)	<div style="display: flex; justify-content: space-between; font-size: 0.8em; margin-bottom: 5px;"> V/f CL-V/f OLV CLV AOLV OLV/PM AOLV/PM CLV/PM EZOLV </div> On the basis that parameter E5-03 [Motor Rated Current (FLA)] is the 100% value, this parameter sets the d-axis current that flows to the motor during run at constant speed as a percentage.	30% (20 - 200%)

Adjust in the following situations.

- Slightly reduce this value if there is too much current when driving a light load at a constant speed.
- Increase the setting value in steps of 5% when hunting or vibration occurs during run at constant speed.
- Increase the setting value in steps of 5% if the motor stalls during run at constant speed.

■ n8-49: d-Axis Cur forHighEfficiencyCont

No. (Hex.)	Name	Description	Default Setting (Range)
n8-49 (053C)	d-Axis Cur forHighEfficiencyCont	<div style="display: flex; justify-content: space-between; font-size: 0.8em; margin-bottom: 5px;"> V/f CL-V/f OLV CLV AOLV OLV/PM AOLV/PM CLV/PM EZOLV </div> Sets, in terms of a percentage, the d-axis current to be supplied to the motor to run it at a uniform speed with a heavy load. Considers E5-03 [Motor Rated Current] to be 100%. Normally there is no need to change this setting.	Determined by E5-01 (-200.0 - 0.0%)

When running an IPM motor, the reluctance torque of the motor can be used to improve efficiency and contribute towards energy conservation.

Set to "0" when running an SPM motor.

Adjust this parameter in the following circumstances.

- If the load is large and motor rotation is unstable, reduce the setting value.
- If the E5 parameters [PM Motor Settings] have been changed, set n8-49 = 0 first, then readjust.

■ n8-51: Accel / Decel Pull-In Current

No. (Hex.)	Name	Description	Default Setting (Range)
n8-51 (053E)	Accel / Decel Pull-In Current	<div style="display: flex; justify-content: space-between; font-size: 0.8em; margin-bottom: 5px;"> V/f CL-V/f OLV CLV AOLV OLV/PM AOLV/PM CLV/PM EZOLV </div> Sets, as a percentage, the pull-in current allowed to flow during acceleration/deceleration, taking the motor rated current as a value of 100%.	Determined by A1-02 (0 - 200%)

Adjust this parameter in the following circumstances.

- Increase the setting value in increments of 5% when motors do not start smoothly due to significant loads.
- Reduce the setting value if excessive current flows during acceleration.

Note:

When set to A1-02 = 8 [Control Method Selection = EZ Open Loop Vector Control], n8-51 will always be in effect with respect to speed ranges below what is set for n7-10 [Sensorless Switchover StartSpeed].

■ n8-54: VoltErrorCompensationTime Const

No. (Hex.)	Name	Description	Default Setting (Range)
n8-54 (056D)	VoltErrorCompensationTime Const	<div style="display: flex; justify-content: space-between; font-size: 0.8em; margin-bottom: 5px;"> V/f CL-V/f OLV CLV AOLV OLV/PM AOLV/PM CLV/PM EZOLV </div> Sets the time constant used when compensating for voltage errors.	1.00 s (0.00 - 10.00 s)

Adjust this parameter in the following circumstances.

- Increase the setting value if oscillation occurs at the time of startup.
- If hunting occurs when running at low speed, increase the setting value.
- If hunting occurs due to rapid changes in load, increase the setting value in 0.1 increments. If hunting cannot be alleviated, set n8-51 [Accel / Decel Pull-In Current] to 0% and set n8-54 to 0.00 s, and disable compensation for voltage errors.

■ n8-55: Load Inertia

No. (Hex.)	Name	Description	Default Setting (Range)
n8-55 (056E)	Load Inertia	<div style="display: flex; justify-content: space-between; font-size: 0.8em; margin-bottom: 5px;"> V/f CL-V/f OLV CLV AOLV OLV/PM AOLV/PM CLV/PM EZOLV </div> This parameter sets the ratio between motor inertia and machine inertia.	0 (0 - 3)

Adjust this parameter in the following circumstances.

- Gradually increase the setting value of 0 if responsiveness of torque and speed is poor.
- Gradually increase the setting value of 0 if motors do not start smoothly.
- Gradually increase the setting value of 0 if the motor stalls during run constant speed.
- Reduce the setting value if vibration or hunting issues occur.

Note:

- If the value is set too low, *STPo* [Pull-Out Detection] may be detected.
- Motors may vibrate if the setting value is too high when using a single motor or operating motors at low inertia.

0 : Below 1:10

Use this setting in the following scenarios.

- The ratio between the motor inertia and machine inertia is less than 1:10
- Current ripples are significant

1 : Between 1:10 and 1:30

Use this setting in the following scenarios.

- The ratio between the motor inertia and machine inertia is approximately between 1:10 to 1:30
- An *STPo* was detected as a result of impact load or sudden acceleration/deceleration when $n8-55 = 0$ was set.

2 : Between 1:30 and 1:50

Use this setting in the following scenarios.

- The ratio between the motor inertia and machine inertia is approximately between 1:30 to 1:50
- An *STPo* was detected as a result of impact load or sudden acceleration/deceleration when $n8-55 = 1$ was set.

3 : Beyond 1:50

Adjust this parameter in the following circumstances.

- The ratio between the motor inertia and machine inertia is over 1:50.
- An *STPo* was detected as a result of impact load or sudden acceleration/deceleration when $n8-55 = 2$ was set.

■ n8-57: High Frequency Injection

No. (Hex.)	Name	Description	Default (Range)
n8-57 (0574)	High Frequency Injection	<div style="display: flex; justify-content: space-between; font-size: 0.8em; margin-bottom: 5px;"> V/f CL-V/f OLV CLV AOLV OLV/PM AOLV/PM CLV/PM EZOLV </div> Selects whether to perform a high frequency injection to detect motor speed.	0 (0, 1)

Note:

- Excitation sound will be generated from the motor when high frequency injection is carried out.
- Set $E1-09$ [Minimum Output Frequency] = 0.0 when using Zero Speed Control.

0 : Disabled

Set this parameter to 0 when using SPM motors. The speed control range is approximately 1:20.

When $n8-57 = 0$ is set, $E1-09$ [Minimum Output Frequency] cannot be set to a value that is less than or equal to 1/20 of the value of $E1-06$ [Base Frequency].

1 : Enabled

Set this parameter to 1 when using IPM motors. The speed control range changes to 1:100, which enables highly accurate speed detection.

■ n8-62: Output Voltage Limit (for PM)

No. (Hex.)	Name	Description	Default Setting (Range)
n8-62 (057D)	Output Voltage Limit (for PM)	<div style="display: flex; justify-content: space-between; font-size: 0.8em; margin-bottom: 5px;"> V/f CL-V/f OLV CLV AOLV OLV/PM AOLV/PM CLV/PM EZOLV </div> To prevent saturation of the output voltage, set the output voltage limit. Normally there is no need to configure this setting.	200 V Class: 200.0 V, 400 V Class: 400.0 V (200 V Class: 0.0 - 230.0 V, 400 V Class: 0.0 - 460.0 V)

Set so it is lower than the actual input power supply voltage.

■ n8-65: SpdFdbkDetectCtrlGainduringOVSup

No. (Hex.)	Name	Description	Default Setting (Range)
n8-65 (065C)	SpdFdbkDetectCtrlGainduringOVSup	<div style="display: flex; justify-content: space-between; font-size: 0.8em; margin-bottom: 5px;"> V/f CL-V/f OLV CLV AOLV OLV/PM AOLV/PM CLV/PM EZOLV </div> Sets the gain of internal speed feedback detection suppression while the overvoltage suppression function is working, as a magnification value. Normally there is no need to configure this setting.	1.50 (0.00 - 10.00)

Adjust this parameter in the following circumstances.

- Increase the setting value if resonance or hunting occurs during use of the overvoltage suppression function.
- Reduce the setting value in increments of 0.05 if motor responsiveness is low during use of the overvoltage suppression function.

■ n8-69: Speed Calculation Gain

No. (Hex.)	Name	Description	Default Setting (Range)
n8-69 (065D)	Speed Calculation Gain	<div style="display: flex; justify-content: space-between; font-size: 0.8em; margin-bottom: 5px;"> V/f CL-V/f OLV CLV AOLV OLV/PM AOLV/PM CLV/PM EZOLV </div> Sets the gain used for speed estimation. Normally there is no need to change this setting.	1.00 (0.00 - 20.00)

■ n8-72: Speed Estimation Method Select

No. (Hex.)	Name	Description	Default Setting (Range)
n8-72 (0655)	Speed Estimation Method Select	<div style="display: flex; justify-content: space-between; font-size: 0.8em; margin-bottom: 5px;"> V/f CL-V/f OLV CLV AOLV OLV/PM AOLV/PM CLV/PM EZOLV </div> Selects the speed estimation method. Normally there is no need to change this setting.	1 (0, 1)

0 : Conventional method

1 : A1000 method

■ n8-74: LghtLoadCurLvl 1

No. (Hex.)	Name	Description	Default Setting (Range)
n8-74 (05C3)	LghtLoadCurLvl 1	<div style="display: flex; justify-content: space-between; font-size: 0.8em; margin-bottom: 5px;"> V/f CL-V/f OLV CLV AOLV OLV/PM AOLV/PM CLV/PM EZOLV </div> Set n8-48 [Pull-In Current (for PM Motors)] to the level of the load current (q-axis current) to be applied.	30% (0 - 255%)

Note:

- If the condition $n8-74 \leq n8-75$ [LghtLoadCurLvl 2] is not met, oPE08 [Parameter Selection Error] is displayed.
- Between n8-74 and n8-75 and the level of the pull-in current from n8-48 to n8-78 [MedLoad Id Level], the change is linear.

■ n8-75: LghtLoadCurLvl 2

No. (Hex.)	Name	Description	Default Setting (Range)
n8-75 (05C4)	LghtLoadCurLvl 2	<div style="display: flex; justify-content: space-between; font-size: 0.8em; margin-bottom: 5px;"> V/f CL-V/f OLV CLV AOLV OLV/PM AOLV/PM CLV/PM EZOLV </div> Set n8-78 [MedLoad Id Level] to the level of the load current (q-axis current) to be applied.	50% (0 - 255%)

Note:

- If the condition $n8-74 [LghtLoadCurLvl 1] \leq n8-75$ is not met, *oPE08 [Parameter Selection Error]* is displayed.
- Between $n8-74$ and $n8-75$ and the level of the pull-in current from $n8-48$ to $n8-78 [MedLoad Id Level]$, the change is linear.

■ n8-77: IPM HiEffCtrLev2

No. (Hex.)	Name	Description	Default Setting (Range)
n8-77 (05CE)	IPM HiEffCtrLev2	<div style="display: flex; justify-content: space-between; font-size: small;"> V/f CL-V/f OLV CLV AOLV OLV/PM AOLV/PM CLV/PM EZOLV </div> Set $n8-49 [d-Axis Cur forHighEfficiencyCont]$ to the level of the load current (q-axis current) to be applied.	90% (0 - 255%)

Note:

Between $n8-75 [LghtLoadCurLvl 2]$ and $n8-77$ and the level of the pull-in current from $n8-78 [MedLoad Id Level]$ to $n8-49 [d-Axis Cur forHighEfficiencyCont]$, the change is linear.

■ n8-78: MedLoad Id Level

No. (Hex.)	Name	Description	Default Setting (Range)
n8-78 (05F4)	MedLoad Id Level	<div style="display: flex; justify-content: space-between; font-size: small;"> V/f CL-V/f OLV CLV AOLV OLV/PM AOLV/PM CLV/PM EZOLV </div> Sets the level of the pull-in current for midrange loads.	0% (0 - 255%)

■ n8-84: InitPolarityEstimationTimeoutCur

No. (Hex.)	Name	Description	Default Setting (Range)
n8-84 (02D3)	InitPolarityEstimationTimeoutCur	<div style="display: flex; justify-content: space-between; font-size: small;"> V/f CL-V/f OLV CLV AOLV OLV/PM AOLV/PM CLV/PM EZOLV </div> Sets, as a percentage, the current for processing an estimation of the initial motor magnetic pole, assuming that the $E5-03 [PM Motor Rated Current (FLA)]$ is the 100% value.	100% (0 - 150%)

If using a Yaskawa motor, and the motor nameplate has an “Si” item, set a value equivalent to $Si \times 2$.

Determining Polarity of Magnetic Poles

When starting operation (only the first time when set to $A1-02 = 7 [Control Method Selection = PM Closed Loop Vector Control]$), initial estimation of the magnetic poles is carried out, and the polarity of the magnetic poles is determined.

To check whether or not the polarity of magnetic poles has been recognized correctly as a result of the initial estimation of the magnetic poles, use the monitor parameter $U6-57 [PoleDis IdDifVal]$.

$n8-84$ is set automatically when Stationary Auto-Tuning or Rotational Auto-Tuning is carried out.

Note:

The motor may rotate in the direction that is opposite that of the direction of the Run command if the polarity direction is detected mistakenly.

■ n8-94: Selection of Recognition Criteria

No. (Hex.)	Name	Description	Default Setting (Range)
n8-94 (012D)	Selection of Recognition Criteria	<div style="display: flex; justify-content: space-between; font-size: small;"> V/f CL-V/f OLV CLV AOLV OLV/PM AOLV/PM CLV/PM EZOLV </div> Choose the criteria for recognizing changes in speed or load. Normally there is no need to change this setting.	Determined by d5-01 (0, 1)

0 : Softstarter

1 : Speed feedback

Effective when $n8-57 = 1 [High Frequency Injection = Enabled]$. Improves the stability during times of sudden changes in speed or load, such as with rapid acceleration/deceleration or impact loads.

■ n8-95: Observer Estimation TimeConstant

No. (Hex.)	Name	Description	Default Setting (Range)
n8-95 (012E)	Observer Estimation TimeConstant	<div style="display: flex; justify-content: space-between; font-size: small; margin-bottom: 5px;"> V/f CL-V/f OLV CLV AOLV OLV/PM AOLV/PM CLV/PM EZOLV </div> Sets the time constant of the filter used with respect to the recognition criteria value for speed and load changes. Normally there is no need to change this setting.	30 ms (0 - 100 ms)

Note:

Enabled when $n8-94 = 1$ [Estimate Base Select = Speed feedback].

11.11 o: Keypad-Related Settings

o parameters are used to configure keypad functions.

Note:

The following parameters cannot be configured when using the optional LED keypad.

Table 11.61 Parameters that Cannot be Configured for the LED Keypad

No.	Name	No.	Name
o1-05	LCD Contrast adjustment	o3-04	Select Backup/Restore Location
o1-24 to o1-35	1st to 12th Monitor Settings	o3-05	Select items to Backup/Restore
o1-36	LCD backlight adjustment	o3-06	Auto Parameter Backup Selection
o1-37	LCD backlight ON/OFF Selection	o3-07	Period setting of auto backup
o1-38	Time to turn off LCD backlight	o4-22	Time Format
o1-39	Initial setup display selection	o4-23	Date Format
o1-40	Home display selection	o5-01	Log Start/Stop Selection
o1-41 to o1-46	1st to 3rd Monitor Max/Min Settings	o5-02	Log Sampling Interval
o1-55 to o1-56	Analog Gauge Min Setting	o5-03 to o5-12	Log Monitor Data 1 to 10

◆ o1: Keypad Display Selection

o1 parameters are used to select parameters that appear on the initial keypad screen and to configure the parameter setting units and display units. These parameters are also used to adjust the backlight and contrast of the LCD display.

■ Monitor Display Format

Parameter *o1-40* [Home display selection] is used to change the display of the monitor that appears on the Home screen. Options include numerical values, bar graph display, and analog meter display.

Bar Graph Display

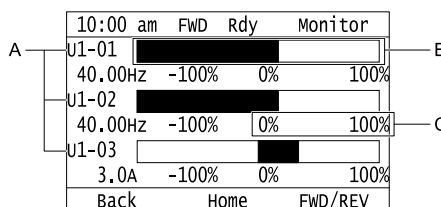

- A - Select *Ux-xx* [Monitors] with *o1-24*, *o1-25*, and *o1-26*.**
- B - Configure display regions with *o1-41*, *o1-43*, and *o1-45*.**
- C - Select display ranges with *o1-42*, *o1-44*, and *o1-46*.**

Analog Meter Display

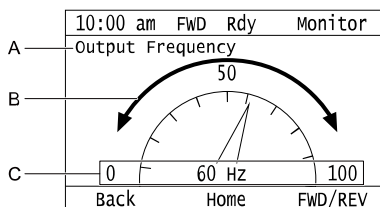

- A - Select *Ux-xx* [Monitors] with *o1-24*.**
- B - Configure display regions with *o1-56*.**
- C - Select display ranges with *o1-55*.**

■ o1-01: Drive Mode Unit Monitor Select

No. (Hex.)	Name	Description	Default Setting (Setting Range)
o1-01 (0500) RUN	Drive Mode Unit Monitor Select	<div style="display: flex; justify-content: space-between; font-size: 0.8em; font-weight: bold;"> V/f CL-V/f OLV CLV AOLV OLV/PM AOLV/PM CLV/PM EZOLV </div> Configure the <i>U</i> monitor that appears for the Drive Mode. This parameter is only enabled for LED keypads.	106 (104 - 855)

Each time the  on the keypad is pressed while the drive is in Drive Mode, the monitor item selected by *o1-01* switches in order of frequency reference, direction of motor rotation, output frequency, and output current.

Configure the *x-xx* portion of the monitoring parameter *Ux-xx* that appears in the fifth position for the Drive Mode. For example, to display *U1-05 [Motor Speed]*, set *o1-01 = 105*.

Note:

- *U2* monitor [*Fault Trace*] and *U3* Monitor [*Fault History*] cannot be selected.
- The selectable monitors vary depending on the control method.

■ o1-02: User Monitor Select afterPowerUp

No. (Hex.)	Name	Description	Default Setting (Setting Range)
o1-02 (0501) RUN	User Monitor Select afterPowerUp	<div style="display: flex; justify-content: space-between; font-size: 0.8em; font-weight: bold;"> V/f CL-V/f OLV CLV AOLV OLV/PM AOLV/PM CLV/PM EZOLV </div> Selects the monitor item initially displayed when the drive is energized. Refer to “U: Monitors” for more information on monitor items that can be displayed. This parameter is only enabled for LED keypads.	1 (1 - 5)

1 : Frequency reference (U1-01)

2 : Direction

3 : Output frequency (U1-02)

4 : Output current (U1-03)

5 : UserSelect Monitor(set by o1-01)

Displays the monitor item selected by *o1-01* [*Drive Mode Unit Monitor Select*].

■ o1-03: Keypad Display Selection

No. (Hex.)	Name	Description	Default Setting (Setting Range)
o1-03 (0502)	Keypad Display Selection	<div style="display: flex; justify-content: space-between; font-size: 0.8em; font-weight: bold;"> V/f CL-V/f OLV CLV AOLV OLV/PM AOLV/PM CLV/PM EZOLV </div> Selects the display units for the frequency reference and output frequency.	Determined by A1-02 (0 - 3)

Note:

When the setting value of *o1-03* is changed, the following monitor and parameter units change as well.

- *U1-01* [*Freq Reference*]
- *U1-02* [*Output Frequency*]
- *U1-05* [*Motor Speed*]
- *U1-16* [*SFS Output Frequency*]
- *d1-01* to *d1-17* [*Reference 1 to 17*]

0 : 0.01 Hz

1 : 0.01% (100% = E1-04)

The maximum output frequency is 100%.

2 : r/min

Calculated automatically based on the maximum output frequency and number of motor poles.

Note:

If *o1-03 = 2* [*r/min*], be sure to set the number of motor poles to the following parameters.

- *E2-04* [*Motor Pole Count*]
- *E4-04* [*Motor 2 Motor Poles*]
- *E5-04* [*PM Motor Pole Count*]
- *E9-08* [*Number of Poles*]

3 : User-selected units

Parameters *o1-10* and *o1-11* can be used to configure the unit of measure as desired when *o1-03* = 3. Parameter *o1-10* is set to the value resulting from removing the decimal point from the maximum output frequency. Parameter *o1-11* is set to the number of digits after the decimal point in the maximum output frequency.

To display a maximum output frequency of 100.00, set the following parameters as follows.

- *o1-10* = 10000
- *o1-11* = 2 [*User Units Decimal Position* = 2 Dec (XXX.XX)]

■ o1-04: V/f Pattern Display Unit

No. (Hex.)	Name	Description	Default Setting (Setting Range)
o1-04 (0503)	V/f Pattern Display Unit	<div style="display: flex; justify-content: space-between; font-size: 0.8em;"> V/f CL-V/f OLV CLV AOLV OLV/PM AOLV/PM CLV/PM EZOLV </div> Select the setting unit of parameters that configure the V/f pattern frequency.	Determined by A1-02 (0, 1)

Note:

- Select the setting unit of the following parameters for motor 1.
 - E1-04 [*Maximum Output Frequency*]
 - E1-06 [*Base Frequency*]
 - E1-07 [*Mid Point A Frequency*]
 - E1-09 [*Minimum Output Frequency*]
 - E1-11 [*Mid Point B Frequency*]
 - E9-02 [*Motor Max Revolutions*]
 - E9-04 [*Motor Rated Frequency*]
- Select the setting unit of the following parameters for motor 2.
 - E3-04 [*Motor 2 Maximum Output Frequency*]
 - E3-06 [*Motor 2 Base Frequency*]
 - E3-07 [*Motor 2 Mid Point A Frequency*]
 - E3-09 [*Motor 2 Minimum Output Frequency*]
 - E3-11 [*Motor 2 Mid Point B Frequency*]

0 : Hz

1 : r/min

The number of motor poles must be configured for the following parameters if *o1-04* = 1 [*r/min*].

- E2-04 [*Motor Pole Count*]
- E4-04 [*Motor 2 Motor Poles*]
- E5-04 [*PM Motor Pole Count*]
- E9-08 [*Motor Pole Count*]

■ o1-05: LCD Contrast adjustment

No. (Hex.)	Name	Description	Default Setting (Setting Range)
o1-05 (0504) RUN	LCD Contrast adjustment	<div style="display: flex; justify-content: space-between; font-size: 0.8em;"> V/f CL-V/f OLV CLV AOLV OLV/PM AOLV/PM CLV/PM EZOLV </div> Configures the LCD display contrast.	3 (0 - 5)

Reducing the setting value decreases the contrast of the LCD display. Increasing the setting value increases the contrast.

■ o1-10: User-Set Display Units Max Value

No. (Hex.)	Name	Description	Default Setting (Setting Range)
o1-10 (0520)	User-Set Display Units Max Value	<div style="display: flex; justify-content: space-between; font-size: 0.8em;"> V/f CL-V/f OLV CLV AOLV OLV/PM AOLV/PM CLV/PM EZOLV </div> Configures the value displayed for the maximum output frequency.	Determined by o1-03 (1 - 60000)

To display a maximum output frequency of 100.00, set the following parameters as follows.

- *o1-10* = 10000
- *o1-11* = 2 [*User Units Decimal Position* = 2 Dec (XXX.XX)]

11.11 o: Keypad-Related Settings

Note:

Before configuring *o1-10* and *o1-11*, configure *o1-03* = 3 [*Keypad Display Selection* = *User-selected units*].

■ o1-11: User-SetDisplayUnits Dec Display

No. (Hex.)	Name	Description	Default Setting (Setting Range)
o1-11 (0521)	User-SetDisplayUnits Dec Display	<input type="checkbox"/> V/f <input type="checkbox"/> CL-V/f <input type="checkbox"/> OLV <input type="checkbox"/> CLV <input type="checkbox"/> AOLV <input type="checkbox"/> OLV/PM <input type="checkbox"/> AOLV/PM <input type="checkbox"/> CLV/PM <input type="checkbox"/> EZOLV Configures the number of decimal places for frequency reference and monitor values.	Determined by o1-03 (0 - 3)

0 : No Dec (XXXXX)

1 : 1 Dec (XXXX.X)

2 : 2 Dec (XXX.XX)

3 : 3 Dec (XX.XXX)

Note:

Before configuring *o1-10* [*User-Set Display Units Max Value*] and *o1-11*, set *o1-03* = 3 [*Keypad Display Selection* = *User-selected units*].

■ o1-24 to o1-35: 1st to 12th Monitor Settings

No. (Hex.)	Name	Description	Default Setting (Setting Range)
o1-24 to o1-35 (11AD to 11B8) RUN	1st to 12th Monitor Settings	<input type="checkbox"/> V/f <input type="checkbox"/> CL-V/f <input type="checkbox"/> OLV <input type="checkbox"/> CLV <input type="checkbox"/> AOLV <input type="checkbox"/> OLV/PM <input type="checkbox"/> AOLV/PM <input type="checkbox"/> CLV/PM <input type="checkbox"/> EZOLV Up to a maximum of 12 desired monitors can be selected as user monitors. This parameter is only enabled for LED keypads.	o1-24: 101 o1-25: 102 o1-26: 103 o1-27 to o1-35: 000 (000, 101 - 825)

Monitor items selected by the LCD keypad [*User Monitors*] are stored in these parameters.

Note:

- Up to three selected monitors can be displayed on one LCD keypad screen.
 - If only one monitor is selected, this monitor appears enlarged. For example, when *o1-25 through o1-35* = 000, the monitor selected with *o1-24* appears enlarged.
 - If only two monitors are selected, these monitors appear enlarged.
 - When 4 or more monitors are selected, the fourth and subsequent monitors appear on subsequent screens.
- Monitors selected with *o1-24* through *o1-26* can be displayed as bar graphs or analog meters.
 - Bar graph display: Up to 3 maximum
Select with *o1-24*, *o1-25*, and *o1-26*.
 - Analog meter display: 1
Select with *o1-24*.

■ o1-36: LCD backlight adjustment

No. (Hex.)	Name	Description	Default Setting (Setting Range)
o1-36 (11B9) RUN	LCD backlight adjustment	<input type="checkbox"/> V/f <input type="checkbox"/> CL-V/f <input type="checkbox"/> OLV <input type="checkbox"/> CLV <input type="checkbox"/> AOLV <input type="checkbox"/> OLV/PM <input type="checkbox"/> AOLV/PM <input type="checkbox"/> CLV/PM <input type="checkbox"/> EZOLV Configures the brightness of the LCD keypad backlight.	3 (1 - 5)

Reducing the setting value lowers the brightness of the backlight. Increasing the setting value increases the brightness.

■ o1-37: LCD backlight ON/OFF Selection

No. (Hex.)	Name	Description	Default Setting (Setting Range)
o1-37 (11BA) RUN	LCD backlight ON/OFF Selection	<input type="checkbox"/> V/f <input type="checkbox"/> CL-V/f <input type="checkbox"/> OLV <input type="checkbox"/> CLV <input type="checkbox"/> AOLV <input type="checkbox"/> OLV/PM <input type="checkbox"/> AOLV/PM <input type="checkbox"/> CLV/PM <input type="checkbox"/> EZOLV Selects the operation of the LCD backlight automatic shut off function.	1 (0, 1)

Note:

The brightness of the LCD backlight is adjusted with *o1-36* [*LCD backlight adjustment*].

0 : OFF**1 : ON**

Enables the automatic shut off function. The time at which the LCD backlight automatically turns off is configured with *o1-38* [Time to turn off LCD backlight].

■ o1-38: Time to turn off LCD backlight

No. (Hex.)	Name	Description	Default Setting (Setting Range)
o1-38 (11BB) RUN	Time to turn off LCD backlight	V/f CL-V/f OLV CLV AOLV OLV/PM AOLV/PM CLV/PM EZOLV Configures the time at which the LCD backlight automatically turns off.	60 s (10 - 300 s)

If *o1-37* = 1 [LCD backlight ON/OFF Selection = ON], after the time configured by *o1-38* elapses, the backlight will automatically turn off.

When any key on the keypad is pressed while the backlight is off, the backlight will temporarily turn back on. Once the backlight turns back on, the backlight will automatically turn off again after the time configured by *o1-38* elapses.

■ o1-39: Initial Setup Display Selection

No. (Hex.)	Name	Description	Default Setting (Setting Range)
o1-39 (11BC)	Initial setup display selection	V/f CL-V/f OLV CLV AOLV OLV/PM AOLV/PM CLV/PM EZOLV Selects whether or not to display the LCD keypad initial setup screen every time the power is turned on. This parameter is only enabled for LED keypads.	1 (0, 1)

The initial setup screen displays a menu to select the display language, configure the date, time, and other basic settings. Set the parameter to 0 to cancel the display of this screen every time the power is turned on.

0 : No

When *o1-39* = 0, the Home screen appears when the power is turned on.

1 : Yes

If the Run command has been input from before the power is turned on, or if the Run command is turned on while the initial setup screen appears, the initial setup screen disappears, and the Home screen appears even if *o1-39* = 1.

■ o1-40: Home display selection

No. (Hex.)	Name	Description	Default Setting (Setting Range)
o1-40 (11BD) RUN	Home display selection	V/f CL-V/f OLV CLV AOLV OLV/PM AOLV/PM CLV/PM EZOLV Selects the monitor display mode used to display the Home screen. This parameter is only enabled for LED keypads.	0 (0 - 2)

0 : Custom Monitor**1 : Bar Graph****2 : Line Graph / XY Plot**

■ o1-41: 1st Monitor Min Setting

No. (Hex.)	Name	Description	Default Setting (Setting Range)
o1-41 (11C1) RUN	1st Monitor Min Setting	V/f CL-V/f OLV CLV AOLV OLV/PM AOLV/PM CLV/PM EZOLV Selects the horizontal axis used to display the monitor configured with <i>o1-24</i> as a bar graph. This parameter is only enabled for LED keypads.	0 (0 - 2)

0 : + - Area (- o1-42 ~ o1-42)**1 : + Area (0 ~ o1-42)****2 : - Area (- o1-42 ~ 0)**

■ o1-42: 1st Monitor Max Setting

No. (Hex.)	Name	Description	Default Setting (Setting Range)
o1-42 (11C2) RUN	1st Monitor Max Setting	<div style="display: flex; justify-content: space-between; font-size: 0.8em; font-weight: bold; margin-bottom: 5px;"> V/f CL-V/f OLV CLV AOLV OLV/PM AOLV/PM CLV/PM EZOLV </div> Configures the setting value for the horizontal axis used to display the monitor configured with o1-24 as a bar graph. This parameter is only enabled for LED keypads.	100.0% (0.0 - 100.0%)

■ o1-43: 2nd Monitor Min Setting

No. (Hex.)	Name	Description	Default Setting (Setting Range)
o1-43 (1131) RUN	2nd Monitor Min Setting	<div style="display: flex; justify-content: space-between; font-size: 0.8em; font-weight: bold; margin-bottom: 5px;"> V/f CL-V/f OLV CLV AOLV OLV/PM AOLV/PM CLV/PM EZOLV </div> Selects the horizontal axis used to display the monitor configured with o1-25 as a bar graph. This parameter is only enabled for LED keypads.	0 (0 - 2)

0 : + - Area (- o1-46 ~ o1-46)

1 : + Area (0 ~ o1-46)

2 : - Area (- o1-46 ~ 0)

■ o1-44: 2nd Monitor Max Setting

No. (Hex.)	Name	Description	Default Setting (Setting Range)
o1-44 (11C4) RUN	2nd Monitor Max Setting	<div style="display: flex; justify-content: space-between; font-size: 0.8em; font-weight: bold; margin-bottom: 5px;"> V/f CL-V/f OLV CLV AOLV OLV/PM AOLV/PM CLV/PM EZOLV </div> Configures the setting value for the horizontal axis used to display the monitor configured with o1-25 as a bar graph. This parameter is only enabled for LED keypads.	100.0% (0.0 - 100.0%)

■ o1-45: 3rd Monitor Min Setting

No. (Hex.)	Name	Description	Default Setting (Setting Range)
o1-45 (11C5) RUN	3rd Monitor Min Setting	<div style="display: flex; justify-content: space-between; font-size: 0.8em; font-weight: bold; margin-bottom: 5px;"> V/f CL-V/f OLV CLV AOLV OLV/PM AOLV/PM CLV/PM EZOLV </div> Selects the horizontal axis used to display the monitor configured with o1-26 as a bar graph. This parameter is only enabled for LED keypads.	0 (0 - 2)

0 : + - Area (- o1-46 ~ o1-46)

1 : + Area (0 ~ o1-46)

2 : - Area (- o1-46 ~ 0)

■ o1-46: 3rd Monitor Max Setting

No. (Hex.)	Name	Description	Default Setting (Setting Range)
o1-46 (11C6) RUN	3rd Monitor Max Setting	<div style="display: flex; justify-content: space-between; font-size: 0.8em; font-weight: bold; margin-bottom: 5px;"> V/f CL-V/f OLV CLV AOLV OLV/PM AOLV/PM CLV/PM EZOLV </div> Configures the setting value for the horizontal axis used to display the monitor configured with o1-26 as a bar graph. This parameter is only enabled for LED keypads.	100.0% (0.0 - 100.0%)

■ o1-55: Analog Gauge Min Setting

No. (Hex.)	Name	Description	Default Setting (Setting Range)
o1-55 (11EE) RUN	Analog Gauge Min Setting	<div style="display: flex; justify-content: space-between; font-size: 0.8em; font-weight: bold; margin-bottom: 5px;"> V/f CL-V/f OLV CLV AOLV OLV/PM AOLV/PM CLV/PM EZOLV </div> Selects the region used to display the monitor configured with o1-24 [1st Monitor Setting] as an analog meter. This parameter is only enabled for LED keypads.	1 (1)

■ o1-56: Analog Gauge Area Setting

No. (Hex.)	Name	Description	Default Setting (Setting Range)
o1-56 (11EF) RUN	Analog Gauge Area Setting	 Configures the setting value used when displaying the monitor configured with o1-24 [1st Monitor Setting] as an analog meter. This parameter is only enabled for LED keypads.	100.0% (0.0 - 100.0%)

◆ o2: Keypad Operation

■ o2-01: LO/RE Key Function Selection

No. (Hex.)	Name	Description	Default (Range)
o2-01 (0505)	LO/RE Key Function Selection	 Selects whether to enable or disable switching between local and remote modes via .	1 (0, 1)

0 : Disabled

Switching using is disabled.

1 : Enabled

Switching using is enabled. The switch can only be performed when the drive is stopped. The on the keypad will be lit while Local mode is selected.

WARNING! Sudden Movement Hazard. The drive may start unexpectedly if switching control sources when setting b1-07 = 1 [LOCAL/REMOTE Run Selection = Accept existing RUN command]. Clear all personnel from rotating machinery and electrical connections prior to switching control sources. Failure to comply may cause death or serious injury.

WARNING! Sudden Movement Hazard. Check all mechanical or electrical connections thoroughly before making any setting changes to o2-01 [LO/RE Key Function Selection] and b1-07 [LOCAL/REMOTE Run Selection]. The drive may start unexpectedly if the Run command is already applied when switching from LOCAL mode to REMOTE mode when setting b1-07 = 1 [Accept existing RUN command], resulting in personal injury.

Table 11.62 Function Settings via o2-01 through b1-07

function selection	LOCAL/REMOTE Run Selection	Switching from Local Mode to Remote Mode	Switching from Remote Mode to Local Mode
o2-01 = 0 [Disabled]	b1-07 = 0 [Cycle existing RUN command]	Switching cannot be performed.	Switching cannot be performed.
	b1-07 = 1 [Accept existing RUN command]		
o2-01 = 1 [Enabled]	b1-07 = 0 [Cycle existing RUN command]	The drive does not start operating even if the Run command is set active. However, if the Run command is set active again, the drive will start to run.	Drive cannot operate as the Run command is not enabled.
	b1-07 = 1 [Accept existing RUN command]	If the Run command is set active, the drive will start to run at the same time as the mode switches from Local Mode to Remote Mode.	Drive cannot operate as the Run command is not enabled.

■ o2-02: STOP Key Function Selection

No. (Hex.)	Name	Description	Default Setting (Setting Range)
o2-02 (0506)	STOP Key Function Selection	 Selects whether or not to enable functionality of the on the keypad when the Run command source for the drive is set to REMOTE (external) and not assigned to the keypad.	1 (0, 1)









0 : Disabled

1 : Enabled

The  is still enabled when the Run command source has not been assigned to the keypad.

When restarting the drive after pressing the  to stop operation, turn the external Run command off and then on again.

■ **o2-03: User Parameter Default Value**

No. (Hex.)	Name	Description	Default Setting (Setting Range)
o2-03 (0507)	User Parameter Default Value	         Changed parameter setting values are stored as the user parameter default settings used when the drive is initialized.	0 (0 - 2)

When *o2-03 = 1 [Set defaults]*, changed parameter settings are saved as user parameter setting values in a region of memory separate from drive parameters.

When initialization is performed while *A1-03 = 1110 [Initialize Parameters = User initialization]*, the internal drive parameter setting values are reset to the user parameter setting values that are saved when *o2-03 = 1*.

0 : No change

1 : Set defaults

Stores changed parameter setting values as user default settings.









When *o2-03 = 1*, pressing the  on the keypad stores the user parameter setting value. Once the setting value has been stored, *o2-03* automatically resets to 0.

2 : Clear all

When *o2-03 = 1*, the stored user parameter setting values are cleared.

When *o2-03 = 2*, pressing the  on the keypad clears the user parameter setting value. Parameter *o2-03* is automatically reset to 0. If user parameter setting values have been cleared, parameter initialization with a configuration of *A1-03 = 1110* cannot be executed.

■ **o2-04: Drive Model Selection**











No. (Hex.)	Name	Description	Default Setting (Setting Range)
o2-04 (0508)	Drive Model Selection	         Configures the Drive Model code for the corresponding Drive Model. This parameter must be configured when control boards are replaced.	Determined by the drive (-)

NOTICE: If *o2-04 [Drive Model Selection]* is not configured correctly, this will not only degrade performance, but this may also result in the protection function not operating correctly, which could lead to the drive becoming damaged.

Note:

When the setting value of *o2-04* is changed, related parameter setting values are also changed. Refer to “Parameters Changed from Default Values with *o2-04 [Drive Model Selection]*” for more information.

■ **o2-05: Freq Ref Setting Method Select**



No. (Hex.)	Name	Description	Default Setting (Setting Range)
o2-05 (0509)	Freq Ref Setting Method Select	         Selects whether or not the  must be pressed to change the frequency reference value with the keypad when in Drive Mode.	0 (0, 1)

0 : Disabled

The  must be pressed to enable the frequency reference value changed with the keypad.

1 : Enabled

The frequency reference is changed as soon as it is entered with the keypad, which then changes the output

frequency. Thus, the  does not need to be pressed. The drive stores the frequency reference 5 seconds after the frequency reference value is changed using the  and  on the keypad.

■ o2-06: Ope Select @Keypad is Disconnect

No. (Hex.)	Name	Description	Default Setting (Setting Range)
o2-06 (050A)	Ope Select @Keypad is Disconnect	V/f CL-V/f OLV CLV AOLV OLV/PM AOLV/PM CLV/PM EZOLV Selects whether or not to stop the drive when the keypad connection cable is disconnected from the drive or damaged while the keypad is the Run command source.	0 (0, 1)

This parameter operates even when the keypad installed to the drive becomes disconnected. This parameter is enabled in the following circumstances.

- When $b1-02 = 0$ [Run Command Selection 1 = Keypad] or $b1-16 = 0$ [Run Command Selection 2 = Keypad]
- Using Local mode

0 : Disabled

The drive continues to operate even when a keypad disconnection is detected.

1 : Enabled

Once a keypad disconnection is detected, the drive stops operating and the *oPr* [Keypad Connection Fault] indicator appears. The motor coasts to stop.

■ o2-07: MotorDirect@PowUpWhenUsingKeypad

No. (Hex.)	Name	Description	Default Setting (Setting Range)
o2-07 (0527)	MotorDirect@PowUpWhenUsingKeypad	V/f CL-V/f OLV CLV AOLV OLV/PM AOLV/PM CLV/PM EZOLV Selects the direction of motor rotation when the power is turned on when the keypad is the Run command source.	0 (0, 1)

This parameter is enabled in the following circumstances.

- When $b1-02 = 0$ [Run Command Selection 1 = Keypad] or $b1-16 = 0$ [Run Command Selection 2 = Keypad]
- Using local mode

0 : Forward

1 : Reverse

■ o2-09: Reserved

No. (Hex.)	Name	Description	Default Setting (Setting Range)
o2-09 (050D)	Factory use	-	-

■ o2-23: Lost Detection of Ext. Power 24V

No. (Hex.)	Name	Description	Default Setting (Setting Range)
o2-23 (11F8)	Lost Detection of Ext. Power 24V	V/f CL-V/f OLV CLV AOLV OLV/PM AOLV/PM CLV/PM EZOLV Selects whether or not to provide warning when the backup external 24-V power supply turns off while the main circuit power supply is supplied.	0 (0, 1)

Note:

The drive cannot run when operating via a single 24-V external power supply.

0 : Disabled

The loss of the 24-V external power supply is not detected.

1 : Enabled

The *L24v* [Ext. 24-V Power Supply Lost] indicator appears when the loss of the 24-V external power supply is detected.

Note:

The minor fault signal is not output from the terminal assigned the configuration of $H2-xx = 10$ [Multi-Function Digital Out = Minor Fault].

■ o2-24: LED Light Function Selection

No. (Hex.)	Name	Description	Default Setting (Setting Range)
o2-24 (11FE)	LED Light Function Selection	<div style="display: flex; justify-content: space-between; font-size: 0.8em; font-weight: bold;"> V/f CL-V/f OLV CLV AOLV OLV/PM AOLV/PM CLV/PM EZOLV </div> Selects the option to enable or disable the LED status rings and LED lamps on the keypad.	0 (0 - 2)

0 : Both Enable

1 : LED Status Ring Disable

2 : Keypad LED Light Disable

◆ o3: Copy Function

o3 parameters are used to configure the operation of the parameter backup function.

■ o3-01: Copy Function Selection

No. (Hex.)	Name	Description	Default (Range)
o3-01 (0515)	Copy Function Selection	<div style="display: flex; justify-content: space-between; font-size: 0.8em; font-weight: bold;"> V/f CL-V/f OLV CLV AOLV OLV/PM AOLV/PM CLV/PM EZOLV </div> Drive parameters can be saved and copied to another drive using the keypad.	0 (0 - 3)

0 : Copy select

1 : Drive → Keypad Backup

The parameter setting values are read from the drive and stored in the keypad.

2 : Keypad → Drive Restore

Copies the parameter setting values stored in the keypad to another drive.

3 : Keypad ↔ Drive (compare)

Verifies that parameter setting values in the drive match the parameters stored in the keypad.

■ o3-02: Copy Allowed Selection

No. (Hex.)	Name	Description	Default Setting (Setting Range)
o3-02 (0516)	Copy Allowed Selection	<div style="display: flex; justify-content: space-between; font-size: 0.8em; font-weight: bold;"> V/f CL-V/f OLV CLV AOLV OLV/PM AOLV/PM CLV/PM EZOLV </div> Selects the enabled/disabled status of backup when <i>o3-01 = 1</i> [<i>Copy Function Selection = Drive → Keypad Backup</i>].	0 (0, 1)

Note:

When the backup function is executed by selecting [Parameter Backup] on the keypad menu screen, *o3-02* is automatically set to *1*.

0 : Disabled

1 : Enabled

■ o3-04: Select Backup/Restore Location

No. (Hex.)	Name	Description	Default Setting (Setting Range)
o3-04 (0B3E)	Select Backup/Restore Location	<div style="display: flex; justify-content: space-between; font-size: 0.8em; font-weight: bold;"> V/f CL-V/f OLV CLV AOLV OLV/PM AOLV/PM CLV/PM EZOLV </div> Selects the storage region for drive parameters when backing up and restoring parameters. This parameter is only enabled for LED keypads.	0 (0 - 3)

Up to a maximum of 4 parameter backup paths can be used with the LCD keypad.

0 : Memory Location 0

1 : Memory Location 1

2 : Memory Location 2

3 : Memory Location 3

■ o3-05: Select items to Backup/Restore

No. (Hex.)	Name	Description	Default Setting (Setting Range)
o3-05 (0BDA)	Select items to Backup/Restore	V/f CL-V/f OLV CLV AOLV OLV/PM AOLV/PM CLV/PM EZOLV Selects the parameters that are backed up, restored, and referenced. This parameter is only enabled for LED keypads.	0 (0, 1)

0 : Standard Parameters

1 : Standard + DWEZ Parameters

The standard, qx-xx, and rx-xx parameters are backed up, restored, and referenced.

Note:

- The qx-xx and rx-xx parameters appear when $A1-07 = 1$ or 2 [DriveWorksEZ Function Selection = DWEZ Enabled or Digital input].
- When $o3-05 = 1$, parameters are only restored and verified.

■ o3-06: Auto Parameter Backup Selection

No. (Hex.)	Name	Description	Default Setting (Setting Range)
o3-06 (0BDE)	Auto Parameter Backup Selection	V/f CL-V/f OLV CLV AOLV OLV/PM AOLV/PM CLV/PM EZOLV Selects whether to enable or disable the automatic parameter backup function. This parameter is only enabled for LED keypads.	1 (0, 1)

When the drive and keypad are connected, parameters configured to the drive are automatically backed up to the keypad in accordance with the configuration of parameters $o3-06$ and $o3-07$.

0 : Disabled

1 : Enabled

■ o3-07: Period setting of auto backup

No. (Hex.)	Name	Description	Default Setting (Setting Range)
o3-07 (0BDF)	Period setting of auto backup	V/f CL-V/f OLV CLV AOLV OLV/PM AOLV/PM CLV/PM EZOLV Configures the interval at which the automatic parameter backup function saves parameters from the drive to the keypad.	1 (0 - 3)

The parameters are stored in the keypad at the following timing.

1. The drive is energized and the set cycle time passes.
2. After the above 1, when a parameter is changed by the ROM enter or the keypad is operated and when the set cycle time passes after that, there is a parameter that was stored in the drive after the backup was stored in the keypad.

Note:

Consider the maximum number of backups when configuring the auto backup period setting. The maximum number of times that data can be written to the keypad is 100000 times. Exceeding this limit may cause data access errors to occur, which could cause keypad failure.

0 : every 10 minutes

1 : every 30 minutes

2 : every 60 minutes

3 : every 12 hours

◆ o4: Maintenance Mon Settings

$o4$ parameters are used to configure the expected service life used as an indicator of when to replace parts. An alarm provides notification when the configured part replacement interval is near.

■ o4-01: Cumulative Operation TimeSetting

No. (Hex.)	Name	Description	Default (Range)
o4-01 (050B)	Cumulative Operation TimeSetting	<div style="display: flex; justify-content: space-between; font-size: 0.8em; font-weight: bold;"> V/f CL-V/f OLV CLV AOLV OLV/PM AOLV/PM CLV/PM EZOLV </div> Configures the initial value of the cumulative drive operation time in units of 10 hours.	0 h (0 - 9999 h)

Selecting *o4-01* on the keypad displays the current value of *U4-01* in units of 10 hours (h). When the setting of *o4-01* is changed via the monitor, the recount of *U4-01* starts in accordance with the setting of *o4-01*.

Note:

Parameter *o4-01* is configured in units of 10 hours (h). When *o4-01* = 30, *U4-01* [Cumulative Ope Time] = 300 h appears.

■ o4-02: Cumulative Operation Time Select

No. (Hex.)	Name	Description	Default Setting (Setting Range)
o4-02 (050C)	Cumulative Operation Time Select	<div style="display: flex; justify-content: space-between; font-size: 0.8em; font-weight: bold;"> V/f CL-V/f OLV CLV AOLV OLV/PM AOLV/PM CLV/PM EZOLV </div> Selects the condition used to count the cumulative operation time.	0 (0, 1)

0 : Logs power-on time

Counts the time when the drive is energized up to when it is de-energized.

1 : Running Time

Counts the time that the drive outputs voltage.

■ o4-03: CoolingFan OperationTime Setting

No. (Hex.)	Name	Description	Default Setting (Setting Range)
o4-03 (050E)	CoolingFan OperationTime Setting	<div style="display: flex; justify-content: space-between; font-size: 0.8em; font-weight: bold;"> V/f CL-V/f OLV CLV AOLV OLV/PM AOLV/PM CLV/PM EZOLV </div> Sets the value from which to start the cumulative drive cooling fan operation time in 10-hour units.	0 h (0 - 9999 h)

The cumulative cooling fan operation time can be monitored with *U4-03* [Cooling Fan Ope Time]. If a cooling fan is replaced, make sure to set *o4-03* = 0 and reset the value of *U4-03*. Selecting *o4-03* on the keypad displays the current value of *U4-03* in units of 10 hours (h). When the setting of *o4-03* is changed via the monitor, the recount of *U4-03* starts in accordance with the setting of *o4-03*.

Note:

Parameter *o4-03* is configured in units of 10 hours (h). When *o4-03* = 30, *U4-03* [Cooling Fan Ope Time] = 300 h appears.

■ o4-05: Capacitor Maintenance Setting

No. (Hex.)	Name	Description	Default Setting (Setting Range)
o4-05 (051D)	Capacitor Maintenance Setting	<div style="display: flex; justify-content: space-between; font-size: 0.8em; font-weight: bold;"> V/f CL-V/f OLV CLV AOLV OLV/PM AOLV/PM CLV/PM EZOLV </div> <i>U4-05</i> [CapacitorMaintenance] monitor values can be overwritten.	0% (0 - 150%)

If a drive is replaced, make sure to set *o4-05* = 0 and reset the value of *U4-05*. When the setting of *o4-05* is changed, the recount of *U4-05* starts in accordance with the setting of *o4-05*. Once the configuration is complete, the setting value of *o4-05* automatically resets to 0.

Note:

The maintenance period differs depending on the environment in which the drive is used.

■ o4-07: DCBusPreChargeRelayMainteSetting

No. (Hex.)	Name	Description	Default Setting (Setting Range)
o4-07 (0523)	DCBusPreChargeRelayMainteSetting	<div style="display: flex; justify-content: space-between; font-size: 0.8em; font-weight: bold;"> V/f CL-V/f OLV CLV AOLV OLV/PM AOLV/PM CLV/PM EZOLV </div> <i>U4-06</i> [SCHgBypassRelayMaint] monitor values can be overwritten.	0% (0 - 150%)

If a drive is replaced, make sure to set $o4-07 = 0$ and reset the value of $U4-06$. When the setting of $o4-07$ is changed, the recount of $U4-06$ starts in accordance with the setting of $o4-07$. Once the configuration is complete, the setting value of $o4-07$ automatically resets to 0.

Note:

The maintenance period differs depending on the environment in which the drive is used.

■ o4-09: IGBT Maintenance Setting

No. (Hex.)	Name	Description	Default Setting (Setting Range)
o4-09 (0525)	IGBT Maintenance Setting	V/f CL-V/f OLV CLV AOLV OLV/PM AOLV/PM CLV/PM EZOLV $U4-07$ [IGBT Maintenance] monitor values can be overwritten.	0% (0 - 150%)

If a drive is replaced, make sure to set $o4-09 = 0$ and reset the value of $U4-07$. When the setting of $o4-09$ is changed, the recount of $U4-07$ starts in accordance with the setting of $o4-09$. Once the configuration is complete, the setting value of $o4-09$ automatically resets to 0.

Note:

The maintenance period differs depending on the environment in which the drive is used.

■ o4-11: U2, U3 Initialization

No. (Hex.)	Name	Description	Default Setting (Setting Range)
o4-11 (0510)	U2, U3 Initialization	V/f CL-V/f OLV CLV AOLV OLV/PM AOLV/PM CLV/PM EZOLV Resets the records of Monitors $U2-xx$ [Fault Trace] and $U3-xx$ [Fault History].	0 (0, 1)

Note:

The records for $U2-xx$ and $U3-xx$ are not reset even after initializing the drive with $A1-03$ [Initialize Parameters].

0 : No Reset

Retains the records of Monitors $U2-xx$ and $U3-xx$.

1 : Reset

Resets the records for Monitors $U2-xx$ and $U3-xx$. After the reset, the setting value of $o4-11$ is automatically reset to 0.

■ o4-12: kWh Monitor Initialization

No. (Hex.)	Name	Description	Default Setting (Setting Range)
o4-12 (0512)	kWh Monitor Initialization	V/f CL-V/f OLV CLV AOLV OLV/PM AOLV/PM CLV/PM EZOLV Resets the monitor values for $U4-10$ [kWh, Lower 4 Digits] and $U4-11$ [kWh, Upper 5 Digits].	0 (0, 1)

Note:

The values of $U4-10$ and $U4-11$ are not reset even after initializing the drive with $A1-03$ [Initialize Parameters].

0 : No Reset

Retains the monitor values for $U4-10$ and $U4-11$.

1 : Reset

Resets the monitor values for $U4-10$ and $U4-11$. After the reset, the setting value of $o4-12$ is automatically reset to 0.

■ o4-13: NumOfRunCommands Counter Initial

No. (Hex.)	Name	Description	Default Setting (Setting Range)
o4-13 (0528)	NumOfRunCommands Counter Initial	V/f CL-V/f OLV CLV AOLV OLV/PM AOLV/PM CLV/PM EZOLV Resets the monitor values for $U4-02$ [Num of Run Commands], $U4-24$ [No of Travels(L)], and $U4-25$ [No of Travels(H)].	0 (0, 1)

0 : No Reset

Retains the monitor values for $U4-02$, $U4-24$, and $U4-25$.

1 : Reset

Resets the monitor values for *U4-02*, *U4-24*, and *U4-25*. After the reset, the setting value of *o4-13* is automatically reset to 0.

■ o4-22: Time Format

No. (Hex.)	Name	Description	Default Setting (Setting Range)
o4-22 (154F)	Time Format	V/f CL-V/f OLV CLV AOLV OLV/PM AOLV/PM CLV/PM EZOLV Selects the time display format. This parameter is only enabled for LED keypads.	0 (0 - 2)

The format display of the time that appears in the upper-left of the LCD keypad screen varies depending on the setting of *o4-22*.

0 : 24 hour clock

1 : 12 hour EA clock

2 : 12 hour JP clock

■ o4-23: Date Format

No. (Hex.)	Name	Description	Default Setting (Setting Range)
o4-23 (1550)	Date Format	V/f CL-V/f OLV CLV AOLV OLV/PM AOLV/PM CLV/PM EZOLV Selects the date display format. This parameter is only enabled for LED keypads.	0 (0 - 2)

The date format used in the fault history and such varies depending on the setting of *o4-23*.

0 : YYYY/MM/DD(2016/01/31)

1 : DD/MM/YYYY(31/01/2016)

2 : MM/DD/YYYY(01/31/2016)

■ o4-24: bAT Detection Operation Selection

No. (Hex.)	Name	Description	Default (Range)
o4-24 (310F) RUN	bAT Detection Operation Selection	V/f CL-V/f OLV CLV AOLV OLV/PM AOLV/PM CLV/PM EZOLV Selects the operation performed when bAT (low keypad battery) faults are detected.	0 (0, 1)

0 : Disabled

Do not detect.

1 : Enabled

Detect as a minor fault.

◆ o5: Log Function

The data log function stores drive state information as a CSV file in the micro SD memory card in the keypad. *Monitors Ux-xx* are the source of data log information. Up to a maximum of 10 monitors can be recorded.

Change the LCD keypad screen from the main menu to the tools screen and select the data log function.

Configure the number of the monitor to record and the sampling time and then start recording the data log.

Table 11.63 Setting Parameters for Data Log Items

No.	Name	Default Setting	Data log monitors
<i>o5-03</i>	Log Monitor Data 1	101	<i>U1-01</i> [Freq Reference]
<i>o5-04</i>	Log Monitor Data 2	102	<i>U1-02</i> [Output Frequency]
<i>o5-05</i>	Log Monitor Data 3	103	<i>U1-03</i> [Output Current]
<i>o5-06</i>	Log Monitor Data 4	107	<i>U1-07</i> [DC Bus Voltage]
<i>o5-07</i>	Log Monitor Data 5	108	<i>U1-08</i> [Output Power]

No.	Name	Default Setting	Data log monitors
o5-08	Log Monitor Data 6	000	Not selected
o5-09	Log Monitor Data 7	000	Not selected
o5-10	Log Monitor Data 8	000	Not selected
o5-11	Log Monitor Data 9	000	Not selected
o5-12	Log Monitor Data 10	000	Not selected

Note:

- Do not de-energize the drive or disconnect the keypad from the drive during log transfer communication. Doing so may cause the log function not to resume even after the power is restored or the keypad is reconnected.
- Micro SDHC cards up to a maximum capacity of 32 GB can be used.

■ Log File Specifications

Item	Specification
File storage location	A folder named [Log_File] is created under the root directory of the micro SD card.
Filename	GLOG0xxx.csv Note: [xxx] indicates a 3-digit decimal number
Maximum number of files	999 (GLOG0001.csv through GLOG0999.csv)
Character code	ASCII code
Line break code	<CR><LF>
Separating character	Commas
Header rows	First row: Drive information including Drive Model, software version, control method, and sampling time Second row: Log data information including the monitor number, number decimal points, and unit code

■ Log File Configuration

The [Log_Files] folder is created under the root directory of the micro SD card, in which log data is stored as CSV files. Log data files are created in the following configuration. The number of rows varies depending on the number of selected monitors.

First row	Drive information
Second row	Log data information
Third row	Log data 1
:	Log data 2
:	Log data 3
:	:
Last row	Log data n

First Row: Drive Information

The following example illustrates the data text strings and data generated for the first row of log data.

Example of generated data: 00,0012,160107111230,GA700,VSAA01010,2,62,1000,000001

No.	Item	Number of characters	Ex.	Description
1	Attribute	2	00	[00] represents that the record is a drive information record.
2	File number	4	0012	The [xxx] part of the [GLOG0xxx.csv] filename is a 3-digit decimal number generated in hexadecimal format. Example filename of [GLOG0018.csv]: 018 (Dec.) = 0012 (Hex.)
3	Time stamp ^{*1}	12	160107111230	Date file was generated • Date: 20YY/MM/DD • Time in 24-hour format: HH:MM:SS Example data of [160107111230]: 11:12:30 on January 7, 2016

No.	Item	Number of characters	Ex.	Description
4	Model	5	GA700	Drive model information
5	Software number	9	VSAA01010	Drive software number
6	Control method	1	2	Setting value (Hex.) of <i>A1-02 [Control Method Selection]</i>
7	Drive capacity	2	62	Setting value (Hex.) of <i>o2-04 [Drive Model Selection]</i>
8	Sampling time	5 (maximum)	1000	Setting value (Dec.) of <i>o5-02 [Log Sampling Interval]</i> Unit: ms
9	Row number	6	000001	Row number (Hex.) in the data log file

*1 If the time is not configured in the keypad, the text string of [000000000000] is generated to represent the time.

Second Row: Log Data Information

The following example illustrates the data text strings and data generated for the second row of log data.

Example of generated data:

01,0012,160107111230,0101,0201,0102,0201,0103,0206,0107,0005,0108,0209,0000,0000,0000,0000,0000,0
000,0000,0000,0000,0000,0000,0000,0000,0000,0000,000002

No.	Item	Number of characters	Description
1	Attribute	2	[01] represents that the record is a log data information record.
2	File number	4	The [xxx] part of the [GLOG0xxx.csv] filename is a 3-digit decimal number generated in hexadecimal format.
3	Time stamp	12	Date file was generated
4	Monitor number 1 *1	4	Monitor number selected by <i>o5-03 [Log Monitor Data 1]</i> Ex.: 0101 (Dec.) for <i>U1-01</i>
5	Monitor Unit 1 *2	4	Unit code and number of decimal places used for the monitor selected with <i>o5-03</i> Example when <i>U1-01 = 30.00 Hz</i> : Number of decimal places = 2, Hz unit code = 01, monitor unit 1 = 0201 (Hex.)
6	Monitor number 2	4	Monitor number (Dec.) selected by <i>o5-04 [Log Monitor Data 2]</i>
7	Monitor Unit 2	4	Unit code and number of decimal places used for the monitor selected with <i>o5-04</i>
:	:	:	:
22	Monitor number 10	4	Monitor number (Dec.) selected by <i>o5-12 [Log Monitor Data10]</i>
23	Monitor Unit 10	4	Unit code and number of decimal places used for the monitor selected with <i>o5-12</i>
24 to 27	Reserved	4	-
28	Row number	6	Row number (Hex.) in the data log file

*1 The text string of [0000] is generated when there is no data log monitor selected.

*2 Refer to the following table for information on unit codes.

Unit code (Hex.)	Unit	Unit code (Hex.)	Unit	Unit code (Hex.)	Unit	Unit code (Hex.)	Unit
00	-	08	PPR	10	H	18	0H
01	Hz	09	kW	11	V	19	-
02	RPM	0A	Ω	12	us	1A	-
03	%	0B	ms	13	min	1B	-
04	VAC	0C	kHz	14	°C	1C	-
05	VDC	0D	PSI	15	W	1D	-
06	A	0E	MPM	16	kWH	1E	-
07	sec	0F	FPM	17	MWH	1F	-

Third and Subsequent Rows: Log Data









The following example illustrates the data text strings and data generated for the third row of log data.

Example of generated data:

02,0012,160107111239,1770,1770,00BE,0118,0028,0000,0000,0000,0000,0000,0000,0000,0000C

No.	Item	Number of characters	Description
1	Attribute	2	[02] represents that the record is a monitor data record.
2	File number	4	The [xxx] part of the [GLOG0xxx.csv] filename is a 3-digit decimal number generated in hexadecimal format.
3	Time stamp	12	Data log data was retrieved (YYMMDDHHMMSS)
4	Log Monitor Data 1	4	Log monitor data (Hex.) of the monitor selected with <i>o5-03</i> [Log Monitor Data 1]
5	Log Monitor Data 2	4	Log monitor data (Hex.) of the monitor selected with <i>o5-04</i> [Log Monitor Data 2]
:	:	:	:
13	Log Monitor Data 10	4	Log monitor data (Hex.) of the monitor selected with <i>o5-12</i> [Log Monitor Data 10]
14	Reserved	4	-
15	Encoding data	4	Encoding data for log monitor data 1 through 10 (Hex.) Bits 0 through 9 represent the encoding of log monitor data 1 1 through 10. A bit value of 1 represents that the data represents a negative value. (Log monitor data 1 through 10 is absolute value data without encoding) Example when log monitor data 2, 5, and 8 represent negative values: Bits 1, 4, and 7 have values of 1, and so the encoding data = 0010010010 (Bin.) = 0092 (Hex.)
16	Row number	6	Row number (Hex.) in the data log file

■ o5-01: Log Start/Stop Selection

No. (Hex.)	Name	Description	Default (Range)
<i>o5-01</i> (1551) RUN	Log Start/Stop Selection	         Starts or stops the data log function. This parameter is only enabled for LED keypads.	0 (0, 1)









0 : OFF

Stops the data log.

1 : ON

Starts the data log in accordance with the sampling cycle configured with *o5-02*.

■ o5-02: Log Sampling Interval

No. (Hex.)	Name	Description	Default Setting (Setting Range)
<i>o5-02</i> (1552) RUN	Log Sampling Interval	         Selects the data log sampling cycle. This parameter is only enabled for LED keypads.	1000 ms (100 - 60000 ms)

■ o5-03: Log Monitor Data 1

No. (Hex.)	Name	Description	Default Setting (Setting Range)
<i>o5-03</i> (1553) RUN	Log Monitor Data 1	         Configures the data log monitor. This parameter is only enabled for LED keypads.	101 (000,101 - 855)

Note:

Select 101 to 855 [U1-01 to U8-55] to specify log data. For example, to display U1-05 [Motor Speed], set *o5-08* = 105. Set the parameter to 000 when you do not wish to select any data log monitors. U2 monitor [Fault Trace] and U3 Monitor [Fault History] cannot be selected.

■ **o5-04: Log Monitor Data 2**

No. (Hex.)	Name	Description	Default Setting (Setting Range)
o5-04 (1554) RUN	Log Monitor Data 2	V/f CL-V/f OLV CLV AOLV OLV/PM AOLV/PM CLV/PM EZOLV Configures the data log monitor. This parameter is only enabled for LED keypads.	102 (000,101 - 855)

Note:

Select 101 to 855 [U1-01 to U8-55] to specify log data. For example, to display U1-05 [Motor Speed], set o5-08 = 105. Set the parameter to 000 when you do not wish to select any data log monitors. U2 monitor [Fault Trace] and U3 Monitor [Fault History] cannot be selected.

■ **o5-05: Log Monitor Data 3**

No. (Hex.)	Name	Description	Default Setting (Setting Range)
o5-05 (1555) RUN	Log Monitor Data 3	V/f CL-V/f OLV CLV AOLV OLV/PM AOLV/PM CLV/PM EZOLV Configures the data log monitor. This parameter is only enabled for LED keypads.	103 (000,101 - 855)

Note:

Select 101 to 855 [U1-01 to U8-55] to specify log data. For example, to display U1-05 [Motor Speed], set o5-08 = 105. Set the parameter to 000 when you do not wish to select any data log monitors. U2 monitor [Fault Trace] and U3 Monitor [Fault History] cannot be selected.

■ **o5-06: Log Monitor Data 4**

No. (Hex.)	Name	Description	Default Setting (Setting Range)
o5-06 (1556) RUN	Log Monitor Data 4	V/f CL-V/f OLV CLV AOLV OLV/PM AOLV/PM CLV/PM EZOLV Configures the data log monitor. This parameter is only enabled for LED keypads.	107 (000,101 - 855)

Note:

Select 101 to 855 [U1-01 to U8-55] to specify log data. For example, to display U1-05 [Motor Speed], set o5-08 = 105. Set the parameter to 000 when you do not wish to select any data log monitors. U2 monitor [Fault Trace] and U3 Monitor [Fault History] cannot be selected.

■ **o5-07: Log Monitor Data 5**

No. (Hex.)	Name	Description	Default Setting (Setting Range)
o5-07 (1557) RUN	Log Monitor Data 5	V/f CL-V/f OLV CLV AOLV OLV/PM AOLV/PM CLV/PM EZOLV Configures the data log monitor. This parameter is only enabled for LED keypads.	108 (000,101 - 855)

Note:

Select 101 to 855 [U1-01 to U8-55] to specify log data. For example, to display U1-05 [Motor Speed], set o5-08 = 105. Set the parameter to 000 when you do not wish to select any data log monitors. U2 monitor [Fault Trace] and U3 Monitor [Fault History] cannot be selected.

■ **o5-08: Log Monitor Data 6**

No. (Hex.)	Name	Description	Default Setting (Setting Range)
o5-08 (1558) RUN	Log Monitor Data 6	V/f CL-V/f OLV CLV AOLV OLV/PM AOLV/PM CLV/PM EZOLV Configures the data log monitor. This parameter is only enabled for LED keypads.	000 (000,101 - 855)

Note:

Select 101 to 855 [U1-01 to U8-55] to specify log data. For example, to display U1-05 [Motor Speed], set o5-08 = 105. Set the parameter to 000 when you do not wish to select any data log monitors. U2 monitor [Fault Trace] and U3 Monitor [Fault History] cannot be selected.

■ o5-09: Log Monitor Data 7

No. (Hex.)	Name	Description	Default Setting (Setting Range)
o5-09 (1559) RUN	Log Monitor Data 7	<div style="display: flex; justify-content: space-between; font-size: 0.8em; font-weight: bold; margin-bottom: 5px;"> V/f CL-V/f OLV CLV AOLV OLV/PM AOLV/PM CLV/PM EZOLV </div> Configures the data log monitor. This parameter is only enabled for LED keypads.	000 (000,101 - 855)

Note:

Select 101 to 855 [U1-01 to U8-55] to specify log data. For example, to display U1-05 [Motor Speed], set o5-08 = 105. Set the parameter to 000 when you do not wish to select any data log monitors. U2 monitor [Fault Trace] and U3 Monitor [Fault History] cannot be selected.

■ o5-10: Log Monitor Data 8

No. (Hex.)	Name	Description	Default Setting (Setting Range)
o5-10 (155A) RUN	Log Monitor Data 8	<div style="display: flex; justify-content: space-between; font-size: 0.8em; font-weight: bold; margin-bottom: 5px;"> V/f CL-V/f OLV CLV AOLV OLV/PM AOLV/PM CLV/PM EZOLV </div> Configures the data log monitor. This parameter is only enabled for LED keypads.	000 (000,101 - 855)

Note:

Select 101 to 855 [U1-01 to U8-55] to specify log data. For example, to display U1-05 [Motor Speed], set o5-08 = 105. Set the parameter to 000 when you do not wish to select any data log monitors. U2 monitor [Fault Trace] and U3 Monitor [Fault History] cannot be selected.

■ o5-11: Log Monitor Data 9

No. (Hex.)	Name	Description	Default Setting (Setting Range)
o5-11 (155B) RUN	Log Monitor Data 9	<div style="display: flex; justify-content: space-between; font-size: 0.8em; font-weight: bold; margin-bottom: 5px;"> V/f CL-V/f OLV CLV AOLV OLV/PM AOLV/PM CLV/PM EZOLV </div> Configures the data log monitor. This parameter is only enabled for LED keypads.	000 (000,101 - 855)

Note:

Select 101 to 855 [U1-01 to U8-55] to specify log data. For example, to display U1-05 [Motor Speed], set o5-08 = 105. Set the parameter to 000 when you do not wish to select any data log monitors. U2 monitor [Fault Trace] and U3 Monitor [Fault History] cannot be selected.

■ o5-12: Log Monitor Data 10

No. (Hex.)	Name	Description	Default Setting (Setting Range)
o5-12 (155C) RUN	Log Monitor Data 10	<div style="display: flex; justify-content: space-between; font-size: 0.8em; font-weight: bold; margin-bottom: 5px;"> V/f CL-V/f OLV CLV AOLV OLV/PM AOLV/PM CLV/PM EZOLV </div> Configures the data log monitor. This parameter is only enabled for LED keypads.	000 (000,101 - 855)

Note:

Select 101 to 855 [U1-01 to U8-55] to specify log data. For example, to display U1-05 [Motor Speed], set o5-08 = 105. Set the parameter to 000 when you do not wish to select any data log monitors. U2 monitor [Fault Trace] and U3 Monitor [Fault History] cannot be selected.

11.12 T: Auto-Tuning

Numbers identifying the *T* parameters are displayed when an LED keypad is used. The names of the parameters are displayed on the LCD screen of the LCD keypad. Set the following.

- Induction Motor Auto-Tuning
- PM Motor Auto-Tuning
- ASR and Inertia Tuning

◆ T0: Tuning Mode Selection

■ T0-00: Tuning Mode Selection

Select *T0-00* first when the control mode used supports Control Tuning. Then, select the motor to be tuned by *T1-00* [*Motor 1/Motor 2 Selection*] and the tuning mode by *T2-01* [*PM Motor Auto-Tuning Mode Select*] or *T3-00* [*Control Loop Tuning Selection*].

No. (Hex.)	Name	Description	Default (Range)
T0-00 (1197)	Tuning Mode Selection	<input type="checkbox"/> V/f <input type="checkbox"/> CL-V/f <input type="checkbox"/> OLV <input type="checkbox"/> CLV <input type="checkbox"/> AOLV <input type="checkbox"/> OLV/PM <input type="checkbox"/> AOLV/PM <input type="checkbox"/> CLV/PM <input type="checkbox"/> EZOLV Selects the type of Auto-Tuning to be used.	0 (0, 1)

0 : Motor Parameter Tuning

1 : Control Tuning

Note:

The available tuning modes vary depending on the control mode.

◆ T1: InductionMotor Auto-Tuning

T1 parameters set the Auto-Tuning input data for induction motor tuning.

Note:

- The base frequency of drive dedicated motors and special motors for use with vector control may be lower than the base frequency of general-purpose motors, which is 50 Hz or 60 Hz. In such cases, this lower frequency is used as the value for *E1-06* [*Base Frequency*] and *E1-04* [*Maximum Output Frequency*] after Auto-Tuning completes. If the maximum output frequency is too low and causes problems, change the setting of *E1-04* after Auto-Tuning completes.
- The following induction motor parameters are set automatically.
 - E1-xx* [*V/f Pattern for Motor 1*]
 - E2-xx* [*Motor Parameters*]
 - E3-xx* [*V/f Pattern for Motor 2*]
 - E4-xx* [*Motor 2 Parameters*]
 - F1-xx* [*Encoder Options*] (only with Closed Loop Vector Control)

■ T1-00: Motor 1/Motor 2 Selection

No. (Hex.)	Name	Description	Default (Range)
T1-00 (0700)	Motor 1/Motor 2 Selection	<input type="checkbox"/> V/f <input type="checkbox"/> CL-V/f <input type="checkbox"/> OLV <input type="checkbox"/> CLV <input type="checkbox"/> AOLV <input type="checkbox"/> OLV/PM <input type="checkbox"/> AOLV/PM <input type="checkbox"/> CLV/PM <input type="checkbox"/> EZOLV Selects the motor to be tuned when motor 1/2 switching is enabled. This parameter can only be set via the keypad not via external input terminals.	1 (1, 2)

Note:

This parameter can be set when *H1-xx* = 16 [*Motor 2 Selection*] is ON and is not displayed when *H1-xx* = 16 is OFF. Motors cannot be switched via external input. Use the keypad to display *T1-00* and change the setting value to switch the motor.

1 : Motor 1 (sets E1-xx, E2-xx)

Auto-Tuning automatically sets parameters *E1-xx* and *E2-xx* for motor 1.

2 : Motor 2 (sets E3-xx, E4-xx)

Auto-Tuning automatically sets parameters *E3-xx* and *E4-xx* for motor 2. Make sure that motor 2 is connected to the drive for Auto-Tuning.

■ T1-01: Auto-Tuning Mode Selection

No. (Hex.)	Name	Description	Default Setting (Range)
T1-01 (0701)	Auto-Tuning Mode Selection	<input checked="" type="checkbox"/> V/f <input checked="" type="checkbox"/> CL-V/f <input type="checkbox"/> OLV <input type="checkbox"/> CLV <input type="checkbox"/> AOLV <input type="checkbox"/> OLV/PM <input type="checkbox"/> AOLV/PM <input type="checkbox"/> CLV/PM <input type="checkbox"/> EZOLV Selects the type of Auto-Tuning to be used.	Determined by A1-02 (Determined by A1-02)

0 : Rotational Auto-Tuning

1 : Stationary Auto-Tuning 1

2 : StaTun for LinetoLine Resistance

■ T1-02: Motor Rated Power

No. (Hex.)	Name	Description	Default Setting (Range)
T1-02 (0702)	Motor Rated Power	<input checked="" type="checkbox"/> V/f <input checked="" type="checkbox"/> CL-V/f <input type="checkbox"/> OLV <input type="checkbox"/> CLV <input type="checkbox"/> AOLV <input type="checkbox"/> OLV/PM <input type="checkbox"/> AOLV/PM <input type="checkbox"/> CLV/PM <input type="checkbox"/> EZOLV Sets the rated output power (kW) of the motor.	Determined by o2-04 and C6-01 (0.00 - 650.00 kW)

Note:

Capacities 300 kW and less are set in units of 0.01 kW. Capacities above 300 kW are set in units of 0.1 kW. The maximum applicable motor output varies depending on the setting of C6-01 [Normal / Heavy Duty Selection].

■ T1-03: Motor Rated Voltage

No. (Hex.)	Name	Description	Default Setting (Range)
T1-03 (0703)	Motor Rated Voltage	<input checked="" type="checkbox"/> V/f <input checked="" type="checkbox"/> CL-V/f <input type="checkbox"/> OLV <input type="checkbox"/> CLV <input type="checkbox"/> AOLV <input type="checkbox"/> OLV/PM <input type="checkbox"/> AOLV/PM <input type="checkbox"/> CLV/PM <input type="checkbox"/> EZOLV Sets the rated voltage (V) of the motor. Enter the base speed voltage here for constant output motors.	Determined by o2-04 and C6-01 (200 V Class: 0.0 - 255.5 V, 400 V Class: 0.0 - 511.0 V)

If auto tuning is carried out with respect to a drive dedicated motor or a special motor for use with vector control, the voltage or frequency derived as the result of the tuning will often be lower than that of a general-purpose motor. For this reason, always compare the data from the nameplate or test report with the results measured by the auto tuning and check for discrepancies. Enter the voltage needed to operate the motor under no-load conditions at rated speed to T1-03 for better control precision around rated speed. If the motor test report or the motor nameplate is not available, enter approximately 90% of the motor rated voltage.

If the drive input power supply voltage is low, enter approximately 90% of the input voltage. Current will increase if the input power supply voltage is low. For this reason, confirm the main power supply capacity and molded-case circuit breaker for the drive.

■ T1-04: Motor Rated Current

No. (Hex.)	Name	Description	Default Setting (Range)
T1-04 (0704)	Motor Rated Current	<input checked="" type="checkbox"/> V/f <input checked="" type="checkbox"/> CL-V/f <input type="checkbox"/> OLV <input type="checkbox"/> CLV <input type="checkbox"/> AOLV <input type="checkbox"/> OLV/PM <input type="checkbox"/> AOLV/PM <input type="checkbox"/> CLV/PM <input type="checkbox"/> EZOLV Sets the rated current (A) of the motor.	Determined by o2-04 (10% to 200% of the drive rated current)

Set the motor rated current between 50% and 100% of the drive rated current for optimal performance. Enter the current at the motor base speed.

■ T1-05: Motor Base Frequency

No. (Hex.)	Name	Description	Default Setting (Range)
T1-05 (0705)	Motor Base Frequency	<input checked="" type="checkbox"/> V/f <input checked="" type="checkbox"/> CL-V/f <input type="checkbox"/> OLV <input type="checkbox"/> CLV <input type="checkbox"/> AOLV <input type="checkbox"/> OLV/PM <input type="checkbox"/> AOLV/PM <input type="checkbox"/> CLV/PM <input type="checkbox"/> EZOLV Sets the base frequency of the motor (Hz).	60.0 Hz (0.0 - 590.0 Hz)

When Auto-Tuning is carried out, the value of *T1-05* is set to *E1-04* [Maximum Output Frequency]. If running at a speed that is higher than the base frequency, or when running in a field weakening range, change *E1-04* (*E3-04* in the case of motor 2) to the maximum output frequency, after the auto-tuning is complete.

■ T1-06: Number of Motor Poles

No. (Hex.)	Name	Description	Default Setting (Range)
T1-06 (0706)	Number of Motor Poles	<input type="checkbox"/> V/f <input type="checkbox"/> CL-V/f <input type="checkbox"/> OLV <input checked="" type="checkbox"/> CLV <input type="checkbox"/> AOLV <input type="checkbox"/> OLV/PM <input type="checkbox"/> AOLV/PM <input type="checkbox"/> CLV/PM <input type="checkbox"/> EZOLV Sets the number of motor poles.	4 (2 - 48)

■ T1-07: Motor Base Speed

No. (Hex.)	Name	Description	Default Setting (Range)
T1-07 (0707)	Motor Base Speed	<input type="checkbox"/> V/f <input type="checkbox"/> CL-V/f <input type="checkbox"/> OLV <input checked="" type="checkbox"/> CLV <input type="checkbox"/> AOLV <input type="checkbox"/> OLV/PM <input type="checkbox"/> AOLV/PM <input type="checkbox"/> CLV/PM <input type="checkbox"/> EZOLV Sets the motor base speed for performing auto tuning (min ⁻¹ (r/min)).	1750 min ⁻¹ (r/min) (0 - 24000 min ⁻¹ (r/min))

■ T1-08: PG Number of PulsesPerRevolution

No. (Hex.)	Name	Description	Default Setting (Range)
T1-08 (0708)	PG Number of PulsesPerRevolution	<input type="checkbox"/> V/f <input type="checkbox"/> CL-V/f <input type="checkbox"/> OLV <input checked="" type="checkbox"/> CLV <input type="checkbox"/> AOLV <input type="checkbox"/> OLV/PM <input type="checkbox"/> AOLV/PM <input type="checkbox"/> CLV/PM <input type="checkbox"/> EZOLV Sets the number of PG (pulse generator, encoder) pulses.	600 ppr (0 - 60,000 ppr)

Set the actual number of pulses for one full motor rotation.

■ T1-09: Motor No-Load Current

No. (Hex.)	Name	Description	Default Setting (Range)
T1-09 (0709)	Motor No-Load Current	<input type="checkbox"/> V/f <input type="checkbox"/> CL-V/f <input checked="" type="checkbox"/> OLV <input checked="" type="checkbox"/> CLV <input type="checkbox"/> AOLV <input type="checkbox"/> OLV/PM <input type="checkbox"/> AOLV/PM <input type="checkbox"/> CLV/PM <input type="checkbox"/> EZOLV Sets the no-load current of the motor.	- (0A to T1-04; max. of 2999.9)

Note:

The unit of display varies depending on the model.

- 2004 to 2042, 4002 to 4023: 0.01 A
- 2056 to 2415, 4031 to 4675: 0.1 A

The value that appears is the no-load current automatically calculated from the values set in *T1-02* [Motor Rated Power] and *T1-04* [Motor Rated Current]. Sets the no-load current listed on the motor test report. Leave this data at the default setting if the motor test report is not available.

■ T1-10: Motor Rated Slip

No. (Hex.)	Name	Description	Default Setting (Range)
T1-10 (070A)	Motor Rated Slip	<input type="checkbox"/> V/f <input type="checkbox"/> CL-V/f <input checked="" type="checkbox"/> OLV <input checked="" type="checkbox"/> CLV <input type="checkbox"/> AOLV <input type="checkbox"/> OLV/PM <input type="checkbox"/> AOLV/PM <input type="checkbox"/> CLV/PM <input type="checkbox"/> EZOLV Sets the motor rated slip.	- (0.00 - 20.00 Hz)

The default setting displayed is the rated slip for a Yaskawa motor calculated from the setting in *T1-02* [Motor Rated Power]. Set the rated slip listed on the motor test report.

■ T1-11: Motor Iron Loss

No. (Hex.)	Name	Description	Default Setting (Range)
T1-11 (070B)	Motor Iron Loss	<input type="checkbox"/> V/f <input checked="" type="checkbox"/> CL-V/f <input type="checkbox"/> OLV <input type="checkbox"/> CLV <input type="checkbox"/> AOLV <input type="checkbox"/> OLV/PM <input type="checkbox"/> AOLV/PM <input type="checkbox"/> CLV/PM <input type="checkbox"/> EZOLV Sets the iron loss information for determining the energy-saving coefficient.	Determined by E2-11 or E4-11 (0 - 65535 W)

Note:

The default setting varies depending on the motor code and motor parameter settings.

The value that appears is either the *E2-10 [Motor Iron Loss]* or *E4-10 [Motor 2 Iron Loss]* for the motor output set in *T1-02 [Motor Rated Power]*. Enter the motor iron loss value listed to T1-11 if the motor test report is available.

◆ T2: PM Motor Auto-Tuning

T2 parameters set the Auto-Tuning input data for PM motor tuning.

Note:

The following PM motor parameters are set automatically.

- E1-xx [V/f Pattern for Motor 1]
- E5-xx [PM Motor Settings]
- F1-xx [PG Speed Control Card (Encoder)] (only with Closed Loop Vector Control)

■ T2-01: PM Motor Auto-Tuning Mode Select

No. (Hex.)	Name	Description	Default (Range)
T2-01 (0750)	PM Motor Auto-Tuning Mode Select	V/f CL-V/f OLV CLV AOLV OLV/PM AOLV/PM CLV/PM EZOLV Selects the type of Auto-Tuning for PM motors to be used.	0 (Determined by A1-02)

Note:

Yaskawa recommends performing the PM Rotational Auto-Tuning when using specialized motors. Rotational Auto-Tuning rotates the motor to measure the actual induction voltage constants, which allows for more accurate control than Stationary Auto-Tuning alone.

0 : PM Motor Parameter Settings

1 : PM Stationary Auto-Tuning

2 : PM StaTun for Stator Resistance

3 : Z Pulse Offset Tuning

4 : PM Rotational Auto-Tuning

■ T2-02: PM Motor Code Selection

No. (Hex.)	Name	Description	Default Setting (Range)
T2-02 (0751)	PM Motor Code Selection	V/f CL-V/f OLV CLV AOLV OLV/PM AOLV/PM CLV/PM EZOLV If the drive is operating a Yaskawa PM motor from the SMRA, SSR1, or SST4 series, enter the PM motor code in accordance with the rotation speed and motor output.	Determined by A1-02 and o2-04 (0000 - FFFF)

Enter the motor code in *T2-02* to automatically set parameters *T2-03* through *T2-14*. If the drive is operating a specialized motor or a motor designed by a manufacturer other than Yaskawa, set *T2-02* to *FFFF* and enter the data from the motor nameplate or the motor test report as prompted.

Only the designated PM motor codes may be entered. The PM motor codes accepted by the drive will differ depending on the selected control mode.

■ T2-03: PM Motor Type

No. (Hex.)	Name	Description	Default (Range)
T2-03 (0752)	PM Motor Type	V/f CL-V/f OLV CLV AOLV OLV/PM AOLV/PM CLV/PM EZOLV Selects the type of PM motor the drive will operate.	1 (0, 1)

0 : IPM motor

1 : SPM motor

■ T2-04: PM Motor Rated Power

No. (Hex.)	Name	Description	Default Setting (Range)
T2-04 (0730)	PM Motor Rated Power	<input type="checkbox"/> V/f <input type="checkbox"/> CL-V/f <input type="checkbox"/> OLV <input type="checkbox"/> CLV <input type="checkbox"/> AOLV <input checked="" type="checkbox"/> OLV/PM <input type="checkbox"/> AOLV/PM <input type="checkbox"/> CLV/PM <input type="checkbox"/> EZOLV Sets the rated output power (kW) of a PM motor.	Determined by o2-04 and C6-01 (0.00 - 650.00 kW)

Note:

Capacities 300 kW and less are set in units of 0.01 kW. Capacities above 300 kW are set in units of 0.1 kW. The maximum applicable motor output varies depending on the setting of C6-01 [Normal / Heavy Duty Selection].

■ T2-05: PM Motor Rated Voltage

No. (Hex.)	Name	Description	Default Setting (Range)
T2-05 (0732)	PM Motor Rated Voltage	<input type="checkbox"/> V/f <input type="checkbox"/> CL-V/f <input type="checkbox"/> OLV <input type="checkbox"/> CLV <input type="checkbox"/> AOLV <input checked="" type="checkbox"/> OLV/PM <input type="checkbox"/> AOLV/PM <input type="checkbox"/> CLV/PM <input type="checkbox"/> EZOLV Sets the rated voltage (V) of the motor.	200 V Class: 200.0 V, 400 V Class: 400.0 V (200 V Class: 0.0 - 255.0 V, 400 V Class: 0.0 - 510.0 V)

■ T2-06: PM Motor Rated Current

No. (Hex.)	Name	Description	Default Setting (Range)
T2-06 (0733)	PM Motor Rated Current	<input type="checkbox"/> V/f <input type="checkbox"/> CL-V/f <input type="checkbox"/> OLV <input type="checkbox"/> CLV <input type="checkbox"/> AOLV <input checked="" type="checkbox"/> OLV/PM <input type="checkbox"/> AOLV/PM <input type="checkbox"/> CLV/PM <input type="checkbox"/> EZOLV Sets the rated current (A) of the motor.	Determined by o2-04 (10% to 200% of the drive rated current)

■ T2-07: PM Motor Base Frequency

No. (Hex.)	Name	Description	Default Setting (Range)
T2-07 (0753)	PM Motor Base Frequency	<input type="checkbox"/> V/f <input type="checkbox"/> CL-V/f <input type="checkbox"/> OLV <input type="checkbox"/> CLV <input type="checkbox"/> AOLV <input checked="" type="checkbox"/> OLV/PM <input type="checkbox"/> AOLV/PM <input type="checkbox"/> CLV/PM <input type="checkbox"/> EZOLV Sets the base frequency of the motor (Hz).	87.5 Hz (0.0 - 590.0 Hz)

■ T2-08: Number of PM Motor Poles

No. (Hex.)	Name	Description	Default Setting (Range)
T2-08 (0734)	Number of PM Motor Poles	<input type="checkbox"/> V/f <input type="checkbox"/> CL-V/f <input type="checkbox"/> OLV <input type="checkbox"/> CLV <input type="checkbox"/> AOLV <input checked="" type="checkbox"/> OLV/PM <input type="checkbox"/> AOLV/PM <input type="checkbox"/> CLV/PM <input type="checkbox"/> EZOLV Sets the number of motor poles.	6 (2 - 48)

■ T2-09: PM Motor Base Speed

No. (Hex.)	Name	Description	Default Setting (Range)
T2-09 (0731)	PM Motor Base Speed	<input type="checkbox"/> V/f <input type="checkbox"/> CL-V/f <input type="checkbox"/> OLV <input type="checkbox"/> CLV <input type="checkbox"/> AOLV <input checked="" type="checkbox"/> OLV/PM <input type="checkbox"/> AOLV/PM <input type="checkbox"/> CLV/PM <input type="checkbox"/> EZOLV Sets the motor base speed (min ⁻¹ (r/min)).	1750 min ⁻¹ (r/min) (0 - 34500 min ⁻¹ (r/min))

■ T2-10: PM Motor Stator Resistance

No. (Hex.)	Name	Description	Default Setting (Range)
T2-10 (0754)	PM Motor Stator Resistance	<input type="checkbox"/> V/f <input type="checkbox"/> CL-V/f <input type="checkbox"/> OLV <input type="checkbox"/> CLV <input type="checkbox"/> AOLV <input checked="" type="checkbox"/> OLV/PM <input type="checkbox"/> AOLV/PM <input type="checkbox"/> CLV/PM <input type="checkbox"/> EZOLV Sets the stator resistance per phase of the motor.	Determined by T2-02 (0.000 - 65.000 Ω)

Note:

Do not confuse this parameter with line-to-line resistance.

■ T2-11: PM Motor d-Axis Inductance

No. (Hex.)	Name	Description	Default Setting (Range)
T2-11 (0735)	PM Motor d-Axis Inductance	V/f CL-V/f OLV CLV AOLV OLV/PM AOLV/PM CLV/PM EZOLV Sets the d-Axis inductance of the motor on a per phase basis.	Determined by T2-02 (0.00 - 600.00 mH)

■ T2-12: PM Motor q-Axis Inductance

No. (Hex.)	Name	Description	Default Setting (Range)
T2-12 (0736)	PM Motor q-Axis Inductance	V/f CL-V/f OLV CLV AOLV OLV/PM AOLV/PM CLV/PM EZOLV Sets the q-Axis inductance of the motor on a per phase basis.	Determined by T2-02 (0.00 - 600.00 mH)

■ T2-13: InducedVoltage Const Unit Select

No. (Hex.)	Name	Description	Default Setting (Range)
T2-13 (0755)	InducedVoltage Const Unit Select	V/f CL-V/f OLV CLV AOLV OLV/PM AOLV/PM CLV/PM EZOLV Selects the unit used for setting the induced voltage constant.	1 (0, 1)

0 : mV/min⁻¹

1 : mV/(rad/s)

Note:

- If T2-13 = 0 is set, then the drive will use E5-24 [PM Back-EMF L-L Vrms (mV/rpm)], and will automatically set E5-09 [PM Back-EMF Vpeak (mV/(rad/s))] to 0.0.
- If T2-13 = 1 is set, then the drive will use E5-09 and will automatically set E5-24 to 0.0.

■ T2-14: PM Motor Induced Voltage Const

No. (Hex.)	Name	Description	Default Setting (Range)
T2-14 (0737)	PM Motor Induced Voltage Const	V/f CL-V/f OLV CLV AOLV OLV/PM AOLV/PM CLV/PM EZOLV Sets the motor induced voltage constant (Ke).	Determined by T2-13 (0.0 - 2000.0)

■ T2-15: Pull-InCurrentLv forPM Motor Tun

No. (Hex.)	Name	Description	Default Setting (Range)
T2-15 (0756)	Pull-InCurrentLv forPM Motor Tun	V/f CL-V/f OLV CLV AOLV OLV/PM AOLV/PM CLV/PM EZOLV Sets the level of the pull-in current as a percentage, with 100% representing the motor rated current. Normally there is no need to configure this setting.	30% (0 - 120%)

Increase the setting value if the load inertia is significant.

■ T2-16: PGNumOfPulses/Rev forPMMotor Tun

No. (Hex.)	Name	Description	Default Setting (Range)
T2-16 (0738)	PGNumOfPulses/Rev forPMMotor Tun	V/f CL-V/f OLV CLV AOLV OLV/PM AOLV/PM CLV/PM EZOLV Sets the number of PG (pulse generator, encoder) pulses.	1024 ppr (1 - 15000 ppr)

Set the actual number of pulses for one full motor rotation.

■ T2-17: Encoder Z-Pulse Offset

No. (Hex.)	Name	Description	Default Setting (Range)
T2-17 (0757)	Encoder Z-Pulse Offset	V/f CL-V/f OLV CLV AOLV OLV/PM AOLV/PM CLV/PM EZOLV If the encoder Z-pulse offset ($\Delta\theta$) (pulse generator, encoder) is listed on the motor nameplate, set it in units of 0.1°.	0.0° (-180.0 - +180.0°)

If the amount of PG (pulse generator, encoder) Z-pulse offset is unknown, or the encoder has been replaced, perform Z Pulse Offset Tuning and correct for the offset ($\Delta\theta$) from the Z phase.

◆ T3: ASR and Inertia Tuning

■ T3-00: Control Loop Tuning Selection

No. (Hex.)	Name	Description	Default (Range)
T3-00 (1198)	Control Loop Tuning Selection	<div style="display: flex; justify-content: space-between; font-size: small;"> V/f CL-V/f OLV CLV AOLV OLV/PM AOLV/PM CLV/PM EZOLV </div> Selects the Control Auto-Tuning method to be used.	0 (0 - 1)

0 : Inertia Tuning

1 : ASR Tuning

■ T3-01: Test Signal Frequency

No. (Hex.)	Name	Description	Default Setting (Range)
T3-01 (0760)	Test Signal Frequency	<div style="display: flex; justify-content: space-between; font-size: small;"> V/f CL-V/f OLV CLV AOLV OLV/PM AOLV/PM CLV/PM EZOLV </div> Normally there is no need to change this setting. Sets the frequency of the test signal applied to the motor during Inertia Tuning.	3.0 Hz (0.1 - 20.0 Hz)

Lower the setting value if the load inertia is too significant and a fault is detected after the Inertia Tuning.

■ T3-02: Test Signal Amplitude

No. (Hex.)	Name	Description	Default Setting (Range)
T3-02 (0761)	Test Signal Amplitude	<div style="display: flex; justify-content: space-between; font-size: small;"> V/f CL-V/f OLV CLV AOLV OLV/PM AOLV/PM CLV/PM EZOLV </div> Sets the amplitude of the test signal applied to the motor during Inertia Tuning. Normally there is no need to change this setting.	0.5 rad (0.1 - 10.0 rad)

Lower the setting value if the load inertia is too significant and a fault is detected after the Inertia Tuning. Adjust this parameter if a fault occurs when T3-01 [Test Signal Frequency] is set to a low value.

■ T3-03: Motor Inertia

No. (Hex.)	Name	Description	Default Setting (Range)
T3-03 (0762)	Motor Inertia	<div style="display: flex; justify-content: space-between; font-size: small;"> V/f CL-V/f OLV CLV AOLV OLV/PM AOLV/PM CLV/PM EZOLV </div> Sets the inertia of the motor. This value is used to determine the load inertia using the test signal response.	Determined by o2-04, C6-01, and E5-01 (0.0001 - 6.0000 kgm ²)

The default setting is for a Yaskawa standard motor as listed in the motor inertia table. Actual values vary depending on whether the motor used is an induction motor or a PM motor.

Note:

Capacities below 37 kW are set in units of 0.0001 kgm². Capacities 37 kW and above are set in units of 0.001 kgm².

■ T3-04: System Response Frequency

No. (Hex.)	Name	Description	Default Setting (Range)
T3-04 (0763)	System Response Frequency	<div style="display: flex; justify-content: space-between; font-size: small;"> V/f CL-V/f OLV CLV AOLV OLV/PM AOLV/PM CLV/PM EZOLV </div> C5-01 [ASR Proportional Gain 1] is automatically calculated and set using the load inertia value derived by the Inertia Tuning process.	10.0 Hz (0.1 - 50.0 Hz)

Oscillation may result if the value input here is too high.

◆ T4: EZ Tuning

With the T4 parameters, the data required for motor parameter auto-tuning is input when setting A1-02 = 8 [Control Method Selection = EZ Open Loop Vector Control]. The following two modes are available.

Value set in T4-01	Operational overview	Items input for tuning	Items tuned
0	Manually enter the required motor parameters by following the instructions presented by the setup wizard on the keypad.	<ul style="list-style-type: none"> T4-02 [Motor Type Selection] T4-03 [Motor Max Revolutions] T4-04 [Rated Speed] T4-05 [Motor Rated Frequency] * T4-06 [Base Voltage] T4-07 [Motor Rated Current] T4-08 [Motor Rated Capacity] T4-09 [Number of Motor Poles] T4-10 [Motor Rated Slip] *2 T4-11 [Motor Line Resistance] 	<ul style="list-style-type: none"> E9-01 [Motor Type Selection] E9-02 [Motor Max Revolutions] E9-03 [Rated Speed] E9-04 [Motor Rated Frequency] E9-05 [Base Voltage] E9-06 [Motor Rated Current (FLA)] E9-07 [Motor Rated Power (kW)] E9-08 [Number of Motor Poles] E9-09 [Motor Rated Slip] E9-10 [Line-to-Line Resistance]
1	Perform only line-to-line resistance tuning.	Motor Rated Current	E9-10 [Line-to-Line Resistance]

*1 Input using the setup wizard can be skipped when using a PM motor or a synchronous reluctance motor. The drive will automatically calculate the rated frequency based on the rated rotation speed and number of motor poles that have been input.

*2 The drive will automatically calculate the motor rated slip based on the rated rotation speed, rated frequency, and number of motor poles that have been input. The setting values can also be entered manually.

■ T4-01: EZ Tuning Mode Selection

No. (Hex.)	Name	Description	Default (Range)
T4-01 (3130)	EZ Tuning Mode Selection	<div style="display: flex; justify-content: space-between; font-size: small;"> V/f CL-V/f OLV CLV AOLV OLV/PM AOLV/PM CLV/PM EZOLV </div> Selects the Auto-Tuning method used for EZ Open Loop Vector Control.	0 (0, 1)

0 : Motor constant setting Auto-Tuning

1 : Stationary Auto-Tuning for Line-to-Line Resistance

■ T4-02: Motor Type Selection

No. (Hex.)	Name	Description	Default Setting (Range)
T4-02 (3131)	Motor Type Selection	<div style="display: flex; justify-content: space-between; font-size: small;"> V/f CL-V/f OLV CLV AOLV OLV/PM AOLV/PM CLV/PM EZOLV </div> Selects the type of motor.	0 (0, 1, 2)

0 : IM

1 : PM

2 : SynRM

■ T4-03: Motor Max Revolutions

No. (Hex.)	Name	Description	Default Setting (Range)
T4-03 (3132)	Motor Max Revolutions	<div style="display: flex; justify-content: space-between; font-size: small;"> V/f CL-V/f OLV CLV AOLV OLV/PM AOLV/PM CLV/PM EZOLV </div> Sets the motor max revolutions (min ⁻¹).	- ((40 to 120 Hz) × 60 × 2 / E9-08)

■ T4-04: Motor Rated Revolutions

No. (Hex.)	Name	Description	Default Setting (Range)
T4-04 (3133)	Motor Rated Revolutions	<div style="display: flex; justify-content: space-between; font-size: small;"> V/f CL-V/f OLV CLV AOLV OLV/PM AOLV/PM CLV/PM EZOLV </div> Sets rated rotation speed of the motor (min ⁻¹).	- ((40 to 120 Hz) × 60 × 2 / E9-08)

■ T4-05: Motor Rated Frequency

No. (Hex.)	Name	Description	Default Setting (Range)
T4-05 (3134)	Motor Rated Frequency	<input type="checkbox"/> V/f <input type="checkbox"/> CL-V/f <input type="checkbox"/> OLV <input type="checkbox"/> CLV <input type="checkbox"/> AOLV <input type="checkbox"/> OLV/PM <input type="checkbox"/> AOLV/PM <input type="checkbox"/> CLV/PM <input checked="" type="checkbox"/> EZOLV Sets the motor rated frequency (Hz).	Determined by E9-01 and o2-04 (40.0 - 120.0 Hz)

Note:

When set to T4-02 = 1, 2 [Motor Type Selection = PM (permanent magnet), SynRM (synchronous reluctance)], input can be skipped since the following is assumed: Motor Rated Revolutions/60 × Number of Motor Poles/2.

■ T4-06: Motor Rated Voltage

No. (Hex.)	Name	Description	Default Setting (Range)
T4-06 (3135)	Motor Rated Voltage	<input type="checkbox"/> V/f <input type="checkbox"/> CL-V/f <input type="checkbox"/> OLV <input type="checkbox"/> CLV <input type="checkbox"/> AOLV <input type="checkbox"/> OLV/PM <input type="checkbox"/> AOLV/PM <input type="checkbox"/> CLV/PM <input checked="" type="checkbox"/> EZOLV Sets the rated voltage (V) of the motor.	200 V Class: 200.0 V, 400 V Class: 400.0 V (200 V Class: 0.0 - 255.0 V, 400 V Class: 0.0 - 510.0 V)

■ T4-07: Motor Rated Current

No. (Hex.)	Name	Description	Default Setting (Range)
T4-07 (3136)	Motor Rated Current	<input type="checkbox"/> V/f <input type="checkbox"/> CL-V/f <input type="checkbox"/> OLV <input type="checkbox"/> CLV <input type="checkbox"/> AOLV <input type="checkbox"/> OLV/PM <input type="checkbox"/> AOLV/PM <input type="checkbox"/> CLV/PM <input checked="" type="checkbox"/> EZOLV Sets the rated current (A) of the motor.	Determined by o2-04 and C6-01 (10% to 200% of the drive rated current)

Note:

The value set here becomes the base value for motor protection, the torque limit, and torque control.

■ T4-08: Motor Rated Capacity

No. (Hex.)	Name	Description	Default Setting (Range)
T4-08 (3137)	Motor Rated Capacity	<input type="checkbox"/> V/f <input type="checkbox"/> CL-V/f <input type="checkbox"/> OLV <input type="checkbox"/> CLV <input type="checkbox"/> AOLV <input type="checkbox"/> OLV/PM <input type="checkbox"/> AOLV/PM <input type="checkbox"/> CLV/PM <input checked="" type="checkbox"/> EZOLV Sets the motor rated capacity in 0.01 kW units.	Determined by E9-10 (0.10 - 650.00 kW)

■ T4-09: Number of Motor Poles

No. (Hex.)	Name	Description	Default Setting (Range)
T4-09 (3138)	Number of Motor Poles	<input type="checkbox"/> V/f <input type="checkbox"/> CL-V/f <input type="checkbox"/> OLV <input type="checkbox"/> CLV <input type="checkbox"/> AOLV <input type="checkbox"/> OLV/PM <input type="checkbox"/> AOLV/PM <input type="checkbox"/> CLV/PM <input checked="" type="checkbox"/> EZOLV Sets the number of motor poles.	Determined by E9-01 (2 - 48)

■ T4-10: Motor Rated Slip

No. (Hex.)	Name	Description	Default Setting (Range)
T4-10 (3139)	Motor Rated Slip	<input type="checkbox"/> V/f <input type="checkbox"/> CL-V/f <input type="checkbox"/> OLV <input type="checkbox"/> CLV <input type="checkbox"/> AOLV <input type="checkbox"/> OLV/PM <input type="checkbox"/> AOLV/PM <input type="checkbox"/> CLV/PM <input checked="" type="checkbox"/> EZOLV Sets the amount of motor rated slip in Hz units.	Determined by o2-04 (0.000 - 20.000 Hz)

Note:

The value set here becomes the base value for slip compensation.

■ T4-11: Motor Line Resistance

No. (Hex.)	Name	Description	Default Setting (Range)
T4-11 (313A)	Motor Line Resistance	<div style="display: flex; justify-content: space-between; font-size: small; margin-bottom: 5px;"> V/f CL-V/f OLV CLV AOLV OLV/PM AOLV/PM CLV/PM EZOLV </div> Sets the line-to-line resistance for motor stator windings in Ω units.	Determined by E9-01, o2-04, and o2-09. (0.000 - 65.000 Ω)

Index

Numerics

- 24 V power supply
 - Power supply input terminals 75

A

- AC reactor
 - Wiring 91
- Acceleration and deceleration times
 - Switching by external input 643
 - Switching by output frequency 644
 - Switching by Motor 2 Selection commands 644
- Acceleration time
 - Parameter 643
 - Unit of measurement setting 646
- Adjustment of control functionality 163
- AEr 296
- AFR
 - Parameter 876
- Alarm 266, 296
- ALM indicator 107, 110
- ALM/ERR
 - LED status 113
- Altitude
 - Derating 378
 - Environment 29
- Ambient humidity 29
- Ambient Temperature Setting 29
 - Parameter 867
- Analog input
 - Function selection for terminals A1 through A3 800
- Analog meter
 - Monitors 127
- Analog Output
 - Gain/Bias Adjustment 813
 - Monitor Parameter Selection 813
 - Signal Level Selection 813
 - Terminal AM Monitor Selection 815
 - Terminal FM Monitor Selection 814
- Application Preset 575
 - Procedure 151
- ASR
 - Closed Loop V/f Control adjustment procedure 655
 - Fine tuning 657
 - Parameter 654
 - Vector Control Adjustment Procedure 656
- ASR tuning 157
 - Precautions 160
- Auto Restart
 - Parameter 854
- Auto-Tuning 153
 - ASR and Inertia Tuning Parameters 922
 - ASR tuning 157
 - Induction motor 153
 - Induction Motor Parameters 916
 - Inertia Tuning 157
 - PM motor 154
 - PM Motor Parameters 919
 - Precautions 159
 - Precautions to Note before ASR Tuning 160
 - Precautions to Note before Inertia Tuning 160
 - Procedure 138
 - Rotational Auto-Tuning Precautions 159
 - Stationary Auto-Tuning for Line-to-Line Resistance precautions 160
 - Stationary Auto-Tuning Precautions 160
 - Stator resistance Auto-Tuning precautions 160

- Stationary Auto-Tuning Precautions 160
- Stator resistance Auto-Tuning precautions 160
- Auto-Tuning Error 266, 315

B

- Backlight
 - Timing of shut-off 148
- Backup
 - Parameters (drive to keypad) 131
- Backup function 906
- Bar graph
 - Monitors 125
- Base frequency
 - Parameter 696
- Base Frequency
 - Motor 2 Parameters 701
- Base voltage
 - Motor 2 parameters 702
 - Parameter 697
- Basic operation
 - Get started 115
- bAT 296
- Battery
 - Disposal 359
 - Replacement 353
 - Specifications 353
- bb 296
- Bi-Directional function 681
- boL
 - Fault 273
 - Minor Fault 296
- Braking resistor
 - Wiring 85
- Braking Resistor
 - Protective function 865
- bUS
 - Detection condition settings 739
 - Detection conditions 733
 - Fault 273
 - Minor Fault 296
 - Operation Selection after Detection 732

C

- CALL 297
- Capacitor Maintenance Setting 908
- Carrier frequency
 - Parameter 664
- Carrier Frequency
 - Derating 375
 - Diminish 870
- CDBR type braking unit
 - Connect multiple units 86
 - Wiring 86
- CE
 - Detection Selection 818
 - Detection Time 818
 - Fault 273
 - Minor Fault 297
 - Operation Selection after Detection 817
- CF 274
- Checklist
 - Test run 173
- Circulation Fan
 - Replacement 342
- CoF 274
- Communication option
 - Parameter 730
- Control Circuit Terminal Block

Replacement	349	DIP switch	78
Control circuit terminals		Disposal	
Configuration of terminal block	75	Battery	359
I/O terminals function selection switches	78	Drive	359
Terminal functions	72	microSD card	359
Wire gauge	76	Packing material	359
Wiring	71	dnE	298
Wiring procedure for terminal block	77	DO-A3	
Control method		Parameter	727
Selection	572	Down 2 command	
Cooling Fan		Parameter	677, 681
Activation Conditions Setting	867	Down command	
Estimated Lifespan	339	Parameter	677, 681
Off Delay Timer	867	Down Command	760, 762
Replacement	342	Drive	
CoolingFan OperationTime Setting	908	Control Circuit Terminal Block Replacement	349
Copy Function Error	266, 320	Disposal	359
CPEr	320	Exterior Dimensions Diagram (IP20)	379
CPF00 to CPF03	275	Exterior Dimensions Diagram (UL Type 1)	381
CPF06	275	Exterior Dimensions Diagram (UL Type 1 conduit)	385
CPF07 to CPF24	275	Initialization	573
CPF25	275	Initialize Parameters	573
CPF26 to CPF45	275	Inspection	336
CPyE	320	Long-Term Storage	355
Crimp ferrule	76	Rating (200 V)	364
CrST	298	Rating (400 V)	367
CSEr	320	Drive Mode Unit Monitor Select	898
Cumulative Operation Time Select	908	Drive Model Selection	904
Cumulative Operation TimeSetting	908	Drive watt loss	33
Current Detection Speed Search	608	Droop Control	
CyC	298	Parameter	635
D		dv1	276
Data log		dv2	276
Monitor selection	146	dv3	276
Sampling time setting	146	Detection condition settings	715
Start procedure	145	dv4	276
Stop procedure	145	Detection condition settings	715
DC Injection Braking		dv7	277
Parameter	604	dWA2	298
DC reactor		dWA3	298
Wiring	91	dWAL	298
DCBusPreChargeRelayMainteSetting	908	Dwell function	
Deceleration time		Parameter	634
Parameter	643	dWF1	277
Unit of measurement setting	646	dWF2	277
Derating		dWF3	277
Altitude	378	dWFL	277
Ambient Temperature Setting	867	E	
Carrier Frequency	375	E5	
Enclosure Type	870	Fault	278
External Cooling Fin	870	Minor Fault	299
Finless	870	Operation Selection after Detection	739
Side-by-side	870	Earth leakage circuit breaker	
dEv		Wiring	88
Detection level	714	EF	299
Detection time	714	EF0	
Fault	275	Detection conditions	732
Minor Fault	298	Detection conditions setting (DeviceNet)	742
Operation Selection after Detection	713	Fault	278
dFPS	320	Minor Fault	299
DI-A3		Operation Selection after Detection	732
Parameter	720	EF1	
Diagnosing and Resetting Faults	322	Fault	278
Digital input option		Minor Fault	299
Parameter	720	EF2	
Digital output option		Fault	278
Parameter	727	Minor Fault	299

EF3			
Fault	278	
Minor Fault	300	
EF4			
Fault	279	
Minor Fault	300	
EF5			
Fault	279	
Minor Fault	300	
EF6			
Fault	279	
Minor Fault	300	
EF7			
Fault	279	
Minor Fault	300	
EF8			
Fault	279	
Minor Fault	301	
ELCB			
Wiring	88	
Electrolytic Capacitor			
Estimated Lifespan	339	
Enclosure Type			
Change to UL Type 1	44	
Derating	870	
Encoder option			
Parameter	711	
End1	315	
End2	315	
End3	315	
End4	315	
End5	315	
End6	315	
End7	316	
Energy-saving control			
Parameter	637	
Enter command	238	
EP24v	301	
Er-01	316	
Er-02	316	
Er-03	316	
Er-04	316	
Er-05	317	
Er-08	317	
Er-09	317	
Er-10	317	
Er-11	317	
Er-12	318	
Er-13	318	
Er-14	318	
Er-15	318	
Er-16	318	
Er-17	318	
Er-18	318	
Er-19	318	
Er-20	319	
Er-21	319	
Er-25	319	
ERF type braking resistor			
Protective function	865	
Wiring	85	
Err	280	
Error Code List	267	
Exterior and mounting dimensions			
Installation dimensions	46	
Panel cut out dimensions	46	
Exterior Dimensions Diagram (IP20)			
Drive	379	
Exterior Dimensions Diagram (UL Type 1)			
Drive	381	
External 24 V power supply			
Power supply input terminals	75	
External Cooling Fin			
Derating	870	
Exterior Dimensions Diagram (UL Type 1 conduit)			
Drive	385	
F			
FAn			
Fault	280	
Minor Fault	301	
FAn1	280	
Fast stop time			
Parameter	646	
Fault	266, 273	
Fault code			
MEMOBUS/Modbus	258	
Fault Code List	267	
Fault history			
Display procedure	137	
Fault Reset	322	
FbH			
Fault	280	
Minor Fault	301	
FbL			
Fault	280	
Minor Fault	301	
Feed Forward Control			
Parameter	884	
Field Forcing			
Parameter	687	
Field weakening			
Parameter	687	
Fine tuning	163	
Finless			
Derating	870	
Firmware update lock	590	
Freq Ref Setting Method Select	904	
Freq reference bias			
Parameter	681	
Frequency Agreement			
Parameter	853	
Frequency reference			
Command source correlation diagram	668	
LOCAL/REMOTE Run selection	592, 668	
Offset frequency addition	688	
Switching between LOCAL/REMOTE	592, 668	
Upper and lower frequency limits	674	
Frequency Reference			
Making changes using keypad	122	
Switching between LOCAL/REMOTE	600	
Frequency reference bias			
Parameter	677	
Frequency reference hold function			
Parameter	677, 681	
Fuse rating	95	
G			
Getting set up	115	
GF	281	
Protective function	867	
GFCI			
Wiring	88	
Ground			
Drive	64	

Ground Fault Detection			
Protective function	867		
H			
HCA	302		
Alarm Settings	871		
HD	363		
Heavy Duty Rating	363		
High-Slip Braking			
Parameter	877		
HOME screen	122		
How to read model numbers	21		
Humidity			
Environment	29		
I			
iFer	320		
IGBT Maintenance Setting	909		
Induction motor			
Auto-Tuning	153		
Inertia Tuning	157		
Precautions	160		
Input Phase Detection			
Protective function	866		
Input voltage			
Parameter	690		
Inspection			
Drive	336		
Installation			
Front cover	42		
Keypad	36		
Terminal cover	42		
UL Type 1 protective cover	44		
Installation dimensions	46		
Installation environment	29		
Interlock			
Circuit example	84		
Internal Drive Braking Transistor			
Protective function	872		
J			
Jog command	674		
Jog operation	122		
JOG operation	122		
Jump frequency			
Parameter	675		
Jumper switch	78		
K			
KEB ride-thru function			
Compensation Time	840		
Parameter	833		
KEB Ride-Thru function			
Operation during momentary power loss	838		
KEB Ride-Thru Function			
KEB Method Selection	842		
Single Drive KEB Method	842		
System KEB Method	842		
Keypad			
Application Preset	151		
Backlight setting	148		
Battery Replacement	353		
Data log setting	146		
Display drive information	149		
Display software version	149		
External dimensions	37		
HOME screen	122		
Installation	36		
Installation on control panel	37		
Language selection	140, 571		
Meaning of indicators	107		
Method of operation	107		
Remove	36		
Set date and time	141		
Set time	141		
Setup Wizard	143		
Start/stop data logging	145		
Keypad Display	897		
Keypad Display Selection	898		
Keypad Operation	903		
Keypad-related settings	897		
kWh Monitor Initialization	909		
L			
L24v	302		
Language selection	571		
Procedure	140		
LCD contrast adjustment	899		
LED Light Function Selection	906		
LED status ring			
ALM/ERR	113		
Ready	113		
RUN	113		
LF	281		
Protective function	866		
LF2	281		
Protective function	869		
LKEB type braking resistor unit			
Wiring	85		
Load Inertia Ratio			
Parameter	851		
LOCAL/REMOTE indicator	107, 110		
LoG	302		
LO/RE Key Function Selection	903		
LSo	282		
Protective function	873		
LT-1	303		
LT-2	303		
LT-3	303		
LT-4	303		
M			
Main circuit terminals			
Configuration of terminal block	53		
Line voltage drop	55		
Wire gauge	55		
Wiring procedure for terminal block	68		
Main menu			
Display procedure	122		
Maintenance Period	907		
Maximum Output Frequency			
Motor 2 Parameters	700		
Parameter	695		
Maximum Output Voltage			
Motor 2 Parameters	701		
Parameter	696		
MCCB			
Wiring	88		
Mechanical Weakening Detection			
Parameter	857		
MEMOBUS			
Broadcast Messages	257		
Command data	240		
Communication specifications	232		
Enter command	238		
Fault code	258		
Loopback test	238		
MEMOBUS/Modbus error code	261		

Minor fault code	260
Monitor data	243
Register reading	237
Register writing	238
Self-diagnosis	239
Wiring	232
MEMOBUS/Modbus communications	
Serial communication terminals	75
Setting for termination resistor	83
MEMOBUS/Modbus Communications	
Parameter	816
microSD card	
Disposal	359
Insertion slot	107
Mid point B frequency	
Motor 2 parameters	701
Parameter	696
Mid point B voltage	
Motor 2 parameters	702
Parameter	697
Middle Output Frequency	
Motor 2 Parameters	701
Parameter	696
Middle Output Frequency Voltage	
Motor 2 Parameters	701
Parameter	696
Minimum output frequency	
Parameter	696
Minimum Output Frequency	
Motor 2 Parameters	701
Induction Motor	
Motor Parameters	697
Minimum Output Voltage	
Motor 2 Parameters	701
Parameter	696
Minor Fault	266, 296
Minor fault code	
MEMOBUS/Modbus	260
Minor Fault Code List	267
Modbus	
Broadcast Messages	257
Command data	240
Communication specifications	232
Enter command	238
Fault code	258
Loopback test	238
MEMOBUS/Modbus error code	261
Minor fault code	260
Monitor data	243
Register reading	237
Register writing	238
Self-diagnosis	239
Wiring	232
Molded-case circuit breaker	
Wiring	88
Momentary Power Loss	
KEB Compensation Time	840
Monitors	
Data log setting	146
Display analog meter	127
Display bar graph	125
Display procedure	123
Set monitoring favorites	124
Show monitoring favorites	124
Start/stop data logging	145
Motor	
Change direction of motor rotation	122

Positive Temperature Coefficient (PTC) Thermistor	827
Wiring distance	64
Motor 2	
Base Frequency	701
Base voltage	702
Control mode settings	700
Leakage Inductance	703
Line-to-Line Resistance	703
Maximum Output Frequency	700
Maximum Output Voltage	701
Mid point B frequency	701
Mid point B voltage	702
Middle Output Frequency	701
Middle Output Frequency Voltage	701
Minimum Output Frequency	701
Minimum Output Voltage	701
Motor Iron Loss	704
Motor Iron-Core Saturation Coefficient 1	704
Motor Iron-Core Saturation Coefficient 2	704
Motor rated power (kW)	704
No-load Current	703
Number of motor poles	703
Rated current	702
Rated Slip	702
V/f Pattern	700
Motor Code Selection	705
Motor Overheating	
Operation During Detection of Alarms	222, 831
Operation During Detection of Faults (PTC Input)	223, 832
Motor overload	
Motor Overload Protection Time	222, 831
Motor parameters	
Motor 2	702
Motor 2 number of motor poles	703
Motor 2 rated Current	702
Motor 2 rated power (kW)	704
Motor Parameters	689, 697
Motor 2 Iron Loss	704
Motor 2 Iron-Core Saturation Coefficient 1	704
Motor 2 Iron-Core Saturation Coefficient 2	704
Motor 2 Leakage Inductance	703
Motor 2 Line-to-Line Resistance	703
Motor 2 No-load Current	703
Motor 2 Rated Slip	702
Motor parameters (induction motors)	697
Leakage Inductance	699
Line-to-Line Resistance	698
Motor Iron Loss	699
Motor Iron-Core Saturation Coefficient 1	699
Motor Iron-Core Saturation Coefficient 2	699
Motor rated power (kW)	699
No-load Current	698
Number of motor poles	698
Rated current	218, 697
Rated Slip	698
MotorDirect@PowUpWhenUsingKeypad	905
Multi-step speed operation	668
Setting procedure	668
N	
Nameplate	21
ND	363
ndAT	320
Noise filter	
Wiring	93
Normal Duty Rating	363
nSE	282
NumOfRunCommands Counter Initial	909

O	
oC	282
Overcurrent Detection Gain	869
oFA00	284
oFA01	284
oFA02	284
oFA03 to oFA06	284
oFA10	284
oFA11	284
oFA12 to oFA17	284
oFA30 to oFA43	284
oFb00	285
oFb01	285
oFb02	285
oFb03 to oFb11	285
oFb12 to oFb17	285
oFC00	285
oFC01	285
oFC02	285
oFC03 to oFC11	286
oFC12 to oFC17	286
oFC50 to oFC55	286
Off-Delay Timer	616
Offset frequency	
Parameter	688
oH	
Alarm Settings	865
Fault	286
Minor Fault	303
oH1	286
oH2	303
Alarm Settings	865
oH3	
Fault	286
Minor Fault	304
Operation During Detection of Alarms	222, 831
oH4	287
Operation During Detection of Faults (PTC Input)	223, 832
oL1	287
oL2	288
Protective function	867
oL3	
Fault	289
Minor Fault	304
oL4	
Fault	289
Minor Fault	304
oL5	
Fault	289
Minor Fault	304
oL7	290
On-Delay Timer	616
Ope Select @Keypad is Disconnect	905
oPE01	309
oPE02	309
oPE03	309
oPE05	311
oPE06	311
oPE07	312
oPE08	312
oPE09	313
oPE10	313
oPE11	313
oPE13	314
oPE15	314
oPE16	314
oPE18	314
oPE20	314
Operation during momentary power loss	
KEB ride-thru function	833
Operation method selection	838
Parameter	838
Operation During Momentary Power Loss	
Speed Search function	607
oPr	290
Option card	
Parameter	711
Options	386
oS	
Detection level	714
Detection time	714
Fault	290
Minor Fault	305
Operation Select at Overspeed	712
Output Phase Loss Detection	
Protective function	866
ov	
Fault	290
Minor Fault	305
Overexcitation deceleration	
Parameter	878
Overload	
Protective function	219, 828
Overtorque detection	
Parameter	856
P	
Panel cut out dimensions	46
Parameter	
Access Level Selection	571
Automatic selection	591
Backup (drive to keypad)	131
Changing setting values	129
Checking commonly used parameters	130
Checking modified parameters	134
Restore (keypad to drive)	132
Restoring default settings	136
User-set	591
Verify (keypad and drive)	133
Parameter Setting Errors	266, 309
PASS	305
Password	
Setting	575
Verification	574
Peripheral Devices	386
PF	291, 305
Protective function	866
PGo	
Detection time	715
Fault	292
Minor Fault	306
Operation Selection after Detection	712
PGoH	
Detection level	718
Fault	292
Level detection (PG1)	716
Level detection (PG2)	717
Minor Fault	306
Phase Order Selection	600
PID control	618
control block diagram	620
Feedback value input	619
fine tuning	621
Parameter	623
PID feedback loss detection	620

PID Sleep	621
Setpoint input	619
PM motor	
Auto-Tuning	154
PM motor parameters	
d-Axis inductance	706
Encoder Z pulse offset	707
Induced voltage constant 1	707
Induced voltage constant 2	707
Motor rated power (kW)	705
Number of motor poles	706
q-Axis inductance	706
Stator resistance	706
PM Motor parameters	
Motor rated current	218, 705
PM Motor Parameters	705
PM Motors	
Fine Adjustment	888
Motor Code Selection	705
Motor Parameters	705
Positive Temperature Coefficient (PTC) Thermistor	827
Power loss	33
Protective function	
DC bus undervoltage	840
Desynchronization	873
Drive Overheating	865
GF	867
Ground Fault Detection	867
HCA	871
Input Phase Detection	866
Internal Drive Braking Transistor	872
LF	866
LF2	869
Low Speed Desynchronization	873
LSo	873
Motor Overheating	222, 831
Motor Overheating (PTC Input)	223, 832
oC	869
oH	865
oH2	865
oH3	222, 831
oH4	223, 832
oL2	867
Output Current Overload	871
Output Phase Loss Detection	866
Overcurrent	869
Overload	219, 828, 867
PF	866
rr	872
Software Current Limit Selection	868
Uv1	840
Pulse Train Input	
Terminal RP Function Selection	820
Pulse Train Input/Output	
Parameter	820
Pulse train output	
Terminal MP function selection	822
Wiring specifications	80
R	
Rating (200 V)	
Drive	364
Rating (400 V)	
Drive	367
RCM/RCD	
Wiring	88
rdEr	321
Ready	

LED status	113
Remove	
Front cover	42
Keypad	36
Terminal cover	42
RESET key	107
Restore	
Parameters (keypad to drive)	132
Reverse Operation Selection	597
rF	292
rH	292
RJ-45 connector	107
Rotational Auto-Tuning	
Induction motor	153
PM motor	154
Precautions	159
rr	293
Protective function	872
rUn	306
RUN	
LED status	113
Run command	
LOCAL/REMOTE Run Selection	594
Switching between LOCAL/REMOTE	594
Run Command at Power Up	603
Run Command Selection 2	
Switching between LOCAL/REMOTE	602
RUN indicator	107, 110
RUN key	107
S	
S-curve characteristics	
Parameter	647
Sampling time	
Data log	146
SC	293
SCF	293
SE	306
SEr	293
Serial communication terminals	
MEMOBUS/Modbus communications	75
Set date and time	
Procedure	141
Set time	
Procedure	141
Setup Wizard	
Procedure	143
Short Circuit Braking	
Parameter	604
Side-by-side	
Derating	870
Simple Positioning Stop	681
Slip compensation	
Parameter	648
Software Current Limit Selection	
Protective function	868
Software version	
Display procedure	149
Speed Agreement	
Parameter	853
Speed Detection	
Parameter	853
Speed Estimation Speed Search	609
Speed limit	
Parameter	682
Speed search function	
Operation during momentary power loss	838
Speed Search function	

Parameter	607	U	
Stall Prevention function		U2, U3 Initialization	909
Parameter	843	UL Type 1	
Stationary Auto-Tuning		Attach protective cover	44
Induction motor	153	UL3	
PM motor	154	Fault	294
Precautions	160	Minor Fault	307
Stationary Auto-Tuning for Line-to-Line Resistance	153	UL4	
Precautions	160	Fault	294
Stator resistance Auto-Tuning	154	Minor Fault	307
Precautions	160	UL5	
STo	306	Fault	294
SToF	307	Minor Fault	307
Stop command		Undertorque detection	
LOCAL/REMOTE Run Selection	594	Parameter	856
STOP key	107	Unit of measurement setting	
STOP Key Function Selection	903	Acceleration and deceleration times	646
Stopping Method Selection	594	Up 2 command	
STPo	294	Parameter	677, 681
Surge protective device		Up command	
Connection	92	Parameter	677, 681
SvE	294	Up Command	760, 762
T		USB port	107
Temperature		User Monitor Select afterPowerUp	898
Environment	29	User Parameter Default Value	904
Terminal block	75	User-Set Display Units Max Value	899
Configuration of main circuit terminal block	53	User-SetDisplayUnits Dec Display	900
Control circuit terminal block functions	72	Uv	307
I/O terminals function selection switches	78	Speed Search Selection at Start	615
Terminal function selection	81	Uv1	295
Terminal A1	78, 81	Detection level settings	840
Terminal A2	78, 81	Uv2	295
Terminal A3	78, 82	Uv3	295
Terminal AM	78, 82	V	
Terminal FM	78, 82	vAer	321
Termination resistor		V/f Pattern	689
Setting switch	83	Second Motor	700
Test run		V/f Pattern Display Unit	899
Checklist	173	Verify	
Fine tuning	163	Parameters (keypad and drive)	133
Procedure	115	vFyE	321
Procedure for no-load test run	161	Vibration-resistant	29
Procedure for test run with actual load	161	W	
Thermal overload relay		Wire gauge	
Connection	89	Control circuit terminals	76
Tightening torque		Main circuit terminals	55
Control circuit terminals	76	Voltage drop	55
Main circuit terminals	55	Wiring	
Timer function		AC reactor	91
Parameter	616	Braking resistor	85
Torque compensation		Checklist	99
Parameter	682	Control circuit terminal block	77
Torque Compensation		Control circuit terminals	71
Parameter	652	DC reactor	91
Torque Control		Earth Leakage Circuit Breaker	88
Parameter	681	ELCB	88
Switching to/from Speed Control	685	GFCI	88
Torque limit function		Main circuit terminal block	68
Parameter	861	MCCB	88
Torque reference		MEMOBUS/Modbus	232
Parameter	682	Molded-case circuit breaker	88
Troubleshooting		Noise filter	93
Code Displayed	267	RCM/RCD	88
No Code Displayed	323	Thermal overload relay	89
Troubleshooting without Fault Display	323	Wiring distance	
TrPC	307	Drive and motor	64
Tuning	643		

Z

Z pulse Auto-Tuning	154
Zero Servo function	
Parameter	641

Revision History

Date of Publication	Revision Number	Section	Revised Content
June 2016	1	All	Revision: Reviewed and corrected entire documentation. Upgraded drive software version to PRG: 1011.
May 2016	–	–	First Edition

YASKAWA AC Drive GA700

High Performance Type Technical Manual

DRIVE CENTER (INVERTER PLANT)

2-13-1, Nishimiyaichi, Yukuhashi, Fukuoka, 824-8511, Japan
Phone: +81-930-25-2548 Fax: +81-930-25-3431
<http://www.yaskawa.co.jp>

YASKAWA ELECTRIC CORPORATION

New Pier Takeshiba South Tower, 1-16-1, Kaigan, Minatoku, Tokyo, 105-6891, Japan
Phone: +81-3-5402-4502 Fax: +81-3-5402-4580
<http://www.yaskawa.co.jp>

YASKAWA AMERICA, INC.

2121, Norman Drive South, Waukegan, IL 60085, U.S.A.
Phone: +1-800-YASKAWA (927-5292) or +1-847-887-7000 Fax: +1-847-887-7310
<http://www.yaskawa.com>

YASKAWA ELÉTRICO DO BRASIL LTDA.

777, Avenida Piraporinha, Diadema, São Paulo, 09950-000, Brasil
Phone: +55-11-3585-1100 Fax: +55-11-3585-1187
<http://www.yaskawa.com.br>

YASKAWA EUROPE GmbH

Hauptstraße 185, 65760 Eschborn, Germany
Phone: +49-6196-569-500
E-mail: support@yaskawa.eu.com
<http://www.yaskawa.eu.com>

YASKAWA ELECTRIC KOREA CORPORATION

9F, Kyobo Securities Bldg., 97, Uisadang-daero, Yeongdeungpo-gu, Seoul, Korea 07327
Phone: +82-2-784-7844 Fax: +82-2-784-8495
<http://www.yaskawa.co.kr>

YASKAWA ELECTRIC (SINGAPORE) PTE. LTD.

151, Lorong Chuan, #04-02A, New Tech Park, 556741, Singapore
Phone: +65-6282-3003 Fax: +65-6289-3003
<http://www.yaskawa.com.sg>

YASKAWA ELECTRIC (THAILAND) CO., LTD.

59, 1st-5th Floor, Flourish Building, Soi Ratchadapisek 18, Ratchadapisek Road, Huaykwang, Bangkok, 10310, Thailand
Phone: +66-2-017-0099 Fax: +66-2-017-0799
<http://www.yaskawa.co.th>

YASKAWA ELECTRIC (CHINA) CO., LTD.

22F, One Corporate Avenue, No.222, Hubin Road, Shanghai, 200021, China
Phone: +86-21-5385-2200 Fax: +86-21-5385-3299
<http://www.yaskawa.com.cn>

YASKAWA ELECTRIC (CHINA) CO., LTD. BEIJING OFFICE

Room 1011, Tower W3 Oriental Plaza, No. 1, East Chang An Ave.,
Dong Cheng District, Beijing, 100738, China
Phone: +86-10-8518-4086 Fax: +86-10-8518-4082

YASKAWA ELECTRIC TAIWAN CORPORATION

9F, 16, Nanking E. Rd., Sec. 3, Taipei, 104, Taiwan
Phone: +886-2-2502-5003 Fax: +886-2-2505-1280
<http://www.yaskawa.com.tw>

YASKAWA INDIA PRIVATE LIMITED

#17/A, Electronics City, Hosur Road, Bangalore, 560 100 (Karnataka), India
Phone: +91-80-4244-1900 Fax: +91-80-4244-1901
<http://www.yaskawaindia.in>

YASKAWA

YASKAWA ELECTRIC CORPORATION

In the event that the end user of this product is to be the military and said product is to be employed in any weapons systems or the manufacture thereof, the export will fall under the relevant regulations as stipulated in the Foreign Exchange and Foreign Trade Regulations. Therefore, be sure to follow all procedures and submit all relevant documentation according to any and all rules, regulations and laws that may apply.

Specifications are subject to change without notice for ongoing product modifications and improvements.

© 2016 YASKAWA Electric Corporation

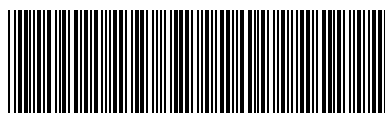

SIEPC71061701

MANUAL NO. SIEP C710617 01B <1>-0
Published in Japan June 2016
16-4-16
Original instructions