

YASKAWA

MOTION CONTROL PRODUCTS

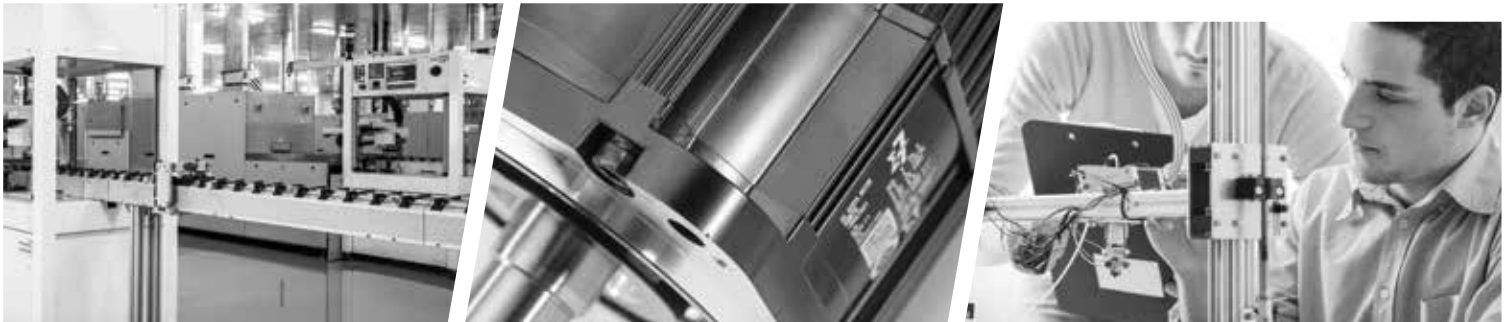

CONFIDENT.
CONSISTENT.
CAPABLE OF MORE.

BE CAPABLE OF MORE

If you're a machine builder or equipment user, you know all about high expectations, limited resources and tight deadlines. Your success depends on suppliers who respond with precisely the right products, delivered with consistency and reliability that never fails.

Yaskawa has been putting this brand of customer success in motion for 100 years. It shows in today's commitment to innovative automation technology, to engineering expertise, and to the operational strength that is the proof behind our promise.



CONFIDENT

PRODUCTS THAT PERFORM

Product performance is more than just a specification. It is the confidence that your machines will work as expected ... every time ... in a way that consistently outperforms your competition.

Breakthrough performance. Your machine functions at a level that can't be achieved with other automation solutions.

A competitive price. You can provide an effective, trustworthy solution at a cost that makes your machine an exceptional value.

Quality, right out of the box. Your systems work as expected, the first time and every time.



CONSISTENT

EXCELLENCE IN OPERATION

Problems with component quality, supply chain hiccups and downtime surprises are simply unacceptable. You need a partner with the operational rigor and expertise to engineer them out of existence.

Inventory for faster fulfillment. Your products are available precisely when and where you need them.

Legendary quality. Your equipment continues to operate reliably and without intervention.

Global service and support. You can rely on timely, helpful technical assistance wherever you or your equipment may be.



CAPABLE

ENGINEERING EXPERTISE. RIGHT NOW

Focus your engineers on their core competencies while still delivering effective machine automation, thanks to a team of Yaskawa engineers who can instantly add power to automation design, development and support.

Motion application expertise. Call on proven automation experts to assist with electromechanical design and development.

Software development. Turn to a team of automation software specialists to streamline your development process.

Engineered systems. Implement complete mechanical and electrical sub-systems that are fully supported for the life of your machine.

"It's Personal" is our commitment to giving you a great experience each time you deal with Yaskawa.



We train people, create products and treat customers with the belief that everything we do matters. With an attitude like this, it's only natural to see everything we do as an intensely personal act.

We commit to that at Yaskawa. We make it happen. **Because to us ... it's personal.**



PRODUCTS THAT PERFORM

POWER UP YOUR PRODUCTIVITY

WHEN MORE IS NOT ENOUGH

In a rapidly changing global marketplace, today's landmarks for world-class machine performance are tomorrow's everyday expectations. Your customers demand the maximum in machine effectiveness, throughput and quality, regardless of a machine's mechanical and design limitations. Your job is to do it all, and at a competitive cost.

YOUR NEED: **PERFORMANCE PLUS**

To stay ahead of competition, you need to continually push the edge of the envelope on machine performance. This extraordinary effort consumes your time, stresses machine mechanisms and impacts the reliability of your finished product. The result is a risk of lost revenue, or of disappointing your key customers.

This environment leaves no room for components that can't be trusted, or for suppliers that create delays in development and delivery.

WHAT IF ...

- You could significantly reduce, or completely eliminate, the time spent optimizing the motion performance of your machine?
- Your servo system could overcome the mechanical limitations of your design?
- You could confidently achieve the highest attainable levels of throughput and effectiveness?

PRODUCT PERFORMANCE
IS MORE THAN JUST
A SPECIFICATION



YOUR GAIN: **A BOOST IN PRODUCTIVITY**

With motion control systems from Yaskawa, you have access to solutions that provide real impact on equipment effectiveness. You enjoy confidence that your machines will work as expected every time, which gives you an advantage over your competitors.

TUNING TIME SAVINGS

Yaskawa's well-earned reputation for the best performance in the industry is enhanced by our Tuning-less Mode, that keeps your machine running at peak efficiency for life by eliminating the need to optimize tuning gains. Electronic Vibration Suppression automatically compensates for limitations in a machine's mechanical design, creating consistent performance in a machine's output.

INITIAL QUALITY

The definition of initial quality is simple: you get what you expect. Yaskawa products ship on time, work out of the box every time, perform as expected, and continue to do so for the life of your machine.

COMPETITIVE PRICE

Yaskawa maintains a #1 market share in some of the world's most price-sensitive industries, which is proof of Yaskawa's superior balance between operational performance and return on your investment.

BE CONFIDENT

EXCELLENCE IN OPERATION

RESOURCES, RESPONSIVENESS AND RELIABILITY

TODAY, QUALITY IS ONLY THE BEGINNING

Your global customer base means your machines must operate anywhere in the world. Your customers' cultures may be different, but they share one thing in common: the need for instant gratification when it comes to product availability, flawless product performance and immediate 24/7 service and support.

YOUR NEED: SPEED AND SUCCESS

When your customers are demanding instant perfection, you can't afford to work with ordinary suppliers. Everyone in your supply chain must be completely reliable in supply and rapid in response to any customer question.

Quality problems simply cannot be part of the equation. Nor can a shortage in engineering support in a fast-tracked machine design process.

WHAT IF ...

- You had no worries about the reliability of your automation system?
- You could reduce your machine lead time and spare parts inventory?
- You had expert service and support wherever your machines might be located?

YASKAWA QUALITY IS THE INDUSTRY BENCHMARK

From 2011 to 2013, Yaskawa shipped nearly 150,000 Sigma-5 motors in North America with only 10 warranty failures.

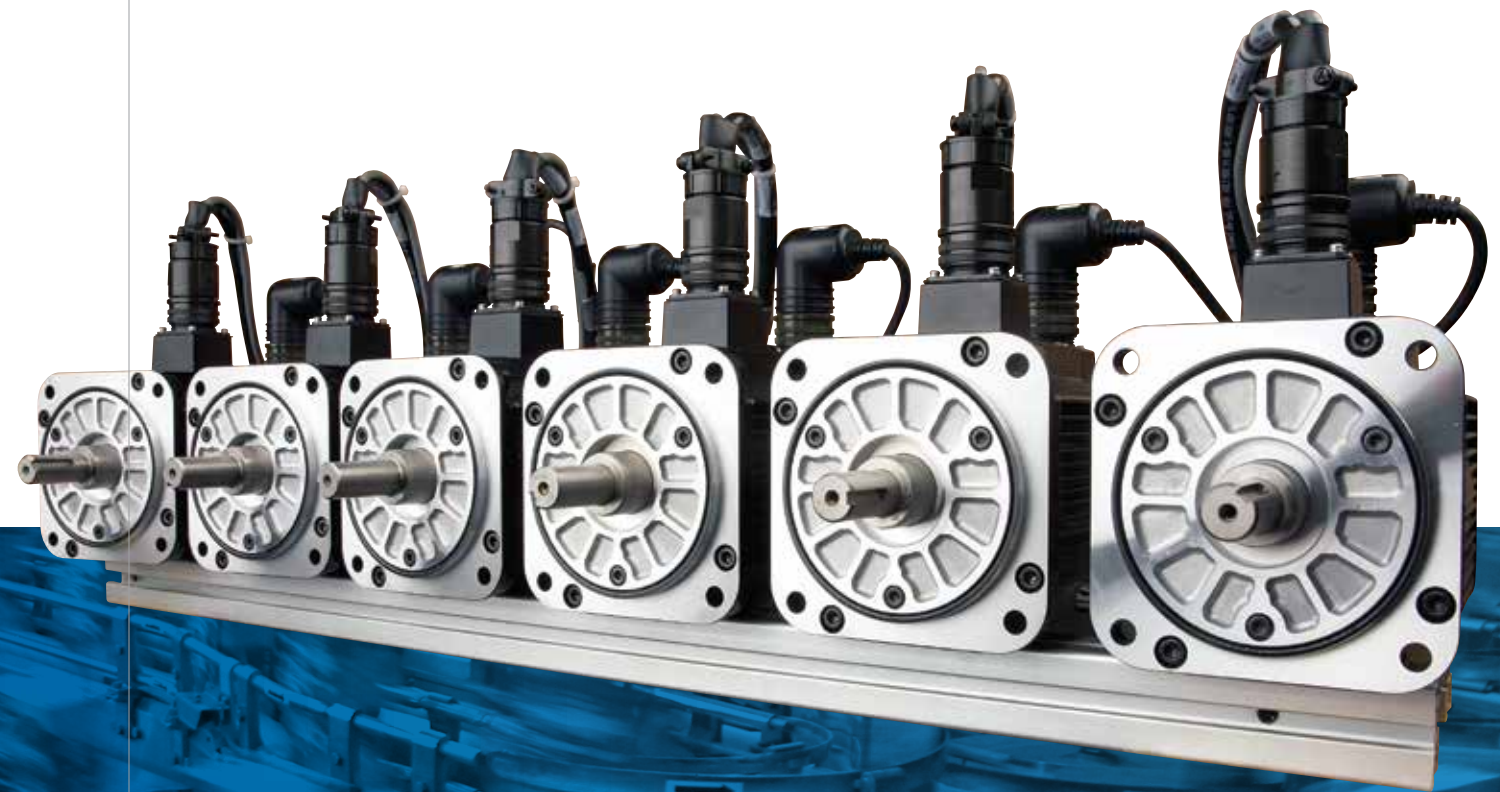

YOUR GAIN: GLOBAL EXCELLENCE

Yaskawa has a long track record for reliable quality, responsive support and rapid product availability. The reason behind these achievements is a simple one: our customers can't afford to settle for anything less.

INVENTORY FOR FASTER FULFILLMENT

Yaskawa maintains a \$14M inventory of motion products in the US, for 95%+ on-time response to customer requests.

A LEGACY OF QUALITY

Yaskawa's award-winning quality has been the motion industry's quality benchmark for decades. Yaskawa products practically never fail, and we can stand behind this statement with 100 years of evidence.

GLOBAL SERVICE AND SUPPORT

As a truly global company, Yaskawa can offer local service and support worldwide. Whether your machine is installed in Asia, Europe or the Americas, Yaskawa can help reduce service costs by providing expert service anywhere you need it.

BE CONSISTENT

ENGINEERING EXPERTISE, NOW

INSIGHT AND INNOVATION. INSTANTLY.

TOP RESOURCES FOR TOUGH PROBLEMS

Today's companies face an acute talent shortage. At the same time, the demand for innovative solutions and effective technologies is stronger than ever. New designs must be brought to market in months or weeks instead of years, all while increasing efficiency, flexibility and quality.

Few companies can afford the luxury of a large engineering staff. True automation expertise is increasingly rare, and the competition for hiring automation engineers is stiff.

ENGINEERS, OR FIREFIGHTERS?

Your engineering staff needs to focus on your company's core competencies. Instead, they are distracted with putting out fires when they should be creating innovations.

These limitations slow the development of automation solutions. They also lead to unreliable long-term operation of your machine. Trial and error in the development process is no longer an option. Nor is downtime or lost production.

WHAT IF ...

- You could add expert automation engineers to your staff at the exact moment you need them?
- Responsibility for designing and supporting your automation could be handed off to someone you trusted?
- Your engineering staff was free to focus on areas where they can truly add value?

YOUR GAIN: EFFECTIVE INNOVATION

For the past 100 years of industrial history, Yaskawa engineers have worked side-by-side with machine builders and end users in manufacturing. Then as now, we've functioned as an extension of your engineering staff to create elegant, reliable automation.

The Yaskawa commitment begins by listening, fully understanding your application and process, the results you need to achieve, your time frame and cost structure. This effort to understand your design and process is unique. It's what sets us apart, and it results in a set of tangible benefits that go directly to your engineering bottom line.

MOTION APPLICATION EXPERTISE

Yaskawa's engineering expertise can be applied to any stage of machine development.

- System concept design
- Component selection
- Electrical design
- Mechatronic design
- Machine start-up
- Programming
- Optimization
- Troubleshooting

YOU NO LONGER HAVE
THE LUXURY OF A LARGE
ENGINEERING STAFF



SOFTWARE DEVELOPMENT

Software design and development can be the key to an automated machine's success or the reason for its failure. Yaskawa software expertise makes the difference, thanks to a staff of engineers who understand proper software design and the ways it can impact real-world machine operation.

ENGINEERED SYSTEMS

Under the banner of Engineered Systems, Yaskawa offers a range of advanced products and services. They include complete machine retrofits, enclosure design and manufacturing, electromechanical assembly design, and integration of Yaskawa servo technology into a "purpose built" mechanism for your application.



BE CAPABLE OF MORE

GLOBAL OVERVIEW

YASKAWA—GLOBAL LEADER IN AUTOMATION, DRIVE TECHNOLOGY, AND ROBOTICS

Yaskawa is one of the world's leading manufacturers of drive technology, industrial automation, and robotics. Founded in 1915, Yaskawa has been a pioneer in the drive to optimize the productivity and efficiency of machines and industrial systems.

- \$4B/year in global sales
- 800,000 servo amplifiers per year
- 1 million servo motors per year
- 1.8 million inverters per year
- 20,000 robots per year
- Over 14,500 associates worldwide
- Yaskawa Sales, Service, and Manufacturing companies in 25 countries

YASKAWA GLOBAL LOCATIONS

NORTH AMERICA & SOUTH AMERICA

U.S.A.
Brazil
Canada
Mexico

ASIA PACIFIC

China
Japan
Korea
Taiwan
Singapore
Thailand
Indonesia
India

AFRICA

South Africa

EUROPE

Germany
Sweden
U.K.
Israel
Italy
France
Spain
Finland
Netherlands
Slovenia
Czech Republic
Turkey



Over the past 30 years, Yaskawa has produced more than 10 million servo amplifiers, 18 million variable frequency drives, and 300,000 robots.

PRODUCT PORTFOLIO: TOTAL SYSTEM SOLUTIONS

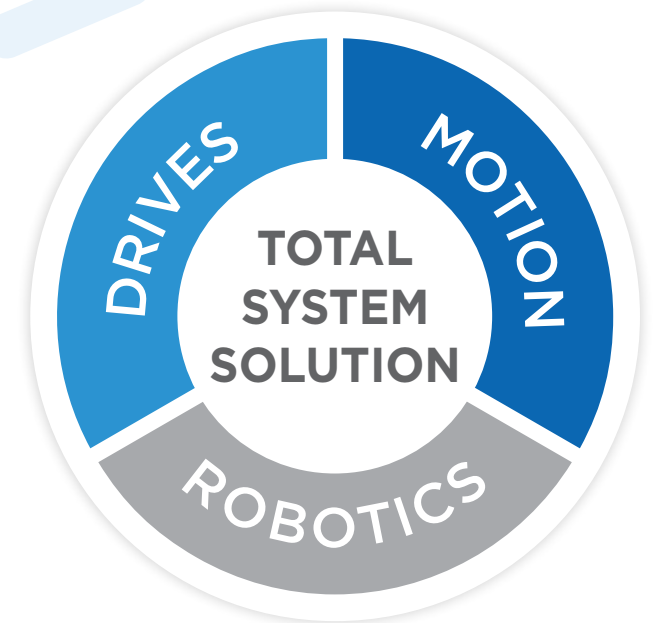

SOFTWARE

SOFTWARE

MotionWorks[®] IEC, Yaskawa's IEC61131-3 programming environment, gives a programmer the best of several programming languages in one development platform.



CONTROL

MACHINE CONTROLLERS

MPiec Machine Controllers integrate Yaskawa's powerful motion engine with the IEC61131-3 and PLCopen programming standards, for control from 1 to 62 axes.



INPUT/OUTPUT

I/O

Yaskawa VIPA SLIO is one of the most effective and modern decentralized I/O systems available, providing exceptional usability in an extremely compact and functional design.

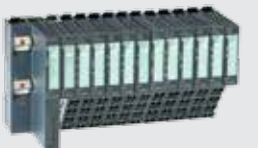

SERVO AMPLIFIERS & MOTORS

SIGMA SERIES SERVO SYSTEMS

Rotary, Linear and Direct Drive servos from 3W to 55kW offer advanced features, including Tuning-less Mode, vibration suppression, ripple and friction compensation.



VARIABLE SPEED DRIVES

INVERTER DRIVES

Yaskawa drives incorporate the latest technological advancements in variable speed AC motor control, with power ranges from fractional HP to 2250 HP.



ROBOTICS

ROBOTICS

The Yaskawa Robotic product portfolio ranges from 4-15 axis industrial robots with load capacities of 2 to 800 kg to special machines, devices and turnkey systems.



MPIEC MACHINE CONTROLLERS



*EASY FOR YOU.
CONSISTENT
FOR EVERYONE.*

To stay a step ahead of the competition, you need programming software that is easy to learn, familiar in format and efficient to work with.

Your controller hardware must be readily accessible to peripheral devices anywhere in the world, yet keep functional control and user experience perfectly consistent from machine to machine.

THE DEMAND: FLEXIBLE AND RELIABLE

Today's customers need to keep a finger on the pulse of their machines at all times. Success means maintaining peak productivity, total reliability and endless freedom to interact with the systems they control.

WHAT IF ...

- Key elements of code are already written for you, using a standard, globally recognized programming language?
- Your customers can safely access your machine controller from anywhere in the world?
- Programming one of your machines easily leads to programming all your machines?

YASKAWA CONTROL: WHAT YOU GAIN

With easy-to-learn MotionWorks® IEC software and MPiec hardware, your engineers start programming quicker and stay connected more easily.

The result? Faster machine commissioning and more rapid machine delivery to market.

A FAMILIAR PROGRAMMING STANDARD

MotionWorks IEC complies with IEC61131-3, and provides five globally recognized standard programming languages. It includes motion function blocks that adhere to the PLCopen standard. Experienced control engineers will find this software comfortably familiar, and learning to program with MotionWorks IEC has never been easier.

BUILT-IN YASKAWA TOOLBOXES

Yaskawa toolboxes make programming common functions so easy, it's like having a Yaskawa engineer working by your side. Development time is reduced because standard code elements are already written and ready for use.

A REUSABLE CODE LIBRARY

Import and re-use previously developed logic to speed up new projects. Re-use your own work or draw on logic created by others.



EASY CONNECTIVITY, WORLDWIDE

An MPiec controller is your gateway to full control of a machine at any remote location with Internet access. Keep a constant finger on the pulse of machine operation, from your own factory floor or anywhere worldwide.

WEB SERVER UPDATES

MPiec controllers allow loading of programs and updating of firmware from any web browser, with no other software required. Browser-based controller status data helps reduce maintenance time and cost.

SCALABILITY

All our single-axis to multi-axis MPiec controllers utilize the same MotionWorks IEC software platform, making programming and maintenance consistent for all machine sizes.

THREE NETWORKS TO CHOOSE FROM

MPiec controllers include the MECHATROLINK motion network, plus Modbus TCP and EtherNet/IP communication networks at no extra cost. This ensures an economical way of connecting to all the devices in your machine.

**ALL YOUR MACHINES NEED
TO FEEL AND FUNCTION IN
EXACTLY THE SAME WAY.**



SYSTEM CONFIGURATION

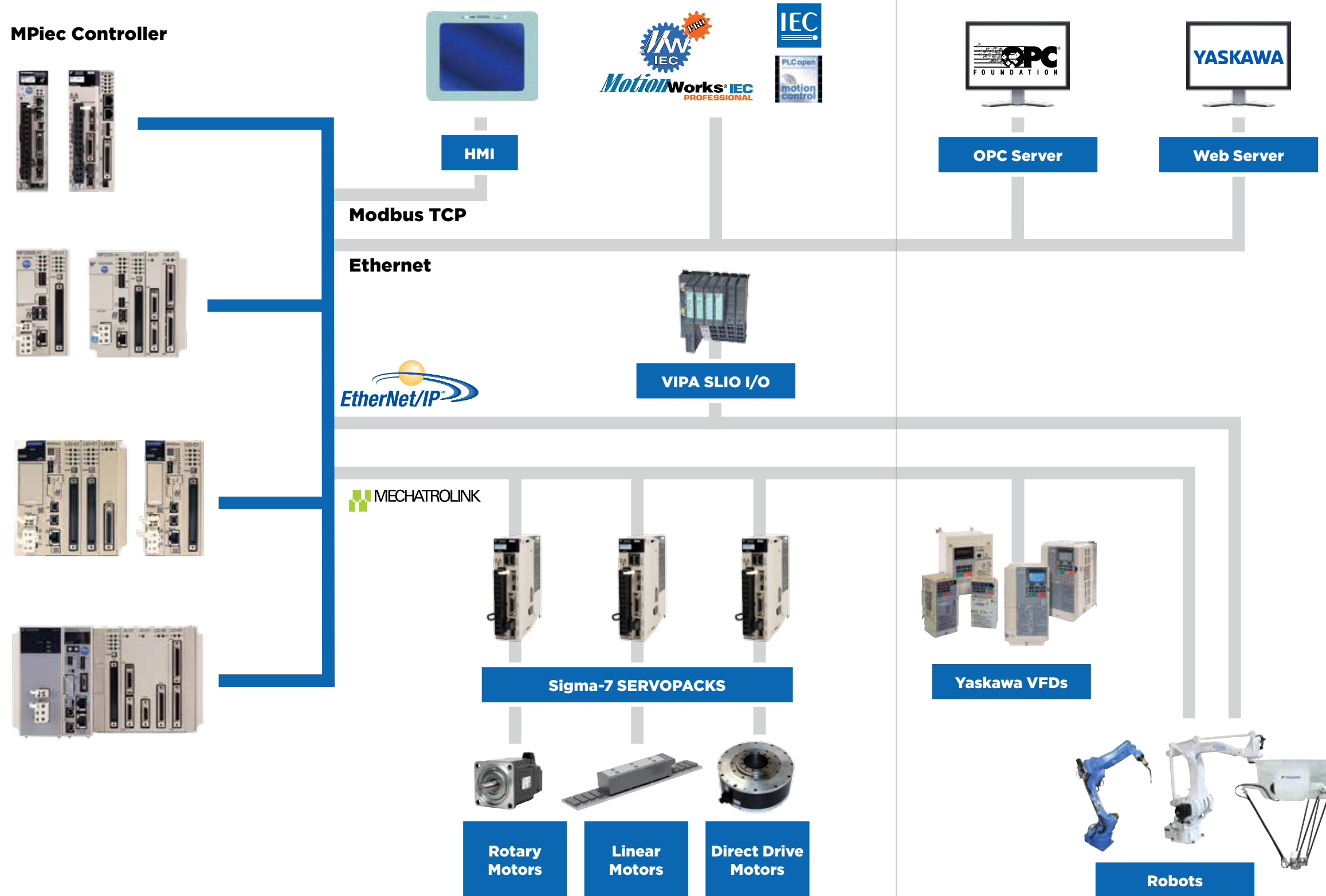

A CONTROLLER THAT GETS YOU TO THE POSITION YOU WANT, WHEN YOU WANT IT:

- Deterministic high speed MECHATROLINK network
- MECHATROLINK retry function
- Dedicated CPU for your motion needs
- High CPU scan rate

PROGRAM ALL OF YOUR CONTROLLERS THE SAME WAY EVERY TIME:

- Standard IEC 61131-3 programming languages
- Reusable PLCopen function blocks
- Reusable standard Yaskawa toolboxes
- Decades of high quality motion experience

YOUR ENTIRE MACHINE AT YOUR FINGERTIPS WITH YASKAWA CONTROLLERS:

- Sigma-7 servos via MECHATROLINK
- Built in web server
- OPC server
- EtherNet/IP
- Modbus TCP
- Wide range of HMIs and I/Os

MPIEC MACHINE CONTROLLERS SOFTWARE

SOFTWARE

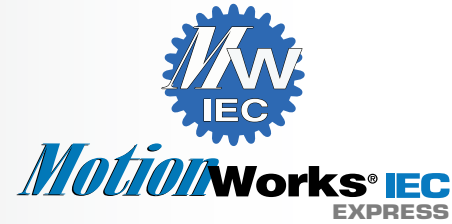

- Number of Tasks: 1
- Number of Resources: 1
- IEC 61131-3 Languages: Ladder Diagram, Function Block, Structure Text
- POU Grouping: No
- Configurable Task Priority: No
- Configurable I/O Task Assignment: No
- Auto Save Setting: No
- Debug PowerFlow: No
- Password Protection: No
- Project Comparison: No



- Number of Tasks: 16
- Number of Resources: Multiple
- IEC 61131-3 Languages: Ladder Logic, Function Block, Structured Text, Sequential Function Chart, Instruction List
- POU Grouping: Yes
- Configurable Task Priority: Yes
- Configurable I/O Task Assignment: Yes
- Auto Save Setting: Yes
- Debug PowerFlow: Yes
- Password Protection: Yes
- Project Comparison: Yes

REUSABLE CODE AND YASKAWA APPLICATION-SPECIFIC TOOLBOXES

Drawing on decades of motion experience, Yaskawa created toolboxes with pre-developed code for specific applications. Leverage Yaskawa expertise to minimize programming time and effort. Libraries also enable importing and re-use of logic you've previously developed, saving even more time on subsequent projects.

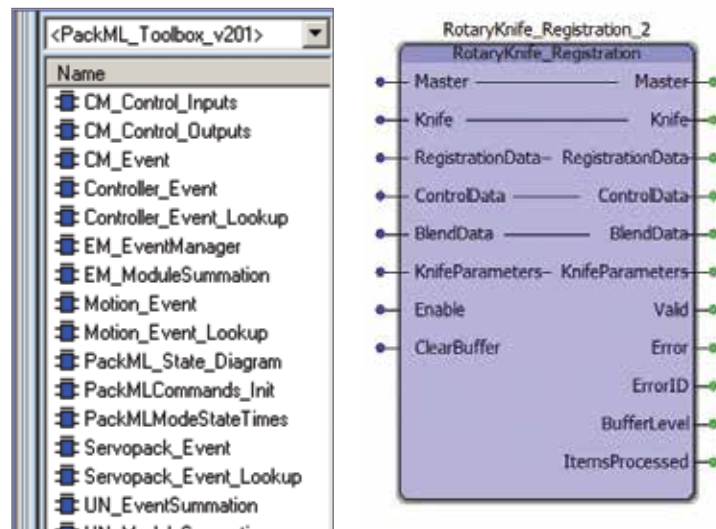

SEQUENTIAL FUNCTION CHART

Sequential Function Chart (SFC) is one of the standardized languages available in IEC 61131-3 and is supported in the Professional version of MotionWorks IEC.

SFC allows the programmer to graphically represent program elements, for easier organization of steps, actions and transitions. Active steps are indicated in red to simplify troubleshooting of complex operations.

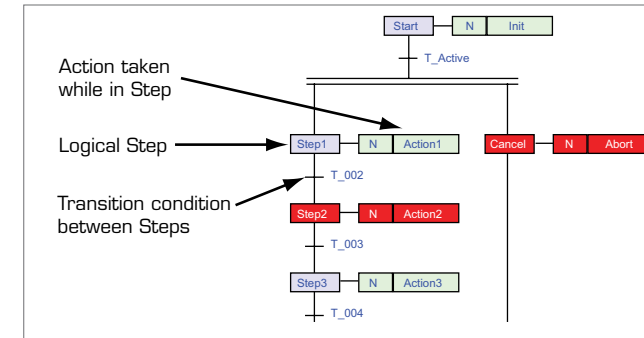

STANDARD PROGRAMMING ENVIRONMENT



MotionWorks IEC software complies to the IEC 61131-3 standard. It also has motion function blocks that adhere to the PLCopen standard, which is your assurance that programs will be developed and executed with predictable behavior.

CAM EDITOR

Let Yaskawa handle the hard work of camming applications with a Cam Editor built into MotionWorks IEC Pro. Create, edit, export and import Cam profiles, or convert Cam tables back and forth from ST code for programming use.

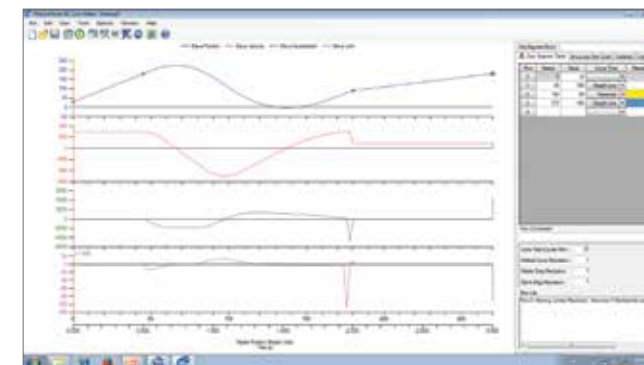

CAMMING FUNCTION BLOCKS

Electronic camming controls the positional relationship of a pair of axes based on a master/slave lookup table.

MotionWorks IEC includes 10 function blocks dedicated to camming. Yaskawa creates customizations based on the PLCopen specification, previous controller cam technology, and decades of synchronized motion experience. The function blocks fall into one of four functional topics:

CAM DATA MANAGEMENT

- CamFileSelect
- CamStructSelect
- ReleaseCam

CAM ENGAGEMENT

- CamIn
- CamOut

ON-THE-FLY ADJUSTMENTS

- CamShift
- CamScale
- SlaveOffset

CAM DATA TRANSFER

- ReadCamTable
- WriteCamTable

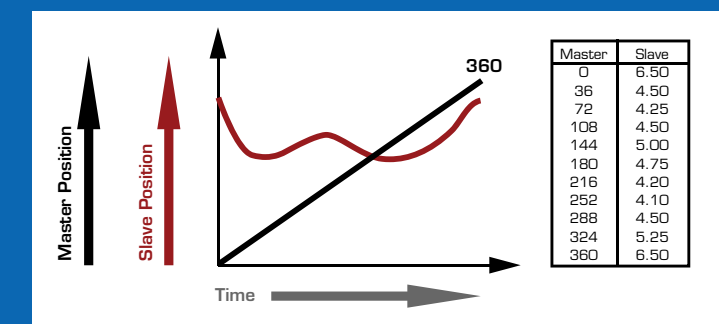
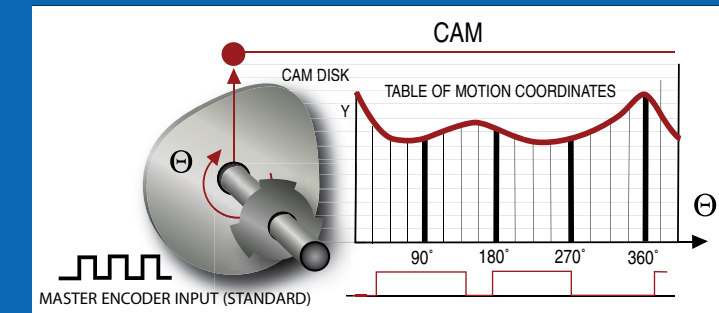

CONTROLLER HARDWARE

You need powerful processing to meet today's needs and prepare for tomorrow's innovations. At the same time, your machine control must offer outstanding ease of use and an extensive track record of automation success. MPiec machine control offers both, plus extra features that add industry-leading user flexibility.

All MPiec Machine Controllers are equipped with the MECHATROLINK motion network. MECHATROLINK combines the speed of modern motion networks with unmatched noise immunity and robust performance. The within-cycle RETRY function of MECHATROLINK responds to a communication error by automatically resending the packet within the same cycle. This creates far fewer gaps in the the flow of data, even in extremely high noise environments.

Without the RETRY function, all data for all slaves are eliminated and slaves must wait for the next cycle. The master must retransmit at a higher rate to compensate for dropped information. The result can be poor quality in machined parts, as shown in the test data at left.

MECHATROLINK

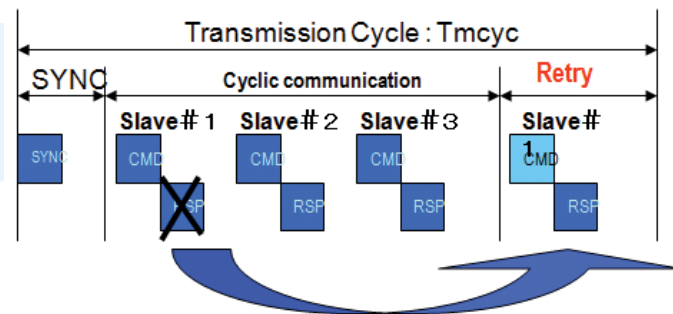
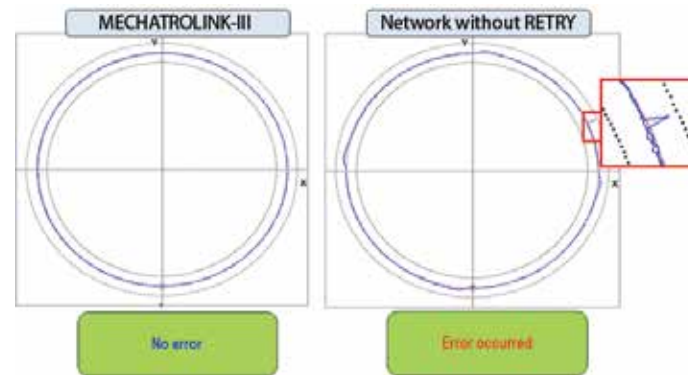

CONTROLLER-CENTRIC COMMISSIONING

The MECHATROLINK motion network provides a conduit to configure the machine from a single location with one software tool, resulting in minimal commissioning time.

REMOTE I/O

Interface with the system using Yaskawa's own MECHATROLINK I/O, VIPA SLIO I/O, or third-party remote I/O modules from Phoenix, Wago or Opto 22 via MECHATROLINK or Ethernet.

LOCAL I/O

MPiec controller hardware can be expanded to include your choice of eight option cards to accommodate most automation requirements.

IEC ON THE DRIVE

The MP2600iec Option Card, used in combination with a Yaskawa SERVOPACK amplifier, offers a compact controller/amplifier combination, providing standardized programming on Yaskawa's latest high quality servo system.

SCALABILITY

The use of one software platform for all MPiec Machine Controllers enables users to easily scale up their applications from single to multi-axis control.

PROGRAMMABLE AMPLIFIER OUTPUTS

The controller can operate local outputs on a SERVOPACK, reducing panel cost and saving panel space when only a few outputs are necessary.

WEB-BASED SYSTEM ACCESS

MPiec Machine Controllers have a built-in web interface for better system access. Plug into a local network and adjust parameters using any web browser, or log in anywhere in the world via a secure Internet connection.

- Monitor vital control status, diagnostic and alarm information
- Change settings or update firmware remotely
- Connect via cable and enjoy on-site control with your favorite browser, or access from any remote location
- Connect via Ethernet on a computer, an Android™ or Apple® tablet



CONTROLLER HARDWARE

MPIec Machine Controllers offer a wide range of hardware for applications ranging from 1 to 62 axes. All controllers are equipped with the reliable MECHATROLINK motion network.

MP2600IEC / SIGMA-7 SIEC

- SERVOPACK amplifier and motion controller in one device
- Processor Speed: 200 MHz
- Motion Network: Dual Port RAM access
- Motion Networks Speed: As fast as 1 ms
- Network Capability: OPC, EtherNet/IP, Modbus TCP
- Axis Count: 1.5 / 1



MP2300SIEC / MP2310IEC

- Processor Speed: 200 MHz
- Motion Network: MECHATROLINK-II
- Motion Networks Speed: As fast as 1 ms
- Network Capability: OPC, EtherNet/IP, Modbus TCP
- Axis Count: 4, 8 or 16
- Option Card Slots: 1 or 3

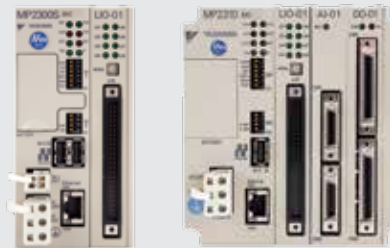

MP3300IEC

- Processor Speed: 400/800 MHz
- Motion Network: MECHATROLINK-III
- Motion Network Speed: As fast as 0.25 ms
- Network Capability: OPC, EtherNet/IP, Modbus TCP
- Axis Count: 4, 8, 20 or 32
- Option Card Slots: 1 or 3



MP3200IEC

- Processor Speed: 1 GHz
- Motion Network: MECHATROLINK-III
- Motion Networks Speed: As fast as 0.25 ms
- Network Capability: OPC, EtherNet/IP, Modbus TCP
- Axis Count: 4, 8, 16, 32 or 62
- Option Card Slots: 3, 5 or 8



SYSTEM COMPONENTS

MECHATROLINK-III Network Components			
Description	Part Number	Notes	
MP3200iec	CPU Module	PMC-U-MP320 □□	□□: Maximum number of MECHATROLINK Axes: 04:4 • 08: 8 • 16:16 • 32:32 • 62:62
	Power Supply Module	JEPMC-PS□3012-E	□: Input Power D: 24VDC • A: 100/200 VAC
	Option Module Rack	JEPMC-BUB300□-E	For optional I/O modules □: Slot number: 3:3 slots • 5: 5 Slots • 8: 8 Slots
MP3300iec	CPU Module	PMC-U-MP33#□□	#: 0: Standard CPU • 3: Medium CPU □□: Maximum number of MECHATROLINK Axes: 04:4 • 08: 8 • 20:20 • 32:32 (Note: Standard CPU up to 20 axes, Medium CPU in 20 and 32 axes only)
	Power and Option Rack	JEPMC-BU330□-E	□: Number of slots: 4: 1 slot, 3: 3 slots
MECHATROLINK-II Network Components			
Description	Part Number	Notes	
MP2300Siec	Controller	PMC-U-MP23S □□	without I/O module
		PMC-U-MP23S □□L1	with factory installed LIO-01
		PMC-U-MP23S □□L2	with factory installed LIO-02
MP2310iec	Controller	PMC-U-MP231 □□	without I/O module
Single-Axis Controller Option with SERVOPACK			
Description	Part Number	Notes	
MP2600iec	Controller/Sigma-5	SGDV□□□□E1A002000300	□□□□: denotes output capacity and voltage of Σ-5 SERVOPACK
	Controller/Sigma-7	SGD7S□□□□E0A000300	□□□□: denotes output capacity and voltage of Σ-7 SERVOPACK
Sigma-7Siec	Controller/Sigma-7	SGD7S-□□□□M0A000F50	□□□□: denotes output capacity and voltage of Σ-7 SERVOPACK
MECHATROLINK-III Network Components			
Description	Part Number	Notes	
Software	MotionWorks IEC Express	PDE-U-IE□Sx	□: Software Version: 2:2 - 3:3 x: License Type: E: Electronic
	MotionWorks IEC Pro	PDE-U-IE□Px	□: Software Version: 2:2 - 3:3 x: License Type: E: Electronic • H: Floating License
	MotionWorks IEC OPC Server	PDE-U-OPCPx	x: Licenses: A:1 • B:5 • C:10 • D: 20
Option Cards (for MP3200iec, MP3300iec, MP2300Siec, MP2310iec)	JAPMC-AN2300	Analog Inputs (AI-01)	(8) channels; +/- 10V @ 16-bit resolution @ 20kΩ or 4-20mA @ 15-bit @ 250Ω
	JAPMC-AN2310	Analog Outputs (AO-01)	(4) channels; +/- 10V @16-bit resolution; 5mA max load current
	JAPMC-DO2300	Output Module (DO-01)	(64) 24VDC sinking outputs; 100mA/output
	JAPMC-IO2300-E	I/O Module (LIO-01)	(16) 24VDC sinking or sourcing inputs; (16) 24VDC sinking outputs; 100mA/output; (1) Encoder Counter; A/B/C channels; differential; latch response time varies based on input used; max frequency 4MHz
	JAPMC-IO2301-E	I/O Module (LIO-02)	(16) 24VDC sinking or sourcing inputs; (16) 24VDC sourcing outputs; 100mA/output; (1) Encoder Counter; A/B/C channels; differential; latch response time varies based on input used; max frequency 4MHz
	JAPMC-IO2303	I/O Module (LIO-04)	(32) 24VDC sinking or sourcing inputs; (32) 24VDC sinking outputs; 100mA/output
	JAPMC-IO2304	I/O Module (LIO-05)	(32) 24VDC sinking or sourcing inputs; (32) 24VDC sourcing outputs; 100mA/output
	JAPMC-IO2305-E	Multi-Function (LIO-06) I/OO Option Module	LIO-06 - (8) 24VDC sinking or sourcing inputs; (8) 24VDC sinking outputs; 100mA/output; (1) Encoder Counter; A/B/C channels differential; (1) Analog Input -10 to +10V 16 bits; (1) Analog Output -10 to +10V 16 bits
	JAPMC-CM2301-E	Communications Option (28IF-Y1)	(1) Ethernet port 10 MBit; (1) RS232 port
	Terminal Block Conversion Kits	CBK-U-MP2A-□□	For LIO-01/02
CBK-U-MP2B-□□		For LIO-04/05/06/ MP2600iec	
SBK-U-VBA-□□		For SGD Servo Amp- CN1	

MPIEC MACHINE CONTROLLERS

VIPA SLIO I/O

If you've wished that Input/Output could be FASTER and EASIER, VIPA SLIO is for you. Yaskawa's new decentralized I/O system is full of features that make connection simpler and I/O function more efficient.

EASY WEB INTERFACE

SLIO diagnostic and status information is accessible through a web interface, delivering complete system status data from any EtherNet/IP or Modbus TCP fieldbus module into a standard browser. Remote access via Internet is also available.



HIGH SPEED BACKPLANE BUS

Achieve reaction times as fast as 20 microseconds with VIPA SLIO's high speed backplane bus. Connect as many as 64 modules at a time, while maintaining speeds up to 48 Mbit/s.



ONE-TOUCH HARDWARE CONFIGURATOR

VIPA SLIO puts an end to hours of tedious manual I/O configuration. The MotionWorks IEC VIPA SLIO Hardware Configurator sets up a complete I/O system with the touch of a single button.

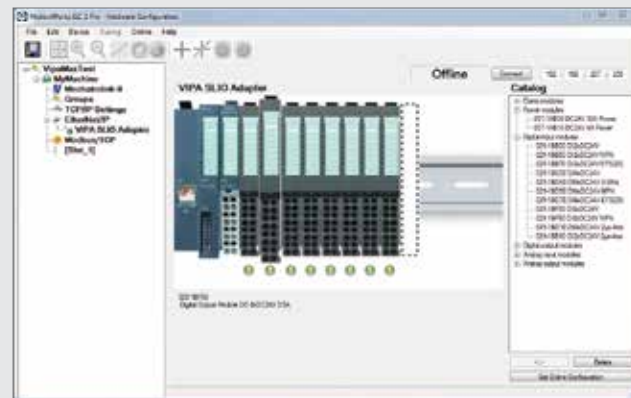

INSTALLER FRIENDLY DESIGN

Engineered for error-free installation, SLIO can be installed by an average technician without consulting a machine designer or installation engineer.

- Easy, safe assembly with no tools required
- Staircase-shaped wiring level saves space, eases connection
- Clamp terminal assignment is clearly printed on each module
- Labeling strips clearly indicate module function, replace easily after a reconfiguration



COMPACT

INTELLIGENT

FLEXIBLE

The SLIO system is designed for customers who want to modularize and standardize, yet remain flexible at the same time. SLIO can help reduce setup time and minimize user errors.

RECONFIGURE WITHOUT REWIRING

Updating or amending a SLIO system is as easy as removing an existing module and snapping in a new one. System functions can be changed without removing the wiring from the contact block.

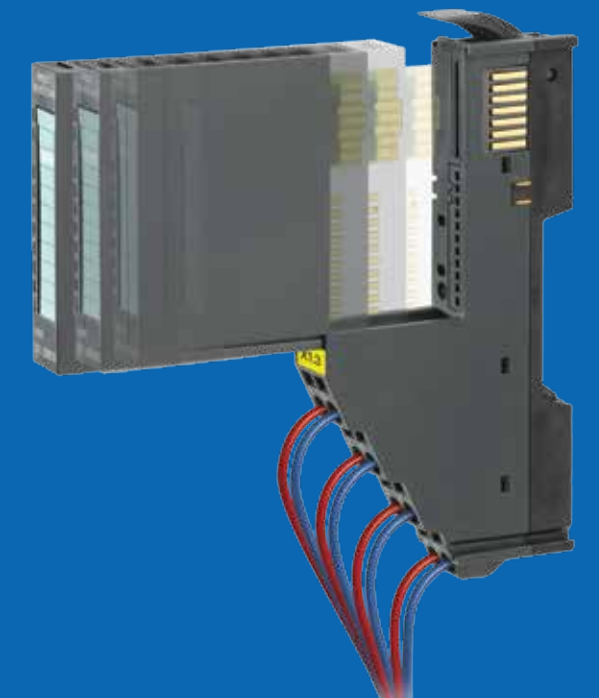

MPIEC MACHINE CONTROLLERS

VIPA SLIO I/O

MODULAR CONSTRUCTION FOR QUICK ASSEMBLY

Compact: Width 12.9 mm, height 109 mm, depth 76.5 mm

Standardized: Direct mounting on 35 mm standard profile rail

Extendable: The flexible design of SLIO makes it easy to expand as needed; add up to 64 signal and function modules per interface.

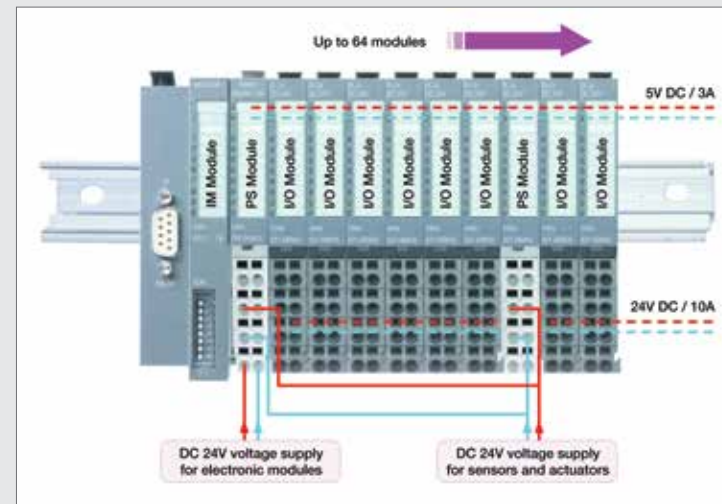

INTERCHANGEABLE FUNCTION MODULES

Choose from a selection of 120+ interchangeable signal and function modules, ready to be snapped into an existing contact block for instant reconfiguration to a new function.

- Analog and digital inputs and outputs
- Communication processor modules
- Coupler modules
- Potential distributor modules
- Power modules
- Temperature modules
- Future modules add tomorrow's functions with the same snap-in interconnection

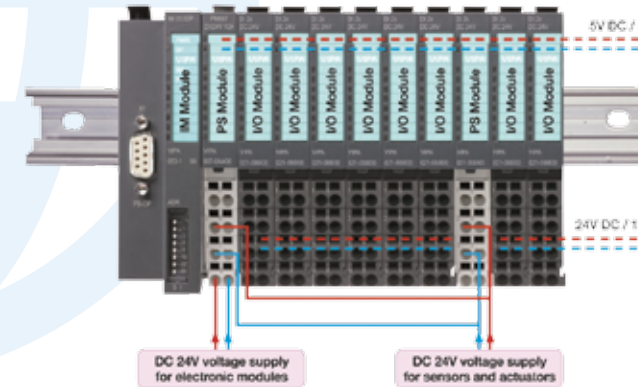
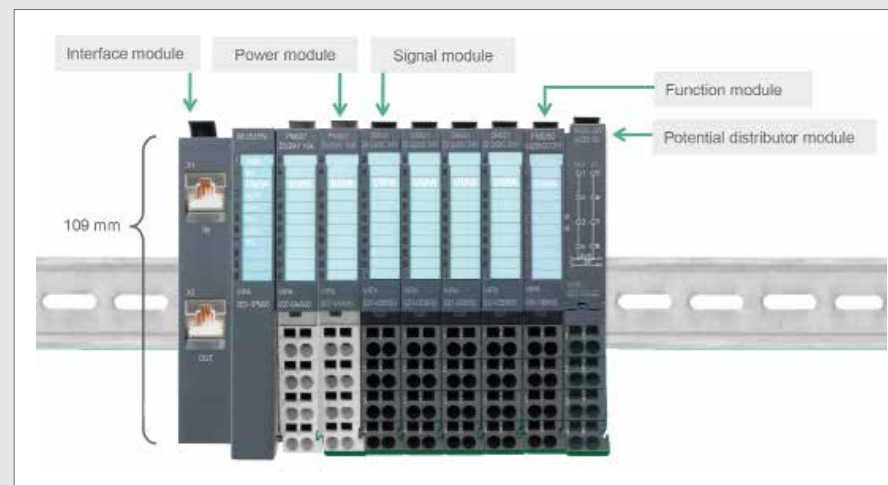

MODULES SUPPORTED BY MOTIONWORKS IEC

Fieldbus Module

EtherNet/IP, 10 A (3 A bus supply)

Power Modules

DC 24V, 10A

DC 24V, 4A (2A bus supply)

Digital Input	2X	4X	8X
DC 24V	•	•	•
DC 24V (2 us to 4 ms)	•	•	
DC 24V (3 wire)		•	
DC 24V (NPN)	•	•	•

Digital Output	2X	4X	8X
DC 24V, 0.5A	•	•	•
DC 24V, 2A	•	•	
DC 24V, 0.5A (NPN)	•	•	•
DC 24V, 0.5A (PWM)	•		
DC 30 / AC 230 V/3A (Relay)	•	•	

Analog Input	1X	2X	4X
0 to 10V, 12 Bit		•	•
0 (4) to 20mA, 12 Bit		•	•
0 (4) to 20mA (2 wire), 12 Bit		•	
+/- 10V, 12 Bit		•	•
Thermocouple, 16 Bit		•	
Ohm Resistance, 16 Bit			•
0 to 10V, 16 Bit		•	•
0 (4) to 20mA, 16 Bit		•	•
+/- 10V, 16 Bit		•	

Analog Output	1X	2X	4X
0 to 10V, 12 Bit		•	•
0 (4) to 20mA, 12 Bit		•	•
+/- 10V, 12 Bit		•	•
0 to 10V, 16 Bit		•	•
+/- 10V, 16 Bit		•	•

SIGMA SERIES SERVO SYSTEMS



READY FOR THE NEXT REVOLUTION

Your next-generation machine needs more flexibility, easier operation, greater compactness and a lower cost than ever before. To achieve it, you need tomorrow's servo systems. And you need them today.

THE FUTURE CHALLENGE

The high expectations continue long after your machine leaves the drawing board. You'll also need superior servo reliability and years of consistent performance, plus support that sustains your user through years ... possibly even decades ... of successful production.

WHAT IF ...

- Your machine could become mechanically simpler, while also becoming more flexible in the way it functions?
- You could cut the turnaround time in half to commission a new machine?
- You could build a quieter, more efficient machine that always delivers optimal performance?

SIGMA-7: MORE BUILT-IN TUNING POWER

We've packed 25 years of innovation and five generations of servo expertise into the tuning features of a Sigma Series servo system. The complete package of tuning features work together to deliver higher speed, greater precision and faster throughput than any servo on the market.

SIMPLIFY YOUR MACHINE
DESIGN WHILE IMPROVING ITS
OVERALL EFFECTIVENESS



TUNING-LESS MODE

Every Sigma Series SERVOPACK is equipped with a tuning-less function that is enabled from the moment you pull it out of the box. This function allows the amplifier to detect load inertia and automatically adjust servo gains at the update rate of the position loop (a lightning fast 62.5 microseconds). You may never need to tune a Yaskawa servo; not at installation and never again over years of precise, productive operation.

VIBRATION SUPPRESSION

Sigma series SERVOPACKs neutralize vibration, both from the motor's motion artifacts and from resonances within the machine. It detects actual vibration frequencies and cancels them out of the motion command, creating a new machine cycle that is quicker, quieter and more efficient.



*Without Vibration
Suppression*



*With Vibration
Suppression*

FIGHT FRICTION, RESONANCE, RIPPLES

Every Sigma-7 SERVOPACK is equipped with a complete set of compensation algorithms that virtually eliminate mechanical impediments which rob a servo of speed, accuracy and smoothness of movement.

- **Anti-resonance compensation** counteracts the effects of a machine's natural mechanical resonances
- **Ripple compensation** eliminates the oscillations caused by motor cogging and other motor-based vibration effects
- **Friction model compensation** automatically corrects for changes in machine operation caused by component wear and other effects of friction over time

BETTER NOISE PROTECTION

Sigma-7 is equipped with nine discrete filters to protect against electrical noise, vibration and resonance. The result is more reliable performance, faster response and greater accuracy despite long cable runs, noisy equipment and everyday variations in a machine's mechanical condition.

PACKED WITH PERFORMANCE

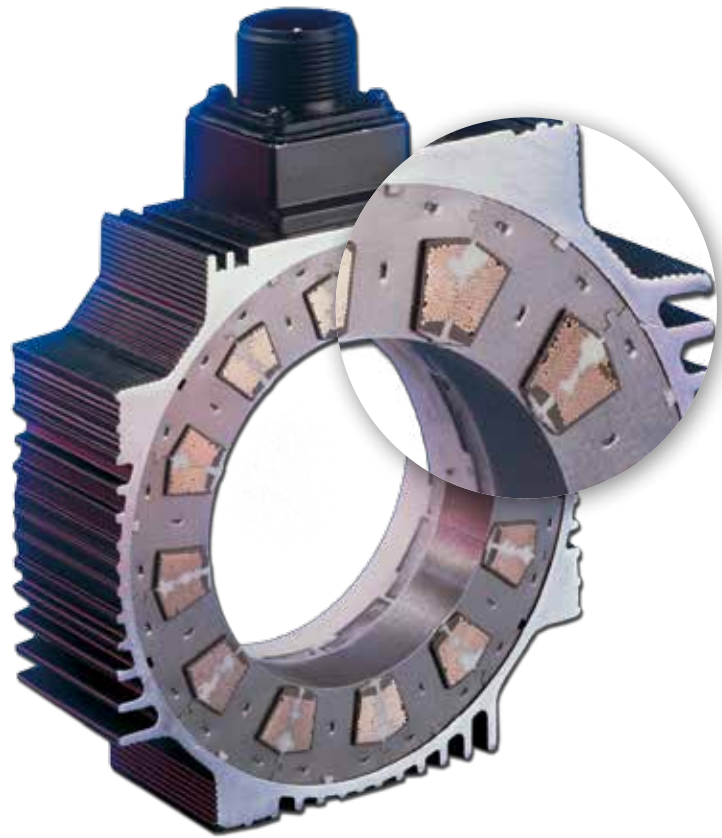

MORE TORQUE IN LESS SPACE, FOR AN EASIER FIT IN YOUR TIGHTEST APPLICATION

- Yaskawa's segmented stator core design and automated winding techniques pack nearly twice the copper into the stator gap, for much more torque output from every square millimeter of space
- Encapsulated windings prevent shorts between windings, improving heat dissipation
- Precise machining is used to minimize the air gap between rotor magnets and stator windings, for higher running torque and reduced cogging torque
- By reducing the space taken up by the end turns of the winding, overall motor length is significantly reduced
- Neodymium-Iron-Boron rotor magnets optimize flux density in the motor



ELIMINATE MECHANICAL BREAKDOWNS

Simplify your machine's design, decrease part counts and cut assembly time by replacing mechanical linkages with reliable, flexible servo control.

- Designed to accommodate up to a 30:1 inertia mismatch
- Reduce gearbox size, or eliminate gearboxes altogether
- Reduce maintenance points in machinery and improve safety

7 SIGMA ADVANTAGES

The new generation of Sigma Series servo motors offers power, precision and reliability unmatched by anything in the automation industry. Better still, new Sigma-7 motors are completely compatible with Yaskawa's industry-leading Sigma-5 products. An easy replacement can lead to an instant boost in machine productivity.

- 1. 20% more compact** in size, for an easier fit in more applications
- 2. 16x better resolution** radically improves positional accuracy
- 3. Nearly double the bandwidth** yields faster speed, more throughput
- 4. New thermal sensors** detect application problems before they affect motor life
- 5. Withstands ambient temperatures to 60°C** for trustworthy performance in extreme environments
- 6. High-altitude friendly** with full function assured at elevations of 2000 meters and above
- 7. IP67 rated** for total protection against dust and the effects of water immersion to a depth of 1 m



PLUS: MATCHED GEARMOTORS

Every Sigma-7 rotary servo motor can be equipped with a companion gearmotor, custom-designed for peak performance in low speed, high torque applications.

- Available for all Sigma-7 rotary servo motors
- Five different ratios, six gearhead sizes
- Factory tested for guaranteed performance



DIRECT DRIVE SERVO MOTORS

REDUCE DOWNTIME

By eliminating gear reduction and creating a direct coupling to the machine load, direct drive motors simplify your machine's design. Eliminating couplings and other components in the machine's mechanical transmission will ultimately lead to fewer breakdowns and long-term reliability you can trust.

INCREASE PERFORMANCE

Direct drive motors eliminate the inefficiencies that develop as mechanical transmission components wear over time. Say goodbye to mechanical backlash as well. As compliance is reduced, the responsiveness of the servo system can be dramatically improved.

REDUCE SIZE AND COST

Directly coupling a compact direct drive servo motor to your machine load will save physical space, which can lead to a more space-efficient machine. When precision gearheads and other mechanical transmission components are gone, the cost of your machine will go down as well.

BOOST THE QUALITY OF YOUR DESIGN

Implementing direct drive motor technology leads to a host of improvements in the quality of your machine designs.

- Machines with direct drive motors typically emit less audible noise
- Eliminating mechanical transmissions reduces the need for preventive maintenance
- Overall efficiency and performance can be significantly increased, leading to a lower long term cost



TYPICAL APPLICATIONS

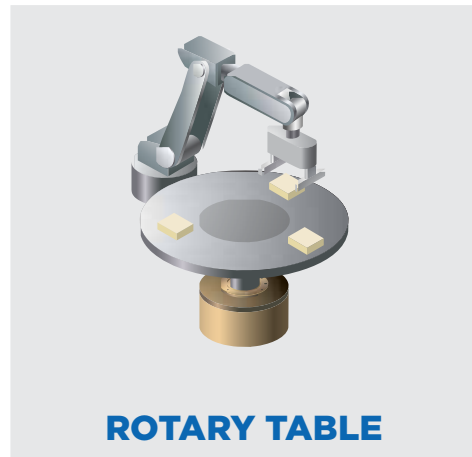

ROTARY TABLE

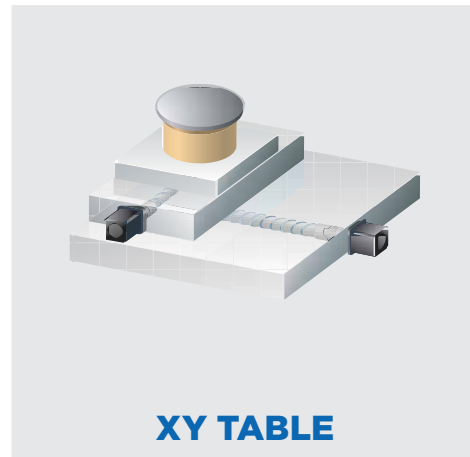

XY TABLE



SEMICONDUCTOR HANDLING ROBOT

LINEAR SERVO MOTORS



A COMPLETE LINE OF LINEAR SOLUTIONS

Yaskawa linear servo motors replace the backlash, friction, inertia and wear of mechanical linkages with smooth, precise, high performance linear motion in a compact footprint. Any product in the Yaskawa linear servo family offers plug-and-play connection with Sigma-7 and Sigma-5 series SERVOPACK amplifiers, using automatic motor recognition and serial encoder technology to make implementation trouble free.

YASKAWA OFFERS A FULL RANGE OF LINEAR SERVO PRODUCTS THAT ARE DESIGNED TO HANDLE THE MOST DEMANDING APPLICATIONS



SGLG CORELESS

Achieve smooth linear motion with an ironless design that eliminates motor cogging.

- 200V windings
- 40 to 3000 N of peak force
- Standard and high force magnetic ways
- Zero cogging for minimal force ripple

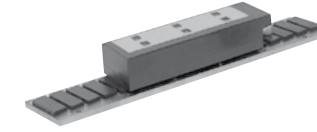

SGLF IRON CORE

A time-tested iron core design that delivers consistent reliability in a wide range of sizes and outputs.

- 200 or 400V windings
- 86 to 2400 N of peak force
- 5 m/s peak speed

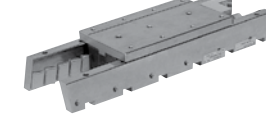

SGLT DUAL MAGNET IRON CORE

An iron core design featuring dual magnets, producing high output in a compact footprint.

- 200V or 400V windings
- 380 to 7500 N of peak force
- 5 m/s peak speed
- Very little cogging



SGT SIGMA TRAC

A ready-to-implement solution, including every element needed for plug-and-play linear motion.

- Factory assembled, integrated stage
- 200 or 400V windings
- Stroke lengths from 80 mm to 2 m
- 220 to 1200 N of peak force
- Sub-micron repeatability

NEED FOR SPEED?

If your application requires linear speeds and accelerations that go beyond the capabilities of traditional mechanisms, take a look at Yaskawa linear motors.

MORE PERFORMANCE

Direct coupling to the machine load eliminates mechanical linkages, significantly improving responsiveness and reliability.

ENGINEERED SOLUTIONS

The Sigma Trac linear motor stage reduces machine design complexity and commissioning time.

SIGMA SERIES SERVOPACKS



A "SMARTER" AMPLIFIER FOR EXTRA PRODUCTIVITY

Every Yaskawa servo motor has a companion SERVOPACK amplifier, with built-in control software that simplifies setup, fine tunes performance and boosts automation efficiency.

THE YASKAWA TUNING SUITE

Successfully commissioning and operating a servo axis requires more than a simple tuning algorithm. Yaskawa equips each SERVOPACK with a suite of software commissioning and tuning tools, aimed at achieving full functioning right out of the box, then continuing this superior performance in spite of all the vibration, resonance, friction and noise that a modern automated machine can dish out.

TUNING-LESS FUNCTION

GET UP AND RUNNING QUICKLY

Right out of the box, the tuning-less function automatically compensates for mismatches in load to rotor inertia up to 30:1.

Settling time:
40 ms
range

ADVANCED AUTOTUNING

MINIMIZE SETTTLING TIME MAXIMIZE SMOOTH MOTION

Advanced auto tuning automatically adjusts nearly 20 gain and filter parameters to cancel vibration, rippling, friction and resonance.

Settling time:
4 ms
range

ONE PARAMETER TUNING

PRECISE USER-DRIVEN ADJUSTMENT

Improve your machine's performance even further with easy fine tuning adjustments that won't throw off your existing operating parameters.

Settling time:
0 to 4 ms
range

SERVOPACKS WITH
FEATURES THAT
AMP UP PRODUCTIVITY



GET RID OF PERFORMANCE-ROBBING MECHANICAL EFFECTS

Automated motion naturally creates unwanted mechanical effects that rob a servo system of the quick, smooth and precise movement users demand. Yaskawa SERVOPACKs are equipped with a set of suppression features that automatically eliminate harmful artifacts.

VIBRATION

Machine vibrations are eliminated by Yaskawa Vibration Suppression, which samples the equipment's natural oscillations and creates compensating frequencies to cancel them out.

COGGING

Motor cogging effects are addressed by Ripple Compensation, an especially important effect for systems that require minimum settling time and exceptionally precise positioning.

RESONANCE

Sigma-7 amplifiers have twice as many anti-resonance filters to more effectively repress a servo system's natural medium-frequency resonances.

FRICTION

Coulomb friction and viscosity-related variables are effectively compensated for by Friction Model Compensation, which is especially effective in eliciting smooth start-up action in low speed or high rigidity machines.

ELECTROMAGNETIC INTERFERENCE

The number of interference filters has been increased by 225% to counteract the losses caused by data dropouts, EMI interference and artifacts caused by long cable runs.

VIBRATION

Machine vibrations are eliminated by Yaskawa Vibration Suppression, which samples the equipment's natural oscillations and creates compensating frequencies to cancel them out.

FEATURE-PACKED FOR YOUR MACHINE

A CHOICE OF OPEN PROTOCOL, HIGH SPEED DETERMINISTIC DIGITAL NETWORKS



- Used with Yaskawa's full line of IEC61131-3 Motion Controllers
- Superior immunity to noise in challenging industrial environments
- Retry function minimizes data drop-outs

OR



- Adheres to CoE device profile (CiA402)
- Distributed clock for synchronized operation
- Variety of system architectures (cascade, line, star, ring)

FUNCTIONAL SAFETY

A Safe Torque Off (STO) circuit is standard equipment in every SERVOPACK. Safety functions SS1 (Safe Stop 1), SS2 (Safe Stop 2), and SLS (Safe Limited Speed) are integrated with selection of an optional safety module

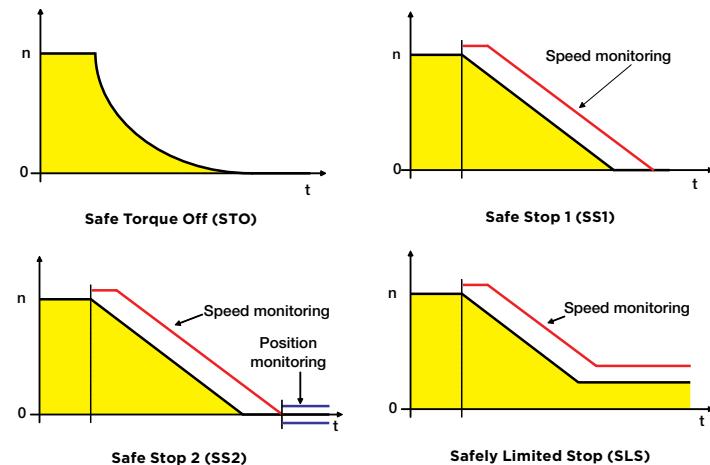

PRIMARY FEEDBACK OPTION

- 20 Bit serial absolute encoder
- Motor data stored in the encoder
- Simplified cable design

SECONDARY FEEDBACK OPTION (FULL CLOSED LOOP CONTROL)

- Allows user to close position loop around secondary feedback device near the load
- Helps eliminate the effects of mechanical compliance and thermal variances
- Delivers more precise control and improved machine performance

SGD7S SINGLE AXIS AMPLIFIER

- 200V operation
- 50W-15kW operating range
- Control interface options: EtherCAT, MECHATROLINK, analog

SGDV SINGLE AXIS AMPLIFIER

- 400V operation
- 500W-55kW operating range
- Control interface options: EtherCAT, MECHATROLINK, analog

SGD7W DUAL AXIS AMPLIFIER

- Control two servo axes with one amplifier
- Lower cost, component count
- Conserves cabinet space
- Regenerative power feature conserves energy

SIGNALOGIC™ WITH ETHERNET/IP

- Add On Instructions (AOIs) for use with Rockwell PLCs
- Dual EtherNet/IP ports onboard
- Perform automation functions without learning new software
- Basic point to point moves, blended speed moves, homing, jogging, electronic gearing

SIGNALOGIC™ 7 COMPACT

- Responds to Rockwell PLC Add On Instructions
- Compact size to save cabinet space
- Internal switch for daisy chaining
- One I/O point, no option card required, keeping component cost to a minimum

MP2600IEC / SIGMA-7 SIEC SINGLE AXIS CONTROLLERS

- Motion Controller and amplifier in one device
- IEC61131-3 compatibility for predictable behavior
- MotionWorks® IEC software provides scalability between single and multi-axis control
- EtherNet/IP, Modbus TCP connectivity links to most PLCs and HMIs
- Sigma-7 SIEC: smaller footprint, fewer i/o points and no external encoder input to save cabinet space and minimize cost



WIDE RANGE

A power range from 10W to 55kW, with 100-480VAC operation.

SCALEABLE AS NEEDS CHANGE

Switching from a single axis controller to a multi axis model is easier, thanks to the fact that programming from a single axis SERVOPACK can be used in any Yaskawa multi-axis controller without revision.

SIMPLE COMMISSIONING

An automatic motor recognition function uses data resident within Yaskawa servo motors to configure a SERVOPACK for safe and effective operation.



SIGMA-7

STANDARD ROTARY

The world's largest manufacturer of servo motors brings 25 years of design innovation into each Sigma-7 rotary servo. Choose from a wide range of sizes, speeds and torque ratings, then add an amplifier and an MPiEC controller to create a complete motion automation system.

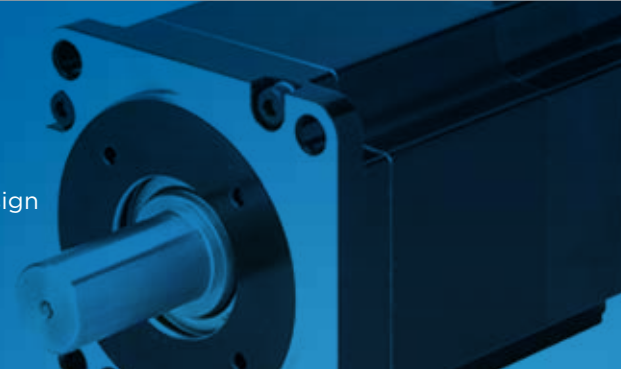

SIGMA-7

DIRECT DRIVE ROTARY

Direct drive products save space, eliminate backlash and cut component costs, adding extra mechanical strength to stiffen dynamic applications.

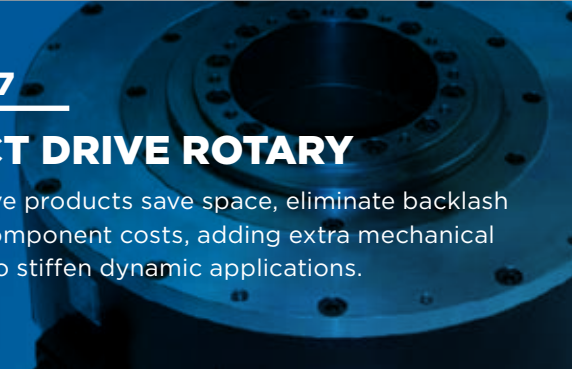

SIGMA-7

DIRECT DRIVE LINEAR

Maximum speed and acceleration for linear motion. Choose from four designs to reduce compliance, replace mechanical linkages and create a better fit for your application.



100/200V

400V

200V

200V

LOW INERTIA ▼

MEDIUM INERTIA ▼

LOW INERTIA ▼

MEDIUM INERTIA ▼



SGMMV 3W-30W



SGM7P 100W-1.5kW



SGM7A 200W-1kW



SGM7J 200W-1.5kW



SGM7A 50W-7kW



SGM7J 50W-750W



SGMSV 1kW-7kW



SGMGV 300W-15kW



SGM7G 300W-15kW



SGMVV 22kW-55kW



GEAR MOTORS
Available custom-fit for any rotary servo motor



SGM7F
(Iron Core)
4.0-25 Nm
rated torque,
600 rpm
max speed



SGMCS
(Coreless)
2.0-200 Nm
rated torque,
500 rpm
max speed



SGLG
(Coreless)
40-3000 N
peak force,
5 m/s
max speed

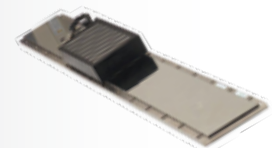

SGLF
(Iron Core)
86-2400 N
peak force,
5 m/s
max speed



SGLT
(DoubleTrac)
380-7500 N
peak force,
5 m/s
max speed



Sigma Trac
Assembly
220-1200 N
peak force,
5 m/s
max speed

400V OPTIONS ALSO AVAILABLE

SERVOPACKS

SERVOPACKS

SERVOPACKS

1 AXIS ▼

2 AXES ▼

1 AXIS ▼

1 AXIS ▼

2 AXES ▼



SGD7S 50W-15kW



SGD7W 200W-1kW/axis



SGDV 500W-55kW



SGD7S 50W-15kW





SGD7W 200W-1kW/axis

Control Interface Options: EtherCAT, MECHATROLINK, Analog
100 V SERVOPACKS available from 50-400W

Control Interface Options: EtherCAT, MECHATROLINK, Analog

› **SMALL CAPACITY MODEL SPECIFICATIONS**

Rotary Servo Motor Model	Rated Power	Rated Torque	Peak Torque	Rated Speed	Max Speed	Rotary Inertia	SGDV- □□□□	SGD7S- □□□□	SGDV- □□□□	SGD7S- □□□□	SGD7W- □□□□	SGDV- □□□□	
		Nm	Nm	rpm	rpm	x10 ⁻⁴ kg·cm ²	24/48VDC	100VAC	200VAC	200VAC	200VAC	400VAC	
 SGMMV Low Inertia Ultra-Small Capacity	SGMMV-B3E	3.3W	0.0105	0.0263	3000	6000	0.000441	1R7E					
	SGMMV-B5E	5.5W	0.0175	0.0438	3000	6000	0.000796	1R7E	N/A		N/A		
	SGMMV-B9E	11W	0.0350	0.0875	3000	6000	0.002210	1R7E		N/A			
	SGMMV-A1A	10W	0.0318	0.0955	3000	6000	0.000272	2R9E	R90F		1R6A, 2R8A	N/A	
	SGMMV-A2A	20W	0.0637	0.1910	3000	6000	0.000466	2R9E	R90F		1R6A, 2R8A		
SGMMV-A3A	30W	0.0955	0.2860	3000	6000	0.000668	2R9E	2R1F		1R6A	1R6A, 2R8A		
 SGM7A Low Inertia Small Capacity	SGM7A-A5A	50W	0.159	.557	3000	6000	0.0217		R70F		R70A	1R6A, 2R8A	
	SGM7A-01A	100W	0.318	1.11	3000	6000	0.0337		R90F		R90A	1R6A, 2R8A	N/A
	SGM7A-C2A	150W	0.477	1.67	3000	6000	0.0458		2R1F		1R6A	1R6A, 2R8A	
	SGM7A-02□	200W	0.637	2.23	3000	6000	0.139	N/A	2R1F	N/A	1R6A	1R6A, 2R8A	1R9D
	SGM7A-04□	400W	1.27	4.46	3000	6000	0.216		2R8F		2R8A	1R6A, 2R8A, 7R6A	1R9D
	SGM7A-06A	550W	1.75	6.69	3000	6000	0.315			N/A	5R5A	5R5A, 7R6A	N/A
	SGM7A-08□	600W	1.91	8.36	3000	6000	0.775			N/A	5R5A	5R5A, 7R6A	3R5D
SGM7A-10□	1.0kW	3.18	11.1	3000	6000	0.971				120A	N/A	3R5D	
 SGM7J Medium Inertia Small Capacity	SGM7J-A5A	50W	0.159	0.557	3000	6000	0.0395		R70F		R70A	1R6A, 2R8A	
	SGM7J-01A	100W	0.318	1.11	3000	6000	0.0659		R90F		R90A	1R6A, 2R8A	N/A
	SGM7J-C2A	150W	0.477	1.67	3000	6000	0.0915		2R1F		1R6A	1R6A, 2R8A	
	SGM7J-02□	200W	0.637	2.23	3000	6000	0.263	N/A	2R1F	N/A	1R6A	1R6A, 2R8A	1R9D
	SGM7J-04□	400W	1.27	4.46	3000	6000	0.486		2R8F		2R8A	1R6A, 2R8A, 7R6A	1R9D
	SGM7J-06A	550W	1.91	6.69	3000	6000	0.800			N/A	5R5A	5R5A, 7R6A	N/A
	SGM7J-08□	750W	2.39	8.36	3000	6000	1.59			N/A	5R5A	5R5A, 7R6A	3R5D
SGM7J-15D	1.5kW	4.77	14.30	3000	6000	4.02				N/A	N/A	5R4D	
 SGM7P Medium Inertia Small Capacity	SGM7P-01A	100W	0.318	0.955	3000	6000	0.0592		R90F		R90A	1R6A, 2R8A	
	SGM7P-02A	200W	0.637	1.91	3000	6000	0.263		2R8F		2R8A	2R8A, 5R5A, 7R6A	
	SGM7P-04A	400W	1.270	3.82	3000	6000	0.409	N/A	2R8F	N/A	2R8A	2R8A, 5R5A, 7R6A	N/A
	SGM7P-08A	750W	2.39	7.16	3000	6000	2.10			N/A	5R5A	5R5A, 7R6A	
	SGM7P-15A	1.5kW	4.77	14.3	3000	6000	4.02				120A	N/A	

› **MEDIUM/LARGE CAPACITY MODEL SPECIFICATIONS**

Rotary Servo Motor Model	Rated Power	Rated Torque	Peak Torque	Rated Speed	Max Speed	Rotary Inertia	SGDV- □□□□	SGD7S- □□□□	SGDV- □□□□	SGD7S- □□□□	SGD7S- □□□□	SGDV- □□□□
		Nm	Nm	rpm	rpm	x10 ⁻⁴ kg·cm ²	24/48 VDC	100 VAC	200 VAC	200 VAC	200 VAC	400 VAC
 SGM7A Low Inertia Medium Capacity	SGM7A-15A	1.5kW	4.90	14.7	3000	6000	2.00				120A	
	SGM7A-20A	2.0kW	6.36	19.1	3000	6000	2.47				180A	
	SGM7A-25A	2.5kW	7.96	23.9	3000	6000	3.19				200A	
	SGM7A-30A	3.0kW	9.80	29.4	3000	6000	7.00	N/A	N/A	N/A	200A	N/A
	SGM7A-40A	4.0kW	12.6	37.8	3000	6000	9.60				330A	
	SGM7A-50A	5.0kW	15.8	47.6	3000	6000	12.3				330A	
	SGM7A-70A	7.0kW	22.3	54.0	3000	6000	12.3				550A	

› **MEDIUM/LARGE CAPACITY MODEL SPECIFICATIONS**

Rotary Servo Motor Model	Rated Power	Rated Torque	Peak Torque	Rated Speed	Max Speed	Rotary Inertia	SGDV- □□□□	SGD7S- □□□□	SGDV- □□□□	SGD7S- □□□□	SGD7S- □□□□	SGDV- □□□□	
		Nm	Nm	rpm	rpm	x10 ⁻⁴ kg·cm ²	24/48VDC	100VAC	200VAC	200VAC	200VAC	400VAC	
 SGMSV Low Inertia Medium Capacity	SGMSV-15D	1.5kW	4.90	14.7	3000	5000	2.00					5R4D	
	SGMSV-20D	2.0kW	6.36	19.1	3000	5000	2.47					8R4D	
	SGMSV-25D	2.5kW	7.96	23.9	3000	5000	3.19					120D	
	SGMSV-30D	3.0kW	9.80	29.4	3000	5000	7.00	N/A	N/A	N/A	N/A	120D	
	SGMSV-40D	4.0kW	12.6	37.8	3000	5000	9.60					170D	
	SGMSV-50D	5.0kW	15.8	47.6	3000	5000	12.3					170D	
	SGMSV-70D	7.0kW	22.3	54.0	3000	5000	12.3					N/A	
 SGMGV Medium Inertia Medium Capacity	SGMGV-03A	300W	1.96	5.88	1500	3000	2.48				3R8A	5R5A, 7R6A	
	SGMGV-05A	450W	2.86	8.92	1500	3000	3.33				3R8A	5R5A, 7R6A	
	SGMGV-09A	850W	5.39	13.8	1500	3000	13.9				7R6A	7R6A	
	SGMGV-13A	1.3kW	8.34	14.2	1500	3000	19.9				120A	N/A	
	SGMGV-20A	1.8kW	11.5	28.7	1500	3000	26.0				180A		
	SGMGV-30A	2.9kW	18.6	54.0	1500	3000	46.0	N/A	N/A	N/A	330A		
	SGMGV-44A	4.4kW	28.4	71.6	1500	3000	67.5				330A		
	SGMGV-55A	5.5kW	35.0	102.0	1500	3000	89.0				470A		
	SGMGV-75A	7.5kW	48.0	119	1500	3000	125				550A		
	SGMGV-1AA	11kW	70.0	175	1500	2000	242				590A	2600	
	SGMGV-1EA	15kW	95.4	224	1500	2000	303				780A		
	SGMGV-03D	300W	1.96	5.88	1500	3000	2.48						1R9D
SGMGV-05D	450W	2.86	8.92	1500	3000	3.33					1R9D		
SGMGV-09D	850W	5.39	13.8	1500	3000	13.9					3R5D		
SGMGV-13D	1.3kW	8.34	23.3	1500	3000	19.9					5R4D		
 SGMGV Medium Inertia Medium Capacity	SGMGV-20D	1.8kW	11.5	28.7	1500	3000	26.0					8R4D	
	SGMGV-30D	2.9kW	18.6	45.1	1500	3000	46.0	N/A	N/A	N/A	N/A	120D	
	SGMGV-44D	4.4kW	28.4	71.1	1500	3000	67.5					170D	
	SGMGV-55D	5.5kW	35.0	87.6	1500	3000	89.0					210D	
	SGMGV-75D	7.5kW	48.0	119	1500	3000	125					260D	
	SGMGV-1AD	11kW	70.0	175	1500	2000	242					280D	
	SGMGV-1ED	15kW	95.4	224	1500	2000	303					370D	
	SGM7V-2BA□□	22kW	140	350	1500	2000	366						121H
	SGM7V-3ZA□□	30kW	191	478	1500	2000	498						161H
	SGM7V-3GA□□	37kW	236	589	1500	2000	595						201H
	SGM7V-2BA□□	22kW	262	526	800	1300	705						121H
	SGM7V-3ZA□□	30kW	358	752	800	1300	1290						161H
SGM7V-3GA□□	37kW	442	930	800	1300	1564						201H	
 SGM7V Medium Inertia Large Capacity	SGM7V-2BD□□	22kW	140	350	1500	2000	366						750J
	SGM7V-3ZD□□	30kW	191	478	1500	2000	498	N/A	N/A				750J
	SGM7V-3GD□□	37kW	236	589	1500	2000	595						101J
	SGM7V-4ED□□	45kW	286	715	1500	2000	1071						131J
	SGM7V-5ED□□	55kW	350	875	1500	2000	1290						131J
	SGM7V-2BD□□	22kW	262	526	800	1300	705						750J
	SGM7V-3ZD□□	30kW	358	752	800	1300	1290						750J
	SGM7V-3GD□□	37kW	442	930	800	1300	1564						101J
	SGM7V-4ED□□	45kW	537	1182	800	1300	1804						131J

› DIRECT DRIVE ROTARY SERVO SPECIFICATIONS

Rotary Servo Motor Model	Rated Power	Rated Torque	Peak Torque	Rated Speed	Max Speed	Rotary Inertia	SERVOPACK Model: SGD7-0000		
		Nm	Nm	rpm	rpm	kg-cm ²	100VAC	200VAC	
 SGMCS Small Capacity	SGMCS-02B	42W	2.0	6.0	200	500	28.0	2R1F	2R8A
	SGMCS-05B	105W	5.0	15.0	200	500	51.0	2R1F	2R8A
	SGMCS-07B	147W	7.0	21.0	200	500	77.0	2R1F	2R8A
	SGMCS-04C	84W	4.0	12.0	200	500	77.0	2R8F	2R8A
	SGMCS-10C	209W	10.0	30.0	200	400	140	2R8F	2R8A
	SGMCS-14C	293W	14.0	42.0	200	300	220	2R8F	2R8A
	SGMCS-08D	168W	8.0	24.0	200	500	285	2R8F	2R8A
	SGMCS-17D	356W	17.0	51.0	200	350	510	2R8F	2R8A
	SGMCS-25D	393W	25.0	75.0	150	250	750	2R8F	2R8A
	SGMCS-16E	335W	16.0	48.0	200	500	930	2R8F	5R5A
	SGMCS-35E	550W	35.0	105	150	250	1430	2R8F	5R5A
 SGMCS Medium Capacity	SGMCS-45M	707W	45.0	135	150	300	388	N/A	7R6A
	SGMCS-80M	1.26kW	80.0	240	150	300	627		120A
	SGMCS-80N	1.26kW	80.0	240	150	300	1360		120A
	SGMCS-1AM	1.73kW	110	330	150	300	865		180A
	SGMCS-1EN	2.36kW	150	450	150	250	2470		200A
	SGMCS-2ZN	3.14kW	200	600	150	250	3060		200A
 SGM7F Small Capacity	SGM7F-02A	63W	2.0	6.0	300	600	8.04	N/A	2R8A,2R1F
	SGM7F-05A	157W	5.0	15.0	300	600	14.5		2R8A,2R1F
	SGM7F-07A	220W	7.0	21.0	300	600	19.3		2R8A,2R8F
	SGM7F-04B	126W	4.0	12.0	300	600	16.2		2R8A,2R8F
	SGM7F-10B	314W	10.0	30.0	300	600	25.2		2R8A,2R8F
	SGM7F-14B	440W	14.0	42.0	300	600	36.9		5R5A
	SGM7F-08C	251W	8.0	24.0	300	600	56.5		2R8A,2R8F
	SGM7F-17C	534W	17.0	51.0	300	600	78.5		5R5A
	SGM7F-25C	785W	25.0	75.0	300	500	111		7R6A
	SGM7F-16D	503W	16.0	48.0	300	600	178		5R5A
	SGM7F-35D	1100/1000W	35.0	105.0	300/270	400	276		7R6A,120A



› LINEAR SERVO SPECIFICATIONS

Linear Servo Motor Coil Model	Rated Force	Peak Force	Rated Speed	Peak Speed	Moving Coil Mass	SERVOPACK Model: SGD7-0000					
	N	N	m/s	m/s	kg	100VAC	200VAC	400VAC			
 SGLGW Coreless Type with Standard Magneticway	SGLGW-30A050CP	12.5	40	1.5	5	0.10	R70F	R70A	N/A		
	SGLGW-30A080CP	25	80	1.5	5	0.15	R90F	R90A			
	SGLGW-40A140CP	47	140	2.0	5	0.34	R90F	R90A			
	SGLGW-40A253CP	93	280	2.0	5	0.60	2R1F	1R6A			
	SGLGW-40A365CP	140	420	2.0	5	0.87	2R8F	2R8A			
	SGLGW-60A140CP	70	220	2.3	4.8	0.42	2R1F	1R6A			
	SGLGW-60A253CP	140	440	2.3	4.8	0.76	2R8F	2R8A			
	SGLGW-60A365CP	210	660	2.3	4.8	1.1	N/A	5R5A			
	SGLGW-90A200CP	325	1300	1.8	4	2.2		120A			
	SGLGW-90A370CP	550	2200	1.5	4	3.6		180A			
	SGLGW-90A535CP	750	3000	1.5	4	4.9		200A			
 SGLGW Coreless Type with High-Force Magneticway	SGLGW-40A140CP	57	230	1.0	4.2	0.34	2R1F	1R6A	N/A		
	SGLGW-60A140CP	85	360	1.0	4.2	4.2	2R1F	1R6A			
	SGLGW-40A253CP	114	460	1.0	4.2	0.60	2R8F	2R8A			
	SGLGW-40A365CP	171	690	1.0	4.2	0.87	N/A	3R8A			
	SGLGW-60A253CP	170	720	1.0	4.2	0.76		3R8A			
	SGLGW-60A365CP	255	1080	1.0	4.2	1.1	7R6A				
 SGLFW Iron Core Type	SGLFW-200090AP	25	86	5.0	5.0	0.70	2R1F	1R6A	N/A		
	SGLFW-200120AP	40	125	3.5	5.0	0.90	2R1F	1R6A			
	SGLFW-350120AP	80	220	2.5	5.0	1.3	2R1F	1R6A	1R9D		
	SGLFW-350230AP	160	440	3.0	5.0	2.3	N/A	3R8A	1R9D		
	SGLFW-500200BP	280	600	1.5	5.0	3.5		5R5A	3R5D		
	SGLFW-500380BP	560	1200	1.5	5.0	6.9		120A	5R4D		
	SGLFW-1Z0200BP	560	1200	1.5	4.9	6.4		120A	5R4D		
	SGLFW-1Z0380BP	1120	2400	1.5	4.9	12	200A	120D			
 SGLTW Dual Magnet Iron Core Type	SGLTW-20A170AP	130	380	3.0	5.0	2.5	N/A	3R8A	N/A		
	SGLTW-35A170AP	220	660	2.5	5.0	3.7		5R5A			
	SGLTW-350170HP	300	600	2.5	4.8	4.9		5R5A	3R5D		
	SGLTW-500170HP	450	900	2.0	3.2	6.0		5R5A	3R5D		
	SGLTW-20A320AP	250	760	3.0	5.0	4.6		7R6A	N/A		
	SGLTW-20A460AP	380	1140	3.0	5.0	6.7		120A			
	SGLTW-35A320AP	440	1320	2.5	5.0	6.8		120A	8R4D		
	SGLTW-350320HP	600	1200	2.0	4.8	8.8		120A	8R4D		
	SGLTW-500320HP	900	1800	2.0	3.1	11.0		180A	N/A		
	SGLTW-35A460AP	670	2000	2.5	5.0	10.0		180A	120D		
	SGLTW-400400BP	670	2600	1.5	3.1	15.0		330A	170D		
	SGLTW-400600BP	1000	4000	1.5	3.1	23.0		330A	170D		
	SGLTW-800400BP	1300	5000	1.5	2.5	24.0		550A	260D		
	SGLTW-800600BP	2000	7500	1.5	2.5	35.0					
	 Σ-TRAC Linear Motor Stage	SGTIF31-000AR20-04	80	220	4.6	5.0		4.3	2R1F	1R6A	N/A
		SGTIF41-000AR20-04	160	440	5.0	5.0		6.6	N/A	3R8A	
		SGTIF91-000AR20-04	280	600	4.2	5.0		8.5		5R5A	
SGTIFA1-000AR20-04		560	1200	4.4	5.0	14.5	120A				
SGTIFD1-000AR20-04		80	220	4.6	5.0	4.3	N/A	N/A	1R9D		
SGTIFE1-000AR20-04		160	440	5.0	5.0	6.6			1R9D		
SGTIFF1-000AR20-04		280	600	4.2	5.0	8.5			3R5D		
SGTIFG1-000AR20-04		560	1200	4.4	5.0	14.5			5R4D		

ENGINEERED SOLUTIONS

TURNING SERVOS INTO SERVICES

YOU NEED SOLUTIONS

Today's machine builders and manufacturers need to bring new designs to market in months or weeks instead of years. At the same time, you no longer have the luxury of a large staff of engineers or the help of in-house experts in automation engineering.



THE CHALLENGE: EXPERTISE

Design and support of automation is a challenge to your resources. Your automation design must be immediately effective and reliable in the long run. There's simply no room for downtime, lost production or support difficulties down the line.

WHAT IF:

- You could add expert automation engineers to your staff at the exact moment you need them?
- You could hand off responsibility for designing and supporting your machine automation to someone you trusted?
- You could keep your engineering staff focused on areas where your company truly adds value?

MORE THAN 75% OF MANUFACTURERS REPORT A MODERATE TO SEVERE SHORTAGE OF SKILLED RESOURCES*

A PORTFOLIO OF SERVICES

The experts at Yaskawa function as an extension of your engineering staff to create elegant, reliable automation.

We begin by understanding your application and process, the results you need to achieve, your time frame and cost structure. This level of understanding is what sets Yaskawa Engineered Systems apart, and makes us Capable of More.

MOTION APPLICATION SERVICES

Yaskawa's engineering expertise can be applied to any stage of machine development.

- System Concept Design
- Component Selection
- Electrical Design
- Mechatronic Design
- Machine Start-up
- Programming
- Optimization
- Troubleshooting

SOFTWARE DEVELOPMENT

Make Yaskawa's staff of programming professionals your software design and development team, and get a staff of engineers who understand proper software design and its impact on real-world machine operation.

ENGINEERED SYSTEMS

Under the banner of Engineered Systems, Yaskawa offers a range of advanced products and services. They include complete machine retrofits, enclosure design and manufacturing, electromechanical assembly design and integration of Yaskawa servo technology into a "purpose built" mechanism for your application.

Purpose-Built Mechanisms: Yaskawa integrates servo technology into complete assemblies, including flexures, four-bar linkages, integrated ballscrew motors, and direct drive systems. Each mechanism is tested and characterized, with a documented, serialized fingerprint and a full warranty provided for each assembly. Yaskawa will continue to service and support each assembly for the entire life of your machine.

Systems Engineering: Yaskawa Engineered Systems provides valuable engineering expertise, including:

- Complete electrical enclosures and custom cables
- Retrofits and training for legacy equipment
- Upgrading your legacy machine controls and servos to the latest technologies
- 365 days a year, 24-hour support

Yaskawa works with you during the entire cycle of a systems project, from defining scope and schedule to specifying components, electrical and software design, installation and line start-up. Our engineering expertise extends to support robot, servo, PLC, VFD, and controller products from Yaskawa and a wide variety of other suppliers.

*2014 Manufacturing Skills and Training Study, The Manufacturing Institute (affiliate of the National Association of Manufacturers.) A copy of the report is available on request.

TO LEARN MORE ABOUT YASKAWA'S LEGENDARY
RELIABILITY, UNBEATABLE PERFORMANCE AND
EXCEPTIONAL VALUE, CONTACT YOUR YASKAWA
SALES REPRESENTATIVE OR VISIT YASKAWA.COM.



Yaskawa is the leading global manufacturer of inverter drives, servo drives, machine controllers, medium voltage inverters and industrial robots. Our standard products, as well as tailor-made solutions, are well known and have a high reputation for outstanding quality and reliability.

YASKAWA